

**Oracle Utilities
Customer to Meter**

Business User Guide

Release 2.7.0.3.1

F21748-02

April 2020

Oracle Utilities Customer to Meter Business User Guide

Release 2.7.0.3.1

F21748-02

April 2020

Documentation build: 2.19.2020 14:39:47 [X1_1582144787000]

Copyright © 2020, Oracle and/or its affiliates. All rights reserved.

This software and related documentation are provided under a license agreement containing restrictions on use and disclosure and are protected by intellectual property laws. Except as expressly permitted in your license agreement or allowed by law, you may not use, copy, reproduce, translate, broadcast, modify, license, transmit, distribute, exhibit, perform, publish, or display any part, in any form, or by any means. Reverse engineering, disassembly, or decompilation of this software, unless required by law for interoperability, is prohibited.

The information contained herein is subject to change without notice and is not warranted to be error-free. If you find any errors, please report them to us in writing.

If this is software or related documentation that is delivered to the U.S. Government or anyone licensing it on behalf of the U.S. Government, then the following notice is applicable:

U.S. GOVERNMENT END USERS: Oracle programs, including any operating system, integrated software, any programs installed on the hardware, and/or documentation, delivered to U.S. Government end users are "commercial computer software" pursuant to the applicable Federal Acquisition Regulation and agency-specific supplemental regulations. As such, use, duplication, disclosure, modification, and adaptation of the programs, including any operating system, integrated software, any programs installed on the hardware, and/or documentation, shall be subject to license terms and license restrictions applicable to the programs. No other rights are granted to the U.S. Government.

This software or hardware is developed for general use in a variety of information management applications. It is not developed or intended for use in any inherently dangerous applications, including applications that may create a risk of personal injury. If you use this software or hardware in dangerous applications, then you shall be responsible to take all appropriate fail-safe, backup, redundancy, and other measures to ensure its safe use. Oracle Corporation and its affiliates disclaim any liability for any damages caused by use of this software or hardware in dangerous applications.

Oracle and Java are registered trademarks of Oracle and/or its affiliates. Other names may be trademarks of their respective owners. Intel and Intel Xeon are trademarks or registered trademarks of Intel Corporation. All SPARC trademarks are used under license and are trademarks or registered trademarks of SPARC International, Inc. AMD, Opteron, the AMD logo, and the AMD Opteron logo are trademarks or registered trademarks of Advanced Micro Devices. UNIX is a registered trademark of The Open Group.

This software or hardware and documentation may provide access to or information about content, products, and services from third parties. Oracle Corporation and its affiliates are not responsible for and expressly disclaim all warranties of any kind with respect to third-party content, products, and services unless otherwise set forth in an applicable agreement between you and Oracle. Oracle Corporation and its affiliates will not be responsible for any loss, costs, or damages incurred due to your access to or use of third-party content, products, or services, except as set forth in an applicable agreement between you and Oracle.

Contents

Business User Guide	26
Customer to Meter Overview.....	26
Oracle Utilities Customer Care and Billing Overview.....	27
Oracle Utilities Meter Data Management Overview.....	28
Oracle Utilities Smart Grid Gateway Overview.....	28
Oracle Utilities Service Order Management Overview.....	28
Oracle Utilities Operational Device Management Overview.....	29
User Interface Standard Features.....	29
Page Components.....	29
The Application Toolbar.....	30
Home Button.....	30
Menu.....	30
Admin Menu.....	32
Back Button.....	33
History Button.....	33
Forward Button.....	34
About Button.....	34
User Menu.....	34
Menu Item Search.....	35
Help Button.....	36
Page Title Area.....	36
Page Actions Toolbar.....	36
Object Display Area.....	40
Multiple Tabs.....	40
Text Box.....	41
Date Only Field.....	43
Date and Time Field.....	44
Search Button.....	45
Context Menu Button.....	46
Go To Button.....	46
Broadcast Button.....	46
Embedded Help Icon.....	46
Work Lists.....	47
Scroll Bars with Dynamic Height.....	47
Sorting Functionality.....	48
Get More Functionality.....	48
Adding and Removing Rows Using Arrows.....	49
Reorganizing Items Using the Up and Down Arrows.....	49
Trees.....	50
Required Field Indicator.....	51
Accordion Windows.....	51
Dashboard Area.....	52
Script Area.....	52
Portal Pages.....	52
Portals Are Made Up Of Zones.....	53
Users Must Be Granted Security Access To Each Zone.....	54
Zones May Appear Collapsed When A Page Opens.....	54
Some Portals Allow User Customization.....	55
Dashboard Portal.....	55
Bookmarks Zone.....	56
Current To Do Zone.....	56
Favorite Links Zone.....	57
Favorite Scripts Zone.....	58
Favorite Searches Zone.....	58
Switch Language Zone.....	58
To Do Summary Zone.....	58
Work List Zone.....	58
Zone Types and Characteristics.....	59

Common Characteristics of Zones.....	59
Explorer Zones.....	59
Map Zones.....	65
Timeline Zone.....	65
Common Base Portals and Zones.....	67
All-In-One Portal.....	67
Separate Query and Maintenance Portals.....	67
Process Flow.....	68
Fixed Pages.....	69
Maintenance Pages.....	69
The Unique Identifier Area.....	69
Confirmation & Error Messages.....	69
Warning If Unsaved Changes Exist.....	69
Query Pages.....	70
The Search Area.....	70
User Preferences.....	70
User - Main.....	70
User - To Do Roles.....	72
User - Access Security.....	72
User - Bookmarks.....	73
User - Portal Preferences.....	73
User - Favorite Links.....	74
User - Favorite Scripts.....	75
User - Characteristics.....	75
User - Miscellaneous.....	75
Initiating Scripts.....	76
Shortcut Key Summary.....	77
Customer Information.....	80
Understanding The V.....	80
Persons.....	81
Accounts.....	81
Service Agreements (SAs).....	82
Premises.....	82
Service Points (SPs).....	83
Metered versus Item-Based versus Non-Badged Service Points.....	83
Service Points With Multiple Items.....	84
Putting It All Together.....	84
Sample V For A Residential Customer.....	85
Sample V For A Commercial Customer With Multiple Premises.....	85
How To Set Up Customer Hierarchies.....	86
Navigating The V Using Control Central.....	87
Control Central - Main.....	87
Search Facilities.....	87
Search Options.....	88
Wild Cards.....	89
Search Results.....	89
Control Central - Account Information.....	90
Account Activity History Zone.....	90
Account Financial History Zone.....	92
Alert Zone.....	93
Applicable Campaigns Zone.....	98
Bill Graph Zone.....	98
Billed Consumption Zone.....	99
Context Zone.....	99
Credit and Collections Info Zone.....	100
Customer Information Zone.....	100
Financial Information Zone.....	102
Premise Information Zone.....	104
SA Premise List Zone.....	105
Service Credit Membership Zone.....	105
Scheduled Payments Log.....	105
Timeline Zone - Account Info.....	105
Control Central - Customer Information.....	106
Communication History Search.....	106

Person Tree Zone.....	107
Active Account Summary Zone.....	107
Timeline Zone - Customer Info.....	108
Control Central - Account Tree.....	108
Control Central - Premise Tree.....	108
Control Central - Bill/Payment Tree.....	108
Control Central - Payment Agreements.....	109
Payment Arrangement Requests.....	109
Payment Arrangement Request Details.....	109
Pay Plan Tree.....	109
How To Add A New Customer From Control Central.....	109
Maintaining The V.....	110
Maintaining Persons.....	110
Person - Main Information.....	110
Person - Correspondence Information.....	114
Person - Characteristics.....	115
Person - Persons.....	116
Person - Person Portal.....	116
Maintaining Accounts.....	118
Account - Main Information.....	118
Account - Auto Pay.....	120
Account - Person Information.....	121
Account - Financial Balances.....	124
Account - Bill Messages.....	125
Account - C&C.....	125
Account - Budget.....	128
Account - Deposits.....	129
Account - Characteristics.....	130
Account - Alerts.....	130
Account - Account Portal.....	131
Account Management Portal.....	132
Account - SAs For A Debt Class.....	133
Using The Account/Person Replicator.....	133
Information Replicated for New Persons.....	134
Information Replicated for New Accounts.....	134
Maintaining Service Agreements.....	135
The Lifecycle Of A Service Agreement.....	135
Service Agreement - Main Information.....	138
Service Agreement - Rate Info.....	142
Service Agreement - SA / SP.....	145
Service Agreement - Chars, Qty & Rec. Charges.....	146
Service Agreement - Miscellaneous.....	147
Service Agreement - Contract Options.....	148
Service Agreement - TOU Contract Values.....	148
Service Agreement - Billing Scenario.....	148
Service Agreement - SA Portal.....	149
Maintaining SA Relationships.....	149
Service Provider SA Relationship.....	151
Maintaining Premises.....	152
Premise - Main Information.....	153
Premise - Characteristics.....	154
Premise - Miscellaneous.....	154
Premise - Geographic Data.....	155
Premise - Alternate Address.....	156
Premise - Premise Portal.....	156
Maintaining Service Points.....	156
Dashboard Portal.....	157
Current Context Zone.....	157
Customer Contact Zone.....	158
Financial Information Dashboard Zone.....	158
Alert Dashboard Zone.....	158
Setting Up Bill Print Groups.....	158
Bill Print Group - Main.....	159
Bill Print Group - SA Sub Group.....	160

Landlord Reversion.....	161
Setting Up Landlord Agreements.....	162
Using The Premise Replicator.....	163
Premise Replicator - Main Information.....	163
Premise Replicator - Premise.....	164
Premise Replicator - Premise SPs.....	164
Start/Stop.....	165
The Big Picture Of Starting Service.....	165
The Lifecycle Of A Pending Start Service Agreement.....	165
Starting Service and Field Activities.....	165
Activating Pending Starts.....	166
What Happens After A SA Is Started?.....	168
The Big Picture Of Stopping Service.....	168
The Lifecycle Of A Pending Stop Service Agreement.....	168
Stopping Service and Field Activities.....	168
Finalizing Pending Stops.....	169
What Happens After A Service Agreement Is Stopped?.....	171
Start/Stop Maintenance.....	171
Start/Stop - Main.....	171
Start/Stop - Start Confirmation.....	175
Start/Stop - Stop Confirmation.....	177
Start/Stop - Address/Phone.....	178
Start/Stop - Pending SA.....	180
Start/Stop - Pending Field Activity.....	182
How To.....	183
Customer Contacts.....	186
Person-Based Versus Premise-Based Customer Contacts.....	186
How Customer Contacts Are Created.....	187
Customer Contacts Are Used To Trigger Letters.....	187
A Customer Contact May Trigger Reminders.....	188
Customer Contacts Can Be Used As Case Files.....	188
Maintaining Customer Contacts.....	189
Customer Contact - Main.....	189
Customer Contact - Log.....	191
Customer Contact - Characteristics.....	192
Customer Contact - Customer Contact Portal.....	193
Printing Letters.....	193
The Letter Extract Processes.....	193
BI Publisher Versus Document Composition Applications.....	194
Where Does The Address Come From?.....	194
Technical Implementation Of Online Letter Display.....	195
Reproducing The Letter Print Flat File.....	195
How To Reprint A Specific Letter.....	195
Letter Data Area Organization.....	196
Letter Extract File Structure.....	196
Extending Letter Record Types.....	196
Maintaining Declarations.....	197
Service Tasks.....	197
The Big Picture of Service Tasks.....	197
Searching and Viewing Service Tasks.....	198
Registration Points.....	198
Understanding Registration Points.....	198
Maintaining Registration Points.....	198
Consumer Contracts.....	199
Maintaining Consumer Contracts.....	199
Customer Service Requests.....	199
Understanding Customer Service Requests.....	199
Maintaining Customer Service Requests.....	200
Maintaining Customer Service Request Person.....	200
Maintaining Customer Service Request Account.....	201
Maintaining Customer Service Request Premise.....	201
Maintaining Customer Service Request Contract.....	201
Maintaining Customer Service Request Contract Product.....	201
Maintaining Customer Service Request Service Location.....	201

Asset Management.....	202
Assets.....	202
About Assets.....	202
Maintaining Assets.....	203
Asset Activities.....	205
About Asset Activities.....	205
Maintaining Asset Activities.....	205
Asset Activity Generators.....	206
About Asset Activity Generators.....	206
Maintaining Asset Activity Generators.....	207
Asset Completion Events.....	207
About Asset Completion Events.....	207
Maintaining Asset Completion Events.....	208
Asset Inbound Communications.....	208
About Asset Inbound Communications.....	208
Maintaining Asset Inbound Communications.....	209
Asset Locations.....	209
About Asset Locations.....	209
Maintaining Asset Locations.....	209
Asset Replication.....	210
About Asset Replication.....	210
Maintaining Asset Replication.....	210
Manufacturers.....	210
About Manufacturers.....	210
Maintaining Manufacturers.....	211
Mass Asset Disposition Update.....	211
Service History.....	211
About Service History.....	212
Maintaining Service History.....	212
Shipping Memos.....	212
About Shipping Memos.....	212
Maintaining Shipping Memos.....	213
Specifications.....	213
About Specifications.....	213
Maintaining Specifications.....	214
Device Management.....	214
Devices.....	214
About Meters.....	214
About Items.....	215
About Communication Components.....	216
Maintaining Devices.....	216
Device Configurations.....	216
About Device Configurations.....	216
Maintaining Device Configurations.....	217
Measuring Components.....	217
About Measuring Components.....	217
Physical Measuring Components.....	219
Scratchpad Measuring Components.....	221
Maintaining Measuring Components.....	221
Uploading Measurement Data.....	222
Requesting Measurement Data.....	222
Measuring Component Comparison Periods.....	223
About Measuring Component Comparison Periods.....	223
Maintaining Measuring Component Comparison Periods.....	224
Device Installations.....	224
Service Points.....	224
About Service Points.....	224
Maintaining Service Points.....	226
Service Point Quantities.....	227
About Service Point Quantities.....	227
Maintaining Service Point Quantities.....	227
Install Events.....	228
About Install Events.....	228
Maintaining Install Events.....	228

Route Management.....	229
About Route Management.....	229
Working with Route Management.....	229
Facilities.....	230
About Facilities.....	230
Maintaining Facilities.....	230
Network Locations.....	230
About Network Locations.....	230
Maintaining Network Locations.....	230
Measurements.....	231
Initial Measurement Data.....	231
About Initial Measurement Data.....	231
Processing Initial Measurement Data.....	232
CSV Upload.....	238
Importing Data From External Systems.....	238
Final Measurements.....	239
About Final Measurements.....	239
Reader Remarks.....	241
Periodic Estimation.....	241
About Periodic Estimation.....	241
Measurement Reprocessing.....	245
About Measurement Reprocessing.....	245
Reviewing Measurements for Reprocessing.....	246
Consumption Sync.....	246
Introduction to Consumption Sync.....	247
VEE.....	248
Introduction to VEE.....	249
About VEE.....	249
Decision-Making VEE Rules.....	251
Validations.....	251
About IMD Validations.....	252
Reviewing and Resolving VEE Exceptions.....	253
Usage Transaction Validations.....	253
Estimations.....	253
About IMD Estimations.....	253
Usage Transaction Estimations.....	254
Editing.....	254
About IMD Editing.....	254
Editing Initial Measurements.....	255
Generating New Initial Measurements.....	255
Usage.....	255
Introduction to Usage Calculation.....	255
About Usage Calculation.....	255
Usage Subscriptions.....	257
About Usage Subscriptions.....	257
Maintaining Usage Subscriptions.....	257
Usage Subscription Market Participants.....	258
About Usage Subscription Market Participants.....	258
Maintaining Usage Subscription Market Participants.....	258
Usage Transactions.....	258
About Usage Transactions.....	258
About Usage Validations.....	262
Reviewing and Resolving Usage Transactions.....	263
Triggering Adjustment Notifications.....	263
Inventory of Other Usage Calculation Rules.....	264
Usage Requests.....	267
Usage Calculation Requests.....	267
About Usage Calculation Requests.....	267
Maintaining Usage Calculation Requests.....	267
Usage Subscription Quantities.....	268
About Usage Subscription Quantities.....	268
Maintaining Usage Subscription Quantities.....	268
Time of Use Maps.....	268
About Time-of-use Processing.....	268

About TOU Maps.....	269
Maintaining TOU Maps.....	269
Dynamic Options.....	270
About Dynamic Options.....	270
About Dynamic Option Events.....	271
Maintaining Dynamic Options.....	271
Maintaining Dynamic Option Events.....	271
Consumption Extract Requests.....	271
About Consumption Extract Requests.....	272
Maintaining Consumption Extract Requests.....	272
Contacts.....	272
About Contacts.....	272
Maintaining Contacts.....	272
360 Degree Search.....	273
Using 360 Degree Search.....	273
360 Degree Views.....	273
360 View Measuring Component.....	273
Using 360 Degree View Measuring Component.....	273
Applying Measurement Functions.....	274
360 Degree View Device.....	275
Using 360 Degree View Device.....	275
360 Degree View Service Point.....	275
Using 360 Degree View Service Point.....	275
360 Degree View Usage Subscription.....	276
Using 360 Degree View Usage Subscription.....	276
360 Degree View Contact.....	276
Using 360 Degree View Contact.....	276
Service Orders.....	277
About Service Order Activities.....	277
How Are Service Order Activities Created?.....	278
About Service Order Field Activities.....	278
What Happens After A Field Activity Is Completed?.....	279
About Appointments.....	279
Field Activity Maintenance.....	280
Lifecycle of a Field Activity.....	280
Field Activity - Main Information.....	280
Field Activity - Steps.....	281
Field Activity - Characteristics/Remarks.....	282
Field Activity - Field Activity Portal.....	282
Field Activity - Log.....	283
Outage Calls.....	283
Outage Call Actions.....	283
Outage Call Zone.....	284
Outage Call Log.....	284
Outage Information.....	284
Job History.....	284
Call History.....	284
Planned Outages.....	285
Billing.....	285
The Big Picture of Billing.....	285
An Illustration Of A Simple Bill.....	285
An Overview of the Bill Creation Process.....	287
Bill Errors.....	288
Bill Segment Errors.....	288
Bill Completion Errors.....	289
Cancel / Rebill Incorrect Bill Segments.....	289
Credit Notes - Presenting Cancellation Details on a Separate Bill.....	290
Credit Notes Are Only Possible if the Installation Option Is Turned On.....	290
Credit / Correction Notes and Auto Pay.....	290
Adjustments On Credit Notes.....	291
Credit Note Routing Suppression.....	291
Correction Notes - Presenting Correction Details on a Separate Bill.....	291
Correction Notes Are Only Possible if the Installation Option Is Turned On.....	292
Correction Notes Versus Credit Notes.....	292

Correction Notes and Auto Pay.....	292
How the System Requests How Much Was Consumed.....	292
Item Snapshot.....	293
Service Quantity Snapshot.....	293
Calculation / Audit Read Details.....	294
Calculation / Audit Usage Details.....	294
How To Override The Commodity Amount In A Bill Segment.....	295
How Rates Affect the Information on Bill Segments.....	295
Bill Frequency - Bill Cycle vs Bill Segment Duration.....	296
Ways To Control The Start Date Of A Bill Segment.....	296
Ways To Control The End Date Of A Bill Segment.....	296
Preventing Short Bill Segments.....	298
Prorating Charges When a Rate is Applied.....	299
Batch Billing.....	299
Window Billing And The Bill Cycle Schedule.....	299
Confirming A Batch Of Bills Before Completing Them.....	299
Canceling A Batch Of Bills After They're Complete.....	300
Reopening A Batch Of Bills After They're Complete.....	300
Fixing Errors Detected In Batch Billing.....	300
Completing Pending Bills.....	300
Billing Financial Transaction Considerations.....	301
Billing - Current Balance versus Payoff Balance.....	301
The Source Of GL Accounts On A Bill Segment's Financial Transaction.....	302
Determining the Statistical Quantity.....	303
The Source Of Bill Routing Information.....	303
Bill Messages.....	304
The Source Of Bill Messages.....	304
Substituting Field Values Into A Message.....	304
A Bill May Affect More Than Just Customer Balances.....	305
Auto Cancel / Rebill If A Service Agreement Is Stopped Retroactively.....	305
Cancel Historical, Estimated Bill Segments When a Real Read Is Found.....	305
Deposits May Be Refunded.....	306
FT Freeze Repercussions.....	306
Budget Billing.....	306
Account versus Service Agreement.....	306
How To Set Up A Customer To Participate In A Budget Plan.....	306
The Financial Impact Of Budget Plans.....	307
Budget Billing Background Processes.....	307
Canceling A Budget.....	308
Net Energy Metering.....	308
What Is Net Energy Metering?.....	308
Net Energy Metering Service Agreements.....	309
Net Energy Metering True Up.....	309
Setting Up the System for Net Energy Metering.....	310
Net Energy Metering Billing Examples.....	311
Using Billable Charges for Pass Through / Convergent Billing.....	314
Printing Bills.....	316
Bill Routings Are Created For Each Recipient Of A Bill.....	316
Bill Route Types Control The Information Merged Onto Bills.....	316
Technical Implementation Of Online Bill Display.....	317
Technical Implementation Of Printing Bills In Batch.....	317
Reproducing The Bill Print Flat File.....	318
How To Reprint A Specific Bill.....	318
Who Gets A Copy Of A Bill?.....	318
Final Bills and Bill Print.....	318
The Bill Extract Records.....	318
XML Bill Extracts.....	331
Sequential Bill Numbers.....	331
Sequential Numbers Are Only Assigned If The Installation Option Is Turned On.....	331
Pending Bills Do Not Have A Sequential Bill Number.....	331
When / How Is The Sequential Bill Number Assigned.....	332
Additional Functionality for Sequential Bill Numbering.....	332
Document Numbers.....	332
Document Numbers Are Only Assigned If the Installation Option Is Turned On.....	333

Pending Bills Do Not Have a Document Number.....	333
When/How Is the Document Number Assigned.....	333
Additional Functionality Exists When Document Numbers Are Used.....	334
Digital Signatures.....	334
Writing Off Bills.....	335
Idiosyncratic Manual Bill Cancellation.....	335
Maintaining Bills.....	335
Bill Lifecycle.....	335
Bill - Main Information.....	338
Generate.....	341
Freeze.....	342
Cancel Frozen.....	342
Freeze / Complete.....	343
Complete.....	343
Delete.....	344
Reopen.....	344
Credit Note.....	344
Correction Note.....	345
Write Off.....	346
Reverse Write Off.....	346
Cancel Bill.....	346
Bill - Bill Segments.....	346
Generate (Bill - Bill Segments).....	348
Freeze (Bill - Bill Segments).....	349
Delete (Bill - Bill Segments).....	349
Cancel/Rebill/Freeze (Bill - Bill Segments).....	349
Cancel (Bill - Bill Segments).....	351
Credit Note (Bill - Bill Segments).....	351
Correction Note (Bill - Bill Segments).....	352
Bill - Bill Routings.....	352
Bill - Bill Messages.....	354
Bill - Characteristics.....	355
How To.....	355
How To Create A Bill For All Service Agreements Linked To An Account.....	355
How To Create A Bill For A Specific Service Agreement.....	356
How To Create a Bill with no Bill Segments.....	356
How To Create A One-Time Invoice.....	356
How To Correct A Bill Segment That's In Error.....	357
How To Correct A Bill That's In Error.....	358
How To Cancel A Bill Segment.....	358
How To Cancel / Rebill A Bill Segment.....	358
How To Create A Credit Note.....	359
How To Create A Correction Note.....	360
How To Create An Off Cycle Bill Generator.....	360
How To Override The Items Billed On A Specific Bill Segment.....	361
How To Remove Unwanted Adjustments (or Payments) From A Completed Bill.....	361
How To Add An Adjustment (or Payment) To A Completed Bill.....	362
How To Reprint A Bill (For The Original Recipients or For Someone New).....	362
How To Add Ad Hoc Messages To A Bill.....	362
How To Remove A Completed Bill.....	363
How To Display A Bill On-line.....	363
Financial Transactions On A Bill.....	364
Maintaining Bill Segments.....	365
Bill Segment Lifecycle.....	365
Bill Segment - Main Information.....	367
Generate (Bill Segment).....	369
Delete (Bill Segment).....	369
Freeze (Bill Segment).....	369
Rebill (Bill Segment).....	370
Init Cancel (Bill Segment).....	371
Undo (Bill Segment).....	371
Cancel (Bill Segment).....	372
Credit Note (Bill Segment).....	372
Bill Segment - Read Details.....	373

Bill Segment - Item Details.....	373
Bill Segment - SQ Details.....	374
Bill Segment - Calc Lines.....	376
Bill Segment - Financial Details.....	377
Bill Segment - Bill Segment Messages.....	378
Bill Segment - Sub Bill Segments.....	379
Bill Segment - Bill Segment Portal.....	379
Bill Segment - Usage.....	380
Financial - Bill Segment Calculation Line Characteristics.....	380
Off Cycle Bill Generator.....	380
Off Cycle Bill Generator Query.....	381
Off Cycle Bill Generator Portal.....	381
Off Cycle Bill Generator Actions.....	381
Off Cycle Bill Generator Zone.....	381
Financial Transactions On Bill.....	381
Off Cycle Bill Generator Log.....	381
Multi Cancel/Rebill.....	382
Multi Cancel/Rebill - Main.....	382
Multi Cancel/Rebill - Graph.....	384
SA Billing History.....	384
Bill Exception.....	384
Bill Segment Exception.....	385
Maintaining Billable Charges.....	385
Billable Charge - Main.....	386
Billable Charge - Line Characteristics.....	387
Billable Charge - SQ Details.....	387
Billable Charge - Read Details.....	388
Uploading Billable Charges.....	389
Billable Charge Upload Background Processes.....	389
Process X - Populate BC Upload Staging.....	390
BCU1 - Validate & Populate Billable Charge Upload Staging.....	399
BCU2 - Create Billable Charge.....	399
BCUP-PRG - Purge Billable Charge Upload Objects.....	400
Billable Charge Upload Staging.....	400
Billable Charge Upload - Main.....	400
Billable Charge Upload - Lines.....	401
Billable Charge Upload - SQ Details.....	401
Billable Charge Upload - Read Details.....	401
Billable Charge Upload Exception.....	401
Budget Review.....	402
Payments.....	402
The Big Picture of Payments.....	402
A Payment Event Has Payments And Tenders.....	402
Multiple Tenders Used To Pay For Multiple Accounts.....	403
An Overview Of The Payment Event Creation & Allocation Process.....	404
Distributing A Payment Event.....	405
Distributing A Payment Amongst An Account's Service Agreements.....	406
Overpayment.....	408
Canceling A Tender Versus Canceling A Payment.....	408
NSF Cancellations.....	408
Transferring A Payment.....	409
Unbalanced Payment Events.....	409
How And When Payments Appear On Bills.....	410
Tender Management and Workstation Cashiering.....	410
Managing Your Cash Drawers.....	411
Turn Ins.....	413
Balancing By Tender Type.....	414
Cash Back.....	414
Managing Payments Interfaced From External Sources.....	415
Payment Financial Transaction Considerations.....	415
Payment - Current Balance versus Payoff Balance.....	416
The Source Of GL Accounts On A Payment Financial Transaction.....	416
A Payment May Affect More Than Just Customer Balances.....	416
Open Item Accounting and Match Events.....	416

FT Freeze Repercussions.....	416
Automatic Payments.....	417
How To Set Up A Customer To Pay Automatically.....	417
What Are Automatic Payments?.....	417
How And When Are Automatic Payments Created?.....	417
Automatic Payment Dates.....	419
How To Implement Maximum Withdrawal Limits.....	419
How Are Automatic Payments Cancelled?.....	419
Match Events Are Created For Open-Item Customers When An Automatic Payment Is Created.....	420
Pay Plans and Automatic Payments.....	420
Non-Billed Budgets and Automatic Payment.....	420
Downloading Automatic Payments and Interfacing Them To The GL.....	420
ACH Record Layouts.....	424
SEPA Direct Debit Record Layouts.....	427
Third Party Auto Pay Record Layouts.....	429
Third Party Payment Processing.....	430
One Time Payments.....	430
Account Verification.....	433
Automatic Payment Setup.....	433
Interfacing Automatic Payments To A Third Party.....	433
Highlighting Scheduled Payments.....	433
Automatic Payment Confirmations And Cancellations.....	434
Third Party Payment Tender Controls Processing.....	434
Issuing A Payment Advice Instead Of Creating An Automatic Payment.....	436
How To Set Up A Customer To Receive Payment Advices.....	436
Payment Advice Option Is For Bill-Related Automatic Payments Only.....	436
Maintaining Payment Events.....	436
Payment Lifecycles.....	436
Payment Event Lifecycle.....	436
Tender Lifecycle.....	437
Payment Lifecycle.....	438
Payment Event - Add Dialog.....	439
Payment Event - Main Information.....	440
Payment Event - Tenders.....	442
Payment Event - Characteristics.....	445
Exception.....	445
Payment Event Exception.....	445
Payment Exception.....	445
Resolving Exceptions Automatically.....	446
Payment Event Action Codes.....	446
Payment Actions.....	446
Payment Event Actions.....	447
Tender Actions.....	449
Payment Event Quick Add.....	449
Multiple Payment Events Dialog.....	450
Single Payment Event Dialog.....	452
Payment Quick Add.....	453
Maintaining Payments.....	455
Payment - Main.....	455
Payment - Pay Segments.....	457
Payment - Manual Distribution.....	458
Payment - Characteristics.....	460
Payment Action Codes.....	460
Distribute (A Payment).....	460
Redistribute (A Payment).....	461
Confirm (A Payment).....	461
Freeze (A Payment).....	461
Cancel (A Payment).....	461
Transfer (A Payment).....	461
Delete (A Payment).....	463
Payment Portal.....	463
Credit Card Payments.....	463
Non CIS Payments.....	463
Alternate Currency Payments.....	464

How To.....	464
How To Add A New Payment Event.....	464
How To Cash A Check.....	464
How To Allocate The Tender Amount To Multiple Accounts.....	465
How To Print Receipts And Endorsements.....	465
How To Cancel A Tender.....	466
How To Transfer A Payment From One Account To Another.....	466
How To Distribute A Payment To A Specific Service Agreement.....	467
How To Get An Unbalanced Tender Control In Balance (Fixing Over/Under).....	467
How To Add A Non-CIS Payment Using A Template.....	468
How To Authorize A Credit Card Tender.....	469
How To Reverse A Credit Card Tender.....	469
How To Process An Alternate Currency Payment.....	470
Financial Transactions On A Payment.....	470
Payment History.....	471
Payment Tender History.....	472
Payment / Tender Search.....	472
Maintaining Deposit Controls.....	475
The Lifecycle Of A Deposit Control.....	475
Deposit Control - Main.....	476
Deposit Control - Tender Control.....	477
Deposit Control - Tender Deposit.....	477
Deposit Control - Turn Ins.....	478
Deposit Control - Characteristics.....	478
Maintaining Tender Controls.....	479
The Lifecycle Of A Tender Control.....	479
Tender Control - Main.....	480
Tender Control - Tenders.....	481
Tender Control - Turn Ins.....	482
Tender Control - Exceptions.....	482
Tender Control - Characteristics.....	483
Interfacing Payments From External Sources.....	483
Interfacing Payments.....	483
Populating The Payment Upload Staging Records.....	483
PYUP-PRG - Purge Payment Upload Objects.....	492
Maintaining Deposit Control Staging.....	492
Payment Upload Staging.....	493
Payment Upload Exception.....	495
Interfacing Payments Using Distribution Rules.....	495
Populating The Payment Event Upload Staging Records.....	495
Payment Event Upload Staging.....	505
Adjustments.....	507
The Big Picture Of Adjustments.....	507
Adjustments - Current Balance versus Payoff Balance.....	507
When Current Balance Equals Payoff Balance.....	507
When Current Balance Differs From Payoff Balance.....	508
Adjustment Type And Balances.....	509
Canceling Adjustments.....	509
Transfer Adjustments.....	509
Calculated Adjustments.....	509
Adjustment Amount May Be Positive, Negative, Or Zero.....	510
Adjustment Type Controls Everything.....	510
Controls Which Balance(s) Are Affected.....	510
Defines The GL Account Affected By The Adjustment.....	510
Defaults The Adjustment Amount.....	511
Calculates The Adjustment Amount.....	511
Controls The Interface To A/P & 1099 Reporting.....	511
Controls Information Printed On The Bill.....	512
Controls If The Adjustment Can Be Frozen Prior To Bill Completion.....	512
Controls If The Adjustment Requires Approval.....	512
Unbilled Adjustments And Aged Debt.....	512
An Adjustment May Affect More Than Just Customer Balances.....	513
Maintaining Adjustments.....	513
The Lifecycle Of An Adjustment.....	513

Adjustment - Main Information.....	515
Adjustment - Characteristics.....	518
Adjustment - Transfer Adjustment.....	518
Adjustment - A/P Request.....	519
Adjustment - Adjustment Portal.....	520
Adjustment - Approval.....	520
Adjustment Information.....	520
Approval Request.....	521
Approval Request Log.....	521
Financial - Adjustment Calculation Line Characteristics.....	521
How and When To Use An Adjustment.....	521
How To Create A Transfer Adjustment.....	522
How To Create A Calculated Adjustment.....	522
How To Cancel An A/P Adjustment After It Has Been Selected By A/P.....	523
How To Correct Normal Service Agreement Debt.....	523
How To Apply Ad Hoc Fees To A Service Agreement.....	523
How To Apply Interest To A Deposit.....	523
How To Apply A Deposit To Outstanding Debt.....	524
How To Refund A Deposit With A Check.....	524
How To Write-Down Deposit Due.....	525
How To Refund A Credit Balance With A Check.....	525
How To Transfer A Credit Balance To A Service Agreement In Arrears.....	525
How To Change The Age Of Debt.....	525
How To Write-Down A Charitable Contribution Service Agreement Debt.....	526
How To Write-Off Debt.....	526
How To Cancel A Service Agreement's Budget.....	526
How To Adjust A Service Agreement On A Budget.....	527
How To Adjust An Installment Plan Service Agreement.....	527
How To Use An Adjustment To Change The GL Distribution.....	527
Interfacing Adjustments From External Sources.....	528
Interfacing Adjustments.....	528
Process X - Populate Adjustment Upload Records.....	528
Process C1-ADUP1 - Preprocess Adjustment Uploads.....	534
Process C1-ADUP2 - Upload Adjustments.....	536
Suspense Adjustments.....	537
What Are Suspense Adjustments?.....	537
How Are Suspense Adjustments Resolved?.....	537
Maintaining Adjustment Staging Control.....	537
Maintaining Adjustment Upload Staging.....	538
Credit & Collection.....	539
The Big Picture Of Credit & Collection.....	539
Automating Your C&C Activities.....	539
The Lifecycle Of A Collection Process And Its Events.....	539
What Is A Collection Process?.....	540
How Are Collection Processes Created?.....	540
How Are Collection Events Completed?.....	541
How Are Collection Processes (and their Events) Canceled?.....	541
What Happens If A Payment Is Not Received?.....	541
The Collection Process Background Processes.....	541
Account Debt Monitor.....	542
Collection Event Activator.....	542
Collection Process Monitor.....	543
The Lifecycle Of A Severance Process And Its Events.....	543
What Is A Severance Process?.....	544
How Are Severance Processes Created?.....	544
How Are Severance Events Completed?.....	545
How Are Severance Processes (and their Events) Canceled?.....	545
What Happens If The Customer Does Not Pay?.....	546
The Severance Process Background Processes.....	546
Severance Event Activator.....	547
Completing Severance Events That Are Dependent On The Completion Of A Field Activity.....	547
Set Trigger Date.....	547
The Lifecycle Of A Write-Off Process And Its Events.....	548
What Is A Write-Off Process?.....	549

How Are Write-Off Processes Created?.....	549
How Are Write-Off Events Completed?.....	549
How Are Write-Off Processes (and their Events) Canceled?.....	549
What Happens If The Debt Is Not Paid?.....	550
How Is Debt Referred To Collection Agencies.....	550
The Write-Off Process Background Processes.....	550
Write-Off Monitor.....	551
Write-Off Event Activator.....	551
Collection Process Maintenance.....	551
Collection Process - Main Information.....	552
Collection Process - SAs (Service Agreements).....	554
Collection Process - Events.....	555
How To Perform Common Collection Process Functions.....	556
How To Create A Collection Process.....	556
How To Change Collection Events.....	557
How To Cancel A Collection Process.....	557
Severance Process Maintenance.....	558
Severance Process - Main Information.....	558
Severance Process - Severance Events.....	560
Severance Process - Field Activity/Customer Contact.....	561
How To Perform Common Severance Process Functions.....	562
How To Create A Severance Process.....	562
How To Change Severance Events.....	562
How To Cancel A Severance Process.....	563
Write-Off Process Maintenance.....	563
Write Off Process - Main Information.....	563
Write Off Process - SAs (Service Agreements).....	565
Write Off Process - Events.....	566
How To Perform Common Write-Off Process Functions.....	567
How To Create A Write-Off Process.....	567
How To Change Write Off Events.....	568
How To Cancel A Write-Off Process.....	568
Writing Off Uncollectable Debt.....	569
Write Off - Main.....	569
How To Manually Write-Off Debt.....	569
Write Off - Write Off SAs.....	569
Collection Referral.....	570
Downloading Collection Agency Referrals.....	571
Collection Agency Extract Record.....	571
Payment Arrangements and Pay Plans.....	573
Setting Up Payment Arrangement Requests.....	573
Starting A Payment Arrangement Request.....	574
Maintaining Payment Arrangement Requests.....	574
Payment Arrangement Request Process Flow.....	574
Viewing Payment Arrangement Request History	575
Setting Up Payment Arrangements.....	575
Pay Arrangement - Main.....	575
How To Set Up A Payment Arrangement.....	577
How To Add Additional Debt To A Payment Arrangement.....	578
How To Break A Payment Arrangement.....	578
How To Cancel A Payment Arrangement.....	578
Pay Arrangement - History.....	579
Setting Up Pay Plans.....	579
Pay Plan - Main.....	580
How To Set Up A Pay Plan.....	581
Reviewing Pay Plans.....	581
Financial Transactions.....	581
The Big Picture Of Financial Transactions.....	581
Bill Segment Financial Transactions.....	581
Payment Segment Financial Transactions.....	582
Adjustment Financial Transactions.....	582
Financial Transactions And Aged Debt.....	582
Current Balance versus Payoff Balance.....	583
Adjustments - Current Balance versus Payoff Balance.....	583

Billing - Current Balance versus Payoff Balance.....	583
Payment - Current Balance versus Payoff Balance.....	583
The Source Of GL Accounts On Financial Transactions.....	583
Obscure Things That Can Happen.....	583
A Stopped Service Agreement May Be Closed.....	584
A Closed Service Agreement May Be Reactivated.....	584
A Write-Off Process May Be Deactivated If The SA Is Closed.....	584
A Reactivated Service Agreement May Be Closed.....	584
A Collection Process May Be Canceled When A Credit FT Is Frozen.....	584
A Severance Process May Be Canceled When A Credit FT Is Frozen.....	585
One Or More Algorithms May Be Executed.....	586
The Big Picture of Balance Control.....	586
The Balance Control Background Processes.....	586
Balance Control Information Is Available Online.....	587
The GL Interface.....	588
GLASSIGN - Assign GL Account Numbers To GL Details.....	588
GLS - Prepare FTs for Download.....	589
GLDL - Create General Ledger Download Flat File.....	589
Financial Transaction.....	590
Financial Transaction - Main.....	591
Financial Transaction - FT Process.....	593
Account Financial History.....	594
Account Bill / Payment History.....	594
SA Financial History.....	594
SA Non-Accrual Accounting Balance.....	595
Balance Control.....	595
Match Event.....	596
Match Event - Main.....	597
Match Event - FT Details.....	599
Match Event - Subtotals.....	602
How To Perform Common Match Event Functions.....	603
How To Find The Match Event Associated With A Financial Transaction.....	603
How To Dispute An Item.....	603
How To Match A Small Mismatch.....	603
Deposits.....	604
The Big Picture Of Deposits.....	604
Cash Deposits.....	604
Refunding Deposits.....	605
Partial Refunds.....	605
Total Amount To Bill.....	606
Current Balance versus Payoff Balance.....	606
Multiple Deposits Linked To A Single Account.....	607
Deposits and Credit & Collections.....	608
Deposit Seizures When Other SAs Are Stopped.....	608
Non-Cash Deposits.....	609
Third Party Deposits.....	609
Deposit Class Controls Everything.....	610
Controls Interest Calculation.....	610
Controls The Recommended Deposit Amount.....	611
Defines The Conditions That Cause The System To Recommend A New or Additional Deposit.....	611
Defines Automatic Refund Conditions.....	611
Controls How Deposits Are Refunded To A Customer.....	611
Deposit Background Processes.....	612
Deposit Interest.....	612
Deposit Refund.....	612
Review Deposits.....	612
Deposit Review.....	613
Statements.....	613
The Big Picture of Complex Statements.....	613
Constructing Statements.....	615
Producing Statements.....	615
Statement Cycles.....	615
Create Statements Background Process.....	616
Statement Routing.....	617

Where Are Statements Sent.....	617
On-Line Statement Production.....	617
How to Regenerate a Specific Statement.....	617
Printing Statements.....	618
Statement Route Types Control The Information Merged Onto Statements.....	618
Technical Implementation Of Online Statement Display.....	618
Technical Implementation Of Printing Statements In Batch.....	619
Reproducing The Statement Print Flat File.....	619
How To Reprint A Specific Statement.....	619
The Statement Extract Records.....	619
Statement Construct Maintenance.....	626
Lifecycle of a Statement Construct.....	626
Statement Construct - Main.....	627
Statement Construct - Details.....	628
Statement Maintenance.....	629
Lifecycle of a Statement.....	629
Statement - Main.....	629
Statement - Details.....	631
Sales & Marketing.....	631
The Big Picture of Campaigns, Packages, and Orders.....	632
An Overview of Campaigns, Packages and Orders.....	632
Supported Business Processes.....	633
Marketing to Prospects from a Marketing List.....	634
Marketing to Pre-Selected Customers.....	635
Real-Time Marketing of Additional Services to a Customer.....	636
Real-Time Marketing of Services to a Prospect.....	636
Setting up a New Customer Prior To Using Start/Stop.....	637
Examples of Campaigns and Packages.....	639
Campaigns Without Packages.....	639
Campaigns With Simple Packages.....	642
Campaigns With Complex Packages.....	644
The Big Picture Of Package Eligibility Rules.....	650
Criteria Groups versus Eligibility Criteria.....	651
Defining Logical Criteria.....	652
Examples Of Package Eligibility Rules.....	652
A Package That Is Always Eligible.....	653
A Package With A Time Span Comparison.....	653
A Package With Service Type Comparison.....	654
A Package With More Complex Operators.....	655
The Big Picture Of Campaign Eligibility Rules.....	656
Campaign Eligibility Rules Are Not Strictly Enforced.....	656
Campaign Eligibility Rules Are Defined Using Algorithms.....	656
Examples Of Campaign Eligibility Rules.....	657
A Campaign That Is Always Eligible.....	657
A Campaign That Is Never Eligible.....	657
A Campaign For Residential Customers.....	657
A Campaign For California, Residential Customers.....	657
Designing Campaigns and Packages.....	657
Determine The Place Of Start/Stop.....	658
Determine Which Types Of Service Agreements Are Created.....	658
Determine The Different Start Options That Exist For Each Type Of Service Agreement.....	658
Determine The SP Type (if any) For Each Service Agreement.....	659
Determine The Method Used To Create Each Service Agreement.....	659
Extract Algorithms From The Start Method.....	660
Determine Which Combinations Can Be Grouped Under A Package.....	660
Determine Package Eligibility Rules.....	660
Eligibility Rules For Package 1.....	661
Eligibility Rules For Package 2.....	661
Eligibility Rules For Package 3.....	662
Eligibility Rules For Package 4.....	663
Extract Algorithms From The Eligibility Rules.....	663
Extract Miscellaneous Fields From The Eligibility Rules.....	664
Determine Additional Information That Is Required If A Package Is Selected.....	664
Determine If There Are Additional Questions / Fields For Your Packages.....	664

Determine If Additional Instructions Should Be Shown.....	665
Determine If There Are Campaign-Level Fields / Questions.....	665
Determine The Properties Of Every Miscellaneous Field.....	666
Extract Characteristic From The Miscellaneous Fields.....	668
Extract Column References From The Miscellaneous Fields.....	668
Extract Algorithms From The Column References.....	669
Determine Account / Premise Dependency For Each Column Reference.....	670
Determine If Any Properties Are Overridden On Any Package.....	671
Determine The Eligibility Rules For The Campaign.....	671
Determine How The Campaign Behaves.....	672
Setup Sequence.....	672
Other Useful Information.....	673
Order versus Start/Stop.....	673
Orders Cannot Be Changed After They Are Completed.....	675
Premise and SP Characteristics May Be Populated From Postal Defaults.....	675
To Do List Processing.....	675
Hold and Cancel Reason Codes.....	675
Automatically Cancelling Old Orders.....	675
Additional Things Can Happen When An Order Is Completed.....	676
New Premises and Accounts Are Only Created if an Order is Completed.....	676
Premise Geographic Types Are Populated In An Unusual Way.....	676
Account And Premise Usage Are Controlled By The Campaign.....	677
Maintaining Orders.....	677
Lifecycle of an Order.....	677
Order User Interface Flow.....	678
Order - Main.....	679
Order - Main - Person Information.....	680
Order - Main - Service Address.....	683
Order - Main - Account Information.....	684
Order - Questions & Misc. Fields	685
Order - Log.....	688
Order - Package Confirmation.....	688
Order - Hold Dialog.....	689
Order - Cancel Dialog.....	690
Maintaining Campaigns.....	690
Lifecycle of a Campaign.....	690
Campaign - Main.....	691
Campaign - Questions and Misc. Fields.....	693
Campaign - Algorithms.....	694
Campaign - Package.....	695
Maintaining Packages.....	696
Lifecycle of a Package.....	696
Package - Main.....	696
Package - SAs To Create.....	697
Package - Questions & Misc Fields.....	698
Package - Eligibility.....	698
Package - Instructions.....	700
The Big Picture of Program Management.....	700
The Big Picture of Initiatives, Leads, and Representatives.....	701
The Big Picture of Initiatives.....	701
The Big Picture of Leads.....	706
The Big Picture of Sales Representatives.....	713
The Big Picture of Third Party Representatives.....	714
Maintaining Initiatives.....	716
Initiative Portal.....	716
How To Perform Common Initiative Functions.....	716
Maintaining Leads.....	723
My Leads.....	723
Lead Portal.....	723
How To Perform Common Lead Functions.....	724
Maintaining Sales Representatives.....	727
Sales Representatives Portal.....	727
How To Perform Common Sales Representative Functions.....	728
Maintaining Third Party Representatives.....	731

Third Party Representatives Portal.....	731
How To Perform Common Third Party Representative Functions.....	731
Rates.....	733
Calculation Rule-Based Rates.....	734
All Calculation Rule-Based Rates Share a Common Structure.....	734
Control Tables That Must Be Set Up Before Creating a Rate Schedule.....	735
Master Configuration.....	735
Defining Frequency Codes.....	736
Setting Up Bill Factors.....	736
An Overview of Bill Factors.....	737
The Structure of a Bill Factor.....	738
An Illustration of a Bill Factor and Its Characteristics.....	738
Deriving/Passing In Characteristic Values.....	740
Defining Bill Factors.....	740
Defining Bill Factor Values.....	744
Rate Schedule Execution.....	745
Understanding Calculation Groups and Rules.....	746
About Calculation Groups and Rules.....	746
Designing Calculation Groups and Rules.....	749
Analyzing Your Rates and Identifying Calculation Rules and Groups.....	749
Reusing Calculation Rules.....	750
Leveraging Eligibility Criteria to Dynamically Apply Calculation Rules.....	751
Case Study: Three Sample Rates.....	751
The Big Picture of Calculation Rule Eligibility Rules.....	754
A Rate Component is Eligible by Default.....	754
Defining Logical Eligibility Criteria.....	754
Examples of Calculation Rule Eligibility Rules.....	755
Working with Calculation Groups and Rules.....	757
Defining Calculation Groups.....	757
Searching and Maintaining Calculation Groups.....	757
Defining Calculation Line Category Types.....	759
Maintaining Calculation Line Category Types.....	759
Defining Calculation Rules.....	759
Searching and Maintaining Calculation Rules.....	763
Defining Calculation Rule Eligibility Criteria.....	764
Creating Rate Schedules.....	764
Defining Rate Schedules.....	764
Searching and Maintaining Rate Schedules.....	765
Base Package Calculation Rule Descriptions.....	766
Common Parameters.....	767
Calculation Rule Validation.....	768
Calculation Rules.....	769
Rate Check.....	788
About Rate Check.....	788
Performing a Rate Check.....	788
Viewing the Results of a Rate Check.....	789
Effective Dates and Price Proration.....	789
Types of Proration.....	789
Proration Factors.....	791
Overriding Proration Factors.....	793
Service Quantity Proration.....	793
Calculation Rule Value Proration.....	794
Bill Factor Value Proration.....	795
Example of Generating Prorated Bill Calculation Lines.....	795
Seasonal Proration.....	796
Price Changes and Interval Quantities.....	798
Setting Up Estimated Consumption for Items.....	798
Setting Up Degree Days (and Average Temperatures).....	799
United Kingdom VAT and CCL.....	799
UK VAT Overview.....	799
UK CCL Overview.....	800
UK VAT and CCL Bill Examples.....	800
Billing and UK VAT.....	802
Excess Credits and UK VAT.....	803

Setting Up The System For UK VAT and CCL.....	804
Quotes.....	807
The Big Picture Of Quotations.....	808
Basic Quotation Concepts.....	808
A Quote Shows How Bill Segments Might Look.....	808
Proposal Service Agreements Must Exist.....	809
Creating Quotes And Quote Details.....	812
Completing A Quote Creates Quote Routings (And More).....	813
Accepting / Declining Quote Details.....	813
Tinkering With Proposal SAs After Quote Generation.....	814
Closing Quotes.....	814
Alerts.....	815
Trees.....	815
Printing Quotes.....	815
Quote Routings Are Created For Each Recipient Of A Quote.....	815
Quote Route Types Control The Information Merged Onto Quotes.....	815
Technical Implementation Of Online Quote Display.....	816
Technical Implementation Of Printing Quotes In Batch.....	816
Reproducing The Quote Print Flat File.....	816
How To Reprint A Quote (For The Original Recipients or For Someone New).....	817
The Quote Extract Records.....	817
Maintaining Quotes.....	823
The Lifecycle Of A Quote And Quote Detail.....	824
Quote Lifecycle.....	824
Quote Detail Lifecycle.....	824
Quote - Main.....	825
Action Buttons On Quote Main.....	826
Quote Actions.....	826
Quote Detail Actions.....	828
Proposal SA Actions.....	828
Quote - Quote Details.....	828
Quote - Quote Routings.....	829
Service Credits.....	830
The Big Picture Of Service Credit Membership.....	831
Who are the Members?.....	831
Joint Membership.....	831
Changing the Membership Accounts.....	832
Membership Application.....	832
Creation of a Membership.....	833
Membership Fees.....	833
Stopping a Membership vs. Inactivating a Membership.....	833
The Big Picture of SC Events.....	834
Event Amounts May Contribute to a Balance.....	834
Events May Indicate a Fiscal Year.....	834
Events May Indicate a Subcategory.....	835
An Event May Cause Other Actions to Occur.....	835
Financial Transactions for an Event.....	836
How Events Are Created.....	836
Events Created by an Algorithm.....	836
Events Created as a Result of a Background Process.....	836
Creating Pending Events.....	837
Events May Be Transferred.....	837
CPCRALOC - Allocating Capital Credits.....	837
CPCRRETR - Capital Credit Retirement.....	839
Maintaining Service Credit Memberships and Their Events.....	840
Service Credit Membership.....	840
Lifecycle of a Membership.....	840
Service Credit Membership - Main.....	841
Service Credit Membership - Account.....	841
Service Credit Membership - Characteristics.....	842
Service Credit Membership - Membership Tree.....	842
Maintaining Service Credit Events.....	843
Lifecycle of a Service Credit Event.....	843
Service Credit Event - Main.....	843

Loans.....	844
The Big Picture Of Loans.....	845
Loans Are Service Agreements.....	845
Loan Interest Charges.....	845
Loan Amortization Schedules.....	846
Negative Amortization.....	846
Loan Overpayments.....	846
The Lifecycle Of A Loan.....	847
Finalizing And Closing A Loan.....	847
Navigating To The Loan Maintenance Page.....	847
Loan Maintenance.....	848
How To.....	850
How To Start A Loan Service Agreement.....	850
How To Modify The Terms Of A Loan.....	851
How To Adjust Loans.....	851
How To Stop A Loan Service Agreement.....	851
Non-Billed Budgets.....	852
The Big Picture Of Non-Billed Budgets.....	852
Non-Billed Budget Service Agreements.....	853
Which SAs Are Covered By A Non-Billed Budget?.....	853
Non-Billed Budgets Versus Other Plans For Payment.....	853
There Are Two Types Of Non-Billed Budgets.....	854
Navigating To The Non-Billed Budget Maintenance Page.....	854
Recommending Scheduled Payments.....	854
Maintaining Non-Billed Budgets.....	855
Non-Billed Budget - Main.....	855
Non-Billed Budget - History.....	856
How To.....	857
How To Start A Non-Billed Budget Service Agreement.....	857
How To Cancel / Stop Non-Billed Budget SAs.....	857
How To Renew Non-Billed Budgets.....	857
How To Set Up Automatic Payment For A Non-Billed Budget.....	858
Case Management.....	858
Background Topics.....	859
Case Type.....	859
Creating Cases.....	859
Log Information.....	859
Alerts.....	859
To Do's and Cases.....	860
Reports.....	860
Maintaining Cases.....	860
Case - Main.....	860
Case - Case Portal.....	862
Case - Log.....	863
Premise Management.....	864
Overview.....	864
Define Premise Hierarchy.....	864
Manage Premises for a Landlord.....	864
Manage Groups of Premises.....	865
Premise Management Page.....	865
Start Service.....	867
Stop Service.....	868
Assign Parent Premise.....	869
Remove Parent Premise.....	869
Assign Landlord.....	869
Remove Landlord.....	869
Umbrella Agreement Management.....	869
Overview Of Umbrella Agreement & Terms Of Service.....	870
Umbrella Agreement - Contacts.....	870
TOS Covered Entities.....	871
Rate Terms Overridden By Terms Of Service.....	871
Rate Schedule Override by TOS.....	871
Override Of Other Rate Terms By TOS.....	871
Umbrella Agreement Renewal.....	872

Umbrella Agreement Renewal Background Process.....	872
Umbrella Agreements & Proposals.....	872
Additional Umbrella Agreement Topics.....	872
Umbrella Agreement Alerts.....	872
Orders And Umbrella Agreements.....	873
Umbrella Agreement Reports.....	873
Umbrella Agreement Maintenance.....	873
Lifecycle Of An Umbrella Agreement.....	873
Umbrella Agreement - Main.....	874
Umbrella Agreement - Contacts.....	874
Umbrella Agreement - Characteristics.....	874
Terms Of Service Maintenance.....	875
Lifecycle Of Terms Of Service.....	875
Terms Of Service - Main.....	875
Terms Of Service - SAs.....	877
Overdue Financial Obligations.....	878
Overdue Processing Background Information.....	878
Overdue Process Maintenance.....	878
Overdue Process - Main.....	878
Overdue Process - Events.....	880
Overdue Process - Log.....	881
How To Perform Common Overdue Process Functions.....	881
How To Create An Overdue Process.....	881
How To Change Overdue Events.....	882
How To Cancel An Overdue Process.....	882
Cut Process Maintenance.....	883
Cut Process - Main.....	883
Cut Process - Events.....	884
How To Perform Common Cut Process Functions.....	885
How To Create A Cut Process.....	885
How To Change Cut Events.....	885
How To Cancel A Cut Process.....	886
Payment Arrangement for Bills.....	886
How To Set Up A Payment Arrangement.....	888
How To Add Additional Debt To A Payment Arrangement.....	889
How To Break A Payment Arrangement.....	889
How To Cancel A Payment Arrangement.....	889
Rebate Claims.....	889
Rebate Claim Query Portal.....	890
Rebate Claim Portal.....	890
Rebate Claim Zone.....	890
Rebate Claim Status.....	891
Rebate Claim Actions.....	892
Editing Rebate Claims.....	892
Verifying Rebate Claims.....	892
Approving Rebate Claims.....	893
Rejecting Rebate Claims.....	893
Noting Issues Related to a Rebate Claim.....	893
Canceling Rebate Claims.....	893
Adding Rebate Claims.....	893
Rebate Claim Line Zone.....	894
Adding Rebate Claim Lines.....	894
Deleting Rebate Claim Lines.....	894
Editing Rebate Claim Lines.....	895
Verifying Rebate Claim Lines.....	895
Rebate Claim Log Zone.....	895
Adding Rebate Claim Log Entries.....	895
Communications.....	896
Device Events.....	896
About Device Events.....	896
Processing Device Events.....	896
Activities.....	899
About Activities.....	899
Maintaining Activities.....	900

Communications.....	900
About Communication Out.....	900
About Communication In.....	901
Maintaining Communications.....	901
Completion Events.....	902
About Completion Events.....	902
Maintaining Completion Events.....	902
Notification Suppressions.....	902
About Device Event Notification Suppressions.....	902
Maintaining Notification Suppressions.....	903
Integrations.....	903
Business Flags.....	903
About Business Flags.....	903
Maintaining Business Flags.....	903
Aggregations.....	904
Standard Aggregations.....	904
About Aggregations.....	904
Creating Aggregators.....	907
Base Product Aggregators.....	908
Maintaining Aggregations.....	909
Dynamic Aggregation.....	909
Dynamic Aggregation Overview.....	909
Understanding Dynamic Aggregation Execution.....	910
Dynamic Aggregation Processing.....	911
Types of Aggregations.....	916
Aggregation Measuring Components.....	919
About Aggregation Measuring Components.....	919
Maintaining Aggregation Measuring Components.....	919
Master Data Synchronization.....	920
Outage Storm Mode.....	920
About Outage Storm Mode.....	920
Reviewing Widespread Outages.....	922
Dashboards.....	922
About Dashboards.....	923
Using the Customer Operational Dashboard.....	923
Using the MDM Operational Dashboard.....	923
Using the Service Order Operational Dashboard.....	924
Using the Service Order Trends Dashboard.....	924
Totals and Trends.....	925
Processing Statistics.....	925
About Processing Statistics.....	925
About Head-End System Processing Statistics.....	925
Consumption Statistics.....	926
Time Zone Support.....	926
Daylight Savings Time Support.....	926
Multiple Time Zone Support.....	928
Service Issue Monitors.....	930
About Service Issue Monitors.....	931
About Service Investigative Orders.....	932
Oracle Utilities Rate Cloud Service.....	932
Overview.....	932
Setting Up Rates with Oracle Utilities Rate Cloud Service.....	932
Using Rate Check with Oracle Utilities Rate Cloud Service.....	932
Data Access Restrictions.....	933
Using Data Access Restrictions.....	933
To Do Processing.....	934
The Big Picture of To Do Processing.....	934
To Do Role.....	934
To Do Priority.....	934
Work Distribution.....	935
A User's Current To Do.....	935
Related To Do Entries.....	936
Complete A To Do.....	936
Managing To Do Entries.....	936

To Do Management.....	936
To Do Supervisor Functions.....	939
Supervisor To Do Summary.....	939
Supervisor User Summary.....	940
Supervisor To Do Assignment.....	940
To Do List Functions.....	941
To Do Summary.....	941
To Do List.....	942
To Do Entry.....	944
To Do Entry - Add Dialog.....	944
To Do Entry - Main.....	944
To Do Entry - Keys/Values.....	946
To Do Entry Actions.....	946
To Do Search.....	948
To Do Search - Main.....	948
To Do Search Actions.....	950
How To.....	950
How To Assign a To Do to a User.....	950
How To Work on To Do Entries.....	951
How To Add a New To Do.....	952
How To Complete To Dos.....	952
How To Forward a To Do.....	952
How To Send Back a To Do.....	952
How To Add a Log Entry to a To Do.....	953
Reports.....	953
About Reports.....	953
Running Oracle Utilities Meter Data Management Reports.....	953

Chapter 1

Business User Guide

Customer to Meter Overview

Oracle Utilities Customer to Meter is a next generation customer service and billing application that incorporates a modern meter data management system. This system is designed to scale with mass smart meter volumes while handling the complexity associated with a utility’s processes across multiple types of service, operating divisions, and jurisdictions. The new application components allow for traditional scalar meter functionality that is equivalent to prior versions of Oracle Utilities Customer Care and Billing; so, it can accommodate the many types of utility environments, and evolve with the business to include more advanced digital requirements.

The roles for each application area in are defined as follows:

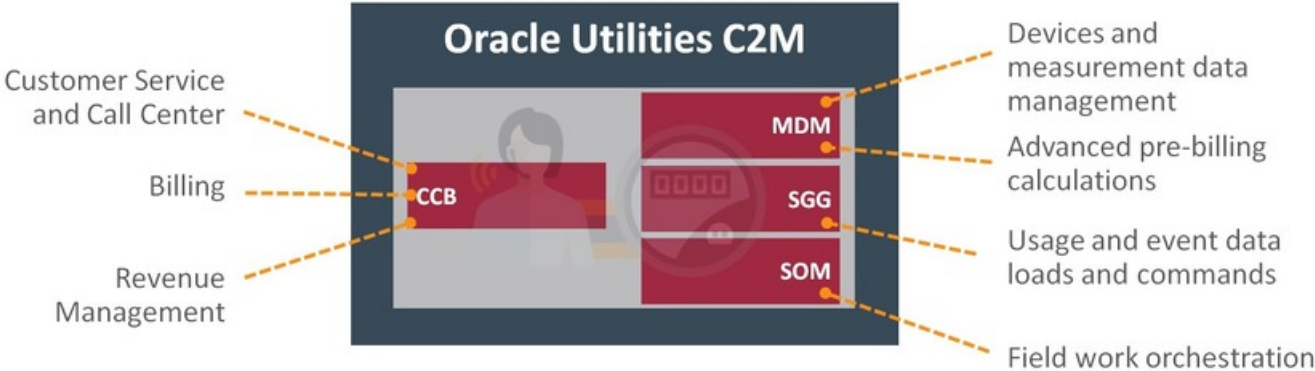

The application components have internal integration for master, admin, and transactional data. The primary transactions between them are for bill determinant processing with MDM and service order processing with SOM. These transactional processes can be initiated by the CCB solution, or from other external systems.

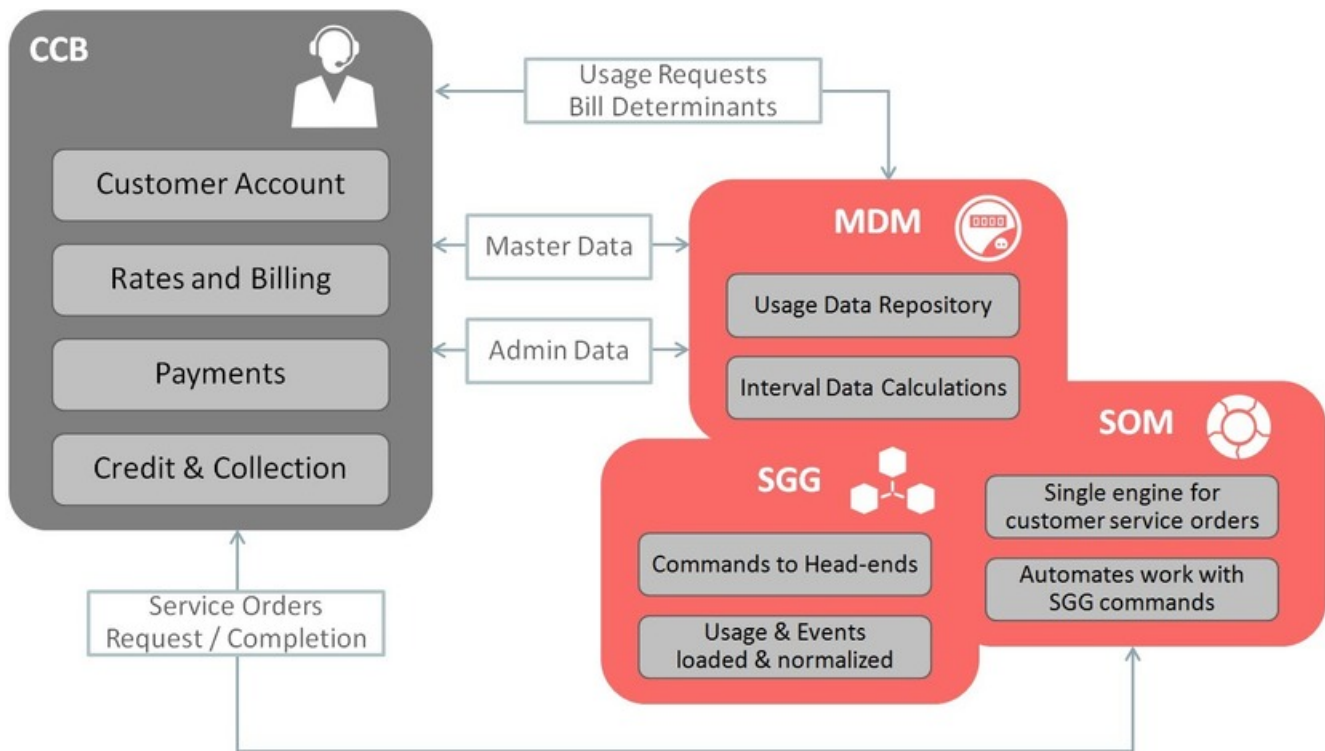

In addition, Oracle Utilities Customer To Meter can also include asset management functionality via Oracle Utilities Operational Device Management which provides the ability to handle large volumes of assets and to manage the receipt, installation, maintenance, tracking and removal of those assets.

Oracle Utilities Customer Care and Billing Overview

Oracle Utilities Customer Care and Billing (CCB) manages customer information and processes associated with the customer lifecycle including:

- Sales and marketing, and program management.
- Customer information for residential, commercial, and industrial customers; including, complex premise management, umbrella agreements, and quotations proposals.
- Starting and stopping service; including, order entry for eligible products and services.
- Customer care interactions for inbound communications (such as phone calls), outbound communications (such as letters or notifications), and case management (configurable customer processes).
- Advanced rating rules.
- Financial management for billing, budget plans, deposits, loans, and payment processing (including cashiering portals).
- Credit and collection for overdue receivables management.

Oracle Utilities Customer Care and Billing acts as a detailed sub ledger for accounts receivables with the ability to send results to a general ledger. It also provides a Control Central portal that increases productivity by providing a comprehensive view of the customer and their related account information so that most questions can be quickly answered without having to navigate through the system.

Oracle Utilities Meter Data Management Overview

Oracle Utilities Meter Data Management (MDM) acts as a consolidated usage measurement data repository with advanced validation, editing, and estimation (VEE) rules. These rules ensure accuracy and measurement compliance that is associated with advanced metering infrastructure (AMI), traditional one-way meters, and a rich usage calculation rules engine.

The following lists the most crucial business processes that are enabled within this system:

- Defining devices; such as, meters at customer locations, device configurations for measurement collection and command execution, customer service points, and effective device installations.
- Loading scalar readings, interval data, and events data from a Head End system or other source.
- Automatic validating, editing, and estimating (VEE) measurement data
- Robust editing capabilities for scalar readings and interval measurement data
- Calculating and publishing bill determinants and other transactions from measurement data. This data is then used in external systems; such as, billing, and pricing. It can also be applied to aggregation for settlement, load research, forecasting, and revenue management.
- Service Issue Monitor configurable process to identify and correct devices that may have operating issues.

The system has a 360 Degree View device portal that provides advanced navigation and operational analytics to improve operational efficiency. It is designed for handling large volumes of meter/device data to enable increased accuracy, flexibility, and scalability.

Oracle Utilities Smart Grid Gateway Overview

Oracle Utilities Smart Grid Gateway (SGG) is designed as a messaging broker to communicate with meters and other devices using a common interface. This allows the system to hide much of the background complexity that can occur when multiple head end or meter data collection systems are used.

SGG functionality covers the following types of standardized processing.

- Loading usage and event data records that are collected on a frequent basis.
- Providing normalized raw data to other applications that require information with the ability to filter based on requirements.
- Standardizing command and control use cases; such as, turning a meter device on or off, checking the current status of a device, and requesting a measurement on-demand via electronic messages to the corresponding head end system.
- Centralizing command and data exceptions with the ability to automate retry processing.

SGG delivers pre-built adapters that support integrations to leading metering technology vendors. It also provides an Adapter Development Kit (ADK) to easily integrate with other sources. The system can provide a single auditable link to devices across all systems, simplify integrating with other utilities applications, and allowing normalized protocols and data types. The platform can expand to allow other types of device and customer communications, beyond meters; or other types of distribution and network devices that are upstream from the metering technology.

Oracle Utilities Service Order Management Overview

Oracle Utilities Service Order Management (SOM) delivers a new approach to handling the most common customer service order use cases for smart metering technology and traditional metering. Rather than generating specific field activity tasks, Oracle Utilities CCB triggers field activity requests that are based on the classic customer scenarios: start service, stop

service, disconnect for non-payment, reconnect service, etc.. Oracle Utilities SOM receives these requests and determines whether the installed device technology can support electronic commands (sending messages via Oracle Utilities SGG), or not (meaning that a field visit is required to complete necessary tasks). Some situations may also require both automated and manual activities to occur, and in a specific sequence; such as, first replacing an old meter with a smart meter through a field visit, then sending a series of Oracle Utilities SGG messages to the new meter.

Oracle Utilities SOM continually monitors and initiates activities to get the service point, device, and completion fully processed; this includes obtaining supporting data, such as measurements needed for billing, in a manner that is appropriate for the associated meter's technology. As more smart devices are installed in the field, Oracle Utilities SOM provides increased savings by reducing field visits, and using more electronic messaging that take care of logic and error handling.

In addition to being initiated by the customer system, service order requests can also be initiated by other systems; for example,

- Oracle Utilities Meter Data Management might detect service issue through its monitoring processes
- Oracle DataRaker's advanced analytics might detect patterns with the meter, device, or customer behavior.
- Oracle Utilities Operational Device Management (ODM) might trigger operational processes; such as, periodic device testing or configuration parameter updates.

It is critical for customer service business processes to see all types of requests that are initiated by other systems and their current execution status. SOM assumes that a mobile workforce system is in use. These systems provide several important functions: they remove the need for printed service orders, handle the assignment and scheduling of work to crews, and provide appointment booking services.

Oracle Utilities Operational Device Management Overview

Oracle Utilities Operational Device Management provides functionality to handle large volumes of assets and to manage the receipt, installation, maintenance, tracking and removal of those assets.

The system supports the following business processes:

- Capturing device attributes and supporting any type of device
- Supporting integration with other utility applications requiring device information and configuration
- Supporting detailed smart device attributes
- Supporting detailed location management and tracking of individual devices throughout their lifecycle
- Capturing device configurations and settings
- Managing configuration between devices, components and software
- Tracking firmware and firmware versions on smart devices

User Interface Standard Features

This section describes basic system concepts, features, and standards of the user interface.

Page Components

Oracle Utilities Application Framework screens are comprised of the following main areas:

1. The Application Toolbar
2. The Page Title Area
3. The Object Display Area

4. The Dashboard Area

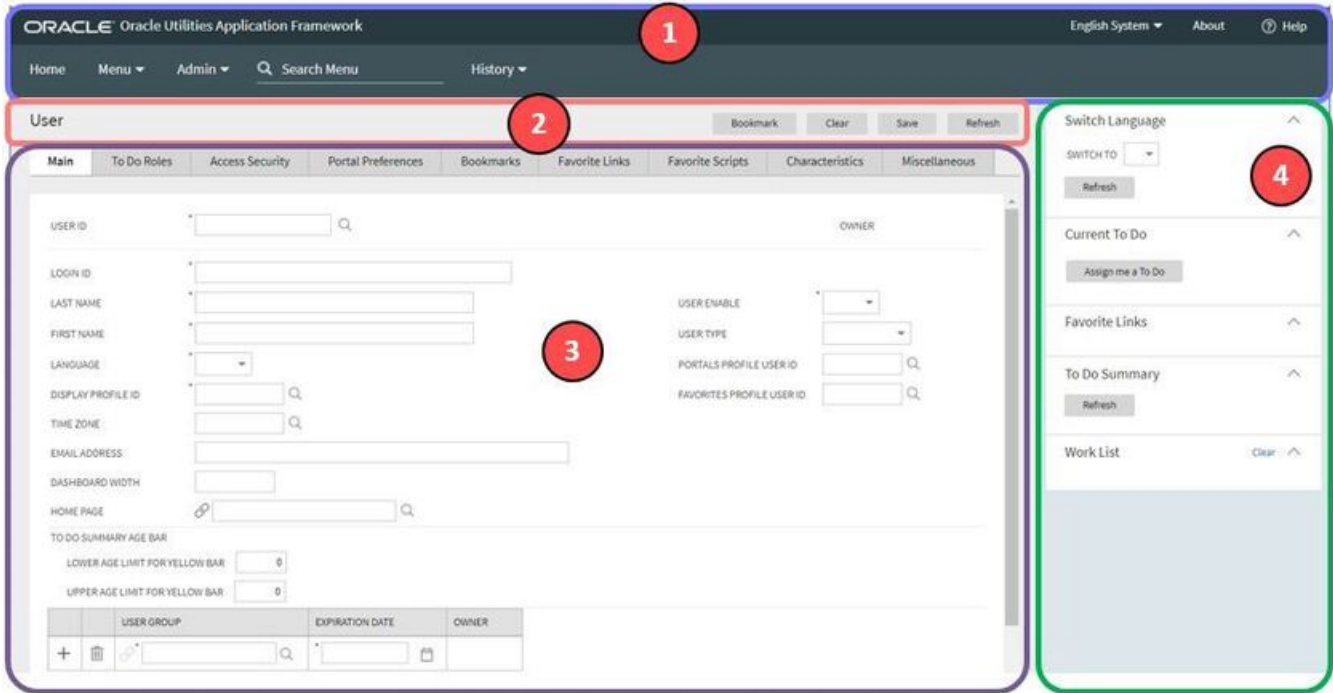

NOTE: The look and feel of the application may be modified after the product is installed. See [Custom Look and Feel Options](#) for customization information, including how to change colors, fonts, and other system features. The information provided in this document represents features and functionality available only in the delivered product.

The next topics provide more information about each component and the Script area, which appears in the Object Display area when applicable.

The Application Toolbar

This section describes the features available on the application toolbar.

Home Button



Click the **Home** button, , on the Application Toolbar to open your home page. Your home page is defined in [User Preferences](#).

Keyboard Shortcut	Alternate Shortcut
Alt+O	Alt+Shift+O

NOTE: Refer to [Shortcut Key Summary](#) for information about the alternate shortcut.

Menu

Menu is available in the application toolbar to help you navigate to the different pages of the system

Keyboard Shortcut

Ctrl+Alt+M

The menu list is organized by functional area. Clicking the Menu button displays each functional area. Clicking a functional area, in turn, displays a submenu that contains pages within that area.

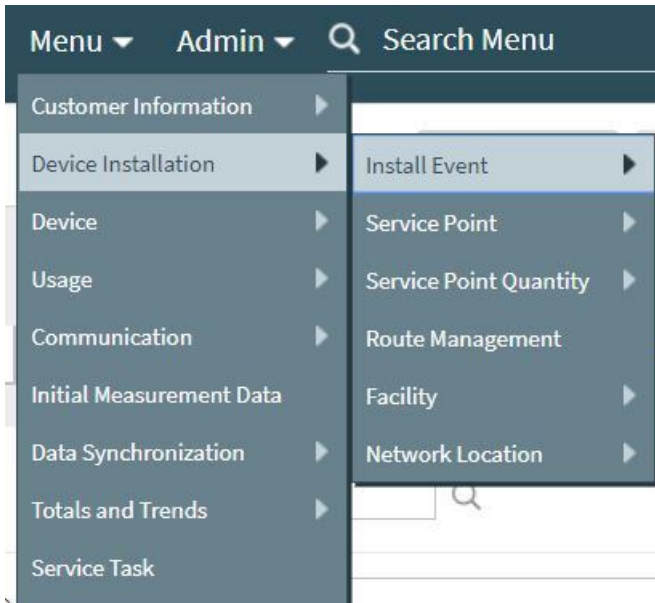

The pages within each functional area *typically* have two options: Search and Add. If the menu item does not have an Add or Search option, select the menu item itself.

How the Search and Add option behaves depends upon whether the maintenance page is fixed or portal-based.

Fixed:

- **Search:** Displays a pop-up search window for the user to enter the search criteria and select the entity to display. Once the entity is selected, the user is taken to the maintenance map with the data populated in the fields.
- **Add:** Displays the maintenance page with empty fields so that the user can complete the information and save the entity.

Portal-Based:

- **Search:** Displays a search portal where the user can enter the search criteria and select the desired entity. Once the entity is selected, the user is typically taken to a maintenance portal or the information is broadcast to other zones within the same portal.
- **Add:** Either navigates to a page where the user can select the entity type or business object, or directly to the input map where the user can enter and save the entity.

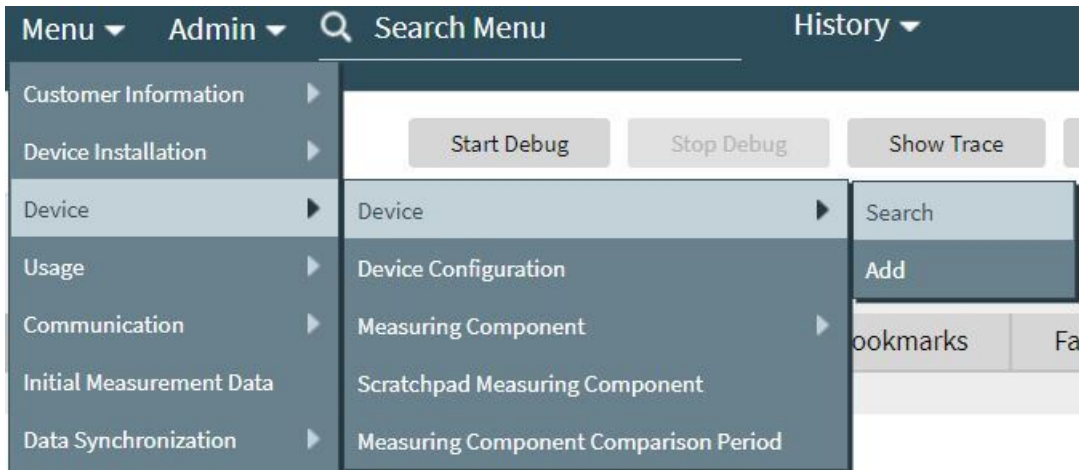

Users may also opt to use the [Menu Item Search](#) input field.

Admin Menu

The Admin dropdown is available in the application toolbar to help you navigate to the different pages of the system.

Keyboard Shortcut

Ctrl+Alt+A

Depending on how your implementation has configured the Admin menu list, it may be organized either by functional area or alphabetically.

Clicking the Admin button displays each functional area or alphabetical list. Clicking one of the options, in turn, displays a submenu that contains pages within that area. The following is an example of the Admin menu organized functionally.

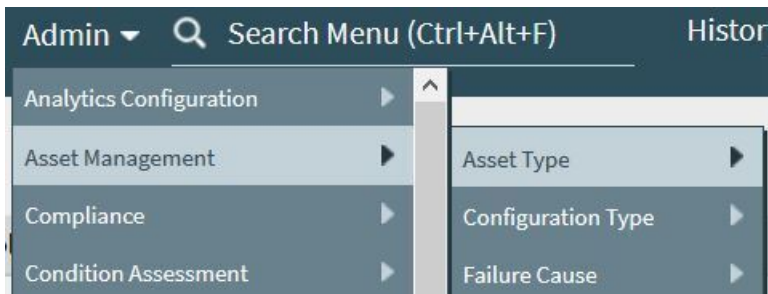

NOTE: Menu navigation paths referenced in the administrative user guide provide the functional grouping. If your implementation uses the alphabetic grouping, the page can be found in the alphabetic letter that is the first letter of the page name.

NOTE: Refer to [Installation Options](#) for information about the admin menu configuration options.

The menu lines displayed for each menu entry *typically* have two options: Search and Add. If the menu item does not have an Add or Search option, select the menu item itself. See [Menu](#) for more information about these options.

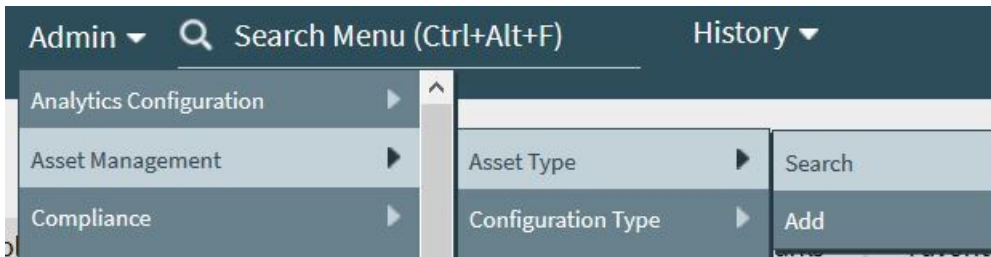

Users may also opt to use the [Menu Item Search](#) input field.

Back Button

Click the **Back** button on the application toolbar to open the previously visited page.

Keyboard Shortcut

Alt+B



The **back** and **forward** navigation buttons, as well as the **History** list, appear in the application toolbar only when page use warrants their appearance.

NOTE: Under certain circumstances, such as revisiting a page that was left unsaved after being loaded with default data, a page may not appear as it did when you left it.

History Button

Click the **History** button to display a list of previously visited pages. When you click on an entry in the list to return to an earlier page, all items above the selected page are removed from the list.

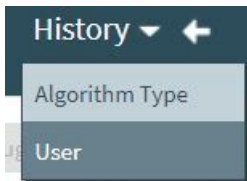

The **back** and **forward** navigation buttons, as well as the **History** list, appear in the application toolbar only when page use warrants their appearance.

Note that if the page has been configured to display an information string in the [page title area](#), that information will also be visible in the History dropdown.

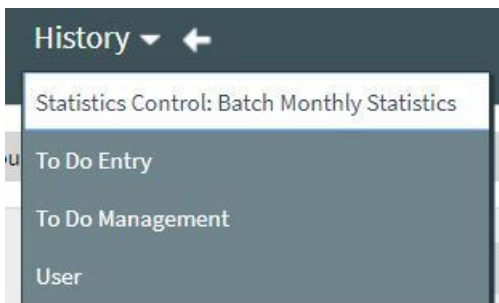

Keyboard Shortcut

Ctrl+Alt+H

Forward Button

Click the **Forward** button to return to the page that was most recently dismissed.

Keyboard Shortcut

Alt+G



The **back** and **forward** navigation buttons, as well as the **History** list, appear in the application toolbar only when page use warrants their appearance.

NOTE: Under certain circumstances, such as revisiting a page that was left unsaved after being loaded with default data, a page may not appear as it did when you left it.

About Button

Click the **about** button to display a window that describes the current and release information for your version of your product.

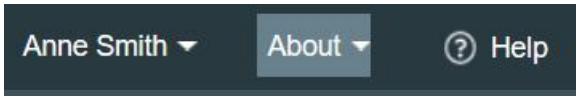

The about window shows a variety of information including:

- The logged in user ID
- The list of products installed in the application along with the release ID. This information comes from the [installation record](#). Note that in a Cloud installation, only the Cloud product name and release ID are displayed. The details of the products that make up the Cloud installation are not displayed (but are still visible on the installation record).

User Menu

The User menu is available in the application toolbar to provide access to user-specific options.

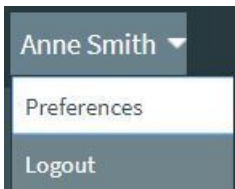

Through this dropdown, the user can access their [User Preferences](#) or [Logout](#) of their current session.

NOTE: Configurable Menu. Additional menu entries may be visible in your implementation as this menu configuration allows for additional options to be defined.

Preferences

Click the **Preferences** menu item in the User Menu to view or modify your settings in a form that appears in the **Main** tab in the object display area.

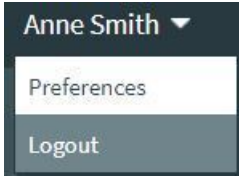

Keyboard Shortcut

Ctrl+Alt+P

Logout

Click the **Logout** menu item in the User Menu to complete your current session of the application. Clicking this item logs the current user out and displays the Welcome page so that another user can login.

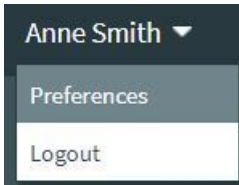

Keyboard Shortcut

Ctrl+Alt+L

Menu Item Search

The Search Menu input field and search icon are used to allow a user to enter the description of a menu item entry to navigate directly to the corresponding page or BPA script rather than using the menus to navigate to the desired page / script.

Keyboard Shortcut

Ctrl+Alt+F



Typing text in the field shows menu items whose descriptions include the typed text.

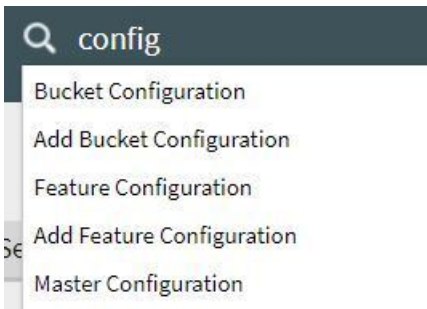

Note that only menu items within the [Menu](#) and [Admin Menu](#) that the user has security access for are included in the results. The text included in the search is taken from the menu item description. As described in [Menu](#), menu lines often have two sub item: Search and Add. In most instances, the description of the "Search" menu item is simply the menu entry text, for example **To Do Entry**. The description of the "Add" menu entry includes the word Add in front of the menu entry text, for example **Add To Do Entry**.

As mentioned in [Menu Item Suppression](#), menu items will not appear if it is associated with a module that is suppressed.

NOTE: When operating in debug mode, the description of the parent menu is displayed in parentheses after the menu item description.

Help Button

Click the **Help** button in the Application Toolbar to open context-sensitive Help in a new browser window.

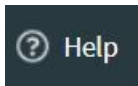

Keyboard shortcut:

Keyboard Shortcut

Alt+F1

Page Title Area

The Page Title Area displays the page title and the page actions toolbar.

For certain pages in the system, the page title may be followed by an information string. It is only applicable to portal-based pages that display a single record. This information is only visible if the portal has been configured to display the primary key's information string. Typically only "stand alone" maintenance portals are configured to show the information string, whereas "all-in-one" portals are not configured this way.

FASTPATH: Refer to [Common Base Portals and Zones](#) for more information about standard base product portals.

NOTE: If an information string is long and would interfere with a page actions button, the information string will automatically be truncated and suffixed by an ellipsis, "...", indicating that more information is available. In this situation, the missing text can be viewed if the user hovers their mouse over the string.

The Page Actions Toolbar displays standard control options, such as Save and Duplicate. More detail about the actions that may appear are described in the following section.

Page Actions Toolbar

In the Page Title Area, control functions appear in the Page Actions Toolbar; such as, Clear, Save, Duplicate, Delete and Refresh buttons.

NOTE:

Buttons in the Page Title Area appear as the function is available to the user; for example, the Delete button will not appear if the user has made any changes to the page's content, or does not have the necessary security rights for this action.

In addition, other functions that are specific to a portal-based page may appear in the toolbar, if configured. For example, the ability to navigate to the Search zone for a specific maintenance object may be visible on the maintenance portal.

This section describes the standard features that are available in the Page Actions Toolbar.

Bookmark Button

Click the Bookmark button on the Page Actions Toolbar to save the current page and context to the bookmarks list.



Keyboard Shortcut

Ctrl+Alt+B

NOTE: Secured. This button is secured using the application service **F1-BOOKMARKS**. Users that do not have security for the application service will not see the Bookmark button (or the corresponding dashboard zone).

After clicking the Bookmark button, you are prompted to provide a name for the bookmark. After saving, it is visible in the [Bookmarks Zone](#), allowing you to return to this page with this context loaded with one click.

NOTE: Unsaved data will not be included in the bookmark. If you view a record and make changes to data without saving the changes and then bookmark the page, the unsaved changes are not included in the bookmark information.

You may change the name of the bookmark or change the sequence of the bookmarks by navigating to the [User - Bookmarks](#) in the user preferences.

Next/Previous Item Buttons

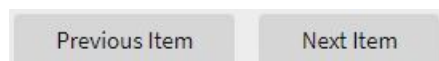

The (**Previous Item** and **Next Item** buttons appear in the Page Actions Toolbar under these conditions:

- You access a fixed page, meaning that it is not portal-based.
- You use a search page to display an item.
- There are multiple items in the search results list *below* or *above* the selected item.

If, for example, you enter search criteria of "Smith" on the User Search page, you might see the following results:

- Smith, Albert
- Smith, Peter
- Smith, Zane

If you select **Smith, Peter**, Peter's user information is displayed on the User page. If you then click the **Next Item** button, **Smith, Zane** will be displayed. In addition, because **Smith, Zane** is the last entry in the search results, the **Next Item** button is no longer needed and will not appear in the Page Actions Toolbar.

If you then click the **Previous Item** button, **Smith, Peter** will be displayed; click again and the **Smith, Albert** record will appear, and, because **Smith, Albert** is the first entry in the search results, the **Next Item** button is no longer needed and will not appear in the Page Actions Toolbar.

Keyboard Shortcut**Alternate Shortcut**

Alt+P

Alt+N

Alt+Shift+N

NOTE: Refer to [Shortcut Key Summary](#) for information about the alternate shortcut.

Duplicate Button

Click the **Duplicate** button in the Page Actions Toolbar to create a duplicate of the currently selected object.



Before the new object is added to the database, a dialog appears in which you must enter the unique identifier for the duplicate object. When you click OK, the system creates the record by copying the original record. It may be helpful to think of the duplication function as the equivalent of a "save as" action.

Keyboard Shortcut

Ctrl+Alt+D

NOTE: Copying ancillary information for a record sometimes requires confirmation during a duplication request. If so, you may also be asked if you also want to duplicate ancillary information. If, for example, you duplicate a user group, besides supplying the ID of the new user group, you are asked if all users in the original user group should be linked to the new user group.

This button does not appear in the Page Actions Toolbar when:

- Duplication is not supported for the current object.
- You are on a portal based page. (For these types of pages, if duplication is supported, the actions are defined in a zone on the portal.)
- You have made changes to the object without committing the changes to the database by clicking Save. (After making changes, you must either discard them using the **Refresh** button, or save them.)

Delete Button

Not all transactions have the capability to be deleted. Deletion is related to the business impact of the action. In some transactions, Delete is present for some scenarios and unavailable for others; for example, you may not be able to delete a record at a certain status level.

NOTE:

If you make a change to an object and do not save the changes to the database, you cannot delete the object until you either save the changes or refresh the object with the contents on the database.

Before you delete an object, the system verifies that the object is not referenced anywhere in the system. If it is, you cannot delete it. If, for example, you attempt to delete a user, the system ensures this user has not been referenced in a user group or on a To Do.

Depending on the type of page that you are using, the option to delete may vary.

- Fixed pages display a Delete button in the page actions toolbar when the option is available.

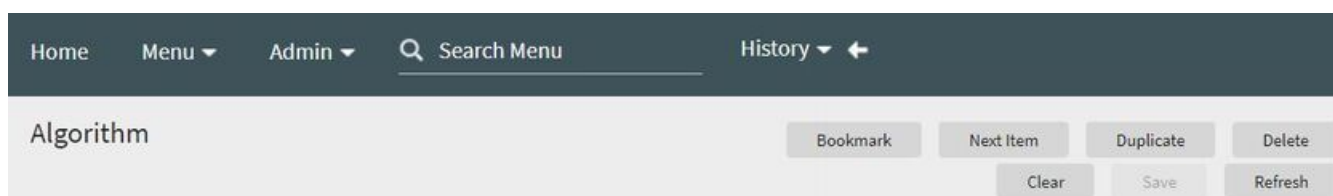

- Portal-based pages display the Delete button in the object-related map.

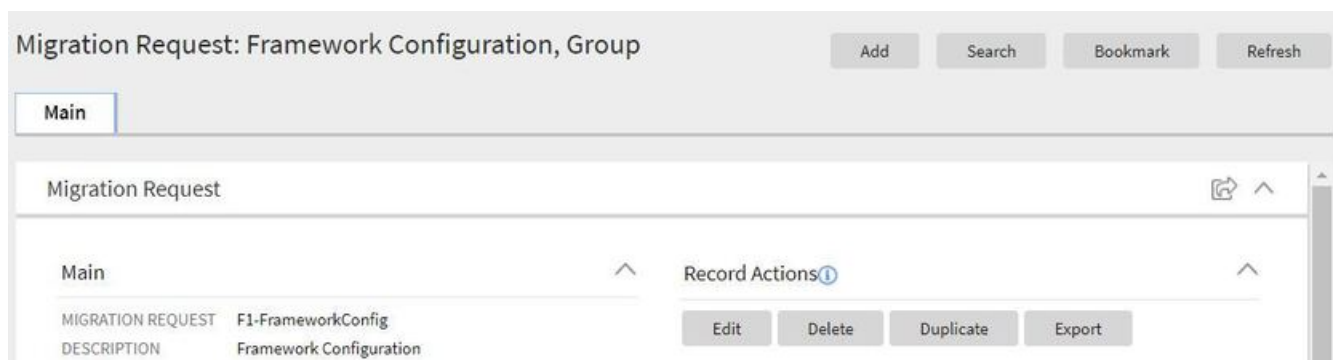

- List style fixed pages commonly display the Delete button (garbage can icon) next to the entity in the list.



In all cases, before the object is deleted, a confirmation dialog is displayed.

CAUTION: A timeout situation could occur as the system attempts to verify the use of the deleted object if the object is referenced in many places *and* involves large volumes of production data. If this timeout situation occurs, you must work with your database administration group to delete the offending object.

Clear Button

Click the **Clear** button to remove the values from the currently displayed object's fields. This action is typically used to clear input fields when adding a new object.

Keyboard Shortcut

Ctrl+Alt+C



Save Button

Clicking the **Save** button saves any changes you have made in the data on the current object.



Keyboard Shortcut

Alt+S

Alternate Shortcut

Alt+Shift+S

NOTE: Refer to [Shortcut Key Summary](#) for information about the alternate shortcut.

The button does not appear unless:

- You enter a page in add mode and default values are loaded.
- You make changes to an object after it is displayed (note that you must tab or click out of the field before the Save button appears).

Refresh Button

Click the Refresh button to reload the values on the page with those from the database.

CAUTION: All unsaved changes are discarded.

Keyboard Shortcut

Alt+R



Object Display Area

The Object Display Area contains the details of the object(s) currently being viewed or maintained. For example, if you display a portal, its zones are displayed in this area.

Because many of the page components follow Internet standards of operation, the behavior of these types of components are not explicitly described. This section focuses on special features that are unique to the application framework.

Multiple Tabs

When a page in the application includes a lot of information, the page may be implemented with vertical scrolling to allow the user to view all the information. Or alternatively, the page may be implemented with several tabs, allowing the user

to navigate between tabs to view or update information. The following image is a section of the User page showing the multiple tabs.

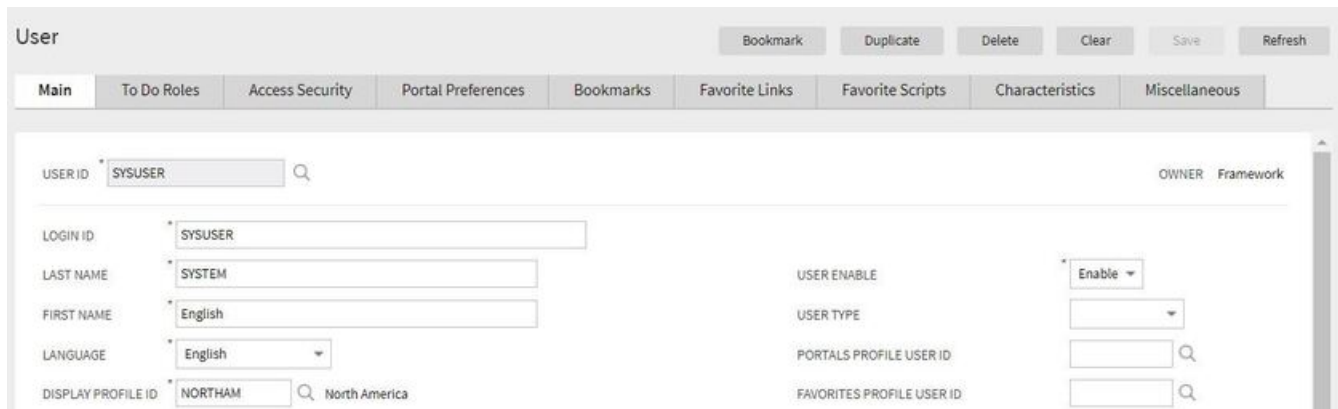

Figure 1: Multiple Tabs Example

The names of the tabs describe the type of information that will be displayed in the page when the tab is clicked. For example, if you click on the **Favorite Links** tab, the contents of the page show the favorite links configured for the user.

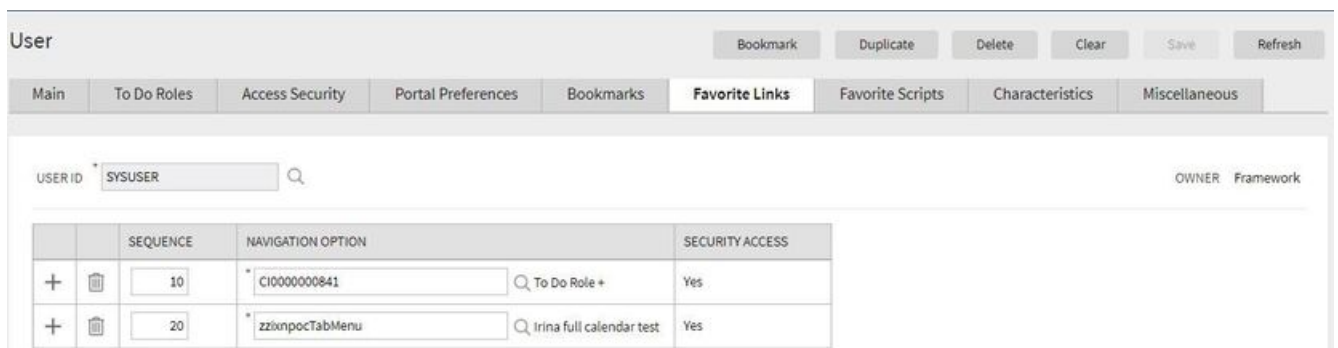

Figure 2: Multiple Tabs Example (After Favorite Links Tab Is Clicked)

NOTE: Hot key options. Rather than clicking on a tab, you can click **F2** or **Shift+F2** to scroll through the tabs. **F2** moves you through the tabs from left to right. **Shift+F2** moves you through the tabs from right to left.

NOTE: Hot key options. Use **Alt+number** to navigate to the tab page whose relative position corresponds with the number. For example, if you press **Alt+6** on the above page, the **Favorite Links** tab will be displayed. If there are more than 9 tabs on a page, you must use the mouse or **F2 / Shift+F2** to display a tab. Note that the numeric keypad on your keyboard cannot be used to implement this function.

NOTE: Returning to a page that contains multiple tabs. If you return to a page (by clicking the **Back** button or the **History** button), the page will be positioned on the last tab that was opened.

NOTE: Page versus Tab nomenclature. The documentation frequently refers to the contents of a given tab as a page. However, the page actually comprises the entire collection of tabs.

Text Box

The following is an example of a basic text box:

DESCRIPTION

Text input field with a red asterisk icon on the left.

If the text box is a large field, the text box may be configured to enable scrolling. In this situation, an expanded edit icon, (a pencil), will appear adjacent to it.

DETAILED DESCRIPTION

This BO enter algorithm creates a To Do entry.

The To Do Type is set as follows:

- > If To Do Type Element Name is defined, the value is retrieved from this element in the object's related type.
- > If no Element Name is defined or no To Do Type is found on the related 'type', the To Do Type parm is used.
- If no To Do Type is found, a log is added for the record with the error.

The To Do Role is set as follows:

- > If To Do Role Element Name is defined, the value is retrieved from this element in the object's related type.
- > If no Element Name is defined or no To Do Role is found on the related 'type', the To Do Role parm is used.

Additional capabilities are provided to display and edit data in these text boxes:

- If the field contains more text than is visible, a pop-up that displays the full text appears when you hover your mouse over the text box. The text in the pop-up can be selected and copied.

DETAILED DESCRIPTION

This zone type is used to create an info zone. Info zones contain a list of information about a given object. For example, you could set up an info zone to produce a list of all contacts made by the customer in context.

Info zones offer many features that can be used to change how the list looks "on the fly" (by end users). For example, users can add additional columns to the list, change the sort order, ...

For a more detailed description of how these zones look and behave, open the help and navigate to the index entry titled "info zone configuration".

To set up a new zone, fill in the zone's parameters as per each parameter's Comments. For examples, please refer to the "tips"

JAVA CLASS NAME

		SEQUENCE	PARAM
+	🗑️	10	VISI
+	🗑️	11	PRE

This zone type is used to create an info zone. Info zones contain a list of information about a given object. For example, you could set up an info zone to produce a list of all contacts made by the customer in context.

Info zones offer many features that can be used to change how the list looks "on the fly" (by end users). For example, users can add additional columns to the list, change the sort order, ...

For a more detailed description of how these zones look and behave, open the help and navigate to the index entry titled "info zone configuration".

To set up a new zone, fill in the zone's parameters as per each parameter's Comments. For examples, please refer to the "tips" that appear in the dashboard.

This zone's parameters support a single SQL statement. If you require a zone that is built using multiple SQL statements (e.g., if you need to retrieve rows from disparate sources), please use the Multi-SQL version of this zone type.

- If you click the expanded edit icon, an editable pop-up window appears. If the field is not protected as a result of business rules for the page, you may modify the text in this window.

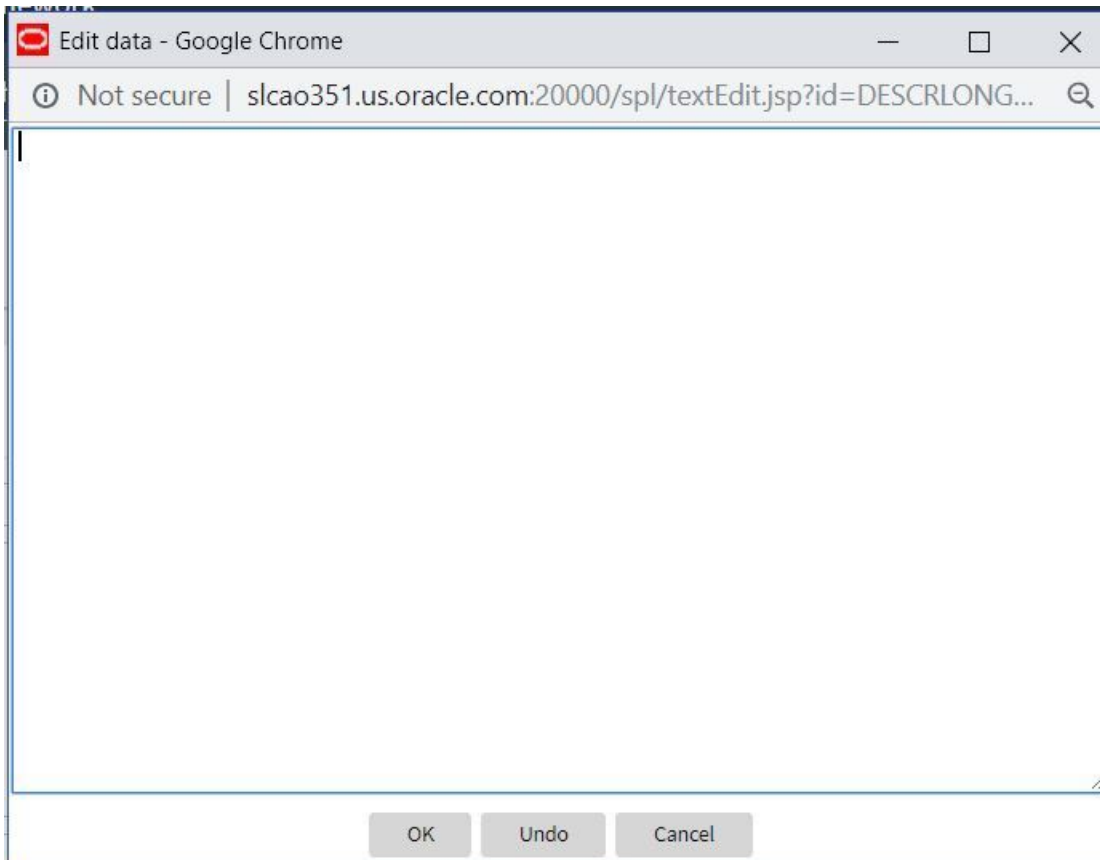

NOTE: The following table highlights special characters that are converted to equivalent standard characters when entered in a text box.

Entered Character Description	Unicode	Converted Character Description
Curly left double quote.	U+201D	Straight double quote.
Curly right double quote.	U+201C	Straight double quote.
Curly left single quote.	U+2019	Straight single quote.
Curly right single quote.	U+2018	Straight single quote.
En dash.	U+2013	Simple hyphen.
Em dash.	U+2014	Simple hyphen.
Ellipse	U+2026	Three dots.
Middle dot (bullet / centered dot)	U+00B7	Asterisk.
Fraction 1/4 (using 1 character).	U+00BC	1/4 (using three separate characters).
Fraction 1/2 (using 1 character).	U+00BD	1/2 (using three separate characters).
Fraction 3/4 (using 1 character).	U+00BE	3/4 (using three separate characters).

Date Only Field

When only the date is required, the Date field looks as follows:

EXPIRATION DATE

* 

If you click the calendar icon next to the date field, or you double-click inside the date field, the following window appears:

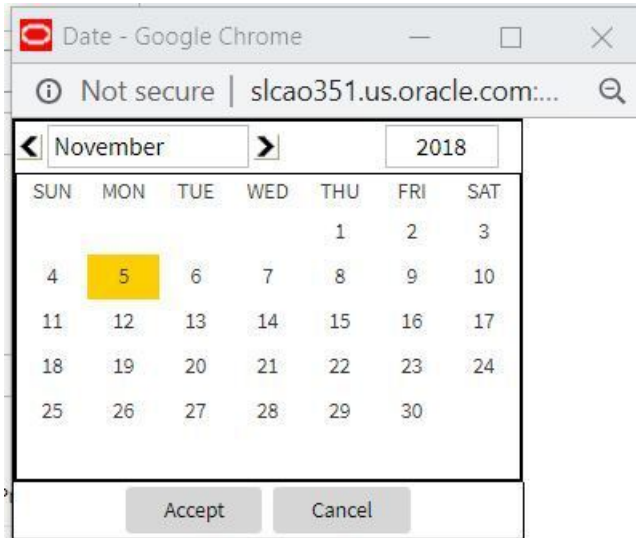

If the date field was blank, the current date is highlighted when the window first appears. If the date field contained a date, it is displayed.

You can double-click the desired date, or you can select a date and click Accept to close the date window and populate the date field.

Date and Time Field

When both the date and time are required, the Date and Time fields typically look as follows:

DESIRED EXECUTION DATE/TIME /

If you double-click or press the Enter key while the cursor is in a Date and Time field, the following window appears:

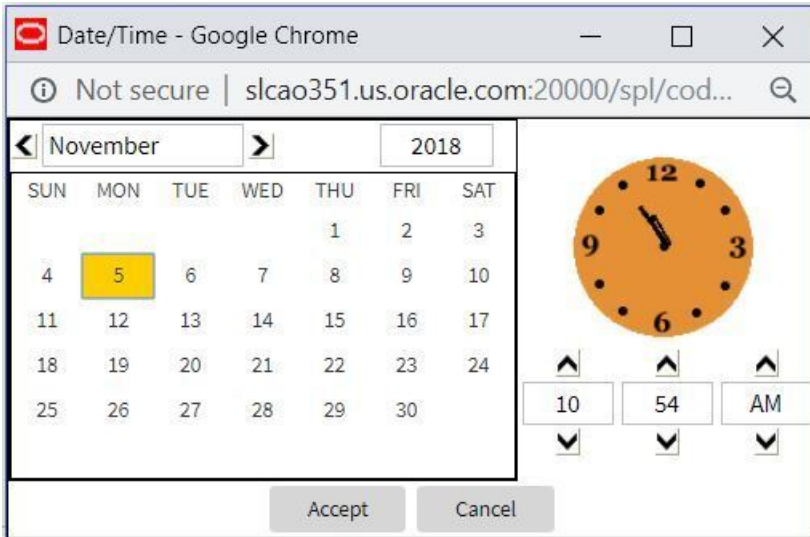

Select the date and use the toggle buttons (or enter) the time and then click **Accept** to populate the original fields.

NOTE: The user cannot select and move the hands on the clock to set the time.

Search Button

The search button appears primarily as a magnifying glass.

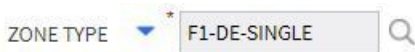

When using a pop-up search window, the search button can appear as a button with its function labeled.

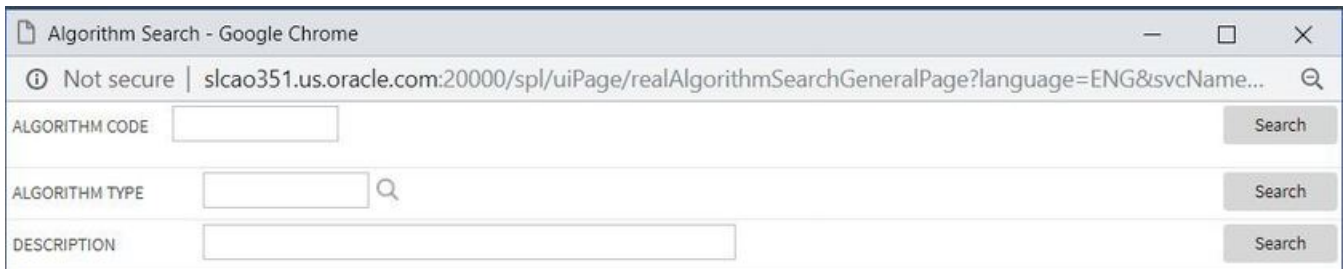

You can have the system search for an item that matches the data you entered using any of the following methods:

- Enter a value in the search field and press **Enter** while the cursor is in the search field. The system assumes you want to search for the value entered and pre-populates it in the search window's search criteria. If a unique match can be found, the system automatically populates the field with details corresponding to the record found. If a unique match cannot be found (either no matches or multiple matches), a search page opens containing selectable items.
- Click the Search button without entering a criteria. This will typically cause a pop-up search window to appear so that you can further refine your search.
- Enter a value and tab out of the search field. The system looks for a value that exactly matches what you entered. If it cannot find such a value, the search dialog will not be presented.

When an item is selected in the search page, the search page closes and the input field is populated with the value selected.

NOTE: Sorting columns within the search grid. You may click on the column heading of columns in a search grid to cause the contents of the grid to be sorted. Refer to [Sorting Functionality](#) for more information.

Context Menu Button

The Context Menu button is a small arrow that appears adjacent to an object's value or information string. An example is shown below:





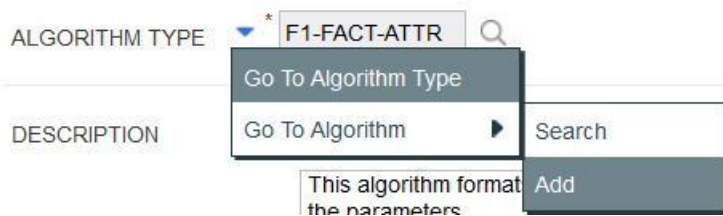

Context menus exist to help you navigate to other pages and populating the page with the current context (by passing the ID of the related object). In addition, the menu items offered in a Context Menu differ depending on the entity that the menu is related to; for example, when you click the Algorithm Type context menu, a pop-up menu similar to this appears:



Different context menus exist for each of the major objects in the system; for example, in Customer Care and Billing, the context menu for Premise contains premise-oriented menu items, whereas the context menu for Account contains account-oriented menu items.

Go To Button

Clicking a Go To button, , opens the page for the related object - it functions like a hyperlink.

		USER GROUP	EXPIRATION DATE	OWNER
+		 ALL_SERVICES <input type="text"/> System User Group	* 01-01-2100 	Framework
		<input type="text" value="Go To User Group"/>		

Broadcast Button

Some zones have been configured to "broadcast" unique identifiers to other zones within the portal; if so, you'll see a

broadcast icon, , in the first column. Clicking the icon causes specific zones to reload - these zones that have been configured to rebuild when the unique identifier is received. For example, you might have configured a zone to display the image of a bill when a bill ID is broadcast from an info zone.

Embedded Help Icon

The icon containing a small 'i' is an Embedded Help icon.



When an embedded help icon is clicked, a tool tip appears containing additional information.

Work Lists

The work list buttons can appear in a zone's column heading, .

Clicking the icon results in populating the dashboard [Work List Zone](#) with the entire column. The user may use the Work List zone to easily process entries one at a time without returning back to the source query zone. The work list stays populated until the user overlays the work list by clicking a different column's icon.

When a user clicks on a work list entry in the dashboard, the system behaves as if the user clicked on the hyperlink in the zone. In addition, the system adds a check mark next to the item showing that the user has "worked on" or visited the entry.

NOTE: The Work List zone is populated only upon user request.

Scroll Bars with Dynamic Height

Sometimes the height of a grid isn't sufficient to display a grid's rows. When this occurs, a vertical scroll bar appears and an "expand button" appears above this bar, . For example, the following grid is not high enough to show all of the available dashboard zones:

Dashboard - 7 of 8 zones selected for display.

ZONE	DISPLAY	INITIALLY COLLAPSED	SEQUENCE	REFRESH SECONDS	SECURITY ACCESS
Switch Language	<input checked="" type="checkbox"/>	<input type="checkbox"/>	<input type="text" value="20"/>	<input type="text" value="0"/>	Yes
Bookmarks	<input checked="" type="checkbox"/>	<input type="checkbox"/>	<input type="text" value="0"/>	<input type="text" value="0"/>	Yes
Current To Do	<input checked="" type="checkbox"/>	<input type="checkbox"/>	<input type="text" value="0"/>	<input type="text" value="0"/>	Yes

If you want to view all of the person's phone numbers without using the vertical scroll bar, you can you click the expand button. When clicked, the height of the grid expands to show all rows in the grid:

Dashboard - 7 of 8 zones selected for display.

ZONE	DISPLAY	INITIALLY COLLAPSED	SEQUENCE	REFRESH SECONDS	SECURITY ACCESS
Switch Language	<input checked="" type="checkbox"/>	<input type="checkbox"/>	<input type="text" value="20"/>	<input type="text" value="0"/>	Yes
Bookmarks	<input checked="" type="checkbox"/>	<input type="checkbox"/>	<input type="text" value="0"/>	<input type="text" value="0"/>	Yes
Current To Do	<input checked="" type="checkbox"/>	<input type="checkbox"/>	<input type="text" value="0"/>	<input type="text" value="0"/>	Yes
Favorite Links	<input checked="" type="checkbox"/>	<input type="checkbox"/>	<input type="text" value="0"/>	<input type="text" value="0"/>	Yes
Favorite Scripts	<input type="checkbox"/>	<input type="checkbox"/>	<input type="text" value="0"/>	<input type="text" value="0"/>	Yes
Favorite Searches	<input checked="" type="checkbox"/>	<input type="checkbox"/>	<input type="text" value="0"/>	<input type="text" value="0"/>	Yes
To Do Summary	<input checked="" type="checkbox"/>	<input type="checkbox"/>	<input type="text" value="0"/>	<input type="text" value="0"/>	Yes
Work List	<input checked="" type="checkbox"/>	<input type="checkbox"/>	<input type="text" value="0"/>	<input type="text" value="0"/>	Yes

Notice, after the grid is expanded, the grid's vertical scroll bar disappears and the button in the upper corner becomes a Collapse Button, . If you click the collapse button, the grid will return to its original height.

NOTE: Search grids. Expand all functionality is not available in search grids.

Sorting Functionality

Grids have a heading row that contains labels for the columns. By clicking a column heading, you cause the rows to be sorted in the order of the selected column. By clicking on a column more than once, you cause the rows to be sorted in reverse order. Clicking the heading a third time removes the sorting function and returns the grid to its default display organization.

The following shows how information look after organizing the grid, clicking the column heading, by algorithm type (notice the icon in the column name).

ALGORITHM CODE	DESCRIPTION	ALGORITHM TYPE 
F1-OVRTD-ALG	Validates date in format YYYY-MM-DD	ADHV-DTD
F1_PROSTINFO	Process Flow Information	F1_PROSTINFO
F1_VALDELPST	Process Flow Delete Validation	F1_VALDELPST
F1-ACTIVEWS	Web Service - Verify Active Operations	F1-ACTIVEWS
F1-ATCHM-INF	Attachment Information	F1-ATCHM-INF
F1-ATSZCLVL	Attachment Size Class Validation	F1-ATSZCLVL
F1-BAT-LSDEF	Timed Batch - Service Level Based on 1.5 Timer Interval Factor	F1-BAT-LVSVC
F1-BFEMOLOG	Add Business Flag Error MO Log	F1-BFEMOLOG
F1-BFSTDNMVA	Business Flag Standard Name Validation	F1-BFSTDNMVA

NOTE: Sorting on dropdown values. If you attempt to sort a column that contains a dropdown value, the information is sorted in the order of the unique identifier associated with the dropdown value, not the description you see on the screen; for example, if you sort on a column containing unit of measure, the information will be sorted in the order of the unit of measure code, not the description that appears in the drop down. This means that the resultant sort will appear incorrect and therefore we discourage you from doing this.

Get More Functionality

Grids in fixed pages that can potentially contain a large number of rows have special processing that we refer to as Get More functionality. Below is an example using the Message maintenance page. A large number of messages are associated with a given message category. This grid could contain hundreds of rows. Rather than show every message, the system retrieves the first X records (where X varies from grid to grid, and from release to release) and appends a Get More button to the bottom of the grid as illustrated below:

			MESSAGE NUMBER	MESSAGE TEXT	OWNER
			11053	Script Type is required.	Framework
			11054	Unable to generate the list of Group Names.	Framework
			11055	Destination field name is missing for Step Sequence '%1'.	Framework
			11060	Step Collection Overflow	Framework

Get More...

When you click the **Get More** button, the system appends the next X rows to the bottom of the grid.

NOTE: The absence of a "get more" button. For pages configured to include Get More, if no button appears at the bottom of the grid, this means all of the rows are displayed.

NOTE: Search grids. The Get More function is not available in search grids.

Adding and Removing Rows Using Arrows

In some editable grids, a new row can be added to another editable grid (the grid on the left) by clicking the Add item button, , of the desired row in the grid on the right:

	SEQUENCE	DESCRIPTION		SEQUENCE	DESCRIPTION
	10	Winter kWh charge, first 500		30	Winter subtotal
	20	Winter kWh charge, remaining		60	Summer subtotal
	40	Summer kWh charge, first 300			
	50	Summer kWh charge, remaining			

When the Remove item button is clicked, , the row is transferred from the grid on the right to the grid on the left. This change will not be committed to the database until you save the object being maintained

Reorganizing Items Using the Up and Down Arrows

Occasionally, rows can be repositioned in an editable grid by clicking up and down arrows. The following is an example of such a grid:

		MERGE TYPE	SEQUENCE	TYPE	DESCRIPTION
			Original	10	Service Quantity Charges
			Merge	20	Service Quantity Winter kWh charge, remaining
			Merge	40	Service Quantity Summer kWh charge, first 300

Notice the following about such a grid:

- The up arrow is dim in the first row. This is because it can't be moved further to the top.
- The down arrow is dim in the last row. This is because it can't be moved further down.
- The up and down arrows are usable in all other rows. Each time you click one of these arrows, the respective row is moved up or down one row.

NOTE: Reminder. When you move rows into a grid, the system does not apply the change to the database until you click the Save button (which commits the entire object to the database).

Trees

Trees are used to illustrate complex relationships between objects. The following is an example from Oracle Utilities Customer Care and Billing of a page with a tree that is expanded:

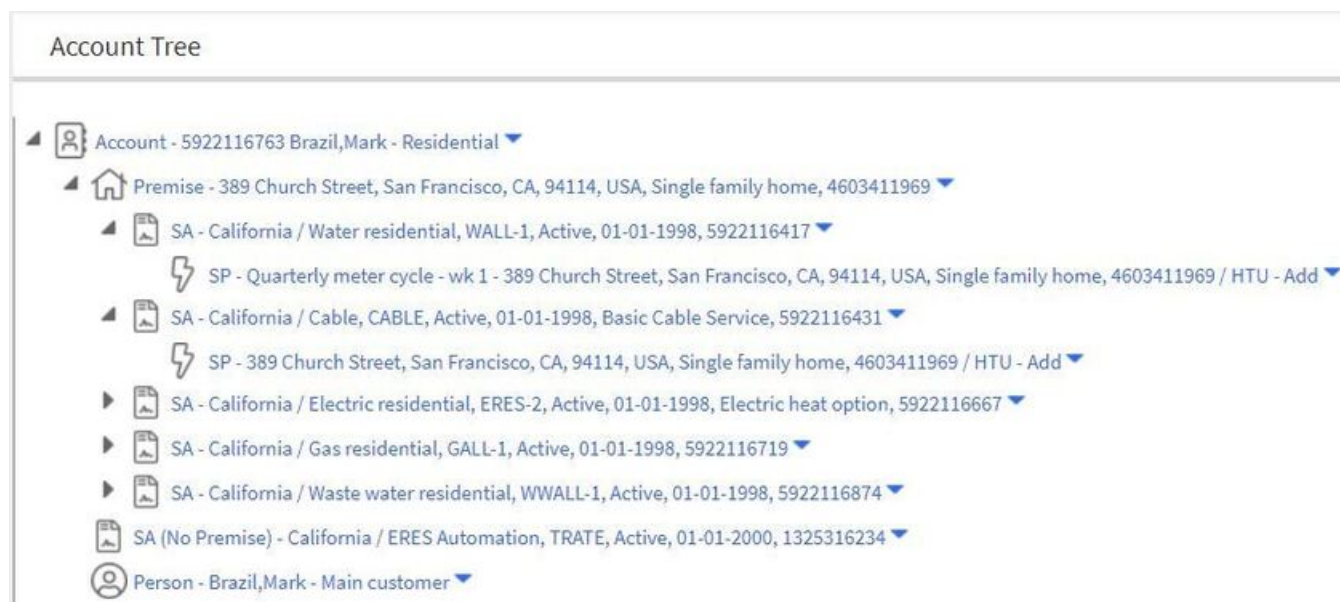

The following points describe how to use trees:

You can expand and contract the nodes in a tree by clicking on the icon that prefixes the node (you can also click the arrows to expand and contract a node).

NOTE: Expand all. If you press `Ctrl` while clicking on an icon that prefixes a node, all child nodes (and their children) expand.

You can click the context menu button to cause a context menu to appear. You can navigate to any of the pages that are presented on this menu. Refer to [Context Menu Button](#) for more information.

You can click on the information that appears in an underlined node to drill into the page in which the object is maintained. For example, if you click on the account information, you will be transferred to the Account - Main page.

NOTE: Important! If you make changes after expanding a tree's nodes (e.g., by drilling down on a Premise and changing the premise's address), the tree will contract to the first node if you return to the page.

Nodes in trees fit into two broad categories:

- **Information nodes.** Information nodes highlight the existence of other data. For example, on the Control Central - Bill Payment Tree, a node exists to highlight the existence of new financial transactions that were created since the last bill was completed.

- **Data nodes.** Data nodes show information about objects in the system. For example, data nodes exist on the Control Central - Bill Payment Tree that show bills and payments.

Required Field Indicator

An asterisk (*) is used to indicate that a field is required. The system determines this based on the field's configuration. When a field becomes required because of an algorithm and not the field's configuration, however, the system will not add an asterisk.

NOTE:

If a page includes a grid, fields within a row may be marked as required.

Operations ⓘ

		OPERATION NAME	SCHEMA TYPE	SCHEMA NAME
+	🗑️	*	*	*

In this situation, the field(s) within the grid are **only** required if the row is being populated.

Accordion Windows

Accordion windows are used when the data held in an object's rows does not comfortably fit into a grid.

Each row in an accordion has a header that summarizes a row's details. When you click a header, the row expands to show the details. The following is an example of an accordion where all headers are collapsed (meaning that only summaries of the rows' details are shown):

<input type="checkbox"/> STEPS	ALL 3 DISPLAYED	[EXPAND ALL] [COLLAPSE ALL]	Copy	▼
<input type="checkbox"/> + 🗑️ (10)	Edit data - Get the Physical BO for the MO			
<input type="checkbox"/> + 🗑️ (20)	Edit data - Get the prime keys of the BO			
<input type="checkbox"/> + 🗑️ (30)	Edit data - Read the BO			

When you expand a header, its details are exposed. For example, the following shows the same accordion after the third row is expanded:

<input type="checkbox"/> STEPS	ALL 3 DISPLAYED	[EXPAND ALL] [COLLAPSE ALL]	Copy	▼
<input type="checkbox"/> + 🗑️ (10)	Edit data - Get the Physical BO for the MO			
STEP SEQUENCE *	10			
STEP TYPE *	Edit data			
TEXT	Get the Physical BO for the MO			
EDIT DATA TEXT	<pre>move "parm/mo" to "F1-RetrieveMOOption/input/mo"; move 'F1PB' to "F1-RetrieveMOOption/input/moOptionType"; move 'false' to "F1-RetrieveMOOption/input/isMultiple"; invokeBS 'F1-RetrieveMOOption' using "F1-RetrieveMOOption";</pre>			
<input type="checkbox"/> + 🗑️ (20)	Edit data - Get the prime keys of the BO			
<input type="checkbox"/> + 🗑️ (30)	Edit data - Read the BO			

NOTE: You must expand to update. In order to update a row in an accordion, you must expand it.

Row Summary and Chunk Management

At the top of an accordion you'll find a summary of its rows. The format of this information differs depending on the number of rows and the size of the accordion:

- If the accordion contains every row, a summary of the total number of rows is displayed.
- If the accordion contains a subset of rows, you are presented with a summary of the rows AND you are provided with options to display different "chunks" of rows.
 - Click **First** to display the first "chunk" of rows (the size of a chunk differs depending on the accordion). This option is dimmed if the first chunk is in the accordion.
 - Click **Previous** to display the previous chunk of rows. This option is dimmed if the first chunk is in the accordion.
 - Click **Next** to display the next chunk of rows. This option is dimmed if the last chunk is in the accordion.
 - Click **Last** to display the last chunk of rows. This option is dimmed if the last chunk is in the accordion.

Dashboard Area

The dashboard is a [portal](#) that contains zones. These zones appear regardless of the object being displayed in the [Object Display Area](#). Refer to [Dashboard Portal](#) for a description of these zones.

NOTE: User configurable. Every user has control over the zones that appear in their dashboard. Refer to [Portal Preferences](#) for more information about how a user can customize the contents of the dashboard.

Script Area

When a [script is initiated](#), the [object display area](#) shifts down to make room for the script area.

The information in the script area takes you through the steps in the selected business process (provided by your implementation team).

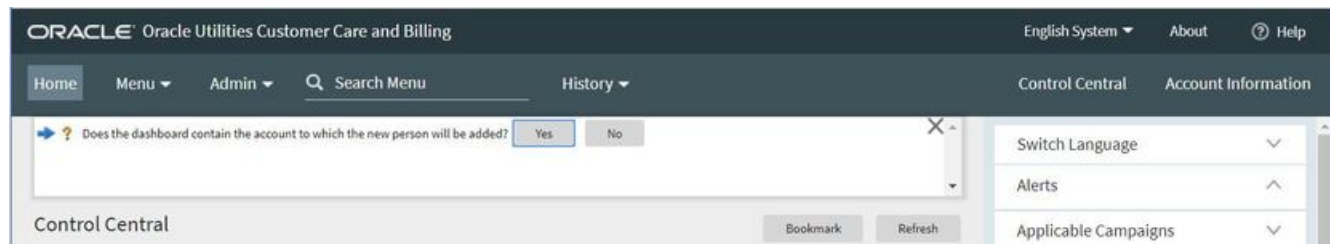

Portal Pages

This section describes using portals and zones to find and display information. This is the preferred technique used by the base product for building user interfaces.

Additionally, portals and zones may be configured by your implementation to supplement the base package provided functionality.

The contents of this section provide background information about portal page behavior.

Portals Are Made Up Of Zones

The term "zone" is used to describe a section on a portal. For example, the following is a portal with seven zones:

- Switch Language
- Bookmarks
- Checked Out
- Current Context
- Current To Do
- Favorite Links
- Favorite Scripts

NOTE: This example may not be available in your application; it is used for illustration purposes only.

The screenshot displays a vertical sidebar menu with the following sections:

- Current Context**: Includes a home icon, user profile (Brazil, Mark), phone number (5922116763), address (11 North-East, Morristown, CA, 07960, USA), and a single family home ID (3364881208).
- Current To Do**: Contains a button labeled "Assign me a To Do".
- Customer Contact**: Features a "LAST" field (27 days ago - System, English), a "TYPE" dropdown menu, a "COMMENT" text area, and an "Add Contact" button.
- Eligible Scripts**: A section with a downward arrow icon.
- Favorite Links**: A section with an upward arrow icon, containing links for "User Group +" and "To Do Role +".

Users Must Be Granted Security Access To Each Zone

A user must be security granted access rights in order to see a zone on a portal.





FASTPATH: Refer to [Granting Access to Zones](#) for information .

Zones May Appear Collapsed When A Page Opens

Zones may be designed to appear collapsed (or minimized) when the portal is initially displayed. To view the information in a collapsed zone, the user can press the zone's expansion button,  , to either expand or collapse the zone:

Favorite Links 

Favorite Links 

User Group +	 1
To Do Role +	 2
QA Query Portal	 3
Workflow Process Template +	 4

A zone's data is only retrieved when it is expanded.

Some Portals Allow User Customization

There are some portals in each base product that are configured to allow user customization. In this case, the portal is visible on the user's portal preferences. For these portals each user has control over the following:

- Which zones appear on their portal
- The order in which the zones appear
- Whether the zones should be "collapsed" (i.e., minimized) when the portal opens.

Users define their preferences by clicking the [User Preferences](#) button. Pressing this button transfers the user to the [User Preferences](#) page on which their [Portal Preferences](#) can be defined.

Portals used for base product query and maintenance pages are typically configured to not allow user customization.

Dashboard Portal

The dashboard is a special portal that always appears on the desktop. Its zones contain tools and data that are useful regardless of the object being displayed.

NOTE:

Minimize the dashboard. You can minimize the dashboard by clicking on the vertical bar on the left side of the dashboard. This causes the dashboard portal to disappear allowing more of the page area to display. The vertical dashboard bar is then displayed on the right side of the page. Clicking the dashboard bar restores the display of the dashboard portal. It also suppresses the refresh of the zones within the dashboard based on updates to the context. Maximizing the dashboard then refreshes the zones with the latest appropriate content.

Minimize the dashboard when launching the system. If desired, a URL parameter may be used to minimize the dashboard when launching the system, using the parameter `minDashboard=true`. Refer to [Creating Application Links in External Applications](#) for more information and examples.

Keyboard Shortcut

Alt+J

The contents of this section describe the zones that are provided by the framework product for this portal. Please note the following additional information about the dashboard portal that may impact how it appears.

- **Additional zones may be available in other products.** The zones described below are available in every base product. Please refer to the product-specific documentation for additional dashboard zones available in your product (open the help and navigate to the index entry labeled **Dashboard**).
- **Context Sensitive Zones may appear.** Some pages may define additional zones that should appear in the dashboard only if that page is displayed. These are referred to as Context Sensitive Zones.
- **Dashboard zones are configurable.** The dashboard portal is configured to allow a user to define preferences for it. Refer to [Portal Preferences](#) for more information.

NOTE: Security. As a general rule, dashboard zones each refer to a unique application service so that a security administrator may configure which users are allowed to have access to which zones. Note that the user portal preferences indicates which zones a user has security access to.

Bookmarks Zone

After clicking the [Bookmark](#) button and saving a bookmark, it is visible in the **Bookmarks** zone. Clicking one of the links in the zone navigates to the page where the bookmark was saved and loads the information related to the record that was displayed when the bookmark was saved.

Click the trash can icon to delete the bookmark.

Note that a user may change the name of the bookmark or change the sequence of the bookmarks by navigating to the [User - Bookmarks](#) in the user preferences.

Current To Do Zone

The **Current To Do** zone is designed to streamline the process of working on To Do entries from assignment to completion. It displays key information about the user's current To Do entry and provides functions that help minimize the number of steps it takes to resolve the entry and potentially other entries related to it.

The following sections provide more detail about the zone.

Next To Do Assignment

Users may have the option to click the **Assign me a To Do** button to request the next To Do entry they should work on. This functionality is optional and can be configured to follow your organization's business rules in determining the next task for a user. For example, if your organization practices work distribution "on demand", this feature can be configured to find the highest priority entry a user can work on and assign it to the user. Refer to [work distribution](#) for more information on this business practice.

NOTE: Next To Do Assignment Rules Are In A Plug-in. Refer to [Installation Options](#) for more information on how to configure the system to take advantage of this function.



If the system is successful in determining the next entry the user should work on, this entry becomes the user's current To Do and its information is displayed on the zone.

User's Current To Do

The user's current To Do may be set using the Next Assignment algorithm, or by drilling in on a To Do from the To Do List or To Do Search page as described in [A User's Current To Do](#). Once a current To Do has been set, the zone displays details related to the To Do.

The **Message** describes why the entry exists. The message description allows the user to drill into the page on which the entry's respective object is displayed. For example, if the entry is associated with an asset that needs review, the user is brought to the asset page to view the information and potentially take action. If the [To Do type](#) has been configured to

associate a [script](#) with this To Do entry's message number, then instead of being taken to the respective page, the associated script is launched.

Info displays the standard To Do information. An icon  appears if there are comments on the To Do and a Log Entry icon  appears if there is a log entry of type **Forwarded**, **Sent Back** or **User Details** on the To Do. The description drills into the [To Do entry](#) page allowing the user to view more information about the entry or make changes to it as needed. The user may use the **Complete** button in the zone to complete the current entry.

Next / Previous Buttons

The **Previous** and **Next** buttons are enabled on this zone under the following conditions:

- The user selected an entry either on the [To Do List](#) page or the [To Do Search](#) page.
- At least one other entry exists *below* (for Next) or *above* the entry selected (for Previous).

Clicking **Next** or **Previous** will bring the user to the transaction indicated on the To Do Entry's message, where its respective object is displayed. It also makes that To Do the Current To Do displayed in the zone.

Keyboard Shortcut	Comments	Alternate Shortcut
Alt+Y	Previous To Do	
Alt+Z	Next To Do	Alt+Shift+Z

NOTE: Refer to [Shortcut Key Summary](#) for information about the alternate shortcut.

NOTE: When a user drills down on a To Do entry from the To Do List page, the system automatically changes the status of the entry to **Being Worked**. If **Next To Do** or **Previous To Do** is subsequently used to scroll through this list, the system does *not* change the To Do entry's status. To change the status of these entries, the user must navigate to the [To Do List](#). On this page, multiple entries may be selected and their status changed with a single user-interface action.

Related To Do Entries

If the To Do entry has non-complete [related entries](#) a summary **Related To Do** description appears. The description states the total number of related entries, how many are still in **Open**, how many are assigned to current user and how many assigned to others. This hyperlink navigates to the [To Do Search](#) query allowing the user to review the related entries. At this point the user may decide to assign entries that can be positively identified as being caused by the same problem as the current To Do also to himself.

If at least one related To Do entry is **Open** or also assigned to the current user, the **Complete All** button is visible. If the user determines that the related To Do entries have been resolved with the appropriate action taken, the button may be used to complete in one step the current entry and all related entries that are **Open** or assigned to the current user.

If the related entries are not resolved with one action, the user may opt to use the **Complete** button to complete the current entry alone and work on related entries one at a time. Using the related To Do information hyperlink the user may navigate to the To Do search page and drill into the first related To Do to work on using the message hyperlink. This entry now becomes the user's current To Do and the **Next** and **Previous** action buttons are set to scroll through the related entries list.

Favorite Links Zone

Each line in the **Favorite Links Zone** corresponds with one of the user's favorite links (e.g., transactions). Clicking on a line invokes the transaction. The first nine entries can be invoked by pressing an accelerator key (Ctrl + the number of the relative position of the link in the list). Note that the numeric keypad on your keyboard cannot be used to implement this function.

Users define their favorite links by clicking the [User Preferences](#) button. Clicking this button transfers the user to the [User Preferences](#) page on which their [Favorite Links](#) can be defined.

Favorite Scripts Zone

The Favorite Scripts zone lists the business process assistant (BPA) scripts that you have defined on your [user preferences](#). You can click on a script to [execute](#) it. You can click the **Search** button in the zone to search for other scripts.

NOTE: If you do not see the Favorite Scripts zone in your dashboard, navigate to User Menu and click the **Preferences** menu item to display the [User - Portal Preferences](#) page. Under the Dashboard Portal row, select the **Display** option for the Favorite Scripts zone.

Favorite Searches Zone

If you marked a saved search as a favorite using [Saved Searches](#) functionality, the search is visible in the **Favorite Searches** zone. Clicking one of the links in the zone navigates to the page where the search was saved and populates the filter values and executes the search.

Switch Language Zone

The **Switch Language** zone is used to switch the application's language. Only languages that are supported by your implementation will appear.

To switch the application's language, choose the desired language and press the **Refresh** button.

NOTE: If your implementation uses a single language, you should suppress this zone by [not granting security rights](#) to the zone's application service.

To Do Summary Zone

The **To Do Summary Zone** has several purposes:

- It presents a summary of the [To Do entries](#) that have been assigned to you and are **Being Worked On**.
- The colored "age bars" highlight the age of the To Do entries. The colors red, yellow and green are used to highlight the relative number of old, middle-aged and new To Do entries. The age associated with each of these colors is [user-configurable](#). Note, you can hover the cursor over an "age bar" to see the number of To Do entries.
- If you click on the To Do Type description or on an "age bar", you'll be transferred to the [To Do List](#) transaction where these To Do entries will be displayed. From this page, you can drill down to the specific entries.

NOTE: Time saver! After you drill down on entry from the [To Do List](#) page, if you have the [Current To Do](#) zone configured in the dashboard, you can use the **Previous To Do** and **Next To Do** buttons in the zone to scroll through additional To Do list entries without returning to the **To Do List** page.

Work List Zone

The **Work List** zone provides quick access to an entire column of an info or query zone. When a user clicks on a work list entry, the system will do whatever it would have done if they'd clicked on the hyperlink in the zone. In addition, the system ticks off that they've worked on the entry (this feature is mostly so users know that they've at least looked at something). Refer to [Work Lists](#) to better understand how to configure query columns to support work lists.

Zone Types and Characteristics

The topics in this section describe common zone types, function, and common characteristics.

FASTPATH: Refer to [The Big Picture of Portals and Zones](#) for a description of general portal and zone functionality.

Common Characteristics of Zones

The following topics describe common characteristics of all zone types supported by the base package.

Zone Visibility

A zone may be configured to dynamically be visible or completely hidden depending on the information being displayed. When hidden, not even the header is displayed.

For configuration information, refer to [Zone Visibility Service Script](#).

Control Zone Headers

A zone may reference a UI Map to define and control its header. This feature provides the means to achieve a uniform look and feel for the application as well as add functionality to the zone header beyond being just a title bar to open and close the zone. Refer to [UI Map](#) and to its context sensitive tips zone for more information on **Fragment** UI Maps and how they are used to construct zone headers.

Explorer Zones

The product provide several zone types that are used to find or display a set of information. These are called explorer zones. There are two types of explorer zones:

- **Info zones.** An info zone displays a list of information about an object. These types of zones often display information without requiring any input from the user.
- **Query zones.** A query zone allows users to find objects matching a given search criteria.

Virtually every aspect of an info or query zone is controlled by its zone [configuration](#). However, most share basic common components described in the subsequent sections.

Search Criteria / Filter Area

For query zones, the Search Criteria Area (also called Filter Area) contains the criteria used to find objects. The design of the zone controls the number and type of filters that appear in this area. After search criteria is entered, clicking the **Search** button causes the system to look for records that match the criteria. The results are shown in the Results Area.

If more than two results are displayed, the system automatically collapses the filter area to allow more space for displaying the results. At that time the **Expand Filters** button may be used to open the filter area to enter different criteria. When the filter area is expanded the **Hide Filters** button may be used to collapse the filter area again without performing a new search.

For info zones, the zone's configuration indicates whether or not a Filter area is applicable and if so, whether or not it is open or closed by default. If the filter area is configured, the [Show Filter](#) icon is visible in the zone header. Click this icon to expose the Filter Area, if it is not visible and click the icon to hide the Filter Area if desired. Use this area to filter the

information that appears in the zone by different values. Click the **Search** button to rebuild the Results Area using the specified filters.

For example, the following shows an info zone listing user groups that do not have access to a given Application Service where a filter area has been configured to allow users to show user groups specific to a given user by ID or name.

The screenshot shows a window titled "User Groups not Linked" with a help icon. Below the title, it displays "Filters: Application Service CILQTDQP , User ID CCBDEV1". A table lists user groups with columns for "USER GROUP", "DESCRIPTION", and "GRANT ACCESS". The first row shows "*PORTAL*" with description "Portal System Default" and a "Grant Access" button. Below the table is a search section titled "USE TO SHOW USER GROUPS WITH SPECIFIC USER" with input fields for "USER ID" (containing "CCBDEV1"), "FIRST NAME", and "LAST NAME", and a "Search" button.

The info zone includes configuration to indicate whether the filter area, when exposed, should be shown at the top of the zone (above the results) or at the bottom of the zone (below the results). For query zones, the search criteria is always displayed at the top.

NOTE: Press Enter. Rather than clicking the **Search** button, you can press **Enter** to trigger the search / info zone refresh.

Description Bar

The Description Bar describes the search criteria that were used to build the Search Results Area.

Results Area

The Results Area displays the appropriate list of objects. For an info zone, this is the list of appropriate objects with any input filter criteria considered. The following is an example of the results for an info zone. For a query zone, this is the list that matches the search criteria defined in the Filter Area. The following is an example of the results set of an Info Zone.

The screenshot shows a window titled "Business Objects with Status Reason" with a help icon. It contains a table with columns: "BUSINESS OBJECT", "DESCRIPTION", and "STATUSES".

	BUSINESS OBJECT	DESCRIPTION	STATUSES
1	F1-BusinessFlagError	Business Flag Error	Discarded
2	F1-CubeView	Cube View	Active, Inactive
3	F1-GenericBISyncRequest	Generic BI Sync Request	Discarded, Cancel
4	F1-MessageFromDevice	Message From Device	Canceled
5	F1-MessageToDevice	Message To Device	Queued, Canceled, Processed
6	F1-MigrDataSetExport	Migration Data Set Export	Canceled
7	F1-MigrDataSetImport	Migration Data Set Import	Canceled, Completed

For a query zone, the columns that appear may differ depending on the search criteria. For example, if you search for a customer by their driver's license number, the resulting columns may be different than the ones displayed when you search by customer name.

The following points highlight details related to viewing and working with the result set:

- **Broadcast.** If the results set is configured to display a broadcast icon, , it means that at least one other zone on the portal is configured to display data related to the record selected in the results list. Clicking this icon will cause the other zone or zones to be built or refreshed to display related data.
- **Hypertext.** One or more columns in the zone may be configured as hypertext. Clicking the hypertext will result in navigating to another page to display data related to that column based on the configuration for that column.
- **Maximum height.** The maximum height of the report area is controlled by the zone's configuration. A vertical scroll will appear when more rows exist than fit into the height.
- **Maximum rows.** The maximum number of rows that can appear is controlled by the zone's configuration. Excess rows are truncated before display. Please note, you can configure the zone to [download more rows to Excel](#) than appear in the Results Area.
- **Control column sorting.** By default zones are designed to allow a user to sort the results list by clicking any column heading. Clicking once sorts ascending. Clicking again sorts descending. However, a zone may be configured to not allow this type of sorting.
- **Rearranging columns.** A zone may be configured to allow a user to rearrange columns and add or remove columns visible in the Result Area. Refer to [Column Configuration](#) for the details.

The type and variety of columns that appear in the Results Area is controlled by the zone's configuration.

Title Bar

The Title Bar contains the zone's description along with other icons and functions described in this section.

In the corner of the Title Bar, you'll see an indicator that tells you whether the zone is collapsed (e.g., minimized) or expanded. Each time you click the indicator, the zone toggles between expanded and collapsed. The following image shows a collapsed zone.



NOTE: Recommendation: For zones that are configured to show on portal preferences, set up [Portal Preferences](#) to collapse zones that aren't needed every time a portal is displayed. Rationale: The system doesn't build collapsed zones when a portal is displayed. Instead, collapsed zones are only built when a user expands them. Thus, indicating a zone is collapsed improves response times.

If the zone is configured with help text, a help icon appears to the right of the zone title. Click this icon to view the help text.

If a [saved search](#) is open for a zone, the name of the saved search is displayed after the zone title.

The following sections describe additional icons and tools visible on the title bar. Note that in addition to the information described in this section, additional actions that are specific to a zone may appear based on configuration. The actions may appear in the form of hypertext, an icon or a button.

Explorer Zone Menu

Click the Explorer Zone Menu icon  to list available tools. The following topics describe each tool.

Clear Filters

Click the **Clear Filters** link in the Explorer Zone menu to clear the filter values and zone data.

Export to Excel

Click the **Export to Excel** link in the Explorer Zone menu to download the zone's data to Excel. This link is hidden if the zone has been configured to not download rows to Excel.

Print

Click the **Print Zone** link in the Explorer Zone menu to print the zone.

Save Search Options

Query zones and info zones that include filter areas, allow a user to capture and save filter criteria so that the same search can be more quickly executed in the future. Users may save many different search options for the same zone. Users also have the option to nominate one search as the default so that this search is automatically loaded upon entering the zone. In addition, users may choose to set one or more searches as a Favorite, which causes the search to appear in the [Favorite Searches](#) zone in the dashboard. This allows a user to navigate to the portal for that zone and load the saved search in one click.

The Explorer Menu includes various options for supporting Saved Searches that are described below.

Note the following additional points about this functionality:

- **Click Search before Saving.** When a user wants to save a search, the search criteria should be entered and the **Search** button should be clicked prior to saving the search.
- **Criteria is saved, not results.** Although a user must click **Search** prior to saving the search, the system saves the criteria, but not the results. When returning to the query or info zone in the future and opening a given saved search, the results displayed will be the current records in the system that match the saved search criteria.
- **Multi-Query Zones.** When a user is on a multi-query zone, the searches are saved at the multi-query zone level so that all saved searches for the various search dropdowns for a given multi-query zone are visible in the Open Saved Searches menu option.
- **Functionality is Secured.** If for any reason an implementation wishes to restrict which users are allowed to save searches, the functionality is securable. Only users with **Inquire** access to the **F1_USRFAVSCH** application service will see these options in the explorer menu. This is the same application service that is used to provide access to the Favorite Searches dashboard zone.

Save As

The **Save As...** option in the Explorer Zone menu allows a user to save the current entered search criteria. This should be clicked after executing the search.

The user is prompted to provide a name for the search. This search is now available from the Open Saved Searches option. If desired, a user can also choose to make this search the Default or may choose to Add to Favorites.

This option is visible whether or not an existing saved search is loaded. When a saved search is loaded, this option allows a user to make changes to the search criteria and save a new search with that criteria.

Open Saved Search

The **Open Saved Search...** option in the Explorer Zone menu is visible if there are any saved searches for the zone that is currently visible. Select this menu entry to view the current list of saved searches for the zone. For multi-query zones, any saved search for any of the query zones that are part of the multi-query zone are visible. Choose the desired saved search. The criteria is updated with this information and the search is performed.

Save

The **Save** option in the Explorer Zone menu is visible if a Saved Search is already loaded. This option allows a user to save changes to the criteria of an existing saved search (overwriting the previously saved criteria).

Set As Default

The **Set As Default** option in the Explorer Zone menu is only visible if a saved search is loaded and it is not currently the default. Click this option to nominate this search to be the one that is loaded when navigating to this zone from the menu.

Remove As Default

The **Remove As Default** option in the Explorer Zone menu is only visible if a saved search is loaded and it is currently the default. Click this option to no longer load this search automatically when navigating to this zone from the menu.

Add To Favorites

The **Add To Favorites** option in the Explorer Zone menu is only visible if a saved search is loaded and it is not currently included in the favorite searches zone. Click this option to include this search in the [Favorite Searches](#) zone. Once a search is in the Favorite Searches zone, you can use the link to the search in the dashboard to navigate to the portal for this zone and load the saved search in one click.

NOTE: Not available for dependent zones There are some portals that include a zone that is not the main query or info zone on the portal, but is rather a zone providing additional information for a record that is displayed. If a zone like this has filter options or configurable columns, a user is able to save searches and mark one as a default, but will not be able to add the saved search to favorites because the zone is dependent on other data on the page that is not captured for the individual zone.

NOTE: Dashboard Zone Preferences. Be sure that your [portal preferences](#) are configured to include the Favorite Searches dashboard zone.

Remove From Favorites

The **Remove From Favorites** option in the Explorer Zone menu is only visible if a saved search is loaded and it is currently included in the [Favorite Searches](#) zone. Click this option when you want to keep the saved search but you no longer want it visible in your Favorite Searches zone. (Deleting a saved search that is also marked as a favorite will automatically remove the search from the favorite searches zone.)

Delete

The **Delete** option in the Explorer Zone menu is only visible if a saved search is loaded. Click this option to remove the currently opened saved search from the list of saved searches.

Note that if the saved search had been configured as favorite, deleting the saved search remove it from the favorite searches zone.

Show Filters

Click the **Show Filters** icon  to show the [Filter Area](#). This button only appears if the zone has been configured to have filters.

NOTE: If the zone is configured to have filters and the drag and drop (column configuration) area, only one or the other is shown at any given time. It means that a user can either change the filter criteria and refresh the search results or change the column configuration and refresh the results.

Show Column Configuration Area

Click the **Column Configuration** icon  to show the [Column Configuration Area](#). This button only appears if the zone has been configured to allow columns to be dragged and dropped into the Results Area.

NOTE: If the zone is configured to have filters and the drag and drop (column configuration) area, only one or the other is shown at any given time. It means that a user can either change the filter criteria and refresh the search results or change the column configuration and refresh the results.

The Open Zone Maintenance Icon

Click the **Go To Zone** icon  to switch to the zone's [zone maintenance](#) page. On this page, you can change the parameters that control the zone's behavior.

NOTE: Debug mode only. This icon only appears when the system operates in [Debug](#) mode.

Configurable Columns

Info zones and query zones may be configured to allow users to rearrange columns and to remove or add columns to the output. This is also referred to as "drag and drop" of columns.

When a zones is configured to support this functionality, the [Show Column Configuration Area](#) icon is visible in the zone title area. Click this icon to expose the Column Configuration Area, if it is not visible and click the icon to hide the Column Configuration Area if desired.

If configurable columns are allowed, a user may rearrange the order of columns currently displayed in the Results Area by clicking the column heading and "dragging" it to the desired location.

In addition, the column configuration area may display columns that are not currently in the Results Area. These are indicated by a cream background. A user can drag one of these columns to the results area and then click **Refresh** to rebuild the zone. To remove a column that is currently in the results area, click the trash can icon next to the column name in the column configuration area and then click **Refresh** to rebuild the zone.

The following is an example of how the Column Configuration Area looks:

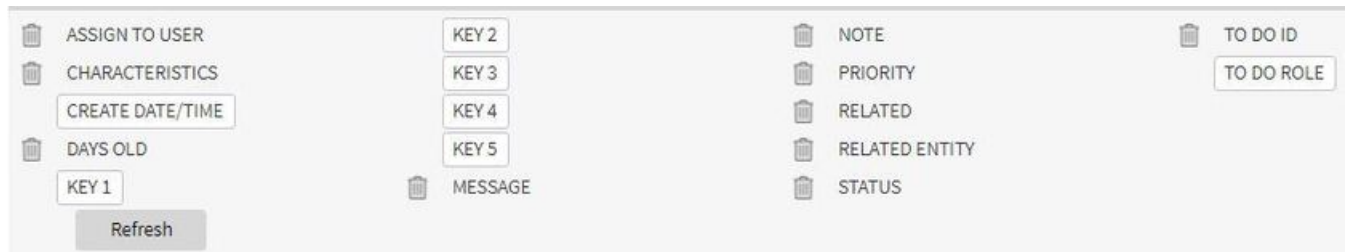

Multi-Query Zones

This type of zone combines individual Query Zones into a single query zone. A **Search By** dropdown, built from the zone descriptions of the individual Query Zones, allows you to select the desired query to execute. Selecting a specific Query Zone display the filters of that query in the filter area. At this point the zone simply executes the selected Query Zone, as if it was executed on a standalone zone. By default, the first query zone option is selected.

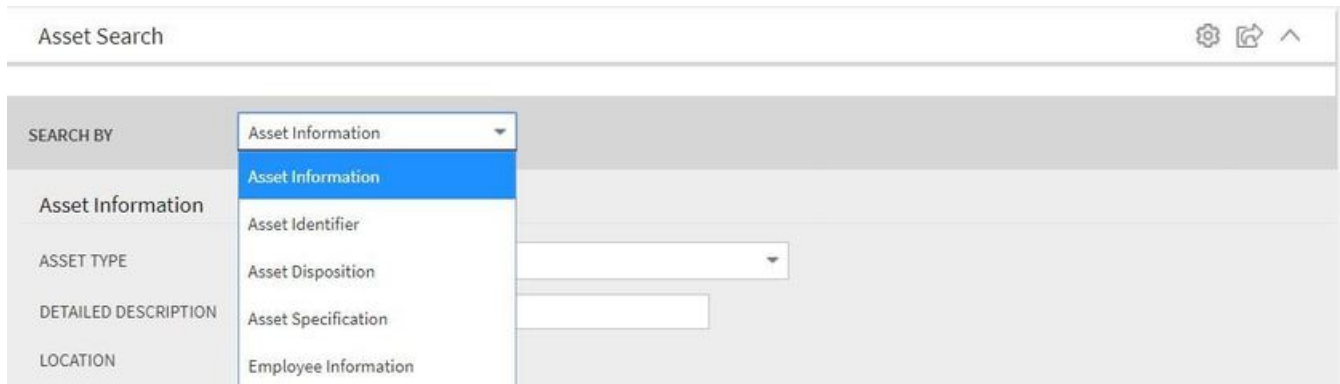

Map Zones

A map zone displays information related to one or more objects. For objects that are maintained using portal-based pages, the standard display of the object is using a map zone. Map zones may be configured to display an explicit map or may dynamically display the map based on the configuration of the record being displayed.

Because the information displayed in a map zone is configured using HTML, virtually any format supported by HTML is possible. The following is an example of a typical map zone used to display information about an object.

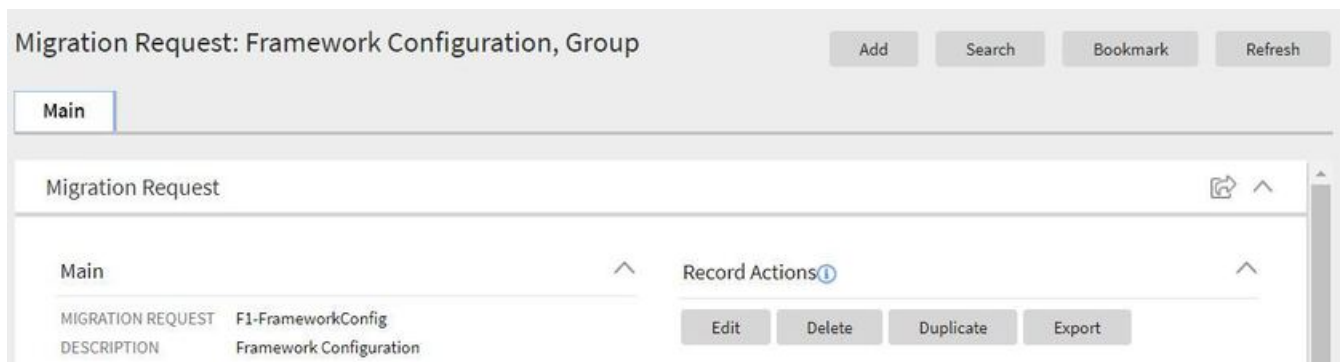

A [tool tip](#) can be used to display additional help information for the details shown in a map zone. The tool tip may appear adjacent to the section header or adjacent to individual elements on a map.

NOTE: You can customize the help icon or disable map help using the [Custom Look and Feel](#) feature configuration.

Open Map Maintenance Icon

Click the **Go To Map** icon  to switch to the [UI map](#) maintenance page. On this page, you can view the HTML configuration for the zone. Note that for map zones that display a business object configured without a map, the elements displayed are automatically rendered. In this case, no "hammer" icon is visible.

NOTE: Debug mode only. This icon only appears when the system operates in [Debug](#) mode.

Timeline Zone

A timeline zone is used to show events over time for multiple types of data. This type of zone is helpful for providing a consolidated view of separate events occurring in time that may in fact impact each other. For example, in the billing system, a timeline can show bills, payments and collection processes for the same time period.

The topics in this section describe the functionality available in timeline zones.

Timelines Zones Are Configured By Your Implementation Team

The product provides support for creating timeline zones. However, whether timeline zones are configured for your implementation and on which portals they may be visible will depend on your specific configuration. Refer to [Configuring Timeline Zones](#) for general information about configuring timeline zones. Refer to your specific edge application's documentation for details about what type of timeline information is provided out of the box.

You Can Move Through Time

You can click the controls at the top of a timeline zone to change the date-range of the zone's information. To reposition the timeline to a specific date, selected the desired month and year at the top of the zone and click the search arrow.

Controls at the top right of the zone allow you to navigate through time.

- To go back one year, click the double-left arrow.
- To go back one month, click the single-left arrow.
- To go to today, click the middle dot.
- To go forward one month, click the single-right arrow.
- To go forward one year, click the double-right arrow.

Timelines Can Have Many Lines

Depending on how a timeline zone is configured, it will typically have one or more "lines" that show when significant events have occurred. Each line represents a specific type of data. The data may be related to a specific maintenance object, for example, payments may be displayed in one line and bills in another. It may also be possible to create multiple lines for different types of records for the same maintenance object. For example, if your product provides an algorithm to display cases, it may support defining a different entry for each case type.

Each Line Shows Events

Each line on a timeline may contain zero or more events where each event shows the date when the event occurs. For example, the payment line in a timeline has a separate event for every payment received from the customer. Each line's description contains the number of events on the line.

CAUTION:

If a line has more events than can fit onto a timeline, the line will show the first "chunk" of events and a message will appear in the "more info area" explaining that some events have been truncated. If this happens and the truncated events are in a later period, you can reposition the timeline's base period to show the truncated events.

Hovering Over An Event Shows the Event Information

When you hover over an event's date icon, a pop-up widow appears showing details of the event. The following information may appear:

- The event date.
- The event "hover text". Typically the standard information string is shown for each event.
- The event's common "information string" appears. This information is hypertext to allow for easy access to the transaction on which the object is maintained.
- Additional information may appear. This is dependent on the particular timeline algorithm. Refer to each timeline algorithm's description to find out if additional information appears in the pop-up area under any conditions.
- If the algorithm has configured BPA scripts that can be executed to perform business processes on the object, the BPA script description appears prefixed with a "wizard's hat" icon.

Common Base Portals and Zones

The following sections describe common standards followed by the product for base query and maintenance dialogue.

All-In-One Portal

The all-in-one portal is used for low volume objects, where a small number of records are expected.

For example, many control tables use this style of portal. In this portal, rather than separate query and maintenance portals, a single portal allows a user to find a record and maintain the record. A zone listing all existing records is displayed when first entering the portal. A user can perform actions on existing records or add new records from there. More details about the list zone are provided below.

Refer to [Maintenance Portal](#) for information about zones commonly found on maintenance portals.

The all-in-one portal will typically provide the ability to add a new record. This may be a button in the Page Action area or a hyperlink defined directly on the list zone's header area.

List Zone

This info zone appears when first entering the portal and displays a row for each record.

The following functions are commonly available in a list zone:

- A broadcast icon is included in each row. Clicking this icon opens other zones that contain more information about the adjacent record.
- An **Edit** icon may be included in each row. Clicking this icon launches the maintenance BPA script to modify the adjacent record.
- A **Duplicate** icon may be included in each row allowing the user to duplicate the adjacent record without having to first display the record.
- A **Delete** icon may be included in each row allowing the user to delete the adjacent record without having to first display the record.
- If the record has a simple BO lifecycle of **Active** and **Inactive**, the list zone may include a button to **Activate** or **Deactivate** the adjacent record.

Separate Query and Maintenance Portals

For high volume objects where more sophisticated search criteria is needed to find a particular record, separate portals are provided to search for the record and to maintain it.

The query portal contains a zone to search of the object that you wish to maintain. Additional information about the query portal's search zone is provided below. Clicking an appropriate record in the search results navigates to the object's stand-alone maintenance portal.

The query portal will typically provide the ability to add a new record. This may be a button in the Page Action area or a hyperlink defined directly on the list zone's header area.

Query Portal Search Zone

The query portal contains one zone used to search for the object.

The zone may be a standard query zone or may be a multi-query zone providing one or more ways to search for your record.

Once the search results are displayed, click on the hypertext for the desired record's information string to navigate to the stand-alone maintenance portal.

Maintenance Portal

A maintenance portal refers to a page that is used to view and maintain a specific record. These types of records are governed by a business object, which defines the user interface layout for both the display of the record and the add or update of the record.

An all-in-one portal is a type of maintenance portal where the maintenance zone is displayed once a record has been broadcast from the list zone. For the separate query and maintenance portal dialogue, the maintenance portal includes only zones relevant for the specific record selected.

Maintenance portals may have multiple tabs to display information relevant for the object. Often, if the object has a Log, the log is on a separate tab. (However, there may be some maintenance portals that include the log zone on the Main tab.)

The stand-alone maintenance portal is typically configured with the ability to navigate back to the query portal using either a **Search** button in the Page Actions area or using a **Go To Search** hyperlink in the main zone's header area. The stand-alone maintenance portal may also include the ability to add a new record using an Add button in the Page Actions area. (If not, a new record can be added by navigating through the menu or by navigating to the query portal where an Add hyperlink may be found.)

The following sections describe zones that are common to portals used to maintain a record. Note that additional zones may exist for specific all-in-one portals or stand-alone maintenance portals based on the particular functionality. Refer to the documentation for each portal to understand the specific zones that are provided.

Object Display Zone

This is a zone that displays the object being maintained.

An object being displayed may or may not allow for actions or updates to be made. Typically there is a Record Actions section in the display area that presents the valid actions. Depending on the functionality, the actions may prompt the users to input values required for that action.

Log Zone

If the maintenance object for the record includes a status, it typically has a log that records important events in its lifecycle.

This log is shown in an info zone on the portal, either on the Main tab or on a separate Log tab. A link appears in the zone's title bar to allow the user to add a new manual log entry.

Process Flow

This portal is used to guide a user through the steps needed to complete a process flow. If the process flow type is configured to keep a record of a completed process flow then this portal may also be used to display the details of such record.

Refer to [Understanding Process Flows](#) for more information.

Each type of process flow is assumed to be configured with designated custom menu options that allows you to launch a new process flow of that type as well as review saved off and completed records. When reviewing existing process flow records, you are brought to a query portal with options for searching for a specific record. You may **Resume** a saved off but not yet finalized process flow or review a complete one.

The **Process Flow** zone on the portal's **Main** tab page assists the user in completing the process flow as well as displays the information captured on a completed process flow.

Fixed Pages

There are some pages in the system that are built using a fixed page metaphor. All user interfaces implemented in this way function in a similar manner. This section describes functionality to these types of pages.

NOTE: Not all pages in the application use this metaphor. The preferred metaphor for pages in the system is to use portal-based pages. For more information see [Common Base Portals and Zones](#).

Maintenance Pages

Maintenance pages are used to maintain (add, change, etc.) the information in the system using a fixed page metaphor. This section focuses on functionality common to all maintenance pages using this metaphor.

The Unique Identifier Area

Every object in the system must have a unique identifier. For some objects, typically administrative or control table data, the unique identifier is defined by the user creating the record. Other objects, typically master or transaction entities, the unique identifier is assigned by the system after the record is saved.

Where the identifier is displayed depends upon whether the ID is user-defined or system generated.

Pages displaying objects with a user defined identifier (such as To Do Type) typically display the identifier on the left along with a search button. For master and transaction tables, (such as To Do Entry) the unique identifier is typically found in the upper right corner of the screen along with a search button and is labeled as the entity's ID. In this case, if there is an information string associated with the object, it is displayed on the left.

If the object being maintained has an associated context menu, a [Context Menu Button](#) is displayed appear.

Confirmation & Error Messages

Whenever a database modification action is requested, the system first validates the data to be put on the database.

First, the system validates the information. If there are errors, the first error encountered is displayed in a window. In addition to the error message, the error window also contains the error number and the identities of the programs that detected the error. If you don't understand an error and you have to call product support, please supply them with this information.

If there are no errors, the system is modified.

Warning If Unsaved Changes Exist

If you make any changes to an object and you don't commit these changes to the database, the following warning appears: "You have unsaved changes that will be lost if you continue. Press OK to continue anyway."

If you want to commit the changes, click **Cancel**. You will then return to the page and can make further changes or press Save. If you want to discard your changes and transfer to the new page, click **OK**.

CAUTION: This warning is not displayed if you are working on a *new* object on a fixed page and you navigate to a different page. Information about new objects is preserved in memory in anticipation of your return to the page. For example, if you are in the middle of adding a new user and you want to quickly reference information on a different page, you will not receive the above warning because your information will be saved. If you use the back button to

return to the user page, all of the information you were adding will be present and you can enter the rest of the new user's data.

Query Pages

Query pages are used to display record sets in the system. Most query pages function in a similar manner. This section focuses on functionality common to all of the system's query pages.

The Search Area

The upper right corner of the screen is almost always the identifier of the object associated with the search. In Oracle Utilities Customer Care and Billing for example, the unique identifier on the Account Financial History page is the Account ID.

To the right of the unique identifier is a [Search button](#). This button is used to search for a different object than the one whose data is being displayed in the page.

If the object being displayed has an associated context menu, a [Context Menu Button](#) is displayed.

User Preferences

The Preferences (or My Preferences) transaction and the User Maintenance transactions are the same except that with My Preferences, only the following items can be modified:

- Main Tab
 - Language
 - Display Profile
 - Time Zone
 - Email Address
 - Dashboard Width
 - Home Page
 - To Do Summary Age Bar Parameters
- Bookmarks
 - All information can be modified
- Portal Preferences
 - All information can be modified
- Favorite Links
 - All information can be modified
- Favorite Scripts
 - All information can be modified

User - Main

This page lets you view or define user information and access settings.

To open the page, use one of the following navigation options:

- The **Admin > Security > User > Search** menu item.
- The **Menu > My Preferences** menu item.
- The **User Menu > Preferences** menu item in the application toolbar.

Note that some fields are only modifiable when the page is opened from the from the **Admin** menu.

Description of Page

Basic user identification information is viewed or set in the **First Name**, **Last Name**, **User ID**, and **Login ID** fields, all of which are modifiable only when the page is opened from the **Admin** menu. User and logon IDs must be unique. The Login ID is the ID that the user uses to log in to the system. The User ID is the ID that is used throughout the application when users are assigned to tasks or when the user ID is stamped on records when logging add or update actions.

Language Code defines the language in which the user's screen prompts and messages appear.

Set **User Enabled** to allow the user to access the system.

NOTE: This field, available only when the page is accessed through the **Admin** menu, provides special field-level security. A user can change the field only if the **Enable/Disable** access mode is set.

Display Profile defines the [display options](#) for the user.

The next group of fields is used to view or set user preferences. For example, you can set up [portal preferences](#) on a "template user" and indicate that specified users will inherit their portal preferences from the template. Doing so provides consistency in the application of account information and dashboard zones. This fields are modifiable only when the page is accessed through the **Admin** menu.

- Set **User Type** to **Template User** if the user's preferences are to match those of other users.
- If a user's [portal preferences](#) are to be inherited from a "template user", use the **Portals Profile User** to define the user ID of the template user. If applied, the specified user will inherit portal preferences from the **Portals Profile User** and will be unable to customize those preferences.
- If a user's [favorite links](#) are to be inherited from a "template user", use the **Favorites Profile User** to define the user ID of the template user. If applied, the specified user will inherit favorites preferences from the **Favorites Profile User** and will be unable to customize those preferences.

The **Time Zone** associated with the user may be defined. Implementations may use this information for features and functions where the user's time zone impacts display of data.

Email ID captures the user's email address.

Dashboard Width defines the number of pixels to use for the user's [dashboard](#) area. A setting of 250 is recommended as a minimum. Depending on the width of a user's monitor, a higher setting (such as 250) will display more information without compromising the space on the main area of the application. Setting the value to 0 will suppress the dashboard.

Home Page defines the page that appears when the user starts a session or clicks the [Home](#) link.

The To Do entry fields control how To Do entries are aged in respect of the "age bars" that appear on [To Do Summary](#), [To Do Supervisor Summary](#) and the [To Do Summary Dashboard Zone](#).

- Use **Lower Age Limit for Yellow Bar** to define the number of days old a To Do entry must be to be considered "yellow" in the age bar. To Do entries below this limit are considered "green" in the age bar.
- Use **Upper Age Limit for Yellow Bar** is the high limit for the "yellow" bar. To Do entries older than this are considered "red" in the age bar.

The **User Group** collection defines the group(s) with which the user is associated and the date (if any) when the user's association expires. This feature is modifiable only when the page is accessed through the **Admin** menu. For more information, see [The Big Picture Of Application Security](#). Assignments of users in a user group can also be established or maintained through the [User Group - Users](#) page.

NOTE: The ability to maintain the user groups on this page requires special field-level security. A user can change the field only if the **System Administration** access mode is set.

If your implementation has configured [Object Erasure](#) for the User maintenance object, the **Object Erasure Schedule** dashboard zone is visible displaying the erasure status for this user record, if applicable. Refer to [Erasing User Information by Obfuscation](#) for more information on object erasure for User records.

User - To Do Roles

Open the User page and then navigate to the **To Do Roles** tab to define the To Do roles assigned to the user.

The information on this page cannot be modified if accessed through **My Preferences**.

FASTPATH: A user's To Do roles control the types of **To Do** entries the user can access. For additional information on To Do roles, see [To Do Entries Reference A Role](#).

Description of Page

The grid contains the user's To Do roles. To modify a To Do role linked to the user, simply move to a field and change its value. To remove a To Do role, click the - (minus) button. To add a new To Do role, click the + (plus) button and enter the role.

Where Used

Every **To Do** entry references a role. A To Do role has one or more users (and a user may belong to many To Do roles). Users who are part of the To Do role assigned to a To Do entry may work on the To Do entry. For more information on this feature, see [The Big Picture Of To Do Lists](#).

User - Access Security

Open the User page and then navigate to the **Access Security** tab to define a user's security rights. You cannot modify this page if you accessed it through **My Preferences**.

FASTPATH: Refer to [The Big Picture of Application Security](#) for more information about data access roles and access groups.

Description of Page

Use the **Default Access Group** to define the access group that is defaulted on new records added by this user that are subject to [row security](#).

The scroll area contains the **Data Access Roles** to which this user belongs. A user's data access roles play a part in determining the accounts whose data they can access.

To add additional data access roles to this user, click the + button and specify the following:

Enter the **Data Access Role**. Keep in mind that when you add a **Data Access Role** to a **User**, you are granting this user access to all of the accounts linked to the data access role's access groups.

Use **Expiration Date** to define when the user's membership in this data access role expires.

NOTE: You can also use [Data Access Role - Main](#) to maintain a data access role's users.

The tree highlights the **Access Groups** to which the above **Data Access Roles** provide access.

User - Bookmarks

This page is used to manage a user's bookmarks that are created when a user clicks the [Bookmark](#) button and saves a bookmark. From this page the user can delete a bookmark, change the name of the bookmark or change the sort sequence.

Open the User page and then navigate to the **Bookmarks** tab to modify or delete a bookmark.

Description of Page

Sequence is the sort sequence associated with the bookmark. Bookmarks with the same sequence are then sorted alphabetically.

Name is the user-defined name assigned to the bookmark. This is the text that is visible in the [Bookmarks](#) dashboard zone.

NOTE: Favorite Links vs. Bookmarks. Favorite links are configured through the user page and define pages that a user can navigate to. They do not define context (although some pages may use information currently in global context when navigating). Some users may not be allowed to configure their own favorite links and would see the favorite links associated with a profile user. Bookmarks are created using a bookmark button available on each page. The bookmark saves navigation information, context information and also captures some information about the state of a page. Bookmarks are not governed by any user profile configuration.

User - Portal Preferences

The base product contains several [portals](#) that allow users to customize them via portal preferences. Portal preferences allow users to control:

- Which zones appear on the portal
- The order in which the zones appear
- Whether the zones should be "collapsed" (i.e., minimized) when the portal opens.

NOTE: You may not be able to change your portal preferences. If a note appears immediately before the list of portals, a system administrator has configured your user ID to reference a **Portals Profile User** (this is defined on the **Main** tab). Preferences set in this way cannot be modified. System administrators do this in order to enforce a common look-and-feel throughout the user community.

Open the User page and then navigate to the **Portal Preferences** tab to modify a user's preferences.

Description of Page

The [accordion](#) contains a row for every portal configured to show on user preferences and to which you have access. To change how a portal's zones appear, expand the respective row and change the elements accordingly. The remainder of this section describes how you can configure how a portal's zones appear.

Zone lists all of the [zones](#) in the portal.

Place a check under **Display** if the zone should be displayed on the portal.

Place a check under **Initially Collapsed** if the zone should be minimized when the portal is initially opened. Setting zones as initially collapsed is a good idea to save space and to help pages to load more quickly. Refer to [Zones May Appear Collapsed When A Page Opens](#) for more information.

CAUTION: Recommendation. It is recommended that you set your preferences to collapse zones that you don't use often. This is because the system doesn't perform the processing necessary to build collapsed zones until you ask to expand a zone. Opening a page with zones collapsed accelerates the response times of portal.

Use **Sequence** to control the position of the zone in respect of the other zones. This field is disabled if **Display** is not checked. Duplicate **Sequence** numbers are allowed.

For zones displaying data that is changing often, use **Refresh Seconds** to define in seconds how often the zone is refreshed. The minimum valid value is 15. The maximum valid value is 3600 (1 hour). A value of 0 indicates no automatic refresh.

Security Access indicates whether the user has access rights to a zone. Refer to [Granting Access To Zones](#) for more information.

User - Favorite Links

This page is used to define a user's favorite transactions and URLs. Each such link appears as an entry in the [Favorite Links Zone](#) in the [Dashboard](#) area.

NOTE: A hot key can be used to execute a favorite link. Rather than clicking a button in the favorite links zone, you can invoke your first nine favorite links by pressing `Ctrl` + a number (where the number corresponds with the relative position of the transaction in your list of favorites). Note that the numeric keypad on your keyboard cannot be used to implement this function.

Open the User page and then navigate to the **Favorite Links** tab to modify a user's favorite links.

Description of Page

NOTE: You may not be able to change your favorite links. If a **Note** appears beneath your **User ID**, your user id has been setup to reference a specific **Favorites Profile User** as defined on the **Main** tab. If a system administrator has setup your user ID in this way, your preferences may not be changed. System administrators may apply this feature in order to enforce a common look-and-feel throughout the user community.

Each row references a [Navigation Option](#). The navigation options supplied with the base package correspond with the system's menu items. This means you can setup a favorite link to open any transaction in the system (in either **add** or **update** mode).

NOTE: Favorite links can point to other places. The navigation options supplied with the base package always open a transaction's **Main** tab. If you find yourself continually accessing a different tab page, you can have your implementation team create a new navigation option that references the desired tab page. Once this navigation option is set up, you can reference it as one of your favorite links. In addition, it's also possible for your implementation team to setup navigation options that open a URL outside of the system. For example, your implementation team could setup a navigation option to a credit rating company's website. Once this navigation option is set up, you can reference it as one of your favorite links.

Use a **Sequence** to control the order in which the navigation option appears in the [Favorite Links Zone](#).

Security Access indicates if you have been given security rights to the respective transaction. Refer to [The Big Picture Of Application Security](#) for more information.

NOTE: Favorite Links vs. Bookmarks. Favorite links are configured through the user page and define pages that a user can navigate to. They do not define context (although some pages may use information currently in global context when navigating). Some users may not be allowed to configure their own favorite links and would see the favorite links associated with a profile user. Bookmarks are created using a bookmark button available on each page. The bookmark saves navigation information, context information and also captures some information about the state of a page. Bookmarks are not governed by any user profile configuration.

User - Favorite Scripts

This page is used to define a user's favorite scripts. Each script is displayed in the **Favorite Scripts** zone on the **Dashboard** portal where it can be used to [initiate a script](#).

NOTE: A hot key can be used to execute a favorite script. Rather than selecting a script from the business process assistant, you can invoke your first nine favorite scripts by pressing `Ctrl + Shift + a number` (where the number corresponds with the relative position of the script in your list of favorites). Note that the numeric keypad on your keyboard cannot be used to implement this function.

Open the User page and then navigate to the **Favorite Scripts** tab to modify a user's Favorite Scripts.

Description of Page

NOTE: You may not be able to change your favorite scripts. If a **Note** is displayed on top of the grid, your user id has been setup to reference a specific **Favorites Profile User** as defined on the **Main** tab. If a system administrator has setup your user ID in this way, your preferences may not be changed. System administrators may apply this feature in order to enforce a common look-and-feel throughout the user community.

Each row in the grid contains one of your favorite **Scripts**.

Use the **Sort Sequence** to control the order in which the scripts appear in the [business process assistant menu](#).

Security Access indicates whether you have access to the script's application service. Refer to [The Big Picture Of Application Security](#) for more information.

User - Characteristics

Select **Admin > Security > User > Search** and navigate to the **Characteristics** tab to define characteristic values for the user. You cannot modify this page if you accessed it through My Preferences.

Description of Page

Use the characteristics grid to capture additional information about the user.

You can only choose **Characteristic Types** defined as permissible for the user record. Refer to [Setting Up Characteristic Types & Their Values](#) for more information.

Enter a valid **Characteristic Value** for the selected characteristic type. You may enter more than one characteristic row for the same characteristic type, each associated with a unique **Sequence** number. If not specified, the system defaults it to the next sequence number for the characteristic type.

User - Miscellaneous

Select **Admin > Security > User > Search** and navigate to the **Miscellaneous** tab to view additional information associated with a user.

User Id, First Name and Last Name are displayed. Depending on your implementation, additional zones may appear on the User Portal

If additional zones appear, use the embedded help for information about the fields managed on the zone.

Initiating Scripts

Your implementation team can set up business process assistant (BPA) [scripts](#) to walk you through business processes. Once scripts have been set up, you can initiate a script using any of the following methods:

- You can define a list of your "favorite scripts" on your [user preferences](#). You can then invoke any of the scripts from the Favorite Scripts zone on the dashboard portal. You can also invoke any of your first 9 favorites by pressing `Ctrl + Shift + a number` (where the number corresponds with the relative position of the script in your list of favorites). For example, if you press `Ctrl+Shift+2` and you've setup your "favorite scripts" to be **Start Autopay** and **Stop sending marketing information**; the **Stop receiving marketing information** script is invoked. Note that the numeric keypad on your keyboard cannot be used to implement this function.
- You can configure a menu item to launch a script by referencing a [navigation option](#) that is a **script** navigation option type.
- The system creates [To Do entries](#) to highlight tasks that require attention (e.g., bills in errors, accounts without bill cycles, etc.). Users can complete many of these tasks without assistance. However, you can set up the system to automatically launch a script when a user selects a To Do entry. For example, consider a To Do entry that highlights a bill that's in error due to an invalid mailing address. You can set up the system to execute a script when this To Do entry is selected. This script might prompt the user to first correct the customer's default mailing address and then re-complete the bill. Refer to [Executing A Script When A To Do Is Launched](#) for more information.
- You can indicate that a script should be [launched upon entering the system](#). This functionality enables an external system to launch the system and immediately launch a script.
- The following [hot keys](#) cause an interactive menu is displayed:
 - `Ctrl+Alt+Q`
 - `Ctrl+Shift+S`

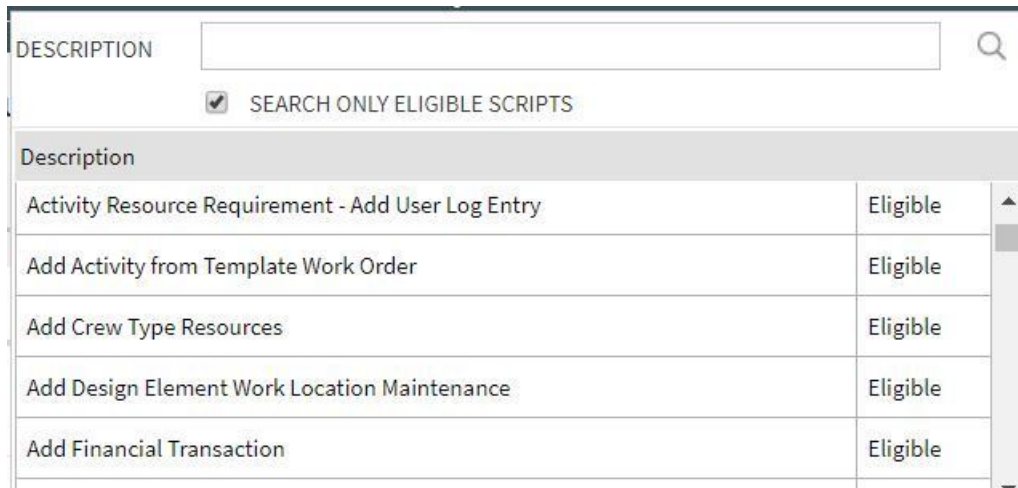

The menu allows you to search for a script using any word in its description. Note, if you've turned on **Search only Eligible Scripts**, your search is limited to [eligible scripts](#). Note, the system displays an indication if each script in the grid is **Eligible** or **Ineligible** in this section.

You can initiate a script from this area by clicking on it.

When a script is initiated, this menu closes and the [object display area](#) shifts down to make room for the script area.

NOTE: Securing scripts. Only scripts the user is allowed to execute are displayed. Refer to [Securing Script Execution](#) for more information.

NOTE: Customize the script area. Using the [Height](#) step type, an individual script may be configured to use more or less of the script area than the standard script area. It is also possible to configure a script to hide the script area altogether.

The information in the script area takes you through the steps in the selected business process (note, your implementation team controls the information that appears in the script area).

The following points highlight useful information common to all scripts:

- **Return focus to script area.** Often during a script the focus moves from the script area to another section of the page. For example, you might be required to fill in data for a new record being added. When you are ready to return to the script area, rather than using the mouse to return to the area, you can press `Ctrl+Shift+F`. The focus returns you to either the first available input field or to a "default" button if no input field is available.
- **The Continue button.** Many steps in a script ask you to click the **Continue** button when you're ready to restart a script. For example, a step may ask you to confirm a customer's automatic payment information and then click **Continue** when you're ready for the script to restart. Rather than using the mouse to click this button, you can press `Ctrl+Shift+C`.
- **Selected button changes color.** When you click a button in the script area, the button selected changes color so that you can easily see which option you selected.

FASTPATH: Refer to [The Big Picture Of Scripts](#) for more information about scripts.

NOTE: You can abort a script at any time by clicking the red X button in the upper right corner of the script area (or by pressing `Ctrl+Shift+X`).

Shortcut Key Summary

The following table summarizes the keyboard shortcuts (hot keys) available in the system:



NOTE: It is possible that your specific product supports additional shortcut keys. Refer to your product documentation for more information.

NOTE: It is possible that some of the following system accelerator keys may duplicate shortcuts, or hot keys, that are predefined within your browser. If this is the case, the browser's functionality commonly takes precedence.

NOTE: It is possible that your implementation uses one of the accelerator keys listed below for a different purpose. For example, in some languages, a shortcut key may be used for a special character in the alphabet not included on all keyboards. It is possible to turn off any of the `Alt+letter` shortcuts and `Ctrl+Alt+letter` shortcuts listed below using a properties file entry. The property is `ouaf.shortcut.ignore.altKeys=` where one or more letters may be entered separated by a comma. When setting this property, the system automatically enables a 'potential alternate key' for certain functions (see the table below). Refer to the *Server Administration Guide* for more information about the property.

Accelerator Key	Potential Alternate Key (see Note above)	Function
<code>Ctrl+Alt+A</code>		Opens the Admin Menu button.
<code>Alt+B</code>		Returns to the previous page on which you were working. This is the equivalent of clicking the Back button.
<code>Ctrl+Alt+B</code>		Launches the Bookmark dialog. This is the equivalent of clicking the Bookmark button.
<code>Alt+C, Ctrl+Alt+C, Alt+Shift+C</code>		Clears the currently displayed object from the page. This is the equivalent of clicking the Clear button.

Accelerator Key	Potential Alternate Key (see Note above)	Function
Ctrl+Shift+C		If the current step in the Script area has a Continue button, this shortcut is equivalent to clicking Continue .
Ctrl+Alt+D, Alt+D		Creates a duplicate of the object being displayed. Equivalent to clicking the Duplicate button.
Ctrl+Alt+F		Positions the user's cursor to the Menu Item Search input field.
Ctrl+Shift+F		If the Script area is open and you are working on a different area of the page, this key returns focus to the script area. Focus returns to either the first available input field or to a "default" button if no input field is available.
Alt+G		Returns to the most recent page that was displayed when the Back button was clicked. Equivalent to clicking the Forward button.
Ctrl+Alt+H		Opens a dropdown list of recently-visited pages, the equivalent of clicking the History button.
Alt+J		Minimizes the dashboard . It also expands the dashboard, if it was minimized.
Alt+K		Transfers you to To Do Entry - Main for the current item in the To Do list. Pressing Alt+K while on this page takes you to the first To Do entry on the list.
Ctrl+Alt+L		Logs the user out of the system. This is equivalent to clicking the Logout menu item.
Ctrl+Alt+M		Opens the Menu button.
Alt+N	Alt+Shift+N	Displays the next entry in the search results. Equivalent to clicking Next Item .
Alt+O	Alt+Shift+O	Navigates to the user's home page. Equivalent to clicking the Home button.
Ctrl+Alt+P		Opens your User Preferences page. Equivalent to clicking the Preferences menu item.
Alt+P		Displays the previous entry in the search results. Equivalent to clicking Previous Item .
Ctrl+Alt+Q		Opens the business process assistant , where you can select a script that walks you through a business process.
Alt+RCtrl+Alt+R		Refreshes the page with the last saved version of the object being displayed in the page. Equivalent to clicking the Refresh button.
Alt+S	Alt+Shift+S	Saves any changes that you've made on the database. Equivalent to clicking the Save button.
Ctrl+Shift+S		Opens the business process assistant , where you can select a script that walks you through a business process.
Alt+X	Alt+Shift+X	Opens the To Do Summary .
Ctrl+Shift+X, Ctrl+Shift+Z		If the Script area is open, equivalent to clicking the Close button in the script area. If a pop-up window is open, this closes the window.
Alt+Y		Displays the previous item in the To Do list. Equivalent to clicking the Previous button in the Current To Do zone.

Accelerator Key	Potential Alternate Key (see Note above)	Function
Alt+Z	Alt+Shift+Z	Displays the next item in the To Do list. Equivalent to clicking the Next button in the Current To Do zone.
Alt+Insert		Inserts a new row into an editable grid if the insertion point is in the grid. Equivalent to clicking the Insert button.
Alt+Delete		Removes a row from an editable grid if the insertion point is in the grid. Equivalent to clicking the Delete button.
Alt+F1		Invokes online Help for the application. Equivalent to clicking the Help button.
Alt+1 ...Alt+9		These keys are only applicable when a page / portal with multiple tabs is open. The shortcuts open the tab page whose relative position corresponds with the shortcut number. For example, if you press Alt+3 on a page with multiple tabs, the third tab is displayed. If there are more than nine tabs on a page, you must use the mouse or F2/Shift+F2 to display a tab. Note that you cannot use the numeric keypad for these shortcuts.
Ctrl+1 ...Ctrl+9		Invokes the favorite link whose relative position corresponds with the shortcut number. For example, if you press Ctrl+3, the transaction for your third "favorite link" is invoked. Note that you cannot use the numeric keypad for these shortcuts.
Ctrl+Shift+1 ... Ctrl+Shift+9		Invokes the favorite script whose relative position corresponds with the shortcut number. For example, pressing Ctrl+Shift+2 selects the second of your "favorite scripts". The numeric keypad cannot be used for these shortcuts.
Alt+left arrow		Populates a scroll area with the previous entry. Equivalent to clicking the scroll control  .
Alt+right arrow		Populates a scroll area with the next entry. Equivalent to clicking the scroll control  .
Enter when in a field with an adjacent Search button		Invokes the search. Equivalent to clicking the Search Button .
Enter when a row in a search result grid is highlighted		Selects the item and closes the search. Note that after selecting an item from the search results, you can press Alt+N or Alt+P to scroll up or down through other items in the result grid without returning to the search results.
Enter when a menu item is highlighted		Selects the menu item.
Enter when the insertion point is within a tree node		Equivalent to clicking on the item in the tree: <ul style="list-style-type: none"> • If the insertion point is on a node image, the node is either expanded or collapsed, dependant on its current state. • If the insertion point is on a context menu, the context menu is opened and normal menu processing applies. • If the insertion point is on a "link" element, normal navigation processing occurs.
Tab when a row in a search result is highlighted		Highlights the next row.
Shift + Tab when a row in a search result is highlighted		Highlights the previous row.

Accelerator Key	Potential Alternate Key (see Note above)	Function
Space	when the insertion point is on a button	Equivalent to pressing the button.
Space	when the insertion point is in a date/time field	Opens the date/time selection window.
Space	when the insertion point is in a check box	Toggles the check box between checked and unchecked.
Page Up	while in a list grid	Scrolls the contents of the list grid up approximately one page.
Page Down	while in a list grid	Scrolls the contents of the list grid down approximately one page.
Up or Down Arrow	when in a dropdown list	Moves to the next or previous value in the list. You can also press a letter key to locate the next value starting with that letter.
Up or Down Arrow keys	when in search results	Highlights the next/previous row in search results.
Up, Down, Left or Right Arrow	when using a menu	Highlights other menu items.
Esc	when using a menu	Closes the menu.
F2		Opens the next tab page when viewing a page / portal with multiple tabs.
Shift+F2		Opens the previous tab page when viewing a page / portal with multiple tabs.

Customer Information

We use the term **customer information** to reference the demographic, geographic, and financial objects that form the core of your CIS system. In this section, we describe how to maintain these objects.

Understanding The V

The "V" is the shape of a diagram we use to illustrate the objects that form the core of the system: **Person, Account, Premise, Service Agreement, and Service Point**. These objects hold demographic, geographic, and financial information about your company's customers and properties. The following diagram illustrates the objects in the "V", as well as important objects related to the "V" objects (**bill, payment, meter, field activity, meter read**).

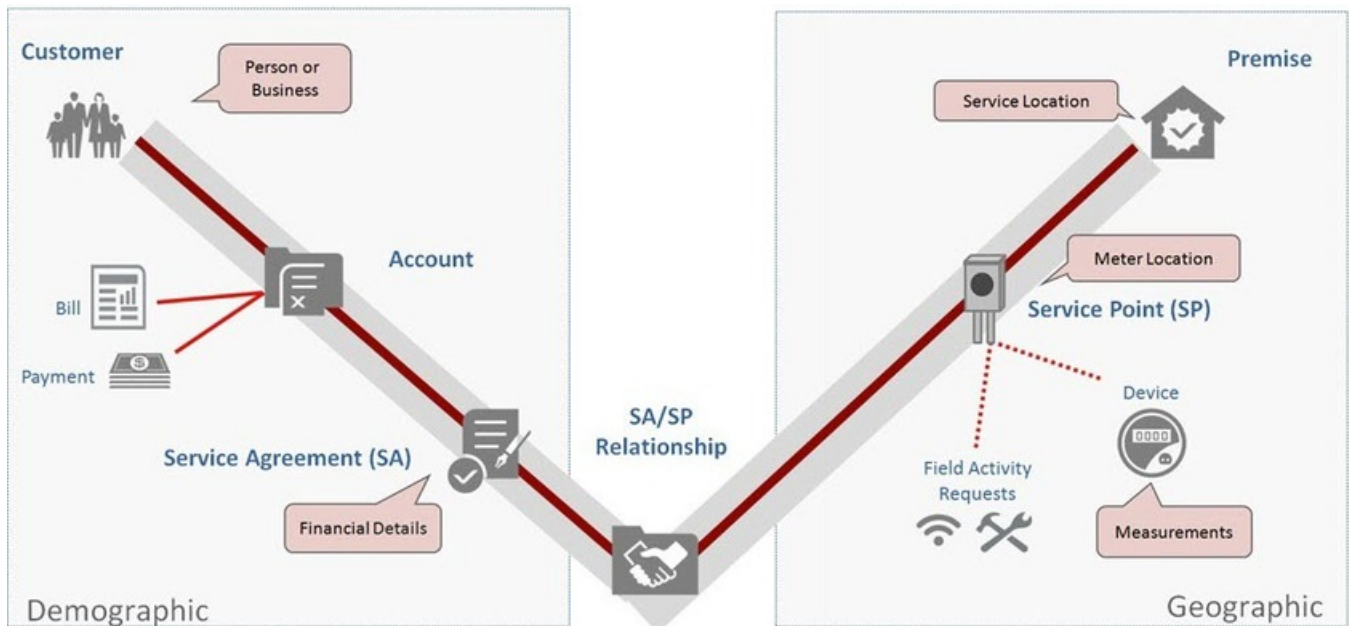

You must intuitively understand the concepts embodied in the "V" before you can perform the business processes in the system. In this section, we provide an overview of these objects. In later sections, we describe how you maintain this information.

Persons

A person exists for every individual or business with which your company has contact. Besides customers, persons exist for landlords, contractors, accountants at corporate customers, third party guarantors, energy distributors, collection agencies, etc.

On a person is maintained demographic information like Name, Mailing Address, Phone Numbers, Email Address, and Life Support Details.

Most persons are linked to at least one [account](#) because, without an account, the person cannot receive a bill. There are rare examples of persons without accounts; for example, collection agencies that don't receive bills, and parent companies that receive statements (as opposed to bills).

FASTPATH:

Refer to [Maintaining Persons](#) for more information about persons.

Accounts

Accounts are the entities for which bills are created. You must create at least one account for every customer. The account contains information that controls when bills are created and how they are formatted.

Every account must reference at least one [person](#) because the person contains the customer's demographic information (e.g., names, phone numbers, forms of ID). We refer to this individual as the "main" person linked to the account. In addition to the "main" person, an account may reference other types of persons, e.g., the billing contact, the third party guarantor of the account's debt, persons who receive copies of bills, etc.

Most accounts are linked to at least one [service agreement](#) because, without a service agreement, there is nothing on which a bill can be based. An account without a service agreement may exist; you just won't be able to do much in the system with such an account.

FASTPATH:

Refer to [Maintaining Accounts](#) for more information about accounts.

Service Agreements (SAs)

Think of a service agreement as a contract between your company and a customer. The service agreement contains the terms and conditions controlling how the system calculates charges for the specific service supplied to the customer.

Every [account](#) should have at least one service agreement (otherwise, the account has no financial obligations with your company). There is no limit to the number of service agreements that may be linked to an account. However, most residential customers have X service agreements where X is the number of services sold by your company. For example, if your company sells both electricity and gas, most accounts will have two service agreements.

A separate service agreement is required for every service supplied to every account. Why? Because a variety of fields may differ for each service agreement:

- Obviously, the price of the service is different.
- The credit and collection criteria may be different.
- The general ledger account to which the resultant revenue and/or receivable are linked is different.
- The sales tax could be different for each good / service / location.
- The service point measuring consumption will frequently be different.
- The list goes on...

Service agreements that bill for premise-based services are linked to one or more [premises](#) via their [service points](#). When you link a service point to a service agreement, you are telling the system that the service agreement's account will pay for the service point's service.

FASTPATH:

Refer to [Maintaining Service Agreements](#) for more information.

Premises

A premise is created for every location to which your company supplies service. On a premise is maintained geographic information like:

- The address.
- Characteristics that determine tax jurisdictions.
- Descriptions of unusual situations associated with a property.
- The list goes on...

Most premises have at least one [service point](#) because, without a service point, there are no services supplied to the premise. A premise without service points may exist; you just won't be able to do much in the system with such a premise.

FASTPATH:

Refer to [Maintaining Premises](#) for more information about premises.

Service Points (SPs)

Think of a service point as a specific location at a premise where your company supplies service. A service point contains information describing the type of service and how it is measured.

A [premise](#) should have at least one service point (otherwise, there are no services supplied to the premise). However, it is permissible for a new premise to exist without service points until you are ready to physically start service at the premise.

A premise may have many service points. However, most residential premises have X service points where X is the number of services sold by your company. For example, if your company sells both electricity and gas, most of your premises will have two service points.

Separate service points are required for every service supplied to a premise. Why? Because a variety of fields may differ for each service point:

- Basic information about the Service Point, including time zone, market, parent Service Point (if applicable), and status.
- Information related to field work that is performed at the current Service Point, including applicable warnings or instructions.
- The measurement cycle, route, and route sequence for the Service Point.
- Basic characteristics about the service; for example, pipe size, take point, and amperes.

When you link a service point to a [service agreement](#), you are telling the system that the service agreement's account will pay for the service point's service.

The following topics describe the relationship between a service point and the physical devices that may be installed at the service point.

Metered versus Item-Based versus Non-Badged Service Points

There are three major categories of service points:

- Those where consumption is measured (e.g., electricity, gas, water) by a meter. We refer to these types of service points as **metered**. A metered service point may have zero or one meter installed at any instant in time. Over time, a metered service point may have many meters installed and removed.
- Those where consumption is not measured, but where there exists some type of badged (i.e., uniquely identified) item that impacts billing and dispatching (e.g., streetlights, a security camera). We refer to these types of service points as **item-based**. An item-based service point may have zero or one badged item installed at any instant in time. Over time, an item-based service point may have many badged items installed and removed.
- Those where one or more non-badged items (i.e., items without a unique identity) that have some impact on billing or dispatching exist. We refer to these types of service points as **unbadged**. At a single instant in time, a non-badged service point may have many unbadged items installed at it. Refer to [Service Points With Multiple Items](#) for an illustration of such a service point.

NOTE:

Multiple unbadged items can also be defined on metered and item-based service points. Under some billing scenarios, you may define non-badged items on a metered or item-based service point. For example, assume you have an item-based service point that exists to support lamp service. Also assume that the rate for lamp service is based on the type of lamp and the number of feet of electric wire between the pole and the power source. To define the number

of feet of wire, you could create a non-badged item type called WIREFEET and indicate the number of feet on the item-based service point. On this service point, you can also keep track of the specific lamp that's installed.

Service Points With Multiple Items

An example will help explain a single service point with multiple non-badged items. Assume you have a parking lot with 4 lights, none of which are badged.

A Premise With One Service Point Where The Service Point Has Multiple Items

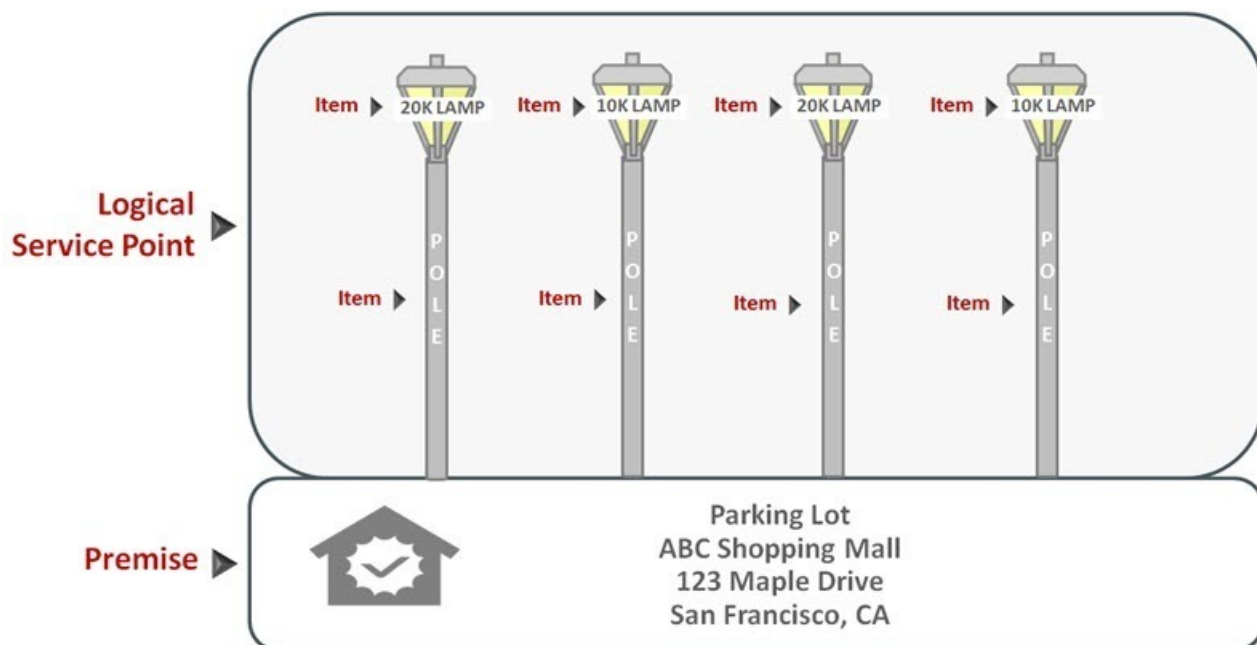

You can set up the above example with one premise with a single non-badged service point. On the service point, you create one item for each type of item in the parking lot:

- 20K lumen lamp
- 10K lumen lamp
- pole

For each type of item, you indicate the quantity that exist in the parking lot:

- 20K lumen lamp - 2
- 10K lumen lamp - 2
- pole - 4

Putting It All Together

To help you understand the significance of the "V", consider a few scenarios:

- When a new residential customer starts service, you create both person and account objects for the new customer. In addition, you also create service agreements and link them to the appropriate service points. You won't have to create a new premise and service points because the customer is probably moving into an existing house.
- If the residential customer moves within your service territory, you don't have to set up new person or account objects. You also don't have to set up new premise and service point objects if the customer is moving into an existing house. You only have to create new service agreements and link them to the appropriate service points (and the system does most of the service agreement set up processes for you).
- A business with a single location uses the same "V" objects as does a residential customer. If the business expands and starts using services at other locations, you simply link new service agreements to the existing account. You don't have to redefine person or account information.

NOTE:

Bottom line. A person and an account are needed for every customer. After these exist, future service requests simply involve stopping existing service agreements and starting new ones. You typically won't have to add or modify premise or service point information unless new locations are built.

FASTPATH:

For more information, refer to [Maintaining The "V"](#), [Navigating The "V" Using Control Central](#), [The Big Picture Of Starting Service](#), and [The Big Picture Of Stopping Service](#).

Sample V For A Residential Customer

The following illustration shows a simple residential customer's "V" objects.

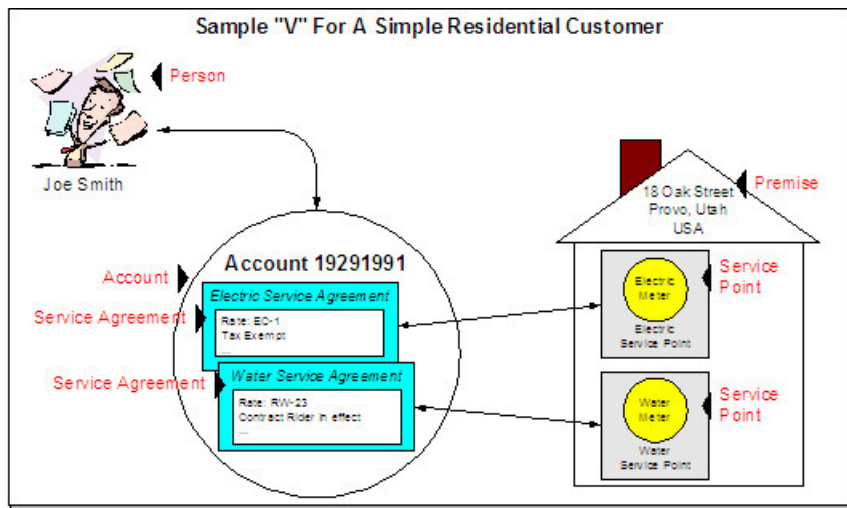

Sample V For A Commercial Customer With Multiple Premises

The following illustration shows the "V" objects for a commercial customer who pays for service at two premises.

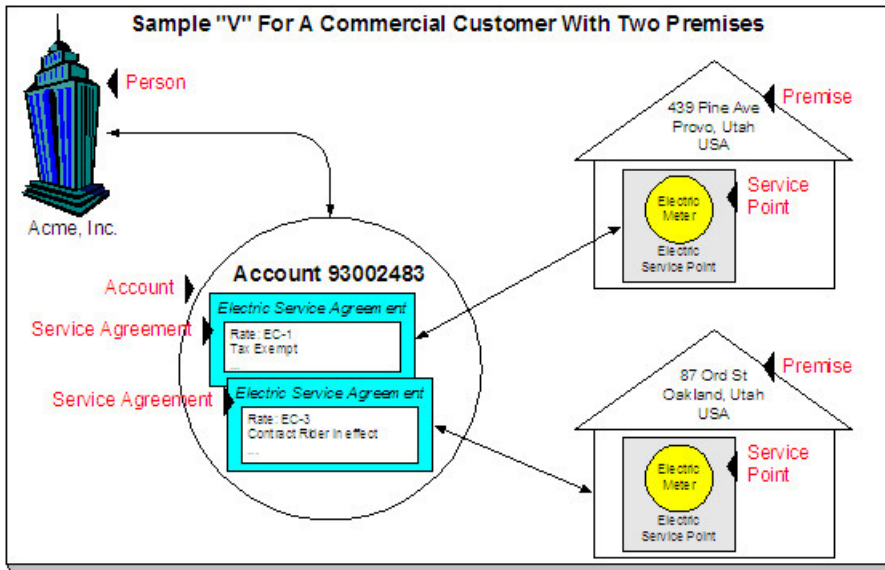

NOTE:

The above example shows a separate service agreement per premise. If your rates allow, you could link both premises to a single service agreement.

How To Set Up Customer Hierarchies

Consider the following customer hierarchy:



The above hierarchy shows a parent company (Michelin Inc) with two subsidiaries. Each subsidiary, in turn, could have their subsidiaries, and these subsidiaries can have their own subsidiaries ...

You must set up a person for every individual and business in a hierarchy. After the basic demographic information is defined, you define each person's children using the [Person to Person](#) page.

NOTE:

A script can be used to set up a hierarchy. The demonstration database contains a [script](#) that guides users through the process of setting up a hierarchy. Please speak to your implementation staff if you'd like to import this script for use in your implementation.

After a hierarchy is set up, the system displays its members in the [Person Tree Zone](#) (this is a zone on the [Customer Information Portal](#)). In addition, if the persons in a hierarchy have accounts, summary information about these accounts is displayed in the [Account Summary Zone](#).

While hierarchies would typically be set up to define parent companies and subsidiaries, you can use this functionality for many other purposes. For example, a customer relationship manager could set up a hierarchy containing their "important" customers. To do this, they'd need to create a "dummy" person for the parent and then link the "important" customers to it. After this hierarchy is set up, the manager could see a summary of these customers in the [Account Summary Zone](#) whenever they display the "dummy" person.

Navigating The V Using Control Central

Control Central is the name given to the functionality that helps you:

- Find a person.
- Find an account.
- Find a premise.
- View information about a person / account / premise.
- View alerts and messages about a person / account / premise.
- Navigate to pages that contain information related to a person / account / premise.

FASTPATH:

For more information about the relationships between persons, accounts, and premises, see [Understanding The "V"](#).

Control Central - Main

Open **Menu** > **Control Central** to find a customer and/or a premise.

Keyboard Shortcut	Alternate Shortcut
Alt+L	Alt+Shift+L

NOTE: Refer to [Shortcut Key Summary](#) for information about the alternate shortcut.

NOTE: Automatic transfer to Account Information tab. You are automatically transferred to [Control Central - Account Information](#) when an account / premise is selected on this page.

The contents of this section describe how to use the main tab of control central.

Search Facilities

Control Central allows users to search for a person, account and/or premise using a variety of search criteria.

The following search options are provided in the base product:

- **Name and Address:** searches for an accounts, person and / or premise using a person's name and / or a service address.
- **Account ID:** searches for an account using an Account ID.
- **Person Contact:** searches for accounts / persons using a person contact.
- **Phone Number:** searches for accounts / persons using a phone number.

- **Person ID Type/Value:** searches for accounts / persons using a person identifier.
- **Geo Type/Value:** searches for a premise using the geographic identifier of the premise or of one of its service points.

Refer to each search option's zone help for details on the search criteria.

From the search results lists, you can select a record to navigate to [Control Central - Account Information](#), where information about the customer is displayed. You can also navigate to other pages in Control Central to view more information about the account, person and / or premise.

NOTE:

Automatic transfer to Account Information tab. If your search criteria result in a single customer being retrieved, you are automatically transferred to [Control Central - Account Information](#) with that customer's information displayed.

Meter Search

Control Central does not provide an option to search using a meter ID.

Item Search

Control Central does not provide an option to search using an item ID.

Search Options

The **CIS Division** filter can be specified to limit the search to accounts or premises in a particular CIS Division. The matching is done on either the account's CIS Division or the premise's CIS Division depending on whether the search is account-oriented or premise-oriented:

- If searching by only a name, the search results that have an associated account will be matched on the account's CIS Division.
- If searching by a name and any of the address constituents, the search results that have an associated account will be matched on the account's CIS Division.
- If searching by only the address constituents, the search results will be matched on the premise's CIS Division, regardless of whether or not the premise is linked to an account.

The **Show All Premises** search option controls whether you see all of an account's premises in the [search results](#). If turned on, every premise linked to an account is shown in the search results. If turned off, only one premise is shown per account (and this premise is selected at random).

This switch pertains to the following search methods:

- Search by name only (i.e., all address constituents are left blank)
- Search by account ID
- Search by person phone number
- Search by person identifier

This switch does NOT pertain to the following search methods as these are premise-oriented, not account-oriented:

- Search by name when any address constituent is entered
- Search by address constituents only (i.e., name is blank)
- Search by geographic identifier

The benefit of turning this switch off is that an account will be immediately selected when you enter unique account-oriented search criteria. For example, if you specify an **Account ID** and press enter, the system automatically selects the

account; you don't have to wait for the search results to be populated with the multitude of premises linked to the account (and then select one of the rows). Please note, an alert highlights if the selected account has other premises.

NOTE:

Default. The first time you open this page, **CIS Division** and **Show All Premises** are defaulted from your [user preferences](#). When you return to this page, the last values are defaulted.

The **Expand Results** search option is available if your implementation has enabled expanded / fuzzy searching. (Refer to [Advanced Search Options](#) for more information.) This functionality relies on special indexes configured in the database, to attempt to include similar words or alternate spellings of a supplied search value. This expanded searching is applied only to searches by name and / or address constituents.

Wild Cards

The control central searches against **Name**, **Address**, and **City** support wild cards. The wild card character is % and represents any number or character. The system always appends a % for you when you use these search methods. Examples will help clarify this functionality:

- If you enter a B, the system searches for B% (and will find all objects that begin with B).
 - If you enter B%N, the system searches for B%N%. It will find anything that
 - Starts with a B, and
 - has zero or more other characters followed by an N.
 - If you enter %B the system searches for %B%. It will find anything with a B in it, no matter what it starts and ends with.
-

NOTE:

Certain wildcard searches can result in lengthy response times. If you use the wildcard character to prefix your search criteria (e.g., %San Fran), lengthy response times can result. Why? Because the system will have to look at EVERY customer in the system before it can return the results.

Search Results

The search results at the bottom of the page contain persons, accounts, and premises that match your search criteria. The information displayed in this area differs depending on the type of search you perform. You can perform searches on a customer's name, address, phone number, person contact, person identifier and geographic value.

The information strings that display in the **Person/Account** and **Premise** columns vary depending on what context information is present:

- For a person that is not linked to an account, the Person/Account information string will include the text 'No Account Information' and the Premise column will be blank.
 - For an account that does not have a service agreement, the Person/Account information string will include the text 'No Service Agreement' and the Premise column will be blank.
 - For an account with a service agreement that is not currently linked to a service point, the Premise column will display 'No Premise Information'.
 - For a premise that is not linked to an account, the Person/Account column will display 'No Person Information'.
-

NOTE:

The first 300 matches are retrieved and displayed. The base search zones are configured with the *Number of Rows to Display* and *Number of Rows to Retrieve for SQL* parameters set to 300. If you do not find the account / person / premise you are looking for in the set of results, refine your search criteria.

Automatic selection if only one match. You don't have to select a record if there is one and only one object that matches your search criteria. The system automatically selects it and transfers you to [Control Central - Account Information](#).

Use Tab and Enter to select an account / person / premise. You don't have to use the mouse to select a record when multiple matches are returned. The system highlights the first row in the search results. If this is the account / person / premise you are looking for, press **Enter** to select it. If not, press **Tab** until you've highlighted the desired record and then press **Enter** to select it.

Use the Work List dashboard zone to navigate to any account / person in the search results. When you select a record from the search results, you are automatically transferred to [Control Central - Account Information](#). If you want to look at a different account that appeared in the search results, you do not have to return to the **Main** tab. You can use the **Work List** dashboard zone to load another account without leaving the [Control Central - Account Information](#) page. To build the work list, run the search and click on the Work List button that appears in the **Person /Account** column heading. This will copy over the contents of the **Person/Account** column into the **Work List** zone in the dashboard. Refer to [Work Lists](#) for more information.

Control Central - Account Information

Once [Control Central - Main](#) has populated an account, you are brought to the Account Information page to see an overview of the account.

Keyboard Shortcut	Alternate Shortcut
Alt+I	Alt+Shift+I

NOTE: Refer to [Shortcut Key Summary](#) for information about the alternate shortcut.

The following points should be noted about this page:

- Selecting an account on control central causes the [global context](#) information to be refreshed. Various zones available on this page use the value in the global context to display relevant data for the appropriate account, person and premise.
- This portal page may be configured by the user. Refer to [Each User Can Customize Which Zones Appear](#) for information about how to configure which zones appear.
- The Go To Control Central option on the account context menu navigates to this page.

The contents of this section describe the zones that are available on this portal page.

Account Activity History Zone

The **Account Activity History Zone** is a grid that summarizes a variety of account-related events (in reverse chronological order). Pushing the button adjacent to the information transfers you to an appropriate page. The following table lists the type of information that may appear in this zone and the page to which you will be transferred if you push the adjacent button.

Activity Label	What Is Displayed	Drill Down Transfers You To
Severance Event. <i>One row is displayed for every Pending and Awaiting Field Activity</i>	The severance event's description, status and trigger date (if non-blank). If the event	Severance Process - Events

Completion severance event linked to the account's service agreements.	is dependent on earlier events, the earlier events' type and status is appended	
Severance Process. One row is displayed for every Inactive severance process linked to the account's service agreements. Inactive processes are displayed (as opposed to active because active severance processes have pending events and pending events are shown separately).	The severance process's SA type description, severance process template description, status and create date/time	Severance Process - Main
Collection Event. One row is displayed for every Pending collection event linked to the account.	The collection event's description, status and trigger date (if non-blank)	Collection Process - Events
Collection Process. One row is displayed for every Inactive collection process linked to the account. Inactive processes are displayed (as opposed to active) because active collection processes have pending events and pending events are shown separately.	The collection process's description, debt class description, status and create date/time	Collection Process - Main
Overdue Event. One row is displayed for every Pending overdue event linked to the account.	The overdue event's standard information string this is dynamic as it is constructed by an algorithm)	Overdue Process - Events
Overdue Process. One row is displayed for every Inactive overdue process linked to the account. Inactive processes are displayed (as opposed to active) because active overdue processes have pending events and pending events are shown separately.	The overdue process's standard information string (this is dynamic as it is constructed by an algorithm)	Overdue Process - Main
Cut Event. One row is displayed for every Pending cut event linked to the account.	The cut event's standard information string (this is dynamic as it is constructed by an algorithm)	Cut Process - Events
Cut Process. One row is displayed for every Inactive cut process linked to the account. Inactive processes are displayed (as opposed to active) because active cut processes have pending events and pending events are shown separately.	The cut process's standard information string this is dynamic as it is constructed by an algorithm)	Cut Process - Main
Write-off Event. One row is displayed for every Pending write-off event linked to the account.	The write-off event description, status and trigger date (if non-blank)	Write-off Process - Events
Write-off Process. One row is displayed for every Inactive write-off process linked to the account. Inactive processes are displayed (as opposed to active) because active write-off processes have pending events and pending events are shown separately.	The write-off process template's description, status and create date/time	Write-off Process - Main
Customer Contact. One row is displayed for every customer contact associated with the main customer linked to the account.	The main name of the person associated with the customer contact, the customer contact's class and type, and the customer contact's date	Customer Contact - Main

Field Activity. One row is displayed for every unique non-cancelled field activity linked to the account's non-cancelled/non-closed service agreements.	The field activity type, scheduled date/time and status	Field Activity - Main
Pay Plan. One row is displayed for every non-cancelled pay plan linked to the account	The pay plan's type, status, date, and amount	Pay Plan - Main
Payment Arrangement. One row is displayed for every non-cancelled payment arrangement (i.e., service agreement with a special role of Payment Arrangement) linked to the account	The service agreement's division, SA type, status, and effective period.	Payment Arrangement - Main
Credit Rating History. One row is displayed for every credit rating transaction that affects the account's credit rating	The effect on the account's credit rating, the end date, creation date and the process that created the transaction.	Account - C&C
Cash-Only History. One row is displayed for every credit rating transaction that affects the account's cash-only score	The effect on the account's cash-only score, the end date, creation date and the process that created the transaction.	Account - C&C
Case. One row is displayed for every case associated with the account.	The case's standard information.	Case - Main
Rebate Claim. One row is displayed for every rebate claim .	The rebate claim's description.	Rebate claim portal

WARNING:

The first 25 rows are displayed when this zone is initially built. If more rows exist, a **Get All** button appears. If you click this button, the system retrieves a maximum of 750 rows.

Account Financial History Zone

The **Account Financial History Zone** lists an account's financial events in reverse chronological order. You can use this grid to both view high-level information about these events and to transfer to the respective page in which an object is maintained.

NOTE:

Approximately a year and half is shown. This zone shows all financial transactions within 20 months of the latest financial transaction. This limitation exists to prevent this zone from becoming unmanageably long.

The following columns are displayed in the grid:

Arrears Date This is the date the event starts aging. This column will be blank if the FT has not started aging yet.

Financial Transaction Type This column indicates the type of financial event: Bill, Payment, Bill Cancellation, Pay Cancellation, Adjustment, and Adjustment (Cancel). If the event is related to an adjustment, the adjustment type's description is displayed instead of "Adjustment".

Current Amount This column shows the financial event's effect on the account's current balance.

Current Balance This column shows the account's current balance after the financial event.

Payoff Amount This column shows the financial event's effect on the account's payoff balance. **Payoff Amount** will be dimmed if it is the same as its **Current Amount**.

Payoff Balance This column shows the account's payoff balance after the financial event. **Payoff Balance** will be dimmed if it is the same as its **Current Balance**.

If you need to see more information about a specific financial transaction, press the go to button to transfer to the respective page in which the information is maintained.

FASTPATH:

For information about current and payoff balance, refer to [Current Amount versus Payoff Amount](#).

WARNING:

The first 25 rows are displayed when this zone is initially built. If more rows exist, a **Get All** button appears. If you click this button, the system retrieves a maximum of 750 rows.

Alert Zone

The **Alert Zone** is a grid that contains messages highlighting a variety of situations. Clicking on the hyperlink transfers you to an appropriate page. The following table lists the various alerts that may appear and the page to which you will be transferred if you click on the hyperlink. The table below lists alerts in alphabetical order, but it includes a column indicating the order in which the alert will appear.

NOTE:

You can create additional alert conditions. The following table contains those alerts supported in the base package. It is possible to highlight additional conditions by plugging-in the appropriate algorithm(s) on the [installation record](#). Refer to Count Customer Contacts of a Given Type (CC-NBR-VALID) and Count Pay Plans with a Given Status (PP BY STATUS) for examples of such algorithms.

Account alerts are implementation-specific. On [Account - Alerts](#), a user can define account-specific alerts that should be displayed whenever the account is selected. The [Alert Types](#) control table contains the possible alert messages.

Alert Text	Order	Description	Drill Down Transfers You To
Account alerts	6	Appears for each user-defined alert associated with an account.	Account - Alert
Account has Multiple Premises	24	Appears when the account has service agreements whose service points reference multiple premises	Control Central - Account Tree
Account SA(s) linked to Umbrella Agreement	41	Appears when the account has one or more service agreements linked to a non-canceled terms of service record for an umbrella agreement that is in effect on the current date.	Terms of Service - Main
Active Write Off Process	10	Appears when an account has an active write off process . Refer to How Are Write off Processes Cancelled for information describing when a write-off process is deactivated.	Write Off Process
Appointment Exists	37		Appointment

Auto-Pay Active: <i>auto pay method description</i>	25	Appears when the account has an automatic payment option effective on the current date. The auto pay method description (i.e. Direct Debit or Payment Advice) appears only if payment advice functionality is enabled. Refer to Payment Advices for more information on payment advice functionality.	Account - Auto Pay
Comment Exists On Account	5	Appears when a free-form comment has been entered for the account (on Account - Main)	Account
Field Activity Pending	19	Appears when any of the premise's service points have a pending field activity	Field Activity
Field activity type alert message	12	Appears when the premise has a service point with a completed field activity whose type has been marked with an alert message (refer to Field Activity Type)	Field Activity
Held Order Exists	32	Appears when the person has a held order .	Order
Installation dynamic alerts	42	You can install plug-in algorithms on the installation record that will create alerts (if given situations exist). Refer to Count Customer Contacts of a Given Type (CC BY TYPCL) and Count Pay Plans with a Given Status (PP BY STATUS) for examples of such algorithms	Varies by plug-in
Landlord Exists	27	Appears when a landlord is linked to the premise	Premise
Last Contact: <i>days old - user name who added the contact</i>	3	Appears when the person has a customer contact . The "days old" presents how old the contact is (based on the contact's date). The word Today is shown if the last contact was on the current date. The word Yesterday is shown if the last contact was on the current date - 1 day. If neither is applicable, the number of days old is shown.	Customer Contact
Multiple Financially Resp	26a	Appears when the account has more than one financially responsible person linked to it	Control Central - Account Tree

Non-cash Deposit	15	Appears when the account has non-cash deposits effective on the current date	Account - Deposit
n Open Contact(s) for Person	4	Appears if there are open customer contacts associated with the person. Refer to Customer Contacts Can Be Used As Case Files for more information.	Customer Contact
Pending Order Exists	31	Appears when the person has a pending order .	Order
Pending Proposal SA Exists	36	Appears when the account has a proposal service agreement in the pending state. Refer to Proposal SA State Transition for more information.	Service Agreement
Pending Quote Exists	34	Appears when the account has a pending quote. Refer to Quote Lifecycle for more information.	Quote
Pending SA Relationships	16	Appears when the account has SA relationships that are pending	SA Relationship
Pending Stop	18	Appears when there is a service agreement in the state of pending stop linked to the account. Refer to The Lifecycle Of A Pending Stop Service Agreement for more information.	Start/Stop
Person is linked to Multiple Accounts	22	Appears when the person has multiple accounts. A person's accounts are maintained on the Account - Person page.	Control Central
n Persons on Account	26c	Appears when the account has multiple persons linked to it. An account's persons are maintained on the Account - Person page.	Control Central - Account Tree
Premise has Multiple Accounts	23	Appears when the premise has that are linked to service agreements that are linked to different accounts.	Control Central - Premise Tree
Premise has n Child Premise(s)	40	Appears when the premise is defined as the parent premise for one or more premises. Refer to Define Premise Hierarchy for more information.	Premise Management
Premise is linked to Parent Premise	39	Appears when the premise defines a parent premise. Refer to Define Premise Hierarchy for more information.	Premise

Quotable Proposal SA Exists	35	Appears when the account has a proposal service agreement in the quotable state. Refer to Proposal SA State Transition for more information.	Service Agreement
Quote Awaiting Customer Response Exists	33	Appears when the account has a complete quote with a quote detail that references a quotable proposal SA. Refer to Quote Lifecycle for more information.	Quote
Reactivated SAs Exist	21	Appears when any of the account's service agreements exist in the state of reactivated (i.e., a financial transaction has been generated after the service agreement was closed). Refer to The Lifecycle Of A Service Agreement for more information.	Service Agreement
SA type alert message	13	Appears when the customer has a service agreement with an SA type that has been marked with an alert message (refer to SA Type - Details) Note that if the account in control central has more than one service agreement, pressing the drill down button will also launch the service agreement search dialog.	Service Agreement
SA type description and status of a non-billed budget service agreement	14	Appears for every pending start, pending stop, and active Non-Billed Budget that is linked to the account.	Non-Billed Budget Service Agreement
Seasonal Address Exists	38b	Appears if the account has a seasonal address and there is no seasonal address active on the current date.	Person - Correspondence Info
Seasonal Address Currently Effective (MM/DD - MM/DD)	38a	Appears if the account has an active seasonal address that is effective on the current date. The date range that the seasonal address is effective is included in the alert.	Person - Correspondence Info
Statement Construct Active	28	Appears if the person has an active statement construct	Statement Construct
Third Party Guarantor	26b	Appears when the account has a third party guarantor. An account's third party guarantors	Control Central - Account Tree

are maintained on the [Account - Person](#) page.

NOTE:

Legacy Alert Order. Certain system-generated alerts have been converted to algorithms that may be plugged-in on the [installation record](#). This implies that the order in which these alerts now appear might differ to the prior system-generated alerts order. If your implementation wishes to retain the legacy order for these alerts, the Use Legacy Alerts **Option Type** for the General System Configuration [Feature Configuration](#) must be defined with a value of Y, and the alert algorithms should not be plugged-in on the [installation record](#). If this option is set, then the alerts in the following table will be treated as system-generated alerts. These alerts are listed in alphabetical order, but a column indicating the order in which they will appear is included. Note that if both the feature option and alert algorithms are configured, these alerts may appear twice on the **Alert Zone**.

Alert Text	Order	Description	Drill Down Transfers You To
Cash-Only Account	11a	Appears when the account's cash-only score exceeds the cash-only threshold on the installation record. Refer to How are credit rating transactions created for information describing how a cash-only score is affected by various system and user events.	Account - C & C
Collection Process Active	8	Appears when an account has an active collection process . Refer to How Are Collection Processes Cancelled for information describing when a collection process is deactivated.	Collection Process
Collection Referral Active	9	Appears when the account has active collection agency referrals .	Collection Agency Referral
Credit rating: NNNN	11b	Appears when the account's credit rating falls below the credit rating threshold on the installation record or the account's CIS Division. Refer to How are credit rating transactions created for information describing how a customer's credit rating is affected by various system and user events.	Account - C & C
Life Support / Sensitive Load on Person	1	Appears when any of the account's persons has life support or sensitive load information	Person
Life Support / Sensitive Load on Premise	2	Appears when the premise has life support or sensitive load information	Premise - Misc.

Pending Start	17	Appears when there is a service agreement in the state of pending start linked to the account. Refer to The Lifecycle Of A Pending Start Service Agreement for more information.	Start/Stop
Severance Process Active	7	Appears when any of the account's service agreement has an active severance process Appears when an account has an active severance process . Refer to How Are Severance Processes Cancelled for information describing when a severance process is deactivated.	Severance Process

Applicable Campaigns Zone

The **Applicable Campaigns Zone** lists the campaigns that may be of interest to the customer. If you press a campaign's Add Order button, you will be transferred to the [Order transaction](#) where you can walk the customer through the campaign's provisions and determine if they are interested in its goods and services.

FASTPATH:

Refer to [The Big Picture Of Campaign Eligibility](#) for more information.

WARNING:

The first 25 rows are displayed when this zone is initially built. If more rows exist, a **Get All** button appears. If you click this button, the system retrieves a maximum of 750 rows.

Bill Graph Zone

The **Bill Graph Zone** illustrates the ending balance and new charges on each of the customer's historical bills.

NOTE:

Approximately a year and half is shown. This zone shows all bills within 20 months of the latest bill. This limitation exists to prevent this zone from becoming unmanageably wide.

For [balance-forward accounts](#), both ending balances and current charges are shown in the graph. For [open-item accounts](#), only the current charges are shown in the graph.

The following points describe unique features of this zone:

- If you hover the mouse over a bar in the graph, summary information about the bill will display.
- If you click on a bar in the graph, you will be transferred to the bill page with the respective bill displayed.

Billed Consumption Zone

The **Billed Consumption Zone** illustrates the amount of consumption on each of the customer's historical bills. Up to three units of measure (UOM) are shown for each bill. The system uses the graph UOM's defined on the SA types associated with the customer's active service agreements. If more than three graph UOM's are detected for a customer, the system uses those associated with the service agreement types with the highest bill print priorities.

The following points describe unique features of this zone:

- If you hover the mouse on a bar in the graph, summary information about the bill will display.
- If you click on a bar in the graph, you will be transferred to the bill page with the respective bill displayed.

NOTE:

Approximately a year and half is shown. This zone shows all bills within 20 months of the latest bill. This limitation exists to prevent this zone from becoming unmanageably wide.

Context Zone

The **Context Zone** contains basic information about the Person / Account / Premise on which you are working.

Person This part of the context area contains the person's standard information. Note, this information is formatted by a plug-in algorithm on the [installation record](#). Refer to the base package's person information algorithm (PERS-INFO) for an example. If you prefer different formatting logic, your system administrator should configure the system appropriately

Account ID This part of the context area contains the unique identifier of the account and the name of its main customer.

Adjacent to the account ID appears a "check digit". This is for information purposes only and is not needed to operate the system. Refer to the Description of Page section under [Account - Main](#) for a description of how "check digit" is calculated.

Below **Account ID**, the account's **Current Balance** and **Payoff Balance** are displayed. **Payoff Balance** will be hidden when it's the same as the **Current Balance**. Refer to [Current Amount versus Payoff Amount](#) for more information.

Aged Debt Bar If the account's **Current Balance** is greater than zero, a colored bar is displayed adjacent. This bar provides information about the age of the account's debt.

The number of segments that appear in this bar is dependent on the elements of the customer's aged balance. The following segments may appear:

- disputed debt (If you handle disputed debt as described in [Disputing Items](#)),
- new charges and debt between 0 and X days old (where X is the account's customer class's bill due days),
- debt between X to 30 days old,
- debt between 31 to 60 days old,
- debt older than 60 days

NOTE:

If you hover the mouse pointer over a segment of the bar, the respective amount of debt will appear. If you click on the arrears bar you will be taken to the [Account Financial History](#) page. Note that information about debt balances by age is not applicable to [open-item accounts](#).

Premise. This part of the context area contains the premise address. The address information is formatted by a plug-in algorithm on the [installation record](#). Refer to the base package's premise format algorithm (PREM-INFO) for an example. If you prefer a different format, your system administrator should configure the system appropriately

 (Start Button) Push this button if you want to start service for the account and the service isn't at a premise (e.g., a deposit). Refer to [The Big Picture Of Starting Service](#) for more information.

 (Stop Button) Push this button if you want to stop service for the account at the premise. Refer to [The Big Picture of Stopping Service](#) for more information.

Credit and Collections Info Zone

The **Credit and Collections Info Zone** is a grid that contains a variety of credit & collections-oriented events. Pushing the button adjacent to the information transfers you to an appropriate page. The following table lists the type of information that may appear in this zone and the page to which you will be transferred if you push the adjacent button.

Activity Label	What Is Displayed	Drill Down Transfers You To
Severance Process. <i>One row is displayed for every Active severance process linked to the account's service agreements.</i>	The severance process's description and create date/time	Severance Process - Main
Collection Process. <i>One row is displayed for every Active collection process linked to the account.</i>	The collection process's description and create date/time	Collection Process - Main
Write-off Process. <i>One row is displayed for every Active write-off process linked to the account.</i>	The write-off process's description and create date/time	Write-off Process - Main
Overdue Process. <i>One row is displayed for every Active overdue process linked to the account.</i>	The overdue process's standard information string (this is dynamic as is constructed by an algorithm)	Overdue Process - Main
Cut Process. <i>One row is displayed for every Active cut process linked to the account's service agreements.</i>	The cut process's standard information string (this is dynamic as is constructed by an algorithm)	Cut Process - Main
Pay Plan. <i>One row is displayed for every Active pay plan linked to the account</i>	The pay plan type's description and create date/time	Pay Plan - Main
Payment Arrangement. <i>One row is displayed for every non-cancelled, non-closed payment arrangement (i.e., service agreement with a special role of Payment Arrangement) linked to the account</i>	The service agreement's SA type description, start date and status	Payment Arrangement - Main

WARNING:

The first 25 rows are displayed when this zone is initially built. If more rows exist, a **Get All** button appears. If you click this button, the system retrieves a maximum of 750 rows.

Customer Information Zone

The **Customer Information Zone** is a grid that contains information about the current person and account. Pushing the button adjacent to the information transfers you to an appropriate page. The following table lists the type of information that may appear in this zone and the page to which you will be transferred if you push the adjacent button.

NOTE:

Rows are suppressed if the related data is blank for the person / account.

Label	What Is Displayed	Drill Down Transfers You To
Account ID	The account's unique identifier (i.e., account ID) is displayed	An account context menu has been provided (allowing you to drill to a variety of account-oriented pages)
Main Customer	The main customer's name. Note, the person's name is formatted by a plug-in algorithm on the installation record . Refer to the base package's name format algorithm (PERS-INFO) for an example. If you prefer different formatting logic, your system administrator should configure the system appropriately	A person context menu has been provided (allowing you to drill to a variety of person-oriented pages)
Set Up Date	The account's setup date	Account - Main
CIS Division	The account's CIS division	Account - Main
Customer Class	The account's customer class	Account - Main
Bill Cycle	The account's bill cycle	Account - Main
Current Credit Rating	The account's current credit rating	Account - C&C
Next Credit Review Date	The next date on which the account's debt will be reviewed by the account debt monitor . Refer to When Is An Account's Debt Monitored for more information.	Account - C&C
<i>A separate row is displayed for each characteristic linked to the account. Each row's label is the characteristic type's description. If the characteristic is future dated, the effective date enclosed in parentheses prefixes the description.</i>	The characteristic's value	Account - Characteristic
Auto Pay Source	The account's auto pay source	Account - Auto Pay
<i>A separate row is displayed for each miscellaneous person linked to the account. Each row's label is the person relationship type's description.</i>	The main name of the miscellaneous person	A person context menu has been provided (allowing you to drill to a variety of person-oriented pages)
Budget Plan	The account's budget plan	Account - Budget
<i>A separate row is displayed for each characteristic linked to the person. Each row's label is the characteristic type's description.</i>	The characteristic's value	Person - Characteristic
<i>A separate row is displayed for each telephone number linked to the person. Each row's label is the phone type's description.</i>	The telephone number	Person - Main
<i>A separate row is displayed for each identifier linked to the person. Each row's label is the ID type's description.</i>	The person identifier value NOTE: The system supports encryption for Person Identifier. If your implementation has configured the system to encrypt Person Identifier, the data will be displayed with a masked value; such as, *****.Refer	Person - Main

to [Encrypting Sensitive Data](#) for more information.

Email Address	The person's email address	Person - Miscellaneous
Service Provider.	The service provider's name and a description of the service provider's billing relationship as of the effective date.	SA Relationship - Main

WARNING:

This zone does not support [User Interface Masking](#). If your implementation masks any of the information that appears on this zone, you must disable it and implement a zone that will mask your data appropriately. The demonstration system provides a sample zone that your implementation can import and then customize if necessary; this zone's code is CI_CIMAP. To disable the base package zone simply deny access to its associated application service. You should only grant access to your new Customer Information zone.

Financial Information Zone

The **Financial Information Zone** is a grid that contains financial information related to the account. Clicking the hyperlink transfers you to the appropriate page. The following table lists the type of information that appears in this zone and the page to which you are transferred if you click the adjacent icon.

NOTE:

Rows are suppressed if the related data is blank for the person / account.

Label	What Is Displayed	Drill Down Transfers You To
Current Balance	The account's current balance. If the account's current balance is greater than zero, a colored bar is displayed adjacent. This bar provides information about the age of the account's debt. Refer to Context Zone for more information about this bar.	Clicking on the Arrears Bar or the hyperlink takes you to Account Financial History - Main
Payoff Balance	The account's payoff balance. It will only be displayed if the amount differs from the current balance.	Not applicable
Last Bill	The date and amount of the account's last bill along with its due date.	Bill - Main
Last Payment	The date and amount of the account's last payment.	Payment Event - Main
Previous Bill	The date and amount of the bill prior to the last bill for the account.	Bill - Main
Next Bill Date	The next date on which a bill is scheduled to be produced for the account (based on the account's bill cycle's schedule)	Not applicable

Pending Bill Exists	The date of the pending bill. This row only appears if there is a pending bill associated with the account	Bill - Main
Freezable Bill Segments	If freezable bill segments exist, this row contains the number of segments and their total amount.	Bill Segment - Main
Incomplete Adjustments	If incomplete adjustments exist, this row contains the number of adjustments and their total amount.	Adjustment - Main
Freezable Adjustments	If freezable adjustments exist, this row contains the number of adjustments and their total amount.	Adjustment - Main
Payment(s) Pending Upload	<p>Appears when the account has a pending payment staging record (i.e., the account has an external payment that has not been uploaded into the system). To prevent payments from being created and frozen before the actual payment is received, external payments are not uploaded into the system until their accounting date is reached.</p> <p>Note that the amount displayed represents the amount tendered for the account, but does not reflect how the payment may be distributed (i.e., the payment may be distributed to other accounts).</p> <p>For information about payment staging records, refer to Interfacing Payments from External Sources.</p>	Payment Upload Staging
Incomplete Payment(s)	<p>Appears when the account has payments that are incomplete. This row contains the number of payments and their total amount.</p> <p>Note, incomplete automatic payments that are pending distribution are not included in this alert as they are highlighted on the Auto Pay will be distributed on described below.</p>	Payment - Main
Payment(s) with Errors	Appears when the account has payments that are in error. This row contains the number of payments and their total amount.	Payment - Main
Freezable Payments)	If freezable payments, this row contains the number of payments and their total amount.	Payment Event - Main
Auto Pay will be created on	This row shows the date that the next auto pay will be created. This alert will appear after a bill is completed for an account on auto pay and when your installation option's Auto Pay Creation Option is Create on Extract Date. If the installation option is Create at Bill Completion, then the Autopay will be created immediately at bill completion time and no information is displayed here. Refer to How	Bill - Main

[And When Are Automatic Payments Created?](#)

for more information.

Auto Pay will be distributed on	This row shows the date that the next auto pay will be distributed. This alert will appear after a bill is completed for an account on auto pay and when your installation option's Auto Pay Creation Option is Create on Extract Date. If the installation option is Create at Bill Completion, then the payment for the Autopay will be created immediately at bill completion time and no information is displayed here. Refer to How And When Are Automatic Payments Created? for more information.	Payment Event - Main
---------------------------------	--	----------------------

Premise Information Zone

The **Premise Information Zone** is a grid that contains information about the current premise. Pushing the button adjacent to the information transfers you to an appropriate page. The following table lists the type of information that may appear in this zone and the page to which you will be transferred if you push the adjacent button.

NOTE:

Rows are suppressed if the related data is blank for the premise.

Label	What Is Displayed	Drill Down Transfers You To
Premise Information	The premise's address. Note, the address information is formatted by a plug-in algorithm on the installation record . Refer to the base package's premise format algorithm (PREM-INFO) for an example. If you prefer a different format, your system administrator should configure the system appropriately	A premise context menu has been provided (allowing you to drill to a variety of premise-oriented pages)
CIS Division	The premise's CIS division	Premise - Main
A separate row is displayed for each characteristic linked to the premise. The label in each row is the respective characteristic type's description.	The characteristic's value	Premise - Characteristic
Landlord	The name of the premise's landlord	Landlord Agreement
Service Point Information. <i>Note, a separate row is displayed for each service point linked to the premise</i>	The service point's type and service cycle (if specified)	A service point context menu has been provided (allowing you to drill to a variety of service point-oriented pages)
<i>Device This row is displayed if a device is currently installed at the service point. If so, this row's label is indented and displayed beneath the related service point</i>	The device's badge number, device type, installation date, and status.	A meter configuration context menu has been provided (allowing you to drill to a variety of meter configuration-oriented pages)
Next Meter Read. <i>This row is displayed if the service point references a service cycle.</i>	The next scheduled meter read date and an indication of the service point's <i>service cycle</i>	No drill down is available

Item Information This row is displayed if an item is currently installed at the service point. If so, this row's label is indented and displayed beneath the related service point.

The item's type, badge number, and status.

An item [context menu](#) has been provided (allowing you to drill to a variety of item-oriented pages).

SA Premise List Zone

The **SA Premise List Zone** contains a row for each non-cancelled, non-closed service agreement linked to the account. The **Premise** (if any), **Current Balance**, **Payoff Balance**, and **SA Information** is displayed for each service agreement.

The service agreements appear in the following order:

- Service agreements linked to the premise on which you're working appear first.
- Next appear service agreements linked to the account that don't have a premise (deposits, charitable contributions, etc.).
- Following this are the remaining service agreements linked to the account.

NOTE:

Dimmed Payoff Balance. A service agreement's **Payoff Balance** will be dimmed if it is the same as its **Current Balance**. Refer to [Current Amount versus Payoff Amount](#) for more information.

WARNING:

The first 25 rows are displayed when this zone is initially built. If more rows exist, a **Get All** button appears. If you click this button, the system retrieves a maximum of 750 rows.

Service Credit Membership Zone

The **Service Credit Membership Zone** contains a row for each pending and active [service credit membership](#) linked to the account. It will also show any inactive membership that contains a balance. The **Service Credit Membership Type**, **Membership Status** and **Balance** (if applicable) are displayed for each membership.

Scheduled Payments Log

This zone displays an account's pending payments. It includes the following

- Pending one time payments initiated from a third party payment processing system.
- Pending one time payments initiated from web self-service
- Pending bill-related automatic payment records
- One time payments in Error that are not succeeded by a Pending or Completed one time payment

Refer to [Third Party Payment Processing](#) for more information on third party payment processing.

Timeline Zone - Account Info

If your implementation team has configured one or more timeline zones, they may be visible on this page. Timeline zones show when significant events have occurred in the past and when significant events will occur in the future. For example, a timeline can show when payments and bills have been received for a customer.

Refer to [Timeline Zone](#) for a detailed explanation of how a timeline zone displays its information and other functionality that it supports.

Refer to [Configuring Timeline Zones](#) for how to add and change timeline zones.

Control Central - Customer Information

Once [Control Central - Main](#) has a person context, you can navigate to this page to view an overview of the related persons, customer contacts, accounts, premises, and service agreements linked to the account.

NOTE:

User configurable. Refer to [Each User Can Customize Which Zones Appear](#) for information about how to configure which zones appear.

Description of Page

NOTE:

Navigation hint. The Go To Control Central option on the person context menu navigates to this page.

A mouse with a roller is useful. This page can extend vertically past the normal desktop boundary. You will find that a mouse with a "roller" will facilitate navigating through the page.

The contents of this section describe the zones that are available on this portal page.

Communication History Search

Search Fields:

The following options allow you to search for and find the desired communications:

- **Search By** (dropdown) allows you to specify the type of communication that you want to find. You can search for Customer Contacts, Notifications from Oracle Utilities Notification Center and Lead Event logs, or all communications, which combine the previous two.
- **Start Date** and **End Date** allow you to set a targeted range of communications.
- **Search By Context** (dropdown) allows you to specify whether the communication is associated to the Person, Account, or Premise.
- **Hide Notification Logs** allows you to display the search results with or without the log entries.

NOTE: The Hide Notification Logs option displays when applicable to the selected Search By option.

Results Grid:

The following details are displayed for each communication:

- **Date / Time:**
 - For a customer contact related entry, the Customer Contact Date / Time for the communication
 - For lead / lead event related entries, the Log Date / Time where the Log Type is Notification for the communication
- **Details:**

- For a customer contact related entry, the Contact Class Description / Contact Type Description is displayed
- For lead / lead event related entries, the Log Messages for both the lead / lead event for the communication is displayed. There will be one entry for the lead and another for the lead event. If the lead / lead event created a customer contact for a communication, then an entry for the customer contact will also exist.
- **Related Object:**
 - For a customer contact related entry, a hyperlink to the customer contact record
 - For lead / lead event related entries, there will be one entry for the lead and another for the lead event.
 - For the lead related entry, a hyperlink to the lead related to the communication
 - For the lead event related entry, a hyperlink to the lead event related to the communication

Person Tree Zone

The [tree](#) in this zone shows a great deal of information including:

- All accounts linked to the person in context. Refer to [Understanding The V](#) for more information.
- Customer contacts linked to this person.
- The [hierarchy](#) of parents and children linked this person.
- All aliases linked to this person.

You can use this tree to both view high-level information about these objects and to transfer to the respective page in which an object is maintained.

Active Account Summary Zone

The **Active Account Summary Zone** lists all accounts related to the person in context where they are the main customer on the account. In addition, accounts linked to this person's [children](#) also appear in this zone, and if a child has children, the grandchildren's accounts are included. In fact, the system will look for accounts up to five levels deep (meaning that the great, great grandchildren's accounts will be included in this zone).

NOTE:

Only accounts linked to child persons with a financial relationship are shown. When you set up a [customer hierarchy](#), you can define both subsidiaries and "key contacts" (i.e., individuals that you contact at a company). As described above, this zone will include accounts related to these subsidiaries and key contacts. However, you might not want to include the personal accounts related to the key contacts in this zone. You can control which accounts appear in this zone when you set up a hierarchy. You do this by turning on the Financial Relationship switch for those [persons](#) whose accounts should be included.

The following columns are displayed in the grid:

Account Info This column contains the standard account information.

Current Balance and **Arrears** This column contains the account's current balance. If the account's current balance is greater than zero, a colored bar is displayed in the **Arrears** column. This bar provides information about the age of the account's debt. Note that information about debt balances by age is not applicable to [open-item accounts](#). Refer to [Context Zone](#) for more information about this bar.

Last Billed Info This column contains information about the last completed bill sent to the account.

Last Contact Info This column contains information about the last customer contact associated with the account's main customer.

Timeline Zone - Customer Info

Your implementation may have configured this page to show one or more timeline zones. Refer [Timeline Zone - Account Info](#) for a description of how to use these zones.

Control Central - Account Tree

Once [Control Central - Main](#) has an account context, you can navigate to the **Account Tree** to see an overview of the persons, premises, and service agreements linked to the account.

Description of Page

This page is dedicated to a [tree](#) that shows the various objects linked to an account. You can use this tree to both view high-level information about these objects and to transfer to the respective page in which an object is maintained.

Control Central - Premise Tree

Once [Control Central - Main](#) has a premise context, you can navigate to the **Premise Tree** to see an overview of the accounts, service points, and service agreements linked to the premise.

Description of Page

This page is dedicated to a [tree](#) that shows the various objects linked to a premise. You can use this tree to both view high-level information about these objects and to transfer to the respective page in which an object is maintained.

Control Central - Bill/Payment Tree

Once [Control Central - Main](#) has an account context, you can navigate to the **Bill/Payment Tree** to see an overview of the financial transactions linked to the account.

Description of Page

This page is dedicated to a [tree](#) that shows the account's bills and payments. You can use this tree to both view high-level information about these objects and to transfer to the respective page in which an object is maintained.

For [balance-forward accounts](#), bill nodes contain the balance presented on the respective bill, and pay nodes contain the amount of the respective payment. However, for [open-item accounts](#), the tree behaves differently:

- The amount on bill nodes is equal to the sum of the current charges, adjustments and corrections on the bill.
- Each bill or payment will contain an indication if all of its financial transactions are fully matched. If not, the node will become red to highlight that unmatched financial transactions exist.
- If a bill or payment node is expanded, a summary of the match status of its financial transactions is shown.
- Credit and correction notes appear as separate nodes.

Control Central - Payment Agreements

Once [Control Central - Main](#) has an account context, you can navigate to the **Payment Agreements** page to see an overview of the account's payment arrangement requests and/or pay plans.

The contents of this section describe the zones that are available on this portal page.

Payment Arrangement Requests

This zone shows the account's in-progress and finalized (e.g. granted, denied, canceled, etc.) payment arrangement requests.

You can use this zone to: view high-level information about the payment arrangement request, navigate to the **Payment Arrangement Request** or start a payment arrangement request.

The **Broadcast** icon on each row displays the [Payment Arrangement Request Details](#) zone that shows summary information about the payment arrangement request.

The **New Payment Arrangement** action located at the header of this zone is used to start a payment arrangement request.

Refer to this zone's embedded help for information on other available actions.

Payment Arrangement Request Details

This zone is displayed when a Payment Arrangement Request is broadcast from the [Payment Arrangement Requests](#) zone.

It shows key information about the selected payment arrangement request.

Pay Plan Tree

This zone shows the pay plans linked to an account. It displays both current and past (expired) pay plans.

You can use this tree to both view high-level information about these objects and to transfer to the respective page in which an object is maintained.

How To Add A New Customer From Control Central

There are three ways to add a new customer from control central:

- You can add a new customer by invoking the [Person](#) and [Account](#) pages from the Menu dropdown. This is not the recommended approach, as it requires several screen interactions; either of the following approaches is preferable.
- If your team has set up sales and marketing campaigns, you can use the [order](#) transaction to add a new customer. Refer to [Order User Interface Flow](#) for more information. Refer to [Sales & Marketing](#) for background information about sales and marketing campaigns.
- Adding a Person from Control Central. You navigate as follows:
 - You start from [Control Central - Main](#). On this page, you determine if the customer already has an account. If so, select it and you're done. If not, proceed to the next step.
 - Click the + button adjacent to the Name field to transfer to [Person - Main Information](#) page (with the name you entered already defaulted). Use the Person pages to record all relevant information about the new customer.
 - Enter the customer's names, phone numbers, and IDs. Click Save (or press ALT+S) to add the person and account. The value of **Add Account and Start Service** is defaulted to "on" and the **Customer Class** defaults based on the

Person Type. This means that when you click save the following will happen: a new person is added, a new account is added, the new person is linked to the new account, and you will be automatically transferred to [Start/Stop](#) where you can start service. (**Note:** This is the default behavior of the system. However, an implementation can define different functionality by setting up a [customer information options](#) feature configuration.

NOTE:

Default. When the system links the person to the account, it defaults the relationship type from the installation options. A different relationship type can be defined for persons versus businesses on the installation record.

If you need to tinker with information on the account, transfer to account maintenance (use the context menu) and make any necessary changes.

Maintaining The V

As described in [Understanding The "V"](#), the "V" objects are those that form the core of your business processes. In this section, we describe the pages that maintain these objects.

NOTE:

Start/Stop Also Maintains The "V". The [Start/Stop Pages](#) also maintain many of the objects in the "V". For example, service agreements are created behind-the-scenes when you start service for a customer. This means you won't have to use most of the pages described in this section as part of your day-to-day activities. Rather, they exist in case you need to override what the system automatically set up for you.

Maintaining Persons

On the person page, you define demographic information about your customers and every other individual or business with which your company has contact. The topics in this section describe the person page.

FASTPATH:

For more information about persons and their place in the "V", refer to [Understanding The "V"](#). For more information about how most persons are added, refer to [How To Add A New Customer From Control Central](#). For more information about how a person is required to set up a customer, refer to [Customer Overview](#).

Person - Main Information

The Main page contains core person information like names, telephone numbers, and forms of identification. Open this page using **Menu > Customer Information > Person > Search**.

Description of Page

Person Information contains basic information about the person. These values only appear after the person exists in the database. The **ID** is a system-assigned random number that stays with a person for the life of the system.

NOTE:

Formatting is performed by a plug-in. The format of **Person Information** is controlled by a plug-in algorithm on the [installation record](#). Refer to the base package's person information algorithm (PERS-INFO) for an example. If you prefer different formatting logic, your system administrator should configure the system appropriately.

The following information may be recorded about a person:

Person/Business indicates if the entity is a person or a business. Valid values are: Person, Business. This value controls how the person's primary name is validated.

Life Support / Sensitive Load indicates if the person has life support or sensitive load equipment. Valid values are: LS/SL (i.e., the person has life support / sensitive load equipment), None. If the customer has LS/SL equipment, make a note of the type of equipment in the **Life Support / Sensitive Load Notes**.

A premise can also have life support / sensitive load information. If the equipment is physically linked to the premise (e.g., a hospital has life support equipment), you should NOT specify the life support information on the person. Rather, transfer to [Premise - Misc](#) and specify life support information on the premise.

NOTE:

Alert and C&C. If the base package's C1-LSSL-PER algorithm is enabled on the installation record, and life support / sensitive load information is specified, an alert will appear when the person is displayed on control central. In addition, if a person has life support or sensitive load equipment, it is possible for a different credit & collection severance process to be kicked off if the person's account associated has overdue debt. Refer to [Designing Your Severance Procedures](#) for more information.

Person Names are used by [Control Central](#) to look for accounts and persons. In addition, a person's primary name is the addressee on the person's bill unless overridden by the Override Mailing Name (maintained on the **Misc** tab). The following fields display:

- Use **Name Type** to indicate if the name is an Alias, Alternate Representation, Doing Business As, Legal, or Primary name. Note, for new persons, a value of Primary is defaulted. The values for the name type field are customizable using the Lookup table. This field name is NAME_TYPE_FLG
 - Use **Person Name** to define the person's name. Note well, the name is case sensitive.
-

NOTE:

Alternate representations of a person's name. You would use an Alternate Representation for a person's name when you have an alternate ways to define the person's primary name. Alternate representations are typically used in countries that use multiple character sets (e.g., the Primary name is entered in Chinese, the Alternate Representation is entered in English). When a person has an alternate name, both the main and alternate names can be used to search for a person. The Alternate Representation **Name Type** only appears if you have enabled alternate names on the installation record. Refer to the description of the Alternate Representation field under [Installation - Main](#) for more information.

Validation and formatting are performed by plug-ins. The validation that is applied to **Person Name** (e.g., a comma separating the last and first name - Smith,Patricia) is controlled by a plug-in algorithm on the [installation record](#). More than one algorithm can be plugged into this plug-in spot. Algorithms plugged into this plug-in spot can also perform formatting such as removing special characters that your implementation's business rules do not allow in person names. Other algorithms can be configured to remove or replace text.

- The **Do Not Format** switch can be used to bypass any person name formatting done by the algorithms described above. Validation such as requiring name separator is still applied, but no further formatting is applied. Setting the switch only applies while the record is being saved and is then reset. The switch is reset because the formatting is only applied when the record is subsequently changed. This switch is only shown if the Enable Person Name Format Bypass **Option Type** on the Customer Information Options [Feature Configuration](#) has been enabled

NOTE: The Person Phone grid appears when the Legacy Person Phone and Email **Option Type** on the Customer Information Options [Feature Configuration](#) has been enabled.

Person Phone numbers are used by [Control Central](#) to look for accounts and persons. The following fields display:

- **Phone Type** indicates the type of phone number, e.g., Home, Mobile, Business, ...
- Use **Phone Number** to define the telephone number. Enter the telephone number in the format described by the **Phone Format**.

NOTE:

Formatting is performed by a plug-in. The format that is applied to a **Phone Number** is controlled by the algorithm that is plugged in on the respective [Phone Type](#). If you prefer a different format, your system administrator should configure this algorithm appropriately.

- Enter the **Extension**, if any, of the telephone number.

Person Contacts provide a central location to capture contact information such as phone numbers and email addresses. Any contact information can be captured. Person Contacts are used on contact preferences for notifications.

While person contacts can be used in lieu of a person phone and all system processes such as start/stop and orders support person contacts, your implementation may still opt to use person phone. Functionality has been provided to create and maintain person contacts from person phone records. When a person contact type is associated with a phone type, the person contact cannot be deleted nor can the fields maintained via person phone be edited. Refer to [Maintaining Person Contact via Person Phone](#) for more information.

Person contacts can also be edited or created from the Account Contact Information Zone. (*See [Account - Account Portal](#) for more information.*)

- **Contact Routing** represents a general grouping of person contacts such as email or phone. It is displayed on this page, and is defined on the person contact type.

NOTE: Contact Routings of type whose Contact Routing type is *Self Service User* can be viewed here and not elsewhere in the system. Furthermore, they can be viewed, but not edited, added, or deleted.

- **Person Contact Type** indicates the type of contact such as, home phone, cell phone, or work email.
- **Contact Information** contains the specific contact information such as, the phone number or email address. Enter the contact information in the format described.

NOTE:

Formatting is performed by a plug-in. The format that is applied to **Contact Information** is controlled by the algorithm that is plugged in on the respective person contact type (refer to [Setting Up Person Contact Types](#) for more information). If you prefer a different format, your system administrator should configure this algorithm appropriately.

- Enter the **Extension**, if any, of the contact information. (This field is only active when the contact's contact routing is phone or fax.)
- The **Primary** switch must be set for exactly one person contact for each contact routing.
- **Do Not Disturb (From)** and **Do Not Disturb (To)** indicate the times when a person contact should not be used. (**Note:** these fields are active when the Person Contact Type's Allow Do Not Disturb information is set to *Optional*.)
- **Contact Status** indicates the option contact's status. The initial status can be defaulted from the Person Contact Type. The status can be manually maintained, as appropriate. (**Note:** This dropdown is enabled when the Person Contact Type allows Status to be used. It is also disabled when the person contact type's status is configured to be controlled by a process such as an Opt-In process.) See [Person Contact Status Can Be Controlled By A Process](#) for more information.

- **Opt-in** provides functionality to initiate an opt-in process for person contact types configured to support opt-in. This is used to obtain permission to use the person contact type to send notifications. (Note: The functionality on this page is not the primary way of initiating an opt-in process.) See [Person Contact Status Can Be Controlled By A Process](#) for more information about Opt-In Processes.
- **Active/Inactive** defaults to Active. Most contact preferences will remain active. When the contact information changes, the information on the existing contact should be updated.

WARNING:

It is strongly recommended that existing contacts are updated whenever possible such as when a person's phone number or email address changes. When a person no longer has a contact such as an alternate phone number, the contact should be deleted. Inactive should only be used when the person contact cannot be deleted because it is referenced on another object such as a contact preference.

- **Contact Nickname** (*display only*) if your implementation is using self-service, users can assign nicknames to contacts and they are shown here.

A **Person's ID's** have several uses:

- They are used by [Control Central](#) when you look for a customer / premise based on their ID.
- They are used to highlight potential duplicate persons.
- [Control Central](#) displays a person's **primary** identification in the search results area to help a user identify the customer when multiple customers match the search criteria.

NOTE:

Person ID may be required or optional. The person ID usage flag on the [installation record](#) indicates whether at least one id for a person is required or optional.

NOTE: The system supports encryption for Person Identifier. If your implementation has configured the system to encrypt Person Identifier, the data will be displayed with a masked value; such as, *****.Refer to [Encrypting Sensitive Data](#) for more information.

The following fields are used to define a person's ID(s).

- Turn on **Primary ID** for the piece of **ID** that is the primary means of identifying the customer.
- Indicate the **ID Type**. The **ID Type** defaults from the [Installation Record](#) based on the **Person Type** (Person versus Business).
- Enter the identification number in the adjacent fields. Please note that if the **ID Number** should be formatted (e.g., dashes in an American social security number), you do not have to enter the dashes. Rather, you can enter the information as a contiguous value and the system will format this for you. The format is shown in the adjacent **Identifier Format** column.

NOTE:

Formatting is performed by a plug-in. The format that is applied to an **ID Number** (e.g., dashes in an American social security number) is controlled by the algorithm that is plugged in on the respective **ID Type**. If you prefer a different format, your system administrator should configure this algorithm appropriately.

If you want to add an account for the person when you save the person information, turn on **Add Account and Start Service**. When this switch is on, you must also define the new account's **Customer Class**. If this information is specified, the system creates a new account and links the person to the account using the relationship type from the installation options. In addition, you will be transferred to [Start / Stop](#) where you can start service for the newly added account.

If you have set the Installation Option CIS Division Control flag, you must first define the new account's **CIS Division**. The values are restricted to the user's CIS Division(s). See [Users and CIS Division](#) for more information. The value is defaulted to user's primary CIS Division. The new account's Customer Class must then be defined.

NOTE:

Default note. The account's customer class defaults from the [Installation Record](#) based on the **Person Type** (Person or Business). If shown, the customer class defaults first from the CIS Division and then from the Installation Record, each based on the **Person Type** (Person or Business)

A message appears in the lower right corner of the page that describes the number of accounts the person has. You can click the adjacent go to button to transfer to [Control Central - Customer Information](#) on which all of a person's accounts appear.

Person - Correspondence Information

This page contains information that may be used to address [bills](#), [letters](#), [quotes](#) and [statements](#). Use **Menu > Customer Information > Person > Search** and navigate to the **Correspondence Info** page.

Description of Page

If the person does not want their primary name (defined on the Main page) used on [bills](#), [letters](#), [quotes](#) and / or [statements](#), specify the desired name in **Override Mailing Name 1, 2, and 3**.

Specify the **Override Mailing Address** fields if the person wants their bills, letters, quotes, and / or statements sent to an address other than their service addresses (for example, a post office box). In addition, if the person's account doesn't already indicate that the person's mailing address should be used, you must update this person's account(s). This information resides in the Address Source field on [Account - Person](#).

NOTE:

Both the [Start/Stop](#) and [Order](#) transactions allow you to update the person's **Override Mailing Address** and their account's address source using a single transaction.

Address isn't everything. In addition to defining the person's **Override Mailing Address**, there may be additional tasks you must perform in order to route information to this address. Refer to the following links for more information: [where are bills sent](#), [where are letters sent](#), [where are quotes sent](#) and [where are statements sent](#).

If you enter an **Override Mailing Address**:

- The **Country** defaults from your [installation options](#).
- The address constituents may differ depending on the **Country**. Refer to [Defining Countries](#) for more information on the address constituents.
- If you have set up [postal defaults](#), the system will default the address constituents when you tab out of the postal code.
- The Validate button on the person page will only be available if you have set the Allow Address Validation option type to Y on the General System Configuration feature configuration. Once clicked, the Address Validation Script on the General System Configuration feature configuration will be invoked to validate the entered address. Refer to [Implementing Address Validation](#) for more information.

Specify the customer's **Email Address** if you communicate with the customer via Email. In addition to defining the person's **Email Address**, your correspondence routing software must support sending the information via Email. Refer to the following links for more information: [where are bills sent](#), [where are letters sent](#), [where are quotes sent](#) and [where are statements sent](#).

NOTE: The Email Address field appears when Legacy Person Phone and Email **Option Type** on the Customer Information Options Feature Configuration has been enabled.

Define the **Language** in which the person prefers their bills and correspondence printed.

NOTE:

Default note. The person's language defaults from [Installation Options - Person](#).

FASTPATH:

Refer to [Customer Language](#) for more information on options for supporting multiple languages for your customers.

Define the person's **Time Zone** preference if it is different from the installation's time zone. Refer to [Installation Options – Framework, Main Page](#) for more information. The time zone appears as part of the display anywhere the Do Not Disturb start and end information is displayed; for example, in the Person Portal or Account Portal.

NOTE: Default Note. The Time Zone defaults to blank, which indicates that the installation's time zone will be used.

The **Seasonal Addresses** scroll is only used if the person wants their correspondence sent to an alternate address during predefined periods. For example, the customer may want their bills sent to their vacation cottage during the summer. Please be aware of the following:

- Seasonal addresses will only be used if the customer's bills, statements, quotes, and / or letters are routed via the postal service. For example, if you route bills to the customer via Email, the seasonal address will never be used to route bills to the customer. Refer to the following links for more information: [where are bills sent](#), [where are letters sent](#), [where are quotes sent](#) and [where are statements sent](#).
- You don't have to specify a seasonal address for every part of the year. For example, if the customer wants their bills sent to their service address except during the summer, you need only enter a seasonal address for the summer.
- You can enter a seasonal address with or without an **Override Mailing Address**. If an **Override Mailing Address** is not specified, the person's correspondence will be addressed as per the instructions on the person's account(s). These instructions reside in the Address Source field on [Account - Person](#).
- You can enter multiple seasonal addresses if the customer so desires.
- The **Seasonal** period is defined in the two adjacent fields. The first field contains the day and month when the season starts; the second field contains the day and month when the season ends. The day and month should be entered in the format defined in your [display profile](#).
- The **Status** of the address must be Active. You can set the status to Inactive if you want a seasonal address ignored (alternately, you can just remove the seasonal address).
- The **Country** defaults from your [installation options](#). The address constituents may differ depending on the **Country**. Refer to [Defining Countries](#) for more information on the address constituents.
- If you have set up [postal defaults](#), the system will default the address constituents when you tab out of the postal code.

Person - Characteristics

The characteristics page contains information that describes miscellaneous information about the person. Use **Menu > Customer Information > Person > Search** and navigate to the **Characteristics** page.

Description of Page

NOTE:

You can only choose characteristic types defined as permissible on the person record. Refer to [Setting Up Characteristic Types & Their Values](#) for more information.

The following fields display:

Effective Date Define the date on which the characteristic becomes effective. The effective date defaults from the [Installation Record](#).

Characteristic Type Indicate the type of characteristic.

Characteristic Value Indicate the value of the characteristic.

Person - Persons

This page is used to define this person's relationship with other persons. For example, if the person being maintained is a conglomerate, you can define its subsidiaries on this page. Refer to [How To Set Up Customer Hierarchies](#) for more information about hierarchies.

NOTE:

You're defining "child relationships". It's important to understand that the persons being defined on this page's grid should be thought of as "children" of the person on the top of the page.

Children may have children. It's possible for one of the children to have children itself (for example, if you have a situation where a subsidiary of a conglomerate itself has subsidiaries). To define a child's children, simply display the child person on this page and then define its children.

Equal relationships. It's possible to link persons where no hierarchy is implied by the relationship (e.g., spouses). There are two ways to do this: 1) you can nominate one spouse as the "parent" and the other as the "child" or 2) you can define the spousal relationship for both persons (i.e., you would define Robert Chopin as the husband of Jeanette Chopin, and Jeanette Chopin as the wife of Robert Chopin). If you choose the latter approach, a recursive relationship will exist.

WARNING:

If your organization enters multiple levels of person, we want to note that we do not prevent recursive relationships. This means that you could set up a nonsensical situation where person 2 is a child of person 1 and person 1 is a child of person 2.

Use **Menu > Customer Information > Person > Search** and navigate to the Persons page.

Description of Page

The grid contains the "children" associated with the "parent" person who is defined at the top of the page. The following fields display:

Child Person This is the unique identifier of the "child" person. This person's main name appears adjacent.

Child Information An informational message appears to highlight if the child person itself has children. You can click the corresponding go to button to view the child's children.

Relationship Type Indicate the type of relationship between the parent and the child person.

Start Date Indicate the date on which this relationship began. This field defaults from the [Installation Record](#).

End Date If the relationship expires, indicate the date the relationship stops.

Financial Relationship Turn on this switch if the child person has account(s) and information about these account(s) should be displayed when the parent person's hierarchy is displayed in the [Active Account Summary Zone](#).

Person - Person Portal

Select **Menu > Customer Information > Person > Search** and navigate to the **Person Portal** page to view additional information associated with a Person.

Depending on your implementations requirements, you may define additional zones to appear on this Portal.

The contents of this section describe the zones that are available on this portal page.

General Information

Person ID, Person Info are displayed.

Customer Notification Preferences

The Customer Notification Preferences Zone displays notification preferences for the customer in context.

The following table lists the notification types that may appear in this zone and the page to which you will be transferred to if you click on a hyperlink (if applicable).

Type	What Is Displayed
Bill Routing for each account the person receives a copy of the bill. Type hyperlink navigates you to the Account – Persons tab	Customer Information: Customer Information hyperlink navigates you to the Account Contact Method: Bill Route Type specified on the account Contact Information: Contact details for the Bill Route Type defined for the account
PPB New Charge if the person has an active prepaid biller. Type hyperlink navigates you to the Prepaid Biller Task	Customer Information: Customer Information hyperlink navigates you to Prepaid Biller Task Contact Method: Notification Preference for how the customer will be notified each time a new charge is calculated (specified on the Prepaid Biller Task) Contact Information: Contact details for the new charge Notification Preference
PPB Payment Request if the person has an active prepaid biller. Type hyperlink navigates you to the Prepaid Biller Task	Customer Information: Customer Information hyperlink navigates you to Prepaid Biller Task Contact Method: Notification Preference for how the customer will be notified when their prepaid balance is less than the required minimum balance (specified on the Prepaid Biller Task) Contact Information: Contact details for the payment request Notification Preference
Quote Routing for each account where the person receives a copy of quotes. Type hyperlink navigates you to the Account – Persons tab	Customer Information: Customer Information hyperlink navigates you to the Account Contact Method: Quote Route Type specified on the account Contact Information: Contact details for the Quote Route Type defined for the account
Statement Routing for each statement the person will receive. Type hyperlink navigates you to the Statement Construct – Main tab	Customer Information: Customer Information hyperlink navigates you to Person Contact Method: Statement Route Type specified on the statement construct Contact Information: Contact details for the Statement Route Type defined for the statement construct for each statement

Self-Service Notification Preferences

This zone displays active notification preferences for the customer in context and is only applicable if your implementation integrates with [Oracle Utilities Customer Self Service](#).

The applicable notification types (self-service task types) are defined on the [Self-Service Integration master configuration](#).

The following details are displayed for each active notification task (self service task) and the page to which you will be transferred if you click on a hyperlink (if applicable):

- Notification Task Information – Summary information for each of the customer’s active notification tasks. The hyperlink navigates you to the notification task (self-service task).
- Account Info – Details of the account linked to the notification task (self-service task). The hyperlink navigates you to the account.
- CSS Web User – End customer’s User ID supplied by Oracle Utilities Customer Self Service when the customer registers for the notification task (self-service task).

- Delivery Types – List of customer’s preferred communication channels specified on the notification task (self-service task).

Self Service Payment Options

This zone provides the ability to add, edit, and delete payment options used in customer self-service. This information is only applicable if your implementation integrates with [Oracle Utilities Customer Self Service](#).

Refer to the zone help for more details.

Maintaining Accounts

The account record contains information that controls billing and collection processes. You should only need to use this page if you need to fine-tune the information that the system has set up by default because:

- Most accounts are created when you [add a new person](#) or when you [complete an order](#) for a new customer.
- Many fields are populated behind-the-scenes as part of the [service activation process](#).

The topics in this section describe the pages on which account related information is maintained.

FASTPATH:

For more information about accounts and their place in the "V", refer to [Understanding The "V"](#).

Account - Main Information

The Main page contains core account information. Open this page using **Menu > Customer Information > Account > Search**.

Description of Page

The primary name of the **Account's** main customer and the **Account ID** are displayed on every tab in this page. These values only appear after the account exists on the database. The **Account ID** is a system-assigned random number that stays with an account for life.

NOTE:

Formatting may be performed by a plug-in. The basic information about an account that appears at the top of this page (and on many other pages in the system) may be formatted by a plug-in algorithm on the [installations record](#). Refer to the base package's account information algorithm (C1-AC-INFO) for an example. If you prefer different formatting logic, your system administrator should configure the system appropriately.

A "check digit" is displayed adjacent to the account ID. This is for information purposes only, and is not needed to operate the system. The following points describe how the check digit is calculated for an Account ID equal to 0011883422

- Calculate the sum of the first and every alternate digit in the account id. $A = 14 = 0+1+8+3+2$
- Calculate the sum of the second and every alternate digit in the Account ID and multiply by 2. For example, $B = 30 = (0 + 1 + 8 + 4 + 2) * 2$
- Add A and B. For example, $C = 44 = 14 + 30$
- Count the number of digits used to calculate B that are greater than 4. For example, $D = 1$ since only 8 is greater than 4.
- Multiply D by 9. For example, $E = 9 = 1 * 9$
- Subtract E from C. For example, $F = 35 = 44 - 9$

- Subtract the units position of F from 10 to find the check digit. For example, check digit = 5 = 10 - 5 (5 is subtracted from 10 because F = 35 and there the units position is 5).

NOTE:

Technical note. The above is calculated in the common routine called CIPCACDN .

Set Up Date is the date the account was initially set up. This is purely informational.

Currency Code defines the currency in which the account's financial transactions are expressed. All rates and payments associated with this account must be denominated in this currency.

NOTE:

Default note. The currency defaults from the [Installation Record](#) and may be overridden here.

Customer Class plays a part in:

- If and when a customer is subject to late payment charges.
 - The account's default collection class and when the account debt monitor reviews an account. Refer to [The Big Picture of Credit & Collections](#) for more information about how and when an account's debt is reviewed.
 - And several other functions. Refer to and [Setting Up Customer Classes](#) for more information.
-

NOTE:

Default note. The customer class defaults from [Installation Options - Account](#) (Person Customer Class) and may be overridden at will. If you have set the Installation Option CIS Division Control flag, the customer class defaults first from the CIS Division and then from the Installation Record. When this option is set, the CIS Division is shown on the page before customer class. You may only select Customer Classes with the account's CIS Division.

CIS Division defines the jurisdiction that governs this account. You may only select **CIS Divisions** associated with the account's [Customer Class](#). If you have set the Installation Option CIS Division Control flag, you need to choose the CIS Division before choosing the Customer Class. The values are restricted to the user's CIS Division(s). See [Users and CIS Division](#) for more information. The value is defaulted to user's primary CIS Division. This field is updated behind the scenes every time a service agreement is activated (the system uses the **CIS Division** associated with the service agreement's SA type). If you have assigned a **CIS Division** and do not want the system to change it when a service agreement is activated, turn on **Protect CIS Division**. If the CIS Division's **Restrict to Account CIS Division** flag is set to *Restricted*, the Protect CIS Division is turned on and cannot be turned off.

NOTE:

CIS Division governs many functions. An account's CIS Division impacts its subsequent bill due dates, late payment charge dates, credit & collections review dates, its default budget plan, the roles assigned to To Do entries, and the calendar of workdays. Refer to [CIS Division Portal](#) and [Setting Up Customer Classes](#) for more information.

Access Group controls which users are allowed to view and update this account's information (including bills, service agreements, payments, and premises). The system defaults this value from one of three sources, stopping after an access group is determined. The first is the Customer Class Control – Determine Access Group system event. The next is the access group defined directly on Customer Class Control. Lastly, it is defaulted from the user's [default access group](#). Refer to [The Big Picture of Row Security](#) for a complete description of how account security is implemented in the system.

The optional Account **Management Group** controls the roles assigned to [To Do entries](#) associated with an account. Refer to [Setting Up Account Management Groups](#) for more information.

Enter a **Comment** to define unusual information about the account. If this field is populated, an alert will highlight such in the [Alert Zone](#).

Bill Cycle controls when a bill is produced for an account. This field is updated behind the scenes every time a service agreement with a service point is activated. The route the system takes to do this update is as follows:

- It looks for all service points linked to the service agreement.
- It extracts the *service cycle* from one of the service points.
- Finally, it takes the bill cycle from the *service cycle*.

NOTE:

The list of bill cycles is restricted to those without a CIS Division and those with a CIS Division that matches the account's CIS Division. When the account does not have a CIS Division, the list is not restricted.

While this is a little complicated, it makes sense because it keeps the bill cycle in sync with the *service cycle*.

If you have assigned a bill cycle and do not want the system to change the bill cycle when a service agreement is activated, turn on **Protect Bill Cycle**.

Mailing Premise ID defines the address on bills for persons who have their bill sent to the account's mailing premise. This field may be updated behind the scenes when a service agreement is activated. The word "may" is used because the system will only update an account's mailing premise if there are no active service agreements currently linked to the account. Refer to [Account - Person Information](#) for more information about how to define where a person has their correspondence and bills sent.

If you do not want the mailing premise to change when a service agreement is activated, turn on **Protect Mailing Premise**.

If you want to stall billing until after some future date, enter the date in **Bill After**.

If a user should review the account's printed bills before they are sent to the customer in an on-going basis, enter this user's ID in **Bill Print Intercept**. This User ID will then be copied to future [Bill - Bill Routing](#) pages when they are created. If the user no longer desires to intercept future bills, their User ID can be removed from this field.

The balances shown in the scroll are the total amounts of debt belonging to every debt class linked to the account's service agreements. The following information is displayed:

- **Debt Class** is the debt class associated with the account's service agreement(s).
- **Current Balance** is the amount of debt the customer currently owes.
- **Payoff Balance** is the amount the customer would owe if they wanted to pay off their debt.

To see summary information about the service agreements that contribute to the financial totals click the go to button adjacent to the respective amount.

WARNING:

If you do not understand the difference between payoff balance and current balance, refer to [Current Amount versus Payoff Amount](#).

Account - Auto Pay

The Auto Pay page is used when an account pays their bills automatically (e.g., by direct debit or credit card).

FASTPATH:

Refer to [How And When Are Automatic Payments Created](#) for more information.

Open **Menu** > **Customer Information** > **Account** > **Search** and navigate to the **Auto Pay** page to maintain this information.

Description of Page

The **Account Auto Pay** scroll defines the bank account / credit card from which the customer's automatic payments are debited. Multiple auto-pay options may exist if the customer changes auto-pay options over time. The following fields display:

- **Start Date** is the date on which the automatic payment information comes into effect. The system creates an automatic payment for any bill produced for this account with a due date on/after this date and on/before the **End Date**. If **End Date** is not specified, this means the automatic payment option applies indefinitely. You need only specify an **End Date** if the customer wants to stop paying automatically.
- **Auto Pay ID** is the unique, system-assigned identifier of the auto-pay record. This value is assigned after the information is saved on the database and may not be modified.
- Use **Auto Pay Source** to define the source of the funds used to satisfy the automatic payment request. For example, if a customer indicates that they want to use their checking account to pay their bill, you would specify the **Auto Pay Source Code** associated with their bank. The source's description and external source ID (e.g., bank routing number) are displayed adjacent.
- Use **Auto Pay Method** to specify whether you want the system to process automatic payments as Direct Debit or Payment Advice. This field is visible only if feature configuration is set up to support payment advice functionality. Refer to [Payment Advices](#) for more information on the payment advice functionality.
- Use **External Account ID** to define the customer's bank account / credit card number.

NOTE:

The system supports encryption for the External Account ID. If your implementation has configured the system to encrypt the External Account ID, the data will be displayed with a masked value; such as, *****. Refer to [Encrypting Sensitive Data](#) for more information

- You will be required to define an **Expires On** date if the **Auto Pay Source Code** references a tender type that requires an expiration date (e.g., if the Auto Pay Source is a credit card company).
- Enter the **Name** of the customer as it appears in the financial institution's system. This name is routed to the financial institution.

NOTE:

Default note. The **Name** will default to the primary name of the main customer linked to the account after you enter a **Start Date**. This defaulting is only possible for accounts that exist on the database.

- In some locales, customers can define a **Maximum Withdrawal Amount** to limit the amount of money that is automatically debited from their account. Refer to [How To Implement Maximum Withdrawal Amounts](#) for more information.
- Use **Comments** to describe anything interesting / unusual about the automatic payment request.

Account - Person Information

The Account Persons page contains information about the person(s) linked to the account.

NOTE:

Both customers and non-customers (e.g. the accounting service that handles the bills of a commercial customer) can be linked to an account.

When you add an account from [Person - Main](#) or from [Order - Main](#) the system automatically links the person to the account, so you typically won't have to open this page. However, if you need to link multiple persons to an account (e.g., because you need to send a duplicate of the account's bill to someone other than the main customer) or change information

about a person on an account, open **Menu > Customer Information > Account > Search** and navigate to the **Persons** page.

Customer Self Service and Account - Person Information:

It is possible that an implementation may have configured the system to integrate with Customer Self-Service. Account - Persons can be created through the self-service application and will use a reserved relationship type that is defined on the self-service master configuration.

Records with this relationship type can be thought of as “owned by the self-service application.” Changes to fields on the page are disabled because the record can be deleted by the self-service application.

You can change the relationship type to another value, which will indicate that the record is no longer owned by self-service. Self-service can no longer delete this record and changes are allowed to the fields on the page. Please note that the relationship cannot be changed back to the self-service designation

Description of Page

The **Account Persons** scroll contains one entry for every person linked to the account. The following fields display:

Person ID The unique identifier of the person linked to the account. The person's name is displayed adjacent.

Main Customer Turn on this switch if the person is the main customer on the account. Only one person on an account may be designated as the main customer.

The significance of the main customer is that its name will appear adjacent to the account ID throughout the system.

Financially Responsible Turn on this switch if the person is financially responsible for the account's debt.

This switch is on and gray if the person is the **Main Customer** because the main customer is always financially responsible. If multiple persons are linked to the account, you use this switch to indicate which ones are financially responsible versus those that are linked for other purposes.

Third Party Guarantor Turn on this switch if the person is a third party guarantor of the account's debt. This switch is off and gray if the person is the **Main Customer**.

Relationship Type Define the relationship between the person and the account. Refer to [Setting Up Account Relationship Codes](#) for information about setting up relationship types.

NOTE:

Default note. When the system links the person to the account when you add an account from [Person - Main](#), it defaults the relationship type from the [Installation Record](#).

Self-Service Role indicates that the Account - Person record has a corresponding entry in the self service application and contains the value for the access in self-service. If there is no corresponding entry in self-service, this field will not display. If configured in the Self-Service Master Configuration, a hyperlink appears allowing direct access to self-service.

Prefix/Suffix and Pfx/Sfx Name Use these fields if you need to append additional information to a customer's name when correspondence or bills are sent to this person. For example, if the account has declared bankruptcy you might attach "Debtor In Possession" to the person's name. Use **Prefix/Suffix** to indicate if the **Pfx/Sfx Name** should be appended to the front or the back of the customer's name.

Receives Copy of Bill Turn on this switch if the person receives a copy of the account's bills. Turning off this switch grays the remaining fields. This switch is on and gray if the person is the **Main Customer** because the main customer always receives a copy of the bill.

FASTPATH:

Refer to [The Source Of Bill Routing Information](#) for more information about how the remaining information is used to format the address of a bill.

Bill Route Type Indicate how the bill is sent to the customer. This field's value defaults from the [Installation Record](#).

- If the **bill route type** you select indicates that bills are routed via Fax, the person's fax number is displayed adjacent The fax number displayed is from a fax person contact associated with an active contact preference, the person's primary fax person contact identified by the contact routing, or a person's fax phone type identified by a flag on the phone type. Which is shown is dependent on how your system is configured.
- If the **bill route type** you select indicates that bills are routed via Email, the person's [Email address](#) is displayed adjacent. The email address displayed is from an email person contact associated with an active contact preference, the person's primary email person contact identified by the contact routing, or a person's email. Which is shown is dependent on how your system is configured.
- If the **Bill Route Type** you select indicates that bills are routed via the Postal service, you must choose an appropriate **Address Source** to define which address should be used.

Refer to [Setting Up Bill Route Types](#) for more information about bill route types.

Bill Format Indicate if the customer should receive a Detailed or a Summary bill.

NOTE:

The values for this field are customizable using the Lookup table. The values need to match the formats supported by your bill print software. This field name is BILL_FORMAT_FLG.

Number of Bill Copies Indicate how many copies of the bill the person receives.

Customer PO ID Indicate the purchase order ID the customer wants printed on their copy of the bill.

NOTE:

Receives Copy of Quote and **Quote Route Type** only appear if the quotation Contract Management module is not [turned off](#).

Receives Copy of Quote Turn on this switch if the person receives a copy of the account's quotes. Turning off this switch grays the remaining fields. This switch is on and gray if the person is the **Main Customer** because the main customer always receives a copy of the account's quotes.

FASTPATH:

Refer to [Printing Quotes](#) for more information about how the remaining information is used to format the address of a quote.

Quote Route Type Indicate how the quote is sent to the customer. This field's value defaults from the [Installation Record](#).

- If the **quote route type** you select indicates that quotes are routed via Fax, the person's fax number is displayed adjacent. The fax number displayed is from a fax person contact associated with an active contact preference, the person's primary fax person contact identified by the contact routing, or a person's fax phone type identified by a flag on the phone type. Which is shown is dependent on how your system is configured.
- If the **quote route type** you select indicates that quotes are routed via Email, the email address displayed adjacent. The email address displayed is from an email person contact associated with an active contact preference, the person's primary email person contact identified by the contact routing, or a person's email. Which is shown is dependent on how your system is configured.
- If the **quote route type** you select indicates that quotes are routed via the Postal service, you must choose an appropriate **Address Source** to define which address should be used.

Refer to [Setting Up Quote Route Types](#) for more information about quote route types.

Receives Collection and Overdue Notices Turn on this switch if the person receives letters (i.e., notifications) initiated by collection, severance, write-off, overdue and cut events. These events will send letters to the main customer and any other person linked to the account that **Receives Notifications**. This switch is on and gray if the person is the **Main Customer**

because the main customer always receives notifications. Refer to [Printing Letters](#) for more information about how letters are produced by the system.

Address Source If the **Bill Route Type** or the **Quote Route Type** you selected indicates that bills / quotes are routed via the postal service, you must choose the appropriate **Address Source**.

Choose Mailing Premise on Account if bills / quotes should be sent to the address associated with the Mailing Premise on the first page. This address is displayed adjacent.

Choose Person if bills / quotes should be sent to the [person's mailing address](#). This address is displayed adjacent.

Choose Account Override if bills / quotes should be sent to an override address specified below. Typically, you would only choose this option if the person has multiple accounts and each account's bills / quotes should be sent to a different address. If you choose this option, the bottom of this page will become populated with fields that should be used to specify this override address.

Override address constituents If you selected an **Address Source** of Account Override, you must enter the address to which bills / quotes will be sent in the address constituents. The number and type of address constituents is based on the [Country](#). These fields will be invisible for other **Address Sources**.

Note, the **Country** defaults from [Installation Options - System](#). The City, County and State default based on the **Country** and **Postal** if a [Postal Default](#) exists for the postal code.

The Validate button on the account page will only be available if you have set the Allow Address Validation option type to Y on the General System Configuration feature configuration. Once clicked, the Address Validation Script on the General System Configuration feature configuration will be invoked to validate the entered address. Refer to [Implementing Address Validation](#) for more information.

Allow Communication Preference: Turn on this switch if person contacts can be used on communication preferences for this account. The switch is on and disabled when the person is the **Main Customer** because their contact information can always be used on contact preferences for notifications.

Account - Financial Balances

The financial balances page is an information-only page that subdivides an account's debt by debt class. The balances shown on this page are the total amounts of debt belonging to every debt class linked to the account's service agreements.

NOTE:

The source of debt class. An account's debt comes from its service agreement(s). Every service agreement has an SA type. Every SA type references a debt class.

Open **Menu** > **Customer Information** > **Account** > **Search** and navigate to the **Financial Balances** page.

Description of Page

The account's **Current Balance** displays at the top of the page.

The **Debt Class Balances** scroll contains one entry for every debt class linked to the accounts non-closed / non-cancelled service agreements. The following information is displayed for each debt class.

- **Debt Class** is the debt class associated with the account's service agreement(s). To see summary information about the service agreements that contribute to the debt class totals click the adjacent Go To button.
- **Current Balance** is the amount of debt the customer currently owes.
- **Payoff Balance** is the amount the customer would owe if they wanted to pay off their debt. Payoff balance is only displayed if it differs from current balance.

WARNING:

If you do not understand the difference between payoff balance and current balance, refer to [Current Amount versus Payoff Amount](#).

- The **Debt Class Arrears** shows the age of all amounts that make up the current balance.
 - The **Days Old** and **Amount** information shows the age of the debt class's debt.
-

NOTE:

Information about debt balances by age is not applicable to [open-item accounts](#).

Account - Bill Messages

The Account Message page contains information about the message(s) to appear on an account's bills. Both one-time and permanent messages may be defined. This information is used when the system assembles messages to appear on an account's bill. Refer to [The Source of Bill Messages](#) for more information about bill messages.

Open **Menu** > **Customer Information** > **Account** > **Search** and navigate to the **Bill Messages** page.

Description of Page

The following fields are displayed:

Bill Message The message code and description of the message that appears on the customer's bill.

Bill Message Type Use Temporary to indicate the message should only be linked to the next bill produced for the account. Use Permanent if the message should appear on every bill. Note, a value of Temporary defaults.

Account - C&C

The Credit Rating page contains the credit rating transactions that impact an account's credit rating and cash-only score. To view or modify these transactions, open **Menu** > **Customer Information** > **Account** > **Search** and navigate to the **C&C** page.

Description of Page

Collection Class controls how the account's debt is compared against collection criteria to determine if a collection process should be started. Refer to [The Big Picture of Credit & Collections](#) for more information about how and when an account's debt is reviewed.

NOTE:

Default note. The **Collection Class** defaults from the account's customer class when the account is first added. It may be overridden at will.

If you need to prevent an account from being reviewed by credit and collections processes (i.e., the [account debt monitor](#) and the [write-off monitor](#)), use **Postpone Credit Review Until** to define the future date when these processes can again review the account's debt.

Last Credit Review Date is the date when the account's debt was last reviewed by the [account debt monitor](#) (ADM).

NOTE:

Forced ADM review. If you want the account debt monitor to review an account's debt the next time it runs, simply change the **Credit Review Date** to a date in the distant past (e.g., 1/1/1900). The next time the ADM background

process runs with the Include Minimum Days Review (Y/N) set to Y, it'll see that a great deal of time has passed since the last time it reviewed the account's debt and review it (and then set the **Credit Review Date** accordingly).

The account's **Current Credit Rating** is displayed. For an explanation of how this number is derived, see [How is an account's credit rating calculated?](#).

The account's **Current Cash-Only Score** is displayed. For an explanation of how this number is derived, see [How is an account's cash-only score calculated?](#).

The **Credit Rating History** scroll contains one entry for each credit rating history record associated with the account. The following fields display:

Start Date This is the first date the credit rating transaction affects the account's credit rating and cash-only score.

End Date This is the last date the credit rating transaction affects the account's credit rating and cash-only score.

The Created On message is formatted using an algorithm on the [Installation Options](#).

Affect Credit Rating By This is the effect of the credit rating transaction on the account's credit score. This should be a *negative* number because the *lower* the score the worse the credit rating.

An account's credit rating is equal to the start credit rating amount defined on the [installation record](#) plus the sum of credit rating demerits that are currently in effect. When an account's credit rating is less than the credit rating threshold defined on the [installation record](#), the account's credit rating is displayed as an alert in the [Alert Zone](#).

Affect Cash-Only Score By This is the effect of the credit rating transaction on the account's cash-only score. The *higher* the score, the greater the chance this account will be marked as cash-only. Therefore, a *positive* number should be used to make the score go up.

An account's cash-only score is equal to the start cash-only score defined on the [installation record](#) plus the sum of cash-only points that are currently in effect. When an account's cash-only score exceeds the cash-only threshold score defined on the [installation record](#), the account is flagged as cash-only in the [Alert Zone](#) and on the payment event page.

Comments Enter comments to clarify the reason(s) for the creation of the transaction.

How are credit rating transactions created?

Credit rating transactions may be created as follows:

- Certain types of severance events add credit rating transactions. The number of credit rating and cash-only points is defined on the [severance event type](#).
- Certain types of severance events add credit rating transactions. The number of credit rating and cash-only points is defined on the severance event type.
- Certain types of write-off events add credit rating transactions. The number of credit rating and cash-only points is defined on the [write-off event type](#).
- If a payment tender is canceled with a cancellation reason that indicates the cancellation was due to non-sufficient funds, a credit rating transaction is created. The number of credit rating and cash-only points is defined on the [payment cancellation reason code](#).
- You may configure your system to create a credit rating transaction when a pay plan is broken. To do this, you must plug in an appropriate Broken Algorithm on the [pay plan type](#).
- A user may create credit rating transactions at their discretion.
- Algorithms may add credit rating transactions. The system provides sample overdue event and cut event activation algorithms that add credit rating transactions. Refer to C1-OE-CR-RT and C1-CE-CR-RT for more information. Some examples of algorithms your implementation may decide to introduce: the creation of a late payment charge. To do this you could introduce a new adjustment freeze algorithm.

NOTE:

Created By Flag. The credit rating transaction includes a **Created By** flag that is customizable using the Lookup table. This field name is CR_RAT_CRE_BY_FLG. If your implementation uses algorithms to create credit rating history transactions, you may consider adding appropriate values to the Created By flag. Also note that the Created By flag includes the value Other , which may be used by your implementation specific algorithms if you do not want to add a new custom value.

How is credit rating calculated?

An account's credit rating is calculated by summing the Affect on Credit Rating from credit rating transactions effective on the current date. This value is added to the beginning credit rating defined on the installation record. The result is the customer's current credit rating.

NOTE: CIS Division can override the beginning credit rating. The system processes first check the account's CIS Division to see if the beginning credit rating has been specified on the CIS Division.

What impact does credit rating have in the system?

The following points describe the impact of an account's credit rating:

- An account's current credit rating is displayed in the Control Central Alert area when it's less than the threshold credit rating defined on the installation record.
- An account's credit rating may affect how the account's debt is collected. We used the word "may" because an account's credit rating will only affect collection criteria if you set up your collection processes to do this.

FASTPATH:

For more information, refer to [Designing Your Collection Class Control Overrides](#).

How is cash-only score calculated?

An account's cash-only score is calculated by summing the Affect on Cash-Only Score from credit rating transactions effective on the current date. This value is added to the beginning cash-only score defined on the installation record. The result is the customer's current cash-only score.

NOTE: CIS Division can override the beginning cash-only score. The system processes first check the account's CIS Division to see if the beginning cash-only score has been specified on the CIS Division.

What impact does cash-only score have in the system?

If an account's current cash-only score exceeds the cash-only threshold on the installation record, and the base package's C1-CASH-ACCT algorithm is enabled on the installation record:

- The customer is flagged as cash-only in the Control Central Alert area.
- If a user attempts to add a payment whose tender type is a cash-equivalent, a warning is issued.

Account - Budget

The Budget page contains information about all service agreements linked to an account that are eligible to participate in a budget billing plan. Refer to [Budget Billing](#) for more information about how this information affects the account's bills.

NOTE:

You are actually changing service agreements. When you change a service agreement's budget amount on this page, you are actually changing the service agreement's recurring charge amount. Refer to [Service Agreement - Recurring Charge](#) for more information.

Eligible service agreements. It's important to be aware that some service agreements linked to an account may not be eligible for budget plans. For example, assume you have a customer with a deposit service agreement and one or more utility service agreements. This customer will be billed for their deposit regardless of the utility service agreements' budget amounts. You define whether a service agreement may participate in a budget plan on the service agreement's SA type.

Open **Menu** > **Customer Information** > **Account** > **Search** and navigate to the **Budget** page to view this information.

Description of Page

The appearance and dialogue of this page differs slightly for an account with a small number of service agreements (100 or less) versus a large number of service agreements (more than 100).

- For an account with a small number of service agreements, the user may click the **Recommend Budget** button to generate a **New Budget** for each service agreement. At that point the service agreement's budget amount has not been updated. The user may review the calculated amounts; make desired changes and then click Save to update the budget amount for the service agreements.
-

WARNING:

You must save the page in order for the budget changes to take effect.

- For an account with a large number of service agreements, the user may click the **Calculate and Apply New Budget** button. At that point the system will calculate the recommended budget and update the **Budget Amount** on all the eligible service agreements. To change the budget amount for one or more of the service agreements, the user navigates to the service agreement page using the drill down button adjacent to the service agreement in question.

Click **Cancel Budget** to have the system set the **New Budget** amount to zero for all the account's service agreements on budget.

NOTE:

Budget Recommendation. Though this page lists all SAs eligible for a budget, the budget recommendation only calculates a budget amount for SAs whose start and end date (if any) includes the budget date.

Budget Plan controls how the account's debt is managed for budget-related purposes. Specifically, it controls how the recommended budget amount is calculated and how / when the customer's budget is periodically changed.

NOTE:

Default note. Budget plan defaults based on the account's customer class / division combination.

The list of budget plans is restricted to those without a CIS Division and those with a CIS Division that matches the account's CIS Division. When the account does not have a CIS Division, the list is not restricted

Use **New Budget Date** to define the effective date of any changes to the customer's budget amount (this date is the effective date on the respective service agreements' recurring charge history).

The system displays the sum of the service agreements' current budget amounts in **Total Budget Amount**.

For accounts with a small number of service agreements, the system displays the sum of the service agreements' new budget amounts in **Total New Budget**.

The grid that follows contains a row for each service agreement linked to the account that is eligible to participate in a budget billing plan:

SA Information This is a concatenation of basic information about the service agreement.

Last Changed Date This is the date when the service agreement's budget amount (i.e., recurring charge amount) was last changed.

Budget Amount This is the existing budget amount (i.e., recurring charge amount) for the service agreement.

New Budget For accounts with a small number of service agreements, the service agreement's budget amount (i.e., recurring charge amount) will be changed to reflect this value when the page is changed. The effective date of the change is defined in **New Budget Date**.

Account - Deposits

The Deposits page contains information about all cash and non-cash deposits linked to an account.

NOTE:

Cash versus Non-cash Deposits. Non-cash deposits (e.g., letters of credit, surety bonds, 3rd party deposits) can be added and maintained on this page. Cash deposits are maintained using service agreements. Refer to [Cash Deposits](#) for information about how to add and maintain cash deposits.

Open **Menu > Customer Information > Account > Search** and navigate to the **Deposits** page to view this information.

Description of Page

The following fields appear in the **Deposit Summary**:

Cash Deposits On Hand The total amount of cash deposits currently held for the account. This value is equal to the sum of the payoff balances from all service agreements whose SA type has a special role of Cash Deposit. Refer to [Cash Deposits](#) for information about how to add and maintain cash deposits.

Cash Deposits Requested This value is equal to the sum of Total Amount to Bill from all service agreements whose SA type has a special role of Cash Deposit. Refer to [Cash Deposits](#) for information about how to add and maintain cash deposits.

Non-Cash Deposits The total amount of active non-cash deposits currently held for the account. This value is equal to the sum of non-cash deposits displayed in the scroll below (note, non-cash deposits can be maintained in the same scroll).

Total Deposits on Hand This is the sum of cash and non-cash deposits held for the account.

Turn on **Do Not Review or Refund** if this account should not be considered by the Deposit Review background process (this process highlights customers who require an additional deposit) or by the Deposit Refund background process. Refer to [The Big Picture Of Deposits](#) for more information about these processes.

The **Non-Cash Deposit** scroll contains an entry for every non-cash deposit linked to the account. Refer to [Non Cash Deposits](#) for more information.

To modify a non-cash deposit, simply move to a field and change its value. To add a new non-cash deposit, click the + button and then fill in the information for each field.

Start Date This is the date the non-cash deposit is effective.

End Date This is the expiration date of the non-cash deposit.

Non Cash Deposit Type Select the appropriate non-cash deposit type. The value selected is important as it controls whether the system requires a **Third Party Deposit** and whether the system will create a To Do entry near the expiration date of the deposit. Refer to [Setting Up Non-Cash Deposit Types](#) for more information.

Deposit Class Select the deposit class in which this non-cash deposit should be included. This value is used when the system amalgamates an account's total deposits when checking if the account holds an adequate deposit (amalgamation and recommendation happens within a deposit class). Refer to [Deposit Class Controls Everything](#) for more information about the significance of deposit class.

Deposit Amount Indicate the amount of the non-cash deposit.

Document Number Enter the document number, if any, associated with the non-cash deposit (e.g., the letter of credit number, the surety bond number, etc.).

Third Party Deposit SA If a 3rd party has paid the cash deposit for the account, reference the deposit SA associated with the 3rd party. Refer to [3rd Party Deposits](#) for more information about how 3rd party deposits are maintained in the system.

Comments Enter any free-form comments about the non-cash deposit.

Account - Characteristics

The characteristics page contains information that describes miscellaneous information about the account. Use **Menu > Customer Information > Account > Search** and navigate to the **Characteristics** page.

Description of Page

NOTE:

You can only choose characteristic types defined as permissible on the account record. Refer to [Setting Up Characteristic Types & Their Values](#) for more information.

The following fields display:

Effective Date Indicate the date on which the characteristic value becomes effective. Note, the effective date defaults to the account's setup date (defined on the **Main** page).

Characteristic Type Indicate the type of characteristic.

Characteristic Value Indicate the value of the characteristic.

Account - Alerts

The alerts page contains information that describes various alerts assigned to the account. Use **Menu > Customer Information > Account > Search** and navigate to the **Alerts** page.

Alerts assigned to an account appear in the [Alert Zone](#). They are used to bring important information to the attention of any customer service representative who looks at the account. Up to 60 alerts can display in the Alert Zone.

Description of Page

The following fields display:

Alert Type Indicate the type of alert to show on Control Central.

Start Date Indicate the date on which the alert starts showing in Control Central. The current date defaults.

End Date Indicate the date on which the alert stops showing in Control Central. You can leave this field blank if the alert should be effective indefinitely. The date defaults to the **Start Date** plus the **Alert Type's** alert period.

Account - Account Portal

Select **Menu > Customer Information > Account > Search** and navigate to the **Account Portal** page to view additional information associated with an Account.

Depending on your implementations requirements, you may define additional zones to appear on this Portal.

The contents of this section describe the zones that are available on this portal page.

General Information displays Account ID and Account Info

Account Contact Information Displays person contacts that are associated with the account in context. Only records for persons that allow communication preferences are shown.

- This zone provides the ability to add or edit existing person contacts. The edit functionality is limited. This provides a convenient way to edit basic information for person contacts. When adding a person contact, person contact types associated with phone types are not available.
- Full maintenance of person contacts can be performed on the *Person – Person Contacts* page.

Push Communication Preferences Displays contact preferences and opt-out preferences for push-based notification types; meaning, those notifications that customers do not need to subscribe in order to receive. You can maintain the customer's preferred method(s) of contact (the preferences) for receiving these notifications, or process a customer's request to opt out of receiving them.

NOTE:

Push notifications have parent and individual notification types. Communication preferences are established for parent notification types. The individual notification types reference a parent notification type and define the message to be sent using the preferences established for the parent. As mentioned, for push notifications a subscription is not needed; a default contact can be determined in the absence of contact or opt-out preferences.

Not all notification types are relevant to all customers. Notification types can be configured with a suppression criteria algorithm that can prevent some notification types from appearing. It is possible that a notification type was suppressed after active contact preferences were set up. These notification types and their contact preferences are also shown when the filter is set to show inactive preferences.

-
- Refer to [Push vs. Subscription Notification Types](#) and [Parent vs. Individual Push Notification Types](#) for more information.
 - Please see the zone's help text for information about this zone's fields.

Subscription Communication Preferences Zone displays contact preferences for subscription-based notification types - meaning those notifications to which customers need to subscribe in order to receive them. You can maintain the customer's preferred method(s) of contact (the preferences) for receiving these notifications. A notification for subscription-based notification cannot be sent without an active contact preference. Opting out is not applicable to subscription-based notification types.

NOTE:

Unlike push notifications, communication preferences are established for the subscription notification types, which also defines the message to be sent.

Not all notification types are relevant to all customers. Notification types can be configured with a suppression criteria algorithm that can prevent some notification types from appearing. It is possible that a notification type was suppressed after active contact preferences were set up. These notification types and their contact preferences are also shown when the filter is set to show inactive preferences.

-
- Refer to [Push vs. Subscription Notification Types](#)
 - Please see the zone's help text for information about this zone's fields.

Account Management Portal

The Account Management portal is used to maintain multiple accounts linked to a particular customer.

Open this page using **Menu > Customer Information > Account Management**

Some examples of customers with large numbers of accounts include:

- Public school districts with many school locations
- Corporate entities with many franchise locations
- Large apartment complexes with many open units
- Service providers billed for many end customers
- Cities, counties, or townships (for street lights, sewer service, etc.)

You can select one or more accounts to update, or you can broadcast an account's service agreements for group SA maintenance. Update actions can be performed on either accounts or SAs. The following items are examples of the account information that can be updated:

- Mailing address
- Characteristics
- Autopay information
- Bill cycle
- Account management group

The following items are examples of the service agreement information that can be updated:

- Rate schedules
- Contract riders and contract values
- Tax exemptions
- Characteristics

When you update information, you can select an account or SA to use as a template, and use this as a basis for updating multiple accounts. The system will copy information from the template to the selected accounts or service agreements. Refer to the embedded help on the Update Details page for more information about using a template to update accounts.

Description of Page

Use the Account Search zone to search for a person. The **Person ID** is required. **Include Hierarchy** determines whether you wish to search for accounts directly linked to the person id specified, or if you want to find all accounts in the hierarchy using person to person relationships. You can also enter one or more of the following values to further restrict the list of accounts returned: **Customer Class, Account Management Group, Bill Cycle** or **Characteristic Type/Value**.

Once a person is selected, you can view and maintain the accounts and the service agreements associate with the person. Click the broadcast icon next to an account to view SAs for the account. The Service Agreement List zone includes a summary listing of the non-closed, non-canceled service agreements of the broadcast account.

Select one or more accounts and click **Update Accounts** to modify account information. Select one or more service agreements and click **Update Service Agreements** to modify service agreement information. Refer to the embedded help on the Update Details page for descriptions of the values that can be updated.

The Person Tree zone, similar to that of Control Central, shows the hierarchy of child persons for the person that has been broadcast.

Account - SAs For A Debt Class

This is an information-only page that shows an account's service agreements grouped by debt class.

NOTE:

The source of debt class. An account's debt comes from its service agreement(s). Every service agreement has an SA type. Every SA type references a debt class.

To access this page, drill down on a debt class shown on **Menu > Customer Information > Account > Search.**

Description of Page

The **Account ID** and the primary name of the account's main customer are displayed.

Debt Class is the debt class associated with the account's service agreement(s).

NOTE:

An account may have service agreements that belong to other debt classes. Navigate to [Account - Main Information](#) to see a list of all debt classes associated with an account.

The **Service Agreement** scroll contains one entry for each service agreement that belongs to the **Debt Class**. The following information is displayed for each service agreement.

- **SA** (service agreement) **Info** is a concatenation of important details about the service agreement.
 - **Premise** defines the service agreement's main premise.
 - **Current Balance** is the amount of debt the customer currently owes.
 - **Payoff Balance** is the amount the customer would owe if they wanted to pay off their debt. Payoff balance is only displayed if it differs from current balance.
-

WARNING:

If you do not understand the difference between payoff balance and current balance, refer to [Current Amount versus Payoff Amount](#).

- **SA Arrears** displays the age of the amounts that make up the current balance.
 - The **Days Old** and **Arrears Amount** information shows the age of the service agreement's debt.
-

NOTE:

Information about debt balances by age is not applicable to [open-item accounts](#).

Using The Account/Person Replicator

There are two different ways to use this transaction:

- You can make many copies of a given Person / Account combination. This may be required if your company works with third party agencies who enroll customers on its behalf. In this situation, the third party agency may receive blocks of pre-allocated account numbers to be used when they enroll a customer. When a customer signs up, the person information can be updated with information about the newly enrolled customer.
- Perform the following steps if you need to create many copies of a given person and account:

- [Add a new person and account](#) if you don't already have a customer to serve as your "template".
- Use the Account/Person Replicator to create copies of the person and the account as described below (and make sure to use the Replicate Acct and Person option).
- You can create many Accounts for a single Person. This may be required if you have a customer who wants many separate accounts rather than a single consolidated account.
- Perform the following steps if you need to create many copies of a given account for a specific person:
 - Select the account that serves as the template account for the person. Note, this account must be linked to the person who wants the many accounts.
 - Use the Account/Person Replicator to create copies of the account as described below (and make sure to use the Replicate Account Only option).

Use **Menu > Customer Information > Account/Person Replicator** to open this page.

Description of Page

Choose the **Account** that serves as the template account.

NOTE:

Recommendation. Carefully verify that the template account you have chosen is correct before you save the replicated accounts. After you save the replicated accounts, any corrections could prove time consuming.

At the top of the page, indicate the **Number** of accounts and persons to **Replicate**.

Indicate the **Main Person Name Base**, which will be used as the main person name for all the new persons to be created. This field will be protected if you choose a **Replicate Type** of Replicate Account Only (as no persons are created).

Use **Replicate Type** to define if you want to create multiple copies of an account for a given person or if you want to create many new person / account combinations. See the description that appears above for more information about this field.

After entering the above, click the **Replicate** button to generate your new accounts and persons. The grid displays informational messages describing what will happen when you click save. For example, it will verify how many accounts will be created, the person whose record will be copied, the name that will be used on all the new persons, etc..

If everything looks clean, click **save**.

Information Replicated for New Persons

Except for the main name, which you indicate in the **Main Person Name** field, all information for the main person linked to the account will be copied to the new persons.

WARNING:

This copy includes the person's identification number. This will result in multiple persons with the same identification number. You should ensure that the identification number for your template person is a temporary number. When you sign up your actual customer, be sure to update the identification number to a valid number for the person.

Information Replicated for New Accounts

Although most information for an account will be copied, not all information will be. The following points describe the information that is NOT copied on newly replicated accounts:

- Mailing premise will be set to blank

- Setup Date is set to the current date
 - Credit Review Date and Postpone Credit Review Until Date will be set to blank
 - Auto Pay information will not be copied
 - Credit Rating History will not be copied
 - Non-cash deposit information will not be copied
-

NOTE:

that all miscellaneous persons linked to the account (i.e., those who are not flagged as Main Customers) will be linked to the new accounts. With this functionality, for example, you can create a person for a third party enroller and link this enroller to the template account. This enroller will then be linked to all the new accounts.

Maintaining Service Agreements

A service agreement contains the terms and conditions controlling how the system calculates charges for a specific service supplied to a customer. The topics in this section describe the pages on which service agreement related information is maintained.

NOTE:

The system creates most service agreements behind the scenes. Most service agreements are created "behind the scenes" by the system as part of the Start Service and Order completion processes. You should only have to access the service agreement pages if you need to fine-tune what the system defaults. Refer to [Start/Stop](#) and [Maintaining Orders](#) for the details.

Service Agreement and Usage Subscription. A Usage Subscription will exist for each 'usage-oriented' service agreement.

FASTPATH:

For more information about service agreements and their place in the "V", refer to [Understanding The "V"](#). For more information about the source of information defaulted onto service agreements, refer to [Setting Up Start Options](#).

WARNING:

Take special care when adding a new service agreement to specify the appropriate Division and SA Type as it will affect how the customer is billed, what rate can be specified, how overdue debt is collected, and much more. After the service agreement is activated, you may not change its SA type.

The Lifecycle Of A Service Agreement

The following diagram shows the possible lifecycle of a service agreement.

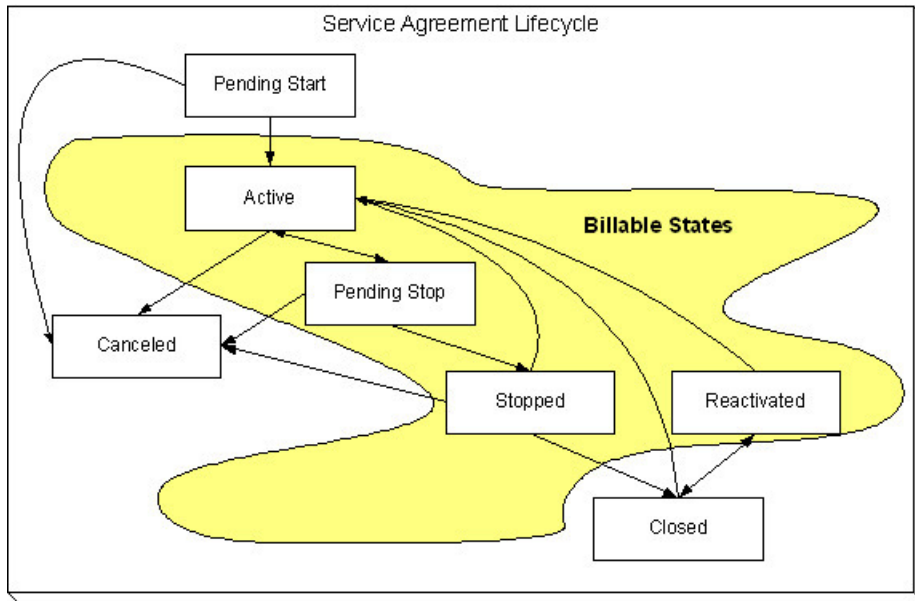

Pending Start When you initiate a request to start service, the system initiates a service agreement in the state of Pending Start. A pending start service agreement remains in this state until everything necessary to start service is defined in the system.

Active The system automatically changes the state of Pending Start service agreements to Active when everything necessary to start service exists in the system. Refer to [Activating Pending Starts](#) for more information. While in this state, the system bills the service agreement's account for the service.

Pending Stop When you initiate a request to stop service, the system progresses the service agreement to the Pending Stop state. A pending stop service agreement remains in this state until everything necessary to stop service is defined in the system.

Stopped The system automatically changes the state of Pending Stop service agreements to Stopped when everything necessary to stop service exists in the system. Refer to [Finalizing Pending Stops](#) for more information. The service agreement remains in this state until it is paid in full.

A service agreement can be automatically stopped depending on the SA Type configuration of the **Stop Option Flag**. Service agreements configured to automatically stop will be stopped when all SP related SAs of the account are stopped. For example, if an account has a cable service and a charitable contribution service agreement then the charitable contribution service agreement can be configured to automatically stop when the cable service agreement is stopped. The stop date of the charitable contribution will be set equal to the stop date of the electric SA.

Closed The system moves a service agreement to the Closed state when it no longer has a financial balance.

Reactivated The system moves a service agreement to the Reactivated state if a financial transaction is created after a service agreement is Closed (e.g., when a payment is canceled after the service agreement is closed). Please be aware that Reactivated service agreements are processed by the [Write Off Monitor](#).

When the service agreement once again has a zero balance (e.g., because the customer pays or the debt is written off), the service agreement returns to the Closed state.

Cancelled You may Cancel a service agreement if it shouldn't exist (because the customer doesn't want service). While cancellation doesn't physically remove a service agreement from the database, most queries and trees suppress information about canceled service agreements. This means cancellation is a nice way to logically delete undesired service agreements.

You'll notice in the above diagram that you can cancel an Active, Pending Stop or Stopped service agreement. You may only do this if the service agreement's financial transactions and non-billed billable charges are all cancelled.

You should rarely have to change a service agreement's status. Why? Because the system changes the status behind-the-scenes when various events take place. For example,

- When you request a service start using the Start/Stop page, the system creates a service agreement in the pending start state.
- If you cancel a pending start before service is activated, the system automatically changes the state of the service agreement to cancelled.
- When everything necessary to start service exists, the system automatically changes the state of the service agreement to active.
- When you request a service stop using the Start/Stop page, the system changes the state of the stopped service agreement to pending stop state.
- When everything necessary to stop service exists, the system automatically changes the state of the service agreement to stopped.
- When a final payment is received and the stopped service agreement's balance becomes zero, the system automatically changes the state of the service agreement to closed. The system can also close a service agreement as part of the write-off processing.
- If the payment bounces, the system automatically changes the state of the service agreement to reactivated. And the system will change it back to closed when the account's balance returns to zero.
- If a billable charge is interfaced into the system, the system automatically changes the state of the service agreement to reactivated.

You may need to manually change a service agreement's state for the following reasons:

- If a service agreement was activated inadvertently, you may cancel it (and therefore logically remove it from the system) after canceling all of its financial transactions. You do this by clicking the cancel button on the service agreement page. You may also cancel an incorrect service agreement if the status transitions to pending stop or stopped before you have a chance to correct the mistake.
- If you don't want to wait for the system to automatically activate a pending start service agreement, you may push the activate button on the service agreement page. You might do this in order to create a bill for an impatient customer.
- If you don't want to wait for the system to automatically finalize a pending stop service agreement, you may push the stop button on the service agreement page. You might do this in order to create a real time final bill for a customer.
- If you don't want to wait for the system to automatically close a stopped service agreement, you may push the close button on the service agreement page.
- Sometimes a service agreement is closed or stopped by mistake. You can activate a stopped, closed, or reactivated service agreement using the **Reinstate SA** button on the service agreement page. Using the **Reinstate SA** button retains the current service's billing history.

NOTE:

One time invoices (i.e., one-time billable charges) are interesting. One-time invoice service agreements follow the above lifecycle; it's just that they do it quickly. You see, when a one-time invoice service agreement is created, both its start and stop dates are known (they are the invoice date). If you followed the above state transition discussion, you'll understand that the system progresses these invoices from pending start to stopped when the service agreement is activated.

Renewing Service Agreements

Some service agreement types (e.g., non-billed budgets) may allow or require renewal. If renewal is optional, a renewal date may be specified when the service agreement is created. If renewal is required, you must specify a renewal date.

The [SA renewal background process](#) initiates the renewal for all active service agreements when the renewal date is reached (i.e., the renewal date is on or before the process date). When a service agreement is renewed:

- The SA renewal algorithm (specified on the SA type) is executed. The SA renewal algorithm can be used to customize the processing required to renew an SA.
- If the SA renewal algorithm is successful, the renewal and expiration date (if calculated by the renewal algorithm) on the service agreement are updated with the values returned from the renewal algorithm.
- If the renewal process is not successful, a To Do list entry (of type TD-SARN) is created for the account and service agreement.

Expiring Service Agreements

Service agreements may specify an expiration date. Some service agreement types (e.g., Non-Billed Budgets) require an expiration date. The [SA expiration background process](#) initiates the request to stop service for all active SAs when the expiration date is reached (i.e. the expiration date is on or before the process date).

Service Agreement - Main Information

The Main page contains basic service agreement information. Open **Menu > Customer Information > Service Agreement > Search** to maintain this information.

Description of Page

SA (service agreement) **Info** and **SA ID** are displayed on every page. These values only appear after the service agreement exists on the database. The **ID** is a system assigned random number that stays with a service agreement for life. The **SA Info** is a concatenation of important details about the service agreement and its account.

NOTE:

Formatting may be performed by a plug-in. The contents of **SA Info** may be formatted by a plug-in algorithm on [SA Type](#). Refer to the base package's C1-SAT-INFO for an example. If such an algorithm is not plugged-in on the SA Type, the system looks for a corresponding algorithm on the [installation record](#). Refer to the base package's C1-SAI-INFO for an example. If you prefer different formatting logic, your system administrator should configure the system appropriately.

SA Status defines the state of the service agreement. The system typically changes the state of a service agreement behind-the-scenes. If you can't wait for the system, use one of the adjacent buttons:

- Click the **Activate SA** button to activate a Pending Start service agreement.
- Click the **Cancel SA** button to cancel a Pending Start or Active, Pending Stop or Stopped service agreement.
- Click the **Initiate Stop** button to populate the **End Date** and change the state of the service agreement to Pending Stop.
- Click the **Stop SA** button to stop a Pending Stop service agreement.
- Click the **Close SA** button to close a Stopped or Reactivated service agreement.
- Click the **Reinstate SA** button to reinstate a Closed, Reactivated, or Stopped service agreement to an Active service agreement.

FASTPATH:

Refer to [The Lifecycle of a Service Agreement](#) for more information about **SA Status**.

If the [quotation](#) module is not [turned off](#), a "real" service agreement can be created when a [proposal service agreement](#) is [accepted](#). If the service agreement you've displayed was created in such a way, information about the **Proposal SA** will appear beneath **SA Status**.

Enter the **Account ID** that is financially responsible for the service agreement. If you change a service agreement's **Account ID**, you are effectively transferring this service agreement (and its debt) to the new account.

Indicate the **CIS Division** and **SA Type**. These fields are very important as they control numerous aspects of the service agreement's behavior. These fields are gray when the status is not Pending Start.

NOTE: If the service agreement's account's CIS Division's **Restrict to Account CIS Division** flag is set to *Restricted*, the CIS Division is set to the account's CIS Division and cannot be changed.

FASTPATH:

For more information about what the SA type controls, refer to [Setting Up SA Types](#).

The **Start Date** defines when the financial relationship begins. The **End Date** defines when the financial relationship terminates. If the end date is blank, the service agreement has not yet been terminated.

Use **Maximum Bill Threshold** if you want the system to generate a bill error when a bill segment is produced in batch that exceeds a given value. These bill errors will appear on the standard billing queries and To Do lists. If, after reviewing the high value bill segment, a user truly intends to send the bill out, they should regenerate the bill. Refer to [How To Correct A Bill Segment That's In Error](#) for more information.

NOTE:

Default note. The value of **Maximum Bill Threshold** defaults from the service agreement's SA type.

the **SA Type** has a special role of Bill Determinants Required, you must enter the **Cutoff Time** and **Start Day Option** that is used on a bill determinants usage request.

- The **Cutoff Time** is entered in "legal time". This value defaults from either the start option or the [installation record](#).
- For **Start Day Option**, you may choose Current Day or Previous Day. This value defaults from either the start option or the [installation record](#).

Use **Customer Read** to define if the customer reads his or her own meter. Valid values are: Yes, No.

If you've set up the system to use [start options](#), you can have the system default many fields by copying the terms from a start option when service is started using either [Start / Stop](#) or the [Order](#) transaction. The **Start Option** field contains the last start option whose field values were copied to the service agreement. If you need to change a service agreement's terms by applying a different start option, you can. Refer to [Changing A Start Option](#) for a description of how to do this.

If the service agreement's rate uses premise-based characteristics for taxation and other purposes, **Characteristic Premise ID** defines the premise that supplies these characteristics. This field also defines the premise under which the service agreement's bill segments are classified and is used to identify where the service agreement's service is located on various windows. This field is gray if the service agreement's SA type doesn't require a characteristic premise. For more information about rates and their use of characteristics, refer to [Setting Up Bill Factors](#).

NOTE:

Selecting a characteristic premise. If the service agreement has service points, only premises associated with these service points may be selected as a **Char Premise**. If the service agreement doesn't have service points, any premise may be selected.

Your conversion process will fill in **Old Account ID** for service agreements that were converted from your legacy CIS system. The [payment upload process](#) uses this field to locate the accounts for payments that reference a legacy account number.

If the service agreement requires a total amount to bill, the amount is displayed. This field is typically only used on loan or cash deposit service agreements. It holds either the loan amount or the desired cash deposit. If you increase this field's value, the customer will be billed for any difference between the new amount and the total amount billed (and paid for) to

date. The label that appears for this field is defined on the SA type (on the Billing tab). We recommend that the system be set up so that this label is very specific, for example:

- It should be called **Cash Deposit Amount** if the total amount to bill is for a deposit.
- It should be called **Loan Amount** if the total amount to bill is for a loan.

Number of Payment Periods only appears for loan SA types. It displays the number of periods specified when the loan was first activated. (The number of payment periods may have been subsequently changed on [Loan maintenance](#).)

If the service agreement uses a recurring charge, the current recurring charge amount is displayed. Transfer to the [Service Agreement - Recurring Charge](#) to update this value. This field is not visible if the service agreement's SA type doesn't allow recurring charges. The label that appears for this field is defined on the SA type (on the Billing tab). We recommend that the system be set up so that this label is very specific, for example:

- It should contain **Budget Amount** if the recurring charge is for a budget.
- It should contain **Installment Amount** if the recurring charge is used for a deposit being paid in installments.
- It should contain **Payment Amount** if the recurring charge is used for a loan.

SA Relationship ID contains the ID of the SA Relationship that is associated with a sub service agreement. This field is only visible on sub service agreements. Refer to [Sub Service Agreements](#) for more information.

CIAC Review Date displays the last date that the Contributions In Aid of Construction (CIAC) review process ran for this service agreement. This field is only visible if the SA type indicates this is a CIAC service agreement. Refer to [CIAC Segmentation](#) for more information on CIAC.

Deposit Interest Calculated contains the last date the system applied interest. This field is only visible if the SA type has a special role of Cash Deposit.

The **Scheduled Payment Autopay** flag determines if the Non-Billed Budget scheduled payments are excluded from automatic payment or included by automatic payment. If the account is not set up for automatic payment for the period that covers the Non-Billed Budget, this flag cannot be set. This field is only visible if the SA has a special role of Non-Billed Budget.

The **NBB Recommendation Rule** displays the description of the non-billed budget recommendation rule used for this SA. This field is only visible if the SA has a special role of Non-Billed Budget.

Expiration Date contains the date at which the service agreement is set to expire.

Renewal Date contains the date at which the service agreement is to be renewed. Renewal date is disabled if renewal is not allowed on the SA type.

Debt Class indicates the debt class into which the service agreement's current balance is categorized by credit and collections. A service agreement's debt class is defined on its SA type. Refer to [Different Collection Criteria For Different Customers And Different Debt](#) for more information about debt class.

Current Balance indicates the amount the customer currently owes for the service.

Payoff Balance indicates the amount the customer would owe if they wanted to close the service agreement. This value is only displayed when it differs from current balance.

FASTPATH:

Refer to [Current Amount versus Payoff Amount](#) for more information.

The **Days Old** and **Arrears Amount** information shows how old the current balance is. This information will be blank if the current balance is a credit.

NOTE:

Information about debt balances by age is not applicable to [open-item accounts](#).

This bottom of this page contains a [tree](#) that shows the various objects linked to the service agreement. You can use this tree to both view high-level information about these objects and to transfer to the respective page in which an object is maintained.

The topics that follow describe miscellaneous features on this page.

Changing A Start Option

If the service agreement is in the pending start state, you can use the [Start/Stop - Pending SAs](#) page to change the service agreement's SA type and/or start option.

If the service agreement is in the active or pending stop states and if the SA type uses [start options](#), a button appears on Service Agreement - Main called **Apply New Start Option**. When clicked, the **Apply New Start Option** dialog box opens.

The fields in this dialog box allow you to define a **Start Option** whose terms should be copied to the service agreement as of a given effective date (**Apply Start Option on**). Because most terms on a service agreement are effective-dated, it's important that you understand the following ramifications of applying a start option (note, we use the word "terms" to generically reference any of the fields that can be defaulted from a start option):

- Terms are reused if **Start Option** contains the same value as defined in the service agreement. For example,
 - If the **Start Option** references the same rate as defined in the service agreement, a new rate record will NOT be created.
 - If the **Start Option** references a contract rider that's currently defined in the service agreement, a new rider will NOT be created.
- Terms that support explicit expiration (i.e., those with an end date) are expired if they are not referenced on the new **start option**. For example, if the service agreement has a rider that is not referenced on the new **start option**, it will be expired.
- Terms that support implicit expiration (i.e., those without an end date) are left unchanged if they are not referenced on the new **start option**. For example, a service agreement characteristic that isn't referenced on the new **start option** will NOT be modified when a new start option is applied.

NOTE:

Only start options related to the service agreement's SA type can be used. It should be noted that only start options related to the service agreement's SA type can be specified. If the service agreement is in the pending start state, you can change the service agreement's SA type on the **Main** tab or via [Start/Stop - Pending SAs](#). If the service agreement is active, you may not change its SA type.

When you click **OK** a warning window will appear that summarizes the changes that will be made to the service agreement. After confirming what will be changed, click **OK** to change the service agreement's terms. The **Start Option** that is shown on the **Main** tab will now reflect the start option whose terms were just applied.

The Impact of Proposal Service Agreements

If the [quotation](#) module is not [turned off](#), you may display a [proposal service agreement](#) on Service Agreement - Main. This section describes how Service Agreement - Main differs when a proposal service agreement is displayed.

The **SA Status** section is replaced with a section that shows the status of the proposal service agreement (proposal SA).

Proposal SA Status defines the state of the proposal service agreement. The [Quote Maintenance](#) transaction typically changes the status of a proposal SA when users accept, decline and cancel quote details. If you wish to change the status of a proposal SA independent of this transaction, you can press one of the adjacent buttons

- Click the **Activate** button to change the status from Pending to Quotable. Note, you can set up the system to automatically make newly created proposal SAs quotable by plugging in the appropriate Proposal SA Creation algorithm on the SA's SA type.
- Click the **Accept** button to change the status from Quotable to Accepted. When you accept a proposal SA, you will be asked to supply the **Start Date** of the real service agreement that will be created.
- Click the **Decline** button to change the status from Quotable to Declined. When you decline a proposal SA, you will be asked to supply a **Decline Reason**.
- Click the **Cancel** button to change the status from Quotable to Canceled.
- Click the **Reactivate** button to return a Canceled or Declined proposal SA to the Quotable state.

FASTPATH:

Refer to [Proposal SA State Transition](#) for more information about **ProposalSA Status**.

If the proposal SA has been declined, the **Decline Reason** appears beneath **Proposal SA Status**. Refer to [Accepting / Declining Quote Details](#) for more information.

If the proposal SA was changed after a quote detail was generated using the proposal SA's terms, a **Remark** appears beneath **Proposal SA Status** highlighting such.

NOTE:

Changing A Start Option. You can [Apply A New Start Option](#) on pending and quotable proposal SAs.

If a real service agreement was created when the proposal SA was accepted, **Real SA ID** appears and contains the ID of the real service agreement. Refer to [Accepting / Declining Quote Details](#) for more information.

Service Agreement - Rate Info

The rate info page contains the service agreement's rate and information needed by the rate to calculate the service agreement's bill segments. This information is only displayed if the service agreement's SA type allows a rate.

Open **Menu > Customer Information > Service Agreement > Search** and navigate to the **Rate Info** page.

Description of Page

The **Rate** grid controls the rate used to calculate the service agreement's bill segments. Multiple rows will only exist if the service agreement's **Rate** changes over time.

A service agreement's **Rate** is populated by the system when service is started. The method used to populate the initial **Rate** depends on how service is started and whether you use start options:

- If the service agreement's SA type uses [start options](#):
 - If the **Order** transaction is used to start service, the rate is populated using the [start option](#) associated with the package that was selected by the user when the order was completed.
 - If **Start/Stop** is used to start service, the rate is populated using the start option selected by the user when service was initiated.
- If the service agreement's SA type does not use [start options](#), the [SA type's default rate](#) is populated on the service agreement.

Billing selects a single rate from the **Rate** grid when it calculates a bill segment for the service agreement. If multiple rates are defined in this grid, the rate is selected based on the service agreement's SA type's [Rate Selection Date](#). The following fields display:

- **Effective Date** is the date the rate becomes effective. The service agreement's start date defaults.

- **Rate Schedule** defines the rate used to calculate the service agreement's bill segments. Note, you can only choose rates defined as permissible on the service agreement's SA type; the permissible rates are shown in the adjacent tree.

NOTE:

Possible override. If your service agreement is linked to a terms of service record, it is possible that the rate used by the system could get [overridden by one referenced on the terms of service](#). If the rate is overridden by the TOS, the tree on this page indicates the rate source.

The **Contract Rider** grid contains the contract riders that are in effect for the service agreement. This information is defaulted when service is started using a start option (using the contract rider information defined on the [start option](#)). You should only have to access this section if you need to fine-tune what the system defaults.

Billing uses this information when it calculates a bill segment for the service agreement if:

- The rate used to calculate the bill segment contains a calculation rule that references a bill factor.
- The referenced bill factor requires a contract rider to levy the associated charge.

If a **Contract Rider** does not exist or is not effective, the charge associated with the calculation rule is not applied to the customer's bill.

To modify a contract rider linked to the service agreement, simply move to a field and change its value. To remove a contract rider, click the - button. To add a new contract rider, click the + button and fill in the information for each field. The following fields display:

- Use **Start Date** to define the date on which the contract rider becomes effective. The service agreement's start date defaults.
- Use **End Date** to define the date on which the contract rider expires. This field need only be specified if the contract rider expires on an explicit date.
- Use **Bill Factor** to define the type of rider. You may only reference **Bill Factors** designated as being applicable for contract riders. Note, the **Bill Factors** linked to the rate that are marked with contract rider applicability are shown in the adjacent tree under the Contract Rider node.

The **Contract Values** grid contains the contract values that are in effect for the service agreement. This information is defaulted when service is started using the contract value information defined on the [start option](#) used to start service (if any). You should only have to access this page if you need to fine-tune what the system defaults.

Billing uses this information when it calculates a bill segment for the service agreement if:

- The rate used to calculate the bill segment contains a calculation rule that references a bill factor.
- The referenced bill factor uses a contract value to define the amount charged.

The following fields display:

- Use **Start Date** to define the date on which the contract value becomes effective. The service agreement's start date defaults.
- Use **End Date** to define the date on which the contract value expires. This field need only be specified if the value rider expires on an explicit date.
- Use **Bill Factor** to define the type of value. You may only reference **Bill Factors** designated as allowing values in contract terms. Note, the **Bill Factors** linked to the rate that are marked as allowing values in contract terms are shown in the adjacent tree under the Contract Value node.
- Use **Value** to define contract value.

FASTPATH:

For more information about contract values, refer to [Defining General Bill Factor Information](#).

The **Tax Exemptions** section contains the taxes from which the service agreement is all or partially exempt.

Billing uses this information when it calculates a bill segment for the service agreement if:

- The rate used to calculate the bill segment contains a calculation rule that references a bill factor.
- The referenced bill factor can have tax exemptions that limit the amount of the charge.

If the bill factor doesn't have a tax exemption or there are none that are effective during the bill period, the tax is levied in full. If the service agreement is exempt, the appropriate charge associated with the tax is calculated. We strongly recommend using the "%T" substitution character in the [Description on Bill](#) on tax-exemptible calculation rules so that an appropriate tax exemption message appears on the customer's bill.

The following fields display:

- Use **Start Date** to define the date on which the tax exemption becomes effective.
- Use **End Date** to define the date on which the tax exemption expires.
- Use **Bill Factor** to define the tax from which the service agreement is exempt. You may only reference bill factors designated as being tax exemptible. Note, the **Bill Factors** linked to the rate that are marked as tax exemptible are shown in the adjacent tree under the Tax Exemption node.
- Use **Percent Exempt** to define the customer tax exemption percent (e.g., 90 means the customer is 90% exempt and will only pay 10% of the normal tax rate).
- Use **Tax Exempt Type** to specify the type of exemption.
- Use **Tax Certification** if the customer has a tax exemption certificate.

Rate Information Tree

The [tree](#) shows the service agreement's permissible rates and the related types of contract riders, contract values and tax exemptions that are possible given these rates.

- The Permissible Rates node displays all the rate schedules associated with the service agreement's SA Type.
- The Effective Rate Schedule node indicates the rate schedule currently effective.
- The Contract Rider node displays the bill factors linked to the service agreement's rate(s) that may have contract riders defined for them. If you expand a node, you can see the individual calculation rule(s) on which the bill factor is specified. If the service agreement has a value defined for the contract rider that is currently in effect, it is also shown.
- The Contract Value node displays all the bill factors linked to the service agreement's rate(s) that may have contract values defined for them. If you expand a node, you can see the individual calculation rule(s) on which the bill factor is specified. If the service agreement has a contract value defined that is currently in effect, it is also shown.
- The Tax Exemption node displays all the bill factors linked to the service agreement's rate(s) that may have tax exemptions defined for them. If you expand a node, you can see the individual calculation rule(s) on which the bill factor is specified. If the service agreement has a tax exemption defined for the bill factor that is currently in effect, it is also shown.

If the service agreement is currently linked to a terms of service record for an effective umbrella agreement, additional information is displayed in the tree.

- The Permissible Rates node displays the rate source value associated with the service agreement's SA Type.
- If the terms of service record linked to the service agreement has a template SA and the rate source is Check TOS First, then SA , the Effective Rate Schedule node displays the rate schedule for the template SA. An additional node indicating whether the rate source is the template SA or the current SA is displayed below.
- The Contract Rider, Contract Value and Tax Exemption nodes include the terms of service usage value from the bill factor.

FASTPATH:

Refer to [Rate Terms Overridden By Terms Of Service](#) for more information.

Service Agreement - SA / SP

The SA / SP page contains the service points that are linked to the service agreement. This information is only displayed if the service agreement's SA type allows service points.

This information is updated by the system when service is started. You should only have to access this page if you need to fine-tune what the system defaults.

WARNING:

You must understand the "V" very well before attempting to maintain this information. Refer to [Understanding The "V" for more information](#).

Use **Menu > Customer Information > Service Agreement > Search** and navigate to the SA/SP page

Description of Page

Billing uses SA / SP information to amalgamate consumption when it calculates a bill segment for the service agreement. The following fields are displayed:

Service Point ID The identity of the service point. The type and location of the service point is displayed adjacent. This field is gray after the service point is committed to the database.

Meter/Item Info The meter / item that is currently installed at the service point is displayed.

How to Use (SP) Indicates how billing uses the consumption associated with the service point. This field is gray for item-type service points. Valid values are: Add, Check, Subtract. Add service points have their consumption added to the total amount of consumption billed under a service agreement. Subtract service points have their consumption subtracted from the total amount of consumption billed under a service agreement. Check service points are ignored by billing.

Use Percent Indicates the percentage of this service point's consumption that is billed under the service agreement. This field is gray for item-type service points.

Start Date/Time The date and time the service point's consumption starts being billed under the service agreement. The service agreement's start date defaults. If the SA Type has a special role of Bill Determinants Required, the system sets this date based on the service agreement's start date, the service agreement's start day option and cutoff time, and the SA Type's initial start date option to reflect the earliest possible date/time that usage may be requested for the SA. The default date/time is overridden by the algorithm C1-UPDSASPDT when the Usage MO's MDM Version option is set to 1.

Stop Date/Time The date and time the service point's consumption stops being billed under the service agreement. If the SA Type has a special role of Bill Determinants Required, the system sets this date based on the service agreement's stop date and the service agreement's start day option and cutoff time to reflect the latest possible date/time that usage may be requested for the SA. The default date/time is overridden by the algorithm C1-UPDSASPDT when the Usage MO's MDM Version option is set to 1.

The **Field Activity** grid contains the list of field that have been generated in respect of this SA / SP. Refer to [Field Activities to Start Service](#), [Field Activities to Stop Service](#) and [The Big Picture Of Severance Events](#) for more information.

Field Activity The unique ID of any field activity associated with starting, stopping, investigating, or severing the service at the service point.

Field Activity Type Indicates why the field activity is linked to the SA/SP. Valid values are Start Activity, Stop Activity, Severance Activity, or Service Activity.

The **Characteristics** grid contains characteristics that are only applicable for a given SA / SP combination. These are typically only used for obscure SA/SP relationships for which unusual pricing terms

NOTE:

You can only choose characteristic types defined as permissible on the SA/SP record. Refer to [Setting Up Characteristic Types & Their Values](#) for more information.

The following fields display:

Effective Date Indicate the date on which the characteristic value becomes effective. The service agreement's start date defaults.

Characteristic Type Indicate the type of characteristic.

Characteristic Value Indicate the value of the characteristic.

Service Agreement - Chars, Qty & Rec. Charges

This page contains the Characteristics, Contract Quantities and Recurring Charges that are in effect for the service agreement.

Use **Menu > Customer Information > Service Agreement > Search** and navigate to the **Chars, Qty & Rec. Charges** page.

Description of Page

The **Characteristics** grid contains information that describes miscellaneous information about the service agreement. This information is defaulted when service is started using the characteristics defined on the [start option](#) used to start service (if any). You should only have to access this section if you need to fine-tune what the system defaults.

NOTE:

You can only choose characteristic types defined as permissible on the service agreement record. Refer to [Setting Up Characteristic Types & Their Values](#) for more information.

The following fields display:

Effective Date Indicate the date on which the characteristic value becomes effective. The service agreement's start date defaults.

Characteristic Type Indicate the type of characteristic.

Characteristic Value Indicate the value of the characteristic.

The **Contract Quantity** grid contains the contract quantities that are in effect for the service agreement. This information is defaulted when service is started using the contract quantities defined on the [start option](#) used to start service (if any). You should only have to access this section if you need to fine-tune what the system defaults.

Billing may use this information when it calculates a bill segment for the service agreement if the rate has pre-processing calculation groups. Refer to [All Calculation Rule-Based Rates Share a Common Structure](#) for more information about pre-processing calculation groups.

The following fields display:

Effective Date The date this quantity becomes effective. The service agreement's start date defaults.

Contract Quantity Type The type of contract quantity.

Contract Quantity The contract quantity.

The **Recurring Charge** section contains effective-dated information that defines the recurring charge amount used to calculate the service agreement's bill segments. This information is only displayed if the service agreement's SA type allows a recurring charge amount.

A service agreement's recurring charge amount history is updated by the system behind-the-scenes as part of the Start Service process. The budget recalculation process can also update this information. You should only have to access this section if you need to change a service agreement's recurring charge amount on some future date.

Billing uses recurring charge information to select the appropriate recurring charge when it calculates a bill segment for the service agreement. To modify a recurring charge, simply move to a field and change its value. To change the recurring charge amount effective on a given date, click the + button to insert a row, then fill in the information for each field. The following fields display:

Effective Date The date the charge becomes effective. The service agreement's start date defaults.

NOTE:

Recurring charge changes during a bill period. Only one recurring charge will be used on any bill segment. The system selects the recurring charge value effective on the end date of the bill segment.

Recurring Charge Amount The recurring charge amount.

Service Agreement - Miscellaneous

The miscellaneous page contains information that describes miscellaneous information about the service agreement. Use **Menu > Customer Information > Service Agreement > Search** and navigate to the **Misc** page.

Description of Page

Start Requested By displays the information entered in the Requested By field on the Start Stop page when this SA was started.

Stop Requested By displays the information entered in the Requested By field on the Start Stop page when this SA was stopped.

Select the **SIC** associated with the customer. This is typically only used for commercial and industrial customers.

Enter a **Business Activity** associated with the customer. This can be used to further define what types of activities are served by this contract.

The bill message grid contains information about the message(s) to appear on a service agreement's bill segments. Both one-time and permanent messages may be defined. This information is used when the system assembles messages to appear on an account's bill (as part of bill completion). Refer to [The Source Of Bill Messages](#) for more information. The following fields are displayed:

- For **Bill Message**, select a message code to appear on the customer's bill.
- For **Bill Message Type**, use Temporary to indicate the message should only be linked to the next bill produced for the account. Use Permanent if the message should appear on every bill. Note, a value of Temporary defaults.

The terms and conditions (T&C) grid contains the service agreement's T&C's. This information is defaulted when service is started using a start option (using the T&C information defined on the [start option](#)). You should only need to change this information if you need to fine-tune the defaults. Refer to [Legal Terms and Conditions May Be Specified on Service Agreements](#) for more information. The following fields display:

- Use **Start Date** to define the date on which the T&C becomes effective. The service agreement's start date defaults.
- Use **End Date** to define the date on which the T&C expires. This field need only be specified if the T&C expires on an explicit date.
- Use **Terms and Conditions** to define the type of T&C.

Service Agreement - Contract Options

The contract options page contains the contract options and contract option events for service agreements.

Open this page using **Menu > Customer Information > Service Agreement > Search** and then navigate to the **Contract Options** page.

Description of Page

The **Contract Option** collection contains effective-dated information that defines the contract options linked to the service agreement. The following information may be defined for each contract option:

Contract Option Id This is the id of the to link to the service agreement. The **SA Contract Option ID** is displayed adjacent. This is the unique identifier of the SA / contract option record.

Effective Date/Time This is the date and time that the contract option is in effect for the service agreement.

Expiration Date/Time This is the date and time that the contract option is no longer in effect for the service agreement.

The **Override Events Collection** contains information about the override events for a shared contract option.

If a contract option event for a shared contract option should not be applicable to this service agreement, enter the **Contract Option Event ID**, the **Override Date/Time** that the override is effective and the **Status**. The status value of Active means that the override is in effect. The status value of Inactive 'cancels' the override, meaning that the event is applicable to this service agreement.

If seasonal time shift records are linked to both the base time zone and to the time zone on the service agreement's characteristic premise, the **Seasonal Time Shift** associated with the time zone on the characteristic premise is displayed.

The **Seasonal Time Shift Remark** indicates whether the data is displayed and should be entered in legal time or standard time. If the data is displayed in legal time use the **Show in Standard** button to toggle to standard time. If the data is displayed in standard time use the **Show in Legal** button to toggle to legal time.

NOTE:

This tab may not appear. This tab is suppressed if the interval billing Complex Billing module is [turned off](#).

Contract Option and Dynamic Option. A Dynamic Option will exist for each Contract Option.

FASTPATH: For more information about Dynamic Option, refer to Dynamic Option.

Service Agreement - TOU Contract Values

TOU Contract Values Tree

Service Agreement - Billing Scenario

NOTE:

This tab may not appear. This tab is suppressed if the quotation Contract Management module is [turned off](#).

This page allows you to define a [proposal service agreement's](#) billing scenario. Refer to [Proposal SAs Contain Billing Scenarios](#) for more information.

Open this page using **Menu > Customer Information > Service Agreement > Search**, then navigate to the **Billing Scenario** page.

Description of Page

This page is protected if the service agreement being displayed is not a [proposal service agreement](#).

When a quote is generated for a proposal SA, the system creates a simulated bill segment for each billing scenario linked to the proposal SA. Each simulated bill segment shows the prospect how much their bill would be if the pricing terms on the proposal SA were applied to the billing scenario's consumption in the related time period.

NOTE:

You should not have to enter this information from scratch. You can set up the system to automatically generate billing scenarios when a proposal SA is created. Refer to [Proposal SAs Contain Billing Scenarios](#) for the details.

The following information is defined for each billing scenario:

- **Start Date** and **End Date** define the simulated bill segment's period.
- The grid contains the consumption that will be priced during this period:
 - **Unit of Measure** is the unit of measure of the service quantity.
 - **TOU** is the time-of-use code of the service quantity.
 - **SQI** is the service quantity identifier of the service quantity.
 - **Initial Service Quantity** is the initial quantity passed to the rate (and massaged by the rate's pre-processing calculation group(s), if any exist).
 - **Service Point ID** is used if your rate uses pre-processing calculation groups that require characteristic values from the service point or premise. For example, the calculation rule that converts CCF to therms uses a bill factor to store the conversion factor. This bill factor may have been configured to use characteristics on the service point / premise (e.g., the conversion factor may differ based on the storage location associated with the service point).

Service Agreement - SA Portal

Select **Menu > Customer Information > Service Agreement > Search** and navigate to the **SA Portal** page to view additional information associated with an SA.

Depending on your implementation's requirements, you may define additional zones to appear on this Portal.

The contents of this section describe the zones that are available on this portal page.

General Information displays **SA ID** and **SA Info**.

Consumer Contract Products displays the service agreement's consumer contract products. **Add**, **Edit** and **Delete** actions are provided.

Maintaining SA Relationships

The SA Relationship page contains information about a specific relationship between a service provider and a customer.

WARNING:

The following page looks deceptively simple. It's not. Refer to [The Big Picture of SA Relationships and Service Providers](#) for more information.

Open **Customer Information, SA Relationship** to maintain this information.

Description of Page

The **SA Relationship Info** is a concatenation of important information about the SA relationship record. The **SA RelID** is a system-assigned random number that stays with a SA relationship record for life. This value is assigned when the record is added to the database.

SA Relationship Status defines the state of the SA relationship. The buttons beneath the status are used to change the state:

- Click the **Activate SA Rel** button to activate a *Pending* SA relationship. This button is only enabled when the status of the SA relationship is *Pending*.
- Click the **Cancel SA Rel** button to *Cancel* an *Active* or *Pending* SA relationship. This button is only enabled when the status of the SA relationship is *Active* or *Pending*.

NOTE:

Automatic SA Relationship creation and activation. The system automatically creates and activates required SA Relationships when the Activate SA background process sees that there are required SA relationships for the master SA Type.

Account ID is the account associated with the **Service Agreement ID**. This field is protected after the SA relationship has been added to the database.

Use **Service Agreement** to define the "master" service agreement ID that has a relationship. This field is protected after the SA relationship has been added to the database.

Premise is a display-only field that shows the **Service Agreement's** characteristic premise (i.e., the primary premise associated with the service agreement).

Use **SA Relationship Type** to define the type of relationship. This field is only enabled if:

- a **Service Agreement ID** is specified, and
- the status of the SA Relationship is not *Cancelled*, and
- all sub SAs in the grid at the bottom of the page (if any) are *Cancelled*.

Enter the **Effective Date** of the relationship. This field is only enabled if:

- a **SA Rel Type** is specified, and
- the status of the SA Relationship is not *Cancelled*.

Usage defines how this relationship is used. The following options are available:

- **Relationship With SPr.** Use this option if this relationship is used to define a relationship between a customer and a service provider.
- **Expire SA Relationship.** Use this option if this relationship expires any prior relationship between a customer and a service provider and there is no relationship with a service provider going forward.

The **Service Provider** associated with this relationship is the one who provides the related service, if any. You can only choose service providers who are linked to the "master" service agreement's SA type and the above **SA Rel Type**. This field is only enabled if:

- **Usage** is *Relationship with SPr*, and
- a **SA Rel Type** is specified, and
- the status of the SA Relationship is not *Cancelled*, and
- all sub SAs in the grid at the bottom of the page (if any) are *Cancelled*.

If the **Service Provider** reads the customer's meter (as defined on the service provider's record), the customer's override **Read Cycle** should be defined. This field is only enabled if:

- a **Service Provider** is specified, and

- the **Service Provider** has the ability to override the service point's *service cycle*, and
- the status of the SA Relationship is not *Cancelled*

The **Account Number in Provider's CIS** is the customer's ID in the service provider's system. This field is only enabled if:

- a **SA Rel Type** is specified, and
- the status of the SA Relationship is not Cancelled.

The **Create Sub SA** button is used to create [Sub Service Agreements](#) for a service provider for which your organization provides billing services. This button will be gray if:

- you do not provide billing services for the service provider (i.e., the service provider doesn't have a billing relationship of *It's Us* or *We Bill For Them*), or
- if the SA relationship's **Status** is not *active*, or
- if the status of the master **Service Agreement** is not *Active*, *Pending Start*, or *Pending Stop*.

The grid at the bottom contains the sub service agreements (if any) that exist when your organization provides billing service for the **Service Provider**. You can click the Go To button on a row to transfer to the sub service agreement. Refer to [Sub Service Agreements](#) for more information. Note: you can click the **Create Sub SA** button to create sub service agreements for a service provider.

NOTE:

Automatic sub SA creation. The system will automatically create sub service agreements for you. It does this when the Analyze SA Relationships background process (known by the batch control ID of ANLYZSAR) sees that a new SA relationship has been activated.

Service Provider SA Relationship

Use this page to manage a service provider's SA relationships and customers. You can view a given service provider's SA relationships of a given type that is in effect on a specified date. You can expire existing relationships or add new relationships. This page is particularly useful for managing [negotiated terms](#).

Open **Menu > Customer Information > Service Provider SA Relationship** to view this information.

Description of Page

Enter the **Service Provider** and **SA Relationship Type** of the SA relationships that should be displayed.

Enter an **Effective Date**. This date filters the results so that only those SA relationships that are in effect on this date are shown.

Use **SA Filter** to restrict the SA relationships that are shown in the grid based on criteria of the related master service agreement. The following options are available:

- **Address.** Use this option to restrict SA relationships to those whose service agreements are linked to service points associated with a given **Address**, **City** and/or **Postal** code. Note, you can specify any combination of these fields.
- **All.** Use this option if you do not wish to restrict SA relationships based on service agreement attributes.
- **Geographic Type.** Use this option to restrict SA relationships to those whose service agreements are linked to premises or service points associated with a given **Geo Type** and **Value**.
- **SA Type.** Use this option to restrict SA relationships to those whose service agreements are linked to a given **CIS Division** and **SA Type**.

Don't forget to click the search button after changing the filters.

The **Select All / Clear All** buttons are used to select / unselect the SA relationships in the results grid. These buttons are enabled if there is at least one SA relationship in the results grid.

The grid that follows contains a line for each SA relationship that has a status of pending or active that meets the search criteria. Canceled SA relationships are not shown. If an SA relationship has more than one sub-SA, additional lines are used to show the additional sub-SA information. The following information appears in the grid:

- Select box. Use this checkbox to select SA relationships that you want to expire using the Expire SA Relationship(s) button.
- Click the go to button to transfer to the [Account - Main page](#) where you can perform maintenance functions on the account listed under Account Information.
- The **Account ID** column shows the account of the master SA linked to the SA relationship.
- The **Account Information** column shows information about the account identified by the account ID.
- Click the go to button to transfer to the [Premise - Main page](#) where you can perform maintenance functions on the premise listed under Premise Information.
- The **Premise Information** column shows information about the premise of the service point linked to the master SA of the SA relationship. If the master SA is linked to multiple service points, one is selected at random.
- The **Premise ID** column shows the ID of the premise whose premise information is shown.
- Click the go to button to transfer to the [Service Agreement - Main page](#) where you can perform maintenance on the service agreement listed under SA Information.
- The **SA Information** column shows information about the master SA that the SA relationship is linked to.
- The **SA ID** column shows the ID of the master SA that the SA relationship is linked to.
- Click the go to button to transfer to the [Service Agreement - Main page](#) where you can perform maintenance on the service agreement listed under Sub SA Information.
- The **Sub SA Information** column shows information about the sub SA linked to the SA relationship.
- The **Sub SA ID** column shows the ID of the sub SA linked to the SA relationship.
- Click the go to button to transfer to the [SA relationship page](#) where you can perform maintenance functions on the SA relationship listed under SA Relationship Information.
- The **SA Relationship Information** column shows information about the SA relationship meeting the search criteria.
- The **SA Relationship ID** column shows the ID of the SA relationship meeting the search criteria.

Following the grid is a section with action buttons that allow you to add or expire relationships for the given service provider:

- Press the **Expire SA Relationship(s)** button to expire the SA relationships that you have selected with the checkbox. You will be asked to confirm the date that you want the selected SA relationships to expire. Each selected SA relationship is expired by creating a new SA relationship without a service provider, i.e., its **Usage** is to Expire SA Relationship. This new SA relationship will be effective the day after the expiration date you specify. This is because an SA relationship that expires on a given day is deemed to be effective until the end of that day.
- Note that you can only expire SA relationships where the SA type and SA relationship type allow gaps in the relationship.
- Press the **Add SA Relationship** button to add a new SA relationship for the service provider and SA relationship type entered above. Enter the effective date for the new SA relationship and the service agreement that the new SA relationship is for. After confirmation, a new SA relationship is added in a pending status. Note that if there is an existing SA relationship with the same effective date whose **Usage** is Expire SA, this relationship is replaced by a new SA relationship with the given service provider.

Maintaining Premises

The premise record contains geographic information about your service addresses.

The following methods list the various ways in which premises can be created:

- A premise can be added via the [premise replicator](#).
- A premise can be added when an [order](#) is completed.
- A premise can be added using this transaction.

The topics in this section describe the premise maintenance transaction.

FASTPATH:

For more information about premises and their place in the "V", refer to [Understanding The "V"](#). For more information about the relationships between premises, service points, meters and items, refer to [An Illustration Of A Premise](#).

Premise - Main Information

The Premise page contains basic premise information. Open **Menu > Customer Information > Premise > Search** to maintain this information.

Description of Page

Basic information about the **Premise** and the premise's unique identifier (i.e., the **Premise ID**) are displayed on every page. These values only appear after the premise exists on the database. The ID is a system assigned random number that stays with a premise for life.

NOTE:

Formatting is performed by a plug-in. The basic information about a premise that appears at the top of this page (and on many other pages in the system) is controlled by a plug-in algorithm on the [installation record](#). Refer to the base package's premise format algorithm (PREM-INFO) for an example. If you prefer a different format, your system administrator should configure the system appropriately.

Indicate the **Premise Type** to categorize the type of premise.

The address's constituent fields vary based on the **Country**. Please refer to the [Country](#) page for more information.

NOTE:

Default note. A premise's **state, city, county, division, characteristics, trend area** and **geographic data** default from your postal default information. Refer to [Setting Up Premise & Service Point Postal Defaults](#) for more information. If you change the premise's postal code, the system will default geographic values based on the new postal code.

Use **CIS Division** to define the jurisdiction in which the premise is located if the premise type allows CIS Division. This defaults based on the **Country** and the **Postal**, but can be overridden here. If your implementation has set the Installation Option Control By CIS Division flag, the values are restricted to the user's CIS Division(s). See Users and CIS Division for more information. The value is defaulted to user's primary CIS Division, but that can be overridden by the postal defaults

The Validate button on the premise page will only be available if you have set the Allow Address Validation option type to Y on the General System Configuration feature configuration. Once clicked, the Address Validation Script on the General System Configuration feature configuration will be invoked to validate the entered address. Refer to [Implementing Address Validation](#) for more information.

Indicate whether the address is a valid **Mailing Address**. Premises that are valid mailing addresses may be specified as the mailing premise on an account. Refer to [Account - Person Information](#) for more information.

Use **Landlord Agreement** to define the landlord agreement that covers the premise, if any.

NOTE:

Landlord reversion. When you specify a landlord agreement on a premise, you are telling the system that service associated with the premise's service points should be reverted to the landlord's account when a tenant stops service. The system uses this information during the stop service process to automatically create pending start service agreement(s) for the landlord.

Managing a large number of premises for the same landlord If the [premise management](#) module is not **turned off**, the [premise management](#) page helps you to [manage the premises linked to the landlord](#).

If the [premise management](#) module is not **turned off**, you may reference a **Parent Premise** to include this premise in a [premise hierarchy](#).

At the bottom of this page is a [tree](#) that shows the various objects linked to the premise. You can use this tree to both view high-level information about these objects and to transfer to the respective page in which an object is maintained.

Premise - Characteristics

The Characteristics page contains information that controls taxation and other rate options that differ based on geography. Use **Menu > Customer Information > Premise > Search** and navigate to the **Characteristics** page.

Description of Page

Many charges that appear on bills associated with consumption at this premise are controlled by the premise's characteristic values (e.g., the taxing city defines the city tax percent applied to the premise's consumption). Refer to [An Illustration Of A Bill Factor And Its Characteristics](#) for more information.

Characteristics also matter if your rates were set up to convert measured consumption into some other unit of measure before charges can be calculated (e.g., converting a cubic foot of gas to its therm value). Refer to [All Calculation Rule-Based Rates Share a Common Structure](#) for more information about pre-processing calculation groups.

NOTE:

You can only choose characteristic types defined as permissible on the premise record. Refer to [Setting Up Characteristic Types & Their Values](#) for more information.

The following fields display:

Effective Date Indicate the effective date of the characteristic type and value. The effective date defaults from the [Installation Record](#) when you are adding a new premise. The effective date defaults to the current date when you are changing an existing premise.

Characteristic Type Indicate the type of characteristic.

Characteristic Value Indicate the value of the characteristic.

NOTE:

Default note. A premise's characteristics default from your postal default information. Refer to [Setting Up Premise & Service Point Postal Defaults](#) for more information. If you change the premise's postal code, the system will default characteristic values based on the new postal code.

Premise - Miscellaneous

The Miscellaneous page contains information meter read controls and life support information related to the premise. Use **Menu > Customer Information > Premise > Search** and navigate to the **Misc** page.

Description of Page

Turn on **OK to Enter** if the meter is located in the interior of the premise and your company has permission to enter.

Indicate a **MR Warning** if a specific warning should be downloaded to the person who reads the meter.

Indicate a **MR Instruction** if specific instructions should be downloaded to the person who reads the meter. Meter read instructions and warnings are downloaded as part of the meter read download.

Use **Instruction Details** to provide more detailed instructions to the individual who reads meters at this premise.

Turn on **Key at Premise** if the meter is secured in a locked area and your company has the key. If this field is turned on, you may also specify the **Key ID**.

Indicate if the premise has life support or sensitive load equipment. Valid values are: LS/SL (i.e., the premise has life support / sensitive load equipment), None. If a value of LS/SL has been selected, define the type of equipment in **Life Support / Sensitive Load Notes**.

NOTE:

A person can also have life support / sensitive load information. If the equipment is personal (i.e., it travels with the person as they move from premise to premise), you should NOT specify the life support information on the premise. Rather, transfer to [Person - Main](#) and specify life support information on the person.

Alert and C&C. If the base package's C1-LSSL-PREM algorithm is enabled on the installation record, and life support / sensitive load information is specified, an alert will appear when the premise is displayed on control central. In addition, if a premise has life support or sensitive load equipment, it is possible for a different credit & collection severance process to be kicked off if the account associated with the premise has overdue debt. Refer to [Designing Your Severance Procedures](#) for more information.

Premise - Geographic Data

The Geographic Data page contains information that defines where the premise is located. Use **Menu > Customer Information > Premise > Search** and navigate to the **Geographic Data** page.

Description of Page

Enter the **Time Zone** in which the premise is located. This value defaults from your [postal defaults](#).

The geographic information is used by [Control Central](#) to look for premises. The following fields display:

Geographic Type Indicate the type of geographic data.

Geographic Value Specify the coordinate value. If the entered value must be in a specific format, a description of the required format is displayed adjacent. For example, if you see the format 99A 99A 99 9, you must enter 2 numbers, followed by a letter, followed by a space, followed by 2 numbers, followed by a letter, followed by a space, followed by 2 numbers, followed by a space, followed by a single number.

NOTE:

Formatting is performed by a plug-in. The format that is applied to a **Geographic Value** is controlled by the algorithm that is plugged in on the respective [Geographic Type](#). If you prefer a different format, your system administrator should configure this algorithm appropriately. Note, algorithms of this type will NOT convert the input value into the relevant format (i.e., you must enter the information in the exact format dictated by the algorithm).

Default note. A premise's geographic data defaults from your postal default information. Refer to [Setting Up Premise & Service Point Postal Defaults](#) for more information. If you change the premise's postal code, the system will default geographic values based on the new postal code.

Premise - Alternate Address

WARNING:

This tab only appears if you have enabled alternate addresses on the installation record. Refer to the description of the Alternate Representation field under [Installation - Main](#) for more information.

This page is used when you have an alternate way to define a premise's address. This is typically used in countries that use multiple character sets (e.g., the **Main** address is entered in Chinese, the **Alternate Address** is entered in English). When a premise has an alternate address, both the main and alternate addresses can be used to search for a premise.

Open **Menu** > **Customer Information** > **Premise** > **Search** and navigate to the **Alternate Address** page to maintain this information.

Description of Page

The remaining fields on the page are used to define the premise's alternate address.

The address's constituent fields vary based on the **Country**. **Country** is always protected on this page because a premise's alternate address must be located in the same country as its main address. Please refer to the [Country](#) page for more information about address constituents.

NOTE:

Default note. An alternate address's **state**, **city** and **county** default from your postal default information. Refer to [Setting Up Premise & Service Point Postal Defaults](#) for more information.

The **Swap Main / Alt Address** button becomes enabled when you've entered an **Alternate Address**. When clicked, the contents of the address on the **Main** tab are swapped with the **Alternate Address**.

Premise - Premise Portal

Select **Menu** > **Customer Information** > **Premise** and navigate to the **Premise Portal** page to view additional information associated with a Premise.

Depending on your implementations requirements, you may define additional zones to appear on this Portal.

The contents of this section describe the zones that are available on this portal page.

General Information

Premise ID, **Premise Info** are displayed.

Maintaining Service Points

Service point records contain information describing the services supplied to a premise.

The following methods list the various ways in which service points can be created:

- A service point can be added when a premise is created using the [premise replicator](#).
 - A service point can be added when an [order](#) is completed.
 - A service point can be added using this transaction.
-

FASTPATH:

For more information about service points and their place in the "V", refer to [Understanding The "V"](#). For more information about the relationships between premises, service points, meters and items, refer to [An Illustration Of A Premise](#).

Dashboard Portal

The [Dashboard](#) is a portal that always appears on the Oracle Utilities Customer Care and Billing desktop. Its zones contain tools and data that are useful regardless of the object being displayed.

NOTE:

User configurable. Refer to [Each User Can Customize Which Zones Appear](#) for information about a user can configure which zones appear.

Global context. The system automatically refreshes the values saved in [global context](#) with information about the object that appears in [Object Display Area](#). Various zones available in the dashboard portal have been designed to display data related to a person id, account id or premise id, which are populated by the base global context algorithm C1-GLBL-CTXT.

The contents of this section describe the zones that are available on this portal.

NOTE:

Other zones exist. The zones described below are unique to Oracle Utilities Customer Care and Billing. Please see [Core Dashboard Zones](#) for a description of other zones that can appear on the dashboard.

Current Context Zone

The **Current Context Zone** contains basic information about the customer on which you are working.

A maximum of six rows may appear:

- The first row contains a person [context menu](#) and the person's name. You can click on the person's name to transfer to the [Person - Main](#) page. Note, the person's name is formatted by a plug-in algorithm on the [installation record](#). Refer to the base package's name format algorithm (PERS-INFO) for an example. If you prefer different formatting logic, your system administrator should configure the system appropriately.
- The second row contains an account [context menu](#) and the account's:
 - ID and check digit
 - The primary name of the main customer
 - Customer class
- The third row contains a premise [context menu](#) and the premise's address and premise type. Note, the address information is formatted by a plug-in algorithm on the [installation record](#). Refer to the base package's premise format algorithm (PREM-INFO) for an example. If you prefer a different format, your system administrator should configure the system appropriately.
- The fourth row contains a service point context menu and the service point's information; including:
 - Premise address
 - Service point type
 - Measurement cycle and route

- Status of the service point
- The fifth row contains a device context menu and the device's information; including:
 - Badge number
 - Device type
 - Device installation date/time
 - Status of the device
- The last row contains a measuring component context menu and the measuring component's information; including:
 - The associated device's badge number
 - Measuring component type

NOTE: If a premise has multiple service points, only one will be displayed in the Current Context Zone.

Customer Contact Zone

The **Customer Contact Zone** has three purposes:

- It shows the age of the **Last** customer contact associated with the person displayed in the Current Context zone. The word Today is shown if the last contact was on the current date. The word Yesterday is shown if the last contact was on the current date - 1 day. If neither is applicable, the number of days old is shown.
- It shows the name of the person who added this contact.
- It greatly simplifies the addition of a new customer contact. To add a new contact, simply select the **Type** of customer contact, enter a brief **Comment**, and press the **Add Contact** button.
- After the contact is added, you can click the hyperlink in the **Last** area to go to the newly added contact where you can set up [reminders](#) or indicate the contact should [remain open until future resolution](#).

Financial Information Dashboard Zone

The **Financial Zone** that appears on the dashboard contains the same information that is described in the [Financial Information Zone](#) on the account information portal.

Alert Dashboard Zone

The **Alert Zone** that appears on the dashboard contains the same information that is described in the [Alert Zone](#) on the account information portal.

Setting Up Bill Print Groups

Bill print groups allow you to categorize an account's service agreements into groups for bill print purposes.

NOTE:

Bill print groups are optional. Typically, only accounts with many SAs will use bill print groups because the standard bill print priority is sufficient for accounts with a limited number of SAs. Refer to [SA Type - Billing](#) for more information about the standard bill print priority.

Let's use an example to clarify the bill print group concept. Consider a local government's account. This account would have many service agreements (some for the police department, others for the court system, others for the department of public works, etc.).

If you don't create a bill print group for this customer, their bill segments will be printed in the order dictated by each segment's service agreement's SA type's bill print priority. If you create a bill print group for this customer, you can define the customer's desired categories (e.g., police, courts, DPW, etc.) and then link each of the account's SAs to the appropriate category.

NOTE:

Nomenclature. We refer to the categories under a bill print group as "subgroups". A bill print group can have an unlimited number of subgroups. When you create a subgroup, you define its relative bill print priority and the associated verbiage to print on the bill (assuming you print information about the subgroup on the bill).

We'd like to highlight the following characteristics of bill print groups:

- A bill print group is associated with a specific account. If multiple customers have the exact categorization preferences, you will have to set up multiple bill print groups.
 - Over time, a customer could have many bill print groups. This would happen if a customer's bill categorization preferences change over time. We'd like to stress that while an account can have multiple bill print groups, only one will be used by the bill print process (the one effective on the bill date).
 - Bill print groups only affect printed bills. Bill print groups do not affect the order in which service agreements appear on the bill maintenance transaction.
 - If new service agreements are added after a bill print group is set up for an account, they will not be linked to a subgroup. If you neglect to link the new service agreements to one of the bill print group's subgroups they will be printed under the "default" subgroup (every bill print group must have one default subgroup to cater for this situation).
-

WARNING:

While the system supports the definition of bill print groups and the categorization of an account's service agreements into the various subgroups, the base package's bill print extract does NOT take advantage of this information.

The topics in this section describe how to set up a bill print group and how to link an account's service agreements to its subgroups.

Bill Print Group - Main

Open **Menu > Customer Information > Bill Print Group > Search** to maintain an account's bill print group and subgroups. After defining this information, transfer to the **SA Sub Group** page to link the account's service agreements to the subgroups.

Description of Page

The **Bill Print Group ID** is displayed on every page. This value only appears after the bill print group exists on the database. The ID is a system-assigned random number that stays with a bill print group for life.

Enter the **Account ID** associated with the bill print group.

Use **Effective Date** to define when the bill print group is effective for the account. This date is important as it allows a customer to change their preferences over time. For example, if the customer wants to change the number of subgroups on a

given date, you would simply add a new bill print group effective on this date and then define the new subgroups (and link each service agreement to one of the subgroups).

Use **Status** to define if the bill print group is Active or Inactive. You would only use the Inactive value if the bill print group is no longer needed (as there is no delete action on this transaction).

Enter a brief **Description** of the bill print group.

Use **Comments** to describe anything special about the bill print group.

The grid contains the bill print group's subgroups. The following information should be defined for each subgroup:

- **Bill Print Sub Group.** This is the unique identifier of the bill print subgroup.
- **Sub Group Bill Print Priority.** This is the relative print priority of the subgroup in respect of the other subgroups.
- **Use as Default.** Turn on this switch for the default sub group. A bill print group must have one and only one default subgroup. The default group is used by the bill print process if it detects a service agreement that is not linked to a subgroup (it links this service agreement to the default subgroup).
- **Sub Group Description.** This is a brief description of the subgroup.
- **Description on Bill.** This is the verbiage that will print on the bill (assuming you print something on your bills for the subgroup).

After defining the bill print group's subgroups, navigate to the **SA Sub Group** tab to link the account's service agreements to the subgroups.

Bill Print Group - SA Sub Group

This page is used to link the account's service agreements to one of the bill print group's subgroups.

Open **Menu > Customer Information > Bill Print Group > Search** and navigate to the **SA Sub Group** page to maintain this information.

Description of Page

The **Bill Print Group's ID**, **Account ID** and **Effective Date** are displayed at the top of the page.

The filters control the service agreements that appear in the **SAs in Bill Print Group** grid. The following points describe the various options:

- Use the **SA Filter** to define the types of service agreements that appear in the grid. The following options are available:
 - **Address.** Use this option to restrict service agreements to those linked to service points associated with a given **Address**, **City** and/or **Postal** code. Note, you can specify any combination of these fields.
 - **All.** Use this option if you do not wish to restrict service agreements based on service agreement attributes.
 - **Bill Print Sub Group.** Use this option to restrict service agreements to those that are linked to a given **Bill Print Sub Group**.
 - **Geographic Type.** Use this option to restrict service agreements to those linked to service points associated with a given **Geo Type** and **Value**.
 - **SA Type.** Use this option to restrict service agreements to those linked to a given **CIS Division** and **SA Type**.
- Use **Status Filter** to restrict the service agreements based on their status. The following options are available:
 - **All.** This option shows all service agreements regardless of status.
 - Refer to [Service Agreement Lifecycle](#) for the various status values.

Don't forget to click the search button after changing the filters.

The **SAs in Bill Print Group** contains an entry for every non-cancelled service agreement linked to the account that is linked to one of the bill print group's subgroups. The following information appears in the grid:

- Use **Bill Print Sub Group** to define the subgroup associated with the service agreement.
- Use **Sequence** when there is more than one service agreement in the subgroup. The sequence controls the order in which the service agreement's financial information appears on the bill.
- The **SA Information** column provides a brief description of the service agreement.
- The **Service Agreement** column contains the unique identifier of the service agreement.
- The **Premise Information** column contains the characteristic premise associated with the bill segment's service agreement.

The next set of filters control the service agreements that appear in the **SAs Not in Bill Print Group** grid. The following points describe the various options:

- Use the **SA Filter** to define the types of service agreements that appear in the grid. The following options are available:
 - **Address.** Use this option to restrict service agreements to those linked to service points associated with a given **Address, City** and/or **Postal** code. Note, you can specify any combination of these fields.
 - **All.** Use this option if you do not wish to restrict service agreements based on service agreement attributes.
 - **Geographic Type.** Use this option to restrict service agreements to those linked to service points associated with a given **Geo Type** and **Value**.
 - **SA Type.** Use this option to restrict service agreements to those linked to a given **CIS Division** and **SA Type**.
- Use **Status Filter** to restrict the service agreements based on their status. The following options are available:
 - **All.** This option shows all service agreements regardless of status.
 - Refer to [Service Agreement Lifecycle](#) for the various status values.

Don't forget to click the search button after changing the filters.

The **SAs Not in Bill Print Group** contains an entry for every non-cancelled service agreement linked to the account that is NOT linked to one of the bill print group's subgroups. The following information appears in the grid:

- Use **Bill Print Sub Group** to define the subgroup associated with the service agreement.
- Use **Sequence** when there is more than one service agreement in the subgroup. The sequence controls the order in which the service agreement's financial information appears on the bill.
- The **SA Information** column provides a brief description of the service agreement.
- The **Service Agreement** column contains the unique identifier of the service agreement.
- The **Premise Information** column contains the characteristic premise associated with the bill segment's service agreement.

Landlord Reversion

Landlord reversion occurs when a landlord would like to have service reverted to his/her name when a tenant moves out. The landlord defines his/her reversion preferences using a [landlord agreement](#).

- A landlord's preferences can differ for each type of service. For example, you can indicate that a specific landlord always wants electric and gas service reverted to his/her account when a tenant stops service. However, they do not want water service to revert.
- A landlord's preferences can also be seasonal. For example, you can indicate water service should only revert to the landlord's account during the winter.

The account to use for the reversion of service is defined on the landlord agreement.

Assuming that you have plugged-in a landlord reversion algorithm on [SA type](#), the system uses the information defined on landlord agreement to create a pending start service agreement(s) for the landlord when service for the existing tenant is stopped.

The following examples illustrate how your organization's landlord reversion algorithm might handle various scenarios for a premise that defines a landlord agreement that indicates service should be reverted:

- When the existing customer calls to stop service and no new customer is scheduled to move in, a pending start service agreement is created for the landlord.
- When a new customer calls in to start service
 - If the start date matches the outgoing customer's start date, the pending start service agreement for the landlord is canceled
 - If the start date is earlier than the outgoing customer's stop date, the pending start service agreement for the landlord is canceled and the stop date of the outgoing customer is changed to match the new date
 - If the start date is later than the outgoing customer's stop date, the pending start service agreement for the landlord is updated with a stop date that matches the new customer's start date
- If changes are made to start or stop dates for the tenants' service agreements, a service agreement for the landlord may need to be created or canceled
 - If the change in dates causes a gap in service that did not exist before, a landlord service agreement is created to cover the gap
 - If the change in dates means that the tenants are now starting and stopping on the same date (and there used to be a gap), a landlord service agreement is canceled
- If the new customer cancels their pending stop, a landlord service agreement is created (if one did not exist) or the landlord SA's stop date is removed (if the new customer's start date resulted in a gap that was being covered by the landlord).

Setting Up Landlord Agreements

The landlord agreement page is used to maintain a landlord's service reversion preferences.

NOTE:

A landlord could have many landlord agreements. A landlord will have at least one landlord agreement. However, if the landlord has different service reversion preferences for different properties, you can create multiple landlord agreements - one for each set of preferences. After a landlord's reversion preferences have been defined, link the landlord agreement record to the respective premises.

Use **Menu > Customer Information > Landlord Agreement > Search** to maintain a Landlord Agreement.

Description of Page

Landlord and **Landlord ID** only appear after the landlord is added to the database. **Landlord ID** is a system-assigned random number that stays with the landlord agreement for life. **Landlord** is the description of the landlord agreement.

If the [premise management](#) module is not **turned off**, a message is displayed indicating the number of premises linked to this landlord. Clicking the hyperlink message text transfers you to the [premise management](#) page, which helps you to [manage the premises linked to the landlord](#).

Enter a **Description** of the landlord agreement.

Use **Account ID** to define the account to use when service is reverted to the landlord. This should be one of the landlord's accounts.

The grid that follows contains one row for each type of service to be reverted to the landlord's account. Any service point whose service type is not referenced in this scroll will NOT revert to the landlord's account when a tenant stops service. For each row define the following:

- **Service Type** defines the type of service point that will revert to the landlord's account when a tenant stops service. Note, a service point inherits its service type from its SP Type.
- Turn on **Seasonal** if the service should only revert to the landlords account during a specific season of the year. When turned on, you must define the **Start Month/Day** and the **End Month/Day** of the effective season.

NOTE:

The month and day must be entered in the format MM/DD. For example, if a season starts on March 1, you must enter the value as 03/01.

Using The Premise Replicator

You use the premise replicator to create many copies of a premise and its service points.

Perform the following steps to replicate a premise:

- Add a [premise](#).
- Add one or more to the premise.
- Use the [premise replicator](#) to create copies of the premise and its service points.

The topics in this section describe how to use the premise replicator.

Premise Replicator - Main Information

You use this page to create many copies of a given premise and its service points.

WARNING:

The system warns you if you attempt to create. However, this is just a warning as you may want to generate similar premises and then update them with, for example, a unique apartment number on [Premise - Main Information](#).

Use **Menu > Customer Information > Premise Replicator** to open this page.

Description of Page

Choose the **Premise** that serves as the template premise.

NOTE:

Recommendation. Carefully verify the template premise using the other pages in this page before you save the replicated premises. After you save the replicated premises, any corrections could prove time consuming.

The two sections at the top of the page determine the number of replica premises to be created and the address information that will be set up for each premise. The left section is used to define how the system will create the part of the address that is *different* for each replica premise. The right section defines the parts of the address that will be the *same* for each replica premise.

In the left section:

Use the **Replicate** option to control how the position of the replicated number in the first address line:

- Choose Street Number if the replicated number should prefix the **Base** value in the first address line of the premise. For example, if you have a **Start #** of 1020 and a **Base** value of Main St and you choose the Street Number option, the first replicated premise will be 1020 Main St.
- Choose Apartment Number if the replicated number should suffix the **Base** value in the first address line of the premise. For example, if you have a **Start #** of 1020 and a **Base** value of 101 Main St, Apt. and you choose the Apartment Number option, the first replicated premise will be 101 Main St, Apt. 1020 .

Indicate the **Number Of Premises** you wish to create.

Use **Base** to define the information that will appear at the end of the first address line on each of the replicated premises. Use **Start #** to define the number assigned to the first copy of the premise. Use **Increment** to define the value to increment successive numbers by. The first and last address lines to be created by the replicator are displayed below.

For example, if the first address you want to create is 101 Derby St, and the last address is 199 Derby and you want to do the odd numbered side of the street, you'd enter the following parameters:

Number of Premises would be 50

Address Suffix would be Derby St

Start From would be 101

Increment by would be 2

The right section displays the rest of the address information that will be copied onto each replicated premise. This information is defaulted from the template premise that you selected. The Address 1 field is not shown because you define the information to be entered there in the previous section, as explained above. The remaining fields, however, may be edited if so desired.

After entering the parameters, click the **Replicate** button to generate your new premises. You can use the sections at the bottom of the page to view the premises that will be created when you click save. The left section will show how Address Line 1 will look on the first 10 premises. If you are creating more than 10 premises, the right section will show how Address Line 1 will look on the last 10 premises. If everything looks clean, click save.

Premise Replicator - Premise

The Premise page is a display only page provided to let you confirm that the premise you selected on the add dialog is the one to be used as the template by the replicator. Use **Menu > Customer Information > Premise Replicator** and navigate to the **Premise** page.

Description of Page

This is a display only page that displays key information about the premise being replicated.

Premise Replicator - Premise SPs

This is a display only page provided to let you confirm that the premise you selected on the add dialog is the one to be used as the template by the replicator. Use **Menu > Customer Information > Premise Replicator** and navigate to the **Premise SPs** page.

Description of Page

This is a display only page that displays the details about the template premise's service points.

Start/Stop

The topics in this section describe how to start and stop service.

WARNING:

Please see [Order versus Start/Stop](#) for a discussion of the pros and cons of using the order transaction versus the start/stop transaction to start service.

The Big Picture Of Starting Service

Almost all requests to start service involve a conversation between a customer and a customer service representative (CSR). During this conversation, the following is defined:

- WHO will pay for the service (i.e., the account).
- WHERE the service is consumed (i.e., the premise). Note, this is only required for premise-oriented services.
- WHEN the service is requested (i.e., the start date).
- WHAT TYPE of service is desired (i.e., the service agreement and service points).
- HOW MUCH will be paid for the service (i.e., the rate and contract riders).

After the conversation is complete, one or more service agreements in the state of pending start will exist. If the service agreement uses service points, field activities may also be created.

In this section, we provide background information about the start process. For information about the page used to start service, refer to [Start Stop Maintenance](#).

The Lifecycle Of A Pending Start Service Agreement

When you request a new service for a customer, a pending start service agreement is created. The following diagram illustrates the lifecycle of a typical pending start service agreement:

The above diagram is referenced in the topics that follow.

Starting Service and Field Activities

When you initiate a request to start service, the system creates a service agreement in the state of pending start. If the service agreement is service point-oriented, pending necessary to start will be created at some point prior to the service agreement being activated. The question is when? The contents of this section provide information about when they are created and what types of activities are created.

FASTPATH:

When you enable the Control Central alert algorithm, C1-PEND-STRT, an alert displays when there is a pending start service agreement linked to the account. This algorithm is plugged-in on the [installation record](#).

What Type Of Start Field Activities Are Created

In addition to being linked to the service points, these are also linked to the service agreement / service point relationship so that the system can automatically activate the service agreement when they are complete.

NOTE:

Back-to-Back. We use the term **back-to-back** to describe the situation when a single field activity supports both the stop and start service requests. The fieldwork algorithm delivered with the base package sets up a back-to-back situation by default when it is aware of both the start AND stop customers at a premise.

FASTPATH:

For more information about the field activities associated with your SP types, refer to [Setting Up Field Activity Type Profiles](#). Refer to [The System Activates Most Service Agreements Behind-The-Scenes](#) for information about how the system monitors field activities linked to a service agreement.

When Start Field Activities Are Created

will be created when the pending start service agreement is created if the following conditions are true:

- The Create Field Activity Start Stop switch is enabled on the installation record. Refer to [Installation Options - Main](#) for more information.
- The appropriate create fieldwork creation algorithm is defined on the service agreement's SA type. Refer to [SA Type - Algorithms](#) for more information.

If the Create Field Activity Start Stop switch is NOT enabled on the installation record, will NOT be created when the pending start is saved. Rather, a background process (PSASPM) creates the shortly before the start date. The number of days before the start date on which will be created is defined on the service agreement's SA type's fieldwork creation algorithm.

NOTE:

A fail safe. If any person or process attempts to activate a pending start service agreement and neither of the above events has taken place, field activities will be created when the user attempts to activate the pending start. The creation of the field activities will prevent the service agreement from being activated as described under [The System Activates Most Service Agreements Behind The Scenes](#).

WARNING:

will only be created if you have defined the appropriate field work creation algorithm on the service agreement's SA type. The algorithm that is supplied with the base package checks if the service agreement / service point already has a start, if so, will not be created (the field work has already been initiated).

Activating Pending Starts

When you initiate a request to start service, the system initiates a service agreement in the state of pending start. A pending start service agreement remains in this state until everything necessary to start service is defined in the system. At that time, the service agreement can be activated.

What Is Necessary To Start Service?

The service agreement's SA type defines what is necessary to start service:

- For SA types that have service points, all linked to the service point must be complete before the service agreement can be activated.
- For SA types that don't have service points (e.g., charitable donations, deposits, one-time charges), everything necessary to activate the service agreement is defined when you initiate the request to start service. These types of service agreements can be activated immediately.

The System Activates Most Service Agreements Behind-The-Scenes

Service agreements are activated by one of the following methods:

- The SA activation background process ([SAACT](#)) automatically activates pending start service agreements once it detects that everything necessary to start service is defined in the system. This is the most common method for activating service agreements. This process runs as often as your organization desires (but it should run at least daily).

NOTE:

Sub SAs are not handled by the SA activation background process. If your organization uses the [SA relationship](#) functionality and you have service providers that necessitate [sub service agreements](#), you should be aware that the SA activation background process only activates normal and master SAs; sub SAs are activated by the [analyze SA relationships](#) background process (described in the next bullet point).

- If your organization uses the [SA relationship](#) functionality and you have service providers that necessitate [sub service agreements](#), the analyze SA relationships background process ([ANLYZSAR](#)) automatically activates pending start sub SAs if their master SA is active.
- You can automatically activate a service agreement when it's created if you plug-in an SA creation algorithm of type SACR-AT on the SA type. Because everything necessary to start service must be defined in the system before a service agreement can be activated, this method only works for SA types that don't have service points (e.g., charitable donations, deposits, one-time charges, etc.). If this algorithm is not plugged in on an SA type, service agreements of that type are activated by the SA activation background process or manually.
- You can activate a service agreement manually (assuming everything that's necessary to activate service is in place). Simply open [Service Agreement - Main](#) and click the **Activate SA** button. This is only necessary if you do not want to wait until the SA activation background process next runs.

What Happens At Activation Time?

When a service agreement is activated, the following takes place:

- The service agreement's state is changed from pending start to active.
- If the account's bill cycle is not protected and the service agreement has a metered service point, the bill cycle will be changed to reflect the service point's bill cycle.
- If the account's mailing premise is not protected and the service agreement has a service point whose premise is a mailing premise, the mailing premise is changed to reflect the service point's premise.
- If the account's division is not protected, the division is changed to reflect the service agreement's SA type's division.
- If there is a start adjustment defined on the service agreement's start option, an adjustment is levied.

- The main customer's billing address is changed to reflect the value specified on the Start/Stop page (and this may involve changing the main customer's override mailing address on their person record).

What Happens After A SA Is Started?

FASTPATH:

Refer to [The Lifecycle Of A Service Agreement](#) for more information about a service agreement's lifecycle.

The Big Picture Of Stopping Service

To stop service you must define:

- WHO pays for the service (i.e., the account).
- WHEN service should stop (i.e., the stop start date).
- WHAT services to stop (i.e., the premise or specific service agreements).

After the above is defined in the system, the state of one or more service agreements will be changed to pending stop. If the service agreement uses service points, field activities may also be created.

In this section, we provide background information about the stop process. For information about the page used to stop service, refer to [Start Stop Maintenance](#).

The Lifecycle Of A Pending Stop Service Agreement

When you request to stop service for a customer, the status of an existing service agreement becomes pending stop. The following diagram illustrates the lifecycle of a typical pending stop service agreement:

The above diagram is referenced in the topics that follow.

Stopping Service and Field Activities

When you initiate a request to stop service, the system changes the service agreement to the state of pending stop. If the service agreement is service point-oriented, pending necessary to stop will be created at some point prior to the service agreement being stopped. The question is when? The contents of this section provide information about when they are created and what types of activities are created.

What Type Of Stop Field Activities Are Created

In addition to being linked to the service points, these are also linked to the service agreement / service point relationship so that the system can automatically stop the service agreement when the field activities are complete.

NOTE:

Back-to-Back. We use the term **back-to-back** to describe the situation when a single field activity supports both the stop and start service requests. The fieldwork algorithm delivered with the base package sets up a back-to-back situation by default when it is aware of both the start and stop customers at a premise.

FASTPATH:

For more information about the associated with your SP types, refer to [Setting Up Field Activity Type Profiles](#). Refer to [The System Finalizes Most Service Agreements Behind-The-Scenes](#) for information about how the system monitors linked to a service agreement.

When Stop Field Activities Are Created

will be created when the pending stop service agreement is recorded when the following conditions are true:

- The Create Field Activity Start Stop switch is enabled on the installation record. Refer to [Installation Options - System](#) for more information.
- The appropriate create fieldwork creation algorithm is defined on the service agreement's SA type. Refer to [SA Type - Algorithms](#) for more information.

If the Create Field Activity Start Stop switch is NOT enabled on the installation record, will NOT be created when the pending stop is saved. Rather, a background process (PSASPM) creates the shortly before the stop date. The number of days before the stop date on which field activities will be created is defined on the service agreement's SA type's fieldwork creation algorithm.

NOTE:

More information about the Create Field Activity Start Stop switch on the installation record. When this switch is on (and the user doesn't override it), pending will be created when a start or stop is recorded (as opposed to shortly before the start/stop date).

A fail safe. If any person or process attempts to finalize a pending stop service agreement and neither of the above events has taken place, will be created when the user attempts to finalize the pending stop. The creation of the will prevent the service agreement from being stopped as described under [The System Finalizes Most Service Agreements Behind The Scenes](#).

WARNING:

will only be created if you have defined the appropriate field work creation algorithm on the service agreement's SA type. The algorithm that is supplied with the base package checks if the service agreement / service point already has a stop , if so, will not be created (the field work has already been initiated).

Finalizing Pending Stops

When you initiate a request to stop service, the system changes the service agreement's state to pending stop. A pending stop service agreement remains in this state until everything necessary to stop service is defined in the system. At that time, the system automatically changes the state of the service agreement to stopped, and at that time the service agreement can be final billed.

So, how does the system know that "everything necessary" is in the system? In this section we provide the answer and explain the many other things that may take place at pending stop finalization.

The System Finalizes Most Service Agreements Behind-The-Scenes

The SA activation background process ([SAACT](#)) finalizes a pending stop service agreement when everything necessary is in place. The service agreement's SA Type defines what's necessary:

- For SA Types that don't have service points (e.g., charitable donations, deposits, third party billing), everything necessary to finalize the service agreement is defined when you initiate the request to stop service. These types of service agreements can be finalized immediately.
- For SA Types that have service points, all linked to the service point must be complete.

When the SA activation background process detects that everything necessary to stop service is in place, it automatically stops the service agreement. This process runs as often as your organization desires (but it should run at least daily).

NOTE:

Sub SAs are not handled by the SA activation background process. If your organization uses the [SA relationship](#) functionality and you have service providers that necessitate [sub service agreements](#), you should be aware that the SA activation background process only stops normal and master SAs; sub SAs are stopped by the [analyze SA relationships](#) background process.

You can stop a service agreement real-time (assuming everything that's necessary to stop service is in place). Simply open [Service Agreement - Main](#) and click the **Stop** button.

What Happens At Finalization Time?

When a service agreement is finalized, the following takes place:

- If the service agreement's SA type has a [SA Stop algorithm](#), the algorithm is executed.
- If the service agreement is for a [non-billed budget](#) (i.e., the SA type has a special role of Non-billed Budget), the system removes all covered SAs from the Non-Billed Budget. Refer to [Stopping Non-Billed Budgets](#) for more information.
- If the service agreement is covered by a [non-billed budget](#), the SA is removed from the Non-Billed Budget. Refer to [Stopping a Covered SA](#) for more information.
- When the last active service agreement covered by a non-billed budget is stopped, the Non-Billed Budget will be [stopped](#) (i.e., its state will be changed from active to pending stop).
- The service agreement's state will be changed from pending stop to stopped.
- If the service agreement has an active severance process, the process and its severance events will be canceled.
- If the service agreement is linked to an active collection process, the service agreement is "removed" from the collection process. If the collection process has no other active service agreements, it is canceled.
- When the last service agreement linked to an account is stopped, the account's bill cycle will be changed so that the account will be final billed when billing next executes. The system selects the latest open bill cycle where the Freeze and Complete switch value matches the value of the Freeze and Complete switch of the account's current bill cycle. In addition, the account's protect bill cycle flag is set to No so that the next time this account starts service, its bill cycle will be set based on the new service point's service cycle.
- The main customer's billing address will be changed to reflect the value specified on the Start/Stop page (and this may involve changing the main customer's override mailing address on their person record).
- If the service agreement is for a deposit (i.e., the SA type has a special role of Cash Deposit), the system calculates interest through the stop date. In addition, the SA's current balance is synchronized with its payoff balance (using the sync adjustment code defined on the service agreement's SA type).

- When the last active service agreement governed by a deposit class is stopped, all active deposit service agreements governed by the same deposit class will be stopped (i.e., their state will be changed from active to pending stop). These pending stop deposit service agreement will then be stopped (as per the above points).
- When a service agreement is stopped, the system automatically cancels the budget. Refer to [Canceling A Budget](#) for more information.

What Happens After A Service Agreement Is Stopped?

FASTPATH:

Refer to [The Lifecycle Of A Service Agreement](#) for more information about a service agreement's lifecycle.

Start/Stop Maintenance

You use the start/stop page to both start and stop service.

This page handles a variety of scenarios, including:

- Starting some or all services at a premise. Note, the system will automatically stop the existing customer when you indicate a new customer is starting.
- Stopping some or all services at a premise. Note, the system will automatically revert service to a landlord's account when you indicate a tenant is stopping.
- Starting non-premise-oriented services.
- Stopping non-premise-oriented services.
- Changing the mailing address associated with the account's main customer.

FASTPATH:

Refer to [The Big Picture Of Starting Service](#) for more information about starting service. Refer to [The Big Picture Of Stopping Service](#) for more information about stopping service.

The topics in this section describe the start/stop page in detail.

Start/Stop - Main

FASTPATH:

The **Description of Page** section that appears below simply describes the fields on this page. Refer to [How To](#) for a description of how to perform common start/stop functions.

Use **Menu > Customer Information > Start/Stop** to open this page.

Description of Page

The **Account ID** and the primary name of the **Account's** main customer are displayed at the top of the page.

If the total number of pending start/stops for the account does not exceed the start stop details threshold defined in [Installation Options](#), the grid contains an entry for every Pending Start and Pending Stop service agreement linked to the **Account ID**.

If information appears on the right portion of the grid, that means that "reciprocal relationships" exist. The following points describe potential reciprocal relationships:

- A reciprocal will be shown for a Pending Start service agreement if the Pending Start service agreement has at least one service point and if another service agreement is found that satisfies the following criteria:
 - The status of the service agreement is not Canceled or Active ,
 - The service agreement is linked to all of the Pending Start service agreement's service points (and all SA/SP records have the same stop date as defined on the qualifying service agreement).
 - The service agreement's stop date is on/before the start date.
 - The service agreement's SA type has a service type that is the same as the Pending Start service agreement's service type.
- Note: if multiple service agreements meet the above criteria, the latest qualifying service agreement is shown as the reciprocal.
- A reciprocal will be shown for a Pending Stop service agreement if the Pending Stop service agreement has at least one service point and if another service agreement is found that satisfies the following criteria:
 - The status of the service agreement is not Canceled
 - The service agreement is linked to all of the Pending Stop service agreement's service points (and they all have the same start date as defined on the qualifying service agreement).
 - The service agreement's start date is on/after the stop date.
 - The service agreement's SA type has a service type that is the same as the Pending Stop service agreement's service type.
- Note: if multiple service agreements meet the above criteria, the earliest qualifying service agreement is shown as the reciprocal.

NOTE:

If multiple reciprocals exist for a given SA, none of the reciprocals will be shown. In this situation, an appropriate message is displayed highlighting this situation. The existence of multiple reciprocals is rare, but it could happen, for example, if multiple customers are paying for a service point's service (where one customer pays for 60% of the metered consumption and the other pays for the remaining 40%).

The following columns appear in the grid:

Drill Down (button) Click this button to drill down into details of the pending start/stop SA. This button transfers you to the **Pending SA** tab.

Action An icon will be displayed to highlight if the associated SA is a pending start or a pending stop. The start icon (green octagon) appears if the SA is a pending start. The stop icon (red octagon) appears if the SA is a pending stop. If there is a reciprocal SA for the pending **start**, the stop icon appears adjacent; clicking it will cause the SA grid to scroll to the left (so that you can see the pending stop). If there is a reciprocal SA for the pending **stop**, the start icon appears adjacent; clicking it will cause the SA grid to scroll to the left (so that you can see the pending start).

Date This is the start date for pending start service agreements and the stop date for pending stop service agreements.

Cancel Turn on this switch if you wish to cancel the pending start/stop.

NOTE:

will be cancelled too. If you cancel a pending start/stop that has , the will also be cancelled. Refer to [Starting Service and Field Activities](#) for the details about how the system automatically creates the to support start service requests. Also, refer to [Stopping Service and Field Activities](#) for the details about how the system creates the to support stop service requests.

System-generated reciprocals will be cancelled too. If you cancel a pending start/stop that has a SYSTEM-GENERATED reciprocal SA, the reciprocal will also be cancelled.

Premise Information If a characteristic premise is linked to the service agreement, summary information about the pending start/stop SA's characteristic premise is displayed.

SA Information Summary information about the pending start/stop SA is displayed.

Action If this column is blank, then there is no reciprocal start/stop for the service agreement whose details appear to the left. If this column is not blank, then the information that appears to the right describes the reciprocal SA of the SA to the left. If a reciprocal SA exists, two icons will always appear: if a start and stop combination appears, the SA to the left is a pending stop (and clicking the stop icon will cause the pending stop to appear); if a stop and start combination appears, the SA to the left is a pending start (and clicking the start icon will cause the pending start to appear).

Date This is the start date for pending start service agreements and the stop date for pending stop service agreements.

Cancel Turn on this switch if you wish to cancel the pending start/stop.

NOTE:

will be cancelled too. If you cancel a pending start/stop that has , the will also be cancelled. Refer to [Starting Service and Field Activities](#) for the details about how the system automatically creates the to support start service requests. Refer to [Stopping Service and Field Activities](#) for the details about how the system creates the to support stop service requests.

System-generated reciprocals will be cancelled too. If you cancel a pending start/stop that has a SYSTEM-GENERATED reciprocal SA, the reciprocal will also be cancelled.

Account Info The name of the main customer associated with the reciprocal's service agreement's account is displayed.

Premise Information Summary information about the pending start/stop premise is displayed.

SA Information Summary information about the pending start/stop SA is displayed.

If the total number of pending start/stops for the account exceeds the start stop details threshold defined in [Installation Options](#), the **Total** number of **Pending Starts** and **Total** number of **Pending Stops** is displayed together with a grid containing a summary of the pending start and pending stops.

The grid contains an entry for every group of Pending Start / Pending Stop service agreement linked to the **Account ID** with the same pending start / pending stop date, action, premise, and CIS division/SA Type.

The following columns appear in the grid:

Date This is the start date for pending start service agreements and the stop date for pending stop service agreements.

Action An icon will be displayed to highlight if the associated SA(s) are pending start or pending stop. The start icon (green octagon) appears if the SA(s) are a pending start. The stop icon (red octagon) appears if the SA(s) are a pending stop. Click the icon to navigate to the [Start Stop - Pending SA](#) tab where the associated pending start / pending stop service agreements will be displayed.

Premise Information Summary information about the pending start/stop premise is displayed.

CIS Division / SA Type This is the CIS division and service agreement type of the pending start / pending stop service agreements.

Total This is the total number of service agreements with the same **Date**, **Action**, **Premise**, and **CIS Division / SA Type**.

Following the Pending Start / Pending Stop grid are two sections; one is used to start service, the other is used to stop service.

The following points describe the fields in the start service section (refer to [How To](#) for a description of how to perform common start functions).

- Use **Start Date** to define the date on which you want service to commence.
- Use **Start Method** to define what you want to start. Valid values are:

- Start Premise SPs. Use this method if you want to start selected services at a premise. This method allows you to control the display of the service agreements to be started, providing a manageable view when there are many service agreements to be started at a premise.
- Start a Premise. Use this method if you want to start services at a premise.
- Start a SA. Use this method if you want to start a non-premise-oriented service (e.g., a deposit, a charitable contribution, a one-time charge).
- If you have selected the Start Premise SPs or Start a Premise option, use **Address** and **City** to select the premise. Refer to [Control Central - Main](#) for suggestions in respect of how to use these fields. The selected address and premise ID appear below the selection.

NOTE: If the service agreement's account's CIS Division's **Restrict to Account CIS Division** flag is set to *Restricted*, the premise search is restricted to the premises without a CIS Division and those whose CIS Division matches the account's CIS Division,

- If you have selected the Start a SA option, use **CIS Division** and **SA Type** to define the type of service agreement you wish to start.

NOTE: If the service agreement's account's CIS Division's **Restrict to Account CIS Division** flag is set to *Restricted*, the CIS Division is set to the account's CIS Division and cannot be changed.

WARNING:

Take special care when adding a new service agreement to specify the appropriate CIS Division / SA Type as it will affect how the customer is billed, what rate can be specified, how overdue debt is collected, and much more. After the service agreement is activated, you may not change its SA type.

- Use **Requested by** to define who requested the stop (e.g., Customer, Jane Smith).
- Click the **Start** button to start service. When you click this button, the [Start Confirmation](#) page appears.

The following points describe the fields in the stop service section (refer to [How To](#) for a description of how to perform common stop functions).

- Use **Stop Date** to define the date on which you want service to stop.
- Use **Stop Method** to define what you want to stop. Valid values are:
 - Stop Selected SAs. Use this method if you want to stop selected service agreements linked to the account.
 - Stop a Premise. Use this method if you want to stop ALL services at a premise.
 - Stop a SA. Use this method if you want to stop a specific SA.
 - Stop all Active SAs. Use this method if you want to stop ALL service agreements linked to the account.
- If you have selected the Stop a Premise option, choose the **Premise ID**. You can optionally choose a specific premise if you selected the Stop Selected SAs option.
- If you have selected the Stop a SA option, choose the **SA ID**.
- Use **Requested by** to define who requested the stop (e.g., Customer, Jane Smith).
- Click the **Stop** button to stop service.

NOTE: Manual date entry is disabled on the start and stop dates and the date picker must be used when the Disable Manual Date Entry **Option Type** on the Customer Information Options [Feature Configuration](#) has been enabled.

Start/Stop - Start Confirmation

The Start SA Confirmation page appears after a user clicks the **Start** button on [Start/Stop - Main](#). This page presents a summary of the service agreement(s) that will be created if the **Start** button on this page is clicked. Refer to [How To](#) for a description of how to perform common start functions.

Description of Page

The **Account ID** and the primary name of the account's main customer are displayed at the top of the page.

The **Start Date** is the date on which the service is scheduled to start.

Start Requested By contains the name of the person who requested the start.

The **SAs to Start** scroll contains an entry for every service agreement that will be created if you click the **Start** button. If you do not want a service agreement to be created, click the - button (or turn off **Start this SA**). If you'd like to start a non-premise oriented service agreement, click the + button. The following fields appear on this page:

Start this SA Turn this switch on if you want this type of service agreement to be created. Turn this switch off if you do not want this type of service agreement to be created.

If you used a **Start Method** of Start a SA on the Start/Stop page, this switch will be turned on by default.

If you used a **Start Method** of Start a Premise (or Start Premise SPs) and this is the first customer at a premise, this switch will be turned on for all service agreements that appear in the scroll. However, if there was a previous customer at the premise, this switch is only turned on for those types of service agreements used by the previous customer (we assume the new customer only wants the services used by the previous customer). Service agreements that are possible, but were not used by the previous customer, will appear in the scroll with this switch turned off.

CIS Division / SA Type These fields define the type of service agreement that will be created. If you change the CIS Division, you must change the SA Type to reflect one of the services that the division manages.

NOTE: If the service agreement's account's CIS Division's **Restrict to Account CIS Division** flag is set to *Restricted*, the CIS Division is set to the account's CIS Division and cannot be changed.

If the SA is linked to a service point, the SA types are restricted based on the type(s) of service points (SP) the system has associated with the service agreement (as indicated in the message box). If there are no SPs, only SA types that don't use SPs are displayed. If there is a single SP, only SA types valid for the related SP Type are displayed. If there are multiple SPs, only SA types valid for all related SP Types are displayed.

Start Option Some SA Types have [start options](#). A start option defines the rate and contract terms defaulted on the service agreement. This field will be gray if the SA type does not use start options.

Total Amount to Bill Use this field if the service agreement is supposed to bill a given amount over its lifetime. This is typically used for deposit service agreements to define the amount of the deposit that should be billed. If the deposit is billed in installments, the installment amount is specified in the next field. This field is gray if the respective SA type doesn't use the Total Amount to Bill option.

 This button is only appears if the SA type has a "special role" of Cash Deposit and references a deposit class. When clicked, the system attempts to calculate a recommended deposit amount by calling the recommended deposit amount algorithm that is plugged in on the SA type's deposit class.

Customer Read Use this value to define if the customer reads his or her own meter. Valid values are Yes and No. This field does not appear for some SA types.

Recurring Charge Amount This field's label is dynamic based on the content of the Recurring Charge Amount Label on the respective SA Type. This field is gray if the respective SA type doesn't use the Recurring Charge option. This field is typically used only for the following types of service agreements:

- Service agreements on a levelized payment plan. This field contains the amount charged each month for the service regardless of the actual amount owed.
- Merchandise service agreements on an installment plan. This field contains the installment amount.
- Deposit service agreements on an installment plan. This field contains the installment amount.
- Charitable contribution service agreement. This field contains the contribution amount.

NOTE:

Default note. The recurring charge amount defaults based on the **Start Option**.

SIC Select the SIC code associated with the customer. This is typically used only for commercial and industrial customers.

Business Activity Enter a description of the business activity at the location where this service is being started.

SA Information This is a display-only area that provides information about the specific pending start SA. For example, information about the service points linked to the SA will be displayed for SP-oriented service agreements.

Messages This is a display-only area that provides information about the account's start/stop situation in general. For example, if there are multiple accounts paying for service at the premise an appropriate message will be displayed.

When you click the **Start** button, the system performs the following for every service:

- A service agreement is created effective on the start date.
- If a start option is specified, the service agreement's rate and contract terms are populated using information on the option. If a start option is not specified, the service agreement's rate is populated with the SA type's default rate.
- Service points are linked to the service agreement (if the service agreement is service point-oriented). The SA/SP start date for each service point is the same as the SA's start date.

If you use a **Start Method** of Start Premise SPs on [Start/Stop - Main](#), the **SAs to Start** are displayed in a grid; you can control the service agreements that appear using filter options. You may want to use the filter if you have a premise with a large number of service agreements to start.

Premise Info displays summary information about the premise at which services are to be started.

The section beneath **PremiseInfo** provides you with options that control which service agreements appear in the grid. The following points describe the various options:

- Use the **SP Type Filter** to restrict the service agreements that appear in the grid based on the SP type of the service points that will be linked to the service agreement. The following options are available:
 - All. Use this option if you do not wish to restrict service agreements based on service point type.
 - Specific SP Type. Use this option to restrict service agreements to those that will be linked to service points of a specific **SP Type**.
- Use the **Geographic Type Filter** to restrict the service agreements that appear in the grid based on a geographic type and value of the service points that will be linked to the service agreement. The following options are available:
 - All. Use this option if you do not wish to restrict service agreements based on a geographic type and value.
 - <Geographic Type>. Use this option to restrict service agreements to those that will be linked to service points associated with the selected geographic type and **GeographicValue**.
- Select whether to Include or Exclude service agreements that are linked to service points where **Service Exists Already**. These service agreements are those that would be not be started by default. Refer to the description of the **Start this SA** checkbox for more information on service agreements that would be not be started by default.

Don't forget to click the search button after changing the filters.

The **Select All / Clear All** buttons are used to select service agreements to start. These buttons are enabled if at least one service agreement is displayed in the grid.

NOTE:

30 service agreements at a time. Clicking **Select All** selects the first 30 service agreements in the grid. If more than 30 service agreements exist, you must select and start them in batches.

The grid that displays contains the **SAs to Start** that match your filter criteria. Click the drill down button to open the **Start SA Confirmation Details** page.

The fields in the grid on the Start SA Confirmation page and on the Start SA Confirmation Details page are as described above for the **SAs to Start** scroll. Differences are highlighted here:

SP Info This is summary information about the service point at which service is to be started.

SP Identifier The service point's SP type's identifying geographic type and value. Refer to . Up to three geo types and values are displayed in the SAs to Start grid.

Click the **Start** button on the Start SA Confirmation page to start the selected SAs. Click on the **Close** button to return to the main page - any changes made on this page since the last time you clicked **Start** are discarded.

Start/Stop - Stop Confirmation

If you choose the stop method of Stop Selected SAs, the Stop SA Confirmation page appears after a user clicks the **Stop** button on [Start/Stop - Main](#). This page presents a summary of the service agreement(s) that will be stopped if the **Stop** button on this page is clicked. Refer to [How To](#) for a description of how to perform common start stop functions.

Description of Page

The **Account ID** and the primary name of the account's main customer are displayed at the top of the page.

The **Stop Date** is the date on which the service is scheduled to stop.

Requested By contains the name of the person who requested the stop.

The section beneath **Requested By** provides you with options that control which service agreements appear in the grid. The following points describe the various options:

- Use the **Premise Filter** to restrict the service agreements to those that are linked to a specific characteristic premise. The following options are available:
 - All. Use this option if you do not wish to restrict service agreements based on premise.
 - No Premise. Use this option to restrict service agreements to those that do not have a characteristic premise.
 - Specific Premise. Use this option to restrict service agreements to those with a characteristic premise of **Premise ID**.
- Use the **SA Type Filter** to restrict service agreements to those of a given SA Type.
 - All. Use this option if you do not wish to restrict service agreements based on SA Type.
 - Specific SA Type. Use this option to restrict service agreements to those of a given **CIS Division** and **SA Type**.
- Use the **Geographic Type Filter** to restrict the service agreements that appear in the grid based on the geographic type and value of the service points that are linked to the service agreement. The following options are available:
 - All. Use this option if you do not wish to restrict service agreements based on a geographic type and value.
 - <Geographic Type>. Use this option to restrict service agreements to those that will be linked to service points / premises associated with the selected geographic type and **Geographic Value**.

Don't forget to click the search button after changing the filters.

The **Select All** / **Clear All** buttons are used to select service agreements to stop. These buttons are enabled if at least one service agreement is displayed in the grid.

NOTE:

30 service agreements at a time. Clicking **Select All** selects the first 30 service agreements in the grid. If more than 30 service agreements exist, you must select and stop them in batches.

The grid that follows contains the service agreements to stop that match your filter criteria. The following information appears in the grid:

Select Box Use this checkbox to select service agreements that you want to stop.

Premise Information Summary information about the pending stop premise is displayed.

SA Information Summary information about the pending stop SA is displayed.

SP Identifier The service point's SP type's identifying geographic type and value. Refer to [Setting Up Service Point Types](#). Up to three geo types and values are displayed.

Click the **Stop** button on the Stop SA Confirmation page to stop the selected SAs. Click on the **Close** button to return to the main page - any changes made on this page since the last time you clicked **Stop** are discarded.

Start/Stop - Address/Phone

Open **Menu > Customer Information > Start/Stop** and navigate to the **Address/Phone** page to change basic information about a customer while you are starting or stopping service.

NOTE:

A subset of person and account information. This page features a subset of person and account fields that typically change when a customer moves. You can always use the [Person](#) or [Account](#) transactions to change this information.

This information is held in limbo. The information on this page will only be updated on the respective person / account when the first service agreement linked to the account is activated or stopped (i.e., this information is held in limbo until the pending start / pending stop is activated / stopped).

Main customer information. The information on this page is associated with the account's main customer (as defined on [Account - Person Information](#)). If you need to change information about any other person linked to the account, you must transfer to [Account - Person Information](#) and make the changes there.

Use **Bill Route Type** to indicate how the bill is sent to the customer. If the **Bill Route Type** you select indicates that bills are routed via fax, make sure you specify a fax number in the **Telephone Numbers** below (note, the system knows which of a [person's phone numbers](#) is a fax number by the phone type). If the **Bill Route Type** you select indicates that bills are routed via Email, make sure to specify the person's **Email Address** below. If the **Bill Route Type** you selected indicates that bills are routed via the postal service, select the appropriate **Address Source**. You have the following options:

- Choose Mailing Premise on Account if bills should be sent to the [account's mailing premise](#). This address is displayed below.
- Choose Person if bills should be sent to the [person's mailing address](#). This address is displayed below.
- Choose Account Override if bills should be sent to the [account person's override address](#). This address is displayed below. Typically, you would only choose this option if the person has multiple accounts and each account's bills should be sent to a different address.

If the **Address Source** is Person or Account Override , the respective address fields are displayed and may be changed. If the **Address Source** is Mailing Premise on Account, the account's mailing premise is displayed and cannot be modified. Refer to [Premise - Main Information](#) for information about these fields.

NOTE:

Default note. If you switch the **Bill Route Type** from a non-postal to postal routed, the **Address Source** defaults to the bill address source defined on the account (if one exists) or Mailing Premise on Account if bill address source is not specified for the main customer.

NOTE:

By default, the **Address Source** field is protected on Start/Stop– Address/Phone page if the **Bill Route Type** is set to a value other than Postal. To enable the **Address Source** field for all **Bill Route Types** in most circumstances, set the Always Enable Address Source option type on the General System Configuration feature configuration to Y.

Regardless of the **Always Enable Address Source** option value, **Address Source** and **Address Information** are displayed but both are disabled when **Bill Routing Method** is *Not Postal* and **Quote Routing Method** (on Account – Persons page) is *Postal*. A message “*The Main Person receives Quotes at this address. To edit it, go to the 'Persons' tab on the Account.*” is displayed next to the **Address Source**.

FASTPATH:

Refer to [Setting Up Bill Route Types](#) for more information about bill route types.

NOTE:

The person contact collections appears when the Legacy Person Phone and Email Option Type on the Customer Information Options [Feature Configuration](#) has **not been** enabled.

The person contacts, from the [Person - Main](#) page are displayed so that you can review and update them as necessary.

NOTE: The Email Address field appears when the Legacy Person Phone and Email Option Type on the Customer Information Options [Feature Configuration](#) has been enabled.

Specify the customer's **Email Address**. This can be used to route bills to the customer via email (if your bill routing software supports this function).

Telephone Numbers are used by [Control Central](#) to look for accounts and persons. If the person has more than 20 phone numbers, the first 20 will be shown as display only with a message indicating that more phone numbers exist until you save your start or stop. Once the start or stop has been saved, you are able to modify the phone number collection.

NOTE: The Person Phone grid appears when the Legacy Person Phone and Email **Option Type** on the Customer Information Options [Feature Configuration](#) has been enabled.

The following fields display:

- **Phone Type** indicates the type of phone number, e.g., Home, Mobile, Business, ...
 - Use **Phone Number** to define the telephone number. Enter the telephone number in the format described by the **Phone Format**.
-

NOTE:

Formatting is performed by a plug-in. The format that is applied to a **Phone Number** is controlled by the algorithm that is plugged in on the respective [Phone Type](#). If you prefer a different format, your system administrator should configure this algorithm appropriately.

- Enter the **Extension**, if any, of the telephone number.
-

Start/Stop - Pending SA

If you need to change additional information about the pending start or stop SAs, navigate to the **Pending SA** tab. Alternatively, you can click the Drill Down button on the SA grid of the **Main** tab.

Description of Page

If the total number of pending start/stops for the account does not exceed the start stop details threshold defined in [Installation Options](#), an entry appears in the scroll for each entry in the SA grid on the main page. Use the **Pending Start/Stop SA** navigation arrow buttons to select the pending SA you want to review or modify. This page is split between the primary SA on the top, and the reciprocal SA on the bottom. The following fields are available.

Primary SA:

SA Info Summary information about the pending start/stop SA is displayed.

Cancel Turn on this switch if you wish to cancel the pending start/stop.

Date This is the start date for pending start service agreements and the stop date for pending stop service agreements.

Reason This column indicates if the pending start/stop is System Generated or Customer Requested. System-generated starts are created when a tenant stops service at a premise covered by a landlord agreement. System-generated stops are created when a customer requests a start at a premise where the existing customer hadn't already requested a stop.

CIS Division / SA Type These fields define the type of service agreement that will be created. These fields will be gray if the service agreement is pending stop.

If you change the CIS Division, you must change the SA Type to reflect one of the services that the division manages.

If the SA is linked to a service point, the SA types are restricted based on the type(s) of service points (SP) the system has associated with the service agreement (as indicated in the message box). If there are no SPs, only SA types that don't use SPs are displayed. If there is a single SP, only SA types valid for the related SP Type are displayed. If there are multiple SPs, only SA types valid for all related SP Types are displayed.

Start Option Some SA Types have [start options](#). A start option defines the rate and contract terms defaulted on the service agreement. This field will be gray if the SA type does not use start options or if the service agreement is pending stop.

Premise Summary information about the pending start / stop premise is displayed.

Reciprocal SA:

SA Info Summary information about the pending start/stop SA is displayed.

Cancel Turn on this switch if you wish to cancel the pending start/stop.

Date This is the start date for pending start service agreements and the stop date for pending stop service agreements.

Reason This column indicates if the pending start/stop is System Generated or Customer Requested. System-generated starts are created when a tenant stops service at a premise covered by a landlord agreement. System-generated stops are created when a customer requests a start at a premise where the existing customer hadn't already requested a stop.

CIS Division / SA Type These fields define the type of service agreement that will be created or stopped. This field will be gray if the service agreement is pending stop.

If you change the CIS Division, you must change the SA Type to reflect one of the services that the division manages.

If the SA is linked to a service point, the SA types are restricted based on the type(s) of service points (SP) the system has associated with the service agreement (as indicated in the message box). If there are no SPs, only SA types that don't use SPs are displayed. If there is a single SP, only SA types valid for the related SP Type are displayed. If there are multiple SPs, only SA types valid for all related SP Types are displayed.

Start Option Some SA Types have [start options](#). A start option defines the rate and contract terms defaulted on the service agreement. This field will be gray if the SA type does not use start options or if the service agreement is pending stop.

Premise Summary information about the pending start / stop premise is displayed.

Account The name of the main customer associated with the reciprocal's service agreement's account is displayed.

If the total number of pending start/stops for the account exceeds the start stop details threshold defined in [Installation Options](#), the pending start/stop SAs and their reciprocal SAs are displayed in a grid; you can control the service agreements that appear using filter options.

The section beneath **Account** provides you with options that control which service agreements appear in the grid. The following points describe the various options:

- Use the **SA Action Filter** to restrict the service agreements that appear in the grid to pending starts or pending stops. The following options are available:
 - All. Use this option if you do not wish to restrict service agreements based on SA Action.
 - Start. Use this option to restrict service agreements to pending starts.
 - Stop. Use this option to restrict service agreements to pending stops.
- Use the date filter to restrict service agreements to those that will start or stop between the **From Date** and the **To Date**.
- Use the **Premise Filter** to restrict the service agreements to those that are linked to a specific characteristic premise. The following options are available:
 - All. Use this option if you do not wish to restrict service agreements based on premise.
 - No Premise. Use this option to restrict service agreements to those that do not have a characteristic premise.
 - Specific Premise. Use this option to restrict service agreements to those with a characteristic premise of **Premise ID**.
- Use the **SA Type Filter** to restrict service agreements to those of a given SA Type.
 - All. Use this option if you do not wish to restrict service agreements based on SA Type.
 - Specific SA Type. Use this option to restrict service agreements to those of a given **CIS Division** and **SA Type**.
- Use the **Geographic Type Filter** to restrict the service agreements that appear in the grid based on the geographic type and value of the service points that are linked to the service agreement. The following options are available:
 - All. Use this option if you do not wish to restrict service agreements based on a geographic type and value.
 - <Geographic Type>. Use this option to restrict service agreements to those that will be linked to service points / premises associated with the selected geographic type and **Geographic Value**.

Don't forget to click the search button after changing the filters.

The **Select All** / **Clear All** buttons are used to select service agreements if you plan on issuing any of the mass update actions at the bottom of the page. These buttons are enabled if at least one service agreement is displayed in the grid.

NOTE:

30 service agreements at a time. Clicking **Select All** selects the first 30 service agreements in the grid. If more than 30 service agreements exist, you must select and start them in batches.

The grid that displays contains the service agreements that match your search criteria. Click on the drill down button to open the **Pending SA Details** page.

Please refer to the **Pending Start/Stop SA** scroll for a description of the fields in the pending start/stop SA grid on the Pending SA tab and on the Pending SA Details page. Additional fields are described here:

Pending SAs Grid:

- **Select box.** Use this checkbox to select service agreements for mass update.
- The **Action** icons highlight if the associated SA is a pending start or a pending stop and if there are reciprocal SAs. Refer to the action icon on [Start Stop - Main](#).

Mass Update Buttons:

Use the **Cancel Selected** button to cancel the selected pending start/stops together with any associated reciprocal pending start/stops. This button is enabled if you have selected one or more pending SAs.

Use the **Change Start/Stop Date** button to change the start/stop date for the selected pending start/stop service agreements. If a selected start/stop has a reciprocal SA, its start/stop date is also changed. This button is enabled if you have selected one or more pending SAs.

Start/Stop - Pending Field Activity

When you start/stop service point-oriented service, are typically created. You can view every non-cancelled, non-complete field activity linked to the account's service agreements on the **Pending Field Activity** page.

NOTE:

The are NOT limited to those associated with starting / stopping service. So, if a customer has a pending "cut for non payment" , it would also appear on this page.

Description of Page

An entry appears in the scroll for every Pending linked to the account's service agreements. The information in the **Field Activity** column contains a summary of the and its service point. The information in the **How Used** column describes the purpose of the (such as, Start Activity, Stop Activity, and Severance Activity).

If the total number of pending start/stops for the account exceeds the start stop details threshold defined in [Installation Options](#), you can control the that appear using filter options.

The section beneath **Account** provides you with options that control which appear in the grid. The following points describe the various options:

- Use the **Schedule Date** filter to restrict the that appear in the grid to those that are scheduled between. The following options are available:
 - All. Use this option if you do not wish to restrict field activities to a specific schedule date.
 - Specific Date. Use this option to restrict the field activities to those with a schedule date between the **From Date** and the **To Date**.
- Use the **Premise Filter** to restrict the to those that are linked to service points at a specific premise. The following options are available:
 - All. Use this option if you do not wish to restrict based on premise.
 - Specific Premise. Use this option to restrict to those linked to a service point at the given **Premise ID**.
- Use the **SP Type Filter** to restrict to those that are linked to service points of a given SP Type.
 - All. Use this option if you do not wish to restrict based on SP Type.
 - Specific SA Type. Use this option to restrict to those of a given **SP Type**.
- Use the **Geographic Type Filter** to restrict the that appear in the grid based on the geographic type and value of the service points that are linked to the service agreement. The following options are available:
 - All. Use this option if you do not wish to restrict based on a geographic type and value.
 - <Geographic Type>. Use this option to restrict to those that are linked to service points / premises associated with the selected geographic type and **Geographic Value**.

Don't forget to click the search button after changing the filters.

How To

The topics in this section describe how to perform common start/stop functions.

How To Start Service At A Premise

The following instructions specifically reference the *Start a Premise* Start Method. You can also use the *Start a Premise's SPs* Start Method and its corresponding user interface.

You navigate through the pages as follows:

- Use [Control Central - Main](#) to look for the customer. If the customer exists, click the Start Service button to transfer to Start/Stop. If the customer doesn't exist, add a new person/account by following the instructions under [How To Add A New Customer From Control Central](#).
- Specify the **Start Date**, **Start Method** (Start a Premise), and select a premise (by entering the premise **Address** and clicking the search button).
- Click the **Start** button to review the various service agreements that will be created.

NOTE:

Service agreements are created. Each row in the scroll is associated with a service agreement. When you close the page, the system creates new service agreements in the state of pending start.

- If you're starting service at a premise, the system automatically populates the Start Confirmation page with information about every service agreement to be created. To do this, we make a basic assumption - the customer wants every service at the premise. If this assumption is incorrect, simply remove the service agreement from the scroll (by turning off the **Start this SA** switch) before closing the page.

NOTE:

Automatically stop the existing customer. If there's a customer currently paying for service at the premise, the system automatically sets up the stop information for the existing customer. The stop date of the existing customer is the start date of the new customer. If you don't want to stop the existing customer, simply indicate such in the scroll.

WARNING:

Take special care when adding a new service agreement to specify the appropriate CIS Division and SA Type as it will affect how the customer is billed, what rate can be specified, how overdue debt is collected, and much more. After the service agreement is activated, you may not change its CIS Division / SA type.

FASTPATH:

Refer to [Starting Service and Field Activities](#) for the details about how the system automatically creates the to support start service requests.

How To Stop Service At A Premise

The following instructions specifically reference the *Stop a Premise* Stop Method. You can also use the *Start Selected SAs* Stop Method and its corresponding user interface.

You navigate through the grid as follows:

- Use [Control Central - Main](#) to find the customer. Click the Stop Service button to transfer to Start/Stop.
- Specify the **Stop Date**, **Stop Method** (Stop a Premise), and select a **Premise** (the premise will have been pre-selected for you if you drilled down from Control Central).
- Click the **Stop** button to stop service at the premise.
- When you click the stop button, the system changes the status of each service agreement to pending stop and sets the stop date accordingly. If we stopped a service agreement that we shouldn't have, simply cancel the stop by checking the **Cancel** column in the grid (and save the page)

NOTE:

Landlord reversion. If you stop service at a premise that references a landlord agreement, the system will automatically create pending start service agreements for the landlord for those service types covered by the landlord agreement.

FASTPATH:

Refer to [Stopping Service and Field Activities](#) for the details about how the system creates the to support stop service requests.

How To Start A Deposit

Charging a customer for a deposit involves creating a service agreement. Deposit service agreements are just like other service agreements in many ways:

- The system bills the customer for the deposit using information on the service agreement.
- The customer pays for the billed amount.
- If the customer doesn't pay, credit & collections starts a collection process to encourage the customer to pay.

Deposit service agreements differ from regular service agreements in the following ways:

- Deposit service agreements typically don't cause a receivable account to be affected when the deposit is billed. It is only when the deposit is paid that a financial transaction occurs (debit cash, credit deposit payable).
- Deposit service agreements have a credit balance when the billed amount is paid (the deposit paid by the customer is a liability of your company - it owes the customer this money).
- Deposit service agreements may be billed in installments or in a lump sum.

Creating a deposit service agreement involves the following steps:

- Select the account on Control Central and open Start/Stop.
- Enter a **Start Date** and **Start Method** of Start a Premise.
- Indicate the premise that the deposit service agreement will cover using the Address and click the **Start** button.
- After you click the **Start** button, the Start Confirmation page will appear:
 - Choose an appropriate **CIS Division / SA Type** for the deposit service agreement.
 - If **Start Options** have been created for the CIS Division / SA Type, you need only select the appropriate option and close the page. The system will use the information on the start option to populate the service agreement's billing parameters (e.g., the total deposit due, the installment amount, etc.).
 - If **Start Options** have not been created for the CIS Division / SA Type, you must define the total amount of the deposit and the installment amount, if any. You define the total amount of the deposit in **Total Amount To Bill**. You can have the system recommend a deposit amount by pushing the  that appears adjacent to this field.

- If you allow the customer to pay the deposit in installments, define the Installment Amount (the prompt for this field is defined on the SA type and therefore will differ depending on how you've set up the system). After defining this information, close the page. The system will use the information you entered to create a deposit service agreement.

NOTE:

The above information related to starting a deposit assumes that the deposit SA Type is set up as a premise-based service. If your company does not associate a deposit with a specific premise, you will need to set up your SA Type for the deposit accordingly. Then, you will need to use a Start Method of Start a SA.

How To Start A Charitable Contribution

If a customer elects to contribute money to a charitable organization, you must create a service agreement. Charitable contribution service agreements are just like other service agreements in many ways:

- The system bills the customer for the elected contribution amount using information on the service agreement.
- The customer pays the billed amount.
- If the customer doesn't pay, credit & collections may start a collection process to encourage the customer to pay (depending upon how the charitable contributions debt class has been set up on your system).

Charitable contribution service agreements differ from regular service agreements in the following ways:

- Charitable contribution service agreements typically don't cause a receivable account to be affected when the charitable contribution is billed. It is only when the charitable contribution is paid that a financial transaction occurs (debit cash, credit charitable contribution payable).
- Charitable contribution service agreements have no balance when the billed amount is paid because the money is being forwarded to a charity.

Creating a charitable contribution service agreement involves the following steps:

- Select the account on Control Central and open Start/Stop.
- Enter a **Start Date** and **Start Method** of Start a SA.
- Indicate the **CIS Division / SA Type** of the charitable contribution agreement and click the **Start** button.
- After you click the **Start** button, the Start Confirmation page will appear:
 - If **Start Options** have been created for the CIS Division / SA Type, you need only select the appropriate option and close the page. The system will use the information on the start option to populate the service agreement's billing parameters (i.e., the charitable contribution amount to be periodically billed).
 - If **Start Options** have not been created for the CIS Division / SA Type, you must define the charitable contribution amount (the prompt for this field is defined on the SA type and therefore will differ depending on how you've set up the system). After defining this information, close the page. The system will use the information you entered to create a charitable contribution service agreement.

How To Start A One-Time Charge Service Agreement

You create a one-time charge (i.e., billable charge) whenever a customer should be charged for a service that occurs outside the normal course of business. For example, you would create a billable charge to charge a contractor for the repair of a ruptured gas line.

A billable charge must reference a service agreement. This service agreement behaves just like any other service agreement:

- **Bill segments are created for the service agreement.** Whenever billing is performed for an account with billable charge service agreements, the system creates a bill segment for each unbilled billable charges.
- **Payments are distributed to the service agreement.** Payments made by an account are distributed to its billable charge service agreements just like any other service agreement.
- **Overdue debt is monitored.** The credit and collections process monitors billable charge service agreements for overdue debt and responds accordingly when overdue debt is detected.

Therefore, in order to levy a one-time charge, the customer must have a billable charge service agreement. If one already exists (because of a previous billable charge), you don't have to create a new service agreement. Rather, transfer to the Billable Charge page and add a billable charge for the service agreement. If the customer doesn't already have billable charge service agreement, create one by performing the following steps:

- Select the account on Control Central and open Start/Stop.
- Enter a **Start Date** and **Start Method** of Start a SA.
- Indicate the **CIS Division / SA Type** of the billable charge service agreement and click the **Start** button.
- After you click the **Start** button, the Start Confirmation page will appear. Simply close the confirmation page to save the agreement.
- After the billable charge service agreement has been created, add a billable charge to it (the easiest way is to use the SA context menu). Refer to [Maintaining Billable Charges](#) for more information.

How To Start Service When Multiple Service Points Measure Consumption

When you start service at a premise, the system automatically links service points to service agreements in the same manner as existed for the previous customer. So, if the previous customer amalgamated consumption of three service points and billed this under a single service agreement, the system will create the same configuration for the new customer.

This works fine when the unusual service point configurations have already been set up for the previous customer. However, it doesn't work when the premise is new. So, if you have a new premise that has multiple service points whose consumption needs to be amalgamated under a single service agreement, do the following:

- Start service for only one of the service points to be linked to the service agreement. When you start service, the system creates a service agreement, links the service point to it, and links a field activity to the service point.
- For every service point that wasn't linked to the service agreement:
 - Link the service point to the pending service agreement

NOTE:

That's it. The activation process will automatically activate the service agreement when the fieldwork is complete on all of its service points.

Customer Contacts

Customer contacts are used to record when and why a customer contacted your company. They can also be associated with person, accounts, and premises. This information can be used for both audit and statistical purposes. The topics in this section provide details about how customer contacts are created and used in the system.

Person-Based Versus Premise-Based Customer Contacts

Customer Contacts can be linked to the person, account, and premise.

- If a person is associated with the customer contact, it is considered to be a person-based contact regardless of whether an account and/or premise are also associated with the contact.
- If only a premise is associated with the customer contact, the system will designate the contact as premise-based.
- Contacts that have an account associated with them must also have a person associated and the contact will become person-based. There are no account-based customer contacts.

Customer Contacts that are associated with a person, account, and/or premise can be accessed through each entity's context menu.

How Customer Contacts Are Created

You can add a Customer Contact at any time using either of the following methods:

- Use the [customer contact maintenance](#) page.
- Use the [Customer Contact Zone](#) on the dashboard.

When customer contacts are created through the Customer Contact dashboard zone, the system populates person, account, and/or premise based on context.

In addition to manually adding customer contacts, your implementation team can set up plug-in algorithms that create customer contacts when certain events transpire. For example, you can plug-in an algorithm on the [customer class](#) object that creates a customer contact whenever an order is completed. Because the number and type of plug-ins can be customized for your implementation, we cannot provide a concise list of all such algorithms.

In addition to the above, a variety of events can trigger the creation of a customer contact. Refer to [Customer Contacts Are Used To Trigger Letters](#) for the details.

Customer Contacts Are Used To Trigger Letters

In order to send a letter to a customer, a customer contact must be created for the customer. These types of customer contacts reference a customer contact type that, in turn, references a [letter template](#). The letter template controls the type of information that is merged into the "form letter" and how the letter is physically produced. Refer to [Printing Letters](#) for more information about letter templates and how letters are physically produced.

Because these letters are being sent to a customer, the customer contact that triggers a letter must be person-based. See [Person-Based Versus Premise-Based Customer Contacts](#) for more information.

Customer contacts that trigger letters can be produced by any of the method described under [How Customer Contacts Are Created](#). While a user can create this type of customer contact (e.g., if a customer requests a form to sign-up for automatic payment), the primary sources of customer contacts that trigger letters are via system events and algorithms. Besides algorithms, the following system events may generate customer contacts automatically:

- **Collection events.** When a customer falls in arrears, the system creates a collection process. A collection process is a series of events meant to encourage the customer to pay their outstanding debt. A classic collection event is one that creates a customer contact that, in turn, causes a letter to be sent to the customer requesting payment. These customer contacts are created with person and account populated. Refer to [The Big Picture Of Collection Events](#) for more information.
- **Severance events.** The last event in a collection process typically creates a severance process for each service agreement that's in arrears. A severance process is a series of events that leads to service being severed. A classic severance event is one that creates a customer contact that, in turn, causes a letter to be sent to the customer warning of impending cutoff (or telling them they've been cutoff and the terms necessary to reinstate service). These customer contacts are created with person and account populated. Premise is also populated if the service agreement being severed is associated with a premise. Refer to [The Big Picture Of Severance Events](#) for more information.

- **Write-off events.** After a customer has been final billed, a write-off process will be created. A write-off process is a series of events that leads to the debt being written off. A classic write-off event is one that creates a customer contact that, in turn, causes a letter to be sent to the customer informing them of that their debt has been referred to a collection agency. These customer contacts are created with person and account populated. Refer to [The Big Picture Of Write Off Events](#) for more information.
- **Overdue events.** Overdue processes can be used to collection on past due debt. An overdue process is a series of events that are used to collect on debt. Some overdue events may create a customer contact that, in turn, causes a letter to be sent to the customer. These customer contacts are created with person and account populated. Refer to [The Big Picture Of Overdue Events](#) for more information.

Your implementation team can introduce plug-in algorithms to create a customer contact when certain events take place. If the created customer contact references a letter template, a letter will be triggered. Because the number and type of plug-ins can be customized for your implementation, we cannot provide a concise list of all such algorithms.

Algorithms that are delivered with the product populate person, account, and/or premise based on the information available when the customer contact is created. For example, the field activity remark algorithm populates the premise and also the person and account if the field activity's service point is linked to a service agreement. From the service agreement the account and account's main person are obtained and used on the customer contact.

A Customer Contact May Trigger Reminders

If you want the system to remind you (via a [To Do entry](#)) about a customer-related issue, you can set up a "reminder" on a customer contact. To do this, follow these steps:

- Determine if you need a new customer contact or if you can reuse one that already exists. If you need a new customer contact, use any of the "online methods" described under [How Customer Contacts Are Created](#).
- Add an entry to the [customer contact's log](#). This log entry should be set up as follows:
 - If the To Do entry should be addressed to a specific user, choose a **Reminder** type of Send to User and enter the user's **User ID**.
 - If the To Do entry should be addressed to a group of users, choose a **Reminder** type of Send to Role and enter the user group's **To Do Role**.
 - Use **Trigger Date** to define the latest date on which the To Do entry should be created. The reason we indicated this should be the latest date is because the background process that's responsible for creating these To Do entries has a parameter called "lead time". This parameter is used to define the number of days before the **Trigger Date** that the To Do entry should be created. Schedule the background process TD-CCCB to create these To Do entries.

A To Do entry will then be created on a future date.

Customer Contacts Can Be Used As Case Files

If a customer calls with a complaint (e.g., they suspect their bill is too high), you can start a "case file" for the complaint by creating a customer contact. This customer contact should be marked as "open".

NOTE:

Alerts. Customer contacts that are marked as being open cause an alert to appear when the customer is displayed on control central.

Over time, as you work on the case, you can add entries to the [customer contact's log](#) to describe your progress.

You can use the customer contact's [reminder](#) functionality to remind you to check out the case on a future date (or dates).

When the case is resolved, you simply turn off the customer contact's open indicator and add an appropriate entry to the log describing the resolution.

Maintaining Customer Contacts

Customer contacts are used to record when and why a customer contacted your company. This information is used for both audit and statistical purposes. The topics in this section describe how to maintain customer contacts. Refer to [The Big Picture Of Customer Contacts](#) for background information about customer contacts.

Customer Contact - Main

Open **Menu** > **Customer Information** > **Customer Contact** > **Search** to maintain a customer contact.

NOTE:

The dashboard. A zone exists in the [dashboard](#) that can be used to easily create new customer contacts.

Description of Page

Open designates that the event or issue associated to the contact has not been resolved. For example, if a customer calls with a high bill complaint and you can't resolve it immediately, you would turn on the **Open** switch and enter an appropriate entry in the **Log**. Refer to [Customer Contacts Can Be Used As Case Files](#) for more information.

User ID the user who created the contact is displayed adjacent to **Open**.

Person ID displays the associated person's unique, system-generated ID. If the customer contact is Person-based the Person ID cannot be changed. (Refer to [Person-Based Versus Premise-Based Customer Contacts](#) for more information). This field is suppressed if the Customer Contact Type indicates that a person is not allowed on customer contacts of this type.

(Optional) **Account ID** displays the account's unique, system-generated ID. This field is suppressed if the Customer Contact Type indicates that an account is not allowed on customer contacts of this type.

Premise ID field displays the associated premise's unique, system-generated ID. If the customer contact is Premise-based the Premise ID cannot be changed. This field is suppressed if the Customer Contact Type indicates that a premise is not allowed on customer contacts of this type.

NOTE:

The customer contact type controls the relationship validation among person, account, and premise.

Preferred Contact Method indicates how the person prefers to be contacted. The following options are available:

- Not Applicable. If the person doesn't want to be contacted (or the contact method is unusual), use this option. You might want to consider describing the situation in the Contact Instructions.
- Person Contact. If this method is selected, select a person contact related to the Person link to the customer contact. The customer contact must contain a Person to use this method.
- Postal. If this method is selected, the Contact Person's address appears. Refer to [Where Does The Address Come From](#) for a description of which address the system displays.

The following methods only appear when the Legacy Person Phone and Email **Option Type** on the Customer Information Options Feature Configuration has been enabled:

- Email. If this method is selected, the Contact Person's email address appears adjacent.
- Phone. If this method is selected, the Contact Person's phone number appears.

- Fax. If this method is selected, the Contact Person's fax number appears (the system knows which of a person's phone numbers is a fax number by the phone type).
- SMS. If this method is selected, the Contact Person's short message service (SMS) information displays.

NOTE: While on a customer contact, users can add a person contact by selecting Add Person Contact from a Person Context menu. This will open a portal-based page that allows a person contact to be added. This process will not lose context or information that has been added to the customer contact. Once added, the new person contact can be used within the customer contact or case.

Contact Date and **Contact Time** displays the date and time that the contact was saved into the system..

NOTE:

Default note. The current date and time are defaulted.

Every customer contact has a **Contact Type** that classifies the record for reporting purposes. Every contact type, in turn, references a **Contact Class**. The class categorizes customer contacts into larger groupings for reporting purposes.

NOTE:

Available customer contact types can be restricted by CIS Division. The restriction of customer contact type by CIS division is dynamic. It is based on the account in context, the premise in context, or the current user. The restriction of customer contact type is applied using these rules in sequence.

- If there is an account in context and that account has a CIS Division, that CIS Division is used to restrict the customer contact types that appear.
- If there is a premise in context and that premise has a CIS Division, that CIS Division is used to restrict the customer contact types that appear. Note: If there are both an account and premise in context, the account CIS Division is used.
- If there is no account or premise in context with a CIS Division and the current user is associated with CIS Division(s) that are used to restrict the customer contact types that appear. See [Users and CIS Division](#) for more information.

When the customer contact is saved, the actual account and premise on the customer contact are validated against the customer contact type's CIS Division.

NOTE:

Adding a customer contact may cause a letter to be generated. You can set up a customer contact type to generate a form letter whenever a customer contact of this type is added. In fact, this is the only way to generate a letter in the system. Refer to [Customer Contacts Are Used To Trigger Letters](#) for more information.

Comments provide initial information about why the contact was created. For example, if the customer contact was created by a collection event, a severance event or a write-off event or is referenced by a field activity step, the **Related Records** contains information about the associated record

If a letter template is associated with the customer contact type / class:

- **Letter Information** describes the status of the letter (i.e., whether it has been printed, will be printed or will not be printed).
- If the letter has been printed and you want to reprint, please turn on the **Reprint Letter** switch (this will cause the letter to be reprinted the next time the letter print background process executes). This resets the letter information about when the letter was printed.
- If the letter is going to be printed in the next batch run, the **Print Letter** switch is on. Turning the switch off removes the letter from being printed in the next batch run. This applies to letters that have never been printed and those that have been set to reprint.

- If your implementation team has plugged-in an Online Letter Display algorithm on [Installation Options - Algorithms](#), the **Display Letter** button appears. When clicked, the image of the letter is rendered in a PDF and displayed in an Adobe reader. Refer to [Technical Implementation Of Online Letter Production](#) for a technical description of how letter images are produced. The system comes with configurations to display letter images using BI Publisher or a document composition application, but can work with other applications.

NOTE: Customer contacts that generate letters can only be Person-Based customer contacts. See [Person-Based Versus Premise-Based Customer Contacts](#) for more information.

The grid that follows contains a diary of past (and future) events related to the customer contact. Refer to [A Customer Contact May Trigger Reminders](#) and [Customer Contacts Can Be Used As Case Files](#) for more information about when you would use this log.

There are two ways to add a row to the log:

- You can click the + button to add a new row.
- You can navigate to the **Log** tab and insert a new row into the scroll.

Regardless of the method used to add a log entry, the following information appears on a log entry:

- **Create Date / Time** is the date and time when the log entry was created.
- **Created by** identifies the user that created the log entry.
- Use **Comments** to describe the reason for the log entry. If you have lengthy comments, we recommend navigating to the **Log** tab (by clicking the adjacent Go To button) as there is a larger input field on this page.
- The remaining fields are only used if you want the system to remind you about this customer contact on a future date. If you enter these fields, the system will create a To Do entry to remind you about the customer contact.
 - If the To Do entry should be addressed to a specific user, choose a **Reminder** type of Send to User and enter the user's **User ID**.
 - If the To Do entry should be addressed to a group of users, choose a **Reminder** type of Send to Role and enter the user group's **To Do Role**.
 - Use **Trigger Date** to define the latest date on which the To Do entry should be created. The reason we indicated this should be the latest date is because the background process that's responsible for creating these To Do entries has a parameter called "lead time". This parameter is used to define the number of days before the **Trigger Date** that the To Do entry should be created. Schedule the background process

TD-CCCB – To Do for Customer Contact

to create these To Do entries.

NOTE:

Multiple reminders. You can set up multiple reminders on a customer contact. For example, you can indicate that you want to be reminded every Monday for the next 4 weeks to check on the issue that caused a given customer contact to arise. You'd do this by entering 4 log entries where each as the desired **Trigger Date**.

Customer Contact - Log

The log contains a diary of past (and future) events related to the customer contact. Open **Customer Information**, **Customer Contact** and navigate to the **Log** tab to maintain a customer contact's log. Note, you can also maintain this information on the **Main** tab.

FASTPATH:

Refer to [A Customer Contact May Trigger Reminders](#) and [Customer Contacts Can Be Used As Case Files](#) for more information about when you would use this log.

Description of Page

Date / Time is a display-only field that contains the date and time when the log entry was created.

Log ID is the system-assigned, unique identifier of the log entry.

Created by is a display-only field that contains the ID and name of the user who created the log entry.

Use **Comments** to describe the reason for the log entry.

The remaining fields are only used if you want the system to remind you about this customer contact on a future date. If you enter these fields, the system will create a To Do entry to remind you about the customer contact.

- If the To Do entry should be addressed to a specific user, choose a **Reminder** type of Send to User and enter the user's ID in **Send To**.
- If the To Do entry should be addressed to a group of users, choose a **Reminder** type of Send to Role and enter the user group's To Do Role in **Send To**.
- Use **Trigger Date** to define the latest date on which the To Do entry should be created. The reason we indicated this should be the latest date is because the background process that's responsible for creating these To Do entries has a parameter called "lead time". This parameter is used to define the number of days before the **Trigger Date** that the To Do entry should be created. Schedule the background process TD-CCCB to create these To Do entries.

Customer Contact - Characteristics

Open **Menu** > **Customer Information** > **Customer Contact** > **Search** and navigate to the **Characteristic** page to maintain a customer contact's characteristics.

NOTE:

The primary purpose of characteristics on customer contacts is to allow a letter to extract information from any object in the system; such as, a field activity, or case. For example, if an algorithm or background process generates a letter related to a Case, you could create a customer contact and reference the case as a characteristic value. When the letter's information is extracted, the extract algorithm can extract the fields from the case to merge onto the letter. Refer to [Customer Contacts Are Used To Trigger Letters](#) for more information

Description of Page

NOTE:

You can only choose characteristic types defined as permissible on a customer contact. Refer to [Setting Up Characteristic Types & Their Values](#) for more information about characteristic types. In addition, the characteristic type must also be defined as valid for the customer contact's type. Refer to [Setting Up Customer Contact Types](#) for more information about customer contact type.

The following fields display:

Characteristic Type Indicate the type of characteristic.

Characteristic Value Indicate the value of the characteristic.

Customer Contact - Customer Contact Portal

Select **Menu > Customer Information > Customer Contact > Search** and navigate to the **Customer Contact Portal** page to view additional information associated with a Customer Contact.

Depending on your implementations requirements, you may define additional zones to appear on this Portal.

The contents of this section describe the zones that are available on this portal page.

General Information

Customer Contact ID, **Customer Contact Info** are displayed.

Printing Letters

As described under [Customer Contacts Are Used To Trigger Letters](#), you must create a customer contact whenever you want to send a letter to a customer. The contents of this section describe the technical implementation of letter production.

The Letter Extract Processes

Customer contacts that trigger letters reference a [customer contact type](#) that, in turn, references a [letter template](#). Two background processes are provided with system that control the information extracted into a file.

C1-LTPEX – Letter Extract

This process produces a letter extract file based on letter extract records that are configured with each letter template. Each letter template can be configured with a different set of record type. Some record types have configuration options such as which characteristic types to extract or how to identify the object to extract. This is a highly configuration extract that should reduce the need for a custom solution.

The record layouts can be viewed in the application on the Letter Template Extract Record List zone on the letter template portal.

NOTE:

This batch does not utilize the extract algorithm plug-in spot on letter template. The sample Online Letter Image algorithm provided with the system calls the letter template extract algorithm plug-in spot and is not compatible with this solution.

LTRPRT – Letter Extract

This process uses the extract algorithm on the letter template and is responsible for extracting the information merged onto your letters. These algorithms create the "flat file records" that are passed to your letter print software.

Additionally, the extract algorithm can be called if your letter print software has the ability to construct a real-time image of a letter (in a PDF). You can plug-in an Online Letter Image algorithm on the [Installation Record](#). This type of algorithm calls the letter template's extract algorithm to extract the information that is merged onto the letter. Refer to [Technical Implementation of Online Letter Production](#) for the details.

NOTE:

Alternate print / routing methods. If you require different print formats, you must create new letter extract algorithms and plug them in on your [letter template](#).

NOTE:

This process is not intended for new implementations. For information related to the record layouts produced by the sample algorithms provide for use with this process, please refer to the documentation supplied with CC&B 2.7.0.1 and earlier.

BI Publisher Versus Document Composition Applications

Using BI Publisher as your external reporting tool to display an online letter image differs from using document composition applications as follows:

- An extract file is not required when using BI Publisher. The sample reports provided to use with these external report tools do not have to extract information from another object to merge into a letter.
- Generating letters in batch is not supported yet.

FASTPATH:

Refer to [Letter Print - BI Publisher Sample Welcome Letters - CI_LTRGN_ENG REPORT](#) for more information.

Where Does The Address Come From?

The following points describes the source of a letter's address:

- For letters generated as a result of collection events, severance events, write-off events and overdue events, the address is extracted as follows:
 - The respective [Account - Person](#) record is retrieved for the letter recipient (note, the account ID is retrieved from the related collection / severance / write-off / overdue process).
 - If the person has a [seasonal address](#) effective on the business date, the letter's address is the respective seasonal address.
 - If the address source is Mailing Premise on Account, the letter's address is the [account's mailing premise](#).
 - If the address source is Account Override, the letter's address is the override address on the respective [Account - Person](#) record.
 - If the address source is Person, the letter's address is the [person's mailing address](#).
 - If the address source is not defined, the [person's mailing address](#) is used.
 - If an address was not populated as a result of the above, the letter is not produced and a warning is issued by the background process responsible for creating the letter extract file.
- For all other types of letters, the address is extracted as follows:
 - If the letter's person has a [seasonal address](#) effective on the business date, the letter's address is the respective seasonal address.
 - If the letter's person has a [mailing address](#), it is used.
 - Otherwise, the system checks if the letter's person has at least one account where the person is the main customer and the account has at least one active service agreement. If so, the logic described above is executed for the first such account found.
 - If an address was not populated as a result of the above, the letter is not produced and a warning is issued by the background process responsible for creating the letter extract file.

Technical Implementation Of Online Letter Display

Users can view an image of any letter that is sent to a customer if you set up the following:

- Plug-in an Online Letter Display algorithm on the [Installation Record](#). Refer to C1-LT-DISP for an example of such an algorithm. Note, if your letter print software is not capable of producing a PDF containing an image of a letter, users will not be able to view images of letters.
- Plug-in the appropriate extract algorithm on each [letter template](#). Algorithms of this type format the records that contain the customer information that is passed to your printing software.

When you plug-in these algorithms, a button appears on [Customer Contact - Main](#) for customer contacts whose customer contact type references a letter template. When a user clicks this button, the following takes place:

- The installation record's Online Letter Display algorithm is executed.
- This algorithm calls the customer contact's letter template's extract algorithm. This algorithm constructs the information that's merged onto the letter and returns it to the Online Letter Display algorithm. This algorithm, in turn, passes it to your letter print software.
- Your letter print software renders an image of the letter in a PDF and returns it to the Online Letter Display algorithm.
- And finally, the Online Letter Display algorithm displays the PDF in a separate Adobe session.

The system provides an algorithm that interacts with BI Publisher to render an online image of a letter. The following points describe what takes place when clicking Display Letter when these sample algorithms are used.

- The sample Online Letter Display algorithm C1-ONLTR-RPT is executed.
- This algorithm calls the letter extract algorithm. The sample letter extract algorithm C1-LTREX-RPT is supplied for displaying letters via BI Publisher. This is not actually extracting data because when you use BI Publisher, the report itself is responsible for extracting and formatting the data. The base product algorithm supplied returns the appropriate report code to the Online Letter Display algorithm, which in turn returns the report code to the customer contact page.
- A user exit on the customer contact page invokes BI Publisher and displays the letter in a separate browser session.

FASTPATH: Refer to [Letter Print - BI Publisher Sample Welcome Letters - CI_LTRGN_ENG REPORT](#) for more information.

Reproducing The Letter Print Flat File

You can reproduce the flat file containing the information sent to your printing software at any time. Simply request the respective extract batch process and specify the run number associated with the historic run.

How To Reprint A Specific Letter

If you need to reprint a specific letter, navigate to [Customer Contact - Main](#) and turn on the **Reprint** switch (and save the customer contact). Alternatively, if your implementation has [enabled the online creation of letter images](#), you can also click the **Display Letter** button on this page and then print the resultant PDF on your local printer.

Letter Data Area Organization

The following refers to logic supported by letter extract process C1-LTPEX – Letter Extract. Refer to [The Letter Extract Processes](#) for more information.

The letter extract records are defined using data areas. There is an organizing data area that includes a detail and optionally a characteristic data area. The detail data area contains the individual elements. Using the account record as an example, the organizing data area is “Account Letter Extract Record” and includes two other data areas, “Account Details Letter Extract” and “Account Characteristics Letter Extract”. This was done to:

- Ensure that characteristic records are extracted directly after their associated record.
- Properly sequence parent records followed by their characteristic then followed by a child record and its characteristic.
- Allow custom extensions to the detail record. See [Extending Letter Record Types](#) for more information.

The characteristic data area is only included on objects with a characteristic collection. For consistency, objects without a characteristic record still follow same pattern with an organizing and detail data area. There are two special records, the end of letter record and the summary record that do not follow this pattern.

Letter Extract File Structure

The following refers to logic supported by letter extract process C1-LTPEX – Letter Extract. Refer to [The Letter Extract Processes](#) for more information.

The letter extract file structure is impacted by the extract format. The extract batch, contains a File Format parameter that supports XML, CSV, and fixed position extract formats.

When the format is set to XML, the organizing data area as described in [Letter Data Area Organization](#), is treated as a single schema. The included data areas are nested within the organizing data area. For example, an account record configured with two characteristics to extract will be nested in a single schema with a detail group and two occurrences of the characteristic list group.

When the format is set to CSV or fixed position, the included data areas are treated as an individual schema so that each record is extracted on a separate row. For example, an account record configured with two characteristics to extract will produce three rows in the extract file.

Extending Letter Record Types

The following refers to logic supported by letter extract process C1-LTPEX – Letter Extract. Refer to [The Letter Extract Processes](#) for more information.

Each record type has a business object that defines the format and the logic to extract records of that type. The BO Extract Record plug-in spot contains the logic to populate the record's data area. This plug-in spot supports multiple algorithms. Each business object is delivered with one algorithm configured for this plug-in spot that contains the logic to populate the record type's elements.

As described in [Letter Data Area Organization](#), there is a detail data area that contains the individual elements for a record type. If your implementation wants to extend a delivered record type, define a custom data area that extends the detail data area. The organizing data area should not be extended. To populate the custom data area, create an additional algorithm for the Extract Record plug-in spot. The record's schema is passed into the plug-in spot so subsequent algorithms have access to values defined by previous algorithms.

Maintaining Declarations

The declaration page allows you to define a declaration percentage for a combination of account, premise, service type, declaration type and date range. The declaration may be used by algorithms to adjust certain calculations in the system. For example you may give certain customers a reduced VAT rate. The declaration is used to indicate the reduced rate for the qualifying customer.

Open **Menu > Customer Information > Declaration > Add** to create a new declaration.

NOTE:

Applicable for UK market. This page is intended for the United Kingdom market. Other markets may disregard this transaction.

Description of Page

The **Declaration Info** is a concatenation of important information about the declaration record. The **DeclarationID** is a system-assigned random number that uniquely identifies this record.

Use **Account ID** to indicate the account for this declaration.

Use **Premise ID** to indicate the premise for this declaration.

The **Service Type** controls the service agreements covered by this declaration. All service agreements for this account and premise whose service point is for this service type are covered.

Use the **Declaration Type** to indicate the type of declaration. The system includes the declaration types CCL Relief and Reduced Rate VAT.

NOTE:

The values for this field are able to be customized using the Lookup table. This field name is DCL_TYPE_FLG.

Enter the **Start Date** and **End Date** to indicate the effective period of this declaration. The start date defaults to the current date.

Enter the **Declaration Percentage**.

If this declaration is related to an external document, indicate the **Document Reference**.

This bottom of this page contains a [tree](#) that shows information about all the declarations linked to this account. You can use this tree to both view high-level information about these objects and to transfer to the respective page in which an object is maintained.

Service Tasks

The topics in this section describes service tasks.

The Big Picture of Service Tasks

Service tasks are records that can be used to perform a variety of tasks. Examples include:

- Task-related records performed by users of other Oracle Utilities applications, such as Oracle Utilities Customer Self Service.

- Task-related records performed by Oracle Utilities Customer Care and Billing to manage specific processing, such as net energy metering true-ups, or prepaid billing to create bill segments for smart meter prepaid service agreements.

For additional information about Service Tasks, see [Defining Service Tasks Options](#)

Searching and Viewing Service Tasks

Use this procedure to search for and view service tasks using the Service Task Query portal.

1. Select **Menu > Customer Information > Service Task**.
2. Enter your search criteria.
Base package search options include customer name, external ID and service task ID.
Self-service task search criteria include service task type.
3. Click **Refresh**.
4. In the search results list, click the link for the service task you want to view or edit. The selected service task opens in the Service Task portal.

Registration Points

Understanding Registration Points

Deregulated markets operate by passing transactions between market participants to manage market processes. Markets use a unique market identifier for market participants to identify the customer or premise that the transaction applies to.

Some markets will identify a customer at a premise and the unique identifier will change with each new customer at the same premise. Other markets will identify the premise as the unique identifier and all customers at that premise will use the same identifier.

A registration point can manage a unique identifier at the premise level, service point level or the service agreement level. Therefore, providing the ability to operate in all markets.

Registration points can be associated directly with market transactions and/or market processes. Transactions can be implemented to trigger from changes to a registration point, or any object associated with the registration point. Transactions from Market Participants are received and validated against the registration point and can update the registration point directory or associated objects.

A registration point search portal provides a central location for all transactions associated with a customer and/or premise to be viewed in a single location.

For implementations operating in deregulated markets, refer to your implementation documentation for further details relating to registration point(s) constructed for your market(s).

Refer to [Understanding Market](#) for more details on markets.

Maintaining Registration Points

This portal is used to display and maintain a Registration Point.

Refer to [Understanding Registration Points](#) for more details.

To view and maintain registration points, open **Menu > Customer Information > Registration Point > Search**. You are brought to a query portal with options for searching for registration points.

Once a registration point record has been selected, you are brought to the maintenance portal to view and maintain the selected record.

The following zones are displayed:

- **Registration Point**
- **Registration Point Attributes**
- **Registration Point Characteristics**
- **Market Messages and Market Processes**
- **Registration Point Relationships**

Refer to the zones' embedded help for more information.

Consumer Contracts

Maintaining Consumer Contracts

This portal is used to display and maintain a Consumer Contract.

Refer to [Understanding Consumer Contracts](#) for more details.

To view and maintain consumer contracts, open **Menu > Customer Information > Consumer Contract > Search**. You are brought to a query portal with options for searching for consumer contracts.

Once a consumer contract record has been selected, you are brought to the maintenance portal to view and maintain the selected record.

The following zones are displayed:

- **Consumer Contract** shows the details of the consumer contract.
- **Consumer Contract Milestone** shows the significant dates on which specific actions will take place for the consumer contract.
- **Consumer Contract Product** shows the related contract product versions
- **Consumer Contract Change Request** shows the related consumer contract change request(s) that created and/or updated the consumer contract.

Refer the zones' embedded help for more information.

Customer Service Requests

Understanding Customer Service Requests

Customer service requests can be used to orchestrate complex customer related processes that can create or update multiple objects.

- Customer service request person

- Customer service request account
- Customer service request premise
- Customer service request consumer contracts
- Customer service request contract product
- Customer service request service location

An implementation can add custom components to use the customer service request objects to add or update persons, accounts, premises and contracts.

To see the available customer service request types in your implementation, refer to the Customer Service Request business objects in the application.

Maintaining Customer Service Requests

This portal is used to display and maintain a Customer Service Request.

Refer to [Understanding Customer Service Requests](#) for more details.

To view and maintain customer service requests, open **Menu > Customer Information > Customer Service Request > Search**. You are brought to a query portal with options for searching for customer service requests.

Once a customer service request record has been selected, you are brought to the maintenance portal to view and maintain the selected record.

The following zones are displayed.

- **Customer Service Request** zone shows the details of the customer service request.
- **Customer Service Request Person** shows the related person(s). Select a record to go to the specific portal where the details can be viewed and maintained.
- **Customer Service Request Account** shows the related account(s). Select a record to go to the specific portal where the details can be viewed and maintained.
- **Customer Service Request Premise** shows the related premise(s). Select a record to go to the specific portal where the details can be viewed and maintained.
- **Customer Service Request Contract** shows the related contract(s). Select a record to go to the specific portal where the details can be viewed and maintained.
- **Customer Service Request Contract Product** shows the related contract product(s). Select a record to go to the specific portal where the details can be viewed and maintained.
- **Customer Service Request Service Location** shows the related service location(s). Select a record to go to the specific portal where the details can be viewed and maintained.
- **Customer Service Request Related Object** shows other related entities.

Refer to the zones' embedded help for more information.

Maintaining Customer Service Request Person

This portal is used to display and maintain a Customer Service Request Person.

This portal is displayed when a record is selected from the **Customer Service Request Person** zone on the Customer Service Request portal. Refer to [Maintaining Customer Service Requests](#) for more details.

The **Customer Service Request Person** zone shows the details of the related person. Refer to the zone's embedded help for more information.

Maintaining Customer Service Request Account

This portal is used to display and maintain a Customer Service Request Account.

This portal is displayed when a record is selected from the **Customer Service Request Account** zone on the Customer Service Request portal. Refer to [Maintaining Customer Service Requests](#) for more details.

The **Customer Service Request Account** zone shows the details of the related account. Refer to the zone's embedded help for more information.

Maintaining Customer Service Request Premise

This portal is used to display and maintain a Customer Service Request Premise.

This portal is displayed when a record is selected from the **Customer Service Request Premise** zone on the Customer Service Request portal. Refer to [Maintaining Customer Service Requests](#) for more details.

The **Customer Service Request Premise** zone shows the details of the related premise. Refer to the zone's embedded help for more information.

Maintaining Customer Service Request Contract

This portal is used to display and maintain a Customer Service Request Contract.

This portal is displayed when a record is selected from the **Customer Service Request Contract** zone on the Customer Service Request portal. Refer to [Maintaining Customer Service Requests](#) for more details.

The **Customer Service Request Contract** zone shows the details of the related contract. Refer to the zone's embedded help for more information.

Maintaining Customer Service Request Contract Product

This portal is used to display and maintain a Customer Service Request Contract Product.

This portal is displayed when a record is selected from the **Customer Service Request ContractProduct** zone on the Customer Service Request portal. Refer to [Maintaining Customer Service Requests](#) for more details.

The **Customer Service Request Contract Product** zone shows the details of the related contract product. Refer to the zone's embedded help for more information.

Maintaining Customer Service Request Service Location

This portal is used to display and maintain a Customer Service Request Service Location.

This portal is displayed when a record is selected from the **Customer Service Request Service Location** zone on the Customer Service Request portal. Refer to [Maintaining Customer Service Requests](#) for more details.

The **Customer Service Request Service Location** zone shows the details of the related service location. Refer to the zone's embedded help for more information.

Asset Management

NOTE: The asset management functionality described in this section is available only to cloud implementations using Oracle Utilities Customer Cloud Service or Oracle Utilities Meter Solution Cloud Service.

Assets

About Assets

In Oracle Utilities Customer To Meter, an asset is any operational device used in a metering system, such as a smart meter, analog meter, communication component, or communication relay.

The status and location of assets are carefully monitored and recorded as they move in and out of service or go for maintenance or repair. This type of asset will be tracked at a location with a disposition such as in receipt, in stores, in repair, retired or rejected. If the tracked asset is installed, or put in service, it will be related to an asset location. Tracked assets utilize more statuses and a status reason to more carefully track the asset as it moves from receipt to retirement.

Assets are defined by the following:

- **Asset Type:** The [asset type](#) on which the asset is based.
- **Status:** The current status of the asset (In Receipt, In Stores, Installed, In Repair, Retired, Rejected, or Pending Disposition)
- **Device:** The device associated with the asset. When assets are created (either manually or through [asset replication](#)), a corresponding device is created (see [Assets and Devices](#) below for more information).
- **Specification:** The asset's [specification](#). This is used to determine the template device used when creating [devices](#) based on the asset or its asset type.
- **Identification:** Identifiers (such as Badge Number or Serial Number) and other information used to identify the asset
- **Settings:** Firmware and configuration settings used with smart meter assets
- **Asset Disposition Detail:** Details regarding the disposition and location of the asset.

NOTE: The **Asset** portal may display information beyond that described here that is not used with Oracle Utilities Customer To Meter.

Components

Components are devices or other objects that are attached to another device, usually an asset.

One of the most common examples of components are the electronic reading devices (ERTs) that are often attached to analog meters. However, a component can be any asset attached to another asset.

Example of components in Oracle Utilities Customer To Meter include:

- **Communication Relays:** Communication relays transmit messages between various points to facilitate communication between units. These typically use the same fields and statuses as meters.
- **Communication Components:** Communication components are devices that can be attached to an analog meter to connect the meter to the “smart” communication grid. These use the same fields and statuses as smart meters with the exception that they are never installed directly at a location, but are instead attached to another asset.

Since they are always attached to another device, components cannot be installed at a location. However, they may be received, tracked, maintained and inspected like any other device. Given this, activities and work orders can be created to perform these tasks on components.

Detaching components involves either moving the component to a new asset or transferring to a storeroom. The process within the system is to search for and select the component and then "detach" it from the asset where it currently resides.

Asset Hierarchy

Assets typically exist within a structured relationship based on the relationship between the asset and its locations and organizations, or "nodes". The hierarchy is represented in a nested format on the **Tree View** tab on the **Asset** portal. This view displays which assets are in a location, which assets are attached to other assets, and where assets belong within organizations. Clicking the broadcast icon next to any element within the tree displays a list of assets and components related to that element in the hierarchy. Clicking the actual link for an element navigates to the associated record for the element.

Assets and Devices

When assets are created (or replicated) in Oracle Utilities Meter To Customer, a related [device](#) is created. The way in which the device is created is based on the configuration of the asset, its asset type, and its specification.

- For assets with specifications that include **Configuration Mapping** details, the type of device created is based on the template device identified in the **Configuration Mapping** section of the [specification](#) referenced on the asset or associated with the asset type.
- For assets that have no template device configured, the type of device created is based on the asset type of the asset and the **Value Mappings** defined for the "Asset Type/Device Type" value of the ODM-MDM Mapping Field Values extendable lookup.

Device identifiers for devices created via an asset can not be changed in the **Device** portal. These identifiers must be changed in the [Asset](#) portal.

Asset Status and Disposition

An asset's Status defines its current state in the system (In Receipt, In Stores, Installed, In Repair, Retired, Rejected, or Pending Disposition).

An asset's Disposition indicates where the asset is and what is being done to the asset. This includes its status and location, as well as the date/time at which the asset was moved to its current location. In the case of components, disposition is also used to track the assets to which a component is attached.

The [Mass Asset Disposition Update](#) portal can be used for moving many assets of the same type from one location to another location.

The disposition of assets with related devices is updated to "Installed" when their related device is installed at a service point. The update to the device's install event triggers the update to the asset disposition, changing its **Status** and **Asset Disposition** to "Installed" and its **Location** to the service point with an effective date matching the install event's **Installation Date/Time**.

NOTE: If an asset is deleted, its related device is also deleted.

Maintaining Assets

You use the **Asset** portal is used to display and maintain assets.

Refer to [About Assets](#) for additional functional information.

You can access the portal from **Menu > Asset Management > Asset**. You are brought to a query portal with options for searching. Once your record has been selected you are brought to the maintenance portal to view and maintain the selected record.

The following zones may appear as part of the portal's **Main** tab page:

- **Asset:** This zone displays the basic attributes of the asset.
- **Attached Components:** This zone displays a list of any components that are installed on the asset.
- **Disposition History:** This zone displays a log of the status and location changes for the life of the asset.

The following zones may appear as part of the portal's **Maintenance** tab page:

- **Asset Service History:** This zone displays a log of the service history that has been recorded for the life of the asset.
- **Activity History:** This zones displays a log of the activities that have been performed on the asset over the life of the asset.

The following zones may appear as part of the portal's **Tree View** tab page:

- **Asset Hierarchy:** This zone displays the service point at which the asset is currently installed (if applicable). Clicking the broadcast icon opens the **Installed Assets** zone, which displays a tree view of all of the assets installed at the service point.
- **Currently Installed Assets:** This zone displays a list of all assets currently installed in this location.
- **Installed Assets:** This zone displays a tree view of all of the assets installed at the service point.

The following zones may appear as part of the portal's **Log** tab page:

- **Asset Log:** This zone displays the server logs for the asset.
- **Asset Sync Requests:** This zone displays a list of synchronization requests related to the asset. Synchronization requests are used to synchronize the asset with an associated device.

NOTE: The **Asset** portal may display tabs and zones beyond those described here. These tabs and zones are not used with Oracle Utilities Customer To Meter.

Working with Assets

A number of actions are available for an asset depending on its status:

Action	Allowed Statuses	Details
Store	In Receipt	Moves the asset to a storage ("out of service") location and sets the asset's status to "In Store"..
	Installed	
	In Repair	
	Retired	
Reject	In Receipt	Sets the status of the asset to "Rejected" (used if an asset fails an inspection)
	In Store	
Install	In Store	Installs the asset at an asset location (service point) and sets the asset's status to "Installed".
Repair	In Store	Sets the status of the asset to "In Repair".
	Retired	
Retire	In Store	Sets the status of the asset to "Retired".
	In Repair	

Pending Disposition	In Store	Sets the status of the asset to "Pending Disposition".
	Installed	
	In Repair	
	Retired	
Change Location	In Store	Changes the storage location of the asset.

NOTE: If an asset is deleted, its related device is also deleted.

Asset Activities

About Asset Activities

Asset activities are used for creating field work tasks related to an asset or asset location, such as installation or removal of a meter to and from its service point. It may also be used for creating field work tasks for a specific location unrelated to an asset such as trimming trees near power lines, fixing a street light pole, repairing fire hydrant leaks, and so on.

The base package includes an asset activity type business object (W1-SOMActivityType) and a corresponding asset activity business object (W1-SOMActivity), used in the integration or consolidation of Operational Device Management activities with and [Service Order Management](#) activities related to field work.

When an asset activity (based on the asset activity type and asset activity business objects referenced above) is created and enters the "Communication in Progress" state, the activity is synchronized with Service Order Management, creating a [service order field activity](#) with a [field task type](#) that corresponds to the asset activity's type.

Once the field activity has been created, Service Order Management is responsible for dispatching the request to the field work system. When the task is completed, Service Order Management receives the completion information from the field work system, completes the service order field activity and sends the completion information to Operational Device Management to complete the corresponding asset activity.

Asset activities (based on the (W1-SOMActivity business object) are defined by:

- **Status:** The current status of the asset activity
- **Emergency:** A flag that indicates if the asset activity is an emergency or not
- **Originating Activity:** The activity that triggered the creation of the asset activity (if applicable)
- **Location:** The location where the asset activity is to be performed
- **Asset:** The asset associated with the asset activity
- **Activity Generator:** The [asset activity generator](#) that created the asset activity (if applicable)
- **Service Date/Time:** The date and time at which the field work associated with the asset activity is to be performed
- **Address Information:** The address where the field work associated with the asset activity is to be performed
- **Contact Information:** Contact information (customer name and phone number) related to the asset activity

Maintaining Asset Activities

You use the [Field Activity Query](#) and [Field Activity](#) portals to display and maintain asset activities.

Refer to [About Asset Activities](#) for additional functional information.

You can access the portal by selecting **Menu**, then **Asset Management**, then **Asset Activity**. You are brought to the **Field Activity Query** portal with options for searching.

The following zones may appear as part of the portal's **Main** tab page:

- **Activity:** This zone displays the basic attributes of the asset activity.
- **Completion Information Entry:** This zone displays a list of completion events that must be processing to finalize the asset activity
- **Attachments:** This zone displays a list of attachments (if any) related to the asset activity.

The following zones may appear as part of the portal's **Log** tab page:

- **Activity Log:** This zone displays the server logs for the asset activity.

NOTE: The **Field Activity** portal may display tabs and zones beyond those described here. These tabs and zones are not used with Oracle Utilities Customer To Meter.

NOTE: For asset activities that have been synchronized with Service Order Management, you are brought to the **Activity** portal to view and maintain the selected record. See [About Service Order Field Activities](#) for more information.

Asset Activity Generators

About Asset Activity Generators

Asset activity generators are used for mass generation of activities. An Asset Generator Criteria business object is selected when creating asset activity generators, and is used for entering the criteria values for searching assets and asset locations that will be linked to the activities to be created. Such criteria includes location type, asset identifiers, location identifiers, address components, asset disposition, indication if asset is installed or not, asset type, specification and among others. Required information also includes, the activity type, disposition of the created activities, maximum number of activities that will be created, and an indication if the activities will be created via batch processing.

The base package the following set of activity generator business objects containing the various criteria:

- **Asset Criteria** (W1-AssetCriteriaActGenerator): used to define asset-related criteria used to select the assets for which activities will be created (for example, activities for all assets for a certain asset type, a specified current disposition or condition, or whose identifiers contain specific characters, and so on)
- **Asset List** (W1-AssetListActGenerator): used to define a list of assets for which activities will be created
- **Component Criteria** (W1-CompnCriteriaActGenerator): used to define component-related criteria to select the components for which activities will be created (for example, asset inspection activities for all assets for a certain component type, a specified current disposition or condition, or whose identifiers contain specific characters, and so on)
- **Component List** (W1-CompnAssetListActGenerator): used to define a list of assets for which activities will be created
- **Location Criteria** (W1-NodeCriteriaActGenerator): used to define location-related criteria to select the asset locations for which activities will be created (for example, activities for all locations where assets are current installed, locations of a specific type, or whose identifiers contain specific characters, and so on)

•

Asset activity generators are defined by:

- **Status:** The current status of the asset activity generator
- **Batch Generation Requested:** A flag that indicates if the activities created by the asset activity generator should be generated via batch processing

- **Generator Information:** Details related to the specific activity generator business object (Asset List, Asset, Location, etc.) used by the asset activity generator
- **Activity Information:** Details for the types of activities created by the asset activity generator, including activity type, default disposition, activation and work lead days (defaulted from the asset activity type), and the maximum number of activities to be created

Specific asset activity generators contain additional information based on their business object. For instance, asset activity generators based on the Location Criteria business object includes **Location Information** and **Address Information** sections.

Maintaining Asset Activity Generators

You use the **Activity Generator** portal is used to display and maintain asset activity generators.

Refer to [About Asset Activity Generators](#) for additional functional information.

You can access the portal by selecting **Menu**, then **Asset Management**, then **Asset Activity Generator**. You are brought to a query portal with options for searching. Once your record has been selected you are brought to the maintenance portal to view and maintain the selected record.

The following zones may appear as part of the portal's **Main** tab page:

- **Activity Generator:** This zone displays the basic attributes of the asset activity generator.
- **Activity Information:** This zone displays summary information about the activities created by the activity generator.

The following zones may appear as part of the portal's **Activities** tab page:

- **Activities:** This zones displays a list of the activities created by the activity generator.

The following zones may appear as part of the portal's **Log** tab page:

- **Activity Generator Log:** This zone displays the server logs for the asset activity generator.

NOTE: The **Activity Generator** portal may display tabs and zones beyond those described here. These tabs and zones are not used with Oracle Utilities Customer To Meter.

Asset Completion Events

About Asset Completion Events

Asset completion events are used to execute business events within the application. For example, completion events may be configured for several types of asset processing such as asset update, state transition, replication, service history and activity creation.

These are created automatically by the inbound communication through the completion event types configured on the activity type of the activity that the inbound communication is attempting to complete.

NOTE: Since these records are most often created by the system, most users will only rarely be manually creating or updating asset completion events.

Asset completion events are defined by:

- **Status:** The current status of the asset completion event
- **Execution Sequence:** The sequence number for the asset completion event

- **Inbound Communication:** The asset inbound communication that created the asset completion event
- **Relationship Information:** The asset, component, location, or service history associated with the asset inbound
- **Event Information:** Information about the asset completion event, including date and time of completion and any comments

Maintaining Asset Completion Events

You use the **Completion Event** portal is used to display and maintain asset completion events.

Refer to [About Asset Completion Events](#) for additional functional information.

You can access the portal by selecting **Menu**, then **Asset Management**, then **Asset Completion Event**. You are brought to a query portal with options for searching. Once your record has been selected you are brought to the maintenance portal to view and maintain the selected record.

The following zones may appear as part of the portal's **Main** tab page:

- **Completion Event:** This zone displays the basic attributes of the asset completion event.
- **Completion Event Related Objects:** This zone displays objects related to the asset completion event, such as a device, service point, or initial measurement.
- **Attachments:** This zone displays attachments, if any, related to the asset completion event.

The following zones may appear as part of the portal's **Log** tab page:

- **Completion Event Log:** This zone displays the server logs for the asset completion event.

NOTE: The **Completion Event** portal may display tabs and zones beyond those described here. These tabs and zones are not used with Oracle Utilities Customer To Meter.

Asset Inbound Communications

About Asset Inbound Communications

Asset inbound communications are used to stage the completion of an asset activity. This is typically created automatically by the system following the completion of the corresponding field activity in the field work system (such as Oracle Field Service Cloud).

NOTE: Since these records are most often created by the system, most users will only rarely be manually creating or updating asset inbound communications.

Asset inbound communications are defined by:

- **Status:** The current status of the asset inbound communication
- **Initiating Activity:** The asset activity, typically a field activity, that triggered the creation of the asset inbound communication
- **Event Information:** Information about the completion event associated with the asset inbound communication, including date and time of completion and any comments
- **Relationship Information:** The asset, component, location, or service history associated with the asset inbound communication

- **Asset Identifier Information:** Identifier types and values used to establish a connection between an asset and a corresponding entity in an external system
- **Attached to Asset Identifier Information:** Identifier types and values used to establish a connection between a component and related asset, and a corresponding entity in an external system
- **Location Identifier Information:** Identifier types and values used to establish a connection between a location and a corresponding entity in an external system
- **Activity Type Identifier Information:** Identifier types and values used to establish a connection between an asset activity type and a corresponding entity in an external system
-

Maintaining Asset Inbound Communications

You use the **Inbound Communication** portal is used to display and maintain asset inbound communications.

Refer to [About Asset Inbound Communications](#) for additional functional information.

You can access the portal by selecting **Menu**, then **Asset Management**, then **Asset Inbound Communication**. You are brought to a query portal with options for searching. Once your record has been selected you are brought to the maintenance portal to view and maintain the selected record.

The following zones may appear as part of the portal's **Main** tab page:

- **Inbound Communication:** This zone displays information for the asset inbound communication.
- **Communication Tree:** This zone displays a tree of objects related to the asset inbound communication, including its parent activity.

The following zones may appear as part of the portal's **Log** tab page:

- **Inbound Communication Log:** This zone displays the server logs for the asset completion event.

NOTE: The **Inbound Communication** portal may display tabs and zones beyond those described here. These tabs and zones are not used with Oracle Utilities Customer To Meter.

Asset Locations

About Asset Locations

Asset locations define the physical location where an asset is installed. In Oracle Utilities Customer To Meter, asset locations are [service points](#), and specify the address where a device is installed.

In Oracle Utilities Customer To Meter, asset locations are created when a service point is created, and are maintained using the [Service Point](#) portal. If the service point has a contact associated with it, a corresponding contact will be created for the asset location. See [About Contacts](#) and [Maintaining Contacts](#) for more information about creating and maintaining contacts used with asset locations.

Note that an asset location is the physical location where assets or components can be installed, whereas [Out of Service Locations](#) are for receipt, storage, repair, retirement, transport (on vehicles) and other dispositions.

Maintaining Asset Locations

You use the **Asset Location** portal is used to search for asset locations.

Refer to [About Asset Locations](#) for additional information about asset locations.

You can access the **Asset Location** portal from **Menu > Asset Management > Asset Location**. You are brought to a query portal with options for searching. Once your record has been selected you are brought to the **Service Point** portal to view and maintain the selected record.

NOTE: In Oracle Utilities Customer To Meter, asset locations are created and/or updated when a service point is created and/or updated. If the service point has a contact associated with it, a corresponding contact will be created for the asset location. See [About Contacts](#) and [Maintaining Contacts](#) for more information about creating and maintaining contacts used with asset locations.

Asset Replication

About Asset Replication

As devices and other assets are received in large quantities, the **Asset Replication** portal allows for the receipt, inspection, storage and other processing of these assets in batches.

Using asset replication functionality your organization can complete processes such as:

- Replicating assets in the same lot/pallet
- Selecting assets for testing or inspection
- Mass updating asset disposition such as rejecting or accepting a lot or pallet

This processing creates new asset IDs, badge numbers and serial numbers for assets based on general information that is entered related to each batch. When a new replication event is created it is tied to a replication activity type to determine default settings and attributes for the replication. The actual asset information can be entered manually or uploaded via a CSV file.

Assets can then be moved between locations, or dispositioned using [Mass Asset Disposition Update](#).

Maintaining Asset Replication

You use the **Asset Replication** portal is used to display and maintain asset replication activities.

Refer to [About Asset Replication](#) for additional functional information.

You can access the portal from **Menu > Asset Management > Asset Replication**. You are brought to a query portal with options for searching. Once your record has been selected you are brought to the maintenance portal to view and maintain the selected record.

The following zones may appear as part of the portal's **Main** tab page:

- **Asset Replication:** This zone displays the basic attributes of the asset replication activity.
- **Completion Event:** This zone displays a list of completion events related to the asset replication activity.

Manufacturers

About Manufacturers

Manufacturers are the companies that makes assets (devices, communication components, transformers, etc.).

An asset is related to a manufacturer through the asset's specification.

Each manufacturer can have zero or more models defined. Models for a single manufacturer can have diverse service types.

Maintaining Manufacturers

You use the **Manufacturer** portal is used to display and maintain manufacturers.

Refer to [About Manufacturers](#) for additional functional information.

You can access the portal from **Menu**, then **Asset Management**, then **Manufacturer**. You are brought to a query portal with options for searching. Once your record has been selected you are brought to the maintenance portal to view and maintain the selected record.

The following zones may appear as part of the portal's **Main** tab page:

- **Manufacturer:** This zone displays the basic attributes of the manufacturer.
- **Manufacturer Models:** This zone displays a list of models associated with the manufacture. To add or edit models available for the manufacturer, click **Edit** in the zone title bar.
- **Manufacturer Specifications:** This zone displays a list of specifications associated with the manufacturer. Use the **Specification** portal to add or edit the specifications associated with the manufacturer.

Mass Asset Disposition Update

You use the **Mass Asset Disposition Update** portal is used to update the disposition of a group of assets.

More specifically, Mass Asset Disposition is used for moving many assets of the same type from one location to another location. In a mass disposition task, the target is always a single asset location. For example, if a pallet of meters has been received in the receiving asset location, mass disposition can be used to move this batch of assets to a storage asset location or an out of service location.

Refer to [About Assets](#) for additional functional information.

To use the **Mass Asset Disposition Update** portal:

1. Select **Menu > Asset Management > Mass Asset Disposition Update**.
You are brought to a query portal with options for searching assets
2. Enter search criteria appropriate to the asset you wish to update and click **Search**.
3. From the list of search results, select the assets you wish to update and click **Change Disposition**. The **Mass Asset Disposition Update** screen opens.
4. Enter the date and time at which the update should take effect in the **Effective Date/Time** field.
5. Select the new disposition for the assets from the **Asset Disposition** drop-down list.
6. Select the new location for the assets from the **Location** drop-down list or field.
7. Select or enter other data as appropriate (based on the new disposition). For instance, if you select "Rejected" you must also select a reason from the **Reason** drop-down list.

Service History

About Service History

Service history is used to capture and record relevant information regarding service or maintenance on assets. Typically it is used to record inspection feedback, pass/fail details, downtime, parts failure information, maintenance or service logs, or other information regarding service on the asset.

Types of service history might include:

- Asset downtime
- Failure details
- Asset maintenance
- Visual inspection
- Leak detection
- Smart meter test
- Battery replacement
- ..., and so on.

Service history records can be manually created or automatically generated as the result of completion events being processed for activities. If the service history type has any schedule defined, a set schedule may also be established to create regular service history for repeated tasks such as inspection or regular maintenance. Service history types linked to asset types control which service history can be created for assets.

Maintaining Service History

You use the **Service History** portal is used to display and maintain service history records.

Refer to [About Service History](#) for additional functional information.

You can access the portal from **Menu > Asset Management > Service History**. You are brought to a query portal with options for searching. Once your record has been selected you are brought to the maintenance portal to view and maintain the selected record.

The following zones may appear as part of the portal's **Main** tab page:

- **Service History**: This zone displays the basic attributes of the service history record.

Shipping Memos

About Shipping Memos

Shipping memos are records of stock items being shipped from an internal storeroom, whether from storeroom to storeroom or from storeroom to vendor.

Shipping memos can be created for both standard and tracked stock items and enables storeroom managers and shipping clerks a way to manage and track stock items being shipped between locations.

Some uses for shipping memo include the following:

- Tracking stock items returned to vendors for credit, replacement, or repair
- Helping to manage the return of repaired or replacement stock items back into inventory

Oracle Utilities Customer To Meter uses the following types of shipping memos:

- **General:** the shipping memo category that should be used when manually creating shipping memos

Oracle Utilities Work and Asset Management and Oracle Utilities Operational Device Management include additional types of shipping memos.

Maintaining Shipping Memos

You use the **Shipping Memo** portal is used to display and maintain shipping memos.

Refer to [About Shipping Memos](#) for additional functional information.

You can access the portal from **Menu > Inventory > Shipping Memo**. You are brought to a query portal with options for searching. Once your record has been selected you are brought to the maintenance portal to view and maintain the selected record.

The following zones may appear as part of the portal's **Main** tab page:

- **Shipping Memo:** This zone provides information about the shipping memo, such as shipping category, shipping memo number, ship to details, and tracking information.
- **Shipping Lines:** This zone provides links to the shipping line and stock items associated with the shipping memo.

Specifications

About Specifications

Specifications are used to define the manufacturer, model, and other information about a set of assets.

- Specifications can include attachments which support the specification definition or provide the actual specification from the manufacturer.
- Specifications may also include default in service and out of service maintenance schedules for assets or components linked to the specification. When the specification is associated with the asset or component, the related maintenance schedule becomes in effect for the asset or component.

Specifications are defined by the following:

- **Asset Type:** The [asset type](#) associated with the specification. This links the specification to assets (assets of the specified asset type reference the current specification).
- **Manufacturer:** The manufacturer associated with the specification.
- **Detail:** Additional details pertaining to the specification. Details can include
 - **Model:** The model number for the specification. Used with item specifications.
 - **Configuration Mapping:** Details of the template device used when creating devices ([meters](#), [items](#), or [communication components](#)) based on assets that reference this specification. This includes:
 - **Configuration:** The type of configuration
 - **Device Identifier Type:** The device identifier type (Asset ID, Badge Number, Serial Number, etc.) used to identify the template device
 - **Identifier Value:** The value for the specified device identifier type used to identify the template device (for example, the Badge Number of the template device)
- **Firmware Information:** Details concerning the firmware specifications associated with the specification (not used with analog meter specifications)

The base package includes the following specifications, each based on a different business object. The table below lists the base package specifications and the business objects for each.

Specification	Business Object
Analog Meter Specification	W2-ManualMeterSpecification
Item Specification	W1ItemSpecification
Communication Component Specification	W2-CommunicationComponentSpec
Communication Relay Specification	W2-CommunicationRelaySpec
Firmware Specification	W2-FirmwareSpecification
Analog Meter Specification	W2-ManualMeterSpecification
Smart Meter Specification	W2-SmartMeterSpecification

Maintaining Specifications

You use the **Specification** portal is used to display and maintain specifications.

Refer to [About Specifications](#) for additional functional information.

You can access the portal by selecting **Menu**, then **Asset Management**, then **Specification**. You are brought to a query portal with options for searching. Once your record has been selected you are brought to the maintenance portal to view and maintain the selected record.

The following zones may appear as part of the portal's **Main** tab page:

- **Specification:** This zone displays the basic attributes of the specification.
- **Specification Assets:** This zone displays a list of assets that reference the specification.

Device Management

Devices

About Meters



Meters are a type of device, which can be physical or virtual objects, that can produce data to be handled by the system.

A meter can have one or more device configurations over time. A meter's measuring components (if applicable) are associated with the device via device configurations.

A meter's device category (defined as an option on the device's business object) defines the broad category to which a particular device belongs. This option is used by smart meter commands and other processes when determining how the system should behave when executing processes based on the category of device. For example, when viewing items via the Device portal, certain item-specific zones appear that are not displayed when viewing meters or communication components. The base package supports the following device categories for meters:

- **Smart Meter:** these meters are associated to a head end system and support smart meter commands. The measuring components associated to these devices are expected to be read very frequently. These meters support periodic estimation

Refer to [Periodic Estimation](#) for additional functional information about how the periodic estimation can fill in missing reads for both interval and scalar measuring components.

- **AMR Meter:** these meters may also be associated to a head end system but they do not support smart meter commands. The measuring components are read frequently.
- **Manual Meter:** these meters are seldom read and do not support smart meter commands.

Attributes used to define devices include the following:

- Basic information about the Device including type of device (Smart Meter, Manual Meter, etc), Manufacturer, and Model
- One or more device identifiers such as serial number, badge number, meter number, etc.
- For smart meters the device can also specify a head end system and an incoming data shift. Note: these fields are only necessary when there is no fallback defined on the device type.

Refer to [Initial Measurement Data](#) for additional functional information about how the device's head end system and incoming data shift can impact processing.

About Items



While the most common type of devices are meters, there are many other devices that can be involved with a customer's service. These other devices are referred to simply as "items", and are used to represent lamps, poles, current transformers, backflow devices, pulse initiators, etc.

Items can be either "badged" or "unbadged". "Badged" items are those that have unique identifiers, and are represented by device records. Device records are not created for "unbadged" items. "Badged" items are installed at service points in much the same way as meters are installed (though they use an item-specific install event). For "unbadged" items, "multi-item" service points are used to define the number of each type of item that is installed at the service point.

These "badged" items are not directly measured and therefore do not have a measuring component. Instead there is configuration on the device type that will identify an effective dated average daily usage. Using the average daily usage the item's consumption will be calculated. The total consumption for a given period will always be equal to the average daily usage multiplied by the duration of the period. However, when the consumption for a period is turned into an interval curve there are two ways this can be done:

- **Use Straight Line:** the consumption will be evenly divided amongst the intervals (thus producing a straight line when graphed)
- **Use Profile:** a profile measuring component will be used to align the consumption to a curve. This is useful because it can more accurately identify the hours where consumption has occurred.

Refer to [About Service Points](#) for additional functional information about "unbadged" items.

About Communication Components

Communication components are devices attached to meters. A communication component may handle electronic transmission of measurement data, events, and commands in situations in which the underlying meter is not capable or not enabled to handle this data. Devices of this sort are sometimes referred to as ERT (Electronic Receiver/Transmitter) meters, or communication modules (for example, the term "gas module" may refer to a communication module attached to a gas meter).

Maintaining Devices

This portal is used to display and maintain devices.

Refer to [About Meters](#), [About Items](#), and [About Communication Components](#) for additional information about specific types of devices.

You can access the portal from **Menu > Device > Device**. You are brought to a query portal with options for searching. Once your record has been selected you are brought to the maintenance portal to view and maintain the selected record.

This portal includes the following zones:

- **Device**: defines the basic attributes of the device
- **Device Configuration Overview**: lists the device configurations for the device
- **Device Activities**: lists activities related to the device in date descending order
- **Device Events**: lists the most recent device events associated to the device in descending order
- **Device Exceptions**: lists the first 50 VEE exceptions for all measuring components for the device, sorted by the exception creation date in descending order

Assets and Devices

In Oracle Utilities Meter To Customer, devices are created when an [asset](#) is created (or replicated) The type of device created is based on the template device identified in the **Configuration Mapping** section of the specification referenced on the asset or associated with the asset type.

Device identifiers for devices created via an asset can not be changed in the **Device** portal. These identifiers must be changed in the [Asset](#) portal.

Devices created via an asset can not be deleted in the **Device** portal. If a device's related asset is deleted in the [Asset](#) portal., the device is deleted as well.

Device Configurations

About Device Configurations

Device configurations represent specific configurations of a device as of a certain time.

Over time, a device can have many configurations. Device configurations are effective-dated allowing a device to retain its identifiers (such as serial number, badge number, etc.) even while the quantities it measures change over time.

Each device configuration can have one or more measuring components associated with it.

Attributes used to define device configurations include the following:

- The device configuration type
- The parent device
- The effective date and time of the device configuration
- The time zone in which the device operates

Refer to [Multi Time Zone Support](#) for additional information on the importance of the Device Configuration time zone.

Maintaining Device Configurations

You use the Device Configuration portal to maintain device configurations.

Refer to [About Device Configuration](#) for additional functional information.

You can access the portal from **Menu > Device > Device Configuration**. You are brought to a query portal with options for searching. Once your record has been selected you are brought to the maintenance portal to view and maintain the selected record.

This portal includes the following zones:

- **Device Configuration:** Defines the basic attributes of the device configuration
- **Measuring Components:** Lists the measuring components for the device configuration
- **Scalar Readings:** Displays a list of scalar readings for scalar measuring components associated with the current device configuration. To create a new reading for scalar measuring components associated with the device configuration, click **New Reading**. To edit an existing reading, click the edit icon for the reading you wish to edit.

NOTE: The Scalar Readings zone is available only with Oracle Utilities Meter Data Management.

Measuring Components

About Measuring Components

Measuring components are single points for which data will be received and stored in the system.

A measuring component can be associated to a device, which can have one or more measuring components, or it can be "virtual" or "stand-alone," meaning that it is not associated to a device.

The base package supports the following types of measuring components:

- **Physical:** Physical measuring components are those that physically exist, and that are linked to a device that can be configured differently over time. Interval channels and scalar registers are examples of physical measuring components. Note: The terms register and channel are synonyms for measuring component.
- **Standalone:** A standalone measuring component is used to record measurements for something that does not have a physical presence or is not associated to a particular device or service point. For example, you might create a standalone measuring component to record the average daily temperature supplied by a weather station. Standalone measuring components can be identified through **Standalone Identifier**.
- **Scratchpad:** Users create scratchpad measuring components based on physical measuring components to experiment with measurement manipulation functions.
- **Aggregator:** An aggregator measuring component holds summarized usage from other measuring components. For example, aggregator measuring components could be configured to hold total consumption for each postal code within a service territory. Head-end system processing statistics used by Oracle Utilities Smart Grid Gateway are stored as aggregated measurements for aggregator measuring components. Refer to [About Aggregations](#) for additional functional information about aggregation measuring components.

Attributes used to define measuring components can include the following:

- The measuring component type
- The device configuration to which the measuring component is associated
- Details concerning how the measuring component is read, such as the number of digits, the type of read out (dials or digital), the meter multiplier, etc.
- The VEE groups used for validation and estimation of measurement data.
Refer to [About VEE](#) for details about the types of VEE groups supported.

Scalar vs. Interval

Beyond the four types described above, measuring components generally fall into one of two primary classes of: scalar measuring components, and interval measuring components.

- **Scalar measuring components** are measured at unpredictable intervals. For example, "once a month" is not a predictable interval as the amount of time between reads is unpredictable and inconsistent.
- **Interval measuring components** are measured at predictable intervals, such as every 15 minutes, every 30 minutes, every hour, etc.
- The terms "interval size" and "seconds-per-interval" (SPI) are used to define the size of an interval measuring component's intervals.
- Note: A device may have any combination of interval and/or scalar measuring components

Measuring Component Measurements

Measuring components are configured to measure specific types of quantities. These include:

- **Unit of Measure:** The unit of measure for the quantity being recorded. Examples include kilo-watt hours (kWh), kilowatts (kW), therms, cubic feet (CCF), temperature (Fahrenheit or Celsius), etc.
- **Time of Use:** Modifiers for a given unit of measure that indicate a period of time during which a quantity has been used, such as On-Peak (meaning during a time when the greatest quantity of some consumable is being used), Off-Peak (meaning during a time when the least amount of some consumable is being used), etc.
- **Service Quantity Identifiers:** Used to further distinguish between measured quantities that have identical UOM/TOU combinations, including situations in which the distinguishing identifier of a UOM is not accurately described as a TOU. Generally, SQI is only used when multiple measuring components measure the same thing, but in different ways. A meter that measures both generation KWH and consumption KWH could use SQIs to differentiate between the two.

The combination of UOM, TOU and SQI define what a measuring component measures. TOU and SQI are optional, but UOM must be defined for all measuring components. For example, consider a meter (as illustrated in the image below) with two measuring components, both measuring the same unit of measure (kWh), but each measuring component measures consumption in different time of use (TOU) periods (peak and off-peak).

Subtractive vs. Consumptive Measurements

Another attribute that defines how measuring components measure quantities is the distinction between subtractive and consumptive measuring components.

A subtractive measuring component's usage is equal to the current reading (also known as the Stop or End Measurement or Reading) minus the previous reading (also known as the Start Measurement or Reading). To put this more simply:

$$\text{Usage} = \text{End Reading} - \text{Start Reading}$$

Most residential scalar meters are subtractive and in some cases interval meters can be subtractive as well . The table below lists a series of measurements for a subtractive measuring component.

Date	kWh (Reading)	Usage
------	---------------	-------

01/01/2010	0	
01/31/2010	1000	1000 kWh
03/02/2010	1780	780 kWh
04/01/2010	2700	920 kWh

A consumptive measuring component's usage is equal to its current measurement. Most residential interval meters are subtractive. For scalar, consumptive measuring components are often used to measure demand, such as KW. The table below lists a series of measurements for a consumptive scalar measuring component.

Date	KW (Reading)	Usage
01/01/2010	0	0 KW
01/31/2010	10	10 KW
03/02/2010	10	10 KW
04/01/2010	13	13 KW

Physical Measuring Components

Physical measuring components are associated to the meters installed at service points. Through a device configuration there can be one-to-many measuring components in place at a given point in time. Much like other measuring components these are either scalar or interval and either consumptive or subtractive.

NOTE: Refer to [About Measuring Components](#) for additional information about scalar versus interval and consumptive versus subtractive measuring components.

The base product supports a core set of physical measuring components, as described in the following sections.

Interval Channel

These measuring components represent consumptive data that is recorded on a regular and consistent frequency as defined by the interval size. By definition interval data must fall on a specific interval boundary. For example, a meter that receives data once per hour cannot have a measurement at 1:30. Rather, the data must fall on either 1:00 or 2:00 not in between.

Data for interval channels is expected to be contiguous. However, in situations where it is not, there is no impact to the calculation of those intervals subsequent to the missing intervals. This is because the calculation of each interval is independent to all other intervals.

If there is a gap in the intervals it can be estimated through the periodic estimation process.

Interval Channel - Subtractive

These measuring components have behavior characteristics of both interval channels and registers. Like the interval channel they receive data on a regular and consistent frequency that is expected to be contiguous. Like a register they use a subtractive consumption calculation and provide rollover validation.

Unlike the interval channel when there are missing intervals there is an impact on the calculation of those intervals subsequent to the missing intervals. This is because the calculation of a given interval is always computed by subtracting its reading from the last known prior reading. The following table describes an example of that scenario:

Date/Time	Reading Condition	Reading	Measurement Condition	Usage
01/01/2010 12:00AM	Regular	0	Regular	0 kWh
01/01/2010 01:00AM	Regular	10	Regular	10 kWh

01/01/2010 02:00AM	Regular	20	Regular	10 kWh
01/01/2010 03:00AM	Regular	30	Regular	10 kWh
Missing measurements				
1/01/2010 12:00PM	Regular	120	Combined Quantity	90 kWh

Notice that the consumption for the 01/01/2010 12:00PM interval has become overloaded and covers the entire period for which no intervals have had been received. Also take note that the measurement condition is assigned a unique condition of Combined Quantity to signify that the consumption covers more than one interval.

A similar situation can arise when there has been an underestimation of consumption for a particular meter:

Date/Time	Reading Condition	Reading	Measurement Condition	Usage
01/01/2010 12:00AM	Regular	0	Regular	0 kWh
01/01/2010 01:00AM	System Estimate	10	System Estimate	10 kWh
01/01/2010 02:00AM	System Estimate	13	System Estimate	3 kWh
01/01/2010 03:00AM	System Estimate	16	System Estimate	3 kWh
1/01/2010 04:00AM	Regular	40	Estimated	24 kWh

To help avoid these situations where an interval becomes overloaded with usage due to missing or estimated intervals the subtractive interval channel has the ability to initiate the calculation of missing intervals or re-calculation of estimated intervals when processing newly received intervals.

NOTE: Refer to [Understanding Measuring Component Types](#) link for additional information about how to configure subtractive interval measuring component types to perform prior and subsequent estimation.

Register

A register, often referred to as scalar, measuring component is used to represent infrequently received data from a meter. Typically these types of measuring components will only be read once per month aligning to the billing period for the customer.

The physical meter these measuring components represent often have dial readings where there are a finite number of digits that can register the consumption. When the maximum amount has been measured the meter will rollover and start counting once more from zero. To appropriately handle these scenarios this type of measuring component can be defined with a rollover tolerance that allows the system to accurately identify an invalid reading from a standard rollover. For example when a meter has 6 dials (a maximum of 999,999):

- Going from a reading of 999,990 to 20 would likely be valid and represent consumption of 30.
- Whereas going from a reading of 999,990 to 800,000 would be an invalid reading since it would represent consumption of 810,000.

Given the infrequent nature of these measuring components they are not eligible for the periodic estimation process.

Register - Auto-Read

An automatically read register processes nearly identical to a register. The key difference between these two types of measuring components is that the automatically read variant is expected to be read on a frequency of at least once per day.

These measuring components are eligible for periodic estimation since the information about their reading schedule allows for missing readings to be detected and estimated.

Given the frequency these meters are read and the nature of subtractive consumption calculation they can be configured to re-estimate any past or future estimates when actual data has been received. The actual readings allow these estimates

to be refined since the total consumption for the estimated period can be calculated (current reading - last reading prior to estimation).

NOTE: Refer to [Periodic Estimation](#) for additional functional information about how the periodic estimation can fill in missing reads for both interval and scalar measuring components.

Scratchpad Measuring Components

Scratchpad measuring components provide users with a means to manipulate "scratchpad" measurement data without affecting existing "live" measurement data. Examples of measurement manipulation might include experimenting with the impact of executing the "spike smooth" function on an initial measurement, or adding or removing intervals to or from the measurement.

Scratchpad measuring components are defined by the same attributes as "regular" measuring components, with the following additional attributes:

- **User:** The name of the user who created the scratchpad. All scratchpad measuring components "belong" to a user.
- **Source Measuring Component:** The measuring component upon which the scratchpad is based.

Like "regular" measuring components, scratchpad measuring components can be related to a device through a device configuration, but scratchpad measuring components are not considered "active" for purposes of install events, and are not used in usage calculations for usage subscriptions.

Like "regular" measuring components, scratchpad measuring components are viewed and maintained using the Measuring Component portal, and measurement data for scratchpad measuring components can be viewed using the Initial Measurement portal or the 360 Degree View.

Maintaining Measuring Components

You use the **Measuring Component** portal to maintain measuring components.

Refer to [About Measuring Components](#) for additional functional information.

You can access the portal from **Menu > Device > Measuring Components**. You are brought to a query portal with options for searching. Once your record has been selected you are brought to the maintenance portal to view and maintain the selected record.

This portal includes the following zones:

- **Measuring Component:** defines the basic attributes of the measuring component
- **Initial Measurement Data History:** lists the last 50 initial measurements for the measuring component in reverse chronological order.
- **Measuring Component Profile Use:** lists all profile factors on which the measuring component is referenced as a factor value.
- **Measurements:** lists final measurements for the measuring component, including any derived values for each measurement. Note: depending on the type of measuring component this zone may be the Interval, Scalar, or Subtractive Interval variant.
- **Device Configuration Overview:** Displays an overview of the measuring component's parent device's configurations over time, including the measuring components associated with each configuration, and service points (along with the relevant install events) at which the device's configurations have been installed over time, if any exist.
- **Data Requests:** Lists data requests for the measuring component. Applicable only for Standalone Data Request measuring components (based on the Standalone Data Request MC business object)

- **Measuring Component Comparison Period Details:** Lists comparison periods for the measuring component (created when the current measuring component is compared to another measuring component via the Interval Proxy Day Estimation VEE rule)

Uploading Measurement Data

Measurement data for a measuring component can be manually uploaded in comma separated values (CSV) format. This can be used to import data from external sources, such as weather systems or other market participants such as system operators in a settlement market.

This feature is accessed via the **Load IMDs (CSV)** option on the measuring component's context menu. When this option is selected, the **Online IMD CSV Upload** screen opens. From this screen users can select a CSV file containing measurement data to upload from a local desktop.

Import files can contain one or more initial measurements. For interval data, breaks between initial measurements will be based on a gap greater than one interval size (SPI) between intervals. For scalar measurements, each row will create a separate initial measurement.

Refer to the embedded help on this page for details concerning the format of CSV files used for importing measurement data.

When processed, each initial measurement in the import file results in the creating of an initial measurement for the measuring component.

Requesting Measurement Data

The base package provides a mechanism by which standalone measuring components can request data from an external application. Examples of this include requesting data weather data from a weather station or zonal load data from an independent system operator (ISO) when used with Oracle Utilities Market Settlements Management. Measuring components of this type are referred to as "standalone measuring components".

Standalone Data Request Measuring Components

Requesting measurement data for standalone measuring components is supported by the "Standalone Data Request MC" (D1-StandaloneDataRequestMC) and "Standalone Data Request MC Type (D1-StandaloneDataRequestMCType)" business objects.

Standalone data request measuring components use many of the same attributes as device-based measuring components, but also use the following unique parameters:

- **Standalone Identifier:** An identifier for the measuring component. This ID is used when importing data for standalone measuring components via the standard initial measurement loading process (see [About Initial Measurement Data](#) for more information).
- **Processing Timetable Type:** A processing timetable type used when scheduling data requests. If not specified, a fallback processing timetable type can be defined on the measuring component's type.
- **Service Provider:** The external application to which data requests are sent. If not specified, a fallback external application can be defined on the measuring component's type.
- **Request Information:** Details about the last data request processed for the measuring component

Measurement Data Requests

Requests for measurement data can be scheduled or made manually by a user.

- Scheduled requests are triggered by the "Standalone MC Data Request - Monitor" batch process.

- Manual requests are triggered by clicking the **Request Data** button in the **Record Actions** section of the **Measuring Component** zone.

This opens the Request dialog where te user enters a start and end date/time for the request.

Each of these invokes the “Calculate Schedule and Create Outbound Communication” algorithm which creates an outbound communication based on the processing method defined for the external application (Service Provider). When the external application sends back the requested measurement data, it can be received via the standard method for importing measurement data.

Configuring External Applications for Measurement Data Requests

To support measurement data requests, the following processing method must be defined for the external applications to which data requests are sent:

Processing Role	Processing Method
Standalone MC Data Request	<p>How to Send MC Related Information</p> <p>Used to send the outbound communication to the external application.</p> <p>Default Communication Out Business Object: D1-StandaloneMCDataRequest (Standalone MC Data Request Communication Out</p> <p>The Request Mapping Algorithm and Response Mapping Algorithm options can be used to map the format of data both from the standard format to an external system format and from an external system format to the standard format.</p> <p>For example, when requesting for zonal load from an ISO the process would be:</p> <ul style="list-style-type: none"> • Take the input of an outbound communication that has the measuring component’s standalone ID and the date/times and put it into the zonal request format for the ISO • Take the input of an outbound message that has the response from the ISO with the intervals and convert it into the IMD format

In addition, the following objects must be configured to send data requests.:

- Communication Type for “Standalone MC Data Request Communication Type”
- External System
- Outbound Message Type
- Message Sender

Measuring Component Comparison Periods

About Measuring Component Comparison Periods

Measuring component comparison periods are records of measuring component comparison. These are used by the Interval Proxy Day Estimation VEE rule to compare weather data to identify historical dates that most closely match current and/or future dates.

Measuring component comparison periods are created by the Interval Proxy Day Estimation rule, and are defined the following:

- **Primary Measuring Component:** The measuring component against which the comparison will be run
- **End Date / Start Date:** The date range that is compared to the period for the **Examined Measuring Component** (defined by the **Examined End Date** and **Examined Start Date**)
- **Rank:** The rank of this data point relative to the other comparison period stores for the same Measuring Component, Comparison Type, and End Date. The lower the rank, the better.
- **Examined Measuring Component:** The measuring component that will be compared to the **Primary Measuring Component**.
- **Examined End Date / Examined Start Date:** The date range that is compared to the period for the Primary Measuring Component (defined by the **End Date** and **Start Date**)
- **Lowest Quality Condition Code:** The lowest quality of condition code that was found for the measurements in the related period.
- **Comparison Metric:** The specific metric used to calculate the Comparison Result from the related Comparison Type)
- **Comparison Result:** The value result of the comparison.

Maintaining Measuring Component Comparison Periods

You use the **Measuring Component Comparison Period** portal to maintain measuring component comparison periods.

Refer to [About Measuring Component Comparison Periods](#) for additional functional information.

You can access the portal from **Menu > Device > Measuring Component Comparison Period**. You are brought to a query portal with options for searching. Once your record has been selected you are brought to the maintenance portal to view and maintain the selected record.

The following zones may appear as part of the portal's **Main** tab page:

- **Measuring Component Comparison Period:** This zone displays the basic attributes of the measuring component comparison period.

Device Installations

Service Points

About Service Points

Service points are physical locations (usually a meter socket) at which a company supplies service and are used in Oracle Utilities Customer To Meter to store information describing the type of service supplied and how it is measured. Devices are installed at service points, and the relationship between individual service points and devices can change over time. For example, over time different devices may be installed at a service point, and a device may be installed at different service points.

A service point may only have one device. If multiple devices at a service point are required, define a parent and child service point relationship to create a hierarchy of service points. On each service point, users will be able to specify a parent service point. An example of this feature would be to link each condominium in a building to a parent service point that represents the common areas of the building. Another example would be a deregulated service point that allows multiple

devices per service point. In this example, the parent service point would be the market service point ID and the children service points would relate to the individual devices.

Service Point

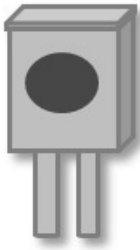

Attributes used to define Service Points can include the following:

- Basic information about the Service Point, including address, time zone, market, parent Service Point (if applicable), status, and main contact
- Specifics related to whether or not the current Service Point supplies service to life support equipment, or if the load supplied to the Service Point is considered sensitive.
- Information related to field work performed at the current Service Point, including any applicable warnings or instructions
- The measurement cycle, route, and route sequence for the Service Point

Service Points and Characteristics

Characteristics can be defined for Customer To Meter service points using the **SP Characteristics** zone on the **Service Point** portal. Only characteristics of types defined for the service point's type in the **Valid SP Characteristic Types** zone on the **Service Point** portal can be defined for the service point.

Service Points and Asset Locations

In Oracle Utilities Customer To Meter, when a service point is created, a corresponding asset location is created. Asset locations are maintained using the [Service Point](#) portal. If the service point has a contact associated with it, a corresponding contact will be created for the asset location.

NOTE: In Oracle Utilities Customer To Meter, service points are maintained via [Merged Maintenance](#).

Service Point Equipment

The **Service Point Equipment Information** section defines items (devices) in the system that may be installed at the service point over time, such as a current transformer at an electric service point or a backflow device at a water service point. Items of this type are most often created from an asset being added to the system (see [Assets and Devices](#) for more information).

Service point equipment information includes the following for each item installed:

- **Item ID:** The ID and information string for the item (or items)
- **Installation Date/Time:** The date and time at which the item (or items) was installed at the service point
- **Removal Date/Time:** The date and time at which the item (or items) was removed from the service point
- **Equipment Count:** The number of items installed at the service point, if applicable
- **Comments:** Optional comments about the item's installation at the service point

When an item is installed or removed from a service point, the asset disposition of the items' corresponding asset is updated accordingly.

Deleting an item from the **Service Point Equipment Information** section deletes the record of its installation at the service point (including its installation history), but does NOT delete the item from the system.

Unbadged Items

Items that do not have any unique identification are referred to as "unbadged." These types of items, unlike "badged" items, do not have a device to represent them. Instead they are associated to service points with the service point category of "multi-item." For these types of service points a list of "unbadged" items can be configured to represent the items that require usage to be calculated. This is an effective dated list that allows for changes over time to the type and count of items over time. The consumption of the list of items is either calculated using the service quantity associated to the item types listed or by using the installation override quantity that can be specified on the service point.

Refer to [Multi Time Zone Support](#) for additional information on the importance of the Service Point time zone.

Maintaining Service Points

This portal is used to display and maintain service points.

Refer to [About Service Points](#) for additional functional information.

You can access the portal from **Menu > Customer Information > Service Point**. You are brought to a query portal with options for searching. Once your record has been selected you are brought to the maintenance portal to view and maintain the selected record.

The following zones may appear as part of the portal's **Main** tab page:

- **Service Point:** defines the basic attributes of the Service Point
- **SP Characteristics:** displays characteristics defined for the service point. To add service point characteristics, click the **Edit** link in the zone title bar.

NOTE: Only characteristics of types defined for the service point's type in the **Valid SP Characteristic Types** zone on the **Service Point Type** portal can be defined for the service point.

- **SP Geographic Information:** displays the geographic information for the service point. To add geographical information for the service point, click the **Edit** link in the zone title bar.
- **Device History:** lists all Device Configurations that have been installed for the Service Point, in reverse chronological order
- **Usage Subscriptions:** lists all Usage Subscriptions linked to the Service Point, sorted in descending order by Start Date/Time of Usage Subscription/Service Point
- **SP Quantities:** lists service point quantities for the current service point
- **SP Market Participants:** lists all market participants linked to the current service point
- **Child Service Points:** lists the first 50 children Service Points of the parent Service Point
- **SP/Measurement Cycle Schedule Routes:** lists all the Measurement Cycle Schedule Routes linked to the Service Point.
- **SP Service Issue Monitors:** displays a list of service issue monitors and related service investigative orders related to the current Service Point, in reverse chronological order.
- **SP Suppression History:** displays a list of suppression activities related to the service point in reverse chronological order.
- **SP Activity History:** shows all activities linked to the service point. The results can be filtered based on activity type category and creation date/time.

- **SP Network Locations:** lists all network locations linked to any facility associated with the service point, ordered by start date/time
- **SP Business Flags:** displays a list of business flags related to the service point in reverse chronological order.

NOTE: In Oracle Utilities Customer To Meter, Service Points are maintained via [Merged Maintenance](#). In addition, when a service point is created, a corresponding asset location is created. If the service point has a contact associated with it, a corresponding contact will be created for the asset location.

NOTE:

When an item is installed or removed from a service point (in the **Service Point Equipment Information** section), the asset disposition of the items' corresponding asset is updated accordingly. Deleting an item from the **Service Point Equipment Information** section deletes the record of its installation at the service point (including its installation history), but does NOT delete the item from the system.

Service Point Quantities

About Service Point Quantities

Service point quantities are quantities that are stored at the service point level. These quantities are calculated at irregular frequencies (such as annually or quarterly) and thus do not make sense as a measured quantity on a device and measuring component. For example, in some deregulated markets the Peak Load Contribution could be stored here and effective dated over time to represent the changing contribution of a given service point to the market wide coincidence peaks.

Service point quantities are defined by the following:

- **Service Point:** The service point for which the quantities were calculated
- **Service Point Quantity Type:** The Service Point Quantity Type used for the record
- **Start Date / End Date:** The date range for the calculated quantity
- **Service Point Quantities:** Calculated quantities based on **Quantity Identifiers** configured on the Service Point Quantity Type (see [Understanding Service Point Quantity Types](#) for more information)

NOTE: There cannot be more than one Service Point Quantity for the same Service Point, Service Point Quantity Type, for the same time period (defined by the Start Date and End Date parameters).

Maintaining Service Point Quantities

You use the **Service Point Quantity** portal to view and maintain service point quantities.

Refer to [About Service Point Quantities](#) for additional functional information.

You can access the portal from the **Main > Device Installation > Service Point Quantity**. You are brought to a query portal with options for searching. Once your record has been selected you are brought to the maintenance portal to view and maintain the selected record.

The following zones may appear as part of the portal's **Main** tab page:

- **Service Point Quantity:** This zone displays the basic attributes of the service point quantity

Install Events

About Install Events

Whenever a device is installed at a Service Point, an installation event is created. Installation events capture the history of the devices that have been installed at a Service Point. This allows consumption for a Service Point to be calculated over time. In technical terms, installation events (or Install Events) link a specific Device Configuration to a Service Point.

There are specific Install Event business objects for different types of devices, including smart meters, items, manual meters, and communication components.

When creating Install Events for items, only "badged" items (those that are uniquely identified in some way) use item Install Events. "Unbadged" items do not use Install Events. Instead, the number of each type of item is specified in the "Multi-Item Detail" section of the Service Point.

While a device is installed at a Service Point, it may be turned off (and back on again). The installation event that records the original installation date and time also records the dates and times when the device has been turned on and off. When a device is removed, the original installation event is updated with the removal date and time.

In Oracle Utilities Customer To Meter, when a device with a related asset is installed at a service point, the install event updates the asset's disposition, changing its **Status** and **Asset Disposition** to "Installed" and its **Location** to the service point with an effective date matching the install event's **Installation Date/Time**.

Maintaining Install Events

This portal is used to display and maintain install events.

Refer to [About Install Events](#) for additional functional information.

You can access the portal from **Menu > Device Installation > Install Event**. You are brought to a query portal with options for searching. Once your record has been selected you are brought to the maintenance portal to view and maintain the selected record.

The following zones may appear as part of the portal's **Main** tab page:

- **Install Event:** defines the basic attributes of the Install Event, the on/off history for the Install Event, and removal information.

When creating a new record, the following options are available:

Name	Details	Business Object
Communication Component Install Event	This Install Event is intended for use with a Communication Component that is installed on top of a traditional Meter.	D1-CommComponentInstallEvent
Item Installation Event	This Install Event records the installation of an Item (i.e. streetlight).	D1-ItemInstallEvent
Manual Meter Installation Event	This Install Event is used for manually read meters.	D1-ManualMeterInstallEvent
Smart Meter Installation Event	This Install Event is unique to smart meters and has a lifecycle that's maintained by remote meter commands.	D1-SmartMeterInstallEvent

In Oracle Utilities Customer To Meter, when a device with a related asset is installed at a service point, the install event updates the asset's disposition, changing its **Status** and **Asset Disposition** to "Installed" and its **Location** to the service point with an effective date matching the install event's **Installation Date/Time**.

Route Management

About Route Management

Route management involves managing the order of the Service Points within measurement cycles and routes.

When creating Service Points, each Service Point can reference a measurement cycle, route, and its sequence within the route. Over time, as Service Points are added and removed to and from measurement cycles and routes, it may become necessary to change the sequence of Service Points within the measurement cycles and routes used in your implementation.

- A **measurement cycle** defines WHEN the Service Point is visited
- A **route** within a cycle defines a group of Service Points in a cycle that are visited by a meter reader
- A **sequence** within a route defines the physical position of the Service Point within a route
- A **schedule** specifies the dates on which Service Points are visited.

Manually read Service Point reference a measurement cycle, route and sequence within the route. A batch process creates SP/Measurement Cycle Schedule Routes for each Service Point, which link the dates on a measurement cycle schedule to a measurement cycle route defined for the Service Point. These define the specific date on which a meter reader will visit Service Points associated with a specific measurement cycle route, and the sequence in which the Service Points on that route are visited.

Measurement Cycles

Measurement cycles define the schedule for manual meter reading of devices at Service Points in that cycle. Measurement cycles can have one or more associated routes used to collect measurements.

Measurement cycles can also be configured to define when to [create usage transactions](#) for Usage Subscriptions associated to Service Points in the cycle.

Measurement Cycle Schedules

Measurement cycle schedules define the dates on which devices are scheduled to be read for a given measurement cycle and the routes used to collect measurements for the measurement cycle.

Working with Route Management

This Route Management portal is used to change the sequence of Service Points within a measurement cycle and route and to transfer Service Points from one measurement cycle and route to another.

Refer to [About Route Management](#) for additional functional information.

You can access the portal from the **Main > Device Installation > Route Management**. You are brought to a query portal with options for searching. Once you enter your search criteria, a list of related Service Points is presented.

The following actions are available once a Measurement Cycle and Route are selected:

- **Renumber Sequence:** renumbers the sequence of selected Service Points for the route. Use the Renumber Sequence page to renumber the sequence of Service Points in a measurement cycle route.
- **Transfer Measurement Cycle Route:** Use this button to transfer the selected Service Points to another route. Use the Transfer Measurement Cycle Route page to transfer the selected Service Points to another measurement cycle route. You can also renumber the sequence of Service Points in their new route as part of the transfer.

Facilities

About Facilities

Facilities represent the network node level closest to the Service Point. In terms of electric networks, facilities typically represent transformers.

While "Facility" is the generic name for this object, many of the Business Objects created within Oracle Utilities Meter Data Management have a more specific name. One good example is the Transformer (D1-Transformer) Business Object.

Maintaining Facilities

This portal is used to display and maintain a Facility.

Refer to [About Facilities](#) for additional functional information.

You can access the portal from **Menu > Device Installation > Facility**. You are brought to a query portal with options for searching. Once your record has been selected you are brought to the maintenance portal to view and maintain the selected record.

The following zones may appear as part of the portal's **Main** tab page:

- **Facility:** defines the basic attributes of the facility
- **Network Locations Related to Facility:** displays a list of network locations associated with the current facility in reverse chronological order.
- **Service Points Related to Facility:** displays a list of Service Points related to the current facility, in reverse chronological order.

Network Locations

About Network Locations

Network locations define the location of a facility within a larger network.

Network locations hold the network nodes that provide service to a facility. In the case of electric networks, network locations define the feeder and substation associated with a transformer (facility). Because these network nodes can change over time, a facility can have many network locations (this is an effective-dated relationship). For example, for electric Service Points, whenever the substation or feeder that provides power to a given transformer is changed, a new record that references the latest substation and feeder should be created.

Maintaining Network Locations

This portal is used to display and maintain a Network Location.

Refer to [About Network Locations](#) for additional functional information.

You can access the portal from **Menu > Device Installation > Network Location**. You are brought to a query portal with options for searching. Once your record has been selected you are brought to the maintenance portal to view and maintain the selected record.

The following zones may appear as part of the portal's **Main** tab page:

- **Network Location:** defines the basic attributes of the network location
- **Service Points Related to Network Location:** displays a list of Service Points related to the current network location, in reverse chronological order.

Measurements

Initial Measurement Data

About Initial Measurement Data

Initial measurement data (IMD) is the term for measurement data in its initial (or raw) form.

Measurements read from a measuring component are referred to as "initial measurement data" (or initial measurements) and are used to record how much of the quantity (defined by UOM, TOU, and SQI) measured by the measuring component was consumed.

Initial measurement data for scalar measuring components contain a single "reading" or value, while initial measurement data for interval measuring components can contain multiple readings, one for each interval that falls between the start time and stop time of the measurement.

At a simple level, initial measurement data goes through the following process:

1. Initial measurements are loaded into the system.
2. Initial measurement data is validated, edited, and estimated (VEE). Please refer to [About VEE](#) for more details on the VEE process.
3. Initial measurements are converted into final measurements.
4. If using Oracle Utilities Meter Data Management, final measurements are used to calculate usage (bill determinants, etc.). Please refer to [About Usage Calculation](#) for more details on the usage calculation process.

Only initial measurements can be edited directly by end users.

Initial measurement data contains both the original and final versions of the quantities recorded by the measuring component.

- Pre VEE quantities are consumption values derived from the measurements recorded by the head-end system or meter reader with the appropriate installation and measuring component multipliers applied.
- Post VEE quantities are the "final" values, after VEE processing.

Pre VEE and Post VEE quantities in an initial measurement often differ based on a number of conditions, including:

- VEE rules have changed the quantities because they are missing or obviously wrong. In this, the Pre VEE values are adjusted based on the specifics of the VEE rules applied to the initial measurement to create the Post VEE values
- Manual changes by a user.

In addition to recorded consumption values, measurements also have condition codes, used to indicate the source and quality of a measurement. For example:

- Regularly recorded measurements might have a condition code of "Regular"
- Missing measurements might have a condition code of "Missing"

- Estimated measurements might have a condition code of "External Estimated" or "System Estimated" based on where the estimation was performed.

Both Pre VEE and Post VEE values have their own condition code, which can also change during VEE processing. For example, a measurement that was missing in the Pre VEE document will likely become "System Estimated" in the Post VEE document once VEE has been executed.

Processing Initial Measurement Data

Initial measurement data (IMD) received from external systems is processed through two major stages:

- **IMD Seeder:** This is the common interface point that receives all IMD information and performs critical validations and conversions. During this process the IMD Seeder identifies the appropriate specific IMD business object for further processing. The choice is made based on the category of IMD being processed (typically initial load) and the type of measuring component the IMD is for. For example, an IMD for an interval measuring component would result in the Initial Load IMD (Interval) business object being selected. If for some reason the IMD Seeder encounters an error an instance of the IMD Seeder will be created to manage the resolution of that error.
- **Specific IMD:** Each specific IMD has the appropriate calculation and validation logic for the type of data that has been received. An IMD containing scalar data will be processed differently than interval data or subtractive interval data. However, all types of data will have a similar set of steps taken:
 - Any external system specific statuses for the measurement data are interpreted into the appropriate internal statuses
 - An initial consumption calculation is performed
 - VEE rules are executed
 - Final measurements are created

IMD Seeder Processing

The IMD Seeder receives IMD data in a common structure, however, the content of the data (identifiers, date/times, etc) can vary depending on the system and the particular device that generated it. To accurately translate the external content to values understood by the system the IMD Seeder leverages the configuration of the service provider (aka head end or external system) and the device.

The service provider specifies the following inputs into IMD Seeder processing:

- **Identifier Types:** Each IMD must identify the device and measuring component the data has been generated from. The system supports a multitude of identifiers for both the device and measuring component. The service provider configuration specifies which identifier types are used for both the device and the measuring component which enables the IMD seeder to search for the correct destination for the measurement data. For example, a service provider might indicate that devices are identified by a serial number and measuring components are identified by a channel identifier.
- **Date/Time Format:** The service provider configuration will identify whether the date/times that were sent included specific time zone designations. This allows the system to accurately handle any time zone conversions that may be necessary.
- **Processing Methods:** A service provider has many processing methods that are used in the evaluation of the IMD.
 - Initial Measurement Creation - Maps a given measuring component type to the initial measurement BO that should be created
 - UOM Translation - Identifies the extendable lookup that should be used to map the service provider specific UOM to the internal UOM
 - TOU Translation - Identifies the extendable lookup that should be used to map the service provider specific TOU to the internal TOU
 - SQI Translation - Identifies the extendable lookup that should be used to map the service provider specific SQI to the internal SQI

- Time Zone Translation - Identifies the extendable lookup to be used in mapping the service provider specific time zone to the interval time zone.

The device specifies the following inputs into IMD Seeder processing:

- **Incoming Data Shift:** This value is either specified directly on the device or can be defaulted via fallback on the device type. It identifies whether the incoming date/time information has is "Shifted" meaning it has been adjusted for Daylight Savings Time (DST) when in effect, or it is "Not Shifted" which means it will never be adjusted for DST. This plays an important role in the date/time processing since all incoming IMD date/times will be stored without an adjustment for DST.

With these inputs the IMD Seeder is able to translate the external identifiers into the appropriate identifiers to tie the IMD data to a specific measuring component in the system.

Once a measuring component is identified it is then used to select the appropriate IMD business object using the "Initial Measurement Creation" processing method of the service provider.

IMD Seeder Critical Validations

For Initial Measurement Data (IMD) to continue on to specific IMD processing it must pass several critical validations:

- The measuring component must be identified.
- The IMD must contain the appropriate date/times for the type of IMD being processed: scalar must have an end date/time and interval must have both a start and end date/time.
- The interval list must match the number of intervals expected based on the IMD start and end date/times. Note: if there are too few intervals the missing intervals can be automatically added to the IMD without generating an error. How this is done depends on whether there are date/times for each individual interval. If there are date/times for each interval the missing intervals are placed where the gaps exist. Otherwise when there are no date/times for the individual intervals the missing intervals are added to the end of the interval list.

If any of the critical validations have failed the IMD processing will be halted and an instance of the IMD Seeder will be created

Note: There is special logic that exists for handling the situation where either the IMD start date/time or the IMD end date/time falls on the duplicate hour that occurs when a time zone transitions out of daylight savings time. Typically there are two 1AMs on that day, one is considered to be during DST and the other is not. To ensure that the appropriate hour is selected the IMD Seeder uses the count of intervals and final measurements that exist prior to the IMD to identify the appropriate hour.

NOTE: Additional detail on the logic to derive the service provider, device, and measuring component identification can be found on the D1-DER-SPRMC Algorithm Type.

IMD Seeder Time Zone Translation and Conversion

To provide the most accurate tracking of measurement data all initial measurement data is stored in a single time zone without an adjustment for Daylight Savings Time (DST). As utilities can have multiple head end systems that each send date/time information in different ways and some utilities operate in multiple time zones the IMD Seeder contains functionality to convert incoming date/times from a source time zone into the time zone of Oracle Utilities Meter Data Management (as indicated by the base time zone)

There are three components to identifying the source time zone of the incoming IMD:

- **Service Provider IMD Import Date/Time Format:** When the IMD date/times are sent in format that identifies the time zone for each date/time the date/times will be delivered to the IMD Seeder already converted.
- **Incoming Data Shift:** This indicates whether the date/times will be adjusted for DST while it is in effect. A value of "Always in Local Time" indicates that the date/times are adjusted for DST. A value of "Always in Standard Time" indicates that the date/times are not adjusted for DST
- **Time Zone:** The time zone of the incoming data is identified using the follow order of precedence:

1. The time zone as indicated by the IMD data
2. The service point time zone
3. The device configuration time zone
4. The measuring component time zone
5. The base time zone

Once the time zone and the data shift of the incoming date/times is identified all date/times will be converted from that time zone and shift into the base time zone in standard time.

NOTE: Additional detail on the logic for date/time adjustments and validation of undercount and overcount can be found on the D1-DODTTMADJ Algorithm Type.

Specific Initial Measurement Data Processing

There are several categories of initial measurement data:

Initial Load

When initial measurement data is received from external systems (e.g. Head End systems) it is processed using the initial load IMD type. These IMDs are configured to execute the VEE rules that are associated to the Initial Load VEE role on the measuring component (or measuring component type in the case of a fallback). For adapter specific variations of the Initial Load IMD there is logic to map external measurement statuses to measurement conditions.

Estimation

For various reasons a meter will not report measurement data for a certain period of time. When the system detects that a measuring component is missing final measurements, it can create an initial measurement to execute estimation rules. This type of initial measurement is referred to as an estimated initial measurement.

At a high-level, the estimation process is as follows:

- Missing final measurements are detected by the Periodic Estimation process
- Estimated initial measurements are created for the "missing" time period by the Period Estimation process
- Values and consumption for the estimated initial measurements are calculated by "estimation" VEE rules.

It's important to note that the processes that detect missing measurements do NOT themselves estimate consumption. Rather, these detection processes simply create an initial measurement and let the estimation VEE rules estimate the consumption for the initial measurement.

Estimation IMDs execute the VEE rules associated to the Estimation VEE role on the measuring component (or measuring component type in the case of a fallback).

NOTE: Refer to [Periodic Estimation](#) for additional functional information about how the periodic estimation can fill in missing reads for both interval and scalar measuring components.

Manual Override

Manual override IMDs are used when the creation of an IMD is user initiated as can be done from the various functions available on some of the 360 Degree zones (e.g., Final Values Overlay, Interval - Initial Measurement Overlay, etc.). Unlike other types of IMD manual override allow the user to edit the initial measurement data prior to performing VEE. These IMDs are used for more advanced tasks where a user must specify, either directly or through a measurement function, the values for the initial measurements.

These IMDs are systematically created during the reconciliation process that occurs when IMDs are finalized for measuring components with subtractive consumption calculations. They are used to recalculate the consumption on a measurement subsequent to an IMD when the start reading for that subsequent measurement has been changed.

Manual override IMDs execute the VEE rules associated to the Manual Override VEE role on the measuring component (or measuring component type in the case of a fallback).

System

A system is generated by internal system processes that need to recalculate measurement multipliers. They do not perform VEE but they can be configured to do so.

NOTE: Refer to [About Measurement Reprocessing](#) for additional functional information about how the system IMDs are created.

Data Conversion

This type of IMD has only the processing necessary to propagate converted measurement data into the system. The data provided to these IMDs is expected to be the quality of final measurements. Therefore no VEE rules will be executed.

Scalar Initial Measurement Data Processing

Initial measurement data for subtractive scalar measuring components contain start and stop readings in addition to Pre and Post VEE usage. For example, a set of initial measurements for a subtractive scalar measuring component might look like the following:

Date/Time	Start Reading	Stop Reading	Pre VEE Usage	Pre VEE Condition	Post VEE Usage	Post VEE Condition
01/01/2010 12:00AM	0	1500	1500	Regular	1500	Regular
02/02/2010 4:11PM	1500	2100	0	Missing	600	System Estimate
03/03/2010 5:22 PM	2100	2900	800	Regular	800	Regular
04/01/2010 01:00PM	2900	3500	0	Missing	600	System Estimate

Subtractive measuring components can "rollover" when the reading exceeds the maximum value based on the number of dials. For example, a register with a 4 dials can record values up to 9999 before rolling over to 0000. When this occurs, consumption is calculated based on the following attributes and calculated values.

- **Rollover Threshold** is the percentage of the measuring component's dial capacity at which measurements for measuring components of this type are considered to have rolled over. Dial capacity is the largest value that can be recorded for the measuring component, based on the measuring component's number of dials. For example, a measuring component with 5 dials has a dial capacity of 99999.
- **Max Dial Capacity** is the maximum value for the number of dials, rounded up to the next whole multiple of 10 (or 10 raised to the power of the number of dials). For example, for a register with 4 dials, the max dial value is 10000.
- **Max Acceptable Difference** is the maximum acceptable consumption that can be recorded for the register. This is equal to the Max Dial Capacity multiplied by the rollover threshold. For example, the Max Acceptable Difference for a register with 4 dials and a rollover threshold of 90% would be 9000. If the consumption is greater than this value, the initial measurement is transitioned to the Error state.
- **Difference:** The difference between the Stop Reading and Start Reading, obtained by subtracting the Start Reading from the Stop Reading. If the Difference is less than zero (<0), then add the Max Dial Capacity to calculate Rollover.
- **Rollover:** The adjusted consumption for a reading on a register that has rolled over. Only applicable if the Difference (Stop Reading - Start Reading) is less than zero (<0).

- **Consumption:** The calculated consumption for the reading, equal to either the Difference or Rollover. If the Difference is greater than or equal to zero, consumption is equal to the Difference. If the Difference is less than zero (<0), and the Rollover is less than or equal to the Max Acceptable Difference, the consumption is equal to the Rollover.

Example: Consider an initial measurement with the following attributes:

- Number of Dials: 4
- Rollover Threshold: 90 (%)
- Start Reading: 8900
- Stop Reading: 0500

For this reading,

- Max Dial Capacity = 10000
- Max Acceptable Difference = 9000 (10000 * 90)
- Difference = 0500 (Stop Reading) - 8900 (Start Reading) or **-8400**
- Rollover = 10000 (Max Dial Capacity) + -8400 (Difference) or **1600**
- Consumption is equal to **1600** (Rollover).

Each scalar IMD that is processed will perform a rollover validation based on the start reading. For those scalar IMDs that have measurements subsequent to the date being processed there will be an additional rollover validation forwards to ensure that the current IMD does not invalidate a future reading.

If the rollover validation fails when validating either backwards, forwards, or both then the system will attempt to automatically correct the situation by evaluating whether the measurements prior to or subsequent to the IMD can be removed. This analysis is done based on the condition of the measurement and the condition of the IMD. For example. If there is a rollover based on the start measurement and the start measurement is a system estimate but the IMD is regular then the start reading will be bypassed and the system will search backwards until:

- It identifies a measurement with a reading that does not cause a rollover when used as the start reading for the IMD
- It encounters a measurement that causes a rollover but is also regular and therefore cannot be bypassed. At this point the IMD would be placed in an error status.

When a rollover error is identified that cannot be automatically corrected there are a few options available for fixing the situation:

- The "Override Condition" functionality can be used. This is an action button available on the IMD from within the Error status. It allows the user to provide a higher quality condition for the IMD to force the rollover process to bypass the measurement (either prior to or subsequent to the IMD) that was the source of the rollover threshold error. For example, if the start read was a regular measurement and the IMD was also a regular measurement the user could update the IMD to have a condition of "Super" which would allow the regular start reading to be bypassed.
- A Manual Override IMD could be created to adjust the measurements surrounding the IMD to ensure that the rollover error is no longer encountered.

NOTE: When a measurement is bypassed by the rollover automatic correction logic it will be set to Do Not Use when the IMD is finalized.

A scalar IMD can generate a manual override IMD during the finalization process when the need for reconciliation is identified. This happens whenever an IMD is received that occurs prior to an already existing scalar measurement. Since the newly processed IMD will introduce a new start reading for the existing subsequent measurement it is necessary to use the manual override IMD to recalculate the consumption. For example, imagine a scalar measuring component had the following readings:

Date/Time	Start Reading	Stop Reading	Pre VEE Usage	Pre VEE Condition	Post VEE Usage	Post VEE Condition
-----------	---------------	--------------	---------------	-------------------	----------------	--------------------

01/01/2010 12:00AM	0	1500	1500	Regular	1500	Regular
02/02/2010 4:11PM	1500	2100	0	Regular	600	Regular
04/01/2010 01:00PM	2100	3500	1400	Regular	1400	Regular

When the February reading is finally received it will spawn a reconciliation Manual Override IMD to correct the consumption of the April reading given the new start reading:

Date/Time	Start Reading	Stop Reading	Pre VEE Usage	Pre VEE Condition	Post VEE Usage	Post VEE Condition
01/01/2010 12:00AM	0	1500	1500	Regular	1500	Regular
02/02/2010 4:11PM	1500	2100	600	Regular	600	Regular
03/03/2010 5:22 PM	2100	2900	800	Regular	800	Regular
04/01/2010 01:00PM	2900	3500	600	Regular	600	Regular

NOTE: These reconciliation IMDs are generated during the finalization of the initiating IMD and must finalize themselves. If for some reason the reconciliation IMD does not complete it will prevent the initiating IMD from finalizing as well. Typically the reason for this issue will be a VEE exception that is being raised against the reconciliation IMD. The reason this rule is enforced is to ensure that the quantity of a measurement always aligns to the reading of that same measurement. If this situation arises the data source of the IMD can be used as an input to the VEE rule eligibility to skip certain rules when the IMD is a reconciliation IMD since the reconciliation process add a data source of "Generated by Reconciliation" to each reconciliation IMD.

Interval Initial Measurement Data Processing

Given the consumption calculation for interval channels is done using the consumptive method the Interval IMD variants do not contain much special processing outside of the general pattern described in [Processing Initial Measurement Data](#).

Subtractive Interval Initial Measurement Data Processing

Initial measurement data for subtractive interval measuring components readings and usage for each interval in addition to Pre and Post VEE usage. Furthermore, there is a condition for both the reading and the usage which allows for more accurate recalculation of intervals. The start reading for each interval is considered to be the reading from the prior interval. For the first interval the start reading will be identified from the measurement data for the measurement immediately prior to the IMD. For example, an initial measurement for a subtractive interval measuring component might look like the following when we assume a start reading of 1490:

Date/Time	Pre VEE Reading / Condition	Pre VEE Usage / Condition	Post VEE Reading / Condition	Post VEE Usage / Condition
01/01/2010 01:00AM	1500 / Regular	10 / Regular	1500 / Regular	10 / Regular
01/01/2010 2:00AM	0 / Missing	0 / Missing	1520 / System Estimate	20 / System Estimate
01/01/2010 3:00AM	1525 / Regular	5 / System Estimate	1525 / Regular	5 / System Estimate
01/01/2010 4:00AM	1540 / Regular	15 / Regular	1540 / Regular	15 / Regular

Subtractive interval IMDs can validate for rollovers based on the configuration of the measuring component. See [Scalar Initial Measurement Data Processing](#) for more details on how rollovers are calculated.

How subtractive interval IMDs identify rollover errors is identical to scalar IMDs. However, the resolution of those errors is much different. With scalar any bypassed measurements are handled at the point of finalizing the IMD and the measurements are set to Do Not Use. With subtractive interval any bypassed measurements are added to the IMDs interval list so that they are processed along with the IMD that identified them as causing a rollover.

Subtractive interval IMDs also must initiate the reconciliation of an interval that comes directly after the IMD being processed. Unlike scalar this is not handled through a separate IMD. Rather the next measurement after the IMD being processed is added to the current IMD and the reconciliation of the usage for that measurement is computed as part of the IMD. This allows for any validation errors that are encountered in the recalculation of that measurement to be resolved along with the IMD.

NOTE: There is one scenario that does result in a reconciliation IMD being generated. When the last interval of an IMD has the reading changed during the VEE process it will require that a reconciliation IMD be generated to adjust the usage of the next measurement after the IMD (if applicable).

The subtractive interval IMDs are responsible for ensuring that the reading for each interval is in line with the usage calculated. This maintenance is performed each time the IMD is run through the VEE rules. After which the IMD will examine each interval and identify which intervals require an update to the reading or quantity.

Initial Measurement Data Valid Date Boundaries

A method to restrict the acceptable date range for IMDs is provided as part of Meter Data Management. The settings for this are controlled on the MDM Master Configuration. This provides a way to restrict either future measurements or very old measurements from being written to Meter Data Management.

Initial Measurement Data Prioritization

By default, initial measurements are created and/or received into the system in an initial state of "Pending" and are transitioned to subsequent states via the "IMD Monitor - Physical Devices" Monitor process. This Monitor process can be skipped by setting the Execution Method flag on the initial measurement to "Real Time" (D1RT), in which case an Enter algorithm transitions the initial measurement to the next state in its lifecycle immediately. This feature can be used to prioritize processing of certain types of initial measurements.

The Execution Method flag can be set in initial measurements sent from the head-end system, or can be inserted during Oracle Utilities Smart Grid Gateway Adapter processing.

Oracle Utilities Smart Grid Gateway Adapters set this flag to "Real Time" on all measurements created as the result of smart meter commands (Remote Connect, Remote Disconnect, or On-Demand Read) or completion events (including Field Activity Completion Events used with Service Order Management).

CSV Upload

Measurement data for a measuring component can be uploaded via comma separated values (CSV) files. See [Uploading Measurement Data](#) for more information.

Importing Data From External Systems

In addition to importing data from head end systems for meters and other devices, the system can also import data from other types of external systems such as weather systems or from market participants such as an independent system operator (ISO) as part of a settlement market. Data received from these types of systems is stored in standalone measuring components (see [About Measuring Components](#) for more information).

When importing data for standalone measuring components, initial measurement processing uses the **Standalone Identifier** (or **Standalone ID**) to identify the measuring component for which the measurement data belongs.

Each external system from which data is imported should be defined as an **external application**. If the data being imported uses units of measure or time of use periods that are specific to the external system, translation methods should be defined to map the specific data to standard codes.

Final Measurements

About Final Measurements

Final measurements are measurements that have been validated, and if necessary, edited & estimated, and is ready for use in downstream processing such as bill determinants calculations.

When an initial measurement is considered "final," that is, it has passed all VEE processing and no additional modifications or changes need to be made, it is transformed into a Final Measurement, or simply a Measurement (the terms measurement, final measurement, and final consumption all reference this same "final" measurement data). Only one final measurement can exist for a given date/time for a given measuring component; one final measurement exists per interval, and likewise one final measurement exists for each scalar reading. In both cases, the final measurement value stored represents the amount consumed between its date/time and the prior final measurement's date/time.

When creating final measurements from initial measurement data:

- Final measurements are created using Post VEE quantities
- Each final measurement's condition is copied from the Post VEE condition
- Initial measurements are normalized into final measurements where each final measurement is for a specific date and time.
- Because a single initial measurement may contain many "readings," a separate final measurement is created for each interval in the initial measurement. For example, if an initial measurement contains 24 hours of 15 minute readings, 96 measurements will be created, each with a specific date and time.
- A Combined Multiplier (created from multipliers defined for the measurement's measuring component type and install event) is stored for each measurement. In addition, other values are stored for measurements of specific types. The Reading Value (which often differs from the measurement value) is stored for scalar and subtractive interval measurements, and the Reading Condition is stored for subtractive interval measurements. These values are used with measurement reprocessing and other recalculation processes in the event that the original initial measurements have been archived or deleted.

The measurement date/time of a measurement represents the end of the period the measurement value covers. How the start of the period is defined varies slightly based on the type of measuring component associated to the measurement:

- **Scalar Measuring Components:** the measurement date/time represents the point at which the reading was taken. The period the measurement covers is defined as the previous measurements date/time through the measurement date/time.
- **Interval Measuring Components:** the measurement date/time represents the end of the interval period. No date/time is stored to represent the beginning of the interval period, rather it is implied by the interval size of the measuring component. For example an interval measuring component with an hourly interval size and a measurement date/time of 01/01/2010 12:00AM represents the measured quantity for the period of 12/31/2009 11:00PM through 01/01/2010 12:00AM.
- For scalar measuring components there exist special circumstances where a final measurement is not eligible for use in processing (e.g. consumption calculation, usage calculation, etc.). To prevent other processes from using these measurements they are marked with a usage flag of "Do Not Use." This is typically the result of the automatic correction of a rollover threshold error when lower quality measurements inaccurate measurements are removed to enable successful calculation of subtractive consumption.

Conditions

Conditions are used to describe the quality of a final measurement and is an important input into many of our processes. During initial measurement data processing these conditions help VEE rules identify the initial measurements that require more advanced validation or estimation. During usage calculations measurement conditions help to inform the billing system whether the billing determinants produced are based on actual data read from a meter or if it has been estimated (or in many cases a combination of the two).

Conditions follow a numeric sequencing that begins at 000000 and goes up to 999999. As the condition code rises numerically so does its perceived quality. Many areas the system take this into account:

- VEE rules use conditions to identify which initial measurement values need to be estimated or adjusted
- Rollover error automatic corrections allow higher quality data to bypass lower quality data in order to achieve a consumption calculation that does not produce an error.
- Usage calculation rules can provide information about the quality of billing determinants based on the underlying measurement data that feeds into those service quantities.

Throughout the system functionality uses condition code ranges to make decisions. In general the ranges are considered to be:

Condition Range Start	Condition Range End	Description of Range
000000	199999	No measurement
200000	299999	Missing Measurement
300000	499999	Estimated measurement
500000	999999	Regular measurement

The ranges of "No Measurement" and "Missing Measurement" at first glance sound synonymous but there is an important distinction. With conditions that fall within the "No Measurement" range the expectation is that no measurement should exist. Whereas, the "Missing Measurement" range implies that a measurement was expected but never received.

Note: in some circumstances, like rollover threshold errors, the regular range is further divided to include a "Superior" range of 9000000 - 999999 which can be used to select the appropriate reading to be used to resolve the error.

During initial measurement processing the Final Measurement Replacement VEE rule can be used to increase the perceived quality of a condition code. For example, the "No Read - Outage" condition which falls in the "No Measurement" range can be considered higher quality than "Estimated Measurements" for the purposes of measurement replacement.

Refer to [About IMD Validations](#) for more information on the Final Measurement Replacement VEE rule.

Derived Values

Final measurements can record up to 10 derived values in addition to the "as measured" value. The derivation formula for each value on a final measurement is controlled by the measuring component type.

Derived values are not reliant on consumption values, but can also come from factors, historical data, or another source. For example, a set of measurements can be adjusted or converted into other units of measure. In the below example the first derived value is the result of the application of a loss adjustment factor and the second derived value is the result of applying a pre set formula against the loss adjusted value to compute BTU.

Date/Time	As Measured UOM: CCF Sqi:	Loss Adjusted UOM: CCF Sqi:	Thermal Units UOM: BTU Sqi:
	N/A	N/A	N/A
01/01/2010 3:00PM	10	10.1	10.11
01/01/2010 4:00PM	15	15.15	15.165

Refer to [Understanding Measuring Component Types](#) in the Administration Guide for additional information about configuring derivation algorithms.

Reader Remarks

Initial measurements for manually-read scalar meters can create reader remarks. Reader remarks are a specific type of device event used to capture and/or record specific events or circumstances encountered when a meter reader is manually reading scalar meters.

Reader remark types are submitted with scalar initial measurements when received from a headend system or meter read collection system. Reader remarks are NOT uploaded along with other device events. Reader remarks are always associated with a scalar initial measurement.

Reader remarks can be passed onto to other subscribing systems such as a customer information system (such as Oracle Utilities Customer Care and Billing), an outage system (such as Oracle Utilities Network Management System), or some other application.

Like other device events, reader remarks can create service issue monitors.

NOTE: Refer to [About Service Issue Monitors](#) for more information on Service Issue Monitors.

Creating Reader Remarks Manually

Use this procedure to create a new reader remark for an existing initial measurement.

Reader remarks must always be associated with an initial measurement.

Reader remarks are most often imported into the application with an initial measurement. However, users can also create reader remarks using the following procedure.

1. Search for and select the initial measurement that the new reader remark is to be associated with.
2. Click the **Add** link on the **Reader Remarks of Initial Measurement** zone on the **Initial Measurement** portal.
3. Select the reader remark type for the reader remark from the **Reader Remark Type** drop-down list.
4. *Optional.* If you need to create more than one reader remark for the initial measurement, click the plus sign, and select the reader remark type for the reader remark from the Reader Remark Type drop-down list. Repeat as needed.
Note that only a single reader remark of any given type can be associated with a single initial measurement.
5. Click **OK**. The new reader remark is displayed in the **Reader Remarks of Initial Measurement** zone on the **Initial Measurement** portal.

Periodic Estimation

About Periodic Estimation

Periodic estimation is a process that scans eligible devices and their measuring components for missing measurements that have not been received within a required amount of time. Once missing measurements are identified it then generates estimation initial measurements to fill in those missing measurements. It is important to note that the periodic estimation itself does not actually perform any estimations. It relies on the estimation initial measurement to generate the estimate through the estimation VEE rules that are executed.

The periodic estimation process is as follows:

1. Determine if measuring component is eligible for estimation.
2. Scan the eligible period for missing measurements.
3. Confirm missing measurements do not fall within a period where the device was not installed or was disconnected.
4. Confirm there are no in progress initial measurements that cover the period of the missing measurements.
5. Either generate an initial measurement or a To Do for each measurement gap that is found.

This process relies on an important date that is maintained on each measuring component:

- **Latest Contiguous Measurement Date/Time:** this represents the last time the measuring component had a complete history of measurements without any gaps. By nature it implies that there is a gap immediately after it.

This date allows the periodic estimation process to efficiently identify those measuring components that are missing measurements and need to be estimated.

NOTE: It is possible to disable periodic estimation for a given device by updating the periodic estimation eligibility on the service point it is associated to. This is useful if there are one-off service points that should either never be eligible for estimation or should temporarily have estimation turned off.

Interval Periodic Estimation

When missing measurements have been identified by the interval periodic estimation functionality an estimation initial measurement will be created for each contiguous set of missing measurements in the estimation period.

There are two methodologies available for estimating interval measuring components:

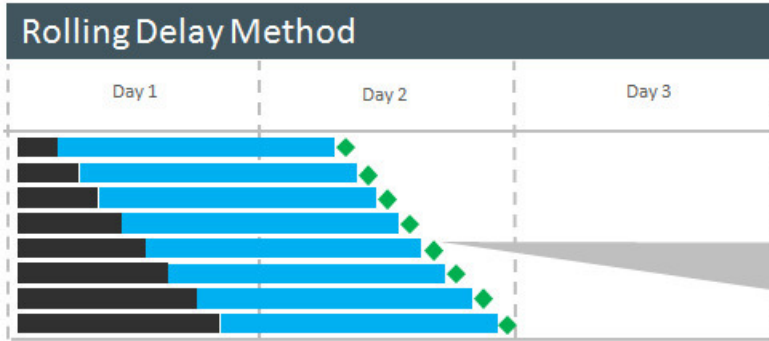
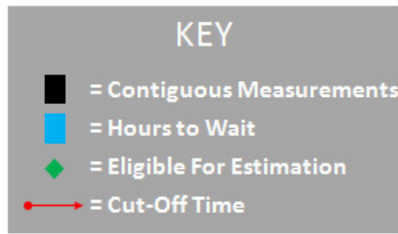

Each measuring component becomes eligible for estimation at a different time because the eligibility is calculated based on the Latest Contiguous Measurement Date/time which is unique per measuring component.

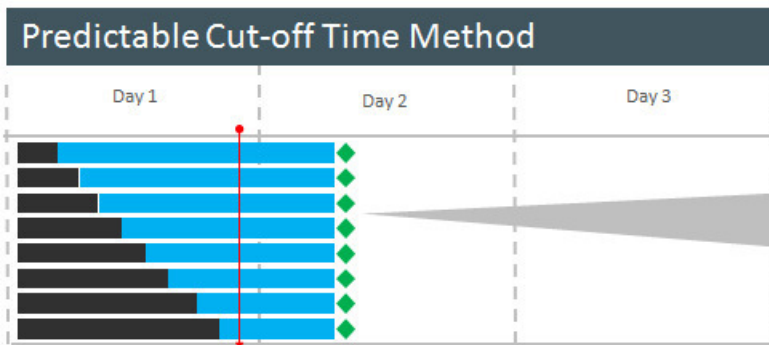

Each measuring component becomes eligible for estimation at exactly the same time because the eligibility is calculated based on the cut-off date time which is common for all measuring components for a given measuring component type.

- **Rolling Delay:** In this method the execution time of the periodic estimation process is an important factor in which measuring components will estimate how far each measuring component estimate. This method supports a minimum number of hours that will be estimated (as defined by the "Hours to Estimate" on the measuring component type).
- **Predictable Cut-off Time:** In this method all measuring components for a measuring component type will estimate until a specified point in time (as defined by the "Cut-off Time" on the measuring component type). With this method the cut-off time determines how far estimations are made rather than the execution time of the periodic estimation process. There is no minimum estimation size for this method it will always estimate up until the cut-off date/time even if that is only a single interval.

The cut-off time takes into consideration daylight savings time (DST) when the device is configured as sending data in legal time (meaning the Incoming Data Shift has been set to Always in Local). In these circumstances the cut-off time will be considered to be adjusted for DST. This is important because measurement data is stored in standard. For example:

Cut-off Time: 12:00AM	Measurement Time in Standard
01/15/2010 12:00AM (DST not in effect)	01/15/2010 12:00AM
04/15/2010 12:00AM (DST in effect)	04/14/2010 11:00PM

Furthermore, the cut-off time defined on the measuring component type does not have a time zone associated to it and as such it is considered to be defined in the time zone of the particular measuring component being processed. For example a cut-off time of 12:00AM would be considered to be 12:00AM UTC -08:00 and 12:00AM UTC -05:00 based on the time zones of the respective measuring components. This allows a single measuring component to apply to many time zones and behave uniformly.

NOTE: Additional detail on the interval periodic estimation process can be found on the D1-CIITBIH Algorithm Type.

Scalar Periodic Estimation

Scalar periodic estimation is only available for automatically read scalar measuring component since it requires that the scalar measuring component be read on at least a daily basis to be eligible.

The scalar estimation process relies heavily on details from the measuring component type to identify when a measurement is missing. This is because scalar measurements are not required to fall on specific boundaries like interval data. For example, a scalar measuring component read on a daily basis around midnight could have measurements at 12:00AM, 11:55PM, 12:01PM or even at various other points during the day if a field reading or on demand read is performed.

Auto-read scalar measuring component types are configured to provide information that will:

- Identify at what point or points during the day the measuring component will be read. This is a combination of the Hours Between Measurements and the First Daily Measurement Time on the measuring component type.
- Identify the allowable tolerance for measurements that do not fall on the specific expected measurement date/times (e.g. 11:55PM and 12:05AM are OK but 9AM is not). This is defined by the Early and Late Measurement Threshold on the measuring component type.

This allows the scalar periodic estimation process to identify the points during the day that measurements are expected and if no measurement are found it will generate an estimation initial measurement.

Unlike interval periodic estimation each missing measurement will be created as a separate estimation initial measurement.

The Early Measurement Threshold and Late Measurement Threshold fields support situations where a head-end system is not be able to report their readings at a consistent time each day. For example a head-end system might send reads as follows:

- 3/1 11:55PM
- 3/3 12:01AM
- 3/4 12:00AM
- 3/5 12:02AM
- 3/6 11:59 PM

These fields create a window prior to and after an expected reading where anything received within that window would satisfy the expected reading. For example:

- For a measuring component with an Early Measurement Threshold of 00:10:00 (10 minutes), a reading for 3/1 11:55PM would satisfy the early threshold for the 3/2 12:00AM expected reading.
- For a measuring component with an Late Measurement Threshold of 00:10:00 (10 minutes), a reading for 3/3 12:01AM would satisfy the late threshold for the 3/3 12:00AM expected reading.

To determine if a measuring component is eligible for estimation the process will evaluate if the Last Contiguous Measurement Date/Time far enough in the past. Specifically the number of hours elapsed since the Last Contiguous Measurement Date/Time must be greater than or equal to the Hours Before Estimation from the measuring component type.

NOTE: The first daily measurement time takes into consideration daylight savings time (DST) when the device is configured as sending data in legal time (meaning the Incoming Data Shift has been set to Always in Local). In these circumstances the first daily measurement time will be considered to be adjusted for DST. This is important because measurement data is stored in standard. For example:

First Daily Measurement Time: 12:00AM	Measurement Time in Standard
01/15/2010 12:00AM (DST not in effect)	01/15/2010 12:00AM

Furthermore, the first daily measurement time defined on the measuring component type does not have a time zone associated to it and as such it is considered to be defined in the time zone of the particular measuring component being processed. For example, a first daily measurement time of 12:00AM would be considered to be 12:00AM UTC -08:00 and 12:00AM UTC -05:00 based on the time zones of the respective measuring components. This allows a single measuring component to apply to many time zones and behave uniformly.

NOTE: Additional detail on the scalar periodic estimation process can be found on the D1-ARSPE Algorithm Type.

Measurement Reprocessing

About Measurement Reprocessing

One major problem utilities face today is when devices are installed with an incorrect consumption multiplier. When this occurs, the billing consumption and the bills are incorrect retroactively.

The Measurement Reprocessing module automatically corrects historical consumption when a change is detected for either a Measuring Component multiplier or Install Event installation constant. The system monitors for these changes and automatically reprocesses historical measurements if one of the values changes. When a Measuring Component has been triggered for Measurement Reprocessing, a new message will be recorded on the **Log** tab for the Measuring Component. The message will look similar to this example: "Measuring Component Multiplier updated from 1.000000 to 2.000000. Measurements will be examined for reprocessing". Also, a link to the activity created to perform the reprocessing will be shown in the Related Object column.

Two different Activities are leveraged to perform this reprocessing:

- **Measurement Reprocess Activity - Interval:** this activity reprocesses interval data by dividing existing measurements by the Combined Multiplier stored on each measurement record and creates new System IMDs.
- **Measurement Reprocess Activity - Scalar:** this activity reprocesses scalar data by creating new System IMDs from the Reading value stored on each measurement.

The new System IMDs that are generated will skip both VEE and Consumption Sync but will apply the new multiplier and installation constant. Once the activity is finished, a list of the spawned IMDs will be displayed on the Activity screen.

This process works in tandem with the Adjustment Notification process to trigger billing adjustment notifications to the CIS. If usage transactions have already been fulfilled once measurements are reprocessed, then each affected period will be sent to CIS to indicate that an adjustment is required.

If desired, an approval step can be set as required on the related Activity Type. If set, a To Do will be generated for review. The review steps for this To Do are covered in the [Reviewing Measurements for Reprocessing](#) section.

The diagram below helps to provide an overview of Measurement Reprocessing:

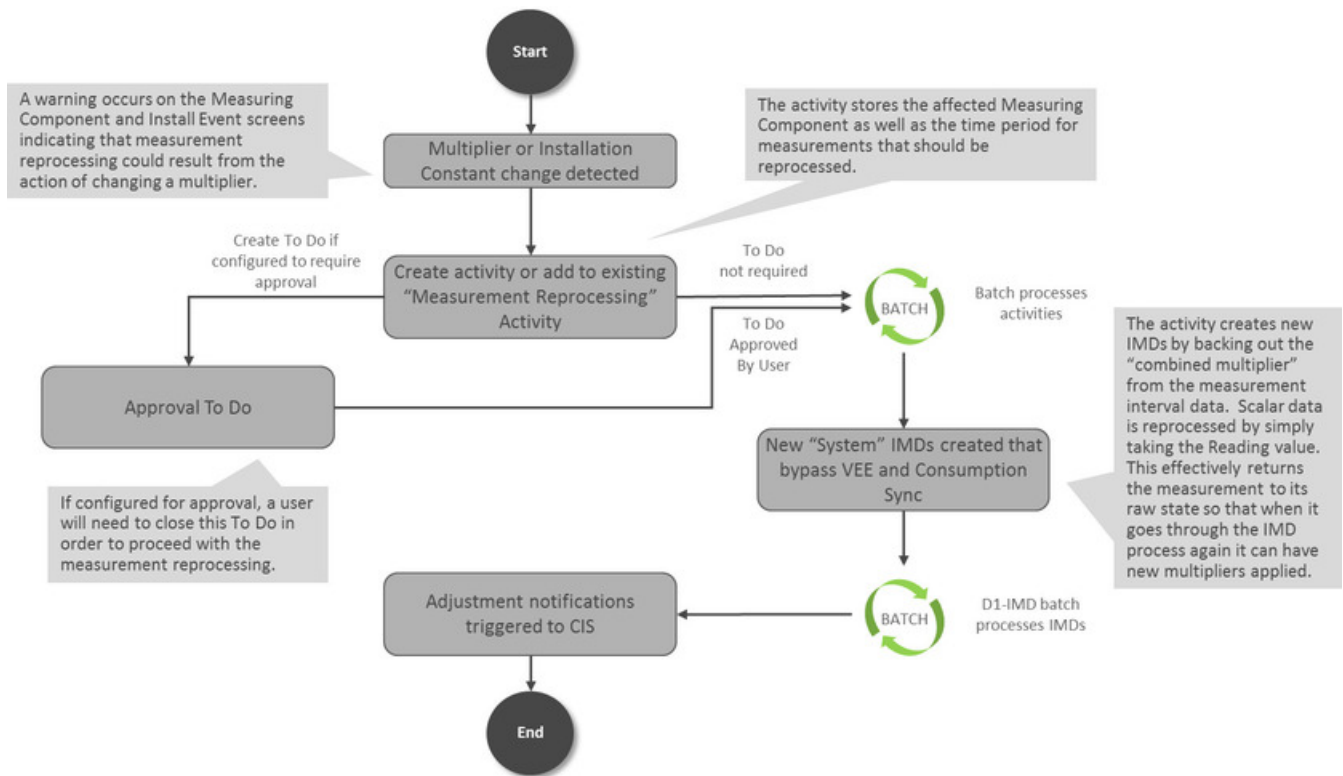

For information on configuration, reference the related section for [Configuring Measurement Reprocessing](#) in the Administration Guide.

Reviewing Measurements for Reprocessing

When the Measurement Reprocessing Activity Types are configured as "Yes" in the "Approval Required?" field, then a To Do will be generated for user review. The To Do Type for this is set on the Activity Type as well (the configuration for this is covered in detail in the section for [Configuring Measurement Reprocessing](#) in the Administration Guide).

This To Do provides an approval step for a user to examine the Measurement Reprocessing Activity and perform the following:

1. Determine if the multiplier change appears legitimate and accurate. Information on the type of change that occurred can be found on the **Log** tab for the Activity. If the change should be rejected, this can be performed using the **Discard** button.
2. Ensure that the period being examined for reprocessing (shown as the Activity Start Date and End Date) covers the period expected. If not accurate, the dates can be changed using the **Edit** button.

If all information on the Activity is correct, then press the **Approve** button to allow reprocessing to continue. Once the activity is finished, a list of the spawned IMDs will be displayed on the Activity screen.

Refer to [About Measurement Reprocessing](#) for additional functional information.

Consumption Sync

Introduction to Consumption Sync

Traditional interval and smart meters are often configured with two channels of consumption data, one interval and the other scalar. Utilities configure their meters this way for several reasons, including:

- Two channels provide for a redundant reading in case of a failure.
- Two channels provide for an independent check reading to ensure the meter is working properly.
- Customers often need both types of data for their business processes.

When capturing and storing usage for smart meters with related measuring components, one potential challenge is keeping measurements from related scalar and interval channels synchronized. Measurements for interval and scalar channels for the same device may fall out of alignment for many different reasons, such as:

1. Some meters use different technologies for recording interval and register readings, so the physical readings can be different
2. Readings can vary because of different measurement times
3. Estimation processes can vary by channel and produce different results
4. There can be a mix of actual and estimated measurements

Having two sources of consumption data can cause many problems for utilities. Unfortunately, utilities often need both the scalar and interval data to satisfy their business requirements. For example, scalar register readings may be used for billing, while the interval data is used on a customer self-service portal.

Keeping measurement data aligned between two related measuring components is achieved in several ways:

- During the initial load of initial measurement data VEE rules estimate for missing measurements using measurement data from related measuring components when available. Please refer to [About IMD Estimations](#) for more information.
- When measurement data is missing for one or both of the related measuring components the periodic estimation process will generate estimation initial measurement data that will estimate one measuring component then estimate the second measuring component such that the second measuring component's data can be synchronized with the first. Please refer to [About Periodic Estimation](#) for more information.
- When new, more accurate, measurement data is received for only one of the measuring components the consumption synchronization process will be initiated to align the previously estimated data with the newly received data. Note: this process is what this section will be concentrating on.

Consumption synchronization is a process by which measurement data for related measuring component is kept synchronized by re-estimating existing measurements when measurement data for related measuring components is received.

For example, consider the following scenario:

- A meter has both scalar and interval channels, and the scalar register channel is considered the "primary" or more reliable channel. The total consumption for each channel should match the consumption for the other channel.
- For a particular day, the daily reading for the "secondary" (interval) channel is received before reads from the scalar register have been received. This reading contains two missing intervals, which are estimated during VEE.
- After the interval reading has been finalized, a scalar register reading for the same day is received. The total of this reading is slightly different than the total of the interval reading due to the estimation of the missing intervals.
- The consumption synchronization process can trigger a re-estimation of the two estimated intervals to adjust the total of the interval reading to match that of the scalar register reading.

Other examples of situations that can be resolved using the consumption synchronization process include the following:

- Register Readings whose start/stop times do not align with interval boundaries

- A broken meter for which estimated readings are created for several days
- Requirements that readings from both channels match exactly even if neither contains estimated measurements

Primary Versus Secondary Measuring Components

When measuring components are related, one is considered the "primary" measuring component, and the other is considered the "secondary" measuring component. How the consumption synchronization process works for a given meter is based largely on which measuring component is considered primary and which is considered secondary.

The following are important principles regarding the primary/secondary measuring components:

1. The primary measuring component has the more reliable data.
2. The secondary measuring component should validate that its consumption aligns with the primary measuring component.
3. If the secondary measuring component needs to be estimated, it should estimate using the available data from the primary measuring component.
4. When possible, initial measurements for the primary measuring component should be processed prior to those for the secondary measuring component (Note: the D1-IMD batch process will process initial measurements in this order). In some scenarios when the secondary measuring component is read more frequently than the primary measuring component, it can be advantageous to violate this principle in favor of being able to execute smaller more frequent loads of measurement data.
5. Periodic estimation should be performed on the primary measuring component first, and then the secondary measuring component.

Understanding Consumption Synchronization Processing

This section provides an overview of the process that supports keeping consumption for related measuring components synchronized.

Note that the process outlined below has been simplified for illustrative purposes, and does not reference every step performed in this process.

1. An initial measurement is received (via initial load or manual) for a measuring component whose device configuration is consumption synchronization enabled.
2. The consumption synchronization process evaluates the related "consumption reference measuring component" to identify any measurements for the time period of the initial measurement are consumption sync eligible (typically estimated).

If eligible measurements are found a consumption synchronization activity is created. Note: the activity will not immediately process it will remain in an initial status until a background process is executed.

3. When the consumption sync background process is executed the activity initiates the re-estimation process by creating estimation initial measurements for each measurement that must be synchronized:
 - For scalar measuring components, this initial measurement contains no measurement value.
 - For interval measuring components, this initial measurement can contain a combination of "Regular" measurements (based on existing final measurements) and measurements that require estimation (based on and corresponding to the measurements with condition codes that fell between the range defined for "consumption synchronization" in step 2).
4. Each estimation initial measurement that was created will execute the estimation VEE group rules to recalculate the synchronization eligible measurements.

VEE

Introduction to VEE

About VEE

As measurements are received into Oracle Utilities Meter Data Management there is a need to ensure the data is accurate, fill in any missing data with estimations, and flag any failures for review by users. The VEE (Validation, Estimation, and Editing) process is the primary method for ensuring that these objectives are met.

VEE acts as a multi-layered filtration system for IMDs. Raw data is received from the Head End as Initial Measurement Data and only clean, validated data is received on the other end in the Measurement table. The IMD has both a Pre-VEE and Post-VEE section that details any data changes made as part of VEE.

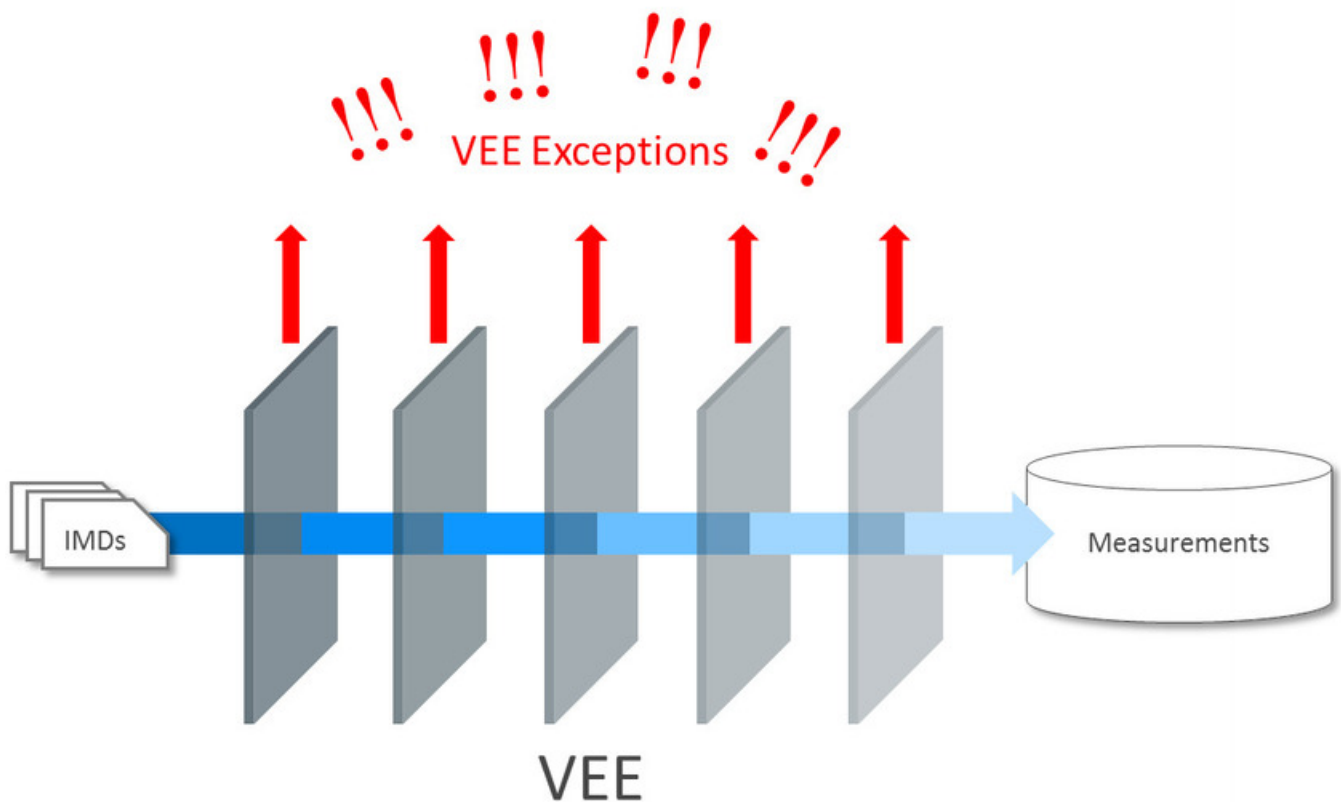

Initial measurement data can come from different sources, such as a head-end system or estimation processes, or it can be manually created by a user (to override or estimate consumption). Measurement data from these different sources might use different VEE Rules. For example:

- Initial measurements sent a head-end system might use strict VEE Rules
- Initial measurements created by a user (to override or estimate consumption) may use less strict rules
- Initial measurements created by the system to estimate consumption have very few (if any) VEE Rules

To assist with this need, you can define different VEE Groups for different sources of IMDs. The base package roles are:

- **Initial Load:** Used for initial measurement data received from a head-end system or import process
- **Manual Override:** Used for initial measurement data manually created by a user or created by the reconciliation process for scalar or subtractive interval measuring component types
- **Estimation:** Used for initial measurement data estimated by the system
- **Projection:** Used for "what if" services that are projecting future energy use for a measuring component

Refer to [About Initial Measurement Data](#) for additional functional information about the reconciliation process.

A measuring component's Measuring Component Type can define "fallback" VEE groups for each of these roles. In addition, an individual measuring component can specify a VEE group for each role. If the measuring component doesn't have a VEE group specified for a role, the "fallback" VEE group defined for the measuring component type is used.

The VEE process has a number of different objects that are detailed below that allow for configurability and flexibility in how the process executes.

VEE Groups

VEE groups are collections of VEE Rules that are applied to initial measurement data. During the VEE process, the system executes the VEE Rules defined in each VEE group. The rules within a VEE group are defined in a specific sequence, allowing control over the order in which the rules are executed.

VEE groups can be associated to a specific measuring component, or to a measuring component type (or both). VEE groups associated with a measuring component type are applied to all measuring components of that type, while those associated to a specific measuring component are applied only to that measuring component. VEE groups associated to a measuring component override those assigned to a measuring component type.

For information on configuration, reference the related section for [Configuring VEE Groups](#) in the Administration Guide.

VEE Rules

The specific validation and estimation processing performed on initial measurement data is defined in individual VEE Rules, each performing a specific set of targeted logic. The base product contains many VEE Rules you can use in your implementation, but you can also create your own custom VEE Rules.

Some VEE Rules generate VEE Exceptions if the initial measurement data fails the conditions specified for the rule. Other rules override measurements, changing measurement values as dictated by the rule's parameters. Some rules can both create exceptions and override the measurement as part of a single process. By convention, VEE Rules change the Post-VEE quantities of initial measurement data, but VEE Rules can change anything on an initial measurement.

For a list of validation VEE Rules, reference the [About IMD Validations](#) section. For a list of estimation VEE Rules, reference the [About IMD Estimations](#) section. For a list of general VEE Rules that handle decision-making within the VEE process, reference the [Decision-making VEE Rules](#) section.

For information on configuration, reference the related section for [Configuring VEE Rules](#) in the Administration Guide.

VEE Exceptions

Each VEE Rule defines an exception type and severity that specify how exceptions are tracked by the system. When an initial measurement fails a validation, an exception of the type specified for the failed VEE Rule is created. A single initial measurement can have multiple exceptions, one (or more) for each rule the measurement fails. This allows users to see all of the problems detected during the VEE process.

There are three levels of severity for VEE Exceptions:

- **Info:** Used to highlight something interesting, but not sufficient to cause the initial measurement to be put into the Exception state. Exceptions of this category can be used to report on the frequency of interesting, but not fatal issues.
- **Issue:** Used to report a problem that will prevent the initial measurement from being finalized. Multiple "issue exceptions" can be created during VEE processing. If at least one issue exists after all rules have been applied, the initial measurement is transitioned to the Exception state.

- **Terminate:** Used to report a severe issue that will cause the VEE process to stop and the initial measurement to be transitioned immediately to the Exception state. Only one terminate exception can be issued (as the first one causes VEE to stop on an initial measurement).

Note that exceptions are not deleted when an initial measurement is adjusted or corrected. After any issues are corrected or the initial measurement is overridden (or manually completed), the exceptions persist in a closed state for reporting purposes.

For information on configuration, reference the related section for [Configuring Exception Types](#) in the Administration Guide.

VEE Rule Eligibility Criteria

Each VEE Rule may optionally have eligibility criteria that controls if the rule is applied. This feature can greatly reduce the number of VEE groups you need to create, because it allows a single VEE group to have conditional VEE Rules based on eligibility criteria (rather than requiring a distinct VEE group for every combination of VEE Rules). Below are a few examples of ways you can use eligibility criteria:

- You might create a rule that compares interval consumption against related scalar consumption (such as might be the case with a device with both interval and scalar measuring components). This rule might use eligibility criteria that specifies that the rule is only applied if the initial measurement's measuring component has a corresponding scalar register measuring component.
- You might want to have a common VEE group but only have certain rules execute to execute based on Unit of Measure. An eligibility criteria can be setup so that a VEE Rule only executed for kWh whereas is skipped for kVARh.
- Another example might be a rule that compares the current consumption against standard consumption for measuring components of a certain type for the first six months after installation. You might create eligibility criteria that specifies that the rule is only applied if the measuring component's Device Configuration has been installed at a Service Point for less than six months.

For information on configuration, reference the related section for [Configuring VEE Rules](#) in the Administration Guide.

Decision-Making VEE Rules

In addition to the VEE Rule Eligibility Criteria, there are VEE Rules delivered as part of the base product that help with decision-making when executing VEE (listed below). For more information on how each rule executes and can be configured, follow the link provided on the rule.

VEE Rule Name	Purpose
Exception Handler	This rule allows for termination of the VEE process based on a configurable set of exceptions being present for the IMD. This rule also allows a unique To Do Type to be generated based on a group of exceptions.
Execute VEE Group	This rule performs a call to execute a separate VEE Group which includes execution of all VEE Rules within that group.
Successful Termination	This rule allows VEE to be successfully terminated based on a list of exceptions.
VEE Group Matrix (Factor)	This rule provides a way to choose different instances of a VEE Rule using a Factor. This factor leverages characteristics that are defined on Service Point, Device, or Measuring Component.

Validations

About IMD Validations

Validation of the Initial Measurement Data on the way in to Oracle Utilities Meter Data Management occurs by leveraging the diverse library of VEE Rules. Below is a list of the validation VEE Rules that are provided as part of base product. For more information on how each rule executes and can be configured, follow the link provided on the rule.

VEE Rule Name	Applicable Data Type(s)	Purpose
Consecutive Interval Check	Interval	This validation rule flags any combination of consecutive intervals within Initial Measurement Data based on the values of the data or the condition codes of the data.
Duplicate IMD Check	Interval or Scalar	This rule allows for a duplicate IMD to be flagged.
Dynamic Comparison Validation	Interval or Scalar	This powerful, flexible validation rule compares measurements to historical statistics for the related Service Point. The system will maintain statistics such as the following: sum, min, max, average, median, zero value count, outage count, and standard deviation. Then you define formulas (no programming required) for the comparison of current measurements to these statistics.
Ensure IMD Exists for Sibling MCs	Interval or Scalar	This rule validates that an IMD exists for all of the other measuring components associated to the same Device Configuration as the current measuring component, for the same period of time.
Final Measurement Replacement	Interval or Scalar	This validation rule allows you to define a variety of configuration options to decide if new data should replace existing measurements. The options include value change thresholds, percentage change thresholds, as well as condition code ranking.
High/Low Check	Interval or Scalar	This validation rule compares the total consumption of the current IMD to historical values. The comparison is normalized based on average daily usage (ADU). If the current IMD is too high or too low compared to historical data then an exception is thrown.
Inactive Measurement Check	Interval or Scalar	This validation rule flags any Initial Measurement Data received on a device that is either disconnected, uninstalled, and/or not connected to a Usage Subscription.
Interval Size Validation	Interval	This rule validates that the interval size (in seconds) supplied with the Initial Measurement is equal to the interval size defined on measuring component's type.
Interval Spike Check	Interval	This rule checks for spikes within an IMD and generates an exception if one is found.
Multiplier Check	Interval or Scalar	This rule validates that the register multiplier supplied with the IMD is equal to the multiplier stored on the measuring component. If not, an exception is created using the register multiplier exception type and severity configured on the rule.
Negative Consumption Check	Interval or Scalar	This rule flags any IMD where the total consumption is negative.
Prolonged Estimation Check	Interval or Scalar	This validation rule creates an alert when a device has been estimated for an extended period of time.
Raise Missing Quantity Exception	Interval	This rule flags any missing interval data.

Sum Check	Interval or Scalar	This rule is used to compare the difference between interval data to scalar data for a period of time, or between a set of TOU scalar reads to a "Sum" scalar reading.
Unit of Measure Check	Interval or Scalar	This rule checks the unit of measure (UOM) passed in with the Initial Measurement against the primary unit of measure configured on the measuring component's type.
Zero Consumption Check	Interval or Scalar	This rule checks if the total consumption for the IMD is zero. There is also a check for whether an outage occurred during the same time as the zero consumption to provide ways to avoid exceptions in that case.

Refer to [About VEE](#) for additional functional information.

Reviewing and Resolving VEE Exceptions

All To Dos generated by a VEE Exception will link back to the Initial Measurement Data that originally failed to create the VEE Exception.

Users have a number of options for dealing with initial measurements with exceptions.

- After correcting the cause of the issues that triggered the exceptions, a user can reinitiate the VEE process for the IMD using the **Perform VEE** button.
- A user can **Discard** the initial measurement.
- A user can use the **Force Complete** button on the IMD in the scenario that they want to approve the exception and the measurement information in the IMD. *Note:* No VEE processing is performed on initial measurement data that is force completed. Regardless of the action taken by the user, the system will complete any open To Do Entries that created when the initial measurement entered the Exception state.

Refer to [About VEE](#) for additional functional information.

Usage Transaction Validations

There are also validations available during the execution of usage calculation. For more information on these reference the [Reviewing and Resolving Usage Transactions](#) section.

Estimations

About IMD Estimations

Below is a list of the estimation VEE Rules provided as part of base product that are responsible for filling the missing data within an IMD. For more information on how each rule executes and can be configured, follow the link provided on the rule.

VEE Rule Name	Applicable Data Type(s)	Purpose
Interval Adjustment From Scalar	Interval	This rule performs adjustments to interval values based on the values from the associated scalar data on the same device.
Interval Averaging Estimation	Interval	This rule finds historical interval data from the same measuring component based on a variety of configuration options to use for estimating any missing data within an IMD.

Interval Create Estimation IMD for Gap	Interval	This estimation rule creates a new Estimation IMD to fill gaps between the interval data received from the Head End. Note: <i>this estimation rule acts differently from the other rules as it creates a new IMD rather than filling in missing values in an estimation IMD created from periodic estimations.</i>
Interval Interpolation Estimation	Interval	This rule attempts to interpolate gaps within an IMD using prior and subsequent intervals as starting points for linear interpolation.
Interval Profile Estimation	Interval	This rule estimates any missing interval data for the IMD based on a referenced Profile Factor.
Interval Proxy Day Estimation	Interval	This rule checks for days with similar temperature and uses the measurement data from those days as the basis of interval estimation for the in-flight initial measurement.
Scalar Calculation From Interval	Scalar	This rule performs adjustments to scalar values based on the values from the associated interval data on the same device.
Scalar Estimation	Scalar	This rule finds historical scalar data from the same measuring component based on a variety of configuration options to use for estimating any missing data within an IMD.
Scalar Profile Estimation	Scalar	This rule will estimate any missing scalar data for the IMD based on a referenced Profile Factor.
Scalar Proration	Scalar	This rule prorates the value of a scalar reading that has two valid scalar readings on either side as boundaries. It will also take into account any related interval data within the same period to exclude from the calculation.
Subtractive Interval Adjustment Rule	Subtractive Interval	This rule performs adjustments to qualifying interval consumption values for subtractive interval measuring components based on an adjustment target calculated using a start and stop reading for the period that encapsulates the intervals to adjust.

Refer to [About VEE](#) for additional functional information.

Usage Transaction Estimations

There are also estimations available at the time of usage calculation. For more information on these reference the [Reviewing and Resolving Usage Transactions](#) section.

Editing

About IMD Editing

At times, the values received in as Initial Measurement Data need to be edited by a user. This is covered in the [Editing Initial Measurements](#) section.

If measurement data is found to be incorrect, a new IMD must be generated to correct the data. This is covered in the [Generating new Initial Measurements](#) section.

Refer to [About VEE](#) for additional functional information.

Editing Initial Measurements

Initial measurements can be manually edited via functions available in the Interval Initial Measurement Lens or Scalar Initial Measurement zones in the Initial Measurement portal. Manual edits can include changes to the measurement values or condition codes.

By default, manual edits made by users of these zones are not logged on the Log tab.

Refer to [Configuring Measurement Logging](#) for additional information on how initial measurement changes can be logged.

Generating New Initial Measurements

The main location for viewing measurements and generating new IMDs for any discrepancies is through the [360 Degree View Measuring Component portal](#). On the portal many of the zones provide ways to [apply measurement functions](#) that will generate a new IMD.

Usage

Introduction to Usage Calculation

About Usage Calculation

Oracle Utilities Meter Data Management can calculate and publish usage calculated from measurement data to service providers on an ongoing basis. In addition, external systems can request usage whenever needed. Usage calculations derive a usage transaction's usage quantities using the measurements linked to a usage subscription's service points.

Before bill determinants can be calculated, you must first create a [Usage Subscription](#). The usage subscription defines the external system to which the data should be sent as well as the usage calculation group that will be used for calculation. The usage calculation rules defined for the usage calculation group are responsible for performing the specific calculations, validations, or estimations for bill determinants.

Usage Service Quantities (bill determinants) are derived from the Measurements of the measuring components installed at the Usage Subscription's Service Points during the calculation period. A Service Point is linked to measuring components through an Install Event linked to the measuring components' Device Configuration.

The results of all calculations performed by Usage Subscriptions are stored as a [Usage Transaction](#).

At any instance in time:

- A Usage Subscriptions may be linked to multiple Service Points
- A Service Point may be linked to a single Device Configuration
- A Device Configuration may have multiple measuring components

The calculation period for bill determinant calculations can span many days and over this period:

- The Service Points linked to the Usage Subscription can change (Service Points can be added and removed)
- The Device Configurations installed at the Service Point can change (due to device reconfigurations and meter exchanges)

This means that values for each Usage Subscription can be calculated using multiple Service Points and measuring components.

The Usage Calculation process has a number of different objects that are detailed below that allow for configurability and flexibility in how the process executes.

Usage Calculation Groups

Usage Calculation Groups are collections of usage calculation rules that are used to either calculate bill determinants or validate bill determinants. During the Usage Transaction process, the system executes the usage calculation rules defined in the usage calculation group referenced on the usage subscription. The rules within a usage calculation group are defined in a specific sequence, allowing control over the order in which the rules are executed.

For information on configuration, reference the related section for [Configuring Usage Calculation Groups](#) in the Administrative User Guide.

Usage Calculation Rules

The specific calculation, validation, or estimation processing performed on a Usage Transaction is defined in individual usage calculation rules, each performing a specific set of targeted logic. The base product contains many usage calculation rules you can use in your implementation, but you can also create your own custom usage calculation rules.

For a list of validation usage calculation rules, reference the [About Usage Validations](#) section. For a list of estimation usage calculation rules, reference the [About Usage Estimations](#) section. For a list of all other usage calculation rules that handle calculation of bill determinants, reference the [Inventory of Other Usage Calculation Rules](#) section.

For information on configuration, reference the related section for [Configuring Usage Calculation Rules](#) in the Administration Guide.

Usage Transaction Exceptions

Each usage calculation rule defines an exception type and severity that specify how exceptions are tracked by the system. When a Usage Transaction fails some part of a usage calculation rule, an exception of the type specified for the failed usage calculation rule is created. A single Usage Transaction can have multiple exceptions, one (or more) for each rule that failed. This allows users to see all of the problems detected during the Usage Calculation process.

There are three levels of severity for Usage Transaction Exceptions:

- **Information:** Used to highlight minor issues, but not sufficient to cause the Usage Transaction to be put into a failure state. Exceptions of this category can be used to report on the frequency of interesting, but not fatal issues
- **Issues:** Used to report a problem that will prevent the usage transaction from being sent. Multiple "issue exceptions" can be created during usage transaction processing. If at least one issue exists after all rules have been applied, the usage transaction is transitioned to a failure state requiring review and approval.
- **Terminate:** Used to report a severe issue that will cause the Usage Calculation process to stop and the Usage Transaction to be transitioned immediately to a failure state requiring review and approval. Only one terminate exception can be issued (as the first one causes calculation processing to stop on for a Usage Transaction). This should be used for cases where manual override / approval isn't accurate. For example, a "Curve Not Continuous" error that says the interval data doesn't cover the full usage period should always be set to Terminate as an Exception Severity.

Note that exceptions are not deleted when a Usage Transaction is adjusted or corrected. After any issues are corrected or the Usage Transaction is overridden (or manually completed), the exceptions persist in a closed state for reporting purposes.

In addition to exceptions, usage processing can also trigger the creation of To Do Entries related to failed validations. If Issue or terminate exceptions exist for an initial measurement, a To Do Entry is created when the usage transaction is transitioned to the Exception state. The To Do Type and default To Do Role of this To Do Entry are defined on the Enter system event for the Exception state of the business object used to define the usage transaction.

To Do Entries created in this way can be routed to different roles depending on the exception's message category and number (using the To Do Type's Message Overrides tab).

For information on configuration, reference the related section for [Configuring Usage Transaction Exception Types](#) in the Administration Guide.

Usage Calculation Rule Eligibility Criteria

Usage calculation rule eligibility criteria are user-definable conditions that could cause a given usage calculation rule to be applied or skipped. This can involve the evaluation of some attribute of the usage subscription or service point, or something else entirely. A usage calculation rule can have multiple eligibility criteria for determining if the rule should be applied or skipped, based on a user-defined sequence.

For information on configuration, reference the related section for [Configuring Usage Calculation Rules](#) in the Administration Guide.

Usage Subscriptions

About Usage Subscriptions

A usage subscription is an ongoing request to send one or more service points' usage to one or more external systems. The usage subscription defines which usage calculation group should be used to calculate service quantities (often referred to as bill determinants).

Usage subscriptions must reference a:

- **Service Provider.** The service provider is used as the identity of the subscribing system. In other words, you must set up a service provider for any system that subscribes to bill determinants.
- **Contact:** Contacts are individuals or business entities with which a company has contact. A contact exists for every individual or business related to a usage subscription. A single usage subscription can have many contacts, and a single contact may be referenced on many different usage subscriptions. Contacts have a 1-to-1 correlation with a "person" in a customer information system (CIS) and the CIS is considered the system of record for contact information.

NOTE: Usage Subscriptions can be created from Customer Care and Billing Service Agreements via [Customer To Meter Master Data Synchronization](#).

Maintaining Usage Subscriptions

This portal is used to display and maintain a usage subscription.

Refer to [About Usage Subscriptions](#) or [About Usage Calculation](#) for additional functional information.

You can access the portal from **Menu > Usage > Usage Subscription**. You are brought to a query portal with options for searching. Once your record has been selected you are brought to the maintenance portal to view and maintain the selected record.

The following zones may appear as part of the portal's **Main** tab page:

- **Usage Subscription:** Defines basic information about the usage subscription, including factor overrides, usage groups, and service points.
- **Usage Subscription Market Participants:** Lists market participants associated with the usage subscription (via Usage Subscription Market Participants)
- **Sub Usage Subscriptions:** Lists the first fifty "sub" usage subscriptions for the master usage subscription displayed in the Usage Subscription zone. This zone is only displayed for "master" usage subscriptions.

NOTE: Usage Subscriptions can be created from Customer Care and Billing Service Agreements via [Customer To Meter Master Data Synchronization](#). Usage subscriptions created from service agreements should not be modified using this portal.

Usage Subscription Market Participants

About Usage Subscription Market Participants

Usage subscription market participants connects a Market, Market Participant and Usage Subscription together over a specified date range. Usage subscription market participants can be created either via the **Usage Subscription Market Participant** portal, or by adding a market participant to a usage subscription via the **Usage Subscription** portal.

Usage subscription market participants are defined by the following:

- **Usage Subscription:** The usage subscription for which this usage subscription market participant was created.
- **Market Relationship Type:** The market relationship (Distributor, Supplier, etc.) of the market participant and its role within a market.
- **Start Date/Time:** The start date/time for when the record is applicable.
- **End Date/Time:** The end date/time for when the record is applicable.
- **Market Participant:** The market participant associated with the **Usage Subscription**, including an optional ID used by the market participant to uniquely identify the account (usage subscription).

Maintaining Usage Subscription Market Participants

You use the **Usage Subscription Market Participant** portal is used to display and maintain usage subscription market participants.

Refer to [About Usage Subscription Market Participants](#) for additional functional information.

You can access the portal from the **Main > Usage > Usage Subscription Market Participant**. You are brought to a query portal with options for searching. Once your record has been selected you are brought to the maintenance portal to view and maintain the selected record.

The following zones may appear as part of the portal's **Main** tab page:

- **Usage Subscription Market Participant:** This zone displays the basic attributes of the usage subscription market participant
- **Sub Usage Subscriptions:** lists sub usage subscriptions for the usage subscription market participant's usage subscription

Usage Transactions

About Usage Transactions

Usage Transactions are records of bill determinant calculations for a Usage Subscription. All of the Service Quantities calculated are stored as part of the Usage Transaction.

Most requests for usage result in the creation of a usage transaction, but it is possible for an external application to invoke the usage calculation engine real-time. In other words, usage can be retrieved for a usage subscription real-time without creating a usage transaction. This technique is only recommended for online requests, not as part of batch processes.

Usage Calculation Group Determination

The first step in calculating the usage is to determine the usage calculation group holding the rules set used in calculating or validating the bill determinants. There are two ways of configuring the usage calculation group to use in the processing. It may be specified on the usage subscription during its creation with an effective and expiration date. If there are no usage calculation groups in effect for the usage transaction, the fallback usage calculation group specified in the usage subscription type will be used. The other way is to specify an algorithm – Determine Usage Calculation Group Override, on the usage subscription type. This option provides flexibility in cases where special or custom logic will be required to identify the usage calculation group. Base product delivered an algorithm that identifies the usage calculation group based on the rate and installed device. Additional details can be found in the Detailed Description of the D2-DRVUSGGRP Algorithm Type.

Calculation Period

Usage transaction requests must specify the date range for the usage transaction. This date range is referred to as the calculation period for the usage transaction. The dates that define the calculation period are specified by a subscribing system when it requests a usage transaction.

Multiple Device Configurations and the Calculation Period

In situations where a meter exchange has taken place at a service point, more than one device configuration can be in effect during the usage transactions cutoff period (the time period between the **End Date/Time From** and **End Date/Time To** values).

To account for this, the **Meter Exchange Option** on the [Usage Subscription Type](#) can be used to specify how the usage calculation should handle multiple device configurations in effect during the cutoff period. If the flag is set to 'Defer Calculation', new device configurations are excluded in the current usage transaction. If the flag is blank or set to 'Calculate Usage', new device configurations are included in the current usage transaction.

Date Breaks

As noted above, date breaks are used to break up a usage period into sub-periods based on the dates on which rate changes took place for the service point. For example, suppose a subscribing system requests usage for the month of January. The customer for this request has an interval meter, and the customer's usage is calculated by applying a TOU map to their interval consumption. The subscribing system detects that the customer's rate changed in the middle of January (on January 16) and wants the TOU consumption calculated in two "chunks" (before and after the rate change). Because the customer has an interval meter, the exact consumption amounts before and after the rate change can be precisely calculated (as opposed to calculating each period's amount by dividing the total usage by the number of days in each period).

One approach to this situation would be for the subscribing system to request two usage transactions (where each has the desired date range). Another approach is for the subscribing system to request a single usage transaction with date breaks that define the date ranges before and after the rate change. To continue the above example, a usage transaction could be created with a date break on January 16.

If a usage transaction has date break(s), the usage calculation engine segregates the usage into multiple usage periods based on the date breaks. If there are no date breaks in the usage transaction, a single usage period is created for the entire calculation period.

As of the v2.0.0 release, the only way a usage transaction can have date breaks is if the subscribing system supplies these when it requests usage (only the subscribing system knows if and when its prices and pricing rules change during the billing period). If an implementation has additional criteria that causes date breaks, these criteria can be easily added to the usage transaction's business rules.

Service Quantities

Every usage period created for a usage transaction contains one or more service quantities. Service quantities are calculated by the usage calculation group's rules specified for the usage subscription from which the usage transaction is created. For example, a usage transaction might have service quantities calculated by a single rule that applies a TOU map to the kWh channel on the device configuration installed at the service point.

Each service quantity lists details about that quantity, including a UOM (or TOU or SQI as appropriate) and a quantity. In addition, each service quantity also references the source (measuring component) of the quantities (for audit purposes).

Service Quantity Rounding

The manner in which service quantities are rounded can be defined using the **SQ Rounding Details** parameters. These parameters allow configuration of the method by which quantities are rounded (Up, Down, or Nearest) and the number of decimal positions retained after rounding.

Quality Assessment for Bill Print Options

Usage transaction service quantities can also contain information about the quality of the measurements used in their calculations and other information that can be sent to an external customer information or bill print system. This information is included in both the usage transaction and its related outbound message.

Quality Assessment

The [Get Interval Data](#), [Get Scalar Details](#), and [Get Time of Use Mapped Usage](#) usage calculation rules include a "Perform Measurement Quality Assessment" option that indicates (yes or no) if the measurement conditions of the measurements used when calculating usage should be evaluated and included in the resulting usage transaction and outbound message. When enabled (set to "Yes"), the usage calculation rule algorithm evaluates the condition codes of the measurements used in the calculation to determine if they fall within a "Regular" range of conditions (this range is defined by the "Bottom Regular Condition Range" and "Top Regular Condition Range" algorithm parameters). The result of this assessment is displayed in the "Data Quality Assessment" column in the Usage Periods section which indicates if the service quantity is based on "regular" or "non-regular" data. (If the "Perform Measurement Quality Assessment" option is disabled, the "Data Quality Assessment" column displays "No Assessment Done"). In addition, the "Source Measurement Quality List" column contains XML that contains a list of measurements aggregated by condition/quality.

Maximum/Minimum Dates and Times

The [Get Interval Data](#), [Get Time of Use Mapped Usage](#), and [Vector and Service Quantity Math](#) usage calculation rules can be configured to identify the date/time of the maximum or minimum measurement value used when calculating the service quantity. For these functions, if "Max" or "Min" is selected as the "Calculation Function" (or the "Comax" and "Comin" functions for the "Vector and Service Quantity Math" rule), the date/time of the maximum/minimum value will be included in the resulting usage transaction and outbound message. The "SQ Highlight Date/Time List" column contains XML that contains a list of maximum/minimum date/times, based on condition/quality.

Usage Transaction Export Configuration

Usage transactions can also include additional information about its related meters and service points, as well as an indication if the service quantity is based on estimated usage. The "Usage Transaction Export Configuration" master configuration is used to control the export of this data. It holds the device and service point business objects used to supply meter and service point information included in the usage transaction and outbound message.

The "Usage Transaction Export Configuration" master configuration also defines the threshold percentage above which a service quantity being exported via the usage transaction outbound message is marked as an estimate. For example, if the "Estimation Threshold Percentage" is set to 35%, any service quantity being exported that was calculated from measurements containing more than 35% estimated usage is marked "estimated".

Service Quantities for Scalar Usage

Usage transactions and service quantities for scalar usage differ in some ways from those created from interval usage. For example, suppose a subscribing system requests usage for the month of January for a customer with a scalar meter that has been exchanged mid-month. In this case, the customer's usage is calculated by finding the scalar readings in the requested period (including all meter exchanges), and the subscribing system requires a record of all scalar readings AND a total of their consumption

Scalar rules cannot use date breaks because the system doesn't store interval values so it cannot accurately compute the amount in each period. In this case, scalar usage calculation rules retrieve scalar readings for the service points linked to the usage subscription, and then creates a single usage period for the usage transaction's entire calculation period. The individual scalar readings are captured as "scalar details" in the usage transaction.

To continue the example above, there would be 2 entries in the Scalar Details, one for each meter, and a single usage period that contains the total consumption for the entire calculation period. The tables below illustrate what this might look like.

Usage Estimation

When calculating usage for monthly read scalar meter, the end read may not be available by the end of the bill cycle window. If the request indicated that estimated measurement is allowed, the Get Scalar Details usage calculation rule creates an estimated end read that will be used to calculate the scalar usage.

Calculating Usage for Items

Usage transactions can also calculate usage for items installed at service points. Usage for items is calculated through use of [Get Item Counts and Consumption](#) usage calculation rule. This rules calculate usage based on the number of items installed at each service point and the average daily service quantity defined for each item's type. The specifics of how usage is calculated for items is based on the service point category (defined on the service point type) at which the items are installed (item or multi-item).

Hypothetical Calculations - Rate Comparisons

When Oracle Utilities Meter Data Management is integrated with Oracle Utilities Customer Self Service, customers can perform rate comparison calculations to see the impact to their usage and billing charges based on a set of user-defined usage adjustments. Rate comparison usage transactions are flagged "Hypothetical Calculation" in the **Calculation Mode** field.

Profile Accumulation Usage Calculation Rules and Usage Adjustment Profile Factors

Rate comparison usage transactions can be created through the use of [Profile Accumulation](#) usage calculation rule. This rule combine a service point's measurements with "usage adjustment" measurements derived from measurement data for profile measuring components defined as characteristic values for one or more profile factors.

Usage adjustment profile factors are associated to usage adjustment types defined in the Usage Adjustment Type extendable lookup and rates defined in the CC&B Rate Schedule extendable lookup (this association is defined in the Self-Service Master Configuration). When the usage transaction is created, the rate determines the usage calculation group to execute and usage adjustment profile factors to include in the calculation based on the CC&B Rate Schedule extendable lookup.

Note: The [Profile Accumulation](#) usage calculation rule should be configured with eligibility criteria such that they are only executed when the Calculation Mode for the usage transaction is set to "Hypothetical Calculation" (D2HC).

Including Summary Service Quantities and Interval Data Snapshots with Usage Transactions

Usage transactions can be configured to include summary service quantities and an interval data "snapshot" along with service quantities and other information sent to external systems. This used when sending usage to a billing system that performs interval-based pricing calculations.

Only usage transactions created (in whole or in part) by either the [Get Interval Data](#) or [Vector and Service Quantity Math](#) usage calculation rules can include interval data snapshot information. These rules use the **Extract Interval Data** flag to indicate ("Yes" or "No") if a "snapshot" of the interval data resulting from the usage calculation rule should be sent to external systems when usage from the usage transaction is sent to external systems.

In the base package, the Usage Transaction Outbound Message (D2-UsageTranOutboundMsg) business object is used to create outbound messages containing usage transactions. This business object includes the "Build Summary SQs" (D2-BLDSUMSQ) Pre-Processing algorithm which calculates and creates the interval data snapshot and other summary service quantities.

How Summary Service Quantities and the Interval Data Snapshot is Calculated

As noted above, the "Build Summary SQs" (D2-BLDSUMSQ) algorithm builds the Summary Usage Periods List based on the usage transaction's details. For every usage period within the usage transaction:

An entry is inserted into the summary service quantity list for every distinct UOM/TOU/ SQI combination in the usage period service quantity list.

An entry is inserted into the service point service quantity list for every distinct service point ID/UOM/TOU/SQI combination in the usage period service quantity list.

Interval data for multiple service quantities are combined into a single interval data curve per UOM/TOU/SQI combination. Intervals are summarized and scaled based on a common SPI

The "Build Summary SQs" (D2-BLDSUMSQ) algorithm uses the "Target Interval Size" parameter to define the interval size of the combined curve when one or more curves are combined with different interval sizes. For example, when combining interval data with 15 minutes intervals (SPI 900) and data with 60 minute intervals (SPI 3600), a Target Interval Size of 60 minutes (SPI of 3600) would result in combined data with an interval size of 3600 (the 15 minute intervals would be scaled up to 60 minute intervals before being combined with the 60 minute interval data).

Refer to [About Usage Calculation](#) for a broader functional view of the overall process. For information on how to configure the request and response process for Usage Transactions, reference the [Integrating Usage Transactions](#) section of the Admin Guide.

About Usage Validations

For the sake of keeping the volume of To Dos to a manageable level it may make sense to shift certain validations to the usage transaction process rather than the IMD load process. The validation should be done on a usage transaction when the result is only crucial for the systems receiving usage transactions rather than more real time needs such as online presentation to a customer. Below is a list of the usage calculation rules used for validating usage transactions that are provided as part of base product. To get more information on how each rule executes and can be configured, follow the link provided on the rule.

Usage Calculation Rule Name	Applicable Data Type(s)	Purpose
Usage High/Low Rule	Interval or Scalar	This validation rule compares the Service Quantities of the Usage Transaction to historical values. If the current value is too high or too low compared to historical data then an exception is thrown.
Validate Against Tolerance	Interval or Scalar	This usage calculation rule is used to validate the calculated usage against a tolerance value. The tolerance value may either come from the specified value or tolerance factor defined in the usage calculation rule.
Business Flag Hold	Interval or Scalar	This usage calculation rule can stop a usage transaction from proceeding when there have been business flags for the applicable service points. The hold can either be indefinite or set to expire a configurable amount of time prior to the calculation window ending.

Refer to [About Usage Transactions](#) or [About Usage Calculation](#) for additional functional information.

Reviewing and Resolving Usage Transactions

This portal is used to review and/or resolve a Usage Transaction.

Refer to [About Usage Transactions](#) or [About Usage Calculation](#) for additional functional information.

You can access the portal from the **Main > Usage > Usage Transaction**. You are brought to a query portal with options for searching. Once your record has been selected you are brought to the maintenance portal to view and maintain the selected record.

The following zones may appear as part of the portal's **Main** tab page:

- **Usage Transaction:** Defines basic information about the usage transaction, including usage period date ranges, date breaks within the usage period, scalar usage details, and usage quantity details.
- **Service Quantity Overlay:** Displays interval data for each service quantity for the usage transaction's usage period
- **Time of Use By Day:** Displays TOU-mapped interval data by day for the usage transaction's usage period

A number of important actions are available for a Usage Transaction depending on its status:

Action	Allowed Statuses	Details
Approve	Approval In Progress Issue Detected (only when the exceptions are marked to require approval)	Allows a user to bypass any exception or failure message for the Usage Transaction and attempt to send it to the requesting system.
Re-Calculate	Approval In Progress Issue Detected	Reruns the entire process of calculation along with any validations (all usage calculation rules) for the Usage Transaction.
Subsequent Correction	Sent	Allows a user to indicate that the usage transaction was corrected after being sent. Sets the status of the usage transaction to Subsequent Correction.
Resend	Send Error	Allows a user to re-send a usage transaction (via its related outbound message) to an external system. Used when an error occurs when sending usage transactions.

Triggering Adjustment Notifications

If any new Measurements are received from a device after that period has been calculated in a Usage Transaction then a discrepancy exists between Oracle Utilities Meter Data Management and the external system (often a customer information system or CIS). As a result, Oracle Utilities Meter Data Management provides a method to notify external systems of these adjustments to Usage Transactions. A **Usage Transaction Correction Processor** activity is created for each usage transaction that may have been impacted by an initial measurement. The **Usage Transaction Correction Monitor** batch (D1-UTCRN) is used to process these activities.

On the [External Application](#) for CIS, a processing method of "Usage Trans Subsequent Correction Notification" must be configured to specify the message that should be sent to notify CIS when an adjustment occurs for a Usage Transaction in Oracle Utilities Meter Data Management.

The IMD process handles the logic to look for existing Usage Transactions to determine if an adjustment will be required. The Usage Transaction will be moved to a "Subsequent Correction" status once this adjustment occurs.

Inventory of Other Usage Calculation Rules

Beyond validations and estimations usage calculation rules, the Usage Transaction process involves many other important rules that prepare and calculate Service Quantities. A list of these rules is provided below. For additional detail, follow the provided link that will take you to the Configuration Guide.

Pre-Calculation Usage Calculation Rules

Below is a list of the pre-calculation usage calculation rules provides as part of base product. For more information on how each rule executes and can be configured, follow the link provided on the rule.

Usage Calculation Rule Name	Applicable Data Type(s)	Purpose
Alignment and Delay Calculation Rule	Interval or Scalar (Frequently Read)	This rule can be used to handle two main needs: 1) aligns all measuring components for a Usage Subscription to the same date (whether on the same device or separate devices) 2) delays the usage transaction until the end of the retry window based on the quality of available data and other configured parameters
Check Existence of Installed Device	Interval or Scalar	This rule checks for the existence of a device installed on the Usage Subscription's Service Point for the usage period. In the case of multi-items this rule also checks that they are effective for the usage period.

Calculation Usage Calculation Rules

The following is a list of the calculation usage calculation rules provided as part of the base product. For more information on how each rule executes and can be configured, follow the link provided on the rule.

Usage Calculation Rule Name	Applicable Data Type(s)	Purpose
Apply Math (Interval Data)	Interval	This rule is used to perform calculations on interval data and stores the results in the usage transaction's service quantities. A variety of options are available on this rule that include defining the calculation type, variables to use, as well as the equation to use (math functions and expressions). This rule provides aggregated usage for all selected interval measuring components (filter by TOU, SQI & UOM) associated to a usage subscription. This rule can also multiply total usage by a factor using a custom formula.
Daily Scalar Usage Calculation Rule	Scalar	This rule is used to calculate usage of daily scalar measuring components installed in

the Service Points associated with a Usage Subscription for the specified usage period. It creates bill determinants by taking the difference between the beginning and ending reading for the bill period.

This rule can also be used to provide register readings by measuring component.

For consumption values, only the beginning and ending readings are exported

This rule supports date breaks (the normal Get Scalar Data rule does not).

[Get Interval Data](#)

Interval

This rule is used to get interval quantities from interval measuring components installed in the Service Points linked to the Usage Subscription for the specified 'Interval' usage period.

This rule retrieves the interval data for measuring components associated to a usage subscription by TOU, SQI and UOM.

This rule converts the interval data to another interval length or unit of measure.

[Get Item Counts and Consumption](#)

Scalar

This rule finds item-based and multi-item-based Service Points linked to the Usage Subscription for the current usage transaction, summarizes the item counts by item type and Service Point, and calculates item-based consumption.

[Get Scalar Details](#)

Scalar

This rule is used to get usage from scalar measuring components installed in the Service Points linked to the Usage Subscription for the specified 'Scalar' usage period.

This rule creates bill determinants by summing all scalar readings for the bill period. This rule can also be used to provide register readings by measuring component. All readings are exported by this rule.

Note: This rule is used for traditional monthly read meters.

[Get Subtractive Interval Details](#)

Subtractive Interval

This rule is used to get interval quantities from subtractive interval measuring components installed on the service points linked to the usage subscription for the specified 'interval' usage period.

It also identifies the start and stop readings for each usage period using subtractive interval readings.

[Get TOU Mapped Usage](#)

Interval

This rule is used to get time of use quantities from interval measuring components for devices installed at the Service Points linked

		to the Usage Subscription for the specified 'Interval' usage period.
Interval Tier Calculation	Interval	<p>This rule calculates the difference between a source and reference vector.</p> <p>This rule loops through each tier that is configured and calculates the imbalance amount associated to that tier level.</p> <p>This rule breaks down that difference into one to many positive or negative tiers, and create a service quantity for each tier calculated.</p>
Profile Accumulation	Interval or Scalar	This rule is used to manipulate a customer's interval data by adding other vectors to it. Those other vectors are derived from a list of profile factors and corresponding characteristic values stored in a list on the usage transaction.
Round and Adjust Usage	Interval or Scalar	This rule copies identified source and target Service Quantities and inserts these as Service Quantities that are rounded and adjusted.
Vector and Service Quantity Math	Interval	<p>This rule is designed to facilitate configuration of complex vector calculations. It is based on a series of underlying services with vectors configured as input to the calculations.</p> <p>Typical uses:</p> <ul style="list-style-type: none"> Perform math using interval data, e.g., take the difference between two curves, find max values, find coincident peaks, multiply a curve by a value, apply TOU maps, etc. Define complex formulas using various interval curves, profile factor values or calculated service quantities (bill determinant values). Support math functions: sin, cos, square root, etc. Store derived curves in memory that can be used in subsequent calculations <p>Please note, this rule is not as efficient as other rules.</p>

Decision-Making Usage Calculation Rules

There are usage calculation rules delivered as part of the base product that help with decision-making when executing running the usage calculation process. For more information on how each rule executes and can be configured, follow the link provided on the rule.

Usage Calculation Rule Name	Purpose
-----------------------------	---------

Execute Usage Calculation Group

This rule performs a call to execute a separate usage calculation group which includes execution of all usage calculation rules within that group.

Exception Handler

This rule evaluates the exception list that was accumulated during the execution of the calculation rules against exception criteria configured on this rule.

Usage Requests

Usage request records are created when bill determinants are requested during billing. The consumption information is then used to create a bill segment for the associated service agreement.

Refer to [The Big Picture of Usage Requests](#) for more details

Use **Menu > Usage > Usage Request** to open this page. When you select a usage request record, the maintenance portal opens and displays the associated information for the usage request record. You can also navigate to the maintenance portal from the [Bill Segment - Usage](#) page.

Refer the embedded help on this portal's zones for more information.

Usage Calculation Requests

About Usage Calculation Requests

Usage calculation request are calculations executed at a customer level where there may be more than one calculation per usage subscription. For example, a customer may have a usage subscription for producing billing determinants but there may be additional calculations that will be executed on a much less frequent basis (annually, quarterly, etc). More specifically, usage calculation requests are used to calculate service point quantities (see [About Service Point Quantities](#) for more information).

Usage calculation requests are defined by the following:

- **Usage Calculation Type:** The usage calculation type for the request. Usage calculation types define the service point quantity type and UOM/TOU/SQI for quantities calculated for requests of that type.
- **Start Date/Time:** The start of the date range for the request.
- **End Date/Time:** The end of the date range for the request.

Maintaining Usage Calculation Requests

You use the **Request** portal to view and maintain usage calculation requests.

Refer to [About Usage Calculation Requests](#) for additional functional information.

You can access the portal from the **Main > Usage > Usage Calculation Request**. You are brought to a query portal with options for searching. Once your record has been selected you are brought to the maintenance portal to view and maintain the selected record.

This portal includes the following zones:

- **Request:** defines the basic attributes of the usage calculation request

- **Request Log:** lists log activities for the usage calculation request

Usage Subscription Quantities

About Usage Subscription Quantities

Usage subscription quantities are quantities that are stored at the usage subscription level. These quantities are calculated at irregular frequencies (such as annually or quarterly) and thus do not make sense as a measured quantity on a device and measuring component. For example, in some deregulated markets the Peak Load Contribution could be stored here and effective dated over time to represent the changing contribution of a given usage subscription to the market wide coincidence peaks.

Usage subscription quantities are defined by the following:

- **Usage Subscription:** The usage subscription for which the quantities were calculated
- **Usage Subscription Quantity Type:** The Usage Subscription Quantity Type used for the record
- **Start Date / End Date:** The date range for the calculated quantity
- **Usage Subscription Quantities:** Calculated quantities based on **Quantity Identifiers** configured on the Usage Subscription Quantity Type (see [Understanding Usage Subscription Quantity Types](#) for more information)

NOTE: There cannot be more than one Usage Subscription Quantity for the same Usage Subscription and Usage Subscription Quantity Type, for the same time period (defined by the Start Date and End Date parameters).

Maintaining Usage Subscription Quantities

You use the **Usage Subscription Quantity** portal to view and maintain usage subscription quantities.

Refer to [About Usage Subscription Quantities](#) for additional functional information.

You can access the portal by selecting **Main**, then **Usage**, then **Usage Subscription Quantity**. You are brought to a query portal with options for searching. Once your record has been selected you are brought to the maintenance portal to view and maintain the selected record.

The following zones may appear as part of the portal's **Main** tab page:

- **Usage Subscription Quantity:** This zone displays the basic attributes of the usage subscription quantity

Time of Use Maps

About Time-of-use Processing

A type of rate used at many utilities is known as a "time of use" rate. For these rates, the price is based on when the usage occurs. For example, prices are typically higher during peak consumption periods (commonly referred to as "On Peak" periods) to encourage lower use during these times. The time range when a given price is applicable is known as a time-of-use (TOU) period.

Time of use periods can (and often do) change during the year. For example, in the summer, TOU periods might be defined as follows:

Time Of Use Period

Time Periods

On Peak	8:00 AM - 9:00 PM Monday - Friday
Off Peak	12:00 AM - 8:00 AM Monday - Friday
	9:00 PM - 12:00 AM Monday - Friday
	12:00 AM - 12:00 AM Saturday, Sunday, and Holidays

While winter TOU periods might be defined as follows:

Time Of Use Period	Time Periods
On Peak	11:00 AM - 5:00 PM Monday - Friday
Off Peak	12:00 AM - 11:00 AM Monday - Friday
	5:00 PM - 12:00 AM Monday - Friday
	12:00 AM - 12:00 AM Saturday, Sunday, and Holidays

This is an example of a "simple" mass-market time-of-use schedule. Commercial and industrial schedules can be much more complex.

Generally speaking, there are two different types of meters that can be installed at service points that participate in TOU rates:

Scalar meters with dedicated registers for each TOU period. For this type of meter, the scalar measurements are the TOU consumption and no special derivation is necessary. The assumption is that the TOU schedule is programmed into the device and no TOU Map is required within Oracle Utilities Meter Data Management.

Interval meters that measure how much is consumed each interval. For this type of meter, the interval measurements are used to derive the consumption in each TOU period based on the TOU Map defined in Oracle Utilities Meter Data Management.

For information on configuration, reference the related section for [TOU Mapping](#) in the Administration Guide.

About TOU Maps

Interval consumption is mapped into time-of-use periods using a TOU map. TOU maps define the TOU periods for each interval. TOU map data is structured in a format very similar to final measurement data, with specified intervals of time each designated to a TOU period (instead of a measurement value). For example, the table below lists a set of TOU map data and corresponding final measurements for a period of 4 hours on January 1, 2010.

TOU Map	Measuring Component		
Date/Time	TOU Code	Date/Time	Consumption
1-Jan-10 3:00pm	ONPEAK	1-Jan-10 3:00pm	14.678
1-Jan-10 4:00pm	ONPEAK	1-Jan-10 4:00pm	29.12
1-Jan-10 5:00pm	ONPEAK	1-Jan-10 5:00pm	12.12
1-Jan-10 6:00pm	OFFPEAK	1-Jan-10 6:00pm	17.16

Any type of final measurement can be mapped to a TOU period, including derived quantities. While the principal requirement for TOU Maps is to aggregate interval consumption into TOU periods for a Usage Transaction, the system has many zones in the user interface that display interval consumption using TOU periods.

Maintaining TOU Maps

This portal is used to display and maintain a TOU Map.

Refer to [About TOU Maps](#) for additional functional information.

You can access the portal from **Menu > Usage > TOU Map**. You are brought to a query portal with options for searching. Once your record has been selected you are brought to the maintenance portal to view and maintain the selected record.

The following zones may appear as part of the portal's **Main** tab page:

- **TOU Map:** Defines basic information about the TOU map, including dynamic options
- **TOU Map Data List:** Lists TOU map data created from the TOU map

The **Time Of Use Map Data Generation Monitor** batch (D1-TOUTR) is used to generate TOU Map data automatically based on the [TOU Configuration](#). TOU Map data can also be generated manually through the TOU Map Portal in the UI.

Dynamic Options

About Dynamic Options

Dynamic Options specify terms that override how usage is normally calculated, such as a critical peak period that affects the TOU mapping of interval consumption.

There are circumstances and conditions during which the rules for creating TOU map data might need to be calculated differently than according to the utility's standard rules. Examples of this might include critical peak periods, curtailment requests or other demand response events. During these types of events, the TOU rules defined for a TOU map may be overridden. This is done through the use of dynamic options and dynamic option events.

Dynamic options allow flexibility for ad-hoc and special events that might impact how usage calculations are performed. For example, if a utility requests that its customers curtail their usage for a specific time period, a dynamic option and corresponding dynamic option event could be used to represent the curtailment request. During the time period of the curtailment request, usage might be calculated differently (with a different set of TOU periods, for example), which in turn might impact how the customer's bill is calculated.

NOTE: Dynamic Options can be created from Customer Care and Billing Contract Options via [Customer To Meter Master Data Synchronization](#).

Dynamic Options and TOU Maps

To apply a dynamic option (and one or more of its related dynamic option events), you reference the dynamic option on a TOU map, along with a corresponding "dynamic" TOU map to be used during the dynamic option event.

For example, with Critical Peak Periods you might add a new TOU period (called "Critical Peak"), and create a new TOU map that is the same as your standard TOU map, but that also includes your Critical Peak TOU period. For example, in the summer your new set of TOU periods might be defined as follows:

Time Of Use Period	Time Periods
Critical Peak	10:00 AM - 2:00 PM Monday - Friday
On Peak	8:00 AM - 10:00 AM Monday - Friday 2:00 PM - 9:00 PM Monday - Friday
Off Peak	12:00 AM - 8:00 AM Monday - Friday 9:00 PM - 12:00 AM Monday - Friday 12:00 AM - 12:00 AM Saturday, Sunday, and Holidays

If a dynamic option event occurs during a usage transaction period, the standard TOU map is overridden with the "dynamic" TOU map. In our example, a usage transaction period that includes August would use the dynamic TOU map when generating TOU map data for the time between 10:00 AM and 2:00 PM on August 2, but would use its standard TOU map for the rest of the month.

About Dynamic Option Events

Dynamic Option Events are specific periods of time during which a dynamic option is applicable.

There are circumstances and conditions during which the rules for creating [TOU map data](#) might need to be calculated differently than according to the utility's standard rules. Examples of this might include critical peak periods, curtailment requests or other demand response events. During these types of events, the TOU rules defined for a TOU map may be overridden. This is done through the use of dynamic options and dynamic option events.

A dynamic option may have many dynamic option events over time.

NOTE: Dynamic Option Events can be created from Customer Care and Billing Contract Option Events via [Customer To Meter Master Data Synchronization](#).

Maintaining Dynamic Options

This portal is used to display and maintain a Dynamic Option.

Refer to [About Dynamic Options](#) for additional functional information.

You can access the portal from **Menu > Usage > Dynamic Option**. You are brought to a query portal with options for searching. Once your record has been selected you are brought to the maintenance portal to view and maintain the selected record.

The following zones may appear as part of the portal's **Main** tab page:

- **Dynamic Option:** defines the basic information about a Dynamic Option.
- **Dynamic Option Event List:** provides a list of the Dynamic Option Events that have been created for this Dynamic Option.

NOTE: Dynamic Options can be created from Customer Care and Billing Contract Options via [Customer To Meter Master Data Synchronization](#). Dynamic Options created from Contract Options should not be modified using this portal.

Maintaining Dynamic Option Events

This portal is used to display and maintain a Dynamic Option Event.

Refer to [About Dynamic Option Events](#) for additional functional information.

You can access the portal from **Menu > Usage > Dynamic Option Event**. You are brought to a query portal with options for searching. Once your record has been selected you are brought to the maintenance portal to view and maintain the selected record.

The following zone may appear as part of the portal's **Main** tab page:

- **Dynamic Option Event:** defines the basic information about a Dynamic Option Event.

NOTE: Dynamic Option Events can be created from Customer Care and Billing Contract Option Events via [Customer To Meter Master Data Synchronization](#). Dynamic Option Events created from Contract Option Events should not be modified using this portal.

Consumption Extract Requests

About Consumption Extract Requests

Consumption Extract Requests are created every time interval data is extracted for Oracle Utilities DataConnect. The consumption extract request can be created manually, typically to initiate an initial load type of extract, or created automatically, typically for an incremental type of extract, based on a configuration on the consumption extract type.

The Consumption Extract Request is responsible for submitting and monitoring the actual batch jobs that perform the data extract. In addition, it can be used to store any additional filters to further trim down data that will be extracted.

Refer to the [Oracle Utilities DataConnect](#) integration section for more details on how this object is specifically put into use.

Maintaining Consumption Extract Requests

This portal is used to display and maintain a Consumption Extract Requests.

Refer to [About Consumption Extract Requests](#) for additional functional information.

You can access the portal from **Menu > Usage > Consumption Extract Requests**. You are brought to a query portal with options for searching. Once your record has been selected you are brought to the maintenance portal to view and maintain the selected record.

The following zones may appear as part of the portal's **Main** tab page:

- **Request:** displays the main attributes of a Consumption Extract Request.
- **Request Log:** displays all log information related to the Consumption Extract Request.

Contacts

About Contacts

Contacts are individuals or business entities with which a company has contact. Service Points can have associated contacts which define the individual or business entity that uses the service (electricity, gas, water, etc.) delivered at the Service Point. A contact is optional for Service Points, but Usage Subscriptions must reference contacts.

Note: The base-package name search on the 360 Degree Search looks for Usage Subscription-related contacts. Use the Service Point Query portal to find a Service Point using a Service Point-related contact.

NOTE: In Oracle Utilities Customer To Meter, contacts are created from Customer Care and Billing Persons via [Customer To Meter Master Data Synchronization](#).

Maintaining Contacts

This portal is used to display a Contact.

Refer to [About Contacts](#) for additional functional information.

You can access the portal from service points, usage subscriptions, and out of service locations (when Operational Device Management is installed). When you select the contact on a service point, usage subscription, or out of service location, you are brought to the maintenance portal to view the selected record.

The following zones may appear as part of the portal's **Main** tab page:

- **Contact:** defines the basic attributes of the contact

NOTE: Contacts are created from Customer Care and Billing Persons via [Customer To Meter Master Data Synchronization](#). Contacts should only be updated via the Customer Care and Billing Person portal.

360 Degree Search

Using 360 Degree Search

The 360 Degree Search feature allows users to search for devices, measuring components, service points, and/or usage subscriptions using a variety of search criteria.

From the search results list, you can navigate to the 360 Degree View portal to view data on one of the following tabs:

- Measuring Component
- Device
- Service point
- Usage Subscription
- Contact

When accessed, the 360 Degree View opens on the tab corresponding to the type of object (device, measuring component, etc.) you select. For example, if you click the Measuring Component description, the Measuring Component tab opens.

Refer to [360 Degree Views](#) for more details about 360 Degree View.

The following options are available for 360 Degree Search:

- **Search by Name:** Allows search by name/address OR contact identifier OR usage subscription identifier. To search by address, click Go To Search by Address. To search by device, click Device.
- **Search by Address:** Allows search by address/name OR service point identifier. To search by name, click Go To Search by Name. To search by device, click Device.
- Note: "Search by Address" search results contain service points with one or more active usage subscriptions only.
- **Search by Device:** Allows search by device identifier OR measuring component identifier. To search by name, click Go To Search by Name. To search by address, click Address.

360 Degree Views

360 View Measuring Component

Using 360 Degree View Measuring Component

This portal is used to view a broad set of information related to a Measuring Component.

You can access the portal from the **Main > 360 Search > [options]**. You are provided with the option of searching by Name, Address, or Device. Once a Measuring Component has been selected you are brought to the 360 Degree View Measuring Component portal.

The following zones may appear as part of the portal's **Measuring Component** tab page:

- **Measuring Component Overview:** Displays the Service Point, device, Device Configuration, Install Event, and Usage Subscription for the selected device.
- **Device Configuration Overview:** Displays an overview of the measuring component's parent device's configurations over time, including the measuring components associated with each configuration, and Service Points (along with the relevant Install Events) at which the device's configurations have been installed over time, if any exist.
- To create a new reading for a scalar measuring component associated to a Device Configuration, click the **New Reading** link in the zone title bar.
- **Interval - Initial Measurement Overlay:** Overlays initial interval measurements (either pre-VEE or post-VEE) against the final measurements for a given period in graphic and tabular formats.
- **Final Values Overlay:** Graphs final measurements for a measuring component, and provides the ability to overlay the graphed data with final measurements from other measuring components. The zone also permits overlaying data from the same measuring component for different time periods, as well as data from measuring components that measuring different quantities, such as temperature.
- **Interval - Audit View:** Allows users to view an interval measurement curve for a given period overlaid with the count of audit records for each individual measurement. It also allows users to magnify a portion of the curve and see how the measurements looked at different points in time.
- **Time of Use By Day:** Displays daily TOU-mapped usage data for an interval measuring component based on a user-defined time period and TOU map.
- **Time of Use Overlay:** Displays an overlay of the TOU periods on a final interval measurement along with totalized TOU consumption based on a user-defined time period and TOU map.
- **Scalar - Initial Measurement Overlay:** Overlays initial scalar measurements (either pre-VEE or post-VEE) against the final measurements for a given period in graphic and tabular formats.
- **Scalar - Audit View:** Allows users to view a scalar measurement for a given period overlaid with the count of audit records for each individual measurement. It also allows users to magnify a portion of the measurement and see how the measurements looked at different points in time.
- **Measurements:** Displays measurement details for the current measuring component in a tabular format. (split into two zones for v2.2)
- **Usage Subscriptions Directly Linked to MC:** Displays Usage Subscriptions that are directly linked to current measuring component.

Functions are available in many of these zones that allow you to interact with the measurement data and/or create new data. For more information of these functions refer to the [Applying Measurement Functions](#) section.

Applying Measurement Functions

Many of the Interval measurement zones on the Measuring Component tab of the 360 Degree View provide access to the following functions:

- **Create Scratchpad:** Creates a scratchpad measuring component along with new initial measurement data by copying all or some of the final measurements from the measuring component displayed in the zone.
- **Create / Override:** Creates new initial measurement data for a selected measuring component for all or part of a selected time period. This function can either copy existing final measurements or create new measurement data for the initial measurement it creates.
- **Export to Excel:** Exports measurement data to a comma-separated values spreadsheet.
- **New Reading:** Creates a new interval initial measurement reading for the measuring component.

- **Rederive Values:** Rederives the measurement's values displayed in the zone.
- **Save As:** Creates new initial measurement data for a measuring component other than that being displayed by copying all or some of the final measurements shown in the zone.

Many of the Scalar measurement zones on the Measuring Component tab of the 360 Degree View provide access to the following functions:

- **Convert to Interval:** Converts scalar consumption into interval consumption. The converted consumption is held in a new scratchpad measuring component.
- **Create / Override:** Creates new initial measurement data for a selected measuring component for all or part of a selected time period. This function can either copy existing final measurements or create new measurement data into the initial measurement it creates
- **Export to Excel:** Exports measurement data to a comma-separated values spreadsheet.
- **New Reading:** Creates a new scalar initial measurement reading for the measuring component.
- **Rederive Scalar Values:** Rederives the measurement's values displayed in the zone.

360 Degree View Device

Using 360 Degree View Device

This portal is used to view a broad set of information related to a Device.

You can access the portal from the **Main > 360 Search > [options]**. You are provided with the option of searching by Name, Address, or Device. Once a Device has been selected you are brought to the 360 Degree View Device portal.

The following zones may appear as part of the portal's **Device** tab page:

- **Device Overview:** Displays the device, Service Point, Install Event, and Usage Subscription for the selected device.
- **Device Configuration Overview:** Displays an overview of the device's configurations over time, including the measuring components associated with each configuration, and Service Points (along with the relevant Install Events) at which the device's configurations have been installed.
- **Scalar Readings:** Displays a list of scalar readings for scalar measuring components associated with the current device and Device Configuration.
- To create a new reading for scalar measuring components associated with the Device Configuration, click **NewReading**.
- To edit an existing reading, click the edit icon for the reading you wish to edit. Editing a reading creates new initial measurements that are validated. If these edits do not pass validations, including VEE Rules, the changes are not saved.

360 Degree View Service Point

Using 360 Degree View Service Point

This portal is used to view a broad set of information related to a Service Point.

You can access the portal from the **Main > 360 Search > [options]**. You are provided with the option of searching by Name, Address, or Device. Once a Service Point has been selected you are brought to the 360 Degree View Service Point portal.

The following zones may appear as part of the portal's **Service Point** tab page:

- **Service Point Overview:** Displays the Service Point, device, Device Configuration, Install Event, and Usage Subscription for the selected Service Point.
- **Measuring Component Types:** Lists the measuring component types configured for the Service Point. To display consumption history for a measuring component, click the **Broadcast** icon next to the Measuring Component Type. Doing so will display either the Interval Consumption History or the Scalar Consumption History.
- **Interval Consumption History:** Displays a graph of interval consumption for a broadcast interval measuring component type.
- **Scalar Consumption History:** Displays a graph of scalar consumption for a broadcast scalar measuring component type.
- **Timeline:** Displays a timeline of events for the Service Point, including usage transactions, activities, and VEE exceptions. Each event is depicted as a button containing the date on which the event occurred. To search for a specific month and year in the Timeline zone, select the month and year from the drop-down lists and click the **Search** icon. To navigate forward and back along the timeline, use the left and right arrows.
- **Service Issue Monitors Related to SP:** displays a list of service issue monitors and related service investigative orders related to the current Service Point, in reverse chronological order.

360 Degree View Usage Subscription

Using 360 Degree View Usage Subscription

This portal is used to view a broad set of information related to a Usage Subscription.

You can access the portal from the **Main > 360 Search > [options]**. You are provided with the option of searching by Name, Address, or Device. Once a Usage Subscription has been selected you are brought to the 360 Degree View Usage Subscription portal.

The following zones may appear as part of the portal's **Usage Subscription** tab page:

- **Usage Subscription Overview:** Displays the Usage Subscription, main customer, Service Point, and direct channels for the selected Usage Subscription.
- **Usage Transaction History:** Lists usage transaction records for the Usage Subscription, including the start date/time, end date/time, description, and duration (in days) for each.
- **Timeline:** Displays a timeline of events for the Usage Subscription, including usage transactions, activities, and VEE exceptions. Each event is depicted as a button containing the date on which the event occurred. To search for a specific month and year in the Timeline zone, select the month and year from the drop-down lists and click the **Search** icon. To navigate forward and back along the timeline, use the left and right arrows.

360 Degree View Contact

Using 360 Degree View Contact

This portal is used to view a broad set of information related to a Contact.

You can access the portal from the **Main > 360 Search > [options]**. You are provided with the option of searching by Name, Address, or Device. Once a Contact has been selected you are brought to the 360 Degree View Contact portal.

The following zones may appear as part of the portal's **Contact** tab page:

- **Contact Overview:** Displays contact information (name, phone number, email address, etc.) for the selected contact.
- **Contact's Service Points:** Lists the Service Points related to the contact, including the relationship type (main contact, main customer, etc.) for each.
- **Contact's Usage Subscriptions:** Lists the Usage Subscriptions related to the contact, including the relationship type (main contact, main customer, etc.) for each.

Service Orders

In this section, we describe how to manage the fieldwork that takes place at your premise's service points.

About Service Order Activities

Service order activities represent specific requests to perform work at service points

These activities orchestrate the steps necessary to fulfill the request, based on the current state of the service point related to the request. For example, the system creates an "enable service" activity when a request is made to enable service at a particular service point. This activity examines the current state of the service point, and creates one or more additional activities if appropriate. For example:

- If there is no meter currently installed at the service point, the service order activity would create an "install meter" service order field activity and send it to a field work system (such as Oracle Utilities Mobile Workforce Management).
- If there is a meter installed, but the meter is not currently registered with the head end system, the service order activity might create a "commission meter" smart meter command.
- If the meter is active and commissioned, but not currently connected, the service order activity might create a "remote connect" smart meter command.

The base package provides the following types of service order orchestration activities:

- **Enable Service:** Used to enable service at a service point.
- **Disable Service:** Used to disable service at a service point.
- **Cut for Non-Payment:** Used to cut off service at a service point due to non-payment of past due amounts.
- **Reconnect for Payment:** Used to restore service at a service point after receipt of past due payment.
- **Exchange Meter:** Used to orchestrate the exchange of meters at service point, such as in the event that a customer upgrades their meter.
- **Back-to-Back:** Used to orchestrate a change of service when the customer at a service point changes; such as, when owners/tenants change.

Service order orchestration activities are defined by the following:

- **Activity Type:** The service order's activity type.
- **Service Date/Time:** The date and time the service order request was received.
- **Service Point:** The service point associated with the service order request.
- **Service Agreements:** A list of one or more service agreements related to the service order request (not used with all service order orchestration activities).
- **Request Information:** Details of the service order request, including requester and external system information.
- **Collection Data Details:** Details regarding past due balances (used with Cut for Non-Payment activities only).
- **Contact Details (or Customer Information):** Contact details for the customer associated with the service order request.

NOTE: Some service order activities use additional data.

In the event that an active service order activity needs to be updated and/or cancelled, the system also supports the following maintenance service order activities:

- **Cancel Orchestration:** Used to cancel a currently active service order activity.
- **Update Orchestration:** Used to update a currently active service order activity.

Service order maintenance activities are defined by the following:

- **Activity Type:** The service order's activity type.
- **Orchestration Activity:** The original orchestration activity related to the maintenance activity.
- **Related Activity:** A specific activity related to the maintenance activity; such as, a service order field activity or smart meter command.
- **Cancel Reason:** The reason for cancelling the original activity (for cancel activities only).
- **Comments/Instructions:** Specific comments and/or instructions applicable to the maintenance activity (for update activities only).
- **Start Date/Time:** The date and time the maintenance activity was initiated (for update activities only).
- **Request Information:** Details of the service order request, including requester and external system information.
- **Activity Hierarchy:** A tree that displays the activity and related activities (including service order field activities and smart meter commands), inbound and outbound communications, and completion events.

How Are Service Order Activities Created?

Service order activities are typically created due to a field activity request as follows:

- Starting or stopping service indirectly causes field activity requests to be created. These field activity requests initiate the service orders to orchestrate the actions necessary to connect or disconnect service. Refer to [Starting Service and Field Activities](#) for more information about how field activity requests are created to start and stop service.

NOTE: If you use the Order transaction to start service, field activity requests will also be created in the same manner described under the Starting Service and Field Activity Requests discussion

- The activation of a severance event with fieldwork causes field activity requests to be generated to disconnect or reconnect service. For more information about severance events and field activity requests, refer to [The Big Picture Of Severance Events](#).

Service order activities can also be created due to a request received from an external system or created directly within Oracle Utilities Smart Grid Gateway.

About Service Order Field Activities

Service order field activities are specific types of tasks performed by field personnel; for example, installing meters, and repairing/replacing meters.

Service order field activities are created when completing specific types of requests for service requires field work. Once created, service order field activities are sent to a field work system (such as Oracle Utilities Mobile Workforce Management) where they are scheduled and assigned to a field work crew. When the task is completed by the crew, the field work system sends an response to the system and the service order field activity is updated as appropriate.

When communicating with field work systems, service order field activities create outbound communications to send the required information to the field work system. When the field work system sends its response, the system creates an inbound communication. See [About Communications](#) for more information about communications.

Service order field activities are created when a service order orchestration activity examines the current state of the service point, and determines that field work is required to completed the service request. For example, if an "enable service" activity determines that there is no meter currently installed at the service point, the service order activity would create an "install meter" service order field activity and send it to a field work system.

Service order field activities are defined by the following:

- **Activity Type:** The service order field activity type.
- **Status:** The current status of the service order field activity.
- **Service Date/Time:** The date and time the service order field activity was created.
- **Service Point:** The service point associated with the service order field activity.
- **Field Task Type:** The field task type for the service order field activity.
- **Recipient:** The service provider to which the service order field activity is sent for scheduling and assignment.
- **Device:** The device related to the service order field activity (if applicable).
- **Request Information:** Details of the service order request, including requester and external system information.
- **Contact Details (or Customer Information):** Contact details for the customer associated with the service order request.
- **Address Information:** The address of the service point associated with the service order field activity.

What Happens After A Field Activity Is Completed?

When a service order activity completes, if there is a related field activity request this will also be completed. Completing a field activity request that is linked to a pending start service agreement, will also automatically activate the service agreement. Similar, completing a field activity request linked to pending stop service agreements will stop the associated service agreement.

After a field activity that is linked to a severance event is completed, the severance event becomes complete. This, in turn, triggers the activation of the next event.

FASTPATH:

For more information about field activities linked to pending starts, refer to [Starting Service and Field Activities](#).

For more information about field activities linked to pending stops, refer to [Stopping Service and Field Activities](#).

For more information about severance events and field activities, refer to [The Big Picture of Severance Events](#).

About Appointments

The Appointment Booking portal is used to request and track appointments related to service order field activities that have been scheduled in an external field work scheduling system such as Oracle Utilities Mobile Workforce Management.

When service order field activities send outbound communications to the field work system, appointments are created in field work system so that the work can be assigned to a crew. Requests for appointments are most often requested automatically when the service order field activity is created, but if needed, users can request appointments manually.

Users work with the Appointment Query portal to search for activities and related appointments.

Users work with the Appointment Booking to request and track appointments for service order field activities. This portal includes the following zones:

- **Service Point Activities:** Displays a list of activities and related appointments for the current service point in date descending order. This zone also includes a filter area which allows the user to define the inclusion or exclusion of activities according to certain criteria
- **Activity Summary:** Displays details of a selected activity in the Service Point Activities zone (indicated by a star).
- **Appointment Booking Results:** Displays a list of available appointment slots as returned by the scheduler. This zone allows the user to book an appointment by selecting a slot and subsequently updating the orchestration or service order field activity.

Field Activity Maintenance

A field activity request is a request to perform actions at a service point. Examples of field activity requests include start service, stop service, and start/stop.

The topics in this section describe the pages on which field activity request-related information is maintained.

Lifecycle of a Field Activity

The following diagram illustrates the lifecycle of a field activity.

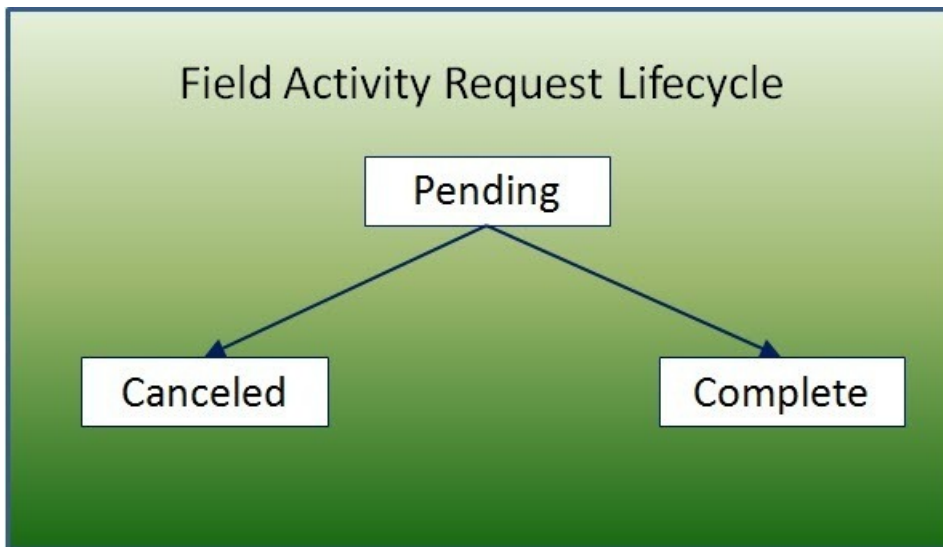

Pending: A field activity starts its life in the Pending state.

Complete: After the related actions have been performed, the system is updated to reflect what happened and the field activity request becomes complete. No changes may be made to a Complete field activity request.

Canceled: A Pending field activity request may be Canceled..

Field Activity - Main Information

The Main page contains core field activity information.

Description of Page

The following fields are displayed on every page.

Field Activity is a concatenation of summary information regarding this field activity request.

Field Activity ID is the system-generated unique identifier for the field activity request.

The remaining fields are specific to the Main page.

Indicate the **Service Point ID** where the activity takes place. Information about the service point is displayed adjacent.

Use **Activity Type** to define the type of field activity request. Only those activity types defined as valid for the service point's SP type's field activity profile may be selected. The activity type's description is displayed adjacent.

Displayed just below the **Activity Type** is a system-generated message regarding how the field activity request was created. This message includes the date and time the field activity request was created and the process that created it. If a user manually creates a field activity request the user's ID is concatenated into the message.

Use **Schedule Date / Time** to define when the field activity is scheduled to be done.

Enter **Reschedule Reason** when changing the field activity's schedule date/time.

NOTE:

Reschedule Reason only appears if the **Fieldwork Options** feature configuration exists with the **Reschedule Reason Required** option set to Y.

Field Activity Status defines the state of the field activity. The following values may exist:

- **Pending** A field activity is originally created in the Pending state.
- **Completed** When an activity's fieldwork is done the system is updated with the results and the activity becomes Completed.
- **Canceled** If an activity cannot be done, it should be Canceled.

To change the status of the field activity request, use the **FA Actions**, described below.

If you cancel a field activity, you must supply a **Cancel Reason Code**.

Field Activity Priority this field is not used when using Service Order Management.

Use **Comments** to describe anything unusual about the activity.

If you have plugged in an FA Additional Information algorithm on the [Installation](#) record, **Additional Info** displays the results of the algorithm, if any.

The **FA Actions** buttons allow you to change the status of the field activity request.

- Click **Complete** to change the status of the field activity to complete. This button is only enabled if the status is pending.
- Click **Cancel** to change the status of the field activity to canceled. This button is only enabled if the status is pending.

NOTE: **Pend** and **Held** are not applicable for service order related field activity requests.

At the bottom of this page is a [tree](#) that shows the account(s) and service agreement(s) that are currently linked to the field activity request's service point. You can use this tree to both view high-level information about these objects and to transfer to the respective page in which an object is maintained.

Field Activity - Steps

The Steps page is not applicable for service order related field activity requests.

Field Activity - Characteristics/Remarks

Use this page to link additional information to the field activity requests.

Description of Page

Summary information about the **Service Point** where the activity will occur is displayed, as well as the service point's system-generated **Service Point ID**.

The **Characteristics** collection contains information that describes miscellaneous information about the field activity request.

To modify a characteristic, simply move to a field and change its value. To add a new characteristic, click the plus button to insert a row, then fill in the information for each field. The following fields display:

- **Characteristic Type** Indicates the type of characteristic.
- **Characteristic Value** Indicates the value of the characteristic.

NOTE:

Default Note. A field activity's characteristics default from the [field activity type](#).

Typically fieldwork related remarks are processed by service order field activities and if applicable a service task. In addition remarks can be added to the **Remarks** grid.

The **Field Activity Remark Status** is only relevant if a **Field Activity Remark** code has algorithms associated with it. The execution of the algorithm is performed by the field activity remark activation a background process (**FACT**).

- When you add a remark that has an algorithm, the status is Pending . It remains in this state until the FACT process next runs.
- When the FACT process next runs, if the system is successful in executing the algorithm, the status of the field activity remark may become Complete. If the system is not successful in executing the algorithm, the status becomes Error.

Field Activity - Field Activity Portal

The Field Activity Portal page displays additional information associated with a field activity request.

Depending on your implementations requirements, you may define additional zones to appear on this Portal.

The contents of this section describe the zones that are available on this portal page.

General Information

Field Activity ID, **Field Activity Info** are displayed.

Service Order Management Information

This zone displays the related service order activities in Service Order Management.

- Clicking a service order activity's information navigates to the Service Order Management Activity Maintenance Portal.
- If the field activity requires appointment, formatted information, indicating that appointment must be booked, appears on top of the field activity tree. Clicking "Book Appointment Now", navigates to Service Order Management application's Appointment Booking Portal.

Field Activity Attachments

This zone provides the ability to add, edit, delete, upload, and view attachments related to field activity request.

- Clicking attachment information navigates to Attachment Maintenance Portal.

Field Activity - Log

Use this page to view and add log records for a field activity request.

Description of Page

The **Log** grid displays log entries that audit the progress of a field activity. You cannot modify or delete log entries that have been created by the system.

You can manually add a log entry of type User.

The Log grid displays the following information:

- **Date/Time** Displays the date and time when the log entry was created.
- **Log Type** Indicates the entry event for which the log entry was created. The log type for log entries created online is User.

NOTE:

The values for the log type are customizable using the Lookup table. This field name is FA_LOG_TYP_FLG.

Details Contains user-specified or system-generated information about the log entry.

User Displays the user who caused the log entry to be created.

Sequence Displays the sequence that makes up part of the unique identifier of this log record (together with the Field Activity ID).

Outage Calls

NOTE:

The information in this section applies to the integration with the Oracle Utilities Network Management System (NMS).

You can use the Outage Call page to view trouble calls and outage information, and to send outage call reports to NMS for a specific service point. You can also use this page to schedule job site appointments. Open this page using **Menu > Communication > Outage Call > Search**.

Description of Page

The Outage Call Search zone is a standard [multi-query portal](#) used to search for and list existing Outage Call records. In the search results list, click the Outage Call link to view and maintain the information about the outage call.

The following zones are displayed for the selected outage call:

Outage Call Actions

This is a standard [actions zone](#).

If the outage call is in a state that has valid next states, buttons to transition to each appropriate next state are displayed. If the record is in at state in which it can be edited, select **Edit** to change details regarding the record, such as scheduling or rescheduling a callback or meeting.

Outage Call Zone

The outage call zone contains display-only information about the record.

Outage Call Log

This is a standard [log zone](#).

Outage Information

NOTE:

The information in this section applies to the integration with Oracle Utilities Network Management System (NMS).

The Outage Information portals provide a real-time interface with NMS to search for the following network management items:

- Job History
- Call History
- Planned Outages.

Open this page using **Menu > Communication > Outage Information**.

Job History

You can use the Job History portal to retrieve current and historical outage and non-outage jobs from NMS by a customer service point or account ID, or proximity to a street intersection or street segment, or other identifiers such as a 911 incident identifier, caller name, or call phone number.

Description of Page

The Job History zone can be used to search for an existing Job History record. If the search results list contains records for a single service point, the service information for that service point and the job history results will be displayed. If the list contains multiple service point's records, a list of service points are displayed and the service information and job history results will be displayed for one of these service points. You can click on the **Show History** button to display the service information and job history results for any other service point record.

Please see the zone's help text for information about this zone's fields.

Call History

You can use the Call History portal to retrieve trouble call history from NMS by a customer service point, or account id, or proximity to a street intersection or street segment, or other identifiers such as a 911 incident identifier, caller name or call phone number.

Description of Page

The Call History zone can be used to search for an existing Call History record. If the search results list contains records for a single service point, the service information for that service point and the call history results will be displayed. If the list contains multiple service point's records, a list of service points are displayed and the service information and call history results will be displayed for one of these service points. You can click on the **Show History** button to display the service information and call history results for any other service point record.

Please see the zone's help text for information about this zone's fields.

Planned Outages

You can use the Planned Outages portal to retrieve planned outage information from NMS.

Description of Page

The Planned Outages zone can be used to search for current, future and past planned outage status and details from NMS for a particular service point. Planned outage information will only be available once a planned outage has been scheduled and the list of impacted customers for that planned outage has been generated.

Please see the zone's help text for information about this zone's fields.

Billing

In this section, we describe how to manage your customer's bills.

The Big Picture of Billing

A bill is used to communicate changes in an account's financial obligations to the customer. Over time, a customer receives many bills. The topics in this section provide background information about a variety of billing topics.

WARNING:

Some organizations are responsible for presenting 3 rd party charges on their bills. Others are responsible for sending their charges to a 3 rd party for presentation on their bills. If this describes your organization, refer [The Big Picture of SA Relationships](#) for a description of how this functionality is implemented.

An Illustration Of A Simple Bill

The following diagram illustrates a simple bill:

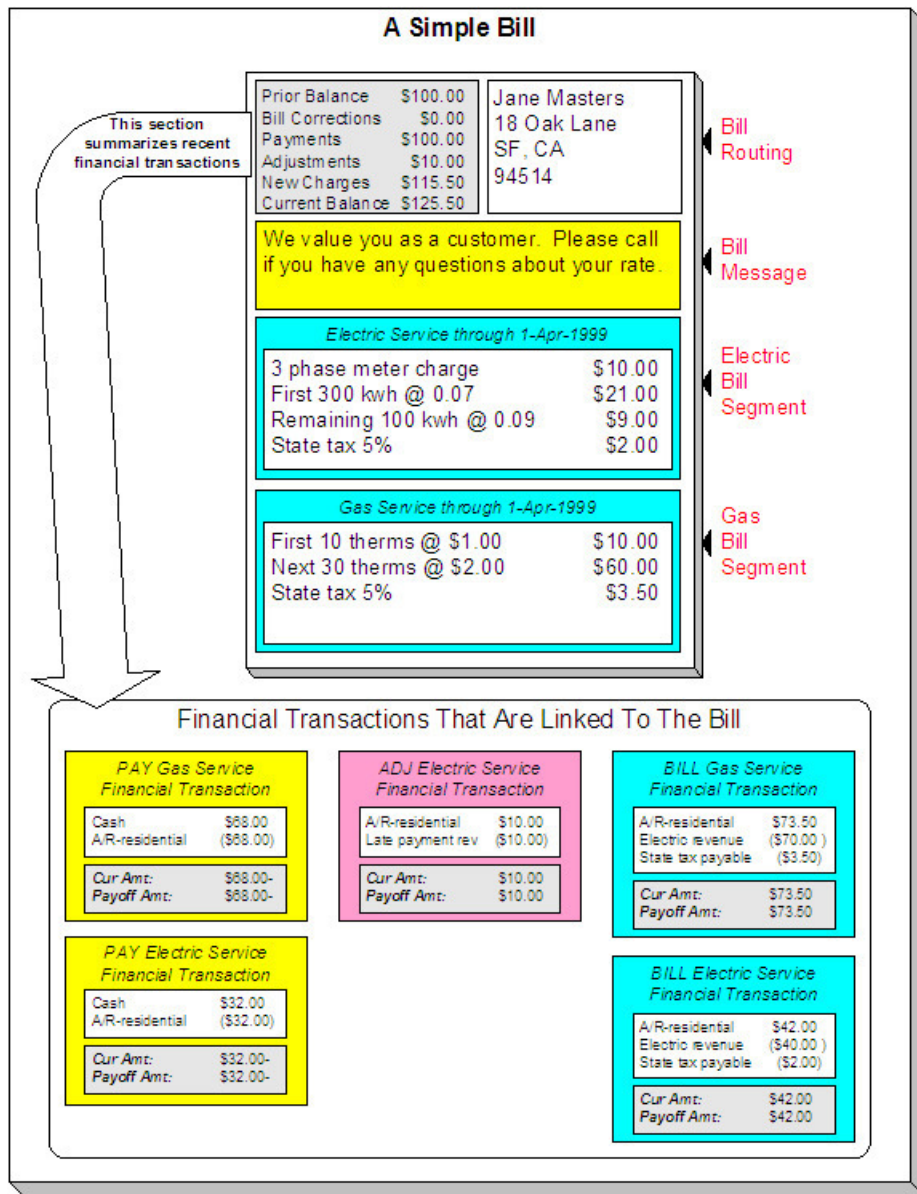

The following concepts are illustrated above:

A bill is produced for an account A bill is produced for an account. Over time, an account receives many bills.

A bill summarizes financial transactions A bill contains information about the various financial transactions that have taken place since the last bill was produced (i.e., payments, adjustments, and bill corrections). The above illustration shows a bill with financial transactions for new charges, a payment, and an adjustment.

A bill is routed to persons A copy of the bill is sent to every person linked to the account who requires a copy of the bill.

A bill contains messages A bill may contain messages.

A bill typically contains bill segments A bill typically contains one bill segment for every active service agreement linked to its account.

A bill segment contains calculation details A bill segment contains information showing how the segment was calculated and how it should be printed on the customer's bill.

An Overview of the Bill Creation Process

When the system is asked to produce a bill for an account, it attempts to create one or more bill segments for every non-cancelled / non-closed service agreement linked to the account. Whether or not a service agreement contributes bill segment(s) to a bill is a complicated subject as the system supports a wide variety of bill segment creation methods. For example, a service agreement that charges for metered service is produced as follows:

- The system first requests for the amount or usage consumed (or billing determinants) from Oracle Utilities Meter Data Management; for example, the number of lamps, the number of gallons of water, or the peak kW. For more information, refer to .
- Next, the system applies the service agreement's rate to the amount consumed in order to calculate how much the customer owes. A bill segment and a financial transaction are generated to reflect the results of this calculation. The details of the calculations are captured in the bill calculation lines. For more information, refer to [How Rates Affect The Information On Bill Segments](#) for the details. Refer to [Effective Dates and Price Proration](#) for information about how the system prorates changes to rates and prices during a bill period.

NOTE:

There are many bill segment creation algorithms. The above points explain how a bill segment is produced for a service agreement. It's important to be aware that the system has other bill segment creation algorithms. For example, if the service agreement charges for a deposit, the system neither amalgamates consumption nor does it apply a rate. You may be wondering how the system knows which method to use. It uses the bill segment type on the service agreement's SA type. Refer to [Designing and Defining Bill Segment Types](#) for a description of the various bill segment creation algorithms that are supported in the system.

If errors are detected during the bill segment creation process, the bill segment is saved with its error. The system then proceeds to the account's next service agreement. This way, a user can see all problematic bill segments so they can be corrected en masse. Refer to [Bill Errors](#) for information about how to deal with bill errors.

NOTE:

Interdependent service agreements. Your organization may have some service agreements whose charges must be calculated in a specific order. For example, you might have a service agreement whose bill segments are calculated using charges from a different bill segment. If this describes your organization, be aware that the system creates the bill segments in the order of the [billing processing sequence](#) on each service agreement's SA type.

When every segment on a bill is error free, the bill is ready to be completed. When a bill is completed, the system:

- Creates a bill routing for each person linked to the account who requires a copy of the bill. The routing information controls the format of the printed bill and how the bill is sent to the person. Refer to [The Source Of Bill Routing Information](#) for the details.
- Links all bill messages to the bill. A bill message can come from a variety of sources. Refer to [The Source Of Bill Messages](#) for the details.
- If the Freeze At Bill Completion [installation option](#) has been turned on:
 - All freezable bill segments will be frozen.
 - All freezable adjustments whose adjustment type indicates Freeze At Bill Completion will be frozen.
- Sweeps recent financial transactions that have been created since the last bill was completed. Refer to [Financial Transactions Created Between Bills](#) for information about how payments, adjustments and bill corrections appear on a bill.

- There are several other functions that happen at completion time. Refer to the description of the Complete button under [Bill Lifecycle](#) for the details.

And that's it; the bill can now be sent to the customer.

The remaining topics in this section provide more information about the creation and completion of bills.

NOTE:

Batch and real-time bill creation. Anything the batch bill process does for whole sets of accounts, you can do to a specific account on-line / real time. Refer to [How To Create A Bill For All Service Agreements Linked To An Account](#) for information about how to create a bill on-line / real time. Refer to [Batch Billing](#) for more information about the batch bill creation process.

Bill Errors

The topics in this section describe errors that are detected when the system creates a bill.

Bill Segment Errors

If you consider the huge number of variables involved in the creation of a bill segment, it probably won't surprise you to learn that occasionally, some bill segments are in error.

Errors tend to be caused by missing or inconsistent data. Some examples of classic errors:

- **Missing master data.** For example, if a bill is supposed to be routed to the account's mailing address and the account doesn't have such an address, an error is generated.
- **Missing rate data.** For example, if a rate contains a customer specific charge and there is no value defined on the customer's service agreement, an error is generated.

The system saves bill segments that are in error just as it saves bill segments that are error-free. This is done because bill segments are nothing more than a snapshot of the data that was used to calculate the charges. By saving the snapshot, you can see the information the system used when it detected the error and therefore more effectively fix the cause of the error. The standard way to fix an error is to:

- Look at the bill segment to determine the cause of the error.
- Correct the cause of the error.
- Regenerate the bill segment. Regeneration simply deletes the offending segment and recreates a new segment using the corrected information.

For every bill segment in error, a record is written to the [Bill Segment Exception](#) table.

FASTPATH:

Refer to [How To Correct A Bill Segment That's In Error](#) for instructions describing how to correct a bill segment.

It's obvious but worth stressing that a bill may contain some segments that are perfect and others that are in error. Once all segments that are in error are corrected, the bill can be completed (and sent to the customer).

If the bill segment in error was created as part of the batch bill process, the system attempts to fix the offending segment(s) each night during the account's bill window by regenerating it. Therefore, if the cause of the error is fixed during the day, the system will automatically regenerate the bill segment when batch billing next runs; you don't have to manually correct each bill. And once a bill is error-free, it will be completed and sent to the customer.

FASTPATH:

Refer to [Batch Billing](#) for more information.

Bill Completion Errors

In addition to errors on bill segments, there may also be errors detected when the system attempts to complete a bill. For example, if the system cannot find a mailing address, the bill will be in error (as opposed to one of its bill segments).

Errors tend to be caused by missing or inconsistent data. Some examples of classic errors:

- **Missing mailing address.** For example, if the system cannot find an address to which the bill can be routed, it generates an error.
- **Bill segments are in error.** If a bill contains bill segments that are in error, it cannot be completed and an error is generated.

The system saves bills that are in error just as it saves bills that are error-free. This is done because bills are nothing more than a snapshot of the data that was used to calculate the charges. By saving the snapshot, you can see the information the system used when it detected the error and therefore more effectively fix the cause of the error. The standard way to fix an error is to:

- Look at the bill to determine the cause of the error.
- Correct the cause of the error.
- Recomplete the bill.

For every bill in error, a record is written to the [Bill Exception](#) table.

FASTPATH:

Refer to [How To Correct A Bill That's In Error](#) for more information.

If the bill completion error was created as part of the batch bill process, the system attempts to recomplete the bill each night during the account's bill window. Therefore, if the cause of the error is fixed during the day, the system will automatically complete the bill when batch billing next runs; you don't have to manually complete each bill.

FASTPATH:

Refer to [Batch Billing](#) for more information.

Cancel / Rebill Incorrect Bill Segments

Sometimes the error on a bill segment is not detected by the system. Such errors occur when the data used to calculate the bill is valid, but wrong. For example, the dial reading on the meter read is incorrect due to slipped fingers, or the sales tax percent was entered incorrectly on a bill factor.

There is no way the system can detect such problems and therefore the system freezes the bill segment and routes the bill to the customer. To correct such a bill segment, you must cancel the offending segment and create a new segment (after correcting the cause of the problem). We refer to this process as cancel / rebill.

FASTPATH:

Refer to [How To Cancel / Rebill A Bill Segment](#) for more information about how to cancel / rebill a frozen bill segment.

You must use the cancel / rebill process to correct problems on frozen bill segments. This is because a frozen bill segment can be thought of as having been posted to your general ledger (even if the GL interface hasn't run). And once a financial

transaction is posted to the general ledger, it can only be removed via a reversal. Contrast this to bill segments that are in error - they can be deleted because they were never posted to the general ledger.

FASTPATH:

Refer to [Bill Segment Lifecycle](#) for more information about the differences between bill segments that are frozen and those that are in error.

NOTE:

Bill segments are canceled / rebilled. It's important to stress that bill segments are canceled and rebilled (as opposed to bills). If every bill segment on a bill is incorrect, you must cancel / rebill each individual bill segment.

Using the cancel or cancel/rebill functionality will cause the cancel and rebill details to be swept on to the customer's next bill. If your organization requires cancellation details to be presented to the customer separately from the new bill, then you will need to use Credit Notes. Refer to [Credit Notes - Presenting Cancellation Details on a Separate Bill](#) for more information. If your organization requires cancellation and rebill details to be presented to the customer separately from the new bill, then you will need to use Correction Notes. Refer to [Correction Notes - Presenting Correction Details on a Separate Bill](#) for more information.

Credit Notes - Presenting Cancellation Details on a Separate Bill

The system's [Cancel / Rebill](#) functionality will include cancellation and rebilling details on the customer's next bill. Some organizations are required to present cancellation details to the customer separately and not to commingle them with a new bill. This separate statement containing only the cancellation information is referred to as a Credit Note.

Credit Notes may be created for an individual bill segment or for all the bill segments linked to a bill. To create a credit note, a Credit Note button is available on the [Bill Segment](#) page and on the [Bill](#) page.

FASTPATH:

Refer to [How To Create A Credit Note](#) for more information about how to create credit notes for a bill or bill segment.

The topics in this section provide describe the impact of this functionality.

Credit Notes Are Only Possible if the Installation Option Is Turned On

The Credit Notes button on the bill segment and bill pages will only be available if you have selected the Credit Note Bill Correction option on the [Installation](#) record.

Credit / Correction Notes and Auto Pay

If a credit or correction note is being created for a customer who is enrolled in Auto Pay, note the following functionality:

When creating a credit or correction note for a bill (and all its bill segments):

- The system will cancel an automatic payment behind-the-scenes if a credit or correction note is issued BEFORE the automatic payment is interfaced to the financial institution. When you recomplete the bill, the system will create a new automatic payment that reflects the new amount due (and the canceled automatic payment will net out the original automatic payment). This is standard auto pay logic. Refer to [How Are Automatic Payments Cancelled?](#) for more information.

- If the customer has automatic payments that have already been interfaced to the financial institution, the creation of the credit or correction note will have no affect on any automatic payment. A warning will be issued in this case.

When creating a credit or correction note for a bill segment:

- Because automatic payments are for an entire bill, creating a credit or correction note at the bill segment level will not affect any automatic payments. A warning is issued in this case.

FASTPATH:

For more information about correction notes, see [Correction Notes - Presenting Correction Details on a Separate Bill](#).

Adjustments On Credit Notes

Above, we described how a credit note is a separate document that contains the cancellation details of the various bill segments that appeared on a given bill. Some implementations also want the adjustments that appeared on the original bill to be cancelled when a credit note is produced. Then, when the next bill is produced for the customer, they want these same adjustments reproduced. The following points describe how to implement this functionality:

- Plug in a Bill Completion algorithm on the applicable [Customer Classes](#). A base-package algorithm (C1-CN-RADJ) will reverse a bill's adjustments when a credit note is completed.
- Plug in a Post Bill Completion algorithm on the applicable [Customer Classes](#). A base-package algorithm (C1-CN-ADNB) will recreate the adjustments on the original bill after the credit note is completed. These adjustments will be swept onto the next bill produced for the account.

You can restrict the above functionality to specific adjustment types (for whatever reason). You do this by putting a given char type / char value on the adjustment types that should be reversed and recreated when a credit note is created. You define this char type / char value combination as parameters of the two algorithms described above.

NOTE:

When the original bill contains adjustment cancellations. The above discussion explained how adjustments can be canceled on a credit note and then recreated on the next bill. These same algorithms also do the opposite, i.e., if the original bill contains an adjustment cancellation, the credit note will contain the recreated adjustment, and the next bill will contain its cancellation. Without this, the credit note would not be the reversal of the bill (and this is how some organizations operate).

Credit Note Routing Suppression

Some implementations do not send credit notes to their customers. To implement this functionality, plug in a Bill Completion algorithm on the applicable [Customer Classes](#). A base-package algorithm (C1-CN-BRT) will cause the routing information to be suppressed when a credit note is completed.

Correction Notes - Presenting Correction Details on a Separate Bill

The system's [Cancel / Rebill](#) functionality will include cancellation and rebilling details on the customer's next bill. Some organizations are required to present cancellation and rebilling details to the customer separately and not to commingle them with a new bill. This separate statement containing the cancellation and rebill information is referred to as a Correction Note.

Correction notes may be created for an individual bill segment or for all the bill segments linked to a bill. To create a correction note, a **Correction Note** button is available on the [Bill Segment](#) and [Bill](#) pages.

FASTPATH:

Refer to [How To Create A Correction Note](#) for more information about how to create correction notes for a bill or bill segment.

The topics in this section describe correction notes.

Correction Notes Are Only Possible if the Installation Option Is Turned On

The **Correction Note** button on the bill segment and bill pages will only be available if you have selected the Correction Note Bill Correction option on the [Installation](#) record.

FASTPATH:

If your implementation uses Correction Notes, it is recommended to also use the Freeze At Bill Completion installation option. For more information, see [Installation Options - Billing](#).

Correction Notes Versus Credit Notes

Correction notes are a mixture of Credit Note and [Cancel / Rebill](#) functionality. However, unlike credit notes, correction notes are like regular bills and are subject to payment.

When you issue a correction note for a bill, the system cancels and rebills the bill segments for that bill. The new bill (the correction note) contains both the cancelled bill segments and the rebilled bill segments.

Similar to credit notes, the new bill (or correction note) is stamped with the ID of the original bill. After you review the bill segments, you can complete the correction note. During completion, the rebilled bill segments and the cancelled financial transactions (of the original bill's bill segments) are swept onto the correction note.

Correction Notes and Auto Pay

FASTPATH:

Refer to [Credit / Correction Notes and Auto Pay](#) for a description of how the system handles correction notes for customers using auto pay.

How the System Requests How Much Was Consumed

There are two types of service agreements:

- Those that charge for some commodity; such as, electricity, water, garbage, and street lighting.
- Those that charge for something intangible; such as, deposit, charitable contribution, and payment arrangement.

For service agreements that charge for something intangible, there is no notion of requesting or determining how much was consumed and therefore the topics in this section are not relevant. For service agreements that charge for a commodity, the first step in the creation of a bill segment is requesting the amount or usage consumed (or bill determinants) from Oracle Utilities Meter Data Management; for example,

- If the service agreement bills for electricity, the system must know how much electricity was consumed.
- If the service agreement bills for lamp service, the system must know how many lamps the customer uses.

After the system requests and receives the amount or usage consumed (or bill determinants) during the bill period from Oracle Utilities Meter Data Management, it saves the consumption or usage details on the bill segment in the following snapshots:

- The **item snapshot** contains information about the items that existed at the service points received from Oracle Utilities Meter Data Management
- The **calculation/audit read details** contains information about the meter read details received from Oracle Utilities Meter Data Management
- The **calculation/audit usage details** contains information about the usage details received from Oracle Utilities Meter Data Management.
- The **service quantity snapshot** contains the billable service quantities received from Oracle Utilities Meter Data Management

NOTE: This logic is in a plug-in. The logic described below resides in algorithms that are plugged-in on the bill segment type referenced on a service agreement's SA type. If you need different logic, you should develop the appropriate algorithm and plug it in on your bill segment types.

FASTPATH:

Refer to [The Big Picture of Usage Requests](#) for more information about how Oracle Utilities Customer Care and Billing requests and receives consumption / usage information from Oracle Utilities Meter Data Management.

Refer to [Usage](#) for more information about how Oracle Utilities Meter Data Management calculates usage.

Item Snapshot

- There are two sources of items:
 - Item-based service points have a single, **badged** item that may be installed at any instant in time. These types of service points are used, for example, when your organization keeps track of the installation history of specific lamps. If an item is installed at an item-based service point during the bill period, it will be included in the item snapshot.
 - All types of service points (metered, item-based, and non-badged) may contain one or more **unbadged** items. Multiple items exist at a service point, for example, when your organization chooses to record multiple lamps on a single service point rather than creating a separate service point for each lamp (this might be useful for a parking lot at a shopping mall). Each item referenced in the service point's collection of unbadged items is included in the snapshot.

FASTPATH:

Service Quantity Snapshot

NOTE:

Pre-Processing Calculation Rules. If the service agreement's rate has pre-processing calculation rules, they may alter the amount of measured consumption or add additional units of measure to the SQ snapshot. Refer to [All Calculation Rule-Based Rates Share a Common Structure](#) for more information about pre-processing calculation groups.

Lamps and estimated consumption. If any of the items linked to the service agreement's service points indicate the system should estimate consumption (e.g., lamps), additional entries will be added to the SQ snapshot for each such item. Refer to [Device Types](#) for more information.

Meter read details used for [interim calculations](#) are ignored when producing the service quantity snapshot.

Calculation / Audit Read Details

We use the term "calculation / audit read" to describe a meter read that appears on a bill segment. The following points provide examples of when calculation / audit reads may be required:

- Some retail companies upload meter read details when they upload [pass through charges](#). They do this in order to print the read details that were used to calculate the pass-through charges. It should be stressed that these reads are not used to derive billable consumption (because the charges have already been calculated). These reads are only uploaded for printing purposes and therefore "real" meter reads are not created. We categorize these reads as "calculation / audit reads". Refer to [Billable Charge Upload - Read Details](#) for more information about uploading meter reads with pass-through charges.
- When usage requests are sent during billing to Oracle Utilities Meter data Management, meter reads details may be returned to Oracle Utilities Customer Care and Billing as part of the usage request response. These reads are used for printing purposes. These reads are captured as "calculation / audit reads". Refer to [Usage Requests](#) for more information.
- You may have situations where a meter has been temporarily removed from a service point but the business practice dictates that usage for the service point should be calculated during billing.

Calculation / audit reads are stored in a bill segment's read details (the name of the table is `CI_BSEG_READ`). The following points describe the main features of calculation / audit reads:

- Calculation / audit reads may or may not reference a service point.
- Calculation / audit reads do not reference the prime key of a real read.
- Calculation / audit reads have a usage flag with a value of Calculation .
- Calculation / audit reads do not require a UOM code. If a UOM is not supplied, an SQI must be supplied.

If you encounter other scenarios during your implementation that necessitate calculation / audit reads, you can develop bill segment type and calculation rule algorithms to add additional calculation / audit reads to a bill segment's read details.

Calculation / audit read details are shown in a separate section on [Bill Segment - SQ Details](#).

Calculation / Audit Usage Details

We use the term "calculation / audit usage" to describe service quantities retrieved from the bill segment's usage request. An example of when calculation / audit usage may be required:

- When usage requests are sent during billing to Oracle Utilities Meter Data Management, usage details may be returned to Oracle Utilities Customer Care and Billing as part of the usage request response. Oracle Utilities Meter Data Management might return both usage details and meter reads to print on the bill.

Usage service quantities are also stored in a bill segment's read details (the name of the table is `CI_BSEG_READ`). The following points describe the main features of calculation / audit usage:

- Calculation / audit usage may or may not reference a service point.
- Calculation / audit usage does not reference the prime key of a real read.
- Calculation / audit usage has a usage flag with a value of Service Quantity.

- Calculation / audit usage does not require a UOM code. If a UOM is not supplied, an SQI must be supplied.

If you encounter other scenarios during your implementation that necessitate calculation / audit usage, you can develop bill segment type and calculation rule algorithms to add additional calculation / audit usage to a bill segment's read details.

Calculation / audit usage details are shown in a separate section on [Bill Segment - SQ Details](#).

How To Override The Commodity Amount In A Bill Segment

As described earlier, the calculation of the amount consumed is one of the first steps that takes place when a bill segment is created. 99.9% of the time, the system does a perfect job in this effort. However, there are rare circumstances when, due to missing or incorrect data, the quantity calculated by the system is not what you want to charge the customer for (consider what the consumption should be if the meter is broken?).

To help you deal with these rare situations, a "back door" exists that allows a bill segment's billable quantities to be overridden. This truly is a "back door" because the proper way to fix the amount of a commodity is to correct the cause of the error and then cancel / rebill the bill segment.

How Rates Affect the Information on Bill Segments

After consumption has been compiled, the system applies the service agreement's rate to the consumption to determine how much to charge the customer. We refer to this process as the "rate application."

The rate application is a very sophisticated process and can affect every aspect of a bill segment. See [Rate Schedule Execution](#) for an overview of how the system processes a rate.

Rates not only control which charges appear on the bill, but also the verbiage. In addition, there are variables that can be used in the configuration to customize the message that the customer receives. See [How to Use Description on Bill](#) for more information

NOTE:

Not all service agreements use a rate! There are a small number of service agreements that don't use a rate to calculate the charges that appear on their bill segments. For example, a service agreement used to levy a customer's payment arrangement amount doesn't need a rate because the amount to charge is defined on the service agreement. Whether or not a service agreement needs a rate is defined by the service agreement's SA type. Whether or not the system calls the service agreement's rate to calculate charges is controlled by the bill calculation algorithm plugged-in on the bill segment type that's referenced on the service agreement's SA type. Refer to [Designing and Defining Bill Segment Types](#) for a description of the various bill segment creation algorithms that are supported in the system.

Proration. A rate contains a variety of effective-dated information (meaning that the prices are effective-dated, and the structure of the rate is effective-dated) If this effective-dated information changes during a bill period, the system may need to prorate the charges; for example, if the sales tax percentage changes mid-period, the system can prorate the tax change. Refer to segments. Refer to [Effective Dates and Price Proration](#) for more information.

There are many plug-in spots available on a calculation rule. These plug-ins can manipulate virtually every aspect of the bill segment. This means if you require functionality that isn't support by the base package calculation rule, you can build additional calculation rule plug-ins to do whatever you need. See [Base Package Calculation Rule Descriptions](#) for more information

FASTPATH:

Refer to [Rates](#) for more information about how rates are constructed.

Bill Frequency - Bill Cycle vs Bill Segment Duration

An account's bill cycle defines when the system attempts to create bill segments for the account's service agreements. The word "attempt" is stressed because a service agreement may not have a bill segment on every bill created for its account.

Some examples will help make the point:

- An account may be on a monthly bill cycle (meaning we attempt to create a bill every month for the account) but contain only biannual service agreements. However, this is not sensible. Why? Because the system would attempt to create a bill every month for the account's service agreements, but only twice during the year would it succeed (because the service agreements have a biannual duration).
- An account may be on a biweekly bill cycle (meaning we attempt to create a bill every 2 weeks for the account) and contain a mixture of biweekly, monthly, and quarterly service agreements. In this scenario, every two weeks the system would create a bill that contains at least one bill segment (for the biweekly service agreement). However, 12 times a year, the bill will contain an additional bill segment for the monthly service agreement. And 4 times a year, the bill will contain one more bill segment (for a total of 3) for the quarterly service agreement.

In sum, the account's bill cycle controls when the system attempts to create a bill for the account's service agreements. Whether a service agreement contributes a bill segment to the bill is a complicated subject. The topics in this section describe how the system knows it's time to create a bill segment for a service agreement.

IMPORTANT:

An account's bill cycle should attempt to create bill segments at least as often as the shortest service agreement duration. For example, if an account has both monthly and quarterly service agreements, the account should be placed on a monthly bill cycle. Refer to [How Does An Account Get Its Bill Cycle?](#) for more information.

Ways To Control The Start Date Of A Bill Segment

Bill segments produced for a service agreement have two time periods:

- The bill segment period. The bill segment period defines the entire period of time covered by a bill segment's charges.
- The consumption period. The consumption period defines the period of time used to calculate the number of days for daily charges.

The consumption period almost always starts one day after the bill segment period. The consumption period always ends on the bill segment's end date. For example, a bill segment period that spans 5-Jan-2002 through 6-Feb-2002 will almost always have a corresponding consumption period of 6-Jan-2002 through 6-Feb-2002. The reason that the start dates don't match is because a bill segment's start date equals the end date of the prior bill segment (i.e., the start date was already counted in the previous bill segment's consumption period and we don't want to count it twice).

The only time when the previous paragraph isn't true is the first bill segment that's produced for a new service agreement. This is because different companies count the first day of a new service agreement differently than others. Refer to [Initial Consumption Period Considerations](#) for examples and an explanation of how you can control the start date of the consumption period.

Ways To Control The End Date Of A Bill Segment

The following points describe the different methods that can be used to define the end date on a service agreement's bill segments:

- **Meter Read Date.** For service agreements with metered consumption (excluding real time meters), the end date is the date of the meter read used on the last day of the bill segment.
- **Bill Period Schedule.** Non-metered service agreements may have the end date of their bill segments defined on the user-maintained bill period calendar. This option is used when bill segments must fall on strict calendar boundaries (e.g., quarterly bills that end on the last day of the quarter).
- **Anniversary.** In addition to the Bill Period Calendar method, non-metered service agreements may have their bill segment end date based on the first day of service. For example, if service started on the 16 th of some month, the ongoing bill segments will start on roughly the 16 th of each month. This option is frequently used to bill for garbage or cable service.
- **ASAP.** For non-meter service agreements that use neither the Bill Period Calendar nor Anniversary methods, the system assumes the end date of a bill segment is the current date. This option is frequently used for service agreements that deal with items (e.g., street lamps, phone booths).
- **Billable Charge.** For non-metered service agreements that exist to levy billable charges, the start AND end dates are defined on the billable charge information that is entered by a user or interfaced from an external system.

The topics in this section discuss each of the above methods.

Using The Meter Read Date Method

A metered service agreement's SA type does not contain a specific indication that the service agreement is used to charge for metered service. Rather, if the system finds metered service points linked to the service agreement, it knows to use a meter read date as the end date of the bill segment.

Using The Bill Period Schedule Method

The bill period schedule method causes the bill segment end date to be calculated using a bill period schedule. The bill period's schedule defines when bill segments are produced and their respective end dates. This method is used when the bill segment needs to fall on strict calendar boundaries (e.g., quarterly bills that end on the last day of the quarter).

The service agreement's SA type indicates if the service agreement uses this method, and if so, the specific bill period whose schedule defines the end dates.

NOTE:

Future and Past End Dates. It's important to be aware that a bill period schedule can be used to generate end dates that are in the future or in the past.

FASTPATH:

For more information about bill periods, refer to [Designing Bill Periods](#).

Using The Anniversary Method

The anniversary date method causes the bill segment end date to be calculated based on the first day of service. For example, if a service agreement started on the 16 th of some month, the ongoing bill segments will start on roughly the 16 th of each month. This method is frequently used to bill for garbage or cable service. When using this method, you also define the applicable billing frequency (i.e., monthly, bi-monthly, quarterly, etc.).

The following table contains the bill periods for a service agreement's starting on 23-Feb-99 that uses a monthly frequency.

Start Date	End Date	Billing Days
23-Feb-99	25-Mar-99	30
25-Mar-99	25-Apr-99	31
25-Apr-99	25-May-99	30
25-May-99	25-Jun-99	31
25-Jun-99	25-Jul-99	30
25-Jul-99	25-Aug-99	31
25-Aug-99	24-Sep-99	30
24-Sep-99	24-Oct-99	30
24-Oct-99	24-Nov-99	31
24-Nov-99	24-Dec-99	30
24-Dec-99	24-Jan-00	31
24-Jan-00	23-Feb-00	30
23-Feb-00	25-Mar-00	31

NOTE:

Future and Past End Dates. It's important to be aware that anniversary billing can generate end dates that are in the future or in the past. The future-option generates the next anniversary date after the current date. The past-option generates the anniversary date that immediately precedes the current date.

The service agreement's SA type indicates if the service agreement uses this method, and if so, the billing frequency.

FASTPATH:

For more information about the SA Type attributes that control this method, refer to [Setting Up SA Types](#).

Using Billable Charges

Bill segments for billable charge service agreements have both their start and end dates defined on the respective billable charge.

FASTPATH:

For more information about billing billable charges, refer to [How To Create A One-Time Invoice](#). For more information about creating a billable charge, refer to [Maintaining Billable Charges](#). For more information about interfacing a billable charge from an external system, refer to [Uploading Billable Charges](#).

The service agreement's SA type indicates if the service agreement uses this method, and if so, the billing frequency.

FASTPATH:

For more information about the SA Type attributes that control this method, refer to [Setting Up SA Types](#).

Preventing Short Bill Segments

Every SA type contains an attribute defining the minimum number of days on a bill segment. Whenever the system attempts to create a bill segment other than the final bill segment, it checks if the number of days is at least as great as the minimum. If not, the bill segment will not be created as part of this bill run. Rather, the system waits until the number of days in the bill segment is at least as large as the minimum. This is true for all methods of bill duration calculation.

Prorating Charges When a Rate is Applied

It is possible for some of the prices that appear on a bill segment to change during the course of the bill period.

FASTPATH:

Refer to [Effective Dates & Price Proration](#) for more information about how charges are prorated during rate application.

Batch Billing

99.9% of all bills are created by the batch billing background process BILLING and require no human intervention before they can be finalized and sent to a customer. The other 0.1% are created by users on-line / real time. This section discusses several important concepts associated with batch billing. If your implementation requires processing of data by CIS Division the BILLING background process provides an optional parameter that allows a CIS Division to be specified as an input parameter.

This process has an optional input parameter for CIS Division. It can be used if you implementation requires processing of data by CIS Division. You will need to create a copy of this process's batch control for each CIS Division.

Window Billing And The Bill Cycle Schedule

FASTPATH:

Refer to [The Cyclical Billing Process & Window Billing](#) for more information about how an account's bill cycle dictates when a customer is billed.

Confirming A Batch Of Bills Before Completing Them

If you're implementing new rates or if something unusual is being introduced that affects billing, you may want to turn off the bill cycle schedule's Freeze and Complete switch. If this switch is off, the system creates bills, it just doesn't freeze and complete them. You can then review the entire batch of bills to make sure they're clean.

- If you find the bills are wrong, correct the source of the error and rerun the bill cycle. The system will remove all incomplete bills and then reproduce them using the corrected information in the system.
- If you find the bills are correct, turn the Freeze and Complete switch on and rerun the cycle. The system will remove all incomplete bills and then reproduce them. Assuming nothing changed, the bill amounts will be the same.

FASTPATH:

Refer to [Setting Up Bill Cycle Schedules](#) for more information.

Canceling A Batch Of Bills After They're Complete

If you need to cancel an entire batch of bills because they were created using faulty data (e.g., the wrong tax rate was defined in the rate), you can. A background process (MASSCNCL) exists for this purpose.

This background process will cancel all the frozen bill segments for the latest run of a given bill cycle's schedule. Optionally, you can cancel bills for a given bill date within the bill cycle's schedule. The cancel reason used on the bill segment is the one marked as the bill cancel reason for mass cancel. Refer to [Setting Up Bill \(Segment\) Cancellation Reasons](#) for more information.

When the cycle is billed again, new bill segments will be created, and the original bill segments and the cancellations will automatically be hidden from the customers.

Reopening A Batch Of Bills After They're Complete

If you need to reopen an entire batch of bills because they were completed prematurely (e.g., payments did not get posted before billing ran, so recent payments were not reflected in the account balances), you can. A background process (MASSROBL) exists for this purpose.

This background process will reopen all the bills for a given bill date for the latest run of a given bill cycle's schedule.

Fixing Errors Detected In Batch Billing

If an "error" bill segment is created by the batch billing process, the system attempts to fix the offending segment each night by regenerating it using the information that exists at that time. Therefore, if the cause of the error is fixed during the day, the system will automatically regenerate the bill segment when batch billing next runs; you don't have to manually correct each bill. And, once a bill is error-free, it will be completed and sent to the customer.

IMPORTANT:

Automatic regeneration only works during the account's bill window. If an "error" bill segment is not successfully regenerated on the last night of the account's bill cycle, it will remain in error until the next time the account's cycle runs (unless a user corrects it real time). At that time, the system will generate another bill error indicating the prior bill segment is in error (and then there'll be two bill segments in error).

Completing Pending Bills

If you need to complete pending bills created by the batch billing process, you can. A background process (C1-BLCMP), exists for this purpose.

This background process will complete all pending bills on a given bill date for a given bill cycle's schedule. This process does not delete and regenerate freezable bill segments linked to pending bills.

FASTPATH:

Refer to [Bill Errors](#) for more information.

Billing Financial Transaction Considerations

The topics in this section provide information about the financial impact of a bill segment.

Billing - Current Balance versus Payoff Balance

A bill segment's financial transaction affects a service agreement's payoff balance and/or current balance. In this section, we describe these two balances.

WARNING:

If you do not understand the difference between payoff balance and current balance, refer to [Current Amount versus Payoff Amount](#).

When Current Balance Equals Payoff Balance

For most service agreements, payoff balance and current balance are always the same (or in colloquial speech - the amount the customer thinks they owe equals what they really owe). Let's run through a typical example. The values in the payoff balance and current balance columns reflect the amount due after the financial transaction has been applied (i.e., the running balance):

Date	Financial Transaction	Payoff Balance	Current Balance
1-Jan-99	Bill: \$125	125	125
15-Jan-99	Payment: \$150	-25	-25
2-Feb-99	Bill: \$175	150	150
14-Feb-99	Payment: \$150	0	0
3-Mar-99	Bill: \$200	200	200
15-Mar-99	Payment: \$150	50	50
2-Apr-99	Bill: \$225	275	275

As you can see, payoff balance and current balance are always in sync.

When Current Balance Differs From Payoff Balance

For some service agreements, payoff balance and current balance differ (or in colloquial speech - the amount the customer thinks they owe differs from what they would owe if they wanted to pay off their account).

Let's run through an example of a customer on a budget to illustrate a classic service agreement where these two balances are not the same. The values in the payoff balance and current balance columns reflect the amount due after the financial transaction has been applied:

Date	Financial Transaction	Payoff Balance	Current Balance
1-Jan-99	Bill: \$125, Budget \$150	125	150
15-Jan-99	Payment: \$150	-25	0

2-Feb-99	Bill: \$175, Budget \$150	150	150
14-Feb-99	Payment: \$150	0	0
3-Mar-99	Bill: \$200, Budget \$150	200	150
15-Mar-99	Payment: \$150	50	0

The following table describes the various types of service agreements where these balances may differ.

Type Of Service Agreement	What Payoff Balance Holds	What Current Balance Holds
Deposit	Payoff balance holds the amount of deposit you are holding on behalf of the customer's debt. This amount is showed as a credit (with a negative sign) because you truly owe the customer this money.	Current balance holds the amount the customer owes for a deposit.
Charitable contribution	N/A - charitable contribution service agreements never have a payoff balance.	Current balance holds the amount the customer owes for a charitable contribution.
Payment arrangements	Payoff balance holds the total amount of delinquent debt that remains unpaid. When a payment arrangement is started, you transfer the payoff balance from the utility service agreement to the payment arrangement service agreement. Each billing period, the customer pays down this balance.	Current balance holds the amount the customer owes in respect of the billed payment arrangement amounts.
Service agreements on a budget plan	Payoff balance holds the actual amount owed (actual bills minus payments).	Current balance holds the amount the customer owes in respect of the billed budget amount.

Bill Segment Type Controls Which Balance(s) Are Affected

Every bill segment references a bill segment type (the bill segment type comes from its service agreement's SA type). The bill segment type controls how payoff balance and current balance are affected by the bill segment amount. It also controls the algorithm used by the system to calculate the bill segment's bill lines.

FASTPATH:

Refer to [Designing and Defining Bill Segment Types](#) for more information about how bill segment type affects how a bill segment is produced and how its financial transaction is generated.

The Source Of GL Accounts On A Bill Segment's Financial Transaction

A bill segment's financial transaction also contains the double-sided accounting entry that defines how the bill segment affects the general ledger.

FASTPATH:

Refer to [The Source Of GL Accounts On Financial Transactions](#) for a description of where the system extracts the distribution codes used to construct the GL accounts.

Determining the Statistical Quantity

The statistical quantity for each general entry line in the financial transaction is populated by adding together the statistical quantity for all bill calculation lines for the same distribution code. The bill calculation line indicates a statistical quantity if its corresponding calculation rule has marked the GL statistical quantity setting.

The statistical quantity for a bill calculation line is the prorated billable quantity for that line.

- If the corresponding calculation rule for the bill calculation line is not marked **measures peak**, then the statistical quantity corresponds to the billable quantity for the bill line. This is because billable quantities for SQs that do not represent a peak quantity are prorated when applying the rate.
- If the corresponding calculation rule for the bill calculation line is marked **measures peak**, then the statistical quantity may not correspond to the billable quantity for the bill calculation line. SQs that measure peak are not prorated when applying the rate. However, when determining the statistical amount to send to the general ledger, the quantity is prorated in the same manner as quantities that do not measure peak amounts.

NOTE:

Bill Calc Line Statistical Quantity. The statistical quantity for each bill calculation line is calculated when generating the bill segment and used to populate the statistical quantity for the FT GL entry. The calculated value is not saved in the bill calc line record.

The Source Of Bill Routing Information

When a bill is completed, the system creates a [bill routing](#) for each person linked to the account who receives a copy of the bill. The bill routing record contains the information that controls how, where and to whom a bill is sent.

The following points describe how this works:

- Each person who receives a copy of an account's bill is listed on the [account's person information](#).
- A [bill routing](#) is created for each such person when the bill is completed.
- The information that appears on the bill routing record is controlled by the **bill route type** specified on the respective account / person information.
- If the bill route type's routing method is email or fax and the system has been configured to use notification preferences for bill routing, a bill routing is created for each active contact preference whose notification type is associated with the **bill route type** specified on the respective account/person information ; otherwise, bill routings are created as follows:
 - If the bill route type indicates the person's bills are routed via fax, the "address line 1" address constituent is populated with the person's fax number. The system knows which of a person's person contacts is a fax number is by the contact routing or which of a person's phone numbers is a fax number by the phone type.. If person contacts are used, the primary fax is selected. If phone is used and the person has multiple fax numbers, one is selected at random.
 - If the bill route type indicates the person's bills are routed via email, the "address line 1" address constituent is populated with the person's [Email address](#). The system knows which of a person's person contacts is an email or knows where to find the person email. If person contacts are used, the primary email is selected.
- If the bill route type indicates the person's bills are routed via the postal service, the address constituents are populated with the address specified on the [account / person's bill address source](#). Note, if the person has a [seasonal address](#) effective on the business date, the seasonal address will be used regardless of the value of **bill address source**.

FASTPATH:

Refer to [Printing Bills](#) and [How To Reprint A Bill \(For The Original Recipients or For Someone New\)](#) for more information. Refer to [Account - Person Information](#) for information regarding how to control who receives a copy of a bill, where the bill is sent, and how the bill is formatted.

Bill Messages

The topics in this section describe how messages are linked to a bill and bill segment.

The Source Of Bill Messages

When a bill is completed, the system sweeps bill messages from the following sources onto the bill.

NOTE:

Bill or Bill Segment Messages. Bill messages will be linked either to the bill or to one its bill segments depending on the source of the bill message code. In other words, messages associated with a service agreement (directly or indirectly) will be linked to the bill segment; messages associated with an account (directly or indirectly) will be linked to the bill.

- All permanent and temporary bill messages linked to an account are linked to the bill when it is completed. Refer to [Account - Bill Messages](#) for more information. Note well that all temporary bill messages are removed from the account when they are swept onto a bill (a temporary message is swept onto the next bill produced for the account).
- The system checks if the bill's account's customer class has bill messages. If so, it links all such messages that are effective on the bill date to the bill when it is completed. Refer to [Setting Up Customer Class Bill Messages](#).
- All permanent and temporary bill messages linked to service agreements that contributed bill segments to the bill are linked to their respective bill segment when the bill is completed. Refer to [Service Agreement - Miscellaneous](#) for more information. Note well that all temporary bill messages are removed from the service agreement when they are swept onto a bill segment (a temporary message is swept onto the next bill segment produced for the service agreement).
- The system checks if each bill segment's rate has bill messages. If so, it links all such messages that are effective on the bill segment's start date to the bill segment when the bill is completed. Refer to [Defining Calculation Rules](#) for more information.
- The system checks if the service provider associated with each sub bill segment has bill messages. If so, it links all such messages that are effective on the bill segment's start date to the bill segment when the bill is completed. Refer to [Service Provider - Bill Messages](#).

In addition, a user may manually add an [ad hoc message to a bill](#).

And finally, you can develop your own background processes and algorithms that add bill messages to accounts, service agreements, bills and/or bill segments. Refer to [Substituting Field Values Into A Bill Message](#) for examples.

Substituting Field Values Into A Message

Many bill messages contain static text (i.e., the message is the same on every bill). However, the system supports messages whose contents are dynamic. For example, consider the bill message Thank you for your charitable contributions in 2000 for \$123.12, please keep this bill for tax purposes. This message contains two substitution values (the year and the amount) as is therefore considered dynamic.

Dynamic messages can be implemented as follows:

- Create a bill message code whose Message on Bill contains substitution values. For example, the bill message code to produce the message illustrated above would contain the following Message on Bill - Thank you for your charitable contributions in %1 for %2, please keep this bill for tax purposes.
- Use either of the following methods to link the message code and its substitution parameters to the bill:
 - Create a background process or algorithm to insert a permanent or temporary bill message on the appropriate accounts. Then, when an account's bill is next completed, the system will sweep the message (and its substitution parameters onto the bill).
In addition to inserting the appropriate bill message code, your background process / algorithm must also insert the appropriate substitution values. The name of the table in which account messages are inserted is **CI_ACCT_MSG**. The name of the table in which a message's substitution values are inserted is **CI_ACCT_MSG_PRM** (you will insert one row for each substitution field).

Please see the background process (REACH) for an example of a background process that performs this type of function. Please see the algorithm identified by DEP PIF MSG for an example of an algorithm that performs this type of function.
 - Rather than adding the dynamic message to account (and then letting the bill completion logic transfer the account message to the bill), you could construct a bill completion algorithm that adds the message code and substitution values on the bill (during bill completion). The name of the table in which bill messages are inserted is **CI_BILL_MSGS**. The name of the table in which a message's substitution values are substituted is **CI_BILL_MSG_PRM** (you will insert one row for each substitution field).

A Bill May Affect More Than Just Customer Balances

The topics in this section provide information about obscure things that may happen when a bill is created, frozen, or canceled.

Auto Cancel / Rebill If A Service Agreement Is Stopped Retroactively

If the system detects a bill segment with a bill date after the stop date of the service agreement (because the service agreement was retroactively stopped), the system automatically cancels the bill segment and creates a new one with an end date equal to the service agreement's stop date.

Cancel Historical, Estimated Bill Segments When a Real Read Is Found

A special plug-in spot exists on bill segment type that can be used to automatically cancel historical, estimated bill segments when a “real” read is used on the current bill. This plug-in spot is invoked only when an excessive read (the prior read is more than the current read) situation is detected.

If you wish that the spot be invoked all the time and not only when an excessive read situation is encountered, you must setup the *Always Call Auto Cancel* option type of the *Financial Transaction Options Feature Configuration*. You will normally do this if you want the type of readings to be the basis of the auto cancellation. For example, you want to cancel estimated bills and rebill distributing usage more accurately across a tiered rate.

These algorithm would typically be specified on bill segment types that calculate bills using meter reads.

NOTE:

This plug-in spot is typically used on bill segment types that calculate bills using meter reads. It is typically not used when usage is requested from Oracle Utilities Meter Data Management.

This algorithm is called by the system when creating bills in batch. It does not get called when a user creates a bill online.

Deposits May Be Refunded

FASTPATH:

Refer to [Refunding Deposits](#) for how deposits may be refunded when a deposit service agreement is "final billed".

FT Freeze Repercussions

FASTPATH:

Refer to [Obscure Things That Can Happen](#) for more information about things that can happen when an FT is frozen (and FT's get frozen during billing).

Budget Billing

The topics in this section provide background information about a variety of budget billing issues.

FASTPATH:

We strongly recommend familiarizing yourself with the topics described in [Designing and Defining Budget Plans](#) to fully appreciate how budgets fit into the system's financial architecture.

Account versus Service Agreement

Customers who pay on a budget plan tend to believe that there is one budget amount applied to their account's bill each month. This is not true. Rather, each service agreement has an individual budget amount (stored in the recurring charge array). The sum of an account's service agreements' budget amount is the account's budget amount.

Why does each service agreement have a unique budget amount? Because all financial accounting in the system is performed at the service agreement level, not for an entire account.

While a unique budget amount is defined for each service agreement, a user can use a simple page to view and change the budget amount for all eligible service agreements linked to an account.

It's important to be aware that some service agreements linked to an account may not be eligible for budget plans. For example, assume you have a customer with a deposit service agreement and one or more utility service agreements. This customer will be billed for their deposit regardless of the utility service agreements' budget amounts. You define whether a service agreement may participate in a budget plan on the service agreement's SA type.

How To Set Up A Customer To Participate In A Budget Plan

If a customer wants to participate in a budget billing plan, simply transfer to [Account - Budget](#) and generate a new budget for the customer.

The Financial Impact Of Budget Plans

The only difference between a customer who participates in budget billing and one who doesn't is that budget billing customer have bill segments where payoff amount differs from current amount. Why? Because the payoff amount is the actual amount of the bill. The current amount is the amount the customer is expected to pay (i.e., their budget amount).

Let's run through an example of a customer on a budget to illustrate a service agreement where these two balances are not the same. The values in the payoff balance and current balance columns reflect the amount due after the financial transaction has been applied:

Date	Financial Transaction	Payoff Balance	Current Balance
1-Jan-99	Bill: \$125, Budget \$150	125	150
15-Jan-99	Payment: \$150	-25	0
2-Feb-99	Bill: \$175, Budget \$150	150	150
14-Feb-99	Payment: \$150	0	0
3-Mar-99	Bill: \$200, Budget \$150	200	150
15-Mar-99	Payment: \$150	50	0

FASTPATH:

For more information about current and payoff amounts, refer to [Current Balance versus Payoff Balance](#).

Budget Billing Background Processes

The topics in this section describe the background processes that automate management of customer who participate in budget billing plans.

NOTE:

Budget Processing. The budget background processes only calculate budget amounts for pending start, active and pending stop SAs whose start and end date (if any) includes the budget date. Additionally, the budget date is used to select the rate schedule that is in effect for an SA if estimating consumption is necessary.

Budget True Up

The Budget True Up background process (BUDTRUP) examines all accounts who participate in budget billing plans. If enough time has passed since the customer's budget was last trued up, the system will calculate the account's recommended budget amount. If the recommended amount differs from their existing budget amount by more than a given tolerance percentage, the customer's budget amount (actually, the recurring charge amount on the account's service agreements) will be changed.

FASTPATH:

The amount of time between true ups and the true up method used to true up is defined on the account's budget plan. The tolerance percentages are defined as parameters of the true-up algorithm that is plugged in on the account's budget plan. Refer to [Designing and Defining Budget Plans](#) for all the details.

Budget Monitor

The Budget Monitor background process (BUDMON) examines all accounts that participate in budget billing plans. If the account's existing budget amount is out-of-sync with predefined tolerance percentages, the system will highlight the account on the [Budget Review](#) page.

FASTPATH:

The tolerance percentages are defined as parameters of the budget monitor algorithm that is plugged in on the account's budget plan. Refer to [Designing and Defining Budget Plans](#) for all the details.

Canceling A Budget

The following points describe when a budget is cancelled:

- A user can cancel a budget at any time by using the Cancel Budget action on the [Account - Budget](#) page.
- The system may cancel a budget during a collection process (if the collection process contains a Cancel Budget collection event). Refer to [Types Of Collection Events](#) for more information.
- When a service agreement is [stopped](#), the system automatically cancels the budget.

When a customer's budget is cancelled, the following events transpire:

- Any recurring charge entry whose effective date is after the cancel date is deleted. This is possible if you are entering a back-dated stop date for the service agreement. For example, perhaps you run the [Budget True Up](#) process, which adds a new budget amount to the service agreement (effective today). Then imagine that the customer calls you and informs you that they moved out last week. If you stop the customer's service as of last week, the recurring charge effective today is deleted when the stop is finalized.
- A new recurring charge amount of zero is created for each of the customer's service agreement.
- Each service agreement's current balance is synchronized with its payoff balance (using the sync adjustment code defined on the service agreement's SA type).

Net Energy Metering

The topics in this section provide background information on net energy metering.

What Is Net Energy Metering?

Customers in a distributed generation energy market may have renewable energy devices such as solar panels or wind turbines connected to their meters. The energy generated at this service point, as well as any energy used, could possibly be measured by a single meter, with the energy generated being netted against the energy used. This is called net energy metering (NEM). The meter records a positive number when customers use more energy than they generate, and a negative number when they generate more than they consume. These customers may owe a minimum charge each month. Their actual energy charges and generation credits are accrued until the account is adjusted at the end of a specified period, called the true up period. When the account is trued up, the consumption charges and generation credits for the period are combined to determine if the customer owes money to the utility.

Net Energy Metering Service Agreements

As mentioned in the previous section, net energy metering (NEM) customers typically owe a minimum charge each month while their actual energy charges and generation credits are accrued until true up time. This is accomplished by setting up a master service agreement (SA) to hold the monthly minimum charge and a sub service agreement to hold the customer's actual energy charges and generation credits.

For more information about service agreement relationships, refer to [Defining SA Relationship Options](#).

Net Energy Metering True Up

To facilitate the true up process, each true up period will be represented by a sub service agreement. Each sub service agreement will be monitored by a true up monitor (TUM), a service task which is responsible for: performing the true up process at the end of the true up period; reversing true up transactions when cancel/rebills affect a period that has been trued up; synchronizing itself with any changes on its master service agreement or service agreement relationship (e.g., if the service agreement relationship is deleted, the true up monitor will cancel itself); and creating the service agreement relationship and sub service agreement for the next true up period.

A service agreement creation algorithm on the master service agreement type is responsible for creating the initial sub service agreement and service agreement relationship. Subsequent sub service agreements are created in the true up monitor lifecycle. A service agreement creation algorithm on the sub service agreement type is responsible for creating the true up monitor. A link to the true up monitor service task is available from the characteristics page of the sub service agreement. It is important to note that the true up monitor is not a user-maintained object. End-users will not normally need to access the true up monitor. All that is visible on the true up monitor is its type, status, related sub service agreement and account. As always, relevant financial history will be accessible from the sub service agreement.

The Lifecycle of a True Up Monitor

The following diagram shows the lifecycle of the True Up Monitor business object:

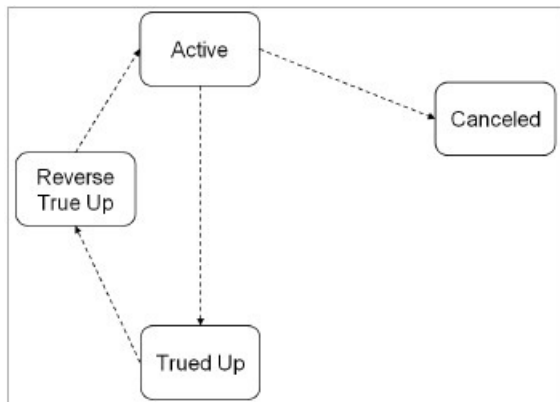

Active State: The true up monitor starts out in the Active state. Here the true up monitor is evaluated for true up processing or possible cancellation. The system will perform a true up if either the true up period has come to an end, or the service agreement is final billed.

The amount of time between true ups is defined on the true up task type. See [Setting Up the System for Net Energy Metering](#) for a description of how true up task types are configured.

Canceled State: The true up monitor is transitioned to the Canceled state if its service agreement is canceled or deleted. Because the service agreement associated with a true up monitor is a sub service agreement, it is possible that the stop date on the sub service agreement is backdated to a point prior to the start of its associated service agreement relationship. In this case, the true up monitor is also canceled.

Trued Up State: If it is time for true up, the true up monitor is transitioned to the Trued Up state. True up processing involves summing the sub service agreement's bill segments to see if the customer owes any debt (i.e., the energy they generated was not enough to cover the energy they consumed). If the sum is positive, the amount is transferred to the master service agreement for the customer to pay off. If the sum is negative, the sub service agreement balance is brought to zero (the utility keeps the credit). If your implementation wants to issue refunds to customers who generate more energy than they consume, you will need to design your own algorithm for the true up process.

The adjustment types used to transfer or zero out the sub service agreement balance are defined on the true up monitor type. See [Setting Up the System for Net Energy Metering](#) for a description of how true up monitor types are configured.

Reverse True Up State: Once the financial true up is done, a new service agreement relationship and sub service agreement are created for the subsequent true up period. If cancel/rebills occur after the true up process has been performed, the true up monitor is transitioned to the Reverse True Up state. Any adjustments that were previously created are canceled as part of this processing. Thereafter the true up monitor is transitioned back to the Active state, where it waits until bill completion attempts another true up.

Setting Up the System for Net Energy Metering

This section summarizes the various tasks required for setting up your system for net energy metering.

Adjustment Types

The following adjustment types are used at true up time:

- **Current Balance True Up.** This is the adjustment type used in syncing the payoff and current amounts on the sub service agreement associated with the true up period. This adjustment type should reference an FT algorithm of **Payoff Amount = 0 / Current Amount = Adj Amount (no GL)**.
- **Transfer To Master.** This is the adjustment type used to transfer the customer's balance from sub service agreement to master service agreement if a positive payoff balance exists on the sub service agreement after true up.
- **Write Down.** This is the adjustment type used to bring the payoff balance of the sub service agreement to zero if a negative payoff balance exists after true up.

Adjustment Type Profile

Create an adjustment type profile that references the adjustment types used in net energy metering billing.

True Up Task Type

To enable billing for net energy metering, your implementation must configure a **True Up Task Type**. This service task type captures the various configuration options that are used by the true up monitor's algorithms:

- **Minimum Days In True Up Period** defines the minimum number of days covered by the bill segments within a true up period before true up processing can occur
- The task type captures the adjustment types used at true up time
- **Reversal Adjustment Cancel Reason** is used on true up adjustments that are canceled as a result of cancel/rebill activity occurring after a true up

Algorithms

Add the following algorithms:

- The sub service agreement and service agreement relationship are initially created by an **SA Creation** algorithm on the master service agreement type. The base package provides algorithm type C1-SAT-SARL for this purpose. An algorithm should be configured with the service agreement relationship type to use.

- Creation of the true up monitor is handled by an **SA Creation** algorithm on the sub service agreement type. The base provides algorithm type C1-SAT-TUM for this purpose. The true up monitor service task type is defined as an algorithm parameter.
- Whenever a net energy metering sub service agreement is canceled, its associated true up monitor should also be canceled. The base provides algorithm C1-CNC-TUM to be plugged in as an **SA Cancel** algorithm on the sub service agreement type to accomplish this.
- The true up monitor is transitioned out of the Active or Reverse True Up state by the billing process. To that end, a **Bill Completion** algorithm needs to be configured on the master service agreement type. This algorithm is responsible for transitioning any true up monitor that is in an Active or Reverse True Up state that is related to the master service agreement. The base provides the algorithm C1-TRN-TUM for this purpose.
- When cancel/rebills occur, financial transactions related to the true up need to be reversed. To accomplish this, an **FT Freeze** algorithm must be plugged in on the sub service agreement type. The base provides algorithm C1-RV-TRUP for this purpose.

For more information on setting up service agreement Relationships, refer to [Defining SA Relationship Options](#). For more information on service agreement type algorithms, refer to [SA Type - Algorithms](#).

Your implementation must also decide if the sub service agreement's bill segment financial transactions should impact the general ledger or not. This is controlled by the **Financial Algorithm** on the bill segment type defined for the sub service agreement type. The base provides algorithms C1-C0-GL and C1-C0-NOGL for this purpose. For more information on configuring Bill Segment Types, refer to [Designing and Defining Bill Segment Types](#).

Net Energy Metering Billing Examples

This section contains billing examples for net energy metering. The examples assume the following:

- The customer is billed quarterly using the following tariff:
 - Customer charge of \$3/day (billed on master service agreement)
 - \$0.10 per kWh (billed on sub service agreement and trued up after 12 month period)
- The GL Accounting distribution codes used in the following tables, such as A/R-NEM and NEM-Liability, are for example only. Your implementation will specify its own distribution codes.
- A True Up Task Type that references the base product NEM business objects with the following configuration:
 - **Minimum Days In True Up Period:** 365
 - **Sync Current Adjustment Type:** NEM SYNC
This is the adjustment type used to synchronize (make equal) the sub service agreement's current amount with the payoff amount at true up time.
 - **Transfer Adjustment Type:** NEM XFER
This is the adjustment type used to transfer debt from the sub service agreement to the master service agreement at true up time.
 - **Write Down Adjustment Type:** NEM WDOWN
This is the adjustment type used to write down any remaining amount on the sub service agreement after we attempt to transfer debt to the master service agreement at true up time.

Example 1: Customer Consumes More Than They Generate

The following table outlines the customer's master service agreement financial transactions in 2010. Adjustments created in the true up period are in bold. In this example the customer's net energy results in an outstanding balance of \$330 which is transferred from the sub service agreement to the master service agreement, leaving the sub service agreement for that true up period with a zero balance.

Event	GL Accounting	Effect On Payoff Amount	Effect On Current Amount	Payoff Balance	Current Balance
Bill Segment (1/1–3/31) (90 days * \$3/day = \$270)	A/R-NEM 270 NEM-Liability <270>	270	270	270	270
Payment	Cash 270 NEM-A/R <270>	-270	-270	0	0
Bill Segment (4/1–6/30) (91 days * \$3/day = \$273)	A/R-NEM 273 NEM-Liability <273>	273	273	273	273
Bill Segment (7/1–9/30) (92 days * \$3/day = \$276)	A/R-NEM 276 NEM-Liability <276>	276	276	549	549
Payment	Cash 549 A/R-NEM <549>	-549	-549	0	0
Bill Segment (10/1–12/31) (92 days * \$3/day = \$276)	A/R-NEM 276 NEM-Liability <276>	276	276	276	276
NEM XFER true up adjustment (transfer from sub service agreement)	A/R-NEM 330 XFER <330>	330	330	606	606

The following table outlines the customer's sub service agreement financial transactions (FTs). Note that bill segment financial transactions affect the customer's pay off balance only. Adjustments created in the true up period are in bold below and reflect the following:

- First, the current balance to the payoff balance is set using the sync adjustment type (NEM SYNC) on the service task type.
- Second, any debt from the sub is transferred to the master service agreement using sync adjustment type on the service task type (NEM XFER).

Event	GL Accounting	Effect On Payoff Amount	Effect On Current Amount	Payoff Balance	Current Balance
Bill Segment (1/1–3/31) (1200kWh * \$0.10 = \$120)	A/R-NEM 120 NEM-Liability <120>	120	0	120	0
Bill Segment (4/1–6/30) (500kWh * \$0.10 = \$50)	A/R-NEM 50 NEM-Liability <50>	50	0	170	0
Bill Segment (7/1–9/30) (600kWh * \$0.10 = \$60)	A/R-NEM 60 NEM-Liability <60>	60	0	230	0
Bill Segment (10/1–12/31) (1000kWh * \$0.10 = \$100)	A/R-NEM 100 NEM-Liability <100>	100	0	330	0

Event	GL Accounting	Effect On Payoff Amount	Effect On Current Amount	Payoff Balance	Current Balance
NEM SYNC adjustment (sync current to payoff)	n/a	0	330	330	330
NEM XFER adjustment (transfer to master service agreement)	XFER 330 A/R-NEM <330>	-330	-330	0	0

Example 2: Customer Generates More Than They Consume

The following table outlines the customer's master service agreement financial transactions (bill and payment segments are exactly the same as in example 1 above). In this example the customer's net energy results in a credit balance on the NEM sub service agreement which is written off, leaving the sub service agreement for that true up period with a zero balance (credits are not transferred to the master service agreement).

Event	GL Accounting	Effect On Payoff Amount	Effect On Current Amount	Payoff Balance	Current Balance
Bill Segment (1/1–3/31) (90 days * \$3/day = \$270)	A/R-NEM 270 NEM-Liability <270>	270	270	270	270
Payment	Cash 270 A/R-NEM <270>	-270	-270	0	0
Bill Segment (4/1–6/30) (91 days * \$3/day = \$273)	A/R-NEM 273 NEM-Liability <273>	273	273	273	273
Bill Segment (7/1–9/30) (92 days * \$3/day = \$276)	A/R-NEM 276 NEM-Liability <276>	276	276	549	549
Payment	Cash 549 A/R-NEM <549>	-549	-549	0	0
Bill Segment (10/1–12/31) (92 days * \$3/day = \$276)	A/R-NEM 276 NEM-Liability <276>	276	276	276	276

The following table outlines the customer's sub service agreement financial transactions (FTs). Note that bill segment financial transactions affect the customer's pay off balance only. Adjustments created in the true up period are in bold below and reflect the following:

- First, the current balance is set to the payoff balance using the sync adjustment type (NEM SYNC) on the service task type.
- Because a credit remains on the sub service agreement, this amount will be written off using the write down adjustment type on the service task type (NEM WDWN).

Event	GL Accounting	Effect On Payoff Amount	Effect On Current Amount	Payoff Balance	Current Balance
Bill Segment (1/1–3/31) (80kWh * \$0.10 = \$8)	A/R-NEM 8 NEM-Liability <8>	8	0	8	0
Bill Segment (4/1–6/30)	A/R-NEM <12> NEM-Liability 12	-12	0	-4	0

Event	GL Accounting	Effect On Payoff Amount	Effect On Current Amount	Payoff Balance	Current Balance
(-120kWh * \$0.10 = \$-12)					
Bill Segment (7/1–9/30)	A/R-NEM <8> NEM-Liability 8	-8	0	-12	0
(-80kWh * \$0.10 = \$-8)					
Bill Segment (10/1–12/31)	A/R-NEM 10 NEM-Liability <10>	10	0	-2	0
(100kWh * \$0.10 = \$10)					
NEM SYNC true up adjustment (sync current to payoff)	n/a	0	-2	-2	-2
NEM WDOWN true up adjustment (write down credit)	NEM A/R 2 E - W/O <2>	2	2	0	0

For more information about current and payoff amounts, refer to [Billing - Current Balance versus Payoff Balance](#).

Using Billable Charges for Pass Through / Convergent Billing

The term "pass through" billing is used to describe the practice of receiving charges calculated by third parties and presenting them on the customer's bill along with your own charges. "Pass through" billing is implemented in the system using [Billable Charges](#).

The following points provide information to help you decide the most appropriate way to implement "pass through" billing given your specific requirements:

- Customers with pass through charges will need a separate service agreement to hold the pass through charges. We refer to this type of service agreement as a "billable charge" service agreement.

NOTE:

A service agreement's SA type controls whether a service agreement can have billable charges linked to it. Specifically, the SA type must have a "special role" of Billable Charge.

- A billable charge service agreement holds the billable charges until the customer is next billed. At that time, a separate bill segment will be created for each unbilled billable charge linked to the billable charge service agreement.
- While it is not required, we recommend creating a separate billable charge service agreement for each type of pass through charge. For example, if you can receive "pass through" charges from the local water company and the local cable company, we'd recommend having two billable charge service agreements for each customer.
- As described under [We Bill For Them](#), you can setup the system to automatically create billable charge service agreements when you start regular service for your customers. If you take this approach, you can also have the system create the payable transaction to pay the 3rd party. Refer to [Pay At Bill Time vs. Pay At Pay Time](#) for more information.
- You can interface billable charges using the [Billable Charge Interface](#). The interfaced charges can consist of any of the following:
 - Pre-calculated bill lines that will be presented "as is" to the customer.
 - Service quantities that are used by the system to calculate the charges on behalf of the third party. For example, the 3rd party may pass through the number of kilowatt-hours and you calculate the bill lines for them. Refer to [Uploading Consumption Rather Than Bill Lines](#) for more information.

- Meter read details that you want printed on the bill. Note, the base package bill segment creation algorithm (BSBS-BC) simply sweeps billable charge read details onto the related [bill segment's read detail](#). This algorithm does NOT use these reads to derive service quantities. This is intentional as most implementations that import reads also import service quantities and therefore deriving service quantities is unnecessary (and also error prone). If your implementation needs to derive service quantities from these reads, you can develop your own bill segment creation algorithm to do just this.
- All of the above. You might interface both bill lines and service quantities if the third party calculated the charges but did not calculate the taxes. The dollar amount for which taxes will be calculated would be defined using a service quantity. Refer to [Calculating Taxes On Uploaded Charges](#) for more information.

NOTE:

- The bill lines on a billable charge can fit into any of the following categories:
- Memo-only (i.e., don't affect the general ledger). A bill line that is memo-only contain information that is purely informational. For example, the 3rd party might pass the start and end meter reads that they used to calculate the charges. You can use memo-only bill lines to show this information on the customer's bill. If a bill line is not memo-only (i.e., it affect the general ledger), a distribution code must also be specified to define how the lines affects the general ledger.
- Show on the customer bill. It is possible to create bill lines that affect the general ledger, but are not shown on the customer's bill. This is an unusual practice, but it happens.
- Summary / detail. Each bill line has an indication of whether it is a summary or detail line. This only impacts bill presentation.

NOTE:

The above indicators can be defaulted onto a billable charge line by using [Billable Charge Line Types](#) when you interface the lines into the system.

-
- Characteristics (i.e., user-defined fields) can be associated with billable charge lines. You might populate this information if you are interfaced information that may be useful during bill presentation or for reporting purposes.
 - If service quantities are specified on a billable charge, they are saved on the bill segment created when the billable charge is billed. This means that they system can support creation of a graph of historical usage on the bill, as well as other queries on customer usage. In addition, it might be possible to event estimate consumption based on these service quantities (but such a plug-in is not supplied with the base package).

NOTE:

The system does not support passing in items (e.g., street lamps). This could be a problem if you need to perform ratable calculations for the 3rd party based on, say, the number of street lights. However, if you require ratable, street light pass through billing, you can calculate a service quantity for each type of street light and save this information on the billable charge. The associated rate would then have a price per service quantity rather than a price per item type.

The system does not support sending in raw meter reads with billable charges. This consumption needs to be passed in as a service quantity. However, you can pass in meter read details to be printed on the bill segment.

-
- Cancel / rebill for billable charges is quite different than for normal bill segments. A billable charge bill segment can be cancelled, and this will reverse the financial effects of the billable charge. But without new information from the source, there is no way to rebill the customer. Therefore, if the original charges were incorrect, the source system would send both a reversal of the charges and a newly revised set of information. These could be passed as two separate billable charges or they could combined on a single billable charge.
 - In terms of the customer information setup, while a service agreement that holds billable charges does not need a service point, there are advantages to having this information in the system. For one thing, if jurisdictional taxes are being calculated by the system, the definition of the jurisdiction(s) is held on the service point or premise. Also, the link to the service point defines the service address, facilitates customer lookup, causes information to appear in Control Central's trees, etc.

- For most other functionality, the billable charge service agreement supports the same functionality as normal service agreements. This includes budget billing, payment distribution, credit & collection tracking and events, current & payoff balances, movement of old debt onto payment arrangements, etc.

FASTPATH:

For more information about billing billable charges, refer to [How To Create A One-Time Invoice](#). For more information about creating a billable charge, refer to [Maintaining Billable Charges](#). For more information about creating sub service agreements to hold billable charges, refer to [We Bill For Them](#). For more information about interfacing a billable charge from an external system, refer to [Uploading Billable Charges](#).

Printing Bills

The contents of this section describe the technical implementation of both an online and batch bill production.

Bill Routings Are Created For Each Recipient Of A Bill

Refer to [The Source Of Bill Routing Information](#) for a description of how the system constructs the information used to route a bill to one or more recipients.

Bill Route Types Control The Information Merged Onto Bills

Every bill routing record references a [Bill Route Type](#).

The bill route type controls the following for interacting with a document composition application:

NOTE: CIS Division can override the extract algorithm and/or the background process found on the bill route type. The system processes first check the bill's account's CIS Division for an override specific for the bill route type.

- It contains an algorithm that is responsible for extracting the information merged onto your bills. Algorithms of this type are called under the following scenarios:
 - The [background process](#) that interacts with your bill print software calls these algorithms.
 - If your bill print software has the ability to construct a real-time image of a bill, you can plug-in an Online Bill Display algorithm on the [Installation Record](#). This type of algorithm will call the bill extract algorithm for an appropriate bill route type to extract the information that is merged onto the bill. Refer to [Technical Implementation Of Online Bill Display](#) for the details.
- It contains the ID of the background process responsible for interacting with your bill print software in batch.

The bill route type controls the following for interacting with a reporting engine, such as BI Publisher:

- It contains an algorithm that is responsible for returning the appropriate report code and other information in order to extract the information to be merged onto your bills. Typically, the reporting engine itself is responsible for extracting and formatting the data. Algorithms of this type are called under the following scenarios:
 - The [background process](#) that interacts with your reporting engine calls these algorithms.
 - If your reporting engine has the ability to construct a real-time image of a bill, you can plug-in an Online Bill Display algorithm on the [Installation Record](#). This type of algorithm will call the bill extract algorithm for an appropriate bill route type to return the appropriate report code. Refer to [Technical Implementation Of Online Bill Display](#) for the details.

- It contains the ID of the background process responsible for interacting with your reporting engine in batch.

Technical Implementation Of Online Bill Display

Users can view an image of any bill that is sent to a customer on [Bill - Main](#) if you set up the following:

- Plug-in an Online Bill Display construction algorithm on the [Installation Record](#).
- Plug-in the appropriate bill extract algorithm on each [Bill Route Type](#).

The system can interact with either document composition applications, or a reporting engine (such as BI Publisher).

The system provides an Installation – Online Bill Display algorithm type (C1-BL-DISP) that interacts with Documaker to render an online image of your bill. The following points describe what takes place when clicking **Display Bill**.

- The algorithm based on this algorithm type calls the bill extract algorithm for an appropriate bill route type (as determined by the algorithm).
- The bill extract algorithm will construct the information that appears on the bill (refer to algorithm type C1-BLEX-XML for further details).
- The constructed information is passed to document composition software that will reconstruct the bill's image in a PDF format.
- The system displays the PDF in a separate browser session. Note that the client must have Adobe Acrobat Reader installed to view PDF files.

NOTE:

Refer to [The Bill Extract Records](#) for examples of the record layouts passed to the document composition software.

The system also provides an Installation – Online Bill Display algorithm type (C1-ONLN-CR) that interacts with [BI Publisher](#) to render an online image of your bill. The following points describe what takes place when clicking **Display Bill**:

- The algorithm based on this algorithm type calls the bill extract algorithm for an appropriate bill route type (as determined by the algorithm).
- The bill extract algorithm returns the appropriate report code to the Online Bill Display algorithm, which in turn returns the report code to the bill page (refer to algorithm type C1-BLEX-BIP for further details). This algorithm is not actually extracting data because when you use BI Publisher reports, the report itself is responsible for extracting and formatting the data.
- A user exit on the bill page invokes BI Publisher and displays the bill in a separate browser session.

NOTE:

Refer to [Bill Print in BI Publisher](#) for examples of the data extracted for the report.

Technical Implementation Of Printing Bills In Batch

The batch process that extracts bill related information reads all bill routing records in a given run number that are marked with its batch control ID

The base package example of this process ([POSTROUT](#)) simply calls the bill extract algorithm on the routing record's route type. The algorithm formats the information to be passed to the bill print software or reporting engine. Refer to [Bill Route Types Control The Information On Bills](#) for more information.

NOTE:

If your software doesn't support online bill display. The algorithm that formats bill extract records that's plugged in on [bill route type](#) serves two purposes: 1) it interacts with the online bill display algorithm plugged into the installation record to support online images of a bill, and 2) it interacts with the background process to support printing your bills in batch. If your bill print software does not support the rendering of bill images real time, there is no need to create an extract algorithm. Rather, you should simply develop your own download process that works with your bill print software to print bills in batch (and then specify this batch process on your bill route type).

Reproducing The Bill Print Flat File

You can reproduce the flat file at any time. Simply request the download process and specify the run number associated with the historic run.

How To Reprint A Specific Bill

Refer to [How To Reprint A Bill \(For The Original Recipients or For Someone New\)](#) for instructions describing how to reprint a specific bill.

Who Gets A Copy Of A Bill?

A copy of a bill is sent to every individual / business specified in the [bill's routing details](#).

There are two ways in which a bill routing detail can be created:

- When a bill is completed, the system creates a routing detail for every person linked to the account that wants to receive a copy of the bill (as specified on [Account - Person Information](#)). Refer to [The Source Of Bill Routing Information](#) for more information.
- After a bill is completed, you may insert a bill routing record. Refer to [How To Reprint A Bill \(For The Original Recipients or For Someone New\)](#) for more information.

Final Bills and Bill Print

If a bill is produced for an account where all of the accounts SAs are stopped, closed or cancelled; the bill is flagged as being the final bill on the flat file produced by the postal routing process (refer to [Bill Record - 0100](#) for the details of this switch).

If a bill is considered to be a final bill and the amount owing for the entire account is less than the final bill threshold amount on the installation record, the bill will be skipped (i.e., it won't appear on the flat file produced by the postal routing process). Note, this logic also suppresses bills from being produced when a payment is received AFTER the final bill and the account's balance falls beneath the installation record's final bill threshold amount. Refer to [Installation Options - Billing](#) for more information.

The Bill Extract Records

Numerous different types of records are interfaced to the document composition application. However, they all share a common structure for bills:

- The first 4 bytes are called the **Printer Key**. This field is a record type used by the document composition application bill template.
- The next 244 bytes are called the **Sort Key**. This field is used to ensure the various records used to construct a printed bill appear in the correct order in the interface file.
- The next 12 bytes are called the **Mailing Key**. This field is used to control the order in which the formatted bills are printed.
- The next 3 bytes are a filler that is available for future use.
- The remaining bytes contain the **BillInformation** that appears on the printed bill. The type of information differs for each type of record.

The topics in this section describe each component.

Printer Keys (Record Types)

The following table defines each printer key (i.e., record type) on the bill print flat file.

Record Type	Description	Notes
0010	Global extract information	Required. 1 per flat file.
0100	Bill record	Required. 1 per bill.
0150	Account Balance Record	Required. 1 per Special Role.
0300	Current charge record	1 per current charge.
0600	Payment record	1 per payment.
0900	Premise record	1 per premise.
1100	Service agreement record	1 per SA linked to the premise.
1300	Bill segment record	1 per bill segment linked to the SA.
1500	Bill calculation header	1 per bill calculation header linked to the bill segment.
1700	Bill calc line	1 per bill calculation line linked to the bill calculation header
1900	End of record type 1500	1 for each bill calculation header
2100	Read detail	1 for each meter read detail linked to the bill segment
2400	Service quantity detail	1 for each service quantity detail linked to the bill segment
2700	Item detail	1 for each item detail linked to the bill segment
2840	Bill segment messages	1 for each message detail linked to the bill segment
2900	End of record type 1300	1 for each bill segment
3100	Consumption history (for graph)	1 for each historical consumption period that appears on the graph
3400	Adjustment detail	1 for each adjustment
3420	Adjustment Calc Line	1 or more per adjustment
3600	End of record type 1100	1 for each service agreement

3700	End of record type 0900	1 for each premise
3900	Bill message detail	1 for each message
9999	End of record type 0100	1 for each bill

Sort Key

The following table defines the structure of the sort key that appears on each bill print record. Please note that different components are filled in for each printer key.

Field Name	Format	Source/Value/Description
Bill Print Intercept	A8	This is the user ID, if any, who reviews the bill (as specified on the account record)
Bill ID	A12	
Sequence Number	N2	The sequence number of the account / person information associated with this bill routing information.
Copy Number	N2	The number of copies desired by the account / person associated with this bill routing information.
Bill record group	A2	10 Bill 20 Payment 30 Current charge 40 Message 50 Non-Premise 55 Non-Premise end 60 Premise 70 Bill end
Filler	A2	
Premise State	A6	Only applicable for Premise based records.
Premise City	A90	Only applicable for Premise based records.
Premise Address 1	A64	Only applicable for Premise based records.
Premise Id	A10	Only applicable for Premise based records.
Premise record group	A2	10 Premise record 20 SA level record 30 Premise end record
SA Print Priority	A2	
SA Id	A10	
SA Group	A2	For Premise based records: 10 SA 20 Histogram 30 Current charge

		40 Adjustment 50 SA end record For Non-Premise based records: 10 SA 20 Current Charge 30 Adjustment 40 SA end record
Bill Segment End Date	A10	If the record is related to an adjustment, this is the adjustment creation date. If the record is for histogram detail, this contains the histogram detail number.
Bill Segment Id	A12	If the record is related to an adjustment, this is the adjustment ID.
Bill Segment Group	A2	10 Bill segment 20 Bill segment calculation group 30 Bill segment read detail 40 Bill segment SQ detail 50 Bill segment item detail 55 Bill segment message 60 Bill segment end
Bill Calc Header Sequence	N2	For records related to read detail, SQ detail, item detail or bill message detail, this field contains the related sequence number for that record.
Bill Calc Header Group	A2	10 Bill calculation header 20 Bill calculation line 30 Bill calculation end
Line Seq	N3	Defines order of rows for similar record types
Filler	47	Only applicable for non-premise based records. (This makes up for the premise address related fields that are not applicable above).

Mailing Key

The following table defines the structure of the mailing key that appears on each bill print record.

Field Name	Format	Source/Value/Description
Postal code	A12	This is the postal code on the bill routing record.

Bill Information

The topics in this section describe the information that appears on each on each bill print record.

- [Global Extract Information Record \(0010\)](#)
- [Bill Record \(0100\)](#)
- [Account Balance Record \(0150\)](#)
- [Current Charge Record \(0300\)](#)
- [Payment Record \(0600\)](#)
- [Premise Record \(0900\)](#)
- [Service Agreement Record \(1100\)](#)
- [Bill Segment Record \(1300\)](#)
- [Bill Calc Header Record \(1500\)](#)
- [Bill Calc line Record \(1700\)](#)
- [End Bill Calc Header Record \(1900\)](#)
- [Bill Segment Read Record \(2100\)](#)
- [Bill Segment SQ Record \(2400\)](#)
- [Bill Segment Item Record \(2700\)](#)
- [Bill Segment Message Record \(2840\)](#)
- [End Bill Segment Record \(2900\)](#)
- [Histogram Record \(3100\)](#)
- [Adjustment Record \(3400\)](#)
- [Adjustment Calc Lines Record \(3420\)](#)
- [End Service Agreement Record \(3600\)](#)
- [End Premise Record \(3700\)](#)
- [Message Record \(3900\)](#)
- [End Bill Record \(9999\)](#)
- [Address Sub-Record](#)

Global Extract Information Record (0010)

This is a "header" record that contains information about the extract run as a whole.

NOTE:

Please be aware that if you do not sort your extract file by **CIS Sort Key** after it is produced, this record will physically be the last record on the extract file.

Field Name	Format	Source/Value/Description
BATCH_CD	A8	Batch Control Code of the extract process.
BATCH_NBR	N10	Batch Number of the extract process
BATCH_RERUN_NBR	N10	Batch Rerun number of the extract process.

BILL_CNT	N10	Count of bills on this extract. Multiple copies of a bill are counted multiple as well.
EXTRACT_DTTM	A26	System time of extraction. Also updated in bill routing table.
BILL_ID_START	A12	This is only used when a bill is produced as a result of an online request (from Bill - Main). It contains the Bill Id to extract.
BILL_ID_END	A12	This is only used when a bill is produced as a result of an online request (from Bill - Main). It contains the Bill Id to extract.
THREAD_NBR	N10	This field is only used if bills are extracted in batch. It contains the thread number in which the bill was extracted.
THREAD_CNT	N10	This field is only used if bills are extracted in batch. It contains the total number of threads that were extracted.

[Top of Page](#)

Bill Record (0100)

Field Name	Format	Source/Value/Description
BILL_ID	A12	CI_BILL
ACCT_ID	A10	CI_BILL
BILL_DT	D (A10)	CI_BILL
DUE_DT	D (A10)	CI_BILL
COPY_NBR	N2	
NBR_BILL_COPIES	N2	CI_BILL_RTG
BILL_PRT_INTERCEPT	A8	CI_BILL_RTG
BILL_FORMAT_FLG	A2	CI_BILL_RTG
REPRINT_SW	A1	CI_BILL_RTG
CASH_ONLY_SW	A1	
CUR_BAL	S13.2	CI_BILL_SA
CUR_CHG_AMT	S13.2	CI_FT
CUR_CORR_AMT	S13.2	CI_FT
CUR_ADJ_AMT	S13.2	CI_FT
CUR_PAY_AMT	S13.2	CI_FT
CUR_PREV_BAL	S13.2	CI_FT
TOT_BAL	S13.2	CI_BILL_SA
TOT_CHG_AMT	S13.2	CI_FT
TOT_CORR_AMT	S13.2	CI_FT
TOT_ADJ_AMT	S13.2	CI_FT
TOT_PAY_AMT	S13.2	CI_FT
TOT_PREV_BAL	S13.2	Computed during extract.

CURRENCY_CD	A3	CI_BILL_SA
DELINQUENT_AMT	S13.2	Computed during extract.
CUST_PO_ID	A20	CI_BILL_RTG
ACCT_ENTITY_NAME	A254	CI_PER_NAME. Account Entity Name. Might include prefix/suffix from Account/Person if available.
ENTITY_NAME	A254	CI_BILL_RTG. Mailing Entity Name.
ADDRESS_SBR	A1241	CI_BILL_RTG. Refer to its components in a later section.
FINAL_BILL_SW	A1	Computed during extract. Contains a value of Y if this bill is considered to be a "final" bill.
SCHED_EXTRACT_DT	D (A10)	CI_APAY_CLR_STG. This is the date that the automatic payment will be downloaded.
ENTITY_NAME1	A254	CI_BILL_RTG. Mailing Entity Name1.
ENTITY_NAME2	A254	CI_BILL_RTG. Mailing Entity Name2.
ENTITY_NAME3	A254	CI_BILL_RTG. Mailing Entity Name3.
ACCT-CUR-SYMBOL	A4	Currency symbol for the account's currency code.

[Top of Page](#)

Account Balance Record (0150)

Field Name	Format	Source/Value/Description
SPECIAL-ROLE-CD	A2	SA Type Special Role flag
SPECIAL-ROLE –DESCR	A30	Special Role description
CUR-AMT	S13.2	Derived from CI_FT (Include ALL non-canceled/non-closed SAs for the account/debt class, even those that do not have current charges)
TOT- AMT	S13.2	Derived from CI_FT (Include ALL non-canceled/non-closed SAs for the account/debt class, even those that do not have current charges)

[Top of Page](#)

Current Charge Record (0300)

Field Name	Format	Source/Value/Description
DEBT-CLASS-CD	A4	Debt Class of SA Type
DEBT-CLASS-DESCR	A30	Debt Class Description
CUR-CHARGE-AMT	S13.2	Derived from CI_FT (Only the current charge bill segments.)
TOT-CHARGE-AMT	S13.2	Derived from CI_FT (Only the current charge bill segments.)

[Top of Page](#)

Payment Record (0600)

Field Name	Format	Source/Value/Description
FT TYPE	A2	Pay or Pay Cancel ('PS' or 'PX')
PAY-DT	D (A10)	Derived from CI_FT
CAN_RSN_CD	A4	Derived from CI_PAY, Only for cancellation
CAN-RSN-DESCR	A30	Derived from CI_PAY_CAN_RSN
CUR-PAY-AMT	S13.2	Derived from CI_FT.
TOT-PAY-AMT	S13.2	Derived from CI_FT.

[Top of Page](#)

Premise Record (0900)

Field Name	Format	Source/Value/Description
NON_PREM_SW	A1	Y/N switch to indicate (Y) special (non-premise) premise record. This is for non-premise service agreements such as charity or payment arrangement.
PREM_ID	A10	From CI_SA or CI_BSEG
ADDRESS_SBR	A1241	Service Address (Address of Char Premise) from CI_PREM. Refer to its components in a later section.

[Top of Page](#)

Service Agreement Record (1100)

Field Name	Format	Source/Value/Description
SA_ID	A10	CI_SA
OLD_ACCT_ID	A36	CI_SA
CUST_READ_FLG	A2	CI_SA
SIC_CD	A4	CI_SA
SIC_DESCR	A30	CI_SIC
BUSINESS_UNIT	A10	CI_SA
SA_TYPE_CD	A8	CI_SA
SA_TYPE_DESCR	A30	CI_SA_TYPE
SA_TYPE_DFLT_DESCR	A80	CI_SA_TYPE
SVC_TYPE_CD	A30	CI_SA_TYPE
SVC_TYPE_DESCR	A30	CI_SVC_TYPE
REV_CL_CD	A8	CI_SA_TYPE
CHAR_PREM_ID	A10	CI_SA
SA_REL_ID	A10	CI_SA_REL
SA_REL_TYPE_CD	A8	CI_SA_REL

SA_REL_TYPE_DESCR	A30	CI_SA_REL_TYPE
SPR_CD	A12	CI_SA_REL
SPR_DESCR	A50	CI_SPR
SPR_ENTITY_NAME	A254	CI_PER_NAME (this is the service provider's person's name)

[Top of Page](#)

Bill Segment Record (1300)

Field Name	Format	Source/Value/Description
START_DT	D (A10)	CI_BSEG
END_DT	D (A10)	CI_BSEG
CLOSING_BSEG_SW	A1	CI_BSEG
EST_SW	A1	CI_BSEG
BILL_CYC_CD	A4	CI_BSEG
SQ_OVERRIDE_SW	A1	CI_BSEG
ITEM_OVERRIDE_SW	A1	CI_BSEG
BSEG_STAT_FLG	A2	CI_BSEG
CAN_RSN_CD	A4	CI_BSEG
CAN_RSN_DESCR	A30	CI_BILL_CAN_RSN
CUR_AMT	S13.2	CI_FT
TOT_AMT	S13.2	CI_FT

[Top of Page](#)

Bill Calc Header Record (1500)

Field Name	Format	Source/Value/Description
START_DT	D (A10)	CI_BSEG_CALC
END_DT	D (A10)	CI_BSEG_CALC
SETID	A10	CI_BSEG_CALC
RS_CD	A8	CI_BSEG_CALC
CALC_AMT	S13.2	CI_BSEG_CALC
DESCR_ON_BILL	A254	CI_BSEG_CALC

[Top of Page](#)

Bill Calc line Record (1700)

Field Name	Format	Source/Value/Description
APP_IN_SUMM_SW	A1	CI_BSEG_CALC_LN
CALC_AMT	S13.2	CI_BSEG_CALC_LN
EXEMPT_AMT	S13.2	CI_BSEG_CALC_LN
UOM_CD	A30	CI_BSEG_CALC_LN

TOU_CD	A30	CI_BSEG_CALC_LN
SQI_CD	A30	CI_BSEG_CALC_LN
BILL_SQ	S12.6	CI_BSEG_CALC_LN
DESCR_ON_BILL	A254	CI_BSEG_CALC_LN

[Top of Page](#)

End Bill Calc Header Record (1900)

Field Name	Format	Source/Value/Description
Dummy field		

[Top of Page](#)

Bill Segment Read Record (2100)

Field Name	Format	Source/Value/Description
SP_ID	A10	CI_BSEG_READ
BADGE_NBR	A16	CI_MTR
UOM_CD	A30	CI_BSEG_READ
TOU_CD	A30	CI_BSEG_READ
RDG_DEC_POS	N1	CI_REG. Decimal positions of the reads.
START_REG_READING	S9.6	CI_BSEG_READ
START_READ_DTTM	T (A26)	CI_BSEG_READ
START_ESTIMATE_SW	A1	CI_REG_READ
END_REG_READING	S9.6	CI_BSEG_READ
END_READ_DTTM	T (A26)	CI_BSEG_READ
END_ESTIMATE_SW	A1	CI_REG_READ
MSR_QTY	S12.6	CI_BSEG_READ
USAGE_FLG	A2	CI_BSEG_READ
USE_PCT	N3	CI_BSEG_READ
HOW_TO_USE_FLG	A2	CI_BSEG_READ
CONSUM_SUB_FLG	A2	CI_REG
MSR_PEAK_QTY_SW	A1	CI_BSEG_READ
REGISTER_CONST	S6.6	CI_BSEG_READ
QTY_DEC_POS	N1	CI_UOM. Decimal positions of the final quantity.
FINAL_UOM	A4	CI_BSEG_READ
FINAL_TOU	A8	CI_BSEG_READ
FINAL_REG_QTY	S12.6	CI_BSEG_READ
SQI_CD	A30	CI_BSEG_READ
FINAL_SQI_CD	A8	CI_BSEG_READ

[Top of Page](#)

Bill Segment SQ Record (2400)

Field Name	Format	Source/Value/Description
UOM_CD	A30	CI_BSEG_SQ
TOU_CD	A30	CI_BSEG_SQ
SQI_CD	A30	CI_BSEG_SQ
SQ_DEC_POS	N1	CI_BSEG_SQ
BILL_SQ	S12.6	CI_BSEG_SQ

[Top of Page](#)

Bill Segment Item Record (2700)

Field Name	Format	Source/Value/Description
START_DT	D (A10)	CI_BSEG_ITEM
END_DT	D (A10)	CI_BSEG_ITEM
ITEM_CNT	S9.2	CI_BSEG_ITEM
ITEM_DESCR	A60	CI_ITEM_TYPE

[Top of Page](#)

Bill Segment Message Record (2840)

Field Name	Format	Source/Value/Description
BILL_MSG_CD	A4	CI_BSEG_MSG
MSG_ON_BILL	A254	CI_BILL_MSG_L

[Top of Page](#)

End Bill Segment Record (2900)

Field Name	Format	Source/Value/Description
Dummy field		

[Top of Page](#)

Histogram Record (3100)

Field Name	Format	Source/Value/Description
UOM_CD	A30	CI_SA_TYPE
TOU_CD	A30	
SQI_CD	A30	
SQ_DEC_POS	N1	CI_UOM. Decimal positions of SQ.
SQ_CNT	N2	Count of SQ (maximum of 13.)
MAX_BILL_SQ	S12.6	Maximum Bill SQ from list. This is derived from CI_BSEG_READ.
SQ_DT (1:13)	D (A10)	Date (for label of the SQ). This is derived from CI_BSEG.

BILL_SQ (1:13)

S12.6 (1:13)

13 occurrences of QTY, one for each period ending on the SQ_DT. This is derived from CI_BSEG_READ.

[Top of Page](#)

Adjustment Record (3400)

Field Name	Format	Source/Value/Description
ADJ_DT	D (A10)	CI_FT
FT_TYPE_FLG	A2	CI_FT
CUR_AMT	S13.2	CI_FT
TOT_AMT	S13.2	CI_FT
ADJ_TYPE_CD	A8	CI_ADJ
ADJ_TYPE_DESCR	A30	CI_ADJ_TYPE
DESCR_ON_BILL	A254	CI_ADJ_TYPE
CAN_RSN_CD	A4	CI_ADJ
CAN_RSN_DESCR	A30	CI_ADJ_CAN_RSN

[Top of Page](#)

Adjustment Calc Lines Record (3420)

Field Name	Format	Source/Value/Description
APP_IN_SUMM_SW	A1	Appears in Summary Y/N switch derived from CI_ADJ_CALC_LN
RS_CD	A8	Rate Schedule derived from CI_ADJ_CALC_LN
CALC_AMT	S13.2	Calculated Amount derived from CI_ADJ_CALC_LN
EXEMPT_AMT	S13.2	Exempt Amount derived from CI_ADJ_CALC_LN
UOM_CD	A30	Unit of Measure derived from CI_ADJ_CALC_LN
TOU_CD	A30	Time of Use derived from CI_ADJ_CALC_LN
SQI_CD	A30	SQI derived from CI_ADJ_CALC_LN
BILL_SQ	S12.6	Billable Service Quantity derived from CI_ADJ_CALC_LN
DESCR_ON_BILL	A254	Description on Bill derived from CI_ADJ_CALC_LN
APP_IN_SUMM_SW	A1	Appears in Summary Y/N switch derived from CI_ADJ_CALC_LN

[Top of Page](#)

End Service Agreement Record (3600)

Field Name	Format	Source/Value/Description
------------	--------	--------------------------

Dummy field

[Top of Page](#)

End Premise Record (3700)

Field Name	Format	Source/Value/Description
Dummy field		

[Top of Page](#)

Message Record (3900)

Field Name	Format	Source/Value/Description
BILL_MSG_CD	A4	CI_BILL_MSGS
MSG_PRIORITY_FLG	A2	CI_BILL_MSG
INSERT_CD	A8	CI_BILL_MSG
MSG_ON_BILL	A254	CI_BILL_MSG

[Top of Page](#)

End Bill Record (9999)

Field Name	Format	Source/Value/Description
Dummy field		

[Top of Page](#)

Address Sub-Record

The address sub-record that appears in both the bill record (0100) and the premise record (0900) is composed of the following:

Field Name	Format	Description
COUNTRY	A3	
ADDRESS1	A254	Refer to The Source Of Bill Routing Information for a description of conditions when this field will contain a fax number or an Email address rather than the first line of a postal address (this only occurs for a bill record (0100)).
ADDRESS2	A254	
ADDRESS3	A254	
ADDRESS4	A254	
CITY	A90	
NUM1	A6	
NUM2	A4	
HOUSE_TYPE	A2	
COUNTY	A90	

STATE	A6
POSTAL	A12
GEO_CODE	A11
IN_CITY_LIMIT	A1

XML Bill Extracts

The system includes a sample bill extract algorithm that produces an XML document to interface to a document composition application. This is an alternative to the fixed flat file format described above. For additional details, see the algorithm type **Create XML bill extract records (C1-BLEX-XML)**.

Algorithms of this type construct the XML file records that contain the information that appears on a printed bill. Each record in the extract is constructed using an extendable data area and may be extended by an implementation using the Post Processing Script parameter. The following steps should be followed to include additional elements in the extract:

- Create a data area that includes the additional elements for the record you wish to extend. This data area must reference the base product data area used in the extract. For example, to extend the bill record, create a data area that references data area C1-BillPrintBillRecord as its extended data area. See the C1-BLEX-XML algorithm type for a complete list of the data areas available.
- Create a service script to retrieve the additional elements. This service script must be defined as the Post Processing Script on your algorithm and its schema must include the main bill extract data area (C1-BillPrintRecord).

For an example of how to extend the XML bill extract to include additional elements, see the `CI_BillPrintXMLExtract` export bundle included in the demo data.

Sequential Bill Numbers

Every bill is uniquely identified by its bill ID. Bill ID is a random, system-assigned number. In some locales, bills have an additional identifier known as a "sequential bill number". Sequential bill numbers are system-assigned, sequential numbers. For example, the first bill produced by the system is assigned a sequential bill number of 1, the next bill is assigned a value of 2, etc. An additional requirement is that no gaps may exist between the sequential bill numbers.

The topics in this section describe how sequential bill numbers are implemented in the system.

Sequential Numbers Are Only Assigned If The Installation Option Is Turned On

Sequential bill numbers will only be assigned if you have selected Sequential Bill Numbers as the Alternative Bill ID Option on the [Installation](#) record.

Pending Bills Do Not Have A Sequential Bill Number

Bills are assigned a sequential bill number after they are completed. This means that pending bills will not have a sequential bill number. This is intentional as pending bills can be deleted and if a deleted bill had a sequential bill number, gaps would result. Refer to [Bill Lifecycle](#) for more information about a bill's state transition lifecycle.

When / How Is The Sequential Bill Number Assigned

WARNING:

This section is a technical explanation of how sequential bill numbers are assigned. It contains background information for those who wish to understand the rationale of the design.

The batch billing background process BILLING takes advantage of parallel processing to allow multiple bills to be produced concurrently. In addition, we allow groups of bills to be committed in "chunks" (based on the commit frequency assigned to the billing background process). These two facts make it impossible to allocate sequential bill numbers during batch billing (because back outs could result in gaps and parallel processing could result in duplicates). This is why sequential bill numbers are allocated as follows:

- A sequential bill number is allocated when a bill is completed online (by clicking the **Complete** button on [Bill - Main](#)).
- If you submit the batch billing process with the following [parameters](#), sequential bill numbers will be allocated when bills are completed:
 - **Batch thread number** must equal 1.
 - **Batch thread count** must equal 1.
 - **Override maximum records between commits** must equal 1.The above parameters mean that bills are not being produced in parallel and they are not being committed in "chunks". This allows the system to allocate sequential bill numbers when the bills are completed.
- If you do not run batch billing single-threaded, you must schedule the Assign Sequential Bill Numbers background process (ASSGNSBN) to run immediately after batch billing. This single-threaded process assigns sequential bill numbers to completed bills.
- The following measures are in place as a fail-safe:
 - If the bill print download background process (POSTROUT) encounters a bill without a sequential bill number, it will abort with an appropriate error message.
 - Users are not allowed to delete a completed bill with a sequential bill number. Note, deletion of completed bills is typically prohibited due to the presence of frozen bill segments. However, it's possible to create a bill without frozen bill segments and additional logic exist to inhibit the deletion of such bills if they have sequential bill numbers.

Additional Functionality for Sequential Bill Numbering

The following points describe additional features that are enabled when the [Installation](#) record indicates sequential bill numbers are used:

- The bill's number appears in "bill info". "Bill info" is the concatenated string of information that summarizes a bill on many pages in the system.
- The Bill Search page includes an additional search option to search by bill number.
- The match type algorithm (DSO BILL-ID) that allows payments to be matched to a given bill id will try to match the payment to a bill with a matching sequential bill number.

Document Numbers

Every bill is uniquely identified by its bill ID. Bill ID is a random, system-assigned number. In some locales utilities may be required to assign and print an additional document number. For example, in Argentina a utility must obtain authorization from the national tax agency before they are allowed to print bills at a local office. Once authorized, the utility is assigned a printing authorization code valid for a period. The printing authorization code and expiration, as well as an official document number are printed on the bill at the location where the bill is issued.

The topics in this section describe how document numbers are implemented in the system.

Document Numbers Are Only Assigned If the Installation Option Is Turned On

Document numbers will only be assigned if you have selected Document Numbers as the Alternative Bill ID Option on the [Installation](#) record. In addition, the Document Number (C1-DOC-NBR) and Document Number Details (C1-DOCNBR-DT) algorithms must be enabled on the [Installation](#) record. These algorithms contain the logic used by the system to assign a document number to a bill.

The logic used to assign a document number can be quite complex. For example, the document number may depend on the issuing center, the bill's document type (credit memo, invoice or debit memo), the account's VAT category and the CIS division. Depending on your implementations complexity, you may choose one of the following possible configurations for document numbers:

- Populate the Document Number, Document Number Details and Document Sequence Number algorithms on the Installation record. The system will behave as follows:
 - During online bill completion, a document type is derived and captured on the bill along with other required bill characteristics and a document number is assigned
 - During batch billing, a document type is derived and captured on the bill along with other required bill characteristics. Assigning a document number is deferred to the Assign Bill Document Numbers background process. The idea here is that all complex logic is executed during the multi-threaded batch billing process leaving the minimal amount of work for the single-threaded batch process that assigns the document number.
- Populate the Document Number and Document Number Details algorithms on the Installation record. Here, the system assigns a document number during online bill completion, but skips the assignment of document type and number during batch billing. The Assign Bill Document Numbers background process is responsible for deriving the bill's characteristics (document type, document classification, etc.) and assigning a document number.

Pending Bills Do Not Have a Document Number

Similar to sequential bill numbers, bills are assigned a document number after they are completed. This means that pending bills will not have a document number. Refer to [Bill Lifecycle](#) for more information about a bill's state transition lifecycle.

When/How Is the Document Number Assigned

WARNING:

This section is a technical explanation of how document numbers are assigned. It contains background information for those who wish to understand the rationale of the design.

- An installation algorithm assigns a document number to a bill.

Similar to sequential bill numbers, document numbers are allocated as follows:

- A document number is allocated when a bill is completed online (by clicking the **Complete** button on [Bill - Main](#)).
- The Assign Bill Document Numbers background process (C1-BNBAS) should be scheduled to run immediately after batch billing. This single-threaded process assigns document numbers to completed bills.
- The logic used to assign a document number resides in the installation options Document Number (C1-DOC-NBR) algorithm.
- The following measures are in place as a fail-safe:
 - If the billing download process (POSTROUT) encounters a bill without a document number, it will abort with an appropriate error message.
 - Users are not allowed to delete a completed bill with a document number. Note, deletion of completed bills is typically prohibited due to the presence of frozen bill segments. However, it's possible to create a bill without frozen bill segments and additional logic exist to inhibit the deletion of such bills if they have sequential bill numbers.

Additional Functionality Exists When Document Numbers Are Used

The following points describe additional features that are enabled when the [Installation](#) record indicates that document numbers are used:

- The Bill Search page includes an additional search option to search by Document Number and Document Type.
- The bill's document number and type appear in "bill info". "Bill info" is the concatenated string of information that summarizes a bill on many pages in the system.
- The match type algorithm (C1-PDOV-PYBN) that allows payments to be matched to a given bill id will try to match the payment to a bill with a matching document number and type.

Digital Signatures

In some locales, billing software is required to generate and store digital signatures for each bill. Digital signatures are used to secure bills that are stored in the database, and the digital key for the bill will be known only to the vendor.

CCB supports digital signatures with the following features:

- An Encryption feature configuration must be configured with an algorithm info option for the key alias and signing algorithm
- The installation algorithm, C1-BILLSIG, generates the digital signature for a bill and captures this on the bill itself. The algorithm also stores an alias of the private/public key pair on the Bill as a characteristic. See the installation algorithm, C1-BILLSIG, for a description of how the signature is generated.
- Bills are assigned a digital signature when they are completed.
 - The Assign Bill Document Numbers background process (C1-BNBAS) is responsible for generating digital signatures for a batch of bills. This batch job should be scheduled to run immediately after batch billing. See the description of the batch control and parameter settings for generating digital signatures.
 - A digital signature is also generated when a bill is completed online (by clicking the **Complete** button)

NOTE: The digital signatures features are only appropriate for customers who use document number in generating bill signatures.

For an example of the objects and instructions used for implementing this feature, see the [CI_BillIDocNumber & DigitalSignature](#) export bundle included in the demo data.

For details about setting up the required keystore for this feature, see the [Installation Guide](#).

Writing Off Bills

If your organization practices [open-item accounting](#) and your credit and collections rules revolve around [collecting on unpaid bills](#), you can set up the system to automatically write-off bills.

If you've enabled this functionality, [Bill - Main](#) will contain a button that a user can click to manually write off a bill. A corresponding button exists that a user can click to reverse a written-off bill.

FASTPATH:

Refer to [Writing Off Bills](#) for a description of how to set up the system to allow both automated and manual bill write off.

Idiosyncratic Manual Bill Cancellation

If a bill's account is associated with a Customer Class that has a Cancel Bill algorithm, the system invokes this algorithm before the bill is displayed to determine if the bill is "cancellable". If the algorithm indicates the bill is cancellable, a button appears on [Bill - Main](#). When clicked, the Cancel Bill algorithm is invoked again to cancel the bill. This functionality is meant to support unique cancellation needs required by some implementations; the sample base-package algorithm is empty.

Maintaining Bills

A bill is used to communicate changes in a customer's financial obligations to the customer. The topics in this section describe how to maintain bills.

NOTE:

The system creates most bills behind-the-scenes. Most bills are created by the system when it processes the bill cycle schedule. You should only have to access the bill pages to correct a bill or to add a bill real-time. For information about how the system creates bills, refer to [The Big Picture of Billing](#).

It's important to be aware that there are very few fields that are directly modifiable by a user. To modify most fields on a bill, you have to change source information (e.g., service agreement, rate, meter read) and then regenerate the bill. For example, if you want to change a bill's amount, you must cancel or add bill segments; you cannot change the bill's amount by modifying the bill amount field. Refer to [How To](#) for step-by-step instructions that explain how to perform common bill maintenance functions.

Bill Lifecycle

The following diagram shows the possible lifecycle of a bill.

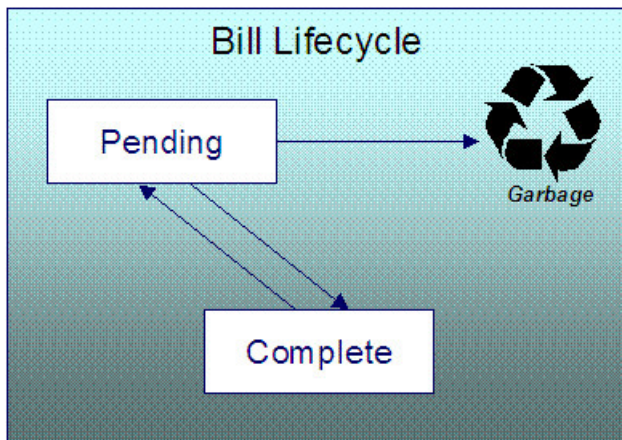

WARNING:

This explanation only makes sense in the context of the page used to maintain bills. Refer to [Bill - Main Information](#) for the details.

A bill is initially saved in the Pending state. You may create one or more bill segments for the account's service agreements at this point. Refer to [How To](#) for information about generating bill segments for the bill.

A bill becomes Complete when it is ready to be sent to the customer. Completing a bill triggers many things to occur. Refer to the section below for information about what happens when a bill is completed.

When you complete a bill, several things may happen:

- Pre-completion algorithms associated with the account's service agreements' [SA types](#) are executed. The system executes these algorithms first in the order of the [billing processing sequence](#) on each service agreement's SA type then in the order of the algorithm's sequence. These are not executed for the completion of [credit notes](#).
- Pre-completion algorithms associated with the account's [customer class](#) are executed.
- The bill's due date is calculated. This is equal to the bill date plus the number of days defined on the account's customer class. If the resultant date is not a workday, the due date is set to the next workday. Note, this due date can be overridden if an override algorithm exists on the account's customer class.
- The bill's routing information is set up using [Account - Person Information](#).
- If the Freeze At Bill Completion [installation option](#) has been turned on, freezable bill segments and adjustments linked to the account are frozen. Note, only freezable adjustments whose [adjustment type](#) indicates Freeze At Bill Completion will be frozen at this time. Refer to [Preventing SA Balances And The GL From Being Impacted Until Bill Completion](#) for more information.
- If a final bill segment of a deposit service agreement is detected, the deposit is refunded to the customer using the refund method algorithm plugged-in on the deposit SA's deposit class. Refer to [Deposit Refund](#) for more information. This step is skipped during the completion of [credit notes](#), or if the bill is linked to an [off cycle bill generator](#).
- Bill completion algorithms associated with the account's service agreements' [SA types](#) are executed. The system executes these algorithms first in the order of the [billing processing sequence](#) on each service agreement's SA type then in the order of the algorithm's sequence.
- Bill completion algorithms associated with the account's [customer class](#) are executed.
- Bill messages are amalgamated from various sources and linked to the bill. Refer to [The Source Of Bill Messages](#) for more information.
- Other financial transactions that have been frozen since the last bill and are marked to show on bill are linked to the new bill
- For open-item customers adjustments and corrections are linked

- For [correction notes](#) or [credit notes](#), the bill cancellation financial transactions are linked
- For off cycle bill generator bills:
- Adjustments linked to the off cycle bill generator are linked to the bill
- If the off cycle bill generator is linked to a service agreement, then all non-payment financial transactions associated with the SA are linked to the bill
- For all other situations, payments, adjustments and corrections are linked assuming the adjustments are not linked to an off cycle bill generator
- All financial transactions that don't already have a user-defined aging date will be dated with the current date. In other words, they start aging from the date the bill is completed.
- If the account pays automatically and the installation's Autopay Creation Option is to Create At Bill Completion, an automatic payment is created. Refer to APAY-CREATE for more information about the auto pay creation algorithm. This step is skipped during the completion of [credit notes](#).
- If the account's customer class indicates the account is an open-item customer, a match event is created. The bill's FTs and the automatic payment's FTs are linked to it. Refer to [Payments and Match Events](#) for more information about match events. This step is skipped during the completion of [credit notes](#).
- If the account pays automatically and the installation's Autopay Creation Option is to Create On Extract Date, the bill is stamped with the date when the automatic payment is to be created. Refer to APAYCRET, the background process that creates the automatic payment, and APAYDSFR, the background process that distributes and freezes the automatic payment, for more information. This step is skipped during the completion of [credit notes](#).
- The bill's late payment date is calculated. This is equal to the due date plus the grace days defined on the account's customer class. If the resultant date is not a workday, the LPC date is set to the next workday. This step is skipped during the completion of [credit notes](#).
- The account is marked for review by the account debt monitor on its due date plus a grace period defined on its customer class. This step is skipped during the completion of [credit notes](#).
- If the account's customer class indicates the account is an open-item customer, the system will create a match event if the new charges are offset by other financial transactions. Refer to [Payments and Match Events](#) for more information about match events. This step is skipped during the completion of [credit notes](#).
- The bill's status becomes Complete.
- Post bill completion algorithms associated with the account's [customer class](#) are executed.

If the system cannot complete the bill (for whatever reason), the bill remains Pending and an error message is shown on the main bill page. After correcting the cause of the problem, attempt to complete the bill again.

A complete bill may be changed back to pending using the [Reopen](#) button on [Bill - Main Information](#). You would reopen a bill when

- Add more bill segments to a completed bill. Refer to the [How To](#) section for information about linking bill segments for a bill.
- Fine-tune the payments, adjustments, and corrections that were linked to a completed bill. Refer to the [How To](#) section for detailed instructions.

When you're happy with the bill, you can complete it again.

NOTE:

Cannot reopen historical bills. You may only reopen an account's most recent bill (except if this bill is linked to an off cycle bill generator) because recompleting the bill causes the ending-balance to change, and we don't want this to happen to historical bills.

Automatic payments. If an automatic payment was created when the bill was completed and it has already been interfaced to the financial institution, you cannot reopen the bill. If the automatic payment exists, but it has not yet been interfaced, the system will automatically cancel the payment when you reopen the bill.

Certain bill completion algorithms prevent reopening. If a bill contains a service agreement whose SA type has a "transfer accounts receivable to service provider" algorithm, the system will not allow the bill to be reopened. Refer to [If You Deal With TBFU Service Providers You Can't Reopen Bills](#) for more information about this bill completion algorithm.

You may [delete](#) a Pending bill from the database. You may not delete a pending bill if: a) there are frozen bill segments linked to the bill, or b) if financial transactions were linked to the bill (and this can only happen if the bill had been previously completed).

In addition to removing the bill, the system will also remove unfrozen bill segments linked to the bill.

Bill - Main Information

Open **Menu > Financial > Bill > Search** to maintain core bill information.

The following discussion describes the fields on this page. Refer to [How To](#) for a description of how to perform common bill maintenance functions.

Description of Page

Bill Info contains a concatenation of important information about the bill (e.g., the bill date, its status, due date, ending balance, etc.). If [sequential bill numbering](#) has been enabled, the bill's number also appears. If document numbering has been enabled, the assigned document number and document type will also appear. If this bill is a [correction note](#) or [credit note](#), a message will appear indicating this along with the ID of the original bill. If the batch billing background process generates the bill, the bill information includes the bill cycle and window start date. Bills generated manually, i.e., off-schedule, do not have this information.

Bill ID is the system-assigned unique identifier of the bill.

Account ID identifies the customer who is responsible for the bill. The name of the main customer on the account appears adjacent.

If this bill is a [credit note](#) or [correction note](#), a message appears adjacent to the account information indicating that this bill is a credit note or correction note for another bill; this hyperlink will drill you to the original bill. If a credit note or correction note has been issued for one or more of this bill's bill segments, a message appears indicating such. **Bill Status** is the bill's status. Refer to [Bill Lifecycle](#) for the potential values and how to handle a bill when it exists in a given state. Adjacent to the bill status is the **Display Bill** button, which will display an online image of the bill when clicked. Refer to [How To Display A Bill On-line](#) for more information.

If the bill is associated with an off cycle bill generator, a message appears adjacent to the bill status indicating this and the hyperlink will take the user to the related off cycle bill generator.

NOTE:

You can only use the **Display Bill** button if your system has been configured to display an on-line image; otherwise, a message indicating that the service is not available will appear. This option can only be configured by your technical staff. The system comes with configurations to display bill images using BI Publisher or a document composition application, but can work with other applications.

Due Date is the date on which the bill is due. A bill's due date is calculated as follows:

- Add the due days specified on the account's customer class to the bill date.
- The resulting date is the due date unless it's not a workday. In this case, the due date is set to the next workday (workdays are defined in the installation options tables).
- If the account's customer class has an override due date calculation algorithm, the due date may be overridden. Refer to [Setting Up Customer Classes](#) for more information.

NOTE:

Late payment charges. Late payment charges are calculated on the due date plus the grace period. Refer to [Defining Late Payment Charge Options](#) for more information.

Bill Date is the business date that was used when the bill was completed. For example, if batch billing starts on 11:55 pm on 1-Jan-2000 and a bill is produced at 1:00 am on 2-Jan-2000, this bill's bill date would be 1-Jan-2000.

Create Date/Time is the date and time on which the bill was originally created.

Completion Date/Time is the date and time on which the bill was completed.

If the customer [pays automatically](#) and the automatic payment has not yet been created, a brief message appears highlighting the date and amount of the future automatic payment. In addition, a button appears called **Stop Autopay**, that, when clicked, causes the associated automatic payment to stop. You might click this button if the customer indicates that they will send in a payment. After you click the **Stop Autopay** button, a message appears highlighting the stoppage. Refer to [How And When Are Automatic Payments Created](#) for more information about how to setup the system to defer the creation of automatic payments until the future automatic payment extract date.

In the **Message** area, a brief error message appears if there's a problem with the bill. The message area is suppressed if there are no problems with the bill.

Click the magnifying button to view the long explanation. The long explanation will provide information about the cause of the error (and how to fix it).

The **Late Payment Charge Details** section contains information about how the system determines when and whether to levy late payment charges:

- **Eligible for Late Payment Charge** can be checked if a charge should be levied for late payment. This field is defaulted based on the customer's customer class. If you want to excuse a bill from late payment charge processing uncheck this box.
- **Late Payment Charge Date** is the date on which the system will levy a late payment charge if payment is not received. This date is calculated when the bill is completed. It is equal to the bill's due date plus the account's customer class's grace days. If this date does not fall on a workday, the date is set to the next available workday when the bill is completed. If you want to manually delay the onset of late payment charge processing, extend this date into the future.

FASTPATH:

Late payment charges. Late payment charges are calculated on the due date plus the grace period. Refer to [How Late Payment Charges Get Calculated](#) for more information.

Bill Summary summarizes the financial impact of the bill. The information that appears differs depending on whether the account is a [balance-forward or open-item account](#). If the account is a balance-forward customer, the following information appears:

- **Previous Period's Balance** is the balance from the account's last bill.
- **Total Payments** is the total amount of frozen or canceled payment segment financial transactions linked to this bill. Frozen payment segments appear as negative numbers (decreasing the amount owed by the customer), while canceled payment segments appear as positive numbers (increasing the amount owed). You can drill down on this balance to view the financial transactions that contribute to this total. Refer to [How To Remove Unwanted Payments From A Completed Bill](#) for a description of how to perform common maintenance functions.
- **Total Adjustments** is the total amount of frozen or canceled adjustment financial transactions linked to this bill. You can drill down on the balance to view the financial transactions that contribute to this total. Refer to [How To Remove Unwanted Adjustments From A Completed Bill](#) for a description of how to perform common maintenance functions.
- **Total Bill Corrections** is the total amount of canceled and / or rebilled bill segment financial transactions linked to this bill. You can drill down on the balance to view the financial transactions that contribute to this total.

- **Total Current Billing Charges** is the total amount of frozen bill segment financial transactions linked to this bill. You can drill down on the balance to view the financial transactions that contribute to this total.
- **Ending Balance For This Period** is the sum of the five amounts above. It is the amount owed by the customer as of the end of the bill period.

If the account is an [open-item customer](#), the following information appears under **Bill Summary**:

- **New Charges** is the total amount of frozen bill segment financial transactions linked to this bill. You can drill down on this value to view the financial transactions that contribute to this total.
- **Adjustments** is the total amount of frozen or canceled adjustment financial transactions linked to this bill. You can drill down on this value to view the financial transactions that contribute to this total. Refer to [How To Remove Unwanted Adjustments From A Completed Bill](#) for a description of how to perform common maintenance functions.
- **Corrections** is the total amount of canceled and / or rebilled bill segment financial transactions linked to this bill. You can drill down on this value to view the financial transactions that contribute to this total.
- **Total** is the sum of the above amounts. You can drill down on this value to view the financial transactions that contribute to this total.

If the account is an [open-item customer](#), the following information appears under **Match Summary** (note, this section is not displayed for balance-forward accounts):

- **X Balanced Item(s)** contains the count and total amount of financial transactions linked to this bill that are linked to balanced match events.
- **X Unbalanced Item(s)** contains the count and total amount of financial transactions linked to this bill that are linked to unbalanced match events.
- **X Disputed Item(s)** contains the count and total amount of financial transactions linked to this bill that are linked to disputed match events.
- **X Unmatched Item(s)** contains the count and total amount of financial transactions linked to this bill that are not linked to any match event.

Total Changes After Completion only appears if bill segments that appeared on the original bill have been subsequently [canceled or rebilled](#). The amount displayed is the net effect of all cancels and rebills. Note, you can use the **Remarks** column in the bill segments grid (to the right) to see which bill segments have been cancelled / rebilled.

If 25 or fewer bill segments are linked to this bill, the grid in the lower right portion of the page contains one row for every bill segment linked to the bill.

The following points describe each column in the grid:

- The **Bill Segment** column contains a concatenation of each bill segment's division, SA type, status and bill period. The division and SA type come from the bill segment's service agreement.
- The **Current Amount** column contains the bill segment's effect on the service agreement's current balance.
- The **Status** column shows the bill segment's status. Refer to [Bill Segment Lifecycle](#) for the possible values.
- The **Remarks** highlight special situations. The following remarks may appear:
 - Rebill after completion appears if the bill segment is a rebill that was created after the bill was sent to the customer. The financial impact of this bill segment appears as a "bill correction" on the next bill produced for the customer.
 - Rebill prior completion appears if the bill segment is a rebill that was created before the bill was sent to the customer.
 - Canceled after completion appears if the bill segment was canceled after the bill was sent to the customer. The financial impact of this bill segment appears as a "bill correction" on the next bill produced for the customer.
 - Canceled prior completion appears if the bill segment was canceled before the bill was sent to the customer.
- If the bill segment's status is Error or Incomplete, this column contains an estimated value of this bill segment. The estimated value is calculated by computing an average daily amount from the service agreement's frozen bill segments in

the last 365 days. This average is then applied to the number of days in this bill segment's bill period. If the bill segment doesn't have a bill period (rare, but possible), the historical average is not displayed.

- If the bill segment's status is Error, this column also contains the error message.
- Rebilled due to correction appears if a correction note was generated for the bill segment. This remark appears only if you have the Correction Note Billing Option specified in the [Installation](#) record.
- Rebilled due to correction. Canceled after completion appears for a correction note that spawns another correction note. This remark appears only if you have the Correction Note Billing Option specified in the [Installation](#) record.

If more than 25 bill segments are linked to this bill, the grid in the lower right portion of the page contains a summary of the various bill segments linked to the bill.

The following points describe each column in the grid:

- The **Status** column shows the bill segment's status. Refer to [Bill Segment Lifecycle](#) for the possible values. Click on the hyperlink to transfer to the Bill Segments tab where the associated bill segments can be viewed.
- The **Total Bill Segments** column contains the number of bill segments linked to the bill with this **Status**. If the status is Error or Incomplete, this column contains an estimated value of these bill segments. The estimated value is calculated by computing an average daily amount from frozen bill segments in the last 365 days for each service agreement. This average is then applied to the number of days in each bill segment's bill period. Please note, an historical average cannot be computed if an Error or Incomplete bill segment does not have a bill period (rare, but possible).
- The **Total Amount** column contains the sum of the current amount of these bill segments.

At the bottom of the scroll is shown the **Total Generated Charge**. This represents the total amount of the bill segments. This amount may differ from the Total Current Billing Charges when:

- The bill is not Complete. A bill segment's financial effect is not shown on the bill until the bill is completed.
- A bill segment has been canceled / rebilled since the bill was completed.

The topics that follow describe each of the actions that appear in the **Bill SegmentAction** and **Bill Action** areas. Refer to [How To](#) for a description of typical business processes that use these buttons.

Generate

The **Generate** button causes a bill segment to be created for each service agreement linked to the account. The system generates bill segments in the order of the [billing processing sequence](#) on each service agreement's SA type.

This button is enabled when you are in add mode (*i.e.*, you are not displaying an existing bill) and you have selected an **Account ID**.

When clicked, the **Generate** window opens.

You must specify the following parameters in the **Generate** window to generate the bill segments:

- **Cutoff Date** is the last possible day of each bill segments bill period. The current date defaults when the window opens. Refer to [Ways To Control The End Date Of A Bill Segment](#) for more information.
- **Accounting Date** defines the financial period to which the new bill segments' financial transactions are booked. The current date defaults when the window opens.
- Check **Allow Estimates** estimate consumption if it cannot find a meter read.
- If the service agreements use meter reads, use the **Billing Option** to control how the system retrieves meter reads that appear on the bill. Choose Use Cut off Date if the meter reads must exist on the **Cutoff Date** (defined above). Choose Use Schedule if you want the service agreement's service point(s)

After specifying the parameters, click **Calculate** to create a new bill and new bill segments for the account. You see a summary of the bill segments in the lower right portion of the page.

Freeze

Clicking **Freeze** causes all freezable bill segments to become frozen. Refer to [Bill Segment Lifecycle](#) for more information about freezing.

This button is enabled if:

- the Freeze At Will **Bill Segment Freeze Option** on the [installation option](#) has been selected AND
- freezable bill segments exist AND
- there are no error, incomplete or pending cancel bill segments.

NOTE:

Freezing a day or more after generation. If, during freezing, bill segments in closed accounting periods are detected, a pop-up appears in which you can specify a new accounting date; this date is updated onto the offending bill segments. This only happens if the accounting period closes before you freeze the bill segments (the accounting date is stamped on a bill segment when it's generated).

If, after freezing, you're ready to send the bill to the customer click [Complete](#) to finalize the bill.

NOTE:

If problems are detected after freezing. A bill segment may not be changed after it is frozen. All subsequent changes must occur by canceling the frozen bill segment and creating a new bill segment. Refer to [How To Cancel A Bill Segment](#) and [How To Cancel / Rebill A Bill Segment](#) for more information.

Cancel Frozen

Clicking **Cancel Frozen** causes all frozen bill segments to become canceled. Refer to [Bill Segment Lifecycle](#) for more information about cancellation. This button is disabled if the bill is written off.

NOTE:

Pending cancels are not affected. Clicking **Cancel Frozen** does not affect bill segments that are pending cancel. To make a pending cancel bill segment canceled, transfer to [Bill Segment - Main](#) and click [Cancel](#).

If you need to cancel a specific bill segment, either transfer to the next tab and cancel the bill segment in question or follow the instructions under [How To Cancel A Bill Segment](#).

This button is enabled if frozen bill segments are linked to the bill.

When clicked, the **Cancel Frozen Bill Segments** window opens.

In the **Cancel Frozen Bill Segments** window, you must specify the following parameters to cancel the frozen bill segments:

- **Cancel Reason** defines why you are performing the cancellation.
- **Accounting Date** defines the financial period to which the canceled bill segments' financial transactions are booked. The current date defaults when the window opens.

After specifying the parameters, click **Calculate** to cancel the frozen bill segments.

NOTE:

There is no Undo. Unlike cancellations performed on [Bill Segment - Main](#), there is no Undo action. This transaction moves the pending cancel bill segments to the cancel state immediately; whereas the bill segment transaction lets you

examine the cancellation before you commit it. If you cancelled bill segments by mistake, you must generate and freeze new bill segments.

If the bill is pending, the cancellation causes the bill segments to be suppressed on the version of the bill sent to the customer (but they remain in the database for audit and financial reporting purposes).

If the bill is complete and you do not [Reopen](#) the bill, the financial impact of the canceled bill segments appears on the next bill created for the account (under Bill Corrections).

If the bill is complete you may be able to [Reopen](#) the bill and then [Complete](#) it. By doing this, you can suppress a frozen bill segment on a previously completed bill. This means that if you catch a problem after completion you don't necessarily have to show the problem to the customer. Rather, cancel the problem, reopen and then recomplete the bill (when you recomplete the bill the system marks the bill segment to be suppressed on the version sent to the customer because its cancellation appears on the same bill as the original charges).

Freeze / Complete

The **Freeze / Complete** button performs a variety of functions:

- all freezable bill segments (including rebills) become frozen
- all pending cancel bill segments become canceled
- all freezable adjustments whose [adjustment type](#) indicates Freeze At Bill Completion become frozen
- the bill is finalized and marked for transmission to the customer

Refer to [Bill Lifecycle](#) for information about what happens during bill completion. Refer to [Bill Segment Lifecycle](#) for more information about freezing.

This button is enabled if:

- the Freeze At Bill Completion Bill Segment Freeze Option on the [installation option](#) has been selected AND
- the bill is pending AND
- there are no bill segments or there are bill segments and all are freezable, pending cancel, frozen or canceled AND
- there are no error or incomplete bill segments.

When clicked, the **Complete** window opens.

If the **User May Override Bill Date** option has been enabled on the [Installation Record](#), you may override the **Bill Date** prior to completion. Otherwise, the **Bill Date** is the current date and cannot be changed. The current date defaults when the window opens.

NOTE:

Freezing a day or more after generation. If, during freezing, bill segments in closed accounting periods are detected, a pop-up appears in which you can specify a new accounting date; this date is updated onto the offending bill segments. This will only happen if the accounting period closes before you freeze the bill segments (the accounting date is stamped on a bill segment when it's initially generated).

After specifying the parameter, click **Calculate** to freeze and complete the bill.

Complete

The **Complete** button causes a bill to be finalized and marked for transmission to the customer. Refer to [Bill Lifecycle](#) for information about what happens during bill completion.

This button is enabled if:

- the Freeze At Will Bill Segment Freeze Option on the [installation option](#) has been selected AND
- the bill is pending AND
- there are no bill segments or there are bill segments and all are frozen or canceled.

When clicked, the **Complete** window opens.

If the **User May Override Bill Date** option has been enabled on the [Installation Record](#), you may override the **Bill Date** prior to completion. Otherwise, the **Bill Date** is the current date and cannot be changed. The current date defaults when the window opens. If completing a correction note, the user is prompted to enter a **Correction Note Date instead of a bill date** in the **Complete** window.

After specifying the above parameters, click **Calculate** to complete the bill.

Delete

The **Delete** button deletes a bill and its bill segments.

This button is enabled if:

- the bill is pending AND
- all bill segments are incomplete, freezable or in error.

Reopen

The **Reopen** button causes a bill to be reopened. Refer to [Bill Lifecycle](#) for information about why you would reopen a bill.

This button is enabled if:

- the bill is complete AND
- the bill is not written off AND
- this is the most recent bill produced for the account AND
- the bill is not linked to an off cycle bill generator AND
- reopening hasn't been prohibited for the bill. Refer to [Bill Lifecycle](#) for information about conditions that can prevent a bill from reopening.

After reopening a bill, it returns to the pending state and you can make changes to the account's financial transactions (e.g., add payments, adjustments, and bill segments). After which, you click [Complete](#) or [Freeze / Complete](#) to finalize the bill. Only one of these buttons is shown - the specific one depends on how your organization has set the **Bill Segment Freeze Option** on the [installation record](#).

Credit Note

The **Credit Note** button is used to cancel ALL bill segments and create a new bill that contains the cancellation details. We refer to this "negative bill" as a credit note. Refer to [Credit Notes - Presenting Cancellation Details on a Separate Bill](#) for more information.

This button is enabled if:

- the **Use Credit Notes** option on the [Installation](#) record is turned on AND
- the bill is not written off AND

- The bill has frozen bill segments.

To create credit notes for all frozen bill segments, click the **Credit Note** button without selecting any bill segments. A system message asks for confirmation that credit notes will be created for all frozen bill segments.

To create credit notes for specific frozen bill segments, select just those bill segments.

When clicked, the **Credit Note** window opens.

You must specify the following parameters in the **Credit Note** window to cancel the frozen bill segments:

- **Cancel Reason** defines why you are performing the cancellation.
- **Accounting Date** defines the financial period to which the canceled bill segments' financial transactions are booked. The current date defaults when the window opens.
- **Credit Note Date** defines the date of the credit note on which the cancellation details appear. The current date defaults when the window opens.

After specifying the parameters, click **Calculate** to cancel the frozen bill segments and create a credit note.

It should be noted that if this operation is successful, the new "negative bill" is complete. It is ready for transmission to the customer and for interface to the general ledger.

NOTE:

If you want to issue a credit note for a specific bill segment. Rather than cancel all bill segments on a bill, you can create a credit note for a specific bill segment on a bill. To do this, drill down on the bill segment in question and then click the Credit Note button on the [bill segment page](#). You can also issue a credit note for selected bill segments on the next tab by selecting the desired bill segments and clicking the **Credit Note** button.

Correction Note

The **Correction Note** button is used to cancel and rebill ALL bill segments and create a new bill that contains the cancellation and rebill details. We refer to the resultant bill as a correction note. Refer to [Correction Notes - Presenting Correction Notes on a Separate Bill](#) for more information.

This button is enabled if:

- the **Correction Note** Billing Option is specified on the [Installation](#) record AND
- the bill is complete AND
- there is at least one frozen bill segment on the bill or all of the bill's bill segments are frozen or cancelled AND
- there are no bill segment financial transactions that have been transferred out of the system.

When clicked, the **Correction Note** window opens.

You must specify the following parameters in the **Correction Note** window to correct the bill segment:

- **Cancel Reason** defines why you are performing the correction.
- **Cutoff Date** is the last possible day of each bill period for a bill segment. The current date defaults when the window opens. Refer to [Ways To Control The End Date Of A Bill Segment](#) for more information.
- **Accounting Date** defines the financial period that the financial transactions are booked for a bill segment. The current date defaults when the window opens.
- Check **Allow Estimates** estimate consumption if it cannot find a meter read.
- Use the **Billing Option** to define how the system looks for meter reads:
 - Select Use Schedule if the system should select reads based on the SA's SP
 - Select Use Cut off Date if the system should only select reads from the end date of the existing bill segment.

- If you prefer to have the system use the consumption details used on the original bill segments, check **Use Old Read/Item/SQ**. If this switch is on, neither **Allow Estimates** nor **Billing Option** is relevant.

NOTE: The **Use Old Read/Item/SQ** switch is not available if the bill's SA references an SA type with a special role flag of Bill Determinants Required.

- After specifying the parameters, click **Calculate** to correct the bill segments and create a correction note. The Bill Page opens and displays the Correction Note.

Once you complete a correction note, it cannot be reopened.

After you create a correction note, the **Undo Correction Note** button is activated.

The button is enabled if:

- the **Correction Note** Billing Option is specified on the [Installation](#) record AND
- the bill is a correction note AND
- the bill is not linked to an off cycle bill generator AND
- all of the bill segments for the correction note are freezable.

NOTE:

If you want to issue a correction note for a specific bill segment. You can create a correction note for a specific bill segment on a bill. To do this, drill down on the bill segment in question and then click the **Correction Note** button on the [bill segment page](#). You can also issue a correction note for selected bill segments by selecting the desired bill segments and clicking the **Correction Note** button.

Write Off

Refer to [Writing Off Bills](#) for a description of when the **Write Off** button appears and what happens if the button is clicked.

Reverse Write Off

Refer to [Writing Off Bills](#) for a description of when the **Reverse Write Off** button appears and what happens if the button is clicked.

Cancel Bill

Refer to [Idiosyncratic Manual Bill Cancellation](#) for a description of when the **Cancel Bill** button appears and what happens if the button is clicked. Note that if the bill is linked to an off cycle bill generator, this button is not enabled.

Bill - Bill Segments

You can use this page to view all or selected bill segments linked to a bill. In addition, you can also perform certain maintenance functions on this page (see the details below).

Open **Menu > Financial > Bill > Search** and navigate to the **Bill Segments** page to view this information.

NOTE:

If the bill has more than 25 bill segments and you don't use the go to buttons in the bill segment grid on the Main tab to drill over to this information, the search criteria are intentionally left blank in order to avoid retrieving all bill segments (with the resultant slow response times). You must therefore use the **SA Filter** and the **Status Filter** to define the type of bill segments that should be retrieved. See the Description of page below for more information about this page's search criteria.

The Description of page section below describes the fields on this page. Refer to [How To](#) for a description of how to perform common maintenance functions.

Description of page

Bill Info contains a concatenation of important information about the bill (e.g., the bill date, its status, due date, ending balance, etc.).

Bill ID is the system-assigned unique identifier of the bill.

NOTE:

If the bill has more than 25 bill segments and you don't use the hyperlinks in the bill segment grid on the Main tab to drill over to this page, the **Filters** are intentionally left blank in order to avoid retrieving all bill segments (with the resultant slow response times). You must therefore use the **SA Filter** and the **Status Filter** to define the type of bill segments that should be retrieved.

The area beneath **BillInfo** provides you with options that control which bill segments appear in the grid. The following points describe the various options:

- Use the **SA Filter** to define the types of service agreements whose bill segments appear in the grid. The following options are available:
- Address. Use this option to restrict bill segments to those whose service agreements are linked to service points associated with a given **Address**, **City** and/or **Postal** code. Note, you can specify any combination of these fields.
- All. Use this option if you do not wish to restrict bill segments based on service agreement attributes.
- Geographic Type. Use this option to restrict bill segments to those whose service agreements are linked to service points associated with a given **Geo Type** and **Value**.
- SA Type. Use this option to restrict bill segments to those whose service agreements are linked to a given **CIS Division** and **SA Type**.
- Use **Status Filter** to restrict the bill segments based on their status. The following options are available:
- All. This option shows all bill segments regardless of status.
- Refer to [Bill Segment Lifecycle](#) for the various status values.

Don't forget to click the search button after changing the filters.

The **Select All / Clear All** buttons are used to select bill segments if you plan on issuing any of the mass update actions at the bottom of the page. These buttons are enabled if either of the following conditions is true:

- All bill segments that appear in the grid are in the Error, Freezable and/or Incomplete states.
- All bill segments that appear in the grid are in the Frozen state

Refer to the description of the "mass update" actions below for more information.

NOTE:

20 bill segments at a time. Clicking **Select All** selects the first 20 bill segments in the grid. If more than 20 bill segments exist, you must select them in batches.

The grid that follows contains the bill segments that match your search criteria. The following information appears in the grid:

- Select box. See the mass update description immediately above for conditions under which this checkbox can be used to select bill segments for mass update actions.
- The **Bill Segment** column contains a concatenation of the bill segment's division, SA type, status and bill period. The division and SA type come from the bill segment's service agreement. Click the hyperlink to transfer to [Bill Segment - Main Information](#). On this page you can perform maintenance functions (e.g., cancel/rebill, delete, cancel, etc., depending on the segment's status) on the bill segment in question.
- The **Current Amount** column contains the bill segment's effect on the service agreement's current balance.
- The **Status** shows the bill segment's status. Refer to [Bill Segment Lifecycle](#) for the possible values.
- The **Remarks** column highlights special circumstances associated with the bill segment.
- Rebill after completion appears if the bill segment is a rebill that was created after the bill was sent to the customer. The financial impact of this bill segment appears as a "bill correction" on the next bill produced for the customer.
- Rebill prior completion appears if the bill segment is a rebill that was created before the bill was sent to the customer.
- Canceled after completion appears if the bill segment was canceled after the bill was sent to the customer. The financial impact of this bill segment appears as a "bill correction" on the next bill produced for the customer.
- Canceled prior completion appears if the bill segment was canceled before the bill was sent to the customer.
- If the bill segment's status is Error or Incomplete, this column contains an estimated value of this bill segment. The estimated value is calculated by computing an average daily amount from the service agreement's frozen bill segments in the last 365 days. This average is then applied to the number of days in this bill segment's bill period. If the bill segment doesn't have a bill period (rare, but possible), the historical average is not displayed.
- If the bill segment's status is Error, this column also contains the error message.
- Rebilled due to correction note appears if the correction note was generated for the bill segment. This remark is generated only if you have Correction Note specified in the [Installation](#) record.
- Rebilled due to correction. Canceled after completion appears for a correction note that spawns another correction note. This remark is generated only if you have Correction Note specified in the [Installation](#) record.
- The **Service Quantity** and **UOM** (unit of measure) columns contain the amount of consumption that was billed. The UOM is defined on the service agreement's [SA type](#).
- The **Bill Segment ID** is the system-assigned unique identifier of the bill segment.

This transaction has sophisticated logic that can be used to perform "mass updates" to the bill segments that appear in the grid (using the buttons at the bottom of the page). The following points describe these mass update actions:

Generate (Bill - Bill Segments)

The **Generate** button is used to delete and recreate one or more bill segments. This button is enabled if you select at least one row from the bill segments grid that's in the Error, Freezable and/or Incomplete state.

Note that you can only select a bill segment for regeneration if ALL bill segments in the grid are in the Error, Freezable and/or Incomplete states. Note, you can use the **Status Filter** to restrict the type of bill segments in the grid.

When clicked, the **Generate** window opens.

You must specify the following parameters in the **Generate** window to regenerate a new bill:

- **Accounting Date** defines the financial period to which the new bill segments' financial transactions will be booked. The current date defaults when the window opens.
- Check **Allow Estimates** estimate consumption if it can't find a meter read.
- If the service agreements use meter reads, use the **Billing Option** to control how the system retrieves meter reads that appear on the bill. Choose Use Cut off Date if the meter reads must exist on the **Cutoff Date** (defined above). Choose Use Schedule if you want the service agreement's service point(s)

After specifying the parameters, click **Calculate** to regenerate the selected bill segments. A summary of what the system does is presented next.

Freeze (Bill - Bill Segments)

The **Freeze** button is used to freeze one or more bill segments. This button is enabled if you select at least one row from the bill segments grid that's in the Freezable state AND the [installation option](#) indicates users are allowed to "freeze at will".

Note that you can only select a bill segment for freezing if ALL bill segments in the grid are in the Freezable state. Note, you can use the **Status Filter** to restrict the type of bill segments in the grid.

When clicked, the **Freeze** window opens.

Accounting Date is used to define the financial period to which the frozen bill segments' financial transactions are booked. The current date defaults when the window opens.

After specifying the above parameters, click **Freeze** to freeze the selected bill segments. A summary of what the system does is presented next.

Delete (Bill - Bill Segments)

The **Delete** button is used to delete one or more bill segments. This button is enabled if you select at least one row from the bill segments grid that's in the Error, Freezable and/or Incomplete state.

Note that you can only select a bill segment for deletion if ALL bill segments in the grid are in the Error, Freezable and/or Incomplete states. Note, you can use the **Status Filter** to restrict the type of bill segments in the grid.

If the system is successful in deleting the selected bill segment(s), a confirmation window summarizes what the system just did (i.e., it shows the number of bill segments that were deleted).

Cancel/Rebill/Freeze (Bill - Bill Segments)

If problems are detected with a frozen bill segment, it should be canceled and a new bill segment should be created. We refer to this process as cancel / rebill. Refer to [Cancel / Rebill Incorrect Bill Segments](#) for more information.

Before you cancel / rebill, you'll probably need to fix the cause of the problem. The following table describes common problems and how to fix them.

Problem	How To Fix It
The wrong rate was used	Go to Service Agreement - Rate Info and correct the rate.
The wrong meter was connected to the service point	
A contract rider was applied incorrectly	Go to Service Agreement - Rate Info and correct the contract rider information.
The wrong tax exemption amount was calculated	Go to Service Agreement - Rate Info and correct the tax exemption information.

NOTE:

Multi-Cancel/Rebill Saves Time. If the cause of the problem impacts many bill segments related to a service agreement, you should use the [Multi Cancel Rebill](#) transaction as it allows you to cancel / rebill an unlimited number of bill segments at once.

Credit Notes. Using the cancel/rebill functionality causes the cancel and rebill details to be swept on to the customer's next bill unless you [Reopen](#) the bill. If your organization requires cancellation details to be presented to the customer separately from the new bill, you should not use the **Rebill** functionality. Rather, you should issue a [Credit Note](#) and then generate a new bill containing the revised charges.

The **Cancel/Rebill/Freeze** button is used to cancel, rebill and freeze one or more bill segments. This button is enabled if you select at least one row from the bill segments grid that's in the Frozen state AND the bill is not written off.

Note that you can only select a bill segment for cancel/rebill/freeze if ALL bill segments in the grid are in the Frozen state. Note, you can use the **Status Filter** to restrict the type of bill segments in the grid.

When clicked, the **Cancel/Rebill/Freeze** window opens.

- **Cancel Reason** defines why the bill segment(s) are being canceled.
- **Accounting Date** defines the financial period to which the canceled and new bill segments' financial transactions are booked. The current date defaults when the window opens.
- Check **Allow Estimates** estimate consumption if it cannot find a meter read.
- Use the **Billing Option** to define how the system looks for meter reads:
 - Select Use Schedule if the system should select reads based on the SA's SP
 - Select Use Cut off Date if the system should only select reads from the end date of the existing bill segment.
 - If you prefer to have the system use the consumption details used on the original bill segments, check **Use Old Read/Item/SQ**. If this switch is on, neither **Allow Estimates** nor **Billing Option** is relevant.

NOTE: The **Use Old Read/Item/SQ** switch is not available if the bill's SA references an SA type with a special role flag of Bill Determinants Required.

WARNING:

If the cause of the rebill is an incorrect rate and the new rate requires service quantities that were not calculated when the bill was originally calculated, do not turn on **Use Old Read/Item/SQ**. Why? Because you want the system to derive new service quantities during the rebill process.

After specifying the parameters, click **Calculate** to cancel, rebill and freeze the selected bill segments.

NOTE:

Errors. Bill segment errors may occur when you cancel / rebill the bill segments. For example, if you change the SA's rate to a rate that requires a unit-of-measure that doesn't exist on the SA's meter, a bill segment error is generated. If this occurs, you must go to [Bill Segment - Main](#) for the pending cancel bill segment and use the **Undo** action to remove the offending bill segment (and restore the original segment to the Frozen state). Alternatively, you can drill down on the Error bill segment and use the **Regenerate** action after correcting the cause of the problem.

There is no Undo. Unlike cancel / rebills performed on [Bill Segment - Main](#), there is no Undo action. This is because this transaction freezes the newly created bill segments after it cancel/rebills; whereas the bill segment transaction lets you examine the new bill segment before you freeze it. If you made a mistake, simply correct the cause of the mistake and then cancel / rebill again. The erroneous financial transactions are automatically suppressed on the next bill produced for the customer.

A confirmation window summarizes what the system just did (i.e., it shows the number of bill segments that were deleted / generated).

Cancel (Bill - Bill Segments)

The **Cancel** button is used to cancel one or more bill segments. This button is enabled if you select at least one row from the bill segments grid that's in the Frozen state AND the bill is not written off.

Note that you can only select a bill segment for cancellation if ALL bill segments in the grid are in the Frozen state. Note, you can use the **Status Filter** to restrict the type of bill segments in the grid.

When clicked, the **Cancel** window opens.

- **Cancel Reason** defines why the bill segment(s) are being canceled.
- **Accounting Date** is used to define the financial period to which the canceled bill segments' financial transactions are booked. The current date defaults when the window opens.

After specifying the above parameters, click **Calculate** to cancel the selected bill segments.

NOTE:

There is no Undo. Unlike cancellations performed on [Bill Segment - Main](#), there is no Undo action. This transaction moves the pending cancel bill segments to the cancel state immediately; whereas the bill segment transaction lets you examine the cancellation before you commit it. If you cancelled bill segments by mistake, you must generate and freeze new bill segments.

Credit Note (Bill - Bill Segments)

The **Credit Note** button is used to cancel selected bill segments and create a new bill that contains the cancellation details. We refer to this "negative bill" as a credit note. Refer to [Credit Notes - Presenting Cancellation Details on a Separate Bill](#) for more information.

This button is enabled if:

- the **Use Credit Notes** option on the [Installation](#) record is turned on AND
- if you select at least one row from the bill segments grid that's in the Frozen state AND
- the bill is not written off.

Note that you can only select a bill segment for this action if ALL bill segments in the grid are in the Frozen state. Note, you can use the **Status Filter** to restrict the type of bill segments in the grid.

When clicked, the **Credit Note** window opens.

You must specify the following parameters in the **Credit Note** window to cancel the frozen bill segments:

- **Cancel Reason** defines why you are performing the cancellation.
- **Accounting Date** defines the financial period to which the canceled bill segments' financial transactions are booked. The current date defaults when the window opens.
- **Credit Note Date** defines the date of the credit note on which the cancellation details appear. The current date defaults when the window opens.

After specifying the parameters, click **Calculate** to cancel the frozen bill segments and create a credit note.

It should be noted that if this operation is successful, the new "negative bill" is complete. Refer to [Bill Lifecycle](#) for information about the steps that take place during completion. It is ready for transmission to the customer and for interface to the general ledger.

NOTE:

If you want to issue a credit note for an entire bill. Rather than cancel a specific bill segment, functionality exists that allows you to create a credit note for ALL bill segments on a bill. To use this feature, display the bill in question and then click the Credit Note button on the [bill page](#).

Correction Note (Bill - Bill Segments)

The **Correction Note** button is used to cancel and rebill bill segments and create a new bill that contains the cancellation and rebill details. We refer to the resultant bill as a correction note. Refer to [Correction Notes - Presenting Correction Notes on a Separate Bill](#) for more information. This button is enabled if:

- the **Correction Note** option is specified on the [Installation](#) record AND
- the bill is complete AND
- the bill segment is frozen AND
- there are no bill segment financial transactions that have been transferred out of the system.

When clicked, the **Correction Note** window opens.

You must specify the following parameters in the **Correction Note** window to correct the bill segment:

- **Cancel Reason** defines why you are performing the correction.
- **Cutoff Date** is the last possible day of each bill segments bill period. The current date defaults when the window opens. Refer to [Ways To Control The End Date Of A Bill Segment](#) for more information.
- **Accounting Date** defines the financial period to which the corrected bill segments' financial transactions are booked. The current date defaults when the window opens.
- Check **Allow Estimates** estimate consumption if it cannot find a meter read.
- Use the **Billing Option** to define how the system looks for meter reads:
 - Select Use Schedule if the system should select reads based on the SA's SP measurement cycle schedule.
 - Select Use Cut off Date if the system should only select reads from the end date of the existing bill segment.
- If you prefer to have the system use the consumption details used on the original bill segments, check **Use Old Read/Item/SQ**. If this switch is on, neither **Allow Estimates** nor **Billing Option** is relevant.

NOTE: The **Use Old Read/Item/SQ** switch is not available if the bill's SA references an SA type with a special role flag of Bill Determinants Required.

- After specifying the parameters, click **Calculate** to correct the bill segments and create a correction note. The Bill Page opens and displays the Correction Note.

NOTE:

If you want to issue a correction note for an entire bill. You can create a correction note for ALL bill segments on a bill. To use this feature, display the bill in question on the [Bill page](#) and click the **Correction Note** button.

Bill - Bill Routings

This page is used to view the recipients of a bill. Refer to [Printing Bills](#) for a discussion of how this information is used to produce bill images.

This page is also used to request a new copy of a bill. Refer to [How To Reprint A Bill \(For The Original Recipients or For Someone New\)](#) for a description of how to do this.

NOTE:

No routing information until completion. A bill has no routing details until it is completed. At completion time, the system creates a routing detail for every person linked to the account that receives a copy of its bills. Refer to [The Source Of Bill Routing Information](#) for more information about how this information is constructed.

Use **Menu > Financial > Bill > Search** and navigate to the **Bill Routings** page.

Description of Page

Bill Info contains a concatenation of important information about the bill (e.g., the bill date, its status, due date, ending balance). If [sequential bill numbering](#) has been enabled, the bill's number also appears.

Bill ID is the system-assigned unique identifier of the bill.

The **Bill Routing Information** scroll contains an entry for each recipient of the bill. This information is disabled after the bill has been routed to the recipient. The remainder of this discussion describes the fields that can be defined for each recipient of the bill.

Person ID identifies the person who was originally associated with the routing record. You may change the **Person ID** to any person in the system as this information is only used to default the recipient's name and address information, below.

The **Bill Routing Parameters** area contains information explaining how and when the bill is routed to the recipient. This information is gray when the bill routing information has been extracted or if a bill is reopened:

- **Bill Route Type** is the method used to transmit the bill to the customer. If the **Person ID** is linked to the account, the bill route type defaults from the person's [Account - Person Information](#).
- **Sequence** is the system-assigned identifier assigned to this bill routing.
- **Batch Control** is the identifier of the batch of bills in which the recipient's copy was downloaded. The batch process is defined on the **Bill Route Type** or CIS Division.
- **Extract Date/Time** is the date and time the bill was downloaded. This information only appears after the download has commenced.
- **Format** indicates if the customer should receive a Detailed or a Summary bill. If the **Person ID** is linked to the account, this information defaults from [Account - Person Information](#).
- **Reprint** is checked if a user created this routing. This switch is populated by the system and is always protected.
- Turn on **Do Not Extract** if the bill should not be routed to the individual for whatever reason.
- **Copies** indicates the number of copies of the bill the person receives. If the **Person ID** is linked to the account, this information defaults from [Account - Person Information](#).
- **PO ID** is the purchase order Id the customer wants printed on their copy of the bill. If the **Person ID** is linked to the account, this information defaults from [Account - Person Information](#).
- **Intercept** is the User ID of the individual who wants to review the bill before it is sent to the customer. This field is automatically populated when the account has a Bill Print Intercept specified (intercept information is defined on [Account - Main Information](#)). For a one-time intercept, a user can enter their ID in this field before the bill, or reprint, has been extracted.

NOTE: Adding a User ID to the Intercept field will not automatically populate the Bill Print Intercept field on the Account's Main page; nor, will it affect future bill routings.

The **Mailing Address Information** area contains the recipient's name and address.

- If the recipient has an [override mailing name](#), **Name1**, **Name2** and **Name3** contain the person's override mailing name. Otherwise, **Name1** contains the recipient's primary name (this name might also include a prefix or suffix if the related [Account - Person](#) relationship has these fields defined).

- The remaining fields are the recipient's address. Refer to [The Source Of Bill Routing Information](#) for information about how the system constructs the recipient's address. Note:
- If the recipient's address is a mailing address (as opposed to fax or email), the **Country** associated with the address controls the fields that appear in the address. Refer to [Defining Countries](#) for more information on the address constituents.
- If a user manually adds a routing record, the mailing address information defaults from the information on the current routing record.
- If a user specifies a **Person ID** that is linked to the bill's account, the **Bill Route Type** defined on the [Account - Person](#) record is defaulted.
- If a user specifies a **Person ID** that is not linked to the bill's account, the **Bill Route Type** on the [installation record](#) is defaulted. Note, if the bill route indicates the bill is routed via the postal service, the system will only be able to default the person's address if the person has an override mailing address on their [correspondence information](#).
- If the user changes the **Bill Route Type** after the initial default, the system populates the address information as described under [The Source Of Bill Routing Information](#).
- The Validate button on the bill page will only be available if you have set the Allow Address Validation option type to Y on the General System Configuration feature configuration. Once clicked, the Address Validation Script on the General System Configuration feature configuration will be invoked to validate the entered address. Refer to [Implementing Address Validation](#) for more information.

Bill - Bill Messages

The Messages page is a grid containing one row for every message that appears on the bill. Open **Menu > Financial > Bill > Search** and navigate to the **Bill Messages** page to view this information.

NOTE:

No messages until completion. A bill has no messages until it is completed (unless you insert them manually). At completion time, the system assembles messages from the various message sources. Refer to [The Source Of Bill Messages](#) for information about these sources.

The bill segment(s) may also have messages. Be aware that only account-oriented messages are linked to a bill. There may also be service agreement-oriented messages linked to the bill's bill segments. Refer to [Bill - Bill Messages](#) for information about the page on which service agreement-oriented messages are displayed. Refer to [The Source Of Bill Messages](#) for information about the various message sources and whether each is linked to a bill or a bill segment.

Bill messages may contain dynamic information. Refer to [Substituting Field Values Into A Bill Message](#) for more information.

The **Description of Page** section below describes the fields on this page. Refer to [How To Add Ad Hoc Messages To A Bill](#) for a description of how to perform common maintenance functions.

Description of Page

Bill Info contains a concatenation of important information about the bill (e.g., the bill date, its status, due date, ending balance). If [sequential bill numbering](#) has been enabled, the bill's number also appears.

Bill ID is the system-assigned unique identifier of the bill.

The following columns are displayed in the grid:

- **Bill Message** is the code that identifies the bill message.
- **Message On Bill** is the message associated with the code.
- **Priority** is the bill messages priority (on the printed bill).

- **Insert Code** defines if the bill message causes an insert in the envelope.

Bill - Characteristics

The Characteristics page is a grid containing one row for each characteristic linked to the bill. Bill characteristics are purely informational.

NOTE:

You can only choose characteristic types defined as permissible on a bill record. Refer to [Setting Up Characteristic Types and Their Values](#) for more information.

Open **Menu > Financial > Bill > Search** and navigate to the **Characteristics** page to view this information.

Description of Page

The following fields display on the grid:

- **Characteristic Type** must be a type of characteristic defined as permissible on a bill record.
- **Sequence** Controls the order in which characteristics of the same type are displayed.
- **Characteristic Value** indicates the value of the characteristic if the characteristic type is pre-defined or foreign key reference.

How To

The topics in this section describe how to perform common bill maintenance functions.

How To Create A Bill For All Service Agreements Linked To An Account

99.9% of all bills are created by the batch bill process and require no human intervention before they are finalized and sent to a customer. The other 0.1% are created by users on-line / real time. This section explains how to create the 0.1%.

The following points describe how to use this page to create a new bill:

- Navigate to the [Bill - Main Information](#) page:
- If you have already selected the customer (say on Control Central), select **Go To Bill > Add** option on the account context menu. [context menu](#). This will transfer you to this page with the respective account populated.
- If you haven't selected the account, use Menu to navigate to this page (**Menu > Financial > Bill > Add**) and then select the **Account ID** using the adjacent [search button](#).
- Click the [Generate](#) button to create a new bill.
- You will see a summary of the bill segments in the lower right portion of the page. If there are errors, refer to [How To Correct A Bill Segment That's In Error](#). If there are no errors, the **Bill Segment Freeze Option** on the [installation option](#) controls the next step:
- If this option is set to Freeze At Bill Completion, click the [Freeze / Complete](#) button.
- If this option is set to Freeze At Will, click the [Freeze](#) button and, if everything looks clean, click the [Complete](#) button.

How To Create A Bill For A Specific Service Agreement

Most bills contain a bill segment for every service agreement linked to the account. If you want to produce a bill that contains bill segments for a subset of service agreements (e.g., you want to create a one-time invoice for an account's billable charge service agreement), follow these steps:

- Navigate to the [Bill - Main Information](#) page:
- If you have already selected the customer (say on Control Central), select **Go To Bill > Add** option on the account context menu. [context menu](#). This will transfer you to this page with the respective account populated.
- If you haven't selected the account, use Menu to navigate to **Menu > Financial > Bill > Add**, and then select the **Account ID** using the adjacent [search button](#).
- Click the [save](#) button to create a bill without bill segments for the account.
- Select Go To Bill Segment + option on the Bill's [context menu](#) to transfer to [Bill Segment - Main](#).
- Select the **SA ID** of the service agreement for which you want to create a bill segment.
- Click the [Generate](#) button to generate a bill segment.
 - If an error exists, refer to [How To Correct A Bill Segment That's In Error](#).
 - If there are no errors, the **Bill Segment Freeze Option** on the [installation option](#) controls the next step:
 - If this option is set to Freeze At Bill Completion, return to [Bill - Main](#) (using the bill context menu) and click the [Freeze / Complete](#) button.
 - If this option is set to Freeze At Will, click the [Freeze](#) button and, if everything looks clean, return to [Bill - Main](#) and click the [Complete](#) button.

How To Create a Bill with no Bill Segments

You may wish to generate a bill that contains no bill segments. For example, perhaps your customer is billed quarterly but pays monthly. During the months where no charges are calculated, you may choose to send a "bill" that does not show new charges, but includes the payments received. To produce a bill with no bill segments, follow these steps:

- Navigate to the [Bill - Main Information](#) page:
- If you have already selected the customer (say on Control Central), select **Go To Bill > Add** option on the account context menu. [context menu](#). This will transfer you to this page with the respective account populated.
- If you haven't selected the account, use Menu to navigate to this page (**Menu > Financial > Bill > Add**) and then select the **Account ID** using the adjacent [search button](#).
- Click the [save](#) button to create a bill without bill segments for the account.
- At this point either the **Complete** or **Freeze / Complete** button (based on the value of Bill Segment Freeze Option on [installation options](#)) becomes enabled. Click the applicable button for your installation to complete the bill. At this point, all the steps described for completing a bill in Bill Lifecycle are performed, including sweeping onto the bill any payments received since the last bill was generated.

How To Create A One-Time Invoice

The following points describe the steps necessary to create and bill a one-time invoice:

- If the customer to be invoiced doesn't already have an appropriate billable charge service agreement, create one. The easiest way to do this is from [Start/Stop Service](#).
- Use [Maintaining Billable Charges](#) to add a billable charge for the service agreement. The billable charge contains the invoice lines and amounts. The system will produce the bill for this charge when the account's bill cycle next executes. If you can't wait until that time, proceed to the next step.
- If you created a new billable charge service agreement in step 1, you must activate it before billing can bill it. To do this, transfer to [Service Agreement - Main Information](#) and click the activate button.
- Refer to [How To Create A Bill For A Specific Service Agreement](#) for instructions describing how to create a bill with a bill segment for the billable charge service agreement.

How To Correct A Bill Segment That's In Error

A bill segment will exist in the Error state if a problem was encountered during the generation of a bill segment. To fix an error bill segment you must correct the cause of the error and then regenerate the bill segment. Refer to [Bill Segment Errors](#) for background information.

NOTE:

Error segments created during batch billing. If the error bill segment was created as part of the batch bill process, the system attempts to fix the offending segment(s) each night during the account's bill window by regenerating it. Therefore, if the cause of the error is fixed during the day, the system will automatically regenerate the bill segment when batch billing next runs; you don't have to manually correct each bill. And once a bill is error-free, it will be completed and sent to the customer. Refer to [Batch Billing](#) for more information.

Correcting the cause of a bill segment error can be difficult or trivial; we hope that the error messages (along with their long descriptions) provide a good description of how to resolve the issue.

After you have corrected the cause of the error, you should regenerate the bill segment. There are two ways to do this:

- You can use the [Generate](#) action on [Bill - Bill Segment](#) to regenerate one or more bill segments. We recommend using this method if the cause of the error affected many bill segments because you can regenerate many bill segments at a time on this page. Also, be aware that this transaction shows the estimated value of error bill segments so you can gauge whether to invest a lot of time in correcting the problem. For example, if the bill segment's estimated value is \$10,000, it's probably worth correcting the problem before sending the bill out. However, if the bill segment's value is small, you may decide to simply delete the error bill segment and send the bill without it (the system will attempt to create a bill for the deleted period the next time the account is billed).
- You can use the [Generate](#) action on [Bill Segment - Main](#) to regenerate an individual bill segment. We'd recommend using this method if the problem is bill segment-specific and you need to examine the information that is snapshot on the bill segment to resolve the error (e.g., you need to look at and service quantities).

NOTE:

Drilling Into Bill Segment Errors. When you use the bill segments in error To Do list to work through errors, you will be transferred to [Bill Segment - Main](#) with the bill segment displayed.

After all errors have been resolved on a bill, return to [Bill - Main](#). The **Bill Segment Freeze Option** on the [installation option](#) controls the next step:

- If this option is set to Freeze At Bill Completion, click the [Freeze / Complete](#) button.
- If this option is set to Freeze At Will, click the [Freeze](#) button and, if everything looks clean, click the [Complete](#) button.

How To Correct A Bill That's In Error

Besides errors on bill segments, there may also be errors detected when the system attempts to complete a bill. For example, if the system cannot find a mailing address, the bill will be in error (as opposed to one of its bill segments). Refer to [Bill Errors](#) for background information.

To correct such an error:

- Navigate to [Bill - Main](#).
- Look at the bill's error message. Push the view button to view the long explanation that will provide suggestions as to the cause of the error (and how to fix it). Transfer to the appropriate page to fix the problem.
- After fixing the cause of the error, return to [Bill - Main](#). The **Bill Segment Freeze Option** on the [installation option](#) controls the next step:
- If this option is set to Freeze At Bill Completion, click the [Freeze / Complete](#) button.
- If this option is set to Freeze At Will, click the [Freeze](#) button and, if everything looks clean, click the [Complete](#) button.

How To Cancel A Bill Segment

If a bill segment was frozen and it should never have been created in the first place, the bill segment must be canceled.

There are several ways to do this:

- You can use the [Cancel Frozen](#) action on [Bill - Main](#) to cancel all frozen bill segments linked to the bill. We recommend using this method if you need to cancel everything on a bill.
- You can use the [Cancel](#) action on [Bill - Bill Segments](#) to cancel selected bill segments. We recommend using this method if you need to cancel multiple bill segments.
- You can use the [Cancel](#) action on [Bill Segment - Main](#) to cancel an individual bill segment. We'd recommend using this method if you need to examine the information on the bill segment before canceling it.

If the related bill is pending, the cancellation will cause the bill segment to be suppressed on the version of the bill sent to the customer (but it remains in the database for audit and financial reporting purposes).

If the related bill is complete and you do not [Reopen](#) the bill, the financial impact of the canceled bill segment(s) will appear on the next bill created for the account (under Bill Corrections).

If the related bill is complete you may be able to [Reopen](#) the bill and then [Complete](#) it. By doing this, you can suppress a frozen bill segment on a previously completed bill. This means that if you catch a problem after completion you don't necessarily have to show the problem to the customer. Rather, cancel the problem, reopen and then recomplete the bill (when you recomplete the bill the system will mark the bill segment to be suppressed on the version sent to the customer because its cancellation appears on the same bill as the original charges).

How To Cancel / Rebill A Bill Segment

If a bill segment was frozen but it contains incorrect information, it should be canceled and a new bill segment should be created. We refer to this process as cancel / rebill. Refer to [Cancel / Rebill Incorrect Bill Segments](#) for more information.

Before you cancel / rebill, you must correct the cause of the problem. The following table describes common problems and where to go to fix them.

Problem	How To Fix It
---------	---------------

The wrong rate was used	Go to Service Agreement - Rate Info and correct the rate.
The wrong meter was connected to the service point	
A contract rider was applied incorrectly	Go to Service Agreement - Rate Info and correct the contract rider information.
The wrong tax exemption amount was calculated	Go to Service Agreement - Rate Info and correct the tax exemption information.

After correcting the cause of the problem, you're ready to cancel and rebill the offending bill segment(s). There are several ways to do this:

- You can use the [Cancel / Rebill / Freeze](#) action on [Bill - Bill Segments](#) to cancel, rebill and freeze selected bill segments. We recommend using this method if you need to cancel / rebill multiple bill segments due to a pervasive problem.
- You can use the [Rebill](#) action on [Bill Segment - Main](#) to cancel and rebill an individual bill segment. We'd recommend using this method if you need to examine the information on the bill segment before and after canceling it. If you use this method, you must also use the [Freeze](#) action to freeze the newly created bill segment.
- If the cause of the problem impacts many bill segments related to a service agreement, you should use the [Multi Cancel Rebill](#) transaction as it allows you to cancel / rebill an unlimited number of bill segments at once. Also note that for service agreements that require bill determinants from Oracle Utilities Meter Data Management, this transaction may only be used to cancel / rebill a single bill segment at a time.

If the related bill is pending, the cancellation will cause the erroneous bill segment to be suppressed on the version of the bill sent to the customer (but it remains in the database for audit and financial reporting purposes).

If the related bill is complete and you do not [Reopen](#) the bill, the financial impact of the canceled bill segment(s) and their rebill bill segment(s) will appear on the next bill created for the account (under Bill Corrections).

If the related bill is complete you may be able to [Reopen](#) the bill and then [Complete](#) it. By doing this, you can suppress an erroneous frozen bill segment on a previously completed bill. This means that if you catch a problem after completion you don't necessarily have to show the problem to the customer. Rather, cancel / rebill the problem, reopen and then recomplete the bill (when you recomplete the bill the system will mark the bill segment to be suppressed on the version sent to the customer because its cancellation appears on the same bill as the original charges).

How To Create A Credit Note

A credit note is used to cancel bills segments and present the results of this cancellation on a separate bill. This separate bill is referred to as a credit note. Refer to [Credit Notes - Presenting Cancellation Details on a Separate Bill](#) for more information.

NOTE:

Installation option must be turned on. If your organization creates credit notes, be sure to select the Credit Note Billing Option on the [Installation Options](#). If you don't select this option, the credit note buttons will not be enabled.

Before creating a credit note, you must first determine whether a single bill segment must be canceled or whether all bill segments for a bill must be canceled:

- If you need to issue a credit note for the entire bill, navigate to the [Bill](#) page and click the [Credit Note](#) button.
- If you need to issue a credit note for a specific bill segment, navigate to the [Bill Segment](#) page and click the [Credit Note](#) button.

NOTE:

Open-item customers. If any of the bill segments are associated with an open-item customer class AND the original bill segment is an open item, the match event will be created and balanced with the original FT and the cancellation FT, assuming you have the appropriate FT freeze algorithm plugged-in on the customer class.

Issuing a credit note for a specific bill segment. You may also issue a credit note for an individual bill segment. When you create a credit note for an individual bill segment, that bill segment is canceled and a new credit note bill is created for that single bill segment's cancellation information.

How To Create A Correction Note

The **Correction Note** button is used to cancel and rebill bill segments and present the cancellation and rebill details on a separate bill. Refer to [Correction Notes - Presenting Correction Notes on a Separate Bill](#) for more information.

NOTE:

Installation option must be turned on. If your organization creates correction notes, be sure to select the Correction Note Billing Option on the [Installation Options](#). If you don't select this option, the correction note buttons will not be enabled.

Before creating a correction note, you must first determine whether the note should impact a single bill segment or whether all bill segments for a bill must be corrected:

- If you need to issue a correction note for the entire bill, navigate to the [Bill](#) page and click the [Correction Note](#) button.
 - If you need to issue a correction note for a specific bill segment, navigate to the [Bill Segment](#) page and click the [Correction Note](#) button.
-

NOTE:

Open-item customers. If any of the bill segments are associated with an open-item customer class AND the original bill segment is an open item, the match event will be created and balanced with the original FT and the cancellation FT, assuming you have the appropriate FT freeze algorithm plugged in on the customer class.

Issuing a correction note for a specific bill segment. You can also issue a correction note for an individual bill segment. When you create a correction note for an individual bill segment, that bill segment is canceled and a new correction note bill is created for that single bill segment's cancellation information.

How To Create An Off Cycle Bill Generator

An off cycle bill generator is used to create an off cycle bill for an account. You control the financial transactions that are linked to the bill. To create a bill using the base off cycle bill generator business object, follow these steps:

- With an account in context, select **Account Context Menu > Go To Off Cycle Bill Generator** +.(*See [context menu](#) for more information about Context Menus.*) This will transfer you to this portal with the respective account populated.
 - Select the adjustments, billable charges and/or service agreements that you wish to include in the bill.
 - Enter the required bill information to be used when creating the bill; this includes the Cutoff Date, Accounting Date, Allow Estimates switch, Billing Option and Bill Date.
 - Click the [save](#) button.
 - Click the Complete button to transition the off cycle bill generator to the complete state and create the bill. Any errors encountered while attempting to create the bill will be captured in the off cycle bill generator's log.
 - Refer to [Off Cycle Bill Generator](#) for more information.
-

How To Override The Items Billed On A Specific Bill Segment

The used by the customer is one of the first steps that happens when a bill segment is created. 99.9% of the time, the system does a perfect job in this effort. However, there are rare circumstances when, due to missing or incorrect data, the quantity calculated by the system is not correct.

To help you deal with these rare situations, a "back door" exists that allows a bill segment's billable quantities to be overridden. This truly is a "back door" because the proper way to fix the amount of a commodity is to correct the cause of the error and then cancel / rebill the bill segment.

This section describes how to override the total number of items billed on a bill segment. You would do this in the rare situation when you cannot get the [item snapshot](#) to reflect the amount of consumption you need to bill.

- Display the error or freezable bill segment on [Bill Segment - Main](#).

IMPORTANT:

You can only override consumption on a bill segment that is in Error or Freezable. This means you must generate a bill segment before you can override the item details.

- Transfer to the [Bill Segment - Item Details](#) tab.
- Insert one row in the item grid (click the + button) for each item you need to add. You may also change item amounts that were populated by the system when it initially generated the bill.
- Save the bill segment.
- [Generate](#) the bill segment.
- If the bill segment still looks wrong, repeat the above points until the bill segment is correct.
- The **Bill Segment Freeze Option** on the [installation option](#) controls the next step:
- If this option is set to Freeze At Bill Completion, return to [Bill - Main](#) (using the bill context menu) and click the [Freeze / Complete](#) button.
- If this option is set to Freeze At Will, click the [Freeze](#) button and, if everything looks clean, return to [Bill - Main](#) and click the [Complete](#) button.

How To Remove Unwanted Adjustments (or Payments) From A Completed Bill

If the system (or a user) has created adjustments that have been swept onto a recently completed bill but you don't want them to appear on the bill (e.g., the system generated a late payment charge but you want to forgive it) perform the following steps:

- Cancel the adjustment ([Adjustment - Main Information](#)).
- Navigate to the [Bill - Main](#) page.
- Click the [Reopen](#) button to reopen the previously completed bill.
- Click the [Complete](#) button to recomplete the bill. When the bill is recompleted, the system will see that an adjustment that was swept onto the bill when it was originally completed has been canceled and it will mark the adjustment for suppression on the printed bill.

You can remove unwanted payments using an analogous approach - Cancel the payment, Reopen the bill, Complete the bill.

NOTE:

Cannot reopen historical bills. You may only reopen an account's most recent bill because recompleting the bill causes the ending-balance to change, and we don't want this to happen to historical bills.

How To Add An Adjustment (or Payment) To A Completed Bill

If you want to add an adjustment to a completed bill perform the following steps:

- Add and freeze the adjustment ([Adjustment - Main Information](#)).
- Navigate to the [Bill - Main](#) page.
- Click the [Reopen](#) button to reopen the previously completed bill.
- Click the [Complete](#) button to recomplete the bill. When the bill is recompleted, the system will sweep the recently created financial transactions onto itself.

You can add a payment to a bill using an analogous approach - Add the payment, Reopen the bill, Complete the bill.

NOTE:

Cannot reopen historical bills. You may only reopen an account's most recent bill because recompleting the bill causes the ending-balance to change, and we don't want this to happen to historical bills.

How To Reprint A Bill (For The Original Recipients or For Someone New)

A copy of a bill is sent to every individual / business specified in the [bill's routing details](#). The system creates the routing details when a bill is completed. Refer to [The Source Of Bill Routing Information](#) for more information about how this information is compiled during bill completion.

If you want to reprint a bill OR if you want to send a bill to someone other than the original recipient(s):

- Navigate to the [Bill - Main](#) page.
 - Transfer to the [Bill - Bill Routings](#) tab.
 - Insert a new row (click the + button). Note well, you can only insert information on a bill that is Complete.
 - Specify the name and address to which the bill should be sent. If you want to send the bill to someone other than the original recipient, simply specify the individual's name and address. If the recipient is a person in the system, you can select their person ID and let the system default this information for you.
 - Save the bill.
-

NOTE:

If a bill is Complete but the print process hasn't yet executed, you don't have to insert a new routing row. Rather, you can simply change the name and address on the original routing details.

How To Add Ad Hoc Messages To A Bill

If you want to add a message to a completed bill:

- Navigate to the [Bill - Main](#) page.
 - Transfer to the [Bill - Bill Messages](#) tab.
 - Insert a new row (click the + button). Note, you can only insert a message on the most recent bill that is Complete.
-

- Specify the desired message code.
 - Save the bill.
 - Reprint the bill as per [How To Reprint A Bill \(For The Original Recipients or For Someone New\)](#).
-

FASTPATH:

Refer to [The Source Of Bill Messages](#) for more information about the messages the system automatically links to a bill when the bill is completed.

How To Remove A Completed Bill

You can't physically remove a completed bill from the system. However, you can remove all financial transactions from the bill (and therefore end up with a zero value bill). You can also suppress the bill from being printed. To do this, perform the following steps:

- If the bill has bill segments, cancel each bill segment. Refer to [How To Cancel A Bill Segment](#) for instructions describing how to do this.
 - If the bill has payment amounts or adjustment amounts that were entered incorrectly, navigate to the payment and/or adjustment pages and cancel the payments / adjustments.
 - Navigate to the [Bill - Main](#) page.
 - Click the [Reopen](#) button to reopen the previously completed bill.
 - Transfer to the [Bill - Bill Routings](#) tab. Turn on the Do Not Print switch for every routing entry.
 - Click the [Complete](#) button to recomplete the bill. When the bill is recompleted, the system will sweep the canceled segments onto it and the net effect should be zero current charges.
-

NOTE:

Cannot reopen historical bills. You may only reopen an account's most recent bill because recompleting the bill causes the ending balance to change, and we don't want this to happen to historical bills.

If the bill has payment amounts or adjustment amounts that are valid, but you don't want them to appear on this bill, navigate to the **Menu > Financial > Bill > Search** and navigate to the **Financial Details** page. Drill over to each respective financial transaction by clicking the drill down button. Clicking this button transfers you to [Financial Transaction - Main](#). On this page, clear out the value of the Bill ID. Clearing out the Bill ID unlinks the financial transaction from the bill. When the system next completes a bill for the account, it will find the unbilled financial transaction and link it to the bill.

How To Display A Bill On-line

To display a bill on-line, you must first have installed software to render the bill in a format suitable for displaying. You must also configure the system to invoke this software; otherwise, you will get a message indicating that the service is not available. This option can only be configured by your technical staff.

The system can be configured to work with different bill production software, and it comes configured with the ability to display a bill on-line using BI Publisher or a document composition application. With a document composition application, the bills are presented in PDF format. To view the bills, you must have Adobe® Acrobat® Reader installed.

To view a bill on-line, click the **Display Bill** button.

Financial Transactions On A Bill

Open **Menu** > **Financial Query** > **Financial Transactions On A Bill** to view this information.

NOTE:

You can also open this page using the go to buttons that prefix the financial transaction summaries on [Bill - Main](#).

Description of page

Bill Id is the system-assigned unique identifier of the bill.

Account ID is the bill's account.

The area beneath **AccountID** provides you with options that control which financial transactions appear in the grid. The following points describe the various options:

- Use the **SA Filter** to define the types of service agreements whose financial transactions appear in the grid. The following options are available:
 - Address. Use this option to restrict financial transactions to those whose service agreements are linked to service points associated with a given **Address**, **City** and/or **Postal** code.
 - All. Use this option if you do not wish to restrict financial transactions based on service agreement attributes.
 - Geographic Type. Use this option to restrict financial transactions to those whose service agreements are linked to service points associated with a given **Geo Type** and **Value**.
 - SA ID. Use this option to restrict financial transactions to those of a specific service agreement.
 - SA Type. Use this option to restrict financial transactions to those whose service agreements are linked to a given **CIS Division** and **SA Type**.
- Use **FT Type Filter** to restrict the type of financial transactions that appear in the grid. The following options are available:
 - Adjustments. This option shows all financial transactions associated with adjustments.
 - All. This option shows all financial transactions.
 - Corrections. This option shows all financial transactions associated with corrections (i.e., cancel / rebills that have occurred after the bill was completed).
 - Current Charges. This option shows all financial transactions associated with bill segments (that aren't Corrections).
 - Payments. This option shows all financial transactions associated with payments.
- Use **Match Event Status Filter** to restrict the financial transactions based on the status of their [match event](#). This filter only appears if the bill's account is an [open-item](#) customer. The following options are available:
 - All. This option shows all financial transactions.
 - Balanced. This option shows all financial transactions whose match event is balanced.
 - Disputed. This option shows all financial transactions whose match event is disputed.
 - Unbalanced. This option shows all financial transactions whose match event is unbalanced.
 - Unmatched. This option shows all financial transactions that are not linked to a match event.

WARNING:

Don't forget to click the search button after changing the filters or after selecting a new Bill ID.

The grid that follows contains the financial transactions that match your search criteria. The following information is displayed:

- **Match Event Status** shows the status of the financial transaction's [match event](#). This column only appears if the bill's account is an [open-item](#) customer.
- **FT Type** displays the type of financial transaction except for adjustments. For adjustments, the adjustment type's description is shown. Click on the hyperlink to transfer to [Financial Transaction - Main](#). On this page, you can change certain aspects of the FT in question. Refer to [How To Remove Unwanted Adjustments \(or Payments\) From A Completed Bill](#) for a description of how to perform common maintenance functions.
- **Accounting Date** is the date the system uses to determine the financial transaction's accounting period in your general ledger.
- **Current Amount** contains the financial transaction's effect on the service agreement's current balance.
- **Payoff Amount** contains the financial transaction's effect on the service agreement's payoff balance. The **Payoff Amount** will be dim if it equals the **Current Amount**.
- **Show on Bill** indicates if information about the financial transaction appears on the customer's bill.
- **SA Information** contains a summary of the respective service agreement.
- **Financial Transaction ID** is the system-assigned unique identifier of the financial transaction.

At the bottom of the page is a summary of the financial transactions that match the search criteria.

Maintaining Bill Segments

A bill typically contains one bill segment for every active service agreement linked to its account. A bill segment contains information showing how the segment was calculated and how it should be printed on the customer's bill.

The actions taken to create a bill segment are dependent on the service agreement's SA type. For example, a service agreement that charges for metered service is produced as follows:

- The service agreement's rate is applied to the amount consumed to calculate how much the customer owes for the service. A bill segment and a financial transaction are generated to reflect the results of this calculation. Refer to [How Rates Affect The Information On Bill Segments](#) for the details. Refer to [Effective Dates & Price Proration](#) for information about how the system prorates changes to rates and prices during a bill period.

NOTE:

SA type controls everything. The above points explain how a bill segment is produced for a service agreement. It's important to be aware that the system has other bill segment creation algorithms. For example, if the service agreement charges for a deposit, the system neither amalgamates consumption nor does it apply a rate. You may be wondering how the system knows which method to use? It uses the bill segment type on the service agreement's SA type. Refer to [Designing and Defining Bill Segment Types](#) for a description of the various bill segment creation algorithms that are supported in the system.

It's important to be aware that there are very few fields that are directly modifiable by a user. To modify most fields on a bill segment, you have to change source information (e.g., service agreement, rate, meter read) and then regenerate the bill segment. For example, if you want to change the rate used to calculate a bill segment, you must change the rate history on the respective service agreement and then cancel / rebill the bill segment. Refer to [How To](#) for step-by-step instructions that explain how to perform common bill segment maintenance functions.

Bill Segment Lifecycle

The following diagram shows the possible lifecycle of a bill segment.

WARNING:

This diagram only makes sense in the context of the page used to maintain bill segments. Refer to [Bill Segment - Main Information](#) for the details.

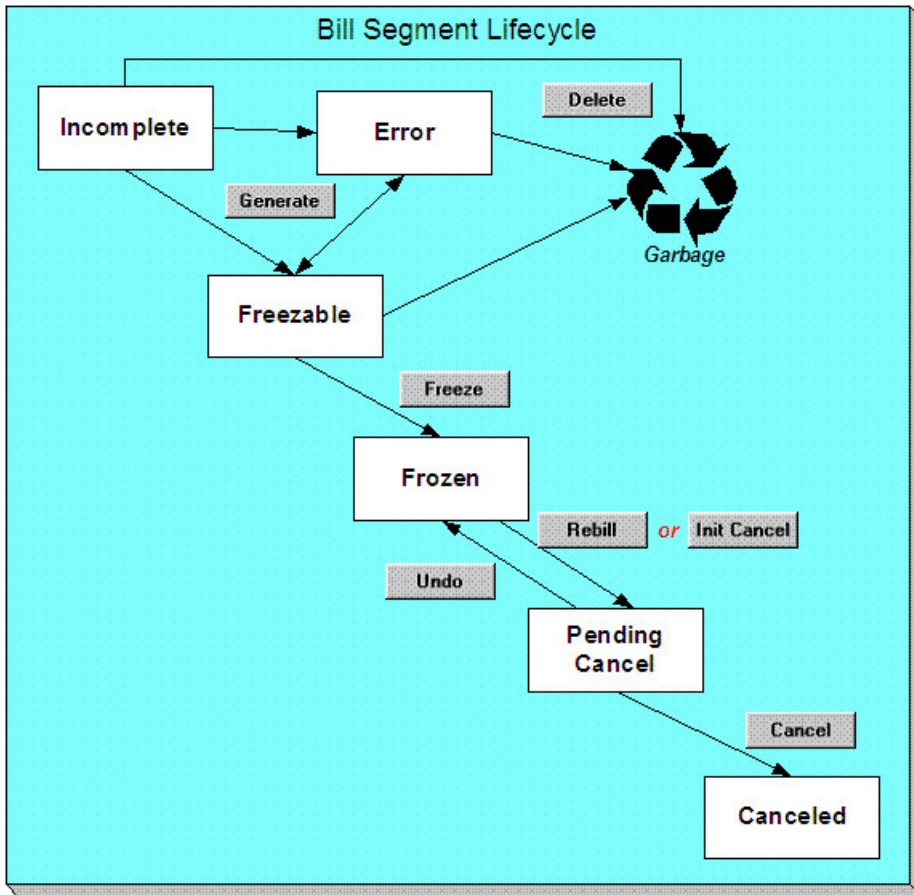

Bill segments are initially created in the Incomplete state. Bill segments in this state don't have bill lines or a financial transaction; they are simply a stub awaiting generation.

Click **Generate** to generate the bill segment's bill lines and its financial transaction.

- If the system cannot generate the bill segment (for any number of reasons), the bill segment is moved to the Error state. You may regenerate the bill segment after correcting the source of the error (by clicking **Generate**). You may also delete such a bill segment.
- If the system successfully generates a bill segment, the bill segment becomes Freezable. If the bill segment is incorrect, correct the cause of the problem (e.g., fix the meter read, change the service agreement's rate) and regenerate the bill segment (by clicking **Generate**).

Click the delete button to physically remove an Incomplete, Error or Freezable bill segment from the database. Note, batch billing will delete unfrozen bill segments when it attempts to create bill segments for an account that has unfrozen bill segments. Also note, if you've plugged-in the appropriate pre-completion algorithm, the system will delete bill segments in error on the last night of the bill cycle. Refer to DEL-BSEG for more information.

Click **Freeze** to freeze a bill segment and its financial transaction. After doing this, the bill segment's state becomes Frozen and the bill segment may now appear on a customer's bill. Also note, when a bill segment is frozen, its financial details will be interfaced to the general ledger the next time the [GL interface](#) executes.

You may not change a bill segment once it is frozen. However, you have two options if you want to change a frozen bill segment's financial impact:

- If you need to remove the financial effects of a bill segment, click **Init Cancel**. Clicking this button causes a new financial transaction to be generated and linked to the bill segment. This financial transaction reverses the financial effects of the original bill segment. The bill segment becomes Pending Cancel after the system successfully generates this financial transaction. At this point, you have two options:
- Click **Cancel** to freeze the cancellation. Clicking this button causes the bill segment to move to the Canceled state. Once canceled, the bill segment cannot be uncanceled or changed.
- Click **Undo** to return the pending cancellation to the Frozen state.
- Click **Rebill** if you need to recalculate the bill segment because something has changed since it was originally created (e.g., the service agreement's rate was changed, a new read was entered). Clicking this button causes the following events to take place:
- The original bill segment is moved to the Pending Cancel state.
- A new bill segment is created in the Freezable (or Error) state.

At this point, you have two options.

- Click **Freeze** to make the new bill segment Frozen and make the original bill segment Canceled.
- Click **Undo** to delete the new bill segment and return the original bill segment to the Frozen state.

Bill Segment - Main Information

FASTPATH:

The **Description of Page** section below describes the fields on this page. Refer to [How To](#) for a description of how to perform common bill maintenance functions.

The Main page contains core bill segment information. Open **Menu > Financial > Bill Segment > Search** to view this information.

NOTE:

Most bill segments are created by a background process. Refer to [A High Level Overview Of The Bill Creation Process](#) for information describing how the system creates a bill segment.

Description of Page

Bill Seg Info is a concatenation of the bill segment's division, SA type, status, bill period and amount. **Bill Segment ID** is the system-assigned unique identifier of the bill segment.

Account ID references the bill segment's account.

Current Amount is the bill segment's effect on the service agreement's current balance. **Payoff Amount** is only shown if it differs from current amount. Refer to [Billing - Current Balance versus Payoff Balance](#) for more information.

Bill ID is the system-assigned unique identifier of the bill on which the bill segment appears. A concatenation of its bill date, status, due date and amount is displayed.

SAID contains information about the bill segment's service agreement. A concatenation of the service agreement's division, SA type, start option (if any), status and start date is displayed.

If the [quotation](#) module is not **turned off**, you can generate [simulated bill segments](#) when you create a quote. You can view simulated bill segments by drilling down on the desired bill segment from [Quote - Quote Details](#). When a simulated

bill segment is displayed on this page, the **Billing Scenario ID** that controlled the bill segment's billing period (and consumption) is displayed. Refer to [Creating Quotes And Quote Details](#) for more information.

Period is the start and end dates of the bill segment.

Usage Period is the period used by to determine the correct interval data to process for the bill segment. This field appears when the bill segment is for an SA that has Bill Determinants Required for the special role flag.

Bill Cycle displays the bill cycle and window start date of the bill segment's bill. This information is only populated on bills when they are generated on-schedule by the batch billing background process. Bills generated manually, i.e. off-schedule, do not have this information.

Status is the bill segment's status. Refer to [Bill Segment Lifecycle](#) for the potential values and how to handle a bill segment when it exists in a given state.

If the **Closing** switch is on, this is the final bill segment for the service agreement (i.e., the service agreement has been stopped and this is the final bill segment).

NOTE:

The closing switch is not set for sub SA bill segments nor billable charge SA bill segments.

If the **Estimate** switch is on, consumption on this bill segment has been estimated by the system.

If the **SQ Override** switch is on, a user has overridden the service quantities (i.e., the amount of consumption for which the customer is charged is not consistent with the customer's meter reads). This switch is also set if a user has overridden the [calculation/audit read details](#).

If the **Item Override** switch is on, a user has overridden the type and/or number of items (i.e., the type/number of items for which the customer is charged is not consistent with the customer's service point information). Refer to [How To Override The Items Billed On A Specific Bill Segment](#) for more information.

If this bill segment was created for a [sub service agreement](#) where we calculate the charges (i.e., not for a "pass through" billing situation):

- **SA Rel ID** shows the unique identifier of the record that defines the relationship between the sub service agreement and the master service agreement (this record shows the service provider associated with the bill segment). Click the go to button to transfer to this record.
- **Master Bseg ID** shows the unique identifier of the master bill segment whose bill triggered the creation of this sub service agreement. This bill segment's consumption was used to calculate the charges on this bill segment.

Premise is the address of the main premise associated with the service agreement (as defined on the service agreement's characteristic premise). It's important to note that the service agreement may cover service at multiple premises, but only one may be defined as the main premise.

Create Dt/Tm is the date and time on which the bill segment was created or regenerated.

In the **Message** area, a brief error message appears if there's a problem with the bill segment. The message area is suppressed if there are no problems with the bill.

Push the magnifying glass button to view the long explanation. The long explanation will provide information about the cause of the error (and how to fix it).

If the bill segment is a rebill of a canceled bill segment, a reference to the original bill segment is displayed. Click the adjacent go to button to transfer to the bill segment that was canceled.

If the bill segment was canceled and rebilled by another segment, a reference to the new bill segment is displayed. Click the adjacent go to button to transfer to the new bill segment that superseded the canceled segment.

The topics that follow describe each of the actions on that appear in the **Bill SegmentActions** area. Refer to [How To](#) for a description of typical business processes that use these buttons.

NOTE:

Mass update actions. This page allows you to work on individual bill segments. If you want to update many bill segments linked to a bill at once, try using the mass update actions available on [Bill -Bill Segments](#).

Generate (Bill Segment)

Click the **Generate** button to create a new a bill segment.

This button is enabled when either of the following conditions is true:

- You are in add mode (i.e., you are not displaying an existing bill segment) and you have selected an **Account ID**, **Bill ID** and **SA ID**.
- You are displaying a bill segment that is Incomplete, Error, or Freezable. Refer to [Bill Segment Lifecycle](#) for more information about these status values.

When clicked, the **Generate** window opens.

You must specify the following parameters to generate a new bill segment:

- **Cut-off Date** is the last possible day of the bill segment's bill period. The current date defaults when the window opens. Refer to [Ways To Control The End Date Of A Bill Segment](#) for more information.
- **Accounting Date** is used to define the financial period to which the new bill segment's financial transaction will be booked. The current date defaults when the window opens.
- Turn on **Allow Estimates** estimate consumption if it cannot find a meter read.
- If the service agreement uses meter reads, use the **Billing Option** to control how the system retrieves meter reads that appear on the bill. Choose Use Cut off Date if the meter reads must exist on the **Cutoff Date** (defined above). Choose Use Schedule if you want the service agreement's service point(s)

After specifying the above parameters, click the **Calculate** button to create a new bill segment for the bill.

If an error exists, refer to [How To Correct A Bill Segment That's In Error](#).

If there are no errors, the **Bill Segment Freeze Option** on the [installation option](#) controls the next step:

- If this option is set to Freeze At Bill Completion, return to [Bill - Main](#) (using the bill context menu) and click the [Freeze / Complete](#) button.
- If this option is set to Freeze At Will, click the [Freeze](#) button and, if everything looks clean, return to [Bill - Main](#) and click the [Complete](#) button.

Delete (Bill Segment)

The **Delete** button deletes a bill segment.

This button is enabled if you are displaying a bill segment that is Incomplete, Error, or Freezable. Refer to [Bill Segment Lifecycle](#) for more information about these status values.

Freeze (Bill Segment)

Clicking the **Freeze** button causes a freezable bill segment to become frozen. Refer to [Bill Segment Lifecycle](#) for more information about freezing.

This button is enabled if:

- the Freeze At Will **Bill Segment Freeze Option** on the [installation option](#) has been selected AND

- the bill segment is freezable.

NOTE:

Freezing a day or more after generation. If the bill segment is linked to a closed accounting period, a pop-up appears in which you can specify a new accounting date. This will only happen if the accounting period closes before you freeze the bill segment (the accounting date is stamped on a bill segment when it's initially generated).

If problems are detected after freezing. A bill segment may not be changed after it is frozen. All subsequent changes must occur by canceling the frozen bill segment and creating a new bill segment. Refer to [How To Cancel A Bill Segment](#) and [How To Cancel / Rebill A Bill Segment](#) for more information.

Rebill (Bill Segment)

If problems are detected with a frozen bill segment, it should be canceled and a new bill segment should be created. We refer to this process as cancel / rebill. Refer to [Cancel / Rebill Incorrect Bill Segments](#) for more information.

Before you cancel / rebill, you'll probably need to fix the cause of the problem. The following table describes common problems and where to go to fix them.

Problem	How To Fix It
The wrong rate was used	Go to Service Agreement - Rate Info and correct the rate.
The wrong meter was connected to the service point	
A contract rider was applied incorrectly	Go to Service Agreement - Rate Info and correct the contract rider information.
The wrong tax exemption amount was calculated	Go to Service Agreement - Rate Info and correct the tax exemption information.

NOTE:

Multi-Cancel/Rebill Saves Time. If the cause of the problem impacts many bill segments related to a service agreement, you should use the [Multi Cancel Rebill](#) transaction as it allows you to cancel / rebill an unlimited number of bill segments at once. Also note that for service agreements that require bill determinants from Oracle Utilities Meter Data Management, this transaction may only be used to cancel / rebill a single bill segment at a time.

Credit Notes. Using the cancel/rebill functionality will cause the cancel and rebill details to be swept on to the customer's next bill unless you [Reopen](#) the bill. If your organization requires cancellation details to be presented to the customer separately from the new bill, you should not use the **Rebill** functionality. Rather, you should issue a [Credit Note](#) and then generate a new bill containing the revised charges.

The **Rebill** button causes an existing bill segment to be canceled, and a new bill segment to be created.

This button is enabled when you display a Frozen bill segment AND the bill segment's bill is not written off AND the bill segment's bill is not linked to an off cycle bill generator. Refer to [Bill Segment Lifecycle](#) for more information about these status values.

When clicked, the **Rebill** window opens.

You must specify the following parameters to cancel and rebill a new bill segment:

- **Cancel Reason** defines why the bill segment is being canceled.
- **Cutoff Date** is the last day of the new bill segment. The cutoff date on the bill segment defaults when the window opens.
- **Accounting Date** is used to define the financial period to which the canceled and new bill segments' financial transactions will be booked. The current date defaults when the window opens.

- Turn on **Allow Estimates** estimate consumption if it cannot find a meter read.
- Use the **Billing Option** to define how the system looks for meter reads. Select Use Schedule if the system should select reads based on the SA's SP's schedule. Select Use Cut off Date if the system should only select reads from the end date of the existing bill segment.
- Turn on **Use Old Read/Item/SQ for Regen** if you want the system to use the consumption details on the original bill segment when it calculates the new bill segment.

NOTE: The **Use Old Read/Item/SQ** switch is not available if the bill's SA references an SA type with a special role flag of Bill Determinants Required.

Click the **Calculate** button to cancel the original bill segment and create a new bill segment.

At this point, there are now two bill segments - the original bill segment is in the state of Pending Cancel, the new bill segment is in the Freezable (or Error) state. If you want to back out, click the go to button to return to the original bill segment and then click **Undo** (this will delete the new bill segment and return the original bill segment to the Frozen state). If the new bill segment looks correct, click **Freeze** to move the original bill segment to the Canceled state and the new bill segment to the Frozen state.

Init Cancel (Bill Segment)

The **Init Cancel** button causes the first step of the bill segment cancellation process to be executed. You'd click this button if a frozen bill segment should never have been created (i.e., you want to remove the financial impact of a bill segment from a customer's balance).

This button is enabled when you display a Frozen bill segment AND the bill segment's bill is not written off. Refer to [Bill Segment Lifecycle](#) for more information about these status values.

When clicked, the **Cancel** window opens.

You must specify the following parameters to cancel and rebill a new bill segment:

- **Cancel Reason** defines why the bill segment is being canceled.
- **Accounting Date** is used to define the financial period to which the canceled bill segment's financial transactions will be booked. The current date defaults when the window opens.

Click the **Calculate** button to cancel the original bill segment.

At this point, the bill segment is in the state of Pending Cancel. If you want to back out, click **Undo**; the bill segment will be returned to the Frozen state. Click **Cancel** to move the bill segment to the Canceled state.

NOTE:

Credit Notes. Using the cancel functionality will cause the cancel details to be swept on to the customer's next bill unless you **Reopen** the bill. If your organization requires cancellation details to be presented to the customer separately from the new bill, you should not use the cancel functionality. Rather, you should issue a **Credit Note** and then generate a new bill containing the revised charges.

Undo (Bill Segment)

The **Undo** button returns a Pending Cancel bill segment to the Frozen state. If a Pending Cancel bill segment was created during a Cancel / Rebill, the newly created Freezable bill segment is also deleted.

This button is enabled when you display a Pending Cancel bill segment. Refer to [Bill Segment Lifecycle](#) for more information about this status.

Cancel (Bill Segment)

Clicking the **Cancel** button causes a Pending Cancel bill segment to become Canceled. Refer to [Bill Segment Lifecycle](#) for more information about cancellation.

This button is enabled if a Pending Cancel bill segment is displayed AND the bill segment's bill is not written off.

When clicked, the **Cancel** window opens.

You must specify the following parameters to cancel the frozen bill segments:

- **Cancel Reason** defines why you are performing the cancellation.
- **Accounting Date** defines the financial period to which the canceled bill segments' financial transactions will be booked. The current date defaults when the window opens.

After specifying the above parameters, click the **Calculate** button to cancel the frozen bill segments.

If the related bill is pending, the cancellation will cause the bill segment to be suppressed on the version of the bill sent to the customer (but it remains in the database for audit and financial reporting purposes).

If the related bill is complete and you do not [Reopen](#) the bill, the financial impact of the canceled bill segment will appear on the next bill created for the account (under Bill Corrections).

If the related bill is complete you may be able to [Reopen](#) the bill and then [Complete](#) it. By doing this, you can suppress a frozen bill segment on a previously completed bill. This means that if you catch a problem after completion you don't necessarily have to show the problem to the customer. Rather, cancel the problem, reopen and then recomplete the bill (when you recomplete the bill the system will mark the bill segment to be suppressed on the version sent to the customer because its cancellation appears on the same bill as the original charges).

Credit Note (Bill Segment)

The **Credit Note** button is used to cancel a bill segment and create a new bill that contains the cancellation details. We refer to this "negative bill" as a credit note. Refer to [Credit Notes - Presenting Cancellation Details on a Separate Bill](#) for more information.

NOTE:

If you want to issue a credit note for an entire bill. Rather than cancel a specific bill segment, functionality exists that allows you to create a credit note for ALL bill segments on a bill. To use this feature, display the bill in question and then click the **Credit Note** button on the [bill page](#).

This button is enabled if:

- the **Use Credit Notes** option on the [Installation](#) record is turned on AND
- the bill segment is frozen AND
- the bill segment's bill is not written off.

When clicked, the **Credit Note** window opens.

You must specify the following parameters to cancel the frozen bill segment:

- **Cancel Reason** defines why you are performing the cancellation.
- **Accounting Date** defines the financial period to which the canceled bill segment's financial transaction will be booked. The current date defaults when the window opens.

- **Credit Note Date** defines the date of the credit note on which the cancellation details will appear. The current date defaults when the window opens.

After specifying the above parameters, click the **Calculate** button to cancel the frozen bill segment and create a credit note.

It should be noted that if this operation is successful, the new "negative bill" will be complete (meaning that it will be ready for transmission to the customer and for interface to the general ledger).

Bill Segment - Read Details

The Read Details page is not populated when meter reads are managed in Oracle Utilities Meter Data Management.

Bill Segment - Item Details

FASTPATH:

The **Description of Page** section below describes the fields on this page. Refer to [How To Override The Items Billed On A Specific Bill Segment](#) for a description of how to override this information.

The Item Details page contains information about the items located at the service agreement's service points. Open **Menu > Financial > Bill Segment > Search** and navigate to the **Item Details** page to view this information.

Description of Page

Bill Seg Info is a concatenation of the bill segment's division, SA type, status, bill period and amount. **Bill Segment ID** is the system-assigned unique identifier of the bill segment.

The item details grid is a snapshot of the items that existed at the service agreement's service points at the time the bill segment was created. One row exists for every type of item linked to every service point linked to the service agreement.

This information may be modified on a bill segment in the Error or Freezable state. Insert one row in the item grid (click the + button) for each item you need to add. You may also change item amounts that were populated by the system when it initially generated the bill by simply overwriting the information.

WARNING:

The proper way to fix the number and type of items on a bill segment is to correct the service point / item information and then regenerate the bill segment. Overriding the item details on a bill segment is a last resort that should only be used when you cannot fix the service point / item information (for whatever reason).

The following information is displayed in the grid:

- **Seq No** is the system-assigned unique identifier of the item detail row.
- **Item Type** is the type of item.
- **Item ID** is the unique identifier of the item (this is only displayed if a badged item is linked to the service point; non-badged items don't have unique identities).
- **Start Date** is the first day in the bill segment's bill period that the item was linked to the service point.
- **End Date** is the last day in the bill segment's bill period that the item was linked to the service point.
- **Item Count** is the number of items of this type that were linked to the service agreement's service points.
- If the item's item type indicates the system must estimate consumption (e.g., lamps), **UOM** is the unit of measure of the estimated consumption. **Daily Service Quantity** is the item's estimated amount of daily consumption.

FASTPATH:

Bill Segment - SQ Details

FASTPATH:

The **Description of Page** section below describes the fields on this page.

The SQ Details page contains information about the that will be priced by the service agreement's rate. In addition to showing SQ details, this page shows any [Calculation / Audit Read Details](#) and [Calculation / Audit Usage Details](#) that are linked to the bill segment. Open **Menu > Financial > Bill Segment > Search** and navigate to the **SQ Details** page to view this information.

Description of Page

Bill Seg Info is a concatenation of the bill segment's division, SA type, status, bill period and amount. **Bill Segment ID** is the system-assigned unique identifier of the bill segment.

The **Service Quantity** details grid is a snapshot of the service quantities amassed from:

- The bill segment's usage request.
- [Billable charges](#) that supply service quantities.

One row exists for every unique combination of unit of measure (UOM), time-of-use (TOU) code, and service quantity identifier (SQI) associated with the service agreement.

This information may be overridden on a bill segment in the Error or Freezable state. Insert one row in the service quantity grid (click the + button) for each UOM/TOU/SQI you need to add. You may also change amounts that were populated by the system when it initially generated the bill by simply overwriting the information.

WARNING:

The proper way to fix the SQ details on a bill segment is to correct the cause of the error (e.g., correct the meter reading). Overriding the SQ details on a bill segment is a last resort that should only be used when you can't fix the cause of the problem. Refer to [How To Cancel / Rebill A Bill Segment](#) for ways to fix common problems.

The following information is displayed in the grid:

- **Unit of Measure** is the unit of measure of the service quantity.
- **Time of Use** is the time-of-use of the service quantity.
- **SQI** is the service quantity identifier of the service quantity.
- **Initial Service Quantity** is the initial quantity amassed by the system before application of the rate's pre-processing calculation group(s), if any exists.
- **Billable Service Quantity** is the service quantity that will be priced by the service agreement's rate. This amount differs from the initial service quantity when the rate's pre-processing calculation rule(s) manipulate consumption.

The **Calculation/Audit Read Details** section contains [Calculation / Audit Read Details](#). This section only appears if any of the following conditions are true:

- The service agreement has a special role of
- The bill segment has one or more reads with a usage flag of Calculation/Audit .

The following information may be defined for each calculation / audit read:

- **Final Unit of Measure** is the final unit of measure of the calculation / audit read.
- **Final Time of Use** is the final time-of-use code of the calculation / audit read.

- **Final SQI** is the final service quantity identifier of the calculation / audit read.
- **Start Date/Time** is the date and time of the calculation / audit read.
- **End Date/Time** is the date and time of the calculation / audit read.
- **Quantity** is the quantity of the calculation / audit read. This would typically contain the amount that was billed during the **Start Date/Time** through the **End Date/Time** for the **Final Unit of Measure**, **FinalTime of Use** and **FinalSQI**.
- **Unit of Measure** is the initial unit of measure of the calculation / audit read (if any).
- **Time of Use** is the initial time-of-use code of the calculation / audit read.
- **SQI** is the initial service quantity identifier of the calculation / audit read.
- **Start Quantity** is the "start" quantity (if any). This value would typically only be displayed if the calculation / audit read is subtractive (i.e., you must subtract the end quantity from the start quantity to determine billable consumption).
- **End Quantity** is the "end" quantity (if any). This value would typically only be displayed if the calculation / audit read is subtractive (i.e., you must subtract the end quantity from the start quantity to determine billable consumption).
- **Measured Quantity** is the resulting measured quantity (if any). This value would typically only be displayed if the calculation / audit read is subtractive (i.e., you must subtract the end quantity from the start quantity to determine billable consumption). It should contain the difference between the **Start Quantity** and the **End Quantity**.
- **Constant** is the constant of the measuring device that was multiplied by the **Measured Quantity** to derive the calculation / audit read's **Quantity**.
- **How To Use** is a code that indicates if the "calculation / audit" read was is considered to be additive, subtractive, peak or check.
- **Use Percent** is the percentage of the total consumption that was billed.
- **Meas Peak Qty** indicates if the unit of measure is one that measures peak consumption.
- **Multiplier** is the ratio of the **Quantity** and the **Measured Quantity**. This value only appears if a non-zero value exists in both of these fields.
- **Seq No** is the sequence number (if any).
- **Service Point** is the unique identifier of the service point at which the readings were calculated (if applicable).

This information may be overridden on a bill segment in the Error or Freezable state. Insert one row in the calculation / audit details grid (click the + button) for each entry you need to add. You may also information populated by the system when it initially generated the bill by simply overwriting the information.

WARNING:

The proper way to fix the calculation/audit details on a bill segment is to correct the cause of the error. Overriding the calculation/audit details on a bill segment is a last resort that should only be used when you can't fix the cause of the problem.

FASTPATH:

Refer to [Calculation / Audit Read Details](#) for more information about this section.

The **Calculation/Audit Usage Details** grid contains usage service quantities for the bill segment. This section appears when the service agreement has a special role of Bill Determinants Required. The following information is displayed in the grid:

- **Final Unit of Measure** is the final unit of measure of the calculation / audit usage.
- **Final Time of Use** is the final time-of-use code of the calculation / audit usage.
- **Final Service Quantity ID** is the final service quantity identifier of the calculation / audit usage.
- **Start Date/Time** is the date and time of the calculation / audit usage.

- **End Date/Time** is the date and time of the calculation / audit usage.
- **Quantity** is the quantity of the calculation / audit usage. This would typically contain the amount that was billed during the **Start Date/Time** through the **End Date/Time** for the **Final Unit of Measure**, **FinalTime of Use** and **FinalSQL**.
- **Sequence** is the sequence number.
- **Service Point ID** is the unique identifier of the service point at which the usage was calculated.

FASTPATH:

Refer to [Calculation / Audit Usage Details](#) for more information about this section.

Bill Segment - Calc Lines

FASTPATH:

The **Description of Page** section below describes the fields on this page. Refer to [How To Cancel / Rebill A Bill Segment](#) for instructions describing how to regenerate this information if the bill segment is incorrect.

The Calc Lines page contains information about the bill calculation lines produced when the system generates the bill segment. These lines are the source of the details printed on the customer's bill. Open **Menu > Financial > Bill Segment > Search** and navigate to the **Calc Lines** page to view this information.

FASTPATH:

Most service agreements use a rate to calculate the information that appears on this page. Refer to [How Rates Affect The Information On Bill Segments](#) for more information.

Description of Page

Bill Seg Info is a concatenation of the bill segment's division, SA type, status, bill period and amount. **Bill Segment ID** is the system-assigned unique identifier of the bill segment.

The Bill Segment Header (**Bill Seg Hdr**) scroll contains one entry for every version of the rate that was used to calculate the bill segment's lines. Because most bill segments use a single rate version calculation group, you typically only see one entry in the scroll.

The following information is displayed above the bill calculation line grid.

- **Sequence** will be 1 unless multiple versions of the rate were in effect during the bill period. If there was more than one effective rate version calculation group, there will be a separate set of calc lines for each version applied. The lines that apply to the first part of the bill period would have a Sequence of 1, the lines for the next part of the bill period would have a Sequence of 2 and so on.
- **Start Date - End Date** is the portion of the bill segment period that the calculation details apply. .
- **Amount** is the sum of the bill calculation lines in the grid.
- **Desc on Bill** is summary information about the calculation details that will be printed on the customer's bill.
- **Rate Version** is the ID of the rate version calculation group and its effective date. This information only appears if a rate was used to calculate the charges.

The calculation lines grid is a snapshot of how the system calculated the bill segment amount. One row exists for every calculation involved in this process. This information is for audit purposes only and may not be modified. The following information is displayed in the grid:

- A drill down button appears in the **Calc Line Char** column if the bill calculation line has characteristics. The **Calc Line Char** column only appears if at least one of the calculation lines has a characteristic.

- **Sequence** is the system-assigned unique identifier of the calculation detail row.
- **Description on Bill** is the information about the bill line that appears on the customer's bill.
- **Calculated Amount** is the calculated amount associated with the bill line.
- The **Print** switch controls whether information about this line will print on the customer's bill.
- The **Appears in Summary** switch defines if this line's amount also appears on a summary line. This switch plays a part at bill print time - those lines that appear in a summary print in the left dollar column, those that don't appear in a summary print in the right dollar column.

The system automatically populates this switch as follows:

- Bill segments created by applying a rate have this switch turned on if the corresponding calculation rule is summarized on a summary calculation rule
- Bill segments created from billable charges use the value of this switch as defined on the billable charge. Refer to [Maintaining Billable Charges](#) for more information.
- **Unit of Measure (UOM)** is the unit of measure of the service quantity priced on the calculation line.
- **Time of Use (TOU)** is the time-of-use code of the service quantity priced on the calculation line.
- **SQI** is the service quantity identifier of the service quantity priced on the calculation line.
- **Billable Service Quantity** is the service quantity priced on the calculation line. This quantity will be different from the measured consumption if there are pre-processing calculation groups in effect.
- **Base Amount** is used by calculation lines (e.g. taxes) that are cross-referenced to other calculation lines and whose value(s), therefore, depend on the amounts calculated by those other lines. The Base Amount shows the total amount derived from the cross-referenced line(s) that the current line then used to calculate its billed amount.
- **Calculation Rule** is the rule that calculated the line. This is only populated if the new rate engine calculated the charges.
- **Measures Peak Qty** is checked if the UOM priced on the calculation line is used to measure a peak quantity.
- **Exempt Amount** is the amount of the calculated charge that the customer doesn't have to pay because they are tax exempt.
- **Distribution Code** is the distribution code associated with the calculation line. This distribution code is used to build the general ledger details on the bill segment's financial transaction.
- **Description** describes the characteristic value that was used when the line's amount was calculated. This information is only displayed if the line was calculated using a bill factor (because only bill factors use characteristic values). Refer to [An Illustration Of A Bill Factor And Its Characteristics](#) for more information.

Bill Segment - Financial Details

FASTPATH:

The **Description of Page** section below describes the fields on this page. Refer to [How To Cancel / Rebill A Bill Segment](#) for instructions describing how to regenerate this information if it is incorrect.

The Financial Details page contains information about the financial effects of the bill segment. Open **Menu > Financial > Bill Segment > Search** and navigate to the **Financial Details** page to view this information.

NOTE:

Refer to [The Source Of GL Accounts On A Bill Segment's Financial Transaction](#) for how the system compiles this information.

Description of Page

Bill Seg Info is a concatenation of the bill segment's division, SA type, status, bill period and amount. **Bill Segment ID** is the system-assigned unique identifier of the bill segment.

The **Bill Segment FT** scroll contains one entry for every financial transaction (FT) associated with the bill segment. All bill segments have an FT that shows the impact of the bill segment on the general ledger. A bill segment may have an additional FT (for a maximum of two) if it is cancelled. The second FT shows the impact of the cancellation on the general ledger.

The following financial transaction information is displayed above the general ledger distribution grid.

- **FT Type** displays the type of financial transaction (FT).
- **Show on bill** indicates if information about the FT appears on the customer's bill.
- **FT ID** is the system-assigned unique identifier of the FT. Click the go to button to transfer to the [Financial Transaction - Main](#) page. On this page you can change certain aspects of the FT in question. Refer to [How To Remove Unwanted Adjustments \(or Payments\) From A Completed Bill](#) for a description of how to perform common maintenance functions.
- The posted by information that appears adjacent to the FT ID shows the date on which the FT was frozen and the user ID of the user who performed the operation.
- The "Linked to bill on" message appears when the financial transaction is linked to a bill. A FT is linked to a bill the next time a bill is completed for the account. Therefore, if a user cancels a bill segment, the FT associated with the cancellation will not be linked to a bill until the next bill is completed (although the financial effect of the cancellation takes place immediately). Click the adjacent go to button to transfer to the bill on which the FT appears.
- **Current Amount** contains the FT's effect on the service agreement's current balance.
- **Payoff Amount** contains the FT's effect on the service agreement's payoff balance. This field is only visible when the payoff amount differs from the current amount.
- **Accounting Date** is the date the system uses to determine the FT's accounting period in your general ledger.
- **Arrears Date** is the date the FT starts aging.

The journal details grid is a snapshot of the distribution codes used to generate the GL accounts that are affected by the FT. This information is for audit purposes only and may not be modified. The following information is displayed in the grid:

- **Seq** is the system-assigned unique identifier of the distribution line.
- **Distribution Code** is the distribution code used to generate the GL account affected by the distribution line. Drill over to the FT if you need to see the actual GL account.
- **Amount** is the amount debited / credited (credits are shown as negative values).
- **Statistics** and **Statistics Amount** are only specified when a statistical quantity is associated with the distribution line. For example, if the line is associated with a charge for the total number of kilowatt-hours consumed, the statistics code will be the kWh and the statistics amount will be the number of kilowatt-hours associated with the charge.
- **Description** describes the characteristic value that was used when the line's amount was calculated. This information is only displayed if the distribution line was derived from bill calculation lines that were calculated using a bill factor (because only bill factor's use characteristic values). Refer to [An Illustration Of A Bill Factor And Its Characteristics](#) for more information.
- If you have configured your installation options to indicate that **fund accounting** is practiced, the description of the **Fund** associated with this distribution code is displayed.

Bill Segment - Bill Segment Messages

The Messages page is a grid containing one row for every message that appears on the bill segment. Open **Menu > Financial > Bill Segment > Search** and navigate to the **Bill Segment Messages** page to view this information.

NOTE:

No messages until completion. A bill segment has no messages until it is completed (unless you insert them manually). At completion time, the system assembles messages from the various message sources. Refer to [The Source Of Bill Messages](#) for information about these sources.

The bill may also have messages. Be aware that only service agreement-oriented messages are linked to a bill segment. There may also be account-oriented messages linked to the bill. Refer to [Bill - Bill Messages](#) for information about the page on which account-oriented messages are displayed. Refer to [The Source Of Bill Messages](#) for information about the various message sources and whether each is linked to a bill or a bill segment.

Description of Page

Bill Seg Info is a concatenation of the bill segment's division, SA type, status, bill period and amount. **Bill Segment ID** is the system-assigned unique identifier of the bill segment.

The following columns are displayed in the grid:

- **Msg Code** is the code that identifies the bill message.
- **Message On Bill** is the message associated with the code.
- **Priority** is the bill messages priority (on the printed bill).
- **Insert Code** defines if the bill message causes an insert in the envelope.

Bill Segment - Sub Bill Segments

The Sub Bill Segments page contains the sub bill segments that are associated with the master SA's bill segment. Open this page using **Menu > Financial > Bill Segment > Search** and navigate to the **Sub Bill Segment** page.

NOTE:

Sub bill segments are only linked to the master SA's bill segment when the master SA has an SA relationship with a We Bill For Them - Rate Ready or an It's Us service provider. Refer to [The Rate Ready Calculation Method](#) for the details.

Description of Page

Bill Seg Info is a concatenation of the bill segment's division, SA type, status, bill period and amount. **Bill Segment ID** is the system-assigned unique identifier of the bill segment.

The following information is displayed in the grid.

- Click the adjacent **Go To** button to transfer to the bill segment.
- The **Bill Segment** column contains a concatenation of the bill segment's business unit, SA type, status, bill period and amount. The business unit and SA type come from the bill segment's service agreement.
- The **Current Amount** column contains the bill segment's effect on the sub service agreement's current balance.
- The **Status** column contains the bill segment's current status.

Bill Segment - Bill Segment Portal

Select **Menu > Financial > Bill Segment > Search** and navigate to the **Bill Segment Portal** page to view additional information associated with a Bill Segment.

Depending on your implementations requirements, you may define additional zones to appear on this Portal

The contents of this section describe the zones that are available on this portal page.

General Information

Bill Segment ID, **Bill Seg Info** are displayed.

Bill Segment - Usage

This Usage portal is available when the bill segment has associated usage requests. It displays all usage requests related to the bill segment. Select **Menu > Financial > Bill Segment > Search** and navigate to the **Usage** page to view bill segment's usages.

General Information

Bill Segment ID and Bill Segment Info are displayed.

Bill Segment Usage

The following information is displayed in the Bill Segment Usage zone:

- The **Create Date/Time** of the usage request.
- The **Usage** column contains a concatenation of the bill segment's division, SA type, status, and period of the usage request. The usage information links to the Usage Portal for the usage request.
- The **Usage ID** for the usage request.

Financial - Bill Segment Calculation Line Characteristics

This page displays the characteristics that are linked to a specific bill segment calculation line. The information on this page is for audit purposes only and cannot be changed.

Open this page by clicking the **Go To Calc Line Characteristic** button on the calculation lines grid of the [Bill Segment - Calc Lines](#) page.

Description of Page

Account is the account to which the bill segment is linked. The name of the main person on the account appears next to the account ID.

The **SA** is the service agreement to which the bill segment applies. Basic information about the service agreement appears adjacent.

Premise shows the service agreement's characteristic premise (i.e., the primary premise associated with the service agreement).

The **Bill Seg ID** and **Bill Seg Header** displays the identification of the bill segment and header associated with the calculation line characteristic.

Calc Line displays the calculation line number with which the characteristics are associated.

The **Description on Bill** displays the description of the calculation line that appears on the customer's bill.

The characteristics grid displays the **Characteristic Types** and the **Characteristic Values** associated with the calculation line.

FASTPATH:

For more information about characteristics, refer to [Setting Up Characteristic Types and Their Values](#).

Off Cycle Bill Generator

The Off Cycle Bill Generator portal may be used to create an off cycle bill for an account where you control which financial transactions are linked to the resultant bill. For example, you can create a bill for a specific adjustment or billable charge. Navigate using **Menu > Financial > Off Cycle Bill Generator > Add.**

Off Cycle Bill Generator Query

Use the [query portal](#) to search for an existing off cycle bill generator. Once an off cycle bill generator is selected, you are navigated to the maintenance portal to view and maintain the selected record.

Off Cycle Bill Generator Portal

This portal appears when an off cycle bill generator has been selected from the Off Cycle Bill Generator Query portal. The topics in this section describe the base-package zones that appear on this portal.

Off Cycle Bill Generator Actions

This is a standard [actions zone](#).

If the off cycle bill generator is in a state that has valid next states, buttons to transition to each appropriate next state are displayed.

FASTPATH:

Refer to [How To Create An Off Cycle Bill Generator](#) for more information about how to create an off cycle bill on-line / real time.

Off Cycle Bill Generator Zone

The Off Cycle Bill Generator zone contains display-only information about the off cycle bill generator. Please see the zone's help text for information about this zone's fields.

Financial Transactions On Bill

The Financial Transactions On Bill zone shows financial transactions linked to the off cycle bill generator's bill. Information displayed on this zone is similar to that displayed on the [Financial Transactions On A Bill](#) transaction.

Off Cycle Bill Generator Log

An off cycle bill generator log contains an entry for every recorded event during the lifecycle of the off cycle bill generator. There are two general types of log entries:

- **Automatic entries.** The system automatically creates an entry in the log when an off cycle bill generator is created or there is a status change or when a related entity is created. This also includes any implementation-specific log entries. Users cannot modify or delete these log entries.

- **Manual entries.** Users can add manual entries to record significant events at their discretion.

Multi Cancel/Rebill

The Multi-Cancel/Rebill transaction is used to cancel / rebill (and freeze) one or more bill segments linked to a service agreement.

NOTE:

You would typically use this transaction when something has been wrong for an extended period of time. For example, if the customer was assigned the wrong rate when they first started service, you would correct the customer's rate using [Service Agreement - Rate Info](#) and then use this transaction to cancel / rebill the customer's historical bill segments.

The following topics describe how to use this transaction.

Multi Cancel/Rebill - Main

The main page is used to select the bill segments to be cancel/rebilled and to initiate the cancel/rebill request. Open **Menu > Financial > Multi-Cancel/Rebill** to use this function.

Description of Page

This page contains all non-cancelled bill segments associated with a given **SA ID**. The service agreement's **SA Info**, **Account ID** (and name), characteristic **Premise** (and address), **Current Balance** and **Payoff Balance** are displayed at the top of page.

When the page first opens, the grid is populated with ALL non-cancelled bill segments displayed in reverse chronology order. All frozen bill segments are pre-selected for cancel/rebill processing. The following information appears in the grid:

- **Selected Switch.** If this switch is turned on, the bill segment will be cancel / rebilled when the **Cancel/Rebill/Freeze** button is clicked. You can use the mouse to toggle the value of this switch on a specific bill segment. Alternatively, you can click the **Select All** button or **Clear All** button to toggle the switch for all frozen bill segments. The checkbox is disabled if the bill segment's bill is written off. Note: the total number of selected bill segments is shown above the grid for confirmation purposes.
- **Start Date.** This is the first day of the bill segment.
- **End Date.** This is the last day of the bill segment.
- **Create Date/Time.** This is the day/time the bill segment was created.
- **Amount.** This is the payoff amount of the bill segment.
- **Original Amount.** This column only contains a value if the bill segment is a rebill of another bill segment. In this situation, one of the following values will be displayed:
 - If the amount of the new bill segment differs from the amount of the original bill segment, the amount of the original bill segment will be displayed.
 - If the amount of the new bill segment equals the amount of the original bill segment, the word No change will be displayed.
- **Bill Segment Information.** This is the standard bill segment summary information.

NOTE:

Sorting By Values In The Grid. Just like all grids in the system, you can click on a column heading to resort the grid by the value of the respective column. This might be useful to sort the bill segments in **Amount** order.

After selecting the bill segments to be cancel/rebilled, click the **Cancel/Rebill/Freeze** button. When this button is clicked, an additional informational page displays. Specify the following information and then click **Calculate** to cancel the selected bill segment and create new bill segments:

- **Cancel Reason** defines why the bill segment(s) are being canceled.
- **Accounting Date** is used to define the financial period to which the canceled and new bill segments' financial transactions will be booked.
- Turn on **Allow Estimates**
- Use the **Billing Option** to define how the system looks for meter reads:
 - Select Use Schedule if the system should select reads based on the SA's SP's schedule.
 - Select Use Cut off Date if the system should only select reads from the end date of the existing bill segment.
- Select Use Schedule if the system should select reads based on the SA's SP's schedule.
- Select Use Cut off Date if the system should only select reads from the end date of the existing bill segment.
- If you'd prefer to have the system use the consumption details snapshot on the original bill segments, turn on **Use Old Read/Item/SQ**. If this switch is on then neither **Allow Estimates** nor **Billing Option** is relevant.

NOTE: The **Use Old Read/Item/SQ** switch is not available if the bill's SA references an SA type with a special role flag of Bill Determinants Required.

WARNING:

If the cause of the rebill is an incorrect rate and the new rate requires service quantities that were not calculated when the bill was originally calculated, do not turn on **Use Old Read/Item/SQ**. Why? Because you want the system to derive new service quantities during the rebill process.

NOTE:

Default note. The Accounting Date is defaulted to the current date and the **Use Old Read/Item/SQ** switch is turned on.

After specifying the above information, the system cancel / rebills each segment in chronological order (i.e., earlier segments will be cancel / rebilled before later segments). The new amount of each bill segment is shown in the **Original Amount** column. You can navigate to the [Graph](#) page to graphically view the financial ramifications of the cancel/rebills.

NOTE:

Errors. It's possible that bill segment errors will occur when you cancel / rebill the bill segments. For example, if you change the SA's rate to a rate that requires a unit-of-measure that doesn't exist on the SA's meter, a bill segment error will be generated. If this occurs, you must go to [Bill Segment - Main](#) for the pending cancel bill segment and use the **Undo** action to remove the offending bill segment (and restore the original segment to the Frozen state). Alternatively, you can drill down on the Error bill segment and use the **Regenerate** action after correcting the cause of the problem.

There is no Undo. Unlike cancel / rebills performed on [Bill Segment - Main](#), there is no Undo action. This is because the multi-cancel/rebill transaction freezes the newly created bill segments after it cancel/rebills; whereas the bill segment transaction lets you examine the new bill segment before you freeze it. If you made a mistake, simply correct the cause of the mistake and then cancel / rebill again. The erroneous financial transactions will be automatically suppressed on the next bill produced for the customer.

Multi Cancel/Rebill - Graph

This page contains a graph that shows the rebilled and original payoff amounts for a service agreement's non-cancelled bill segments. Open **Menu > Financial > Multi Cancel/Rebill** and navigate to the **Graph** page to view this information.

Description of Page

This page contains a graph that shows the payoff amounts for a service agreement's non-cancelled bill segments (represented by the blue bars in the graph). If a bill segment is a rebill of another bill segment, the payoff amount of the original bill segment is displayed on a red-colored bar adjacent to the respective blue bar.

NOTE:

Click a bar. You can click on a bar to drill down to a bill segment.

SA Billing History

Open **Menu > Financial Query > SA Billing History** to view a history of all bill segments produced for a service agreement.

Description of Page

The **Account ID** is displayed with the account's name adjacent.

The **SA Information** shows a summary of information about the service agreement. The **SA ID** is the unique identifier of this SA.

One row is displayed for every bill segment ever produced for the selected service agreement.

The following information is displayed for each bill segment:

- The **Start Date** and **End Date** of the bill segment.
- The number of **Days** in the bill segment consumption period.
- The **Status** of the bill segment
- The **Current** and **Payoff Amounts** of the bill segment.
- The **UOM** (Unit of Measure) of the service quantity designated as the "graph UOM" for the SA's SA type.
- The total amount of the service **Billable Service Quantity** that was billed.
- The **Avg Daily Qty** is the **Billable Service Quantity** divided by the numbers of days of service.

If you need to see more detailed information about the bill segment, click the go to button to transfer to the bill segment page.

Bill Exception

If errors are detected during the billing process, it may cause a record to be written to the bill exception table with a message indicating the nature of the severe error.

To view the messages associated with the exception records, schedule the **TD-BIERR** background process. This process generates a To Do entry for every record in the bill exception table.

FASTPATH:

Refer to [How to Correct a Bill That's In Error](#) for instructions describing how to correct a bill.

Bill Segment Exception

If errors are detected during the billing process, it may cause a record to be written to the bill segment exception table with a message indicating the nature of the severe error.

To view the messages associated with the exception records, schedule the [TD-BSERR](#) background process. This process generates a To Do entry for every record in the bill segment exception table.

FASTPATH:

Refer to [How To Correct A Bill Segment That's In Error](#) for instructions describing how to correct a bill segment.

Maintaining Billable Charges

You create a billable charge whenever a customer should be charged for a service that occurs outside the normal course of business. For example, you would create a billable charge to charge a contractor for the repair of a ruptured gas line.

NOTE:

Billable charges can be uploaded from an external system. Refer to [Uploading Billable Charges](#) and [Using Billable Charges For Pass Through Billing](#) for more information.

A billable charge must refer to a service agreement. This service agreement behaves just like any other service agreement:

- **Bill segments are created for the service agreement.** Whenever billing is performed for an account with billable charge service agreements, the system creates a bill segment for each billable charge. This means that if a service agreement has many unbilled billable charges, it will have many bill segments.
- **Payments are distributed to the service agreement.** Payments made by an account are distributed to its billable charge service agreements just like any other service agreement.
- **Overdue debt is monitored.** The credit and collections process monitors billable charge service agreements for overdue debt and responds accordingly when overdue debt is detected.
- This service agreement must reference an SA Type that has a Special Role of Billable Charge. If such a service agreement does not already exist for the account, one must be created before you can levy a billable charge. See "For more information" at the end of this section for links to other sections that will help you with this process.

Billable charge templates exist to minimize the effort required to create a billable charge for a customer. A billable charge template contains the standard bill lines, amounts and distribution codes used to charge for a one-off charge.

A user may override the information on the template when the billable charge is created. For example, you can create a billable charge template to levy charges when a contractor ruptures a gas main. This template would contain the bill lines, amounts and distribution codes associated with a ruptured pipe repair. Then, when a contractor ruptures a line, a user can create a billable charge using the template and override the amount to reflect the actual repair amount (if it differs from the norm).

NOTE:

Templates aren't required. A billable charge can be created without a template for a truly unexpected charge. If you don't use a template, you'll have to enter the bill information manually.

FASTPATH:

Refer to [Setting Up Billable Charge Templates](#) for more information.

NOTE:

Adding taxes and other calculation lines to a billable charge. Refer to [Billable Charge - SQ Details](#) for information about how to have the system calculate tax lines and append them to the billable charge.

Billable Charge - Main

Open **Menu > Financial > Billable Charge > Search** to maintain a billable charge.

Description of Page

The **Billable Charge ID** is system generated. The **Account ID** of the account responsible for the charge is displayed at the top.

Use **SA ID** to define the ID of the billable charge service agreement that will hold the billable charge's debt. The **Account ID** for the service agreement is displayed for information purposes.

Use **Start Date** and **End Date** to define the charge's bill period.

NOTE:

Installment billable charges. You can create many future dated billable charges to implement unusual installment plans. For example, if you want to bill a customer \$250 today, \$150 next month, and \$1000 three months from now; you could create three billable charges with a date that reflects the earliest bill date. When a bill is produced for the account, the system will create a bill segment for every billable charge whose start date is on or before the current date.

If you want to create the billable charges from an existing template, enter the ID of the **Billable Charge Template** from which the billable charge information defaults. If your **SA Type** indicates a billable charge template, that value will be defaulted. The billable charge template is stored with the billable charge, to reference what was used to create it.

NOTE: Actual billable charge lines can differ from what was originally defaulted from the billable charge template if user overrides were done after defaulting. Refer to [Maintaining Billable Charges](#) for more details.

Use **Description on Bill** to define the verbiage that should print on the customer's bill above the line item details.

Billable Charge Status defines the state of the billable charges. Possible values are Billable and Cancelled. Click the **Cancel** button to cancel a billable charge.

Bill Segment ID is the ID of the bill segment on which the billable charge's charge details appear. This information is only populated AFTER the billable charge has been swept onto a bill.

The **Total Bill Amount** displays the sum of all billable charge lines except those that are **Memo Only**. The **Total Line Amount** displays the sum of all billable charge lines except those that **Appear In Summary**.

The information in the scroll defines the line item details associated with the billable charge. Click the drill down button to navigate to the line characteristics. The following fields are required for each line:

Sequence Sequence controls the order in which the line items appear on the bill segment.

Description on Bill Specify the verbiage to print on the bill for the line item.

Charge Amount Specify the amount to charge for the line item.

Show on Bill Turn this switch on if the line item should appear on the customer's printed bill. It would be very unusual for this switch to be off.

Appears in Summary Turn this switch on when the amount associated with this line also appears in a summary line. This switch plays a part at bill print time - those lines that appear in a summary print in the left dollar column, those that don't appear in a summary print in the right dollar column. Also note, those lines that appear in a summary line are not included in the total amount associated with the billable charge.

Memo Only, No GL Turn this switch on if the billable charge line does not contribute to the total amount due (e.g., this switch would be on for "information only" lines).

Distribution Code Specify the distribution code that identifies the GL account associated with this line item. The description of the code appears adjacent.

FASTPATH:

For more information about billing billable charges, refer to [How To Create A One-Time Invoice](#). For more information about billable charge templates, refer to [Setting Up Billable Charge Templates](#).

Billable Charge - Line Characteristics

Characteristics may be associated with billable charge lines. Typically, this is done to categorize billable charge lines for reporting purposes.

Open **Menu > Financial > Billable Charge > Search** and navigate to the **Line Characteristics** page to maintain characteristics that are associated with billable charge.

Description of Page

The **Billable Charge Line** scroll defines the billable charge line to which you wish to assign characteristic values. The following fields display:

Characteristic Type The type of characteristic.

Characteristics Value The value of the characteristic.

NOTE:

You can only choose characteristic types defined as permissible on a billable charge line. Refer to [Setting Up Characteristic Types & Their Values](#) for more information.

Billable Charge - SQ Details

Optionally, you may specify service quantities associated with a billable charge. These are most commonly used when you want the system to calculate charges *in addition to the billable charge lines* (e.g., adding tax to the billable charge lines).

NOTE:

The SA must specify a rate. If you want the system to calculate additional charges based on the service quantities defined on this page, the related billable charge service agreement must reference a rate. This rate must have calculation rules that calculate charges based on the service quantities specified on this page. When the service agreement is next billed, the system will sweep on the billable charges and then call the rate and pass it the service quantities defined on this page. The rate will calculate the additional charges and these will be appended to the bill segment.

Open **Menu > Financial > Billable Charge > Search** and navigate to the **SQ Details** page to maintain a billable charges service quantities.

Description of Page

The following fields display:

Sequence Specify the sequence number of the SQ.

UOM Select the unit of measure of this SQ. One or more of **UOM**, **TOU**, or **SQ Identifier** must be selected.

TOU Select the time of use period.

SQ Identifier Select the SQ identifier.

Service Quantity Specify the number of units of this service quantity.

Billable Charge - Read Details

Optionally, you may specify meter read details associated with a billable charge. These are most commonly used when you need to print the read details that were used to calculate the bill lines that appear on the main tab.

NOTE:

Using these reads to derive billable consumption. The base package bill segment creation algorithm (BSBC-BC) simply sweeps billable charge read details onto the related bill segment as [calculation / audit reads](#). This algorithm does NOT use these reads to derive billable consumption. This is intentional as most implementations that import reads also import billable consumption and therefore deriving billable consumption is unnecessary (and also error prone). If your implementation needs to derive billable consumption from these reads, you can develop your own bill segment creation algorithm to do just this.

Open **Menu** > **Financial** > **Billable Charge** > **Search** and navigate to the **Read Details** page to maintain a billable charges service quantities.

Description of Page

The grid is a snapshot of the meter reads whose consumption was billed using the bill lines shown on the main tab. One row exists for every read that should be swept onto the related bill segment as a [calculation / audit read](#) when the system creates a bill segment for this billable charge. The following information is displayed in the grid:

- **Final Unit of Measure** is the unit of measure of the resultant billing quantity.
- **Final Time of Use** is the time-of-use code of the resultant billing quantity.
- **Final Service Quantity Identifier** is the service quantity identifier of the resultant billing quantity.
- **Register Quantity** is the resultant billing quantity.
- **How To Use (SP)** is the SA/SP's how to use code.
- **Service Point ID** is the unique identifier of the service point at which the meter was located.
- **Meter Configuration ID** is the unique identifier of the meter's configuration.
- **Sequence** is the sequence number of the register on the meter.
- **Unit of Measure** is the register's unit of measure.
- **Time of Use** is the register's time-of-use code.
- **SQI** is reserved for future use.
- **Start Register Reading** is the start register reading.
- **End Register Reading** is the end register reading.
- **Measured Quantity** is the resulting measured quantity.
- **Register Constant** is the constant on the register that is multiplied by the measured quantity to derive the register's billable consumption.
- **How To Use** is the register's how to use code.

- **Use Percent** is the SA/SP's usage percentage. A value of 100% is defaulted.
- **Measures Peak Qty** indicates if the unit of measure is one that measures peak consumption.
- **Start Read Date/Time** is the date and time of the start meter read. If the register is consumptive, (as opposed to subtractive) nothing will be displayed.
- **End Read Date/Time** is the date and time of the end meter read.
- **Start Reg Read ID** is the unique identifier of the start register read. If the register is consumptive, (as opposed to subtractive) nothing will be displayed.
- **Read Type** is the read type of the start meter read.
- **End Reg Read ID** is the unique identifier of the end register read.
- **Read Type** is the read type of the end meter read.
- **Multiplier** is the composite multiplier that converts the measured quantity to the registered quantity.

NOTE:

The multiplier is calculated by dividing the Register Quantity by the Measured Quantity (if the Measured Quantity is 0, then the result is 0). This is not stored on the database. There is a chance that the value is not precise due to round-off.

Uploading Billable Charges

This section describes how the system uploads billable charges from an external source. This mechanism is used when you need to ["pass through" charges](#) that have been calculated by a third party but appear on your bill.

Billable Charge Upload Background Processes

The following diagram illustrates the processes involved in the uploading of billable charges into the system.

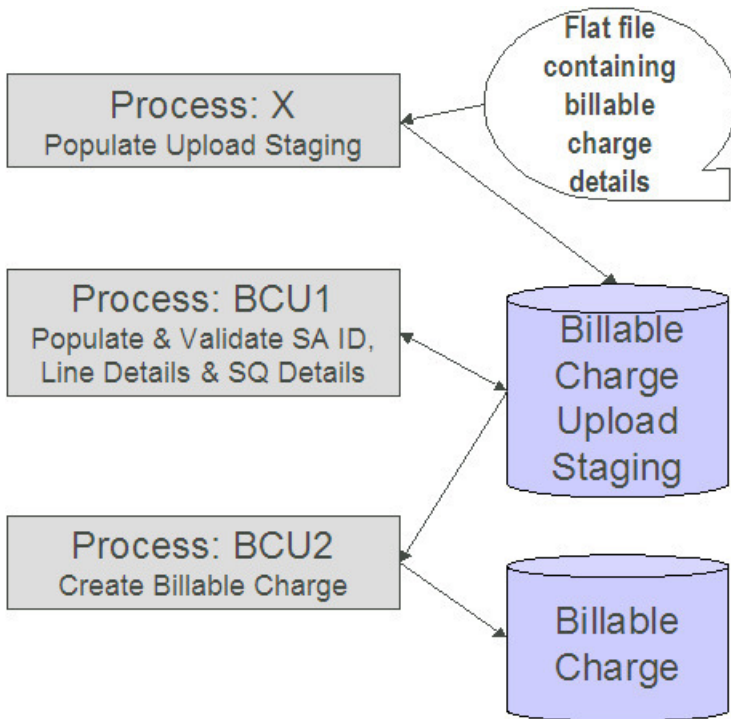

The topics in this section describe how these processes work.

Process X - Populate BC Upload Staging

Process X refers to the mechanism used by your organization to populate the various staging tables (shown in the yellow section of the following ERD).

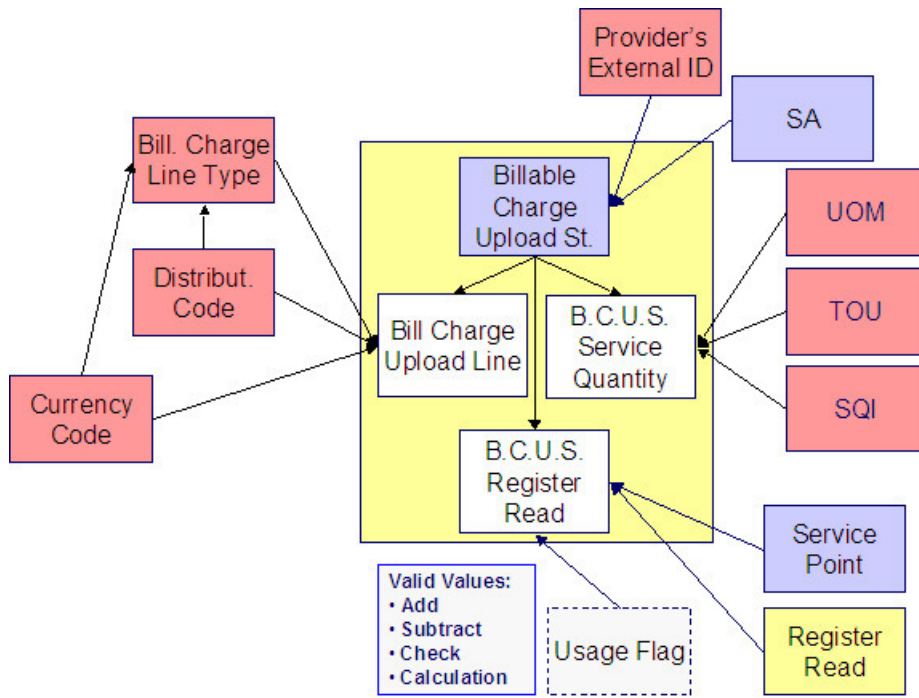

The topics in this section describe each of these tables.

Billable Charge Upload Staging Layout

You must create an upload staging record for each billable charge. The name of this table is **CI_BCHG_UP**. The following table describes each column on this table.

Column Name	Length	Req'd	Data Type	Comments
BCHG_UP_ID	30	Y	Char	This is the unique identifier of the record. This value does NOT have to be a random number, but it does need to be unique. If your process that inserts records on this table is capable of calling a routine, call ProgramCIPZKEYG and it will supply a 12 digit random number for you.
BCHG_UP_STAT_FLG	2	Y	Char	This must be set to P for Pending.
NT_XID_CD	30	N	Char	This is the external system id of the sender of the billable charge. See the description of the SA_EXT_REFT_ID field for how this field is used to determine the billable charge's SA_ID.
SA_EXT_REF_ID	36	N	Varchar2	This field along with NT_XID_CD are used to uniquely identify the service agreement against which the billable charge will be stored. These two fields are used to identify a SA relationship record; the SA relationship record, in turn, has a sub SA and it is this SA that the billable charge will be linked to. Note well: these fields are only necessary if you do not know the billable charge SA ID. Refer to Maintaining SA Relationships for more information.

BCHG_EXT_REF_ID	50	N	Varchar2	This is the identifier of the billable charge in the sender's system.
CRE_DTTM	26	N	Date/Time	The date and time the upload staging row was inserted (this can be used for audit purposes).
START_DT	10	Y	Date	The start date of the period encompassed by the billable charge.
END_DT	10	Y	Date	The end date of the billable charge period.
DESCR_ON_BILL	254	Y	Varchar2	This is the description that should prefix the charges on the printed bill.
SA_ID	10	See note	Char	This must correspond with a SA ID of a billable charge service agreement. You may leave this column blank if NT_XID_CD and SA_EXT_REF_ID are populated.
BILLABLE_CHG_ID	12	N	Char	Leave this column blank. It will be assigned by the system when it creates a billable charge record.

Billable Charge Line Upload Staging Layout

You must create a billable charge line upload record for each line to be uploaded. The name of this table is **CI_BCHG_LINE_UP**. The following table describes each column on this table.

NOTE:

Defaulting from BCHG_UP_XTYPE. Please pay special attention to the **Comments** column below as many fields, if left blank, will default from each record's BCHG_UP_XTYPE.

Column Name	Length	Req'd	Data Type	Comments
BCHG_UP_ID	30	Y	Char	This is the foreign key to the billable charge upload staging record.
LINE_SEQ	3	Y	N	This is the unique line number of the billable charge line. This value must be unique within the billable charge.

DESCR_ON_BILL	254	Y	Varchar2	This is the description that will be printed on the bill for the line.
CHARGE_AMT	13.2	N	N	This is the amount associated with the billable charge line.
BCHG_LINE_XID	20	N	Varchar2	This is the unique identifier of the billable charge line in the sender's system.
BCHG_UP_XTYPE	30	N	Char	This is the type of billable charge line. This is a foreign key reference to the billable charge line type control table. This control table is used to populate the remaining fields (if they are blank). If this field is blank, the remaining fields must be specified as they cannot be defaulted from the billable charge line type control table. Refer to Billable Charge Line Type for more information.
CURRENCY_CD	3	See note	Char	This is a foreign key reference to the currency code of the billable charge line. This field must be specified if CHARGE_AMT is non-zero.
SHOW_ON_BILL_SW	1	See note	Char	This should be Y if the line should appear on the customer's printed bill. This should be N if the line should not appear on the customer's printed bill. If left blank, this value will be populated from the line's BCHG_UP_XTYPE.
APP_IN_SUMM_SW	1	See note	Char	This should be Y if the line appears in a summary line. This should be N if the line does not appear in a summary line. This switch plays a part at bill print time - those lines that appear in a summary print in the left dollar column, those that don't appear in a summary print

				in the right dollar column. If left blank, this value will be populated from the line's BCHG_UP_XTYPE.
MEMO_SW	1	See note	Char	This should be Y if the line does NOT affect the general ledger. This should be N if the line affects the general ledger. If left blank, this value will be populated from the line's BCHG_UP_XTYPE.
DST_ID	10	See note	Char	If the line affects the general ledger, the set ID (the previous field) and the distribution code of the GL account must be specified. If left blank, this value will be populated from the line's BCHG_UP_XTYPE.

Billable Charge Line Characteristic Upload Staging Layout

If you want to upload characteristics on your billable charge lines, you must create a billable charge line characteristic upload record for each characteristic on each line. The name of this table is **CI_B_LN_UP_CHAR**. The following table describes each column on this table.

Column Name	Length	Req'd	Data Type	Comments
BCHG_UP_ID	30	Y	Char	This is the foreign key to the billable charge upload staging record.
LINE_SEQ	3	Y	N	This is the foreign key to the billable charge line upload staging record
CHAR_TYPE_CD	8	Y	Char	This is the unique identifier of the billable charge line characteristics. This value must be unique within the billable charge line characteristics.
ADHOC_CHAR_VAL	30	N	Varchar2	An ad hoc characteristic value must be supplied if the ad hoc switch on characteristic type is Y. Otherwise, it is not allowed.

CHAR_VAL	16	N	Char	A characteristic value must be supplied if the ad hoc switch on characteristic type is N. Otherwise, it is not allowed.
CHAR_VAL_FK1	50	N	Varchar2	A characteristic value foreign key must be supplied if the ad hoc switch on characteristic type is Y. Otherwise, it is not allowed.
CHAR_VAL_FK2	50	N	Varchar2	A characteristic value foreign key must be supplied if the ad hoc switch on characteristic type is Y. Otherwise, it is not allowed.
CHAR_VAL_FK3	50	N	Varchar2	A characteristic value foreign key must be supplied if the ad hoc switch on characteristic type is Y. Otherwise, it is not allowed.
CHAR_VAL_FK4	50	N	Varchar2	A characteristic value foreign key must be supplied if the ad hoc switch on characteristic type is Y. Otherwise, it is not allowed.
CHAR_VAL_FK5	50	N	Varchar2	A characteristic value foreign key must be supplied if the ad hoc switch on characteristic type is Y. Otherwise, it is not allowed.

Billable Charge Service Quantity Upload Staging Layout

You must create a billable charge service quantity upload record for each service quantity to be uploaded. The name of this table is **CI_BCHG_UP_SQ**. The following table describes each column on this table. Refer to ["pass through" charges](#) for more information about how this type of information is used.

Column Name	Length	Req'd	Data Type	Comments
BCHG_UP_ID	30	Y	Char	This is the foreign key to the billable charge upload staging record.

SEQ_NUM	3	Y	N	Sequence of the service quantity within the Billable Charge Upload
UOM_CD	30	N	Varchar	The unit of measure of the Billable Charge Upload SQ row. If specified, it must reference a valid value on CI_UOM. Note, at least one of the following fields should be specified: SQI_CD, TOU_CD, UOM_CD.
TOU_CD	30	N	Char	The time of use of the Billable Charge Upload SQ row. If specified, it must reference a valid value on CI_TOU. Note, at least one of the following fields should be specified: SQI_CD, TOU_CD, UOM_CD.
SQI_CD	30	N	Varchar	The service quantity identifier of the Billable Charge Upload SQ row. If specified, it must reference a valid value on CI_SQI. Note, at least one of the following fields should be specified: SQI_CD, TOU_CD, UOM_CD.
SVC_QTY	12.6	N	N	Quantity of the service used for the UOM / TOU / SQI combination

Billable Charge Read Details Upload Staging Layout

You must create a billable charge read details upload record for each read detail to be uploaded. The name of this table is **CI_BCHG_UP_READ**. The following table describes each column on this table. Refer to ["pass through" charges](#) for more information about how this type of information is used.

Column Name	Length	Req'd	Data Type	Comments
BCHG_UP_ID	30	Y	Char	This is the foreign key to the billable charge upload staging record.
SP_ID	10	Y	Char	Note, if USAGE_FLG is calculation, you can set this field to 0 if you do not know the SP ID. The only thing that's important is

that the combination of BCHG_UP_ID, SP_ID and SEQNO are unique.

SEQNO	5	Y	Number	This should be a value greater than zero. See SP_ID comment for more information. This is typically the sequence number of the register on the meter.
END_READ_DTTM	26	Y	DateTime	This is the date and time of the end read
END_REG_READ_ID	12	N	Char	This field must reference an existing register read ID if USAGE_FLG is anything other than a calculation.
END_REG_READING	9.6	Y	Number	This is the reading of the end read.
FINAL_REG_QTY	12.6	Y	Number	This is the final amount of the reading (this is the amount of billable consumption the read detail contributed to the entire billed consumption).
FINAL_SQI	8	N	Char	The service quantity identifier of the FINAL_REG_QTY. If specified, it must reference a valid value on CI_SQI. Note, at least one of the following fields should be specified: FINAL_SQI, FINAL_UOM_CD.
FINAL_TOU_CD	8	N	Char	The time-of-use code of the FINAL_REG_QTY. If specified, it must reference a valid value on CI_TOU.
FINAL_UOM_CD	4	N	Char	The unit of measure of the FINAL_REG_QTY. If specified, it must reference a valid value on CI_UOM. Note, at least one of the following fields should be specified: FINAL_SQI, FINAL_UOM_CD.
HOW_TO_USE_FLG	2	Y	Char	See the field description in the data dictionary

				for the valid values (CI_BCHG_UP_READ).
MSR_PEAK_QTY_SW	1	Y	Char	Y or N
MSR_QTY	12.6	Y	Number	This is the difference between END_REG_READING and START_REG_READING for subtractive registers.
REG_CONST	6.6	Y	Number	This is the register's constant (the value used to adjust the measured quantity due to something associated with the physical meter). Set this to a value of 1 if it is not known.
SQI_CD	30	N	Varchar	The service quantity identifier of END_REG_READING and START_REG_READING . If specified, it must reference a valid value on CI_SQI. Note, at least one of the following fields should be specified: SQI_CD, TOU_CD, UOM_CD.
START_READ_DTTM	26	Y	DateTime	This is the date and time of the start reading.
START_REG_READ_ID	12	Y	Char	This field must reference an existing register read ID if USAGE_FLG is anything other than a calculation.
START_REG_READING	9.6	Y	Number	This is the reading of the start read.
TOU_CD	30	N	Char	The time-of-use code of END_REG_READING and START_REG_READING . If specified, it must reference a valid value on CI_TOU.
UOM_CD	30	Y	Char	The unit of measure of END_REG_READING and START_REG_READING .
USAGE_FLG	2	Y	Char	See the field description in the data dictionary for the valid values (CI_BCHG_UP_READ).

BCU1 - Validate & Populate Billable Charge Upload Staging

This process has several functions:

- It populates the SA ID on all BC upload staging records where SA ID is left blank. This means that you don't have to know the SA ID in order to interface a billable charge into the system. The program populates SA ID with the service agreement related to the SA relationship with the most recent effective date for a given combination of service provider's external system ID and customer's ID in the sender's system. The system can only do this if the following points are true:
- You use the system's SA relationship functionality to define that you provide bill ready billing services for a service provider. On the customer's SA relationship record you must define the customer's ID in the service provider's system. Refer to [Maintaining SA Relationships](#) for more information.
- You identify the service provider's external system ID on the billable charge upload staging record.
- You identify the customer's ID in the sender's system.

NOTE:

You can still interface billable charges if you don't use the system's SA relationship functionality. How? You simply need to derive the SA ID associated with the uploaded billable charge.

- It populates various fields (e.g., the GL distribution code, memo only switch) on the billable charge upload line records from the billable charge line type specified on each respective record.

Any validation / population errors detected during this process are written to the [BC Upload Exception](#) table. You can fix errors using BC Upload Staging page (don't forget to change the record's status back to Pending).

BCU2 - Create Billable Charge

This process creates a billable charge and billable charge lines (shown in the yellow section of the following ERD) for all BC upload records in the Pending state.

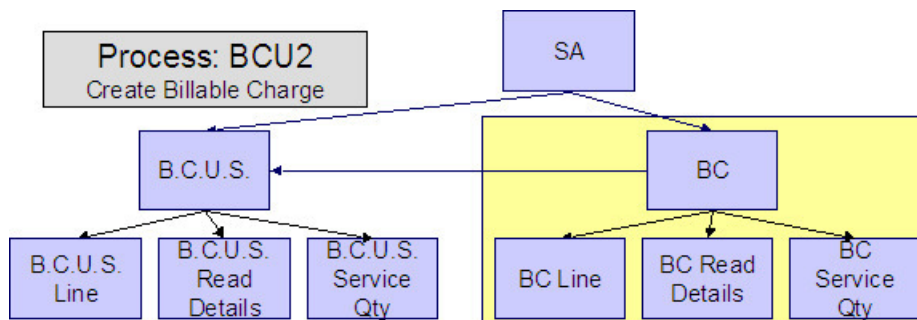

If the billable charge's SA is Closed, it will Reactivate it so that the billable charges will be swept onto the next bill produced for the account.

NOTE:

This process will override the values of the various switches referenced on billable charge upload staging line if the respective service agreement's SA type has an override value for the line's billable charge line type. Refer to [SA Type - Billable Charge Overrides](#) for more information.

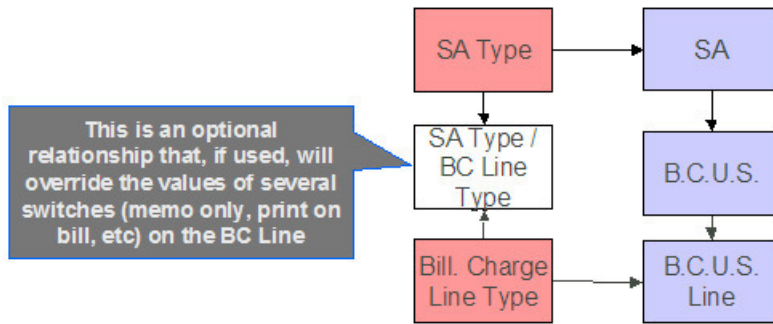

Any errors detected during this process are written to the [Billable Charge Upload Exception](#) table. You can fix errors using BC Upload Staging page (don't forget to change the record's status back to Pending).

BCUP-PRG - Purge Billable Charge Upload Objects

Completed billable charge upload staging objects should be periodically purged from the system by executing the [BCUP-PRG](#) background process. This background process allows you to purge all Completed billable charge upload staging objects older than a given number of days.

We want to stress that there is no system constraint as to the number of Completed billable charge upload objects that may exist. You can retain these objects for as long as you desire. However we recommend that you periodically purge Completed billable charge upload objects as they exist only to satisfy auditing and reporting needs.

Billable Charge Upload Staging

The Billable charge Upload Staging page has three purposes:

- You can view historical billable charge upload records.
- You can correct billable charge upload records that are in error.
- You can add new billable charge upload records. These will be uploaded by the billable charge upload process (although it's probably easier to just add the billable charges using the [Maintaining Billable Charges](#) page).

The topics in the section describe how to maintain this information.

Billable Charge Upload - Main

Open this page using **Menu > Financial > Billable Charge Upload Staging > Search.**

Description of Page

FASTPATH:

Refer to [Billable Charge Upload Staging](#) for more information about these fields.

NOTE:

Correcting Errors. If a Billable Charge Upload record's status is Error , you should correct the problem and then change its status back to Pending. The next time the billable charge upload process runs, it will revalidate the record and, if valid, it will create a billable charge record.

Billable Charge Upload - Lines

Open this page using **Menu > Financial > Billable Charge Upload Staging > Search** and navigate to the **Lines** page.

Description of Page

FASTPATH:

Refer to [Billable Charge Line Upload Staging](#) for more information about these fields.

Billable Charge Upload - SQ Details

Open this page using **Menu > Financial > Billable Charge Upload Staging > Search** and navigate to the **SQ Details** page.

Description of Page

FASTPATH:

Refer to [Billable Charge Service Quantity Upload Staging](#) for more information about these fields.

Billable Charge Upload - Read Details

Optionally, you may specify meter read details associated with a billable charge. These are most commonly used when you need to print the read details that were used to calculate the bill lines that appear on the main tab.

NOTE:

Using these reads to derive billable consumption. The base package bill segment creation algorithm (BSBS-BC) simply sweeps billable charge read details onto the related [bill segment's read detail](#). This algorithm does NOT use these reads to derive billable consumption. This is intentional as most implementations that import reads also import billable consumption and therefore deriving billable consumption is unnecessary (and also error prone). If your implementation needs to derive billable consumption from these reads, you can develop your own bill segment creation algorithm to do just this.

Open **Menu > Financial > Billable Charge Upload Staging > Search** and navigate to the **Read Details** page to view this information.

Description of Page

FASTPATH:

Refer to [Billable Charge Read Details Upload Staging](#) for more information about these fields.

Billable Charge Upload Exception

If errors are detected during the billable charge upload process, a record is written to the billable charge upload exception table with a message indicating the nature of the severe error.

To view the messages associated with the exception records, schedule the [TD-BCUPL](#) background process. This process generates a To Do entry for every record in the billable charge upload exception table.

You can fix this error using the [Billable Charge Upload Staging](#) page and change the status of the record from Error to Pending. When the billable charge upload process next runs, it attempts to upload this record again.

Budget Review

The Budget Review page shows all accounts with an anomalous budget amount.

NOTE:

This information on this page is created by the [Budget Monitor](#) background process.

Open this page using **Menu > Financial Query > Budget Review**.

Description of Page

One row is displayed for every account whose current budget amount is out-of-sync with the recommended budget amount.

Clicking the Go To button will cause the [Account - Budget](#) page to open. When this page opens you can recalculate the customer's budget amount.

Payments

In this section, we describe how to manage your customer's payments.

The Big Picture of Payments

A payment reduces how much an account owes. The topics in this section provide background information about a variety of payment topics.

A Payment Event Has Payments And Tenders

The explanation in [The Financial Big Picture](#) provides an accurate, but incomplete view of payments. The missing pieces concern *payment events* and *tenders*. The following diagram illustrates the difference between a payment event, its payment(s) and its tender(s).

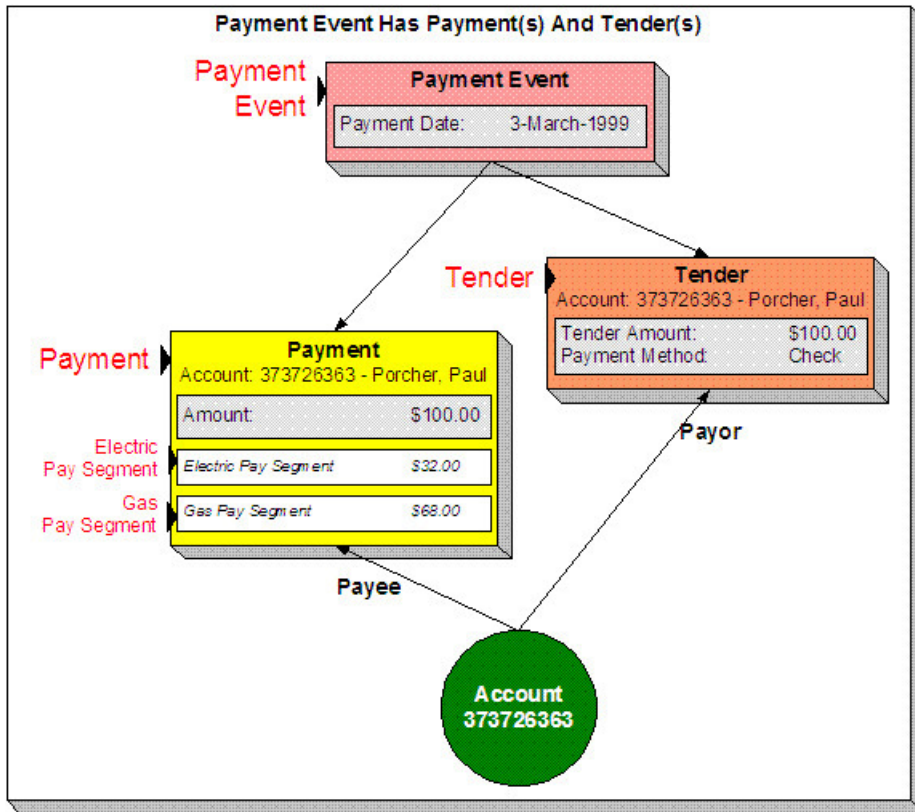

The following concepts are illustrated above:

A payment event defines the event A payment event is required whenever any form of payment is received. The payment event defines the payment date (and that's all).

A payment event has tender(s) A tender exists for every form of tender remitted as part of the payment event. A payment event must have at least one tender otherwise nothing was remitted. A payment event may have many tenders when multiple payment methods are associated with an event (e.g., paying with cash, a check, and a credit card).

A payment is allocated to account(s) The total amount of tenders under a payment event is distributed to one or more accounts.

A payment is distributed to SAs The system allocates an account's payment amount amongst its service agreements. The system creates a payment segment for each service agreement that receives a portion of the payment.

Payor and payee are frequently the same The account remitting the tender (the payor) is frequently the same as the account to which the funds are allocated (the payee). The next illustration provides an example when this is not the case.

Multiple Tenders Used To Pay For Multiple Accounts

The following diagram illustrates a payment event with multiple tenders where the payor of the tender is not the same as the account(s) receiving the payment.

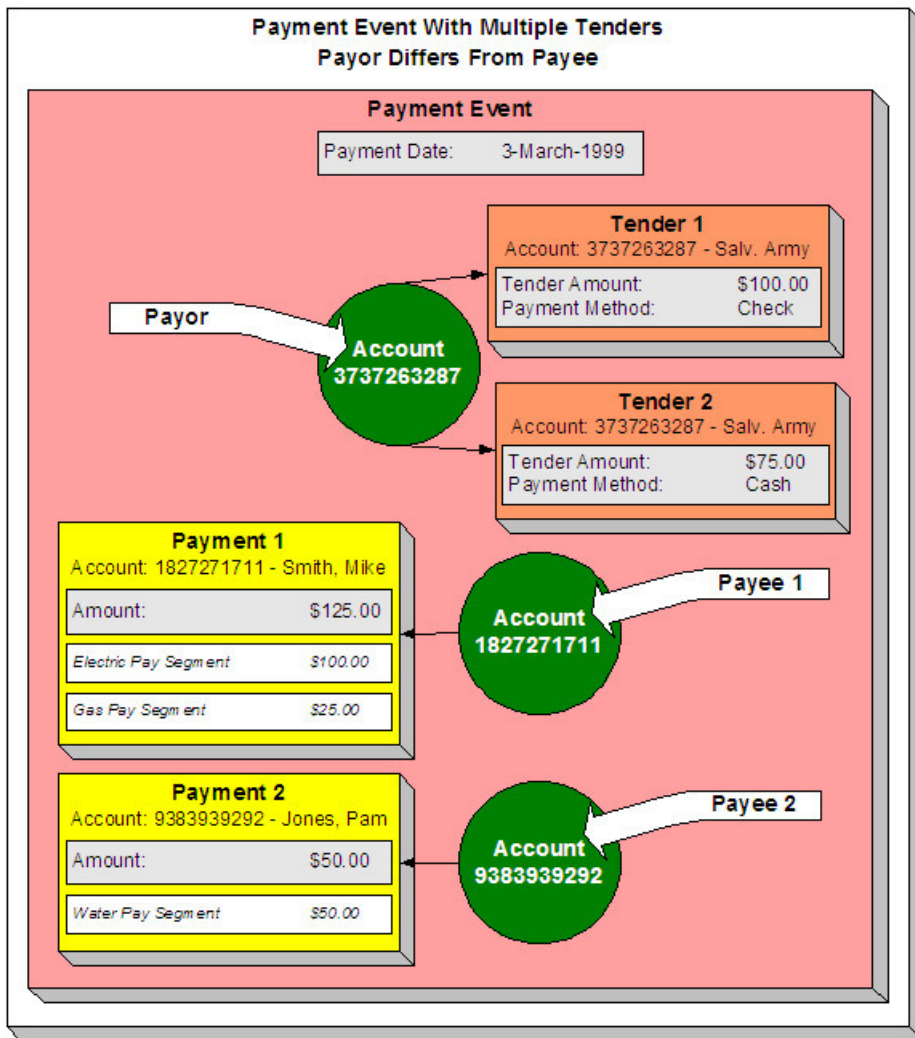

A payment event may have many tenders A single payment event may have many tenders. While the above example shows both tenders being paid by the same account, each tender may reference a different account.

Many accounts may be paid under 1 event The total amount of tenders under a payment event are distributed to one or more accounts.

Payor may differ from payee The account(s) remitting the tender may differ from the account(s) whose debt is relieved.

An Overview Of The Payment Event Creation & Allocation Process

When a payment event occurs, the system stores a tender for each form of remittance (e.g., cash, check, charge). It then allocates the sum of the tenders to one or more accounts.

By default, the system allocates the sum of the tenders to the account that remits the tenders. You may override this default and specify any number of accounts and their respective payment allocation amount. This is useful, for example, when a social service agency pays for many accounts. If applicable, you may also configure the system to use your own payment event distribution rule(s).

FASTPATH:

Refer to [Distributing A Payment Event](#) for more information.

The system distributes a payment amongst an account's service agreements based on the age of each service agreement's debt AND distribution priority. The system creates a payment segment for each service agreement that receives part of the payment.

FASTPATH:

Refer to [Distributing A Payment Amongst An Account's Service Agreements](#) for more information.

You may manually redistribute the payment amount amongst the account's service agreements before you commit the distribution. When the distribution is acceptable, you freeze the payment. Freezing a payment causes the system to create a financial transaction for each related payment segment. It is the financial transaction(s) that causes the service agreements' payoff and current balances to be reduced. The financial transaction also contains the journal details that debit "cash" and credit some other GL account.

And that's it. The remaining topics in this section provide more information about the creation and allocation of payment events.

NOTE:

Batch and real-time payment event creation / allocation. There is only one payment event creation / allocation routine and therefore anything the batch payment process does for whole batches of payments, you can do to a payment on-line.

Distributing A Payment Event

WARNING:

This section deals with the concept distributing a payment amount into payment(s). It does not discuss the distribution of a single payment into segments. **For more information** about payment distribution, refer to [Distributing A Payment Amongst An Account's Service Agreements](#).

The base-package, by default, creates a single payment for a payment event. Some business practices require potentially many payments to be created when payment events are added.

A few examples of when multiple payments may be necessary are:

- A payment amount needs to be distributed towards different distribution types:
 - \$50 in interest
 - \$60 in collection charges
 - \$70 in taxes
- Each of the above distributions is realized as a separate payment identified by its own match type (i.e., there'll be one match type called Interest, another called Collection Charges, etc.).

In this example, the debt of a single service agreement may be relieved by each of these payments.

- In a similar way, you may want to create a separate payment for an overpayment to differentiate it from regular payments (using yet another match type).
- In the case of a social service agency that pays for many accounts, a single payment event may be distributed amongst multiple accounts.

The method by which a payment amount is distributed to create payment(s) is contained in Create Payment [algorithms](#) plugged in on a distribution rule.

There is yet another aspect to having control over how payment events are created. The default method of creating payment events assumes knowledge of account IDs (of the payor and the payee) when making a payment. In cases where payments are made by and towards business entities other than accounts, knowledge of their corresponding account IDs may not be available at payment time. Consider the following examples:

- A payment is made to pay a person's bill, providing the person's identification at payment time.
- A payment is made towards a specific service agreement using a "contract number" defined as SA characteristic.

The method by which the tender account is determined by means of an alternate identifier is contained in Determine Tender Account [algorithm](#) plugged in on a distribution rule.

FASTPATH:

Refer to [Making Payments Using Distribution Rules](#) for information on how to configure your system to use this distribution method.

Distributing A Payment Amongst An Account's Service Agreements

WARNING:

This section deals with the concept of distributing a payment amongst an account's service agreements. It does not discuss how the sum of a payment event's tenders is balanced out by payment allocations. **For more information** about payment event balance, refer to [Unbalanced Payment Events](#).

A payment must be distributed to one or more service agreements for its financial impact to be realized. When a payment satisfies an account's entire debt, you don't have to worry about how the system distributes the payment. The concept of payment distribution is only relevant when a partial or excess payment is distributed.

The first important point to understand is that the method of distributing a payment amongst an account's service agreements is contained in an algorithm that's plugged in on to [Customer Class](#). This means that you can have different distribution algorithms for different customer classes.

NOTE:

Manual overrides. Most of the time, you'll let the payment distribution algorithm distribute the payment amongst an account's service agreements. However, you may manually distribute a payment when a customer directs a payment to specific service agreement(s).

The following explanation describes one of the base package payment distribution algorithms (refer to Payment Distribution - Pay Priority and Debt Age (PYDIST-PPRTY) for information about this algorithm). This algorithm distributes a payment based on:

- The age of each service agreement's debt.
- The payment distribution priority of each service agreement's SA type.

The following diagram helps illustrate how the distribution algorithm works.

**Distributing A Payment Amongst An Account's Service Agreements
Is Controlled By The Age Of The Debt And The SA's Distribution Priority**

		Priority 10 (Highest)		Priority 90 (Lowest)		
		SA #1	SA #2	SA #3		
Excess Credits		16				
New Debits*		13	14	15		
Non-Delinquent		10	11	12		
A r r e a r s	35-day Arrears	5	6	9	35-day Arrears	
	66-day Arrears	3	4	8	52-day Arrears	
	93-day Arrears	1	2	7	93-day Arrears	

*--Includes all charges not yet invoiced to the customer.

The above example shows three columns, one for each service agreement linked to a hypothetical account. Notice that two of the service agreements have the same distribution priority, the third has a lower priority. The numbers in the cells indicate the order in which the system distributes a partial payment.

NOTE:

Debt terminology. Before we can discuss the distribution algorithm, you must understand the terminology we use to categorize debt. **Delinquent** debt is associated with financial transactions that appear on overdue bills. **Non-delinquent** debt is associated with financial transactions that appear on current bills. **New debits** debt is associated with financial transactions that do not yet appear on a completed bill (e.g., a late payment charge that hasn't been billed yet).

The following points describe the algorithm used to distribute the partial payment:

- The system pays off delinquent debt of the highest priority service agreements first. In the above example, where multiple service agreements have the same distribution priority, the system does NOT payoff one service agreement before it starts on the next (which one would it pick?). Rather, it distributes the payment amongst the service agreements based on the age of the respective debt on each service agreement. In the above example, this is represented by steps 1 through 6 (notice how the distribution jumps between SA1 and SA2).
- After all delinquent debt has been relieved from the highest priority service agreement(s), the system pays off the next priority until all delinquent debt is relieved. In the above example, this is represented by steps 7 through 9.
- The system next pays off non-delinquent debt using each service agreement's respective distribution priority. Note well, the payment distribution algorithm doesn't associate an age with non-delinquent debt and therefore the distribution is

based purely on the service agreements' respective distribution priority. In the above example, this is represented by steps 10 through 12.

- After all non-delinquent debt is relieved, the system next pays off "new debit" debt based on the service agreements' respective distribution priority. In the above example, this is represented by steps 13 through 15.
- Refer to [Overpayment](#) for a description of what happens if money still exists after the above distribution is complete.

NOTE:

Payment segments and financial transactions. A payment segment exists for each service agreement that receives a portion of a payment. Linked to each payment segment is a financial transaction. It is the financial transaction that causes the service agreement's debt to be relieved and the general ledger to be impacted.

FASTPATH:

Refer to [Payment Exception](#) for more information about how the system handles errors detected during the payment distribution process.

NOTE:

Overriding the distribution algorithm for uploaded payments. The standard distribution algorithm is used for payments that are [Interfaced From An External System](#) unless you specify a MATCH_VALUE and MATCH_FLG on the [Payment Staging](#) row associated with the uploaded payment. These fields are used in conjunction to indicate that the distribution of the payment should be restricted in some way (i.e., the standard payment distribution algorithm should not be used). MATCH_FLG indicates how the payment should be distributed (e.g., only distribute to a specific service agreement), MATCH_VALUE contains the ID of the restriction (e.g., the SA ID).

Open item customers. For an [open-item customer](#), you MUST override the standard distribution algorithm because the payment is distributed as per the open items that it is relieving. Refer to [Payments And Match Events](#) for more information.

Overpayment

Overpayment refers to the situation where money is left over after a payment has been distributed to all eligible service agreements, and all debt is relieved. Refer to [Overpayment Segmentation](#) for a description on how to configure the system to handle your overpayment requirements.

Canceling A Tender Versus Canceling A Payment

A payment event has tender(s) and payment(s). You can cancel a tender when it's not valid, e.g., when a check bounces. You can cancel a payment when the account should not have received the payment (e.g., a misdistribution or a canceled tender).

When you cancel a tender, the system automatically cancels ALL frozen payments. We do this because if the tender is canceled, there are no funds to distribute to accounts (unless there are other non-canceled tenders under the event). However, when you cancel a payment, the system does NOT cancel the tender(s) because we assume that, if the tenders were incorrect, you would have canceled them rather than the payment.

NSF Cancellations

When a tender is canceled, a cancellation reason must be supplied. If the cancellation reason indicates a NSF (non sufficient funds) charge should be levied, the system invokes the NSF charge algorithm specified on the tender's account's [customer class](#). Algorithms of this type will typically create an adjustment or billable charge to levy the NSF charge. Refer to NSFC-DFLT for an example of such an algorithm.

NOTE:

The payor gets the NSF adjustments. It's possible for the payor of a tender to differ from the payee (e.g., when a social service agency pays for other customers' debt). When you cancel a tender you must specify a cancellation reason. If the cancellation reason indicates an NSF charge should be levied, the sample algorithm provided with the system levies the NSF charge on the PAYOR's account. Because adjustments must be linked to a service agreement, the algorithm picks the payor's service agreement with the highest payment distribution priority and levies the adjustment specified in the service agreement's SA type's NSF adjustment type.

Besides calling this algorithm, a NSF cancellation may affect the tendering [account's credit rating and cash-only score](#). The cancellation reason indicates the extent to which the account's ratings are affected.

And finally, whenever a tender is canceled due to non-sufficient funds, the account is scheduled for review by the [Account Debt Monitor](#).

Transferring A Payment

If the account on an event's tender and payment are wrong, you can use the [Transfer](#) button on the Payment Event page to transfer the payment to another account.

If the account on the payment is wrong - but the tender is correct, you can use the [Transfer](#) button on the Payment page to transfer the payment only to another account.

Unbalanced Payment Events

The system, by default, distributes the sum of a payment event's tenders to the account that remits the tender with a single payment. After distribution the sum of the tenders equals the sum of the payments when the event is first created. We refer to such an event as being balanced.

However, it is possible for an event's tender amount to not equal the sum of the payment allocations (i.e., the event becomes unbalanced). How? Well, there are several ways this can happen:

- While the system DEFAULTS the payment amount to be the tender amount, you can override the payment amount and therefore make a previously balanced event unbalanced.
- While the system DEFAULTS the payment account to be the tender account, you can add additional accounts / amounts and therefore make a previously balanced event unbalanced.
- When you cancel a tender (e.g., because a check bounces), the system cancels ALL payments linked to the tenders payment event. If the payment event has multiple tenders, this will cause the event to become unbalanced. To correct this situation, you must add payment allocations to equal the amount of uncanceled tenders.
- If you cancel a payment and forget to add another payment for the same amount, the event becomes unbalanced. To correct this situation, you must add another payment (or cancel the tender).
- You may delete a tender from an event while its tender control is open. If you delete a tender and don't do anything about the related payments, the event becomes unbalanced.
- You may add a tender to an event at any time. If you don't allocate the tender amount to an account, the event becomes unbalanced.

FASTPATH:

Refer to [Payment Event Exception](#) for more information about how the system reminds you about unbalanced payment events.

How And When Payments Appear On Bills

FASTPATH:

Refer to [Financial Transactions Created Between Bills](#) for more information.

Tender Management and Workstation Cashiering

When you add a tender, you must identify its **Tender Source**. For example,

- A specific cash drawer ID is the source of tenders remitted to a cashier.
- The notional lockbox ID is the source of tenders interfaced from a lockbox.
- The remittance processor is the source of tenders interfaced from a remittance processor.

NOTE:

Default note. When a user adds a tender control the system attempts to default a tender source based on the currency of the deposit control and the tender source(s) defined on the user's record. If your organization accepts alternate currency payments, then a tender source must exist for each currency code accepted at a location.

FASTPATH:

For more information, refer to [Setting Up Tender Sources](#).

A tender source's tenders must be balanced against an expected total before they can be deposited at a bank. This periodic balancing requires all tenders to exist in respect of a **Tender Control**. Over time, a tender source may have many tender controls (one per balancing event).

An example of a cashier's cash drawer will help clarify the tender control concept:

- When a cashier starts in the morning, s/he starts with a fresh cash drawer (i.e., one without tenders). Whenever a drawer starts afresh, a new Tender Control must be created because you balance the contents of a drawer.
- A cash drawer typically contains funds to make change. These funds are the tender control's **Opening Balance**.

NOTE:

Default note. A tender control's starting balance defaults from its tender source.

- During the day, customers remit tenders to the cashier. Every tender put into the drawer is associated with the drawer's tender control created at the start of the day.
- A tender control's balance increases during the day as tenders are recorded. A cashier can view the balance at any time.
- The cashier can turn in funds to the head cashier during the day. Each turn in event can be recorded in the system. Note well, if the amount of funds in a tender control exceeds the maximum balance defined on the tender control's tender source, a warning is issued to the cashier to remind him/her to turn in funds.

- At some point, the contents of the drawer must be balanced against the total tenders linked to the tender control. When balancing starts, no additional tenders may be put into the tender control. If the cashier receives additional tenders after balancing starts, a new tender control must be created (and the above process starts afresh).
- During the balancing process, some modifications may be made to the tenders associated with the tender control, but no additional tenders may be added. When the tender control is balanced, neither it nor its tenders may be modified.

FASTPATH:

For more information, refer to [Managing Your Cash Drawers](#).

While the above explanation is true, it isn't complete. In addition to the requirement that a tender must reference a tender control, the tender control must refer to a **Deposit Control**. Deposit controls give you administrative control over all of the tender controls whose contents will be deposited en masse. The following concepts will help explain the power of deposit controls:

- As explained above, when a cash drawer is started afresh, a new tender control must be created. The tender control "holds" all new tenders received by the cashier.
- Similarly, when a tender control is created, it must reference a deposit control. During the day, a deposit control's tender controls are constantly changing. You can view the total impact of a deposit control's tender controls at any time.
- At some point, you will want to deposit the tenders received during the day. To do this, you must indicate how much will be deposited at the bank. This deposit amount must equal the sum of the tender controls linked to the cash drawer. When this deposit balancing starts, no additional tender controls may be associated with the deposit control.
- When the deposit total equals the sum of the tender controls, the deposit control becomes balanced and no changes may be made to it, its tender controls, or its tender controls' tenders.

FASTPATH:

For more information, refer to [Managing Your Cash Drawers](#).

NOTE:

Background processes use the same concepts. Tenders that are interfaced from external sources (e.g., lockboxes and remittance processors) make use of the concepts describe above. For example, tenders interfaced from a remittance processor are linked to a tender control and this tender control is linked to a deposit control. The main difference is that the background processes require no human intervention; the system automatically creates tender and deposit controls and sets their states to balanced when the interface concludes successfully.

The ACH activation process also creates tender and deposit controls. Refer to [Activating Automatic Payments](#) for more information.

The topics in this section elaborate on the tender management concepts described above.

Managing Your Cash Drawers

WARNING:

This section assumes you are familiar with the concepts described in [The Lifecycle Of A Deposit Control](#) and [The Lifecycle Of A Tender Control](#).

There are many ways to handle the daily management of tenders received via cash drawers. It really depends on how your organization works. To help you understand the potential of the system, we'll continue the example started above.

Assume that the cash drawers in your western office are balanced and deposited independently from those in your eastern office. We'll assume that both offices follows the same daily routine:

- Load fresh drawers first thing in the morning. Each drawer contains a starting balance of \$150.00. Note: the drawer's tender control's starting balance defaults from its tender source.
- At 10 am, the cashier turns in funds to the chief cashier and continues to receive additional tenders.
- At 12 noon, each drawer is pulled and balanced by a supervisor.
- By 12:30 pm, the tender controls are balanced.
- At 4 pm, the cashiering stations are closed. Each drawer is pulled and balanced by a supervisor.
- By 4:30 pm, the tender controls are balanced.
- At 5 pm, the deposit control is balanced and funds are ready to be deposited at the bank.

Given this, the following diagram illustrates the deposit controls and tender controls used by each office on a given day.

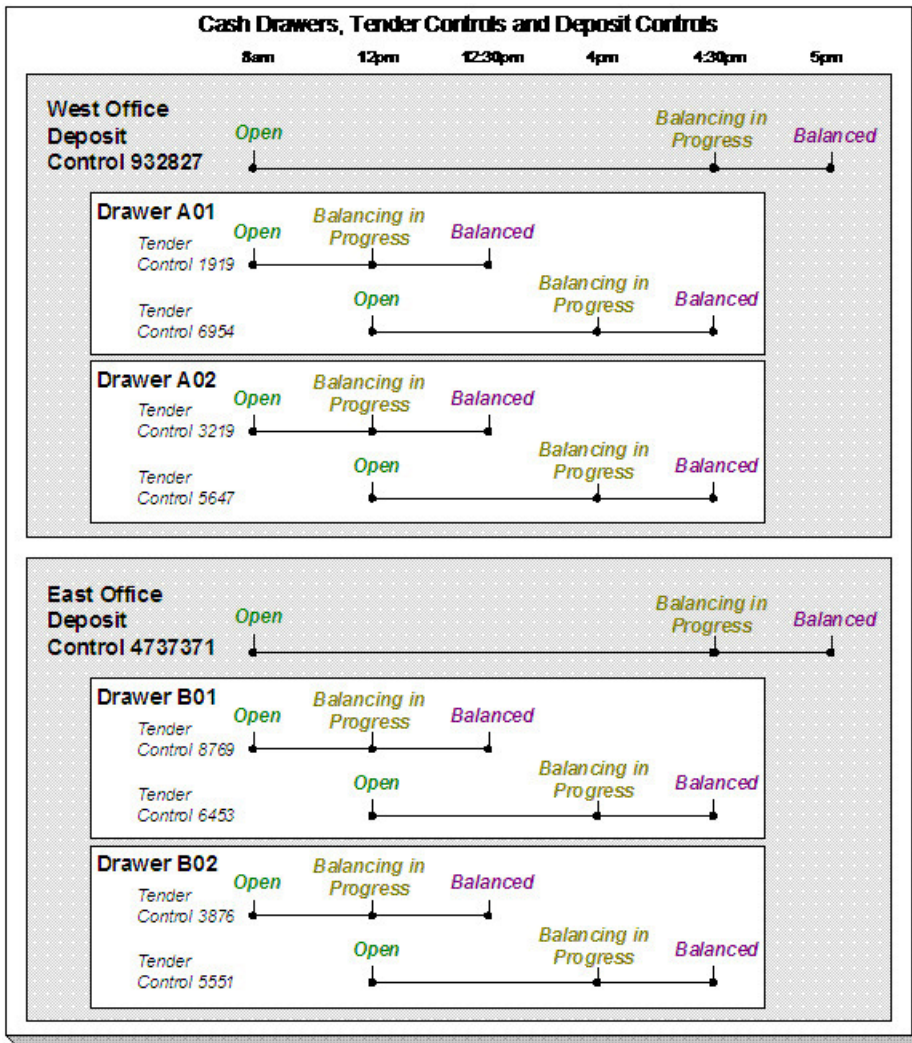

The following concepts are illustrated above:

- An Open deposit control must exist before you can create a tender control. And an Open tender control must exist before you can create a tender. From a business process standpoint, this means:
 - A supervisor would create a deposit control at the start of the day (8 am in the above illustration).
 - Each cashier would create a tender control when they start a drawer and reference the deposit control created by the supervisor.

- During the day, the cashier can turn-in moneys to the chief cashier. These turn-in events are recorded in the system as they play a part in the ultimate balancing of the drawer. Refer to [Turn Ins](#) for more information.
- At some point, the contents of a drawer can be pulled and balanced. If additional tenders can be received in a drawer, a new tender control must be created for the drawer. Refer to [Balancing By Tender Type](#) for more information.
- At the end of the day, the supervisor checks to make certain that all tender controls linked to the deposit control are Balanced. After this has been done, the supervisor indicates the deposit amount on the deposit control and changes it to Balanced. Notice that in the above illustration each deposit control references four tender controls.

NOTE:

Alternate currency payments. If your organization accepts payments in alternate currencies, that is, a currency other than the account's currency; a supervisor would create a deposit control for each such currency. Likewise, the cashier would create a tender control for each such currency.

FASTPATH:

Refer to [Alternate Currency Payments](#) for more information.

- Typically, a cash drawer has one tender control Open at any point in time (meaning that the tenders being received are being linked to a specific tender control). However, this is not a hard rule. If you want, you may have multiple tender controls Open at any point for a specific cash drawer (for example, if multiple cashiers can work the same drawer during the day but take their drawer with them).
- Typically, a specific cashier puts tenders into a specific tender control. However, this is not a hard rule. On a tender control, you can define if it's limited to a specific operator OR if any operator can link tenders to it.
- When you're ready to balance a drawer, you change the tender control to Balancing in Progress. This prevents new tenders from being added to the tender control. If the cashier can continue to receive tenders, s/he must create another tender control. In the above example, all drawers are balanced at 12 noon by a supervisor while the cashier continues to take payments.
- When the tender control is balanced, you change its state to Balanced. This prevents any changes to the tender control or its tenders.
- All tender controls exist in respect of a deposit control (in fact, the deposit control must be created before the tender control). This way, a supervisor can check the state of the related drawers throughout the day. Notice that the state transition of a deposit control is identical to that of the tender control (refer to [The Lifecycle Of A Deposit Control](#) and [The Lifecycle Of A Tender Control](#)). There is only a temporal difference. Notice that the deposit control stays open throughout the day while any number of tender controls are being opened and balanced.

NOTE:

Multiple deposits in a day. While the above example illustrates a single deposit per office per day, it is quite possible to have multiple deposit controls on any given day.

Turns ins. The above example did not illustrate the fact that a cashier can turn-in moneys during the day without having to balance the drawer. Refer to [Turn Ins](#) for more information.

Turn Ins

A cashier may optionally turn-in funds received into a cash drawer to a head cashier. The turn-in process requires two steps:

- Each time a cashier turns-in funds, they add a turn-in event on the [Tender Control - Turn Ins](#) page. Note that a separate turn-in event is required for each type of tender that's turned in. This is because the balancing of a tender control is performed for each tender type and therefore the system must know how much of each tender type has been removed from the drawer.

NOTE:

Turn in warning. If the amount of cash-like funds in a tender control exceeds the maximum balance defined on the tender control's tender source, a warning is issued to the cashier to remind him/her to turn in funds.

- The head cashier (the person responsible for the deposit control associated with the various tender controls) approves the turn in using the [Deposit Control - Turn Ins](#) page.
-

NOTE:

All turn-ins must be approved for balancing to complete. A tender control cannot be balanced until the head cashier has approved all turn-in events.

Balancing By Tender Type

It should be noted that when it's time to balance a tender control, the cashier must enter the amount of each tender type that is in the drawer in order to balance it. For example, assume the following takes place:

- A drawer is opened with a starting balance of \$150.50 (tender type is Cash).
- During the day, the cashier receives \$5,000 in Cash, and \$1,000 in Checks.
- During the day, the cashier turns in \$750 of the Checks and \$4,000 of Cash.

At the end of the day, the following operator would have to enter the balances shown in the Ending Balance column.

Tender Type	Starting Balance	Tenders Received	Turn Ins	Ending Balance
Cash	\$150.50	\$5,000	\$4,000	\$1150.50
Check	-	\$1,000	\$750	\$250

NOTE:

Time saver. The system assists in the balancing effort by amalgamating the amount of tenders by tender type when the tender control's status is changed from Open to Balancing In Progress. The cashier just needs to enter the Ending Balance. The system can then compare the cashier's Ending Balance against the Expected Ending Balance. When these values are equal for all tender types, the tender control's status can become Balanced.

Cash Back

When a [payment is added](#), the user defines the following:

- The amount of debt to be relieved (i.e., the payment amount)
- The amount remitted (i.e., the tender amount)
- The form of the remittance (i.e., the [tender type](#))

The payment amount typically equals the tender amount unless cash will be returned to the customer. For example, if a customer remits \$100, but only wants to pay off \$25 of debt, the tender amount will be \$100 and the payment amount will be \$25. The system will only allow a user to remit more than the payment amount if the tender type indicates "cash back" is allowed. For example, you may not allow cash to be returned if a check is remitted, but you may allow it to be returned if cash is remitted.

If cash back is allowed for the tender type, the system displays the amount of cash to be returned on the [Payment Event](#). In addition, because the system enforces [balancing the cash drawer by tender type](#), the system adjusts the payment event's tendered information as follows:

- When there is cash back, the payment event will have two tenders - one will be for the amount and type entered by the user, the other will be a negative amount with a tender type of cash (note, this tender type is retrieved from the Starting Balance Tender Type on the [installation record](#)). For example, if a customer remits \$100 in traveler's checks, but only wants to pay off \$25 of debt, there will be two tenders: one for the \$100 travelers check and the other for the -\$25 of cash.

NOTE:

Alternate currency payments. If your organization accepts payments in alternate currencies, that is, a currency other than the account's currency; the cash back tender is always created in the account's currency.

NOTE:

Multiple tenders and payment cancellation. If multiple tenders were created because of "cash back" processing, both tenders must be cancelled if the payment event needs to be cancelled.

When modifying an unfrozen payment on the [Payment Event](#), if the payment becomes unbalanced, a button is displayed allowing the user to **Recalculate Cash Back**. If the user clicks this button, the system reassesses the cash back tender as follows:

- If there is now cash back, a new tender is created for the credit amount
- If the cash back amount has changed, the tender for the cash back is adjusted to the new amount
- If there is no longer cash back due, the tender for the cash back is removed.

Managing Payments Interfaced From External Sources

Just like a payment recorded on-line via a cash drawer, a payment interfaced from an external source (e.g., lock box or remittance processor) must reference a tender control and the tender controls, in turn, must reference a deposit control. The only real differences between these two types of payments are highlighted below:

- Whilst an operator must create and balance the tender and deposit controls for real-time payments, the system creates the tender and deposit controls associated with interfaced payments.
- It's impossible for an invalid account to be referenced on a payment recorded real-time. However, it is quite possible for an interfaced payment to reference an unknown account. If an invalid account is referenced on an interfaced payment (using no distribution rules), the system links it to the suspense service agreement referenced on the tender source control table.

FASTPATH:

Refer to [Interfacing Payments From External Sources](#) for more information.

Payment Financial Transaction Considerations

A payment segment exists for each service agreement that receives a portion of a payment. Linked to every frozen payment segment is a financial transaction. This financial transaction affects a service agreement's payoff balance and/or current balance. It also contains the journal details that debit cash and credit some other account.

The topics in this section provide information about the financial impact of a payment segment.

FASTPATH:

Refer to [The Financial Big Picture](#) for more information about a payment's place in the financial big picture.

Payment - Current Balance versus Payoff Balance

WARNING:

If you do not understand the difference between payoff balance and current balance, refer to [Current Amount versus Payoff Amount](#).

A payment segment financial transaction almost always affects payoff balance and current balance by the same amount (think of it like this - when a customer pays, the amount they think they owe goes down by the amount they really owe). The only exception is a payment segment for a charitable contribution. These payment segments only affect current balance because the customer was never billed for the contribution in the first place.

FASTPATH:

Refer to [Setting Up Payment Segment Types](#) for more information about how payment segment type affects how a payment segment is produced and how its financial transaction is generated.

The Source Of GL Accounts On A Payment Financial Transaction

A payment segment's financial transaction also contains the double-sided accounting entry that defines how the payment segment affects the general ledger.

FASTPATH:

Refer to [The Source Of GL Accounts On Financial Transactions](#) for a description of where the system extracts the distribution codes used to construct the GL accounts.

A Payment May Affect More Than Just Customer Balances

The topics in this section provide information about obscure things that may happen when a payment is distributed and frozen.

Open Item Accounting and Match Events

FASTPATH:

Refer to [Payments and Match Events](#) for more information about how payments can create match events for open-item accounts.

FT Freeze Repercussions

FASTPATH:

Refer to [Obscure Things That Can Happen](#) for more information about things that can happen when an FT is frozen (and FT's get frozen when a payment is frozen).

Automatic Payments

This section discusses how to set up and manage customers who pay their bills automatically (via direct debit or credit card debits)

How To Set Up A Customer To Pay Automatically

If a customer wants to pay automatically, transfer to [Account - Auto Pay](#) and define the source of the funds and the customer's account or credit card number.

What Are Automatic Payments?

An automatic payment is just like any other payment (refer to [A Payment Event Has Payments And Tenders](#) for more information about payments in general). However, automatic payments have one special trait - they cause funds to be transferred into your company's bank account. Refer to [Downloading Automatic Payments and Interfacing Them To The GL](#) for how this transference happens.

How And When Are Automatic Payments Created?

Automatic payments can be created in several ways:

- The system creates automatic payments for bills linked to accounts with an active auto pay option (note, the system uses the [account's autopay option](#) that's effective on the bill's due date). When the system does this is dependent on the value of the **Autopay Creation Option** on the [installation record](#):
 - If you've set this option to Create At Bill Completion, the automatic payment is created when the account's bill is completed. The payment is distributed and frozen at the same time. This means that the account's balance is almost always zero (or in credit if they have a deposit). You will see the automatic payments in the payment list immediately after the bill is completed (rather than waiting until the automatic payment's extraction date).
 - If you've set this option to Create On Extract Date, the automatic payment is NOT created when the bill is completed. Rather,
- At bill completion time, the bill is stamped with the automatic payment's extract date and amount. The date is the automatic payment source's extraction date (refer to [Automatic Payment Dates](#) for more information on how this date is calculated).
- The automatic payment background process ([APAYCRET](#)) creates the automatic payment on the extract date stamped on the bill. If the supplied Auto Pay Creation algorithm (APAY-CREATE) is used and is configured to override the automatic payment amount based on the account's current balance, the algorithm can either adjust the auto pay amount (if the balance is less than the original auto pay amount) or skip automatic payment creation (if the balance is zero or a credit). Refer to the algorithm type description for more details.
- The automatic payment is NOT distributed and frozen when the automatic payment is initially created. A separate background process ([APAYDSFR](#)) distributes and freezes the automatic payment on the automatic payment GL

distribution date (refer to [Automatic Payment Dates](#) for more information on how this date is calculated). This means that the customer's balance increases when the bill is completed and is only reduced when the automatic payment is marked for interface to the general ledger.

Note that it is possible for automatic payments to be distributed and frozen after being extracted and interfaced to a financial institution. Please refer to [Downloading Automatic Payments and Interfacing Them To The GL](#) and [The Nightly Processes](#).

An algorithm plugged in on the [Installation Record](#) calculates the payment amount whether the automatic payment is created at bill completion time or on the extract date. Please refer to APAM-DFLT for more information about how the algorithm that is supplied with the base package calculates this amount.

NOTE:

With balance forward accounting, automatic payments are not just for new charges. The base package algorithm includes prior balances when it creates a customer's first automatic payment. For example, if a customer has an existing balance of \$100 and then signs up for automatic payment, their next bill will cause an automatic payment of \$100 plus any new charges to be created (assuming the \$100 remains unpaid at the time the next bill is completed). Refer to [Open Item Versus Balance Forward Accounting](#) for information about balance forward accounting.

-
- If a customer with a pay plan indicates that the payment method is via "autopay", a background process ([PPAPAY](#)) creates an automatic payment on the scheduled payment dates. Please note, if the **Autopay Creation Option** on the [installation record](#) is set to Create On Extract Date, the automatic payment is NOT distributed and frozen when the automatic payment is initially created. Rather, a separate background process ([APAYDSFR](#)) distributes and freezes the automatic payment on the automatic payment GL distribution date (refer to [Automatic Payment Dates](#) for more information on how this date is calculated). Refer to [The Big Picture Of Pay Plans](#) for more information about pay plans.
 - If a customer with an account that is set up for automatic payment has a Non-Billed Budget that is not excluded from automatic payment, a background process ([NBBAPAY](#)) creates an automatic payment on the scheduled payment dates. Please note, if the **Autopay Creation Option** on the [installation record](#) is set to Create On Extract Date, the automatic payment is NOT distributed and frozen when the automatic payment is initially created. Rather, a separate background process ([APAYDSFR](#)) distributes and freezes the automatic payment on the automatic payment GL distribution date (refer to [Automatic Payment Dates](#) for more information on how this date is calculated). Refer to [What is a Non-Billed Budget](#) for more information about Non-Billed Budgets.
 - A user can create an automatic payment by simply adding a payment tender with a tender type that indicates it is for automatic payment purposes. This would be a rather unusual thing to do, but you might do this if you want to immediately debit a customer's bank account after a large adjustment is added to the system (e.g., if they suddenly owe you a lot of money and you don't want to wait until the next bill to collect it). Automatic payments created by this method must be distributed and frozen before they can be extracted.

NOTE:

An algorithm is used to create automatic payments. The logic used to create automatic payments is plugged in on the [Installation Record](#). This algorithm is **not** called when a user manually creates an automatic payment (by adding a payment tender with a tender type that indicates that it is for automatic payment purposes).

When an automatic payment is first created, it gets marked with a distribution date. The distribution date is the date on which the automatic payment's FT's GL details can be interfaced to the general ledger (via the standard GL interface). The distribution date is determined as follows:

- Every automatic payment references an auto-pay source.
- Every auto-pay source references an auto-pay route type.
- Every auto-pay route type contains an algorithm that is responsible for calculating the GL Distribution (Posting) date. On the GL distribution date, the automatic payment will be interfaced to the general ledger.

Automatic Payment Dates

As described in the previous section, an algorithm (that's plugged in on [Auto Pay Route Types](#)) controls the date on which the automatic payment is interfaced to your general ledger. We refer to this date as the GL distribution date.

This algorithm also populates the following dates:

- The payment date that is stored on the payment.
- The date on which the automatic payment is interfaced to the financial institution.

The algorithm that is supplied with the base package provides many parameters that allow you to dictate how these dates are calculated. Please refer to APAY-DTCALC for the details.

How To Implement Maximum Withdrawal Limits

In some locales, customers can define a "maximum withdrawal amount" to limit the amount of money that is automatically debited from their bank account. For example, a low-income customer may want to prevent direct debits of more than \$50 from being applied to their checking account.

You define a customer's maximum withdrawal amount when you setup their automatic payment information on [Account - Auto Pay](#).

The following points describe how the system implements maximum withdrawal limits:

- When a bill is completed for a customer who pays automatically the system calls the automatic payment creation algorithm that's plugged in on the [Installation Record](#). The base-package autopay creation algorithm (APAY-CREATE) checks if the amount of the automatic payment exceeds the customer's maximum withdrawal amount. If so, the autopay creation algorithm calls the automatic payment over limit algorithm that's plugged in on the account's [customer class](#). Algorithms of this type have the ability to reduce the amount of the autopay or to prevent the autopay from being created. Refer to APOL-RA for an example plug-in.
- When a user manually creates an automatic payment (by adding a tender with a tender type that indicates that it is for automatic payment purposes), the system issues a warning message when the tender amount exceeds the account's maximum withdrawal amount.

NOTE:

Pay plans and Non-Billed Budgets. Automatic payments that are created as a result of pay plans and Non-Billed Budgets are not subject to maximum withdrawal limits. This is because both of these options required customer approval and therefore the customer should be able to plan accordingly. Refer to [How And When Are Automatic Payments Created](#) for more information.

How Are Automatic Payments Cancelled?

There are two ways to cancel an automatic payment:

- The system will cancel an automatic payment behind-the-scenes if the related bill (if any) is reopened BEFORE the automatic payment is interfaced to the financial institution. When you recomplete the bill, the system will create a new automatic payment that reflects the new amount due (and the canceled automatic payment will net out the original automatic payment).
- An operator can cancel an automatic payment (refer to [How To Cancel A Tender](#)) at any time. You would do this if the automatic payment was rejected by the financial institution.

FASTPATH:

Refer to [Credit / Correction Notes and Auto Pay](#) for information about how a credit note may cancel an automatic payment.

Match Events Are Created For Open-Item Customers When An Automatic Payment Is Created

The system creates a match event when a bill is completed for open-item customers that pay automatically (i.e., direct debit customers). The match event groups together the bill's new charges against the automatic payment's payment segments.

If the bill is subsequently re-opened, the match event will be cancelled when the automatic payment is cancelled.

FASTPATH:

Refer to [Open Item Accounting](#) for more information.

Pay Plans and Automatic Payments

If a customer wants to pay their pay plan scheduled payments automatically, the account must be set up for automatic payment (as described under [How To Set Up A Customer To Pay Automatically](#)). In addition, the payment method defined on the pay plan must indicate automatic payment is being used.

When this is done, a background process (PPAPAY) creates automatic payments on the scheduled payment date by calling the automatic payment creation algorithm plugged in on the installation record.

Non-Billed Budgets and Automatic Payment

If a customer wants to pay their Non-Billed Budget scheduled payments automatically, the account must be set up for automatic payment (as described under [How To Set Up A Customer To Pay Automatically](#)). In addition, the Non-Billed Budget must indicate that automatic payment is being used.

When this is done, a background process (NBBAPAY) creates automatic payments on the scheduled payment date by calling the automatic payment creation algorithm plugged in on the installation record.

Downloading Automatic Payments and Interfacing Them To The GL

The following diagram illustrates the background processes that interface automatic payment out of the system:

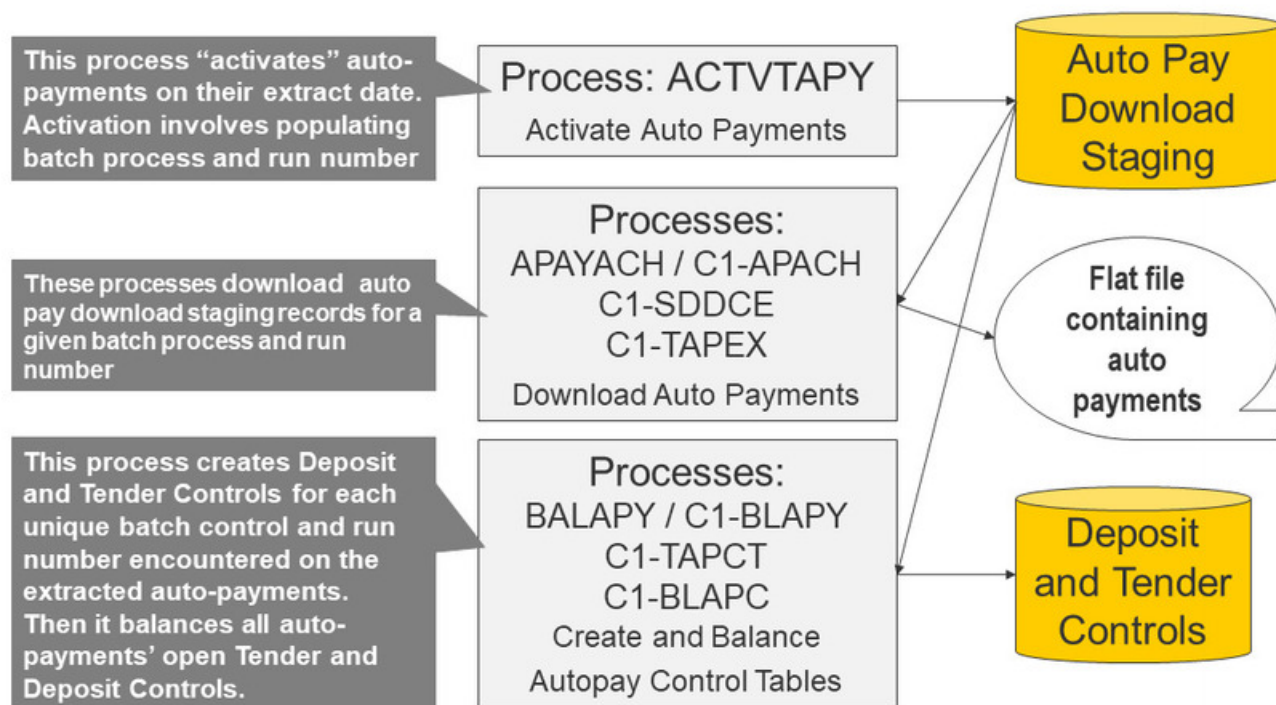

These processes are described in the following topics.

ACTVTAPY - Activating Automatic Payments

When an automatic payment is first created, it gets marked with an extract date. The extract date is the date the automatic payment will be downloaded to the respective financial institution. The extract date is determined as follows:

- Every automatic payment references an auto-pay source.
- Every auto-pay source references an auto-pay route type.
- Every auto-pay route type contains an algorithm that calculates this date.

On the extract date, the automatic payment is "activated". The automatic payment is activated is marked for download the next time its download process runs. An automatic payment's download process is defined on its auto-pay source's route type.

APAYACH - Download Automatic Payments To The ACH (Automated Clearing House)

This process reads all auto pay download staging records marked with a given batch control ID and run number, and creates the flat file that's passed to the ACH. Refer to [ACH Record Layouts](#) for the details of the record layouts.

The following outlines the differences between APAYACH and C1-APACH:

- APAYACH uses the Business Process Date as the draft date. C1-APACH populates the Effective Entry Date field on the Company Batch Header Record with a date (the actual draft date) as to when the payment should be withdrawn from the customer's account.

- APAYACH produces a file that has one File Header Record, a Company Batch Header Record per payment source (if multiple payment sources exist), and multiple detail lines. C1-APACH produces a file with multiple occurrences of the Company Batch Header Record differing on the Effective Entry Date field and the payment source (if multiple payment sources exist).

NOTE:

This process may be rerun. You can reproduce the flat file at any time. Simply request this job and specify the run number associated with the historic run.

If you require a different flat file format, you must create additional versions of this program. Refer to [Setting Up Automatic Payment Extracts](#) for instructions describing how to add another process.

C1-APACH - Download Automatic Payments To The ACH (Automated Clearing House)

This process is an alternative to using APAYACH. Similar to APAYACH, this process reads all auto pay download staging records marked with a given batch control ID and run number, and creates the flat file that's passed to the ACH. Refer to [ACH Record Layouts](#) for the details of the record layouts.

The following outlines the differences between APAYACH and C1-APACH:

- C1-APACH populates the Effective Entry Date field on the Company Batch Header Record with a date (the actual draft date) as to when the payment should be withdrawn from the customer's account. APAYACH uses the Business Process Date as the draft date.
- C1-APACH produces a file with multiple occurrences of the Company Batch Header Record differing on the Effective Entry Date field and payment source (if multiples payment sources exist). APAYACH produces a file that has one File Header Record, a Company Batch Header Record per payment source (if multiple payment sources exist), and multiple detail lines.

NOTE:

This process may be rerun. You can reproduce the flat file at any time. Request this job and specify the run number associated with the historic run.

If you require a different flat file format, you must create additional versions of this program. Refer to [Setting Up Automatic Payment Extracts](#) for instructions describing how to add another process.

C1-SDDCE - SEPA Direct Debit Payment Extract

This process reads all auto pay download staging records marked with a given batch control ID and run number to create an XML extract file that's passed to the financial institution. Refer to [SEPA Direct Debit Record Layouts](#) for the details of the record layouts.

NOTE:

This process may be rerun. You can reproduce the XML extract at any time. Simply request this job and specify the run number associated with the historic run.

C1-TAPEX - Third Party Auto Pay Extract

This process reads all auto pay download staging records marked with a given batch control ID and run number to create an extract file that is sent to the third party payment processing system.

This is a plugin-driven batch process that supports any of three file layouts (comma-separated values (CSV), fixed position and XML) specified in an input batch parameter.

The C1-TAPEX batch control is delivered with two algorithms plugged in:

- A Select Records algorithm is responsible for selecting the auto pay staging records to download.
- A Process Record algorithm is responsible for formatting and writing each extract record into the output flat file.

Your implementation can plug in your own Select Records and Process Record algorithms if your business rules for this extract differ.

This batch process is meant to be run after the Activate auto-pay (ACTVTAPY) runs and before Third Party Auto Pay Tender Controls (C1-TAPCT) runs.

Refer to [Third Party Auto Pay Record Layouts](#) for the details of the record layouts.

NOTE:

This process may be rerun. You can reproduce the XML extract at any time. Simply request this job and specify the run number associated with the historic run.

BALAPY - Creating Automatic Payment Tender Controls

This process creates a new tender control (with an associated deposit control) for each unique batch control ID and run number encountered in the extracted automatic payments (where its payment tender is not yet linked to a tender control). The payment tender of each of these automatic payments is then linked to the corresponding tender control. This process also balances the open tender control records afterwards.

NOTE: A separate batch process ([C1-BLAPC](#)) must be scheduled after BALAPY to balance open tender and deposit control records.

C1-BLAPY - Create Autopay Tender Controls

This process creates a new tender control (with an associated deposit control) for each unique batch control ID and run number encountered in the extracted automatic payments (where its payment tender is not yet linked to a tender control).

This is a plugin driven version of BALAPY. The difference is that it excludes payments that were processed by a third party payment processing system. These are handled by other tender controls processes - C1-TAPCT (for third party auto pays) and C1-TOPCT (for third party one time payments)

The C1-BLAPY batch control is delivered with two algorithms plugged in:

- A Select Records algorithm is responsible for determining the auto pay staging records to process.
- A Process Record algorithm is responsible for linking the auto pay record's payment tender to the tender control.

Your implementation can plug in your own Select Records and Process Record algorithms if your business rules for this extract differ.

NOTE: A separate batch process ([C1-BLAPC](#)) must be scheduled after C1-BLAPY to balance open tender and deposit control records.

C1-BLAPC - Balance Autopay Control Tables

This batch process is responsible for balancing tender and deposit control tables in the autopay extract process. This batch process is executed after [BALAPY](#) completes.

ACH Record Layouts

The topics in this section describe the layout of the records created by [APAYACH - Download Automatic Payments To The ACH \(automated clearing house\)](#) and [C1-APACH - Download Automatic Payments To The ACH \(automated clearing house\)](#).

NOTE:

APAYACH and C1-APACH share most of the same fields. The exceptions are documented in the following tables.

File Header Record

The ACH extract flat file must have one record of this type and it must be the first logical record on file.

Field Name	Format	Source/Value/Description
RECORD-TYPE	A1	"1"
PRIORITY-CD	A2	"01"
RESERVED-01	A1	Spaces
IMMEDIATE-DESTINATION	A9	The auto pay route type's tender source's bank account's DFI ID. Note. Tender source may be overridden on CIS Division
COMPANY-ID	A10	Auto Pay Route Type / Company Id Note. May be overridden on CIS Division
FILE-CRE-DT	A6	YYMMDD. Current date
FILE-CRE-TM	A4	HHMM. Current time
FILE-ID-MODIFIER	A1	"A"
RECORD-SIZE-CONST	N3	"094" The "FILLER" at the end of all but the Entry Detail Record serves to bring the total length of each record up to this constant.
BLOCKING-FACTOR	N2	"10"
FORMAT-CD	A1	"1"
DEST-FIN-INST-NAME	A23	The auto pay route type's tender source's bank description. Note. Tender source may be overridden on CIS Division
COMPANY-NAME (ORIG-FIN-INST-NAME)	A23	Auto Pay Route Type / Company Name Note. May be overridden on CIS Division
REFERENCE-CD	A8	Spaces

Company Batch Header Record

The ACH extract flat file can contain multiple company batch headers - one header per payment source as distinguished by STD-ENTRY-CLASS. This record must be the second logical record on file.

Field Name	Format	Source/Value/Description
RECORD-TYPE	A1	"5"
SERVICE-CLASS-CD	A3	"200"
COMPANY-NAME	A16	Auto Pay Route Type / Company Name Note. May be overridden on CIS Division
COMPANY-DISCRETIONARY	A20	Spaces
COMPANY-ID	A10	Auto Pay Route Type / Company Id Note. May be overridden on CIS Division
STD-ENTRY-CLASS	A3	"PPD", unless the payment is a one-time payment. For one-time payments, the STD-ENTRY-CLASS can be populated using a One Time Payment Source characteristic on the associated tender. Base logic for self-service one-time payment processing adds a One Time Payment Source characteristic with a value of 'WEB' to the tender. Your implementation may define other characteristic values for any of your additional payment sources/triggers. Refer to the help for the One Time Payment Sources section of the Self-Service Integration Master Configuration for more details.
CO-ENTRY-DESCR	A10	For standard Auto Pay Route Type: Company Entity Description Note. May be overridden on CIS Division
COMPANY-DESCR-DT	A6	Business process date
EFF-ENTRY-DT	A6	For APAYACH, the EFF-ENTRY-DT is the business process date. For C1-APACH, the EFF-ENTRY-DT is calculated from the ACH staging / Scheduled Extract Date + Number of Days batch parameter if specified greater than 0. A company batch is created for each value.
RESERVED-01	A3	Spaces
ORIGINATOR-STAT-CD	A1	"1"
ORIGIN-DFI-ID	A8	The auto pay route type's tender source's bank account's DFI ID. Note. Tender source may be overridden on CIS Division

Entry Detail Record

The ACH extract flat file must have one record of this type for every direct debit record.

Field Name	Format	Source/Value/Description
RECORD-TYPE	A1	"6"
TRANSACTION-CD	A2	Pay Tender's Tender Type / External Type Flag
TRANSIT-RTG-NBR	A9	Auto pay source / External Source Id
DFI-ACCT-NBR	A17	Auto pay staging / External Account Id
AMOUNT	N8.2	Pay Tender / Tender Amount
INDIVIDUAL-ID	A15	Pay Tender / Payor Account Id
INDIVIDUAL-NAME	A22	Auto pay staging / Entity Name
DISCRETIONARY-DATA	A2	Spaces
ADDENDA-REC-IND	A1	"0"
DFI-ID	A8	The auto pay route type's tender source's bank account's DFI ID. Note. Tender source may be overridden on CIS Division
ENTRY-DETAIL-CNT	N7	Ascending counter starting at 1 and incremented by 1 for each entry detail record

NOTE:

External Account ID. The EXT_ACCT_ID field supports up to 50 characters. If the value entered in the field is longer than that supported by the record layout (17 characters), the value will be truncated.

Company Batch Control Record

The ACH extract flat file must have one record of this type and it must follow the Entry Detail records.

Field Name	Format	Source/Value/Description
RECORD-TYPE	A1	"8"
SERVICE-CLASS-CD	A3	"200"
ENTRY-ADDENDA-CNT	N6	The total number of entry detail records in this batch.
ENTRY-HASH	N10	The product of the first 8 digits of the external source id of the autopay source, multiplied by the number of entry detail records in the batch.

TOTAL-DR-DOLLAR-AMT	N10.2	Total tender amounts of the entry detail records.
TOTAL-CR-DOLLAR-AMT	N10.2	Zero.
COMPANY-ID	A10	Auto Pay Route Type / Company Id Note. May be overridden on CIS Division
RESERVED-01	A19	Spaces
RESERVED-02	A6	Spaces
ORIGIN-DFI-ID	A8	The auto pay route type's tender source's bank account's DFI ID. Note. Tender source may be overridden on CIS Division
BATCH-NBR	N7	The batch number of this batch within the file.

File Control Record

The ACH extract flat file must have one record of this type and it must be the last logical record on file.

Field Name	Format	Source/Value/Description
RECORD-TYPE	A1	"g"
BATCH-CNT	N6	The number of batches in this file.
BLOCK-CNT	N6	Calculation of the total number of records in the file / 10.0 + 0.9
ENTRY-ADDENDA-CNT	N8	The total number of entry detail records in this file.
ENTRY-HASH	N10	The sum of the entry hash values on all the batch control records in this file.
TOTAL-DR-DOLLAR-AMT	N10.2	Sum of the total debit entry dollar amounts of all the batches in this file.
TOTAL-CR-DOLLAR-AMT	N10.2	Sum of the total credit entry dollar amounts of all the batches in this file.
RESERVED-01	A39	Spaces

SEPA Direct Debit Record Layouts

Group Header

A SEPA XML file must include a group header. The XML path for the group header is **CstmrDrctDbtInittn/GrpHdr** and the elements under the group header are as follows:

Description	Element Name	Source/Value
Message Identification	MsgId	Retrieved from the direct debit task type

Creation Date/Time	CreDtTm	Batch business date in the format YYYY-MM-DDThh:mm:ss
Number of Transactions	NbOfTx	Calculated at extract time
Initiating Party Name	InitgPty/Nm	Retrieved from the direct debit task type

Payment Information

Payment Information contains elements related to the credit side of the transaction, such as creditor and payment type. The XML path for payment information is **CstmrDrctDbtInitt/PmtInf** and the elements are as follows:

Description	Element Name	Source/Value
Payment Information Identification	PmtInfId	Constructed at extract time by concatenating the following: Batch Code, Batch Run Number, Batch Business Date and a Sequence Number assigned to each Payment
Payment Method	PmtTpInf/PmtMtd	Defaulted to DD (Direct Debit)
Service Level Code	SvcLvl/Cd	Retrieved from the direct debit task type; defaulted to 'SEPA'
Local Instrument Code	PmtTpInf/LclInstrm/Cd	Retrieved from the direct debit task type; defaulted to 'CORE'
Sequence Type	PmtTpInf/SeqTp	Direct debit mandate task's Payment Type
Requested Collection Date	ReqdColltnDt	Payment event's pay date
Creditor Name	Cdtr/Nm	Direct debit mandate task's Creditor Name
Creditor Account Identification IBAN	CdtrAcct/Id/IBAN	CI_BANK_ACCOUNT.ACCOUNT_NBR
Creditor Agent Financial Institution Identification BIC	CdtrAgt/FinInstnId/BIC	CI_BANK_ACCOUNT.DFI_ID_NUM
Creditor Account Number	CdtrSchmeld/Id/PrvtId/Othr/Id	Direct debit task type's Creditor Identification
Creditor Party	CdtrSchmeld/Id/PrvtId/Othr/SchmeNm/Prtry	Defaulted to 'SEPA'

Direct Debit Transaction Information

Direct Debit Transaction Information contains elements related to the debit side of the transaction, such as debtor and remittance information rules. The XML path for direct debit transaction information is **CstmrDrctDbtInitt/PmtInf/DrctDbtTxInf** and the elements are as follows:

Description	Element Name	Source/Value
Payment End to End Identification	PmtId/EndToEndId	CI_PAY_TNDR.PAY_TENDER_ID
Payment Instructed Amount	InstdAmt	CI_PAY_TNDR.TENDER_AMT
Mandate Related Information – Mandate Identification	DrctDbtTx/MndtRltdInf/MndtId	Direct debit mandate task's External Mandate Reference
Mandate Related Information – Date of Signature	MndtRltdInf/DtOfSgntr	Direct debit mandate task's Effective Date
Mandate Related Information – Electronic Signature	MndtRltdInf/ElectrcSgntr	Direct debit mandate task's Signature

Debtor Agent Financial Institution Identification BIC	DbtrAgt/FinInstnId/BIC	CI_APAY_SRC.EXT_SOURCE_ID
Debtor Name	Dbtr/Nm	CI_APAY_CLR_STG.ENTITY_NAME
Debtor Account Identification IBAN	DbtrAcct/Id/IBAN	CI_APAY_CLR_STG.EXT_ACCT_ID

Third Party Auto Pay Record Layouts

The Third Party Auto Pay Extract file is a comma-separated (CSV) format file that contains one or more automatic payment detail records and a footer record.

Automatic Payment Detail Record

There must be at least one record of this type in the file.

Field Name	Format	Source/Value/Description
Account ID	A10	Account Auto Pay Option / Account ID
Auto Pay Amount	N13.2	Pay Tender linked to the Auto Pay Clearing Staging / Tender Amount
Due Date	A10	Due Date of the Bill ID that is linked to the Auto Pay Clearing Staging
Maximum Withdrawal Amount	N13.2	Account Auto Pay Option of the related Account ID / Maximum Withdrawal amount field
Auto Pay Staging ID	A12	Auto Pay Clearing Staging / Auto Pay Staging ID

Summary/Footer Record

There must be one record of this type at the end of the file.

Field Name	Format	Source/Value/Description
Total Number of Records	N13.2	Total number of auto pay detail records in the file
Total Amount	N13.2	Sum of auto pay amounts in the file

Payment Information

The Third Party Auto Pay Extract file must have one record of this type for every direct debit record. The **C1-TAPEX-PR** Process Record algorithm uses the **C1-ThirdPartyAutoPayExtractRec** data area, which contains the following:

Description	Element Name	Source/Value
Payor Account ID	payorAccountId	Payor account ID on the auto pay tender
Auto Pay Amount	autopayAmount	Tender amount on the auto pay tender
Due Date	billDueDate	Due date of the Bill ID linked to the auto pay
Maximum Withdrawal Amount	autopayMaxWithdrawalAmount	From the account's auto pay option

Footer Information

The Third Party Auto Pay Extract file must have one and only one record of this type. The **C1-TAPEX-PR** Process Record algorithm uses the **C1-ThirdPartyBatchRunVariables** data area, which contains the following:

Description	Element Name	Source/Value
Record Count	recordCount	Total number of payments in the file
Total Amount	totalAmount	Total amount of payments in the file

Third Party Payment Processing

A third party payment processing system is a service provider that can handle all aspects of electronic payments for a utility. When this service provider is integrated with , every payment made through channels such as web self-service or integrated voice response (IVR) is accepted and processed within the service provider's fully hosted payment acceptance environment. Payment data (credit card number, bank account number, etc) is stored and processed outside of the utility's network.

The following sections describe the functions that are supported when this product is integrated with a third party payment processing system.

One Time Payments

A one time payment is a one-off, non-recurring payment option where the third party payment processing is authorized to collect a payment from a utility customer's credit card or bank account.

One time payments can be immediate or scheduled:

- Immediate one-time payments are processed on the same date that the payment is created/captured in the third party payment processing system.
- Scheduled one-time payments are processed at a future date that the customer designates.

The base product provides an inbound web service **C1-ThirdPartyOneTimePayNotification** that receives one time payment information from the third party payment processor, and, based on the required action, creates/updates the payment in the system. This web service supports the following functions:

- Creating an immediate or scheduled one time payment.
- Updating a scheduled one time payment
- Processing a scheduled one time payment
- Canceling a processed one time payment

The following sections describe these actions.

Creating One Time Payments

When the third party payment processing system processes a new one time payment, it will call the **C1-ThirdPartyOneTimePayNotification** inbound web service with an Add action. The payment details include the payment date/time, payment amount and basic details about the payment method (*i.e.*, bank account or credit card).

NOTE: Because bank account numbers and credit card numbers are captured outside of the system, the full account numbers are not sent. In most cases, only a partial value is sent, e.g. last four digits.

The inbound web service processes the payment as follows:

- If the Payment Date is the current date, it is processed as an immediate payment.
 - The system creates a Third Party One Time Payment Task, which in turn creates a frozen payment.
 - The payment date/time sent in by the third party payment processor is stored as a characteristic on the payment tender using the Processing Date/Time Characteristic Type in the Third Party One Time Payment Processing Integration master configuration. This is to capture the actual date/time when the payment was processed. This information is used in tender control processing.
 - A reference to the Third Party One Time Payment Task's Service Task ID is stored as a characteristic on the payment tender using the Processing Reference Characteristic Type in the Third Party One Time Payment Processing Integration master configuration. This helps identify that the payment event/tender was created from third party payment processing.
 - The Payment Event ID is sent back to the third party payment processing system so that it has a way to identify the payment should there be a need to cancel the payment in the future.
- If the Payment Date is a future date, it is processed as a scheduled payment.
 - The system creates a pending Third Party One Time Payment Task. No further action is taken until the third party payment processing system sends another notification that the scheduled payment has been processed.
 - The Service Task ID is sent back to the third party payment processing system so that it has a way to identify the service task on subsequent requests to either update or process the pending one time payment.

For more information about the lifecycle of the Third Party One Time Payment Notification service task, refer to the **C1-ThirdPartyOneTimePayTask** business object in the system.

For more information about master configuration settings, refer to the **Third Party Payment Processing Integration** master configuration in the system.

Updating Scheduled One Time Payments

If the third party payment processing system receives a request from the customer to update an existing one time payment, it will call the **C1-ThirdPartyOneTimePayNotification** inbound web service with an **Update** action, passing in the pending one time payment's Service Task ID and the updated payment details.

NOTE: Because bank account numbers and credit card numbers are captured outside of the system, the full account numbers are not sent. In most cases, only a partial value is sent, e.g. last four digits..

The inbound web service updates the existing Third Party One Time Payment Task with the new payment details sent in. The Third Party One Time Payment Task remains in the Pending state.

For more information about the lifecycle of the Third Party One Time Payment Notification service task, refer to the **C1-ThirdPartyOneTimePayTask** business object in the system.

Processing Scheduled One Time Payments

When it is time to process a scheduled one time payment, the third party payment processing will process the payment as it does an immediate one time payment. However, in this case, it will call the **C1-ThirdPartyOneTimePayNotification** inbound web service with a **Process** action, passing in the pending one time payment's Service Task ID and the payment details.

NOTE: Because bank account numbers and credit card numbers are captured outside of the system, the full account numbers are not sent. In most cases, only a partial value is sent, e.g. last four digits.

The inbound web service processes the one time payment as follows:

- The system transitions the existing Third Party One Time Payment Task so that it proceeds to create a frozen payment event.
- The payment date/time sent in by the third party payment processor is stored as a characteristic on the payment tender using the Processing Date/Time Characteristic Type in the Third Party One Time Payment Processing Integration master configuration. This is to capture the actual date/time when the payment was processed. This information is used in tender control processing.
- A reference to the Third Party One Time Payment Task's Service Task ID is stored as a characteristic on the payment tender using the Processing Reference Characteristic Type in the Third Party One Time Payment Processing Integration master configuration. This helps identify that the payment event/tender was created from third party payment processing.
- The Payment Event ID is sent back to the third party payment processing system so that it has a way to identify the payment should there be a need to cancel the payment in the future.

For more information about the lifecycle of the Third Party One Time Payment Notification service task, refer to the **C1-ThirdPartyOneTimePayTask** business object in the system.

For more information about master configuration settings, refer to the **Third Party Payment Processing Integration** master configuration in the system.

Canceling One Time Payments

Scheduled or processed one time payments could get canceled for specific reasons. For instance, a processed payment could get canceled if a customer disputed a credit card charge or if the bank account has insufficient funds. When there is a need to cancel an existing scheduled or processed one time payment, the third party payment processor will cancel the one time payment in their system and call the **C1-ThirdPartyOneTimePayNotification** inbound web service with a **Cancel** action, passing in either a pending one time payment's Service Task ID (if canceling a scheduled payment) or a processed one time payment's Payment Event ID (if canceling a processed payment).

The inbound web service processes the one time payment cancellation as follows:

- For a scheduled on time payment, the existing Third Party One Time Payment Task is simply transitioned to the Discarded state.
- For a processed payment, the cancellation is processed as follows:
 - Since the original Third Party One Time Payment Task is already in the Completed state, a new Third Party One Time Payment Task is created to process the cancellation. Logic on the Process Payment state will cancel the existing Payment Tender using the Payment Event ID that is passed in from the web service.
 - The Tender Cancel Reason is taken from the **Third Party Payment Processing Integration** master configuration.
 - A reference to the cancellation Service Task ID is stored as a characteristic on the payment tender using the Cancellation Reference Characteristic Type that is defined in master configuration.
 - If master configuration is also set up with a Payment Auto-Cancel To Do Type, a To Do Entry is created.

For more information about the lifecycle of the Third Party One Time Payment Notification service task, refer to the **C1-ThirdPartyOneTimePayTask** business object in the system.

For more information about master configuration settings, refer to the **Third Party Payment Processing Integration** master configuration in the system.

Account Verification

A third party payment processing system can perform account verification prior to processing one time payments and automatic payment enrollments. This is to verify that the account exists, as well as to get specific information about the account such as the account balance, due date, past due amount, and existing auto pay information.

The base product provides an inbound web service **C1-ThirdPartyVerifyAccount** that receives an Account ID from the third party payment processor and creates a Third Party Account Verification Task that is responsible for verifying the account. Base-supplied logic on this service task checks that the account exists and returns the account's balance, due date, past due amount (if any) and existing auto pay information (if any). Refer to the **C1-ThirdPartyAcctVerifTask** business object for more details.

Automatic Payment Setup

When the system is integrated with a third party payment processing system, customers who opt for automatic bill payment enrol through the third party payment processing system, where payment information that includes credit card or bank account number are captured and stored.

The third party payment processing system sends a notification when it processes new or updated account auto pay information.

The base product provides an inbound web service **C1-ThirdPartyAutoPaySetup** that receives auto pay setup information and creates a Third Party Auto Pay Setup Task, which is responsible for creating or updating the account's auto pay information. Base-supplied logic on this service task adds an account auto pay option, updates an existing account auto pay option's details or cancels an existing account auto pay option by setting its end date to the designated date. Refer to the **C1-ThirdPartyAutoPayTask** business object for more details.

Interfacing Automatic Payments To A Third Party

For customers who are enrolled to automatically pay bills through a third party payment processing system, existing auto pay processing that occurs during bill completion applies. Refer to [How And When Are Automatic Payments Created?](#) for more details.

The difference with automatic payment processing via third party payment processing system is that the auto pay staging records are not sent directly to the financial institution. Since the routing is different, a third party payment processing system is associated with a distinct Auto Pay Source and Auto Pay Route Type. Refer to [Define Auto Pay Sources and Auto Pay Route Types](#) for more details on this configuration.

Third party automatic payment transactions are extracted using the Third Party Auto Pay Extract (C1-TAPEX) batch process. Refer to [Downloading Automatic Payments and Interfacing Them To The GL](#) for details on how this batch process fits into the auto pay batch process flows.

Highlighting Scheduled Payments

The Scheduled Payments Log zone in Control Central - Account Information displays the following:

- Pending third party one time payments
- Pending self-service one time payments
- Pending bill-related automatic payment records
- One time payments in error that have not been resolved, i.e. not succeeded by a Pending or Completed one time payment

Refer to the zone help for more information.

Automatic Payment Confirmations And Cancellations

A third party payment processing system can notify the system about whether or not the auto pay transactions sent to it for processing were processed successfully.

The base product provides two batch processes, one each for auto pay confirmation and auto pay cancellation. Refer to the following sections for more details.

C1-TAPDF - Third Party Auto Pay Confirmations

This batch process receives a comma-delimited (CSV) file containing information about auto pay transactions that were successfully processed at the third party payment processing system. Each record contains the following:

- Account ID
- Auto Pay Clearing ID (i.e. PK of the auto pay staging record)
- Payment Date/Time

A Process Record algorithm **C1-TAPDF-PR** is plugged in on this batch control. For each record in the file, it distributes and freezes the payment associated with the auto pay staging record. It also updates the payment event date if it differs from the payment date sent with the confirmation. The payment date/time on the confirmation is stored as a characteristic on the auto pay tender.

C1-TAPCN - Third Party Auto Pay Cancellations

This batch process receives a comma-delimited (CSV) file containing information about auto pay transactions that were not processed successfully at the third party payment processing system. Each record contains the following:

- Account ID
- Auto Pay Clearing ID (i.e. PK of the auto pay staging record)

A Process Record algorithm **C1-TAPCN-PR** is plugged in on this batch control. For each record in the file, it cancels the tender associated with the auto pay staging record, using the Tender Cancel Reason that is defined in the Third Party Payment Processing Integration master configuration.

Third Party Payment Tender Controls Processing

A third party payment processing system handles two types of payments: one time payments and recurring automatic bill payments.

The third party payment processing system sets the daily cutoff time for payment processing. For instance, a third party payment processor could set the default daily processing cutoff time to 8pm Eastern Time. But each implementation can override this processing cutoff time. The third party's processing cutoff time is defined in the Third Party Payment Processing Integration master configuration.

For recurring bill auto pays, the system will create the payment event, payment (non-frozen), tender and auto pay staging record. The Tender Control ID is not assigned until a batch process runs and creates the tender and deposit controls for the extracted auto pay transactions.

For one time payments, the assumption is that tender and deposit control processing will be handled in the same way as the recurring auto pays. The one time payment's tender will not be linked to a tender control at one time payment tender creation time. Instead, the tender control will be created in batch, similar to how recurring auto pay tender controls are created.

The base product provides two batch processes for Third Party Auto Pay Tender Controls (C1-TAPCT) and Third Party One Time Payment Tender Controls (C1-TOPCT). For a third party one time payment, a pre-processing batch process C1-TOPPP takes the place of the usual auto pay extract process. This is because third party one time payment auto pays are used purely for tender controls processing and are not sent out to the third party payment processing.

The following sections describe these batch processes.

C1-TAPCT - Third Party Auto Pay Tender Controls

This process creates a tender control (with an associated deposit control) for each batch control and run number encountered for third party automatic payments that are not yet linked to a tender control.

This is a plugin-driven batch process. The C1-TAPCT batch control is delivered with two algorithms plugged in:

- A Select Records algorithm is responsible for selecting the auto pay staging records to process.
- A Process Record algorithm is responsible for linking each auto pay staging record's payment tender to the corresponding tender control.

Your implementation can plug in your own Select Records and Process Record algorithms if your business rules for this extract differ.

This batch process is meant to be run after the Third Party Auto Pay Extract (C1-TAPEX) runs and before Balance Autopay Control Tables (C1-BLAPC) runs.

C1-TOPPP - Third Party One Time Payment Controls Pre-Processing

This process reads all auto pay download staging records marked with a given batch control ID and run number, to verify that the associated one time payment was processed within the current processing cutoff time. Any one time payments that were processed after the cutoff will be updated with the next batch run number.

This is a plugin-driven batch process.

The C1-TOPPP batch control is delivered with two algorithms plugged in:

- A Select Records algorithm is responsible for selecting the auto pay staging records to retrieve, based on the input batch code and batch run number..
- A Process Record algorithm is responsible for verifying that each auto pay staging record selected was processed within the current cutoff time.

Your implementation can plug in your own Select Records and Process Record algorithms if your business rules for this extract differ.

This batch process is meant to be run after the Activate auto-pay (ACTVTAPY) runs and before Third Party One Time Payment Tender Controls (C1-TOPCT) runs. This batch control should be specified on your configured auto pay route type for third party one time payments.

C1-TOPCT - Third Party One Time Payment Tender Controls

This process creates a tender control (with an associated deposit control) for each batch control and run number encountered for third party one time payments that are not yet linked to a tender control.

This is a plugin-driven batch process. The C1-TOPCT batch control is delivered with two algorithms plugged in:

- A Select Records algorithm is responsible for selecting the auto pay staging records to process.
- A Process Record algorithm is responsible for linking each auto pay staging record's payment tender to the corresponding tender control.

Your implementation can plug in your own Select Records and Process Record algorithms if your business rules differ.

This batch process is meant to be run after the Third Party Auto Pay Extract (C1–TOPPP) runs and before Balance Autopay Control Tables (C1–BLAPC) runs.

Issuing A Payment Advice Instead Of Creating An Automatic Payment

If the system is configured to send the customer a payment advice (instead of initiating an electronic funds transfer) when a bill is completed, the automatic payment records - i.e. payment event, payment, tender and auto pay clearinghouse staging - are not created. Refer to [Payment Advices](#) for more information.

How To Set Up A Customer To Receive Payment Advices

Use [Account - Auto Pay](#) to capture the customer's bank details and indicate an auto pay method of Payment Advice.

Payment Advice Option Is For Bill-Related Automatic Payments Only

Payment advices can be printed for auto pays that result from completed bills.

An auto pay for a pay plan scheduled payment will not be created if the account's effective auto pay option is set to Payment Advice. The Pay Plan Auto Pay (PPAPAY) batch process will log an error in this case.

An auto pay for a Non-Billed Budget scheduled payment will not be created if the account's effective auto pay option is set to Payment Advice. The Non-Billed Budget Pay Plan Auto Pay (NBBAPAY) batch process will log an error in this case.

Manually created automatic payments (i.e. auto pays created via payment event UI) are always processed as direct debit.

Maintaining Payment Events

A payment event is used to record when moneys are remitted and how the moneys are allocated amongst accounts. The topics in this section describe how to maintain payment events.

NOTE:

The system creates most payment events behind-the-scenes. Most payment events are created by the system when it [uploads payments](#) and when it creates [automatic payments](#). You should only have to access the payment event transaction if you need to correct a payment event or add a payment event real-time. For information about how the system creates payment events, refer to [The Big Picture of Payments](#).

Payment Lifecycles

The topics in this section describe the lifecycle of the various payment objects.

Payment Event Lifecycle

The following diagram shows the possible lifecycle of a payment event.

WARNING:

This diagram only makes sense in the context of the page used to maintain payment events. Refer to [Payment Event - Main Information](#) for the details.

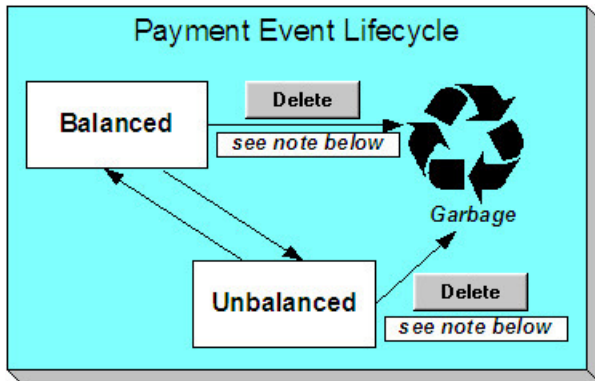

The system, by default, distributes the sum of a payment event's tenders to the account that remits the tenders. After distribution the sum of the tenders equals the sum of the payments (remember, the term *payment* is used to refer to an allocation of some/all of a payment event's tenders to an account's debt) when the event is first created. We refer to such an event as being **Balanced**.

It is possible via any of the methods described in [Unbalanced Payment Events](#) to make a balanced payment event **Unbalanced**.

Click **Delete** to physically remove a balanced or unbalanced payment event from the database. You may not delete a payment event if: a) there are frozen or canceled payments linked to the event, or b) if there are canceled tenders linked to the event, or c) if a tender linked to the event is part of a balanced tender control. When the payment event is deleted, the system also deletes its tenders, payments, and payment segments.

Tender Lifecycle

The following diagram shows the possible lifecycle of a payment event.

WARNING:

This diagram only makes sense in the context of the page used to maintain tenders. Refer to [Payment Event - Tenders](#) for the details.

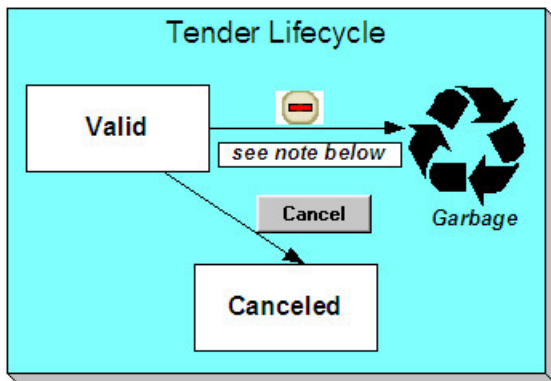

A tender is initially saved in the **Valid** state. It is possible via any of the methods described in [Unbalanced Payment Events](#) to make a balanced payment event **Unbalanced**.

If a tender is invalid, click **Cancel** to cancel the tender AND ALL PAYMENTS LINKED TO THE EVENT.

Click the delete button to physically remove a tender from the database. You may not delete a tender if it is part of a balanced tender control.

Payment Lifecycle

The following diagram shows the possible lifecycle of a payment.

WARNING:

This diagram only makes sense in the context of the page used to maintain a payment. Refer to [Payment - Main](#) for the details.

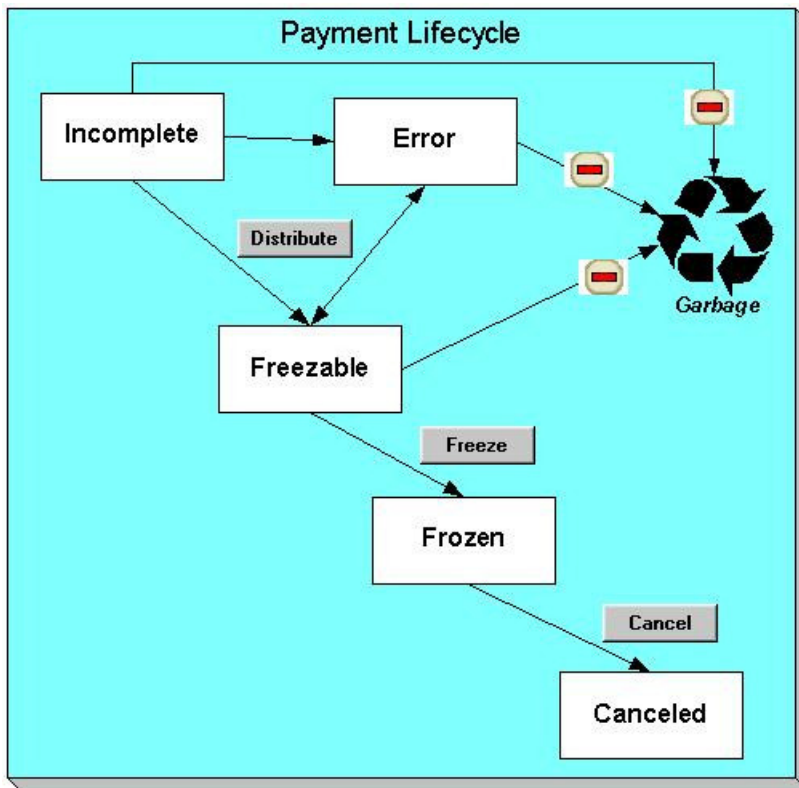

Payments are initially created in the Incomplete state. Payments in this state don't have payment segments or financial transactions; they are simply a stub awaiting distribution.

Click **Distribute** to distribute a payment amongst an account's service agreements.

- If the system cannot distribute the payment (for whatever reason), the payment is moved to the Error state. You may delete such a payment.
- If the system successfully distributes a payment, the payment becomes Freezable.

Click the - button to physically remove an Incomplete, Error or Freezable payment from the database.

Click **Freeze** to freeze a payment and its financial transaction. Freezing the payment causes the following to occur:

- The system executes any payment freeze algorithms linked to the account's [customer class](#) and to the service agreement's [SA type](#).
- The payment's state becomes Frozen and the payment may now appear on a customer's bill.

You may not change a payment once it is frozen. However, you may reverse the payment's financial effect by clicking **Cancel**. Clicking this button will cause the following to occur:

- A new financial transaction is generated and linked to the payment. This financial transaction reverses the financial effects of the original payment.
- The system executes any payment cancellation algorithms linked to the account's [customer class](#).
- If the payment has a related adjustment, this adjustment is also cancelled. Refer to [Loan Overpayments](#) for an example of payments with adjustments.
- The payment becomes Canceled.

Payment Event - Add Dialog

The Payment Event transaction features an unusual dialog that simplifies the addition of new payment events. This page appears if you open the **Menu > Financial > Payment Event > Add** from either the Account context menu or from Menu (it also appears if you click the clear button when on the Payment Event page).

NOTE:

If you have opted to always use the payment event distribution rules method as your [default method](#), the [Payment Event Quick Add \(Single Payment Event\)](#) page appears instead.

Description of Page

The **Payor Account ID** is the account that remitted the payment. We assume this account is both the tendering account and the account whose debt is being relieved by the payment. If this assumption is not correct, choose a **Distribute Action** of Do Not Distribute and then change the tendering or paying account when the Payment Event page appears (after you click **OK**).

NOTE:

Default note. If you have navigated to this page from account context menu, the Payor Account ID and Payment Amount are defaulted to this account.

The **Payment Amount** is the amount of the customer's debt to be relieved by the payment. Note, this amount is defaulted using an algorithm plugged in on the [Installation Record](#). Please refer to APAM-DFLT for more information about how the algorithm that is supplied with the base package calculates this amount.

The payment tenders grid allows you to enter multiple tender types and amounts. Click + to add a new tender. For each tender specify the following fields:

- The **Amount Tendered** is the amount of moneys remitted for the tender type.
- **Tender Type** describes what was remitted (e.g., cash, check, ...). **Tender Type** defaults from the Quick Add Tender Type that is defined on the [installation record](#).
- If a check was tendered, use **Check Number** to specify the identity of the check.

NOTE:

Cash back causes an additional tender to be created. If cash should be returned to the customer (because the customer overpaid and the tender type's cash back allowed switch is true and the tender type is not "like cash"), a negative tender for the cash back amount is created for the payment event. Refer to [Cash Back](#) for a description of how the system can recommend Cash Back amount if the customer tendered more than they are paying.

Match Type and **Match Value** are used if either of the following conditions is true:

- This **Payor Account** belongs to an [open item](#) customer class. In this situation, specify a **Match Type** to define how the payment should be matched to the customer's open-items and use **Match Value** to define the open-items covered by the payment. For example, if this payment is in respect of a bill, specify a match type of "bill ID" and a match value of the bill ID being paid.

NOTE:

Shortcut. If you enter a **Match Type** of "bill ID" and leave the **Match Value** blank, the system assumes the customer wants to pay the latest bill.

- The customer wants to restrict the distribution of the payment to a specific service agreement. In this situation, specify a **Match Type** of "service agreement ID" and a **Match Value** of the respective service agreement ID.

The **Payment Date** defaults to the current date.

If the **Payor Account ID's** [customer class](#) is designated as non-CIS (i.e., the person making the payment isn't a customer), the following information appears in the above window:

- **Non CIS Name** is the name of the person remitting the payment.
- **Reference Number** is the reference number of the item being paid (e.g., the property tax reference number).
- **Non CIS Comments** are used to describe anything unusual about the non-CIS payment.

Use **Distribute Action** to describe what you'd like to have happen when you click the **OK** button:

- Choose Distribute and Freeze if OK if this is a simple payment that should require no manual intervention. By "simple payment" we mean:
 - The account is both the tendering account and the account whose debt is being relieved by the payment
 - The payment date is the current date
 - The payment should be [distributed](#) amongst the account's service agreements using standard distribution logic
- If this option is selected, the system distributes the **Payment Amount** amongst the account's service agreements. If the distribution is successful, the system automatically freezes the payment. If the distribution is not successful, the payment will be in the Error or Incomplete state. When the Payment Event page appears, you can view the error and then correct it. After the cause of the error is corrected, you must distribute and freeze the payment manually (this can be done on several pages including [Payment Event - Main](#) and [Payment - Main](#)).
- Choose Manual Distribution if you need to manually distribute the payment amongst the account's service agreements. If this option is selected, the system creates a payment event, a tender and a payment and then transfers you to the [Payment - Manual Distribution](#) page where you can define the amount to be allocated to each of the account's service agreements. After you've distributed the payment, don't forget to freeze it.
- Choose Do Not Distribute if you want to process the payment event manually (e.g., if you need to define multiple accounts whose debt is relieved by the payment). If this option is selected, the [Payment Event - Main](#) page opens with the information you entered defaulted accordingly. You can make any changes you want and then distribute and freeze the payment. Refer to [How To Add A New Payment Event](#) for more information.

NOTE:

Cash-only warning. If the account has exceeded your [cash-only threshold](#) and the **Tender Type** isn't marked as "like cash", a warning appears advising of such. Note, a customer's cash-only points are maintained on [Account - Credit Rating](#).

Payment Event - Main Information

The Main page contains core payment event information. Open this page using **Menu > Financial > Payment Event > Search**.

FASTPATH:

The **Description of Page** section below describes the fields on this page. Refer to [How To](#) for a description of how to perform common payment event maintenance functions.

Description of Page**NOTE:**

Cash-only customers. When you attempt to add a new payment event, the system warns you if the account remitting the tender is a cash-only customer and the tender's [tender type](#) is not cash. An account is considered cash-only if their current cash-only points exceed the cash-only threshold maintained on the Installation record or account's CIS Division. A customer's cash-only points are maintained on [Account - Credit Rating](#).

Pay Event Info contains a concatenation of the payment date, amount, and the name of the main customer on the account that remits the tender. If multiple tenders exist, the customer's name is not displayed. If the payment event is associated with a single distribution detail, the rule name and the description of the rule value are displayed as well. If multiple distribution details exist, Multiple Distribution Details Exist is displayed instead. If document numbering has been enabled, the assigned document number will appear. If the payment was made in an alternate currency, the message Alternate Currency Used is displayed. **Pay Event Info** is only displayed after the payment event has been added to the database.

Refer to [Alternate Currency Payments](#) and [Document Numbers](#) for more information. **Payment Event ID** is the system-assigned unique identifier of the payment event.

The area under **Pay Event Info** provides warnings about the payment event. Possible warnings are Unfrozen Payments and The Payment Event is Unbalanced. A warning is also issued to the cashier to remind him/her to turn in funds - see [Turn Ins](#).

If multiple distribution details are linked to the payment event, the distribution rule, value, and amount for each distribution detail displays.

Payment Date is the business date associated with the payment event.

WARNING:

If you change the payment date and this event's tender(s) are automatic payments, the extract date (i.e., the date the automatic payment is sent to the financial institution) will be changed to equal the payment date. Refer to [Automatic Payments](#) for more information.

Payment(s) contains the total number and value of payments linked to the event.

Tender(s) contains the total number and value of tenders linked to the event.

Amount Tendered contains the amount that was tendered by the customer.

The system displays a **Cash Back Amount** if the customer tenders more than they are paying (refer to [Cash Back](#) for details).

If the payment event becomes unbalanced, a **Recalculate Cash Back** button appears. If this button is clicked, the system creates, deletes or recalculates the cash back tender. Refer to [Cash Back](#) for details.

While most payment events contain a single payment, the system allows many payments to exist under a payment event (when the payment event's tender(s) are distributed amongst multiple accounts). If a payment event has a large number of payments, you can use the **Account Filter** to limit the payments that appear in the **Payments** grid. The following options are available:

- Account. Use this option if you only want to see the payment linked to an **Account ID**.
- All. Use this option to view all payments linked to the payment event.
- Person Name. Use this option to restrict payments linked to accounts whose main customer has a primary name that matches **Person Name**.

The **Payments** grid contains the payment(s) linked to the payment event. The following points describe the attributes in this scroll; refer to [How To](#) for instructions describing how to perform common maintenance activities.

- **Account ID** references the payment's account. The name of the account's main customer is displayed adjacent.
- **Payment Amount** is the amount of the account's debt relieved by the payment. The adjacent context menu allows you to drill down to the details of the [payment](#) (this is where you can see the payment's payment segments and where you can override the distribution of the payment).
- **Payment Status** is the payment's status. If the payment's status is Error, the error message is displayed adjacent. Refer to [Payment Lifecycle](#) for the potential values and how to handle a payment when it exists in a given state.
- **Match Type** and **Match Value** should only be used if either of the following conditions is true:
 - This **Account ID** belongs to an [open item](#) customer class. In this situation, specify a **Match Type** to define how the payment should be matched to the customer's open-items and use **Match Value** to define the open-items covered by the payment. For example, if this payment is in respect of a bill, specify a match type of "bill id" and a match value of the bill id being paid.
 - The customer wants to restrict the distribution of the payment to a specific service agreement. In this situation, specify a **Match Type** of "service agreement ID" and a **Match Value** of the respective service agreement ID.
- The remaining columns are only used if the payment is linked to an **Account ID** that belongs to a customer class that is used for non-CIS payments. Refer to [Setting Up Customer Classes](#) for more information. If such an account exists, the following fields must be defined.
 - **Non CIS Name** is the name of the person remitting the payment.
 - **Reference Number** is the reference number of the item being paid (e.g., the property tax reference number).
 - **Non CIS Comments** are used to describe anything unusual about the non-CIS payment.
- Note, you can also define a comment for a non-CIS payment. To define a comment, use the context menu adjacent to **Payment Amount** to drill to [Payment - Main](#).
- **Payment ID** is the unique, system-assigned identifier of the payment. This value only appears after the payment has been added to the database.

Refer to [Payment Actions](#) and [Payment Event Actions](#) for information about the action buttons on this page. Refer to [How To](#) for a description of typical business processes that use these buttons.

Payment Event - Tenders

The Tenders page contains a scroll showing one row for every tender associated with the payment event. Open this page using **Menu > Financial > Payment Event > Search** and navigate to the **Tenders** page.

FASTPATH:

The **Description of Page** section below describes the fields on this page. Refer to [How To](#) for instructions describing how to perform common maintenance functions.

Description of Page

Pay Event Info contains a concatenation of the payment date, amount, and the name of the main customer on the account that remits the tender. If multiple tenders exist, the customer's name is not displayed. If the payment event is associated with a single distribution detail, the rule name and the description of the rule value are displayed as well. If multiple distribution details exist, Multiple Distribution Details Exist is displayed instead. If document numbering has been enabled, the assigned document number will appear. If the payment was made in an alternate currency, the message Alternate Currency Used is displayed. **Pay Event Info** is only displayed after the payment event has been added to the database.

Payment Event ID is the system-assigned unique identifier of the payment event.

Payment Date is the business date associated with the payment event.

Payment(s) contains the total number and value of payments linked to the event.

Tender(s) contains the total number and value of tenders linked to the event.

Amount Tendered contains the amount that was tendered by the customer.

The system displays a **Cash Back Amount** if the customer tenders more than they are paying (refer to [Cash Back](#) for details).

If the payment event becomes unbalanced, a **Recalculate Cash Back** button appears. If this button is clicked, the system creates, deletes or recalculates the cash back tender. Refer to [Cash Back](#) for details.

The **Tenders** scroll controls the display of the tenders linked to the payment event. The following simply describes the fields in this scroll; refer to [How To](#) for instructions describing how to perform common tender maintenance activities.

- **Payor Account ID** references the tendering account. The name of the account's main customer is displayed adjacent. If the account has exceeded your cash-only threshold, the warning Cash-Only appears.

WARNING:

If you change the Payor Account ID and the tender has an associated automatic payment request, the automatic payment request will be removed. A new automatic payment request will be created for the new Payor Account ID. Refer to [Automatic Payments](#) for more information.

-
- **Tender Amount** is the amount of the tender. The amount is disabled if the payment was made in an alternate currency.
 - If a check was used, the **Check Number** contains the identity of the check.
 - **Pay Tender ID** is the system-assigned unique identifier of the tender. This value appears after the tender has been added to the database.
 - **Tender Type** describes what was remitted (e.g., cash, check). If the **Tender Type** is associated with an automatic payment, the page displays a section that includes information about how and when the automatic payment was interfaced to the payment source.

NOTE:

Authorizing Tenders. The **Tender Type** dropdown list does not include tender types that require authorization (i.e. credit card payments).

FASTPATH:

For information about tender types requiring authorization, refer to [Credit Card Payments](#).

-
- If the payment tender was remitted in an alternate currency, i.e. a currency other than the payor account's currency, **Alternate Currency** and **Exchange Rate** will display the formatted alternate amount ((includes the alternate amount and currency) and the exchange rate that was in effect on the payment date.

FASTPATH:

For information about accepting payments in alternate currencies, refer to [Alternate Currency Payments](#).

-
- **Tender Status** is the tender's status. Refer to [Tender Lifecycle](#) for the potential values and how to handle a tender when it exists in a given state.
 - If the **Tender Type** is associated with an [automatic payment](#), the system attempts to default automatic payment information from the [account's auto-pay](#) option if the tender type is the same as the tender type on the account's auto-pay source and if the auto pay option is effective on the payment date. If the system is unable to default information, you must specify the source of the funds and the customer's account number / credit card number at the financial institution.

You can override automatic payment information as long as the automatic payment has not been sent to the financial institution or cancelled. The **Auto Pay Section** contains the following fields:

- **Auto Pay Source** is the financial institution / credit card company that receives the automatic payment request.
- **Scheduled Extract Date** is the date the automatic payment request was sent / is scheduled to be sent to the financial institution. This information is display-only.
- **External Account ID** is the customer's account number at the financial institution.

NOTE: The system supports encryption for External Account ID. If your implementation has configured the system to encrypt External Account ID, the data will be displayed with a masked value; such as, *****.Refer to [Encrypting Sensitive Data](#) for more information.

- **Expires On** is only needed if the Tender Type indicates that an expiration date is necessary (e.g., for a credit card payment).
- **Name** is the customer's name in the financial institution's system.
- **Bill ID** is the ID of the bill whose completion caused the creation of the automatic payment. This information only appears if the automatic payment was created as a result of a bill. This information is display-only.
- If the payment was uploaded, the following fields MAY contain information (if they were populated in the interface file):
- **MICR ID** is the value of the magnetic ink character recognition (MICR) line on the payment.

NOTE: The system supports encryption for MICR ID. If your implementation has configured the system to encrypt MICR ID, the data will be displayed with a masked value; such as, *****.Refer to [Encrypting Sensitive Data](#) for more information.

- **Customer ID** is the customer's account ID that appeared on the interfaced payment.
- **Ext. Reference ID** is the unique identifier of the payment upload interface record.
- **Name** is the customer's name on the interfaced payment record.
- In the **Tender Control** area, the **Tender Control ID** is the identity of the remittance processor batch or cash drawer bundle in which the tender was remitted. Refer to [Tender Management and Workstation Cashiering](#) for more information about tender controls.
- Displayed adjacent to **Tender Control** is the date, tender source, and status of the tender control.

Every new tender must reference an open tender control. The system will attempt to default an appropriate tender control as follows:

- If the user has at least one open, user-specific Tender Control, the system will default one, at random.
- If the user has no open, user-specific Tender Controls; the system will default an open, "all users" tender control if it can find one whose tender source indicates it's used for online cashiering. If multiple exist, one will be selected at random.
- Turn off **Included in Tender Ctl Balance** if the tender should not be included in the tender amount in the tender control's tender balance. You would turn this switch off if you canceled a tender because it was mistakenly applied to the wrong account (or the amount was wrong). This switch is only enabled if:
 - The tender control isn't balanced.
 - The tender is canceled.
- **Deposit Control** contains a concatenation of the tender control's deposit control's creation date, tender source type, and status. Refer to [Tender Management and Workstation Cashiering](#) for more information about deposit controls.
- The **Tender Action** area contains a button that you use to cancel a tender. Refer to [Tender Actions](#) for information about this button. Refer to [How To Cancel A Tender](#) for more information.

The **Characteristics** collection on the Tenders page contains information that describes miscellaneous information about the tender. The following fields display:

Characteristic Type Indicate the type of characteristic.

Sequence Controls the order in which characteristics of the same type are displayed.

Characteristic Value Indicate the value of the characteristic.

Payment Event - Characteristics

To update payment event characteristics, open **Menu > Financial > Payment Event > Search** and navigate to the **Characteristics** page.

Description of Page

The **Characteristics** collection contains information that describes miscellaneous information about the payment event.

The following fields display:

Characteristic Type Indicate the type of characteristic.

Sequence Controls the order in which characteristics of the same type are displayed.

Characteristic Value Indicate the value of the characteristic.

Exception

The topics in this section describe exceptions that are detected when the system allocates a payment.

Payment Event Exception

It is possible for a payment event's tenders to not equal its payments. Such events are classified as unbalanced. For each unbalanced payment event, a record is written to the Payment Event Exception table (CI_PAY_EVT_EXCP). A To Do background process creates To Do entries for records in this table.

Unbalanced payment events cause a record to be written to the payment event exception table with a message indicating the nature of the error.

To view the messages associated with the exception records, schedule the [TD-UNBAL](#) background process. This process generates a To Do entry for every record in the payment event exception table.

FASTPATH:

Refer to [Unbalanced Payment Events](#) for instructions describing how to correct an unbalanced payment event.

Payment Exception

When the system is unable to distribute a payment, a record to be written to the payment exception table with a message indicating the nature of the error. A common example of a payment exception is **no service agreement to hold a credit**. This can occur when an account overpays their debt and the account doesn't have a single service agreement that is allowed to hold a credit, a payment error is generated.

The system saves payments that are in error just as it saves payments that are error-free. This is done because payments are nothing more than a snapshot of the data that was used to distribute the payment. By saving the snapshot, you can see the information the system used when it detected the error and therefore more effectively correct it.

Every payment in error is written to the Payment Exception table (CI_PAY_EXCP). A To Do background process creates To Do entries for records in this table.

To view the messages associated with the exception records, schedule the [TD-PYERR](#) background process. This process generates a To Do entry for every record in the payment exception table.

After correcting the cause of the error, drill into the [Payment](#) and attempt to redistribute it.

Resolving Exceptions Automatically

Some payment errors occur because master data was not fully set up prior to receiving a payment for the account. For these cases, the system will periodically check to see whether the master data problem has been resolved by attempting to distribute and freeze the payment in error.

A background process, Resolve Payments in Error - [PY-RPE](#), exists for this purpose. This background process works as follows:

- It looks for payments in error where the error was caused by the lack of active service agreements linked to the payment's account. Note, this may occur when a customer is verbally asked to pay a connection fee or deposit prior to starting service, and for some reason, the appropriate service agreement has not been set up yet, or is still pending.
- For each such payment, it attempts to re-distribute the payment. If service agreements have been created in the meantime, this payment will distribute and freeze successfully.

Payment Event Action Codes

The topics that follow describe each of the actions that appear on the payment event pages.

Payment Actions

The topics that follow describe payment-oriented actions. Refer to [How To](#) for a description of several business processes that use these buttons.

Distribute (Payments)

Clicking the **Distribute** button distributes all Incomplete, Error, or Freezable payments linked to the event. Refer to [Distribute \(A Payment\)](#) for information of how a single payment is distributed.

This button is enabled if at least one payment is Incomplete, Error, or Freezable.

Redistribute (Payments)

Clicking the **Redistribute** button redistributes all Incomplete, Error, or Freezable payments linked to the event. Refer to [Redistribute \(A Payment\)](#) for information of how a single payment is redistributed.

This button is enabled if at least one payment is Incomplete, Error, or Freezable.

Print

This button is enabled under the following conditions:

- The **POS Printing - Payment Event** BPA script is configured in the Point of Sale (POS) Printer Integration master configuration.
- The payment event must have at least one payment that is frozen AND no payments that are in Incomplete, Error or Freezable

Refer to [How To Print Receipts And Endorsements](#) for more information.

Freeze (Payments)

Clicking the **Freeze** button causes all Freezable payments linked to the event to become frozen. Refer to [Freeze \(A Payment\)](#) for information of how a single payment is frozen.

This button is enabled if at least one payment is Freezable.

NOTE:

If problems are detected after freezing. A payment may not be changed after it is frozen. All subsequent changes must occur by canceling the frozen payment and creating a new one. You can cancel and redistribute a payment on the next tab. Refer to [Canceling A Tender Versus Canceling a Payment](#) for more information.

Payment Event Actions

The topics that follow describe payment event-oriented actions. Refer to [How To](#) for a description of typical business processes that use these buttons.

Transfer

If the payment event was created using distribution rule(s), any transfer of its payments should also be done using the distribution rules method. Hence, a different dialog opens when you click **Transfer** based on whether the payment event is associated with at least one distribution detail or not.

Transfer (No Distribution Details Exist)

The **Transfer** button is enabled if:

- There is a single non-cancelled tender linked to the event AND
- There is a single frozen payment linked to the event AND
- The account on the tender is the same as the account on the payment.

When clicked, the **Payment Event Transfer** dialog opens.

You must specify the following parameters in the **Payment Event Transfer** dialog to transfer a payment:

- **Account ID** is the account to which the payment event should be transferred.
- **Cancel Reason** defines why you are performing the transfer.

- **Match Type** and **Match Value** are defaulted based on their values for the payment event that you are transferring. If necessary, modify the values appropriately for the account to which you are transferring the payment event. Match Type and Match Value are used for an account that belongs to an [open item](#) customer class or to restrict the distribution of the payment to a specific service agreement. Refer to [Payment Event - Main](#) for more information.
- Turn on **Freeze Payment** if the transferred payment should be frozen automatically. You may want to leave this turned off if you want to examine the payment distribution before freezing the payment.
- **Non CIS Name**, **Reference Number**, and **Non CIS Comments** appear if the **Account ID** belongs to a customer class that is used for non-CIS payments. Refer to [Setting Up Customer Classes](#) for more information.

Clicking **OK** causes the following to take place:

- The account on the tender is changed to reflect the transfer to account.
- The original payment and its segments are cancelled.
- A new payment is added for the transfer to account. The payment characteristics associated with the original payment are copied to the new payment.
- The new payment is distributed.
- If so designated, the new payment is frozen.

Transfer (Distribution Details Exist)

The **Transfer** button is enabled if:

- There is a single payor AND
- All existing payees before the transfer are the same as the payor AND
- There is at least a single non-cancelled tender linked to the event

When clicked, the **Payment Event Transfer** dialog opens.

You must specify the following parameters in this dialog to transfer payment(s):

- **Distribution Rule** is the account to which the payment event should be transferred.
- **Rule Value** is the value associated with the payment and expected by the distribution rule.
- **Amount** is the payment amount.
- **Cancel Reason** defines why you are performing the transfer.

Clicking **OK** causes the following to take place:

- The payment(s) associated with the original account are canceled.
- The new set of distribution details are processed, creating new payment(s) for the transfer to account. The payment characteristics associated with the original payment are copied to the new payment.
- If all new payments are for the same payee account (and the payee is different than the current payor) the account on the tender is changed to reflect the transfer to account.
- Original distribution details (only those with a non-zero amount) are deleted and replaced by the new set of details on the payment event.

NOTE:

Distribution rule entries can have a zero amount. Refer to [Rule Value Can Capture Additional Information](#) for more information about how to use distribution details to capture additional payment related information.

Determine Tender Account. This dialog does not call the Determine Tender Account algorithm defined on [distribution rule](#) as this action does not rebuild the payment tender collection.

FASTPATH:

Refer to [Rule Value Can Capture Additional Information](#) for more information about how to use distribution details to capture additional payment related information.

Delete A Payment Event

The **Delete** button deletes a payment event and its tenders and payments.

This button is enabled if there are no frozen or canceled payments and no canceled tenders.

Tender Actions

The topics that follow describe tender-oriented actions. Refer to [How To](#) for a description of several business processes that use these buttons.

Cancel A Tender

Clicking **Cancel** causes the following to take place:

- All payments associated with the tender's payment event are canceled.
- The tender becomes canceled.
- If the cancellation reason indicates the cancellation is due to non-sufficient funds, other actions may occur. Refer to [NSF Cancellations](#) for more information.

The **Cancel** button is enabled if the tender is not canceled

When clicked, the **Tender Cancel** window opens.

You must specify the following parameters to cancel a tender:

- Select a **Cancel Reason** to describe why the tender is being canceled.
- The system also needs to know which **Bank Account To Charge** the cancellation against. The system will default the **Bank** and **Bank Account Key** from the original bank information used when the tender was deposited. You can override them here.

When you click the **OK** button, the system cancels the tender and ALL payments linked to the event.

NOTE:

When non-canceled tenders are still linked to the event. If there are multiple tenders linked to the payment event, you must either add new payment(s) that equal the sum of the event's non-canceled tenders or cancel the remaining tenders.

Cancellation after cash back. If a customer tenders a check for \$100, but only owes \$80, the system will recommend returning \$20 in cash to the customer (assuming the tender type for checks allows overpayment). If the tender type for checks is not "like cash", a second tender is created for -\$20 (the first tender is for \$100). If the check subsequently bounces, both tenders must be cancelled.

Payment Event Quick Add

The Payment Event Quick Add page is used to quickly add, distribute and freeze one or more payment events using [distribution rules](#). Open this page using **Menu > Financial > Payment Event Quick Add > Search**.

Description of Page

Specify the **Tender Control ID** in which the tenders will be recorded. Every new tender must reference an open tender control. The system will attempt to default an appropriate tender control as follows:

- If the user has at least one open, user-specific Tender Control whose type is online cashiering or ad hoc, the system will default one, at random.
- If the user has no open, user-specific Tender Controls; the system will default an open, "all users" tender control if it can find one whose tender source has a tender source type of online cashiering or ad hoc. If multiple exist, one will be selected at random.

Specify the **Payment Date**. The current date defaults.

Use **Number of Payment Events** to indicate whether you intend to add a single payment event or multiple payment events.

Choose the multiple payment events option if you intend to add "simple" payment events. By "simple" we mean:

- A single account is both the payor account and the account whose debt is being relieved by the payment.
- The payment tender is not an auto-pay tender.

For all other cases choose the single payment event dialogue as it is designed to handle more complex payment event configurations such as when:

- The payor account is different than the payee account.
- Multiple payors cover payments for one or more payees.
- The payment tender is an auto-pay tender.

Once you have made your selection the page is adjusted to support the corresponding dialog.

NOTE:

Cash-Only customers. When you attempt to add a new payment event, the system warns you if the account remitting the tender is a cash-only customer. An account is considered cash-only if their current cash-only points exceed the cash-only threshold maintained on the Installation record or the account's CIS Division. A customer's cash-only points are maintained on [Account - Credit Rating](#).

Multiple Payment Events Dialog

This section describes the default dialog setup when navigating from **Menu > Financial > Payment Event Quick Add**

Description of Page

Using the multiple payment events option, each row in the payment detail grid typically represents a unique distribution detail. However, more than one row in the grid can belong to a single payment event. All distribution details for identical tender account will be grouped under a single pay event.

The following columns appear in the **Payments** grid:

- Select a **Distribution Rule** by which the payment detail is to be processed. If you have set up a [default distribution rule](#), it is defaulted in the first row.
- Specify the **Rule Value** associated with the payment and expected by the distribution rule.
- Use **Payment Amount** to define the amount of the payment.
- Use **Tender Type** to define the form or remittance (e.g., cash, check, etc.). Note that the **Tender Type** defaults from the [installation record](#).

NOTE:

Authorizing Tenders. The **Tender Type** dropdown list does not include tender types that require authorization (i.e. credit card payments).

FASTPATH:

For information about tender types requiring authorization, refer to [Credit Card Payments](#).

NOTE:

Automatic Payments. The multiple payment events dialog does not support automatic payments. Switch to the single payment event dialog to enter automatic payments.

- Use **Check Number** if a check is remitted.
- **MICR ID** is the value of the magnetic ink character recognition (MICR) line on the payment.

NOTE: The system supports encryption for MICR ID. If your implementation has configured the system to encrypt MICR ID, the data will be displayed with a masked value; such as, *****. Refer to [Encrypting Sensitive Data](#) for more information.

- You may use **Customer ID** to record additional customer information.
- You may use **External Reference ID** to record external information associated with the payment tender.
- You may use **Name** to record additional payment tender information.
- **MICR ID** is the MICR ID associated with the tender.
- **Payor Account ID** is the tender account as determined by the Determine Tender Account algorithm defined on the [distribution rule](#). This information is only populated after the distribution detail has been processed.

After specifying the various payment distribution details in the grid, click **Create**. The system attempts to create payment event(s) as follows:

- As mentioned earlier, all distribution details for identical tender accounts are grouped under a single pay event. The first step in identifying common tenders is to determine the tender account. To do that the system calls the Determine Tender Account algorithm defined on the [distribution rule](#).
- A payment event is created for each unique tender account.
- All rows having all attributes of the tender identical except for the amount are grouped together where each group represents a single tender.
- A single payment tender is created for each unique tender and linked to the payment event.
- The total payment amount for each distinct group of distribution details (for the payment event) having the same rule and value is summarized. For each distinct group, the system calls the Create Payment algorithm defined on the [distribution rule](#) providing it with the rule value and total payment amount. It is the responsibility of this algorithm to create the payments for this payment event.
- Add the distinct payment event distribution detail and its total amount beneath the payment event.
- If the tender control's tender source type indicates that this is a cashiering station and your implementation is configured for printing at a cashier station, the [Print Dialog](#) appears, using the **POS Printing - Payment Event Quick Add BPA** script that is configured in the Point of Sale (POS) Printer Integration master configuration.

The **Payment Event ID** column appears in the grid after the distribution details have been processed. It shows the payment event ID created for the distribution detail record and a short description as to the status of the payment(s) created for the payment event. You can use this field to navigate to the payment event.

After you've added a group of payment events, you should press the [clear](#) button (or Alt-C), to ready the page for the next group of payment event details.

Single Payment Event Dialog

If you have opted to always use the payment event distribution rules method as your [default method](#), this section describes the default dialog setup when you navigate to the **Payment Event** page in **Add** mode.

Adding a single payment event at a time, allows for more complex payment event information to be captured.

Enter one row in the **Tenders** grid for every unique tender associated with the payment event.

- **Payor Account ID** references the tendering account. The name of the account's main customer is displayed adjacent. If the account has exceeded your cash-only threshold, the warning Cash-Only appears.

WARNING:

If you change the Payor Account ID and the tender has an associated automatic payment request, the automatic payment request will be removed. A new automatic payment request will be created for the new Payor Account ID. Refer to [Automatic Payments](#) for more information.

- **Tender Amount** is the amount of the tender.
- Use **Tender Type** to define the form or remittance (e.g., cash, check, etc.). Note, the **Tender Type** defaults from the [installation record](#).
- Use **Check Number** if a check is remitted.
- **MICR ID** is the value of the magnetic ink character recognition (MICR) line on the payment.

NOTE: The system supports encryption for MICR ID. If your implementation has configured the system to encrypt MICR ID, the data will be displayed with a masked value; such as, *****. Refer to [Encrypting Sensitive Data](#) for more information.

- You may use **Customer ID** to record additional customer information.
- You may use **External Reference ID** to record external information associated with the payment tender.
- You may use **Name** to record additional payment tender information.
- If the **Tender Type** is associated with an automatic payment, the page displays a section that includes information about how and when the automatic payment was interfaced to the payment source.
- If the **Tender Type** is associated with an [automatic payment](#), the system attempts to default automatic payment information from the [account's auto-pay](#) option if the tender type is the same as the tender type on the account's auto-pay source and if the auto pay option is effective on the payment date. If the system is unable to default information, you must specify the source of the funds and the customer's account number / credit card number at the financial institution.
 - **Auto Pay Source** is the financial institution / credit card company that receives the automatic payment request.
 - **External Account ID** is the customer's account number at the financial institution.
 - **Expires On** is only needed if the **Tender Type** indicates that an expiration date is necessary (e.g., for a credit card payment).
 - **Name** is the customer's name in the financial institution's system.

The following columns appear in the **Payments** grid:

- Select a **Distribution Rule** by which the payment detail is to be processed. If you have set up a [default distribution rule](#), it is defaulted in the first row.
- Specify the **Rule Value** associated with the payment and expected by the distribution rule.
- Use **Payment Amount** to define the amount of the payment.

After specifying the various payment distribution details in the grid, click **Create**.

NOTE:

Go To Payment Event. If you wish to be transferred to the payment event page once processing is complete, remember to check the Go To Payment Event check box before you click **Create**. This field does not appear when this page is used as the default Payment Event - Add Dialog and you are automatically transferred to the payment event page once the payment event is created.

After distribution details have been processed, a short description of the payment event that has been created is displayed to the right of the **Go To Payment Event** field. The description provides information as to the status of the payment(s) created for the payment event. You can use this field to navigate to the payment event.

The system attempts to create the payment event as follows:

- Validate that the sum of the tenders is not less than the sum of the payments.
- Create the payment event with a separate payment tender for each row in the Tenders grid.
- Summarize the total payment amount for each distinct group of distribution details having the same rule and value. For each distinct group, call the Create Payment algorithm defined on the [distribution rule](#) providing it with the rule value and total payment amount. It is the responsibility of this algorithm to create the payments for the payment event.
- Add the distinct payment event distribution detail summary beneath the payment event.
- If the tender control's tender source type indicates that this is a cashiering station and your implementation is configured for printing at a cashier station, the [Print Dialog](#) appears, using the **POS Printing - Payment Event Quick Add BPA** script that is configured in the Point of Sale (POS) Printer Integration master configuration.

NOTE:

Determine Tender Account. Having an explicit collection of tenders eliminate the need to determine the tender account. Therefore this dialog does not call the Determine Tender Account algorithm.

Payment Quick Add

The Payment Quick Add page is used to quickly add, distribute and freeze payment events for up to fifteen accounts. Open this page using **Menu > Financial > Payment Quick Add**.

Description of Page

Specify the **Tender Control ID** in which the tenders will be recorded. Every new tender must reference an open tender control. The system will attempt to default an appropriate tender control as follows:

- If the user has at least one open, user-specific Tender Control whose type is online cashiering or ad hoc, the system will default one, at random.
- If the user has no open, user-specific Tender Controls; the system will default an open, "all users" tender control if it can find one whose tender source has a tender source type of online cashiering or ad hoc. If multiple exist, one will be selected at random.

Specify the **Payment Date**. The current date defaults.

Enter one row in the grid for every payment event to be added. The following information is entered for each payment event:

- Use **Account ID** to define the customer who tendered the payment. It's important to note that this transaction assumes that the tendering account is the same as the account whose balance is relieved by the payment. Refer to [How To Allocate The Tender Amount To Multiple Accounts](#) if you need to distribute the payment to an account (or accounts) other than the tendering account.

NOTE:

Cash-Only customers. You cannot use this transaction to add a payment for a "cash-only" account if the tender type is not "like cash". An account is considered cash-only if its cash-only points exceed the cash-only threshold maintained on the Installation record. A customer's cash-only points are maintained on [Account - Credit Rating](#). You must use the [Payment Event transaction](#) to add such a payment (note, if you use the Account context menu to transfer to the Payment Event page in add mode, you won't have to retype the Account ID when you add the payment event).

- Use **Payment Amount** to define the amount of the payment.
 - Use **Tender Type** to define the form or remittance (e.g., cash, check, etc.). Note, the **Tender Type** defaults from the [installation record](#).
-

NOTE:

Authorizing Tenders. The **Tender Type** dropdown list does not include tender types that require authorization (i.e. credit card payments).

FASTPATH:

For information about tender types requiring authorization, refer to [Credit Card Payments](#).

- Use **Check Number** if a check is remitted.
 - **Match Type** and **Match Value** are only used if either of the following conditions is true:
 - This **Account ID** belongs to an [open item](#) customer class. In this situation, specify a **Match Type** to define how the payment should be matched to the customer's open-items and use **Match Value** to define the open-items covered by the payment. For example, if this payment is in respect of a bill, specify a match type of "bill id" and a match value of the bill id being paid.
-

NOTE:

Shortcut. If you enter a **Match Type** of "bill id" and leave the **Match Value** blank, we assume the customer wants to pay the latest bill.

- The customer wants to restrict the distribution of the payment to a specific service agreement. In this situation, specify a **Match Type** of "service agreement ID" and a **Match Value** of the respective service agreement ID.

After specifying the various accounts and amounts in the grid, click the **Distribute and Freeze** button. When you click this button, the system attempts to create a payment event for each row in the grid. Four potential outcomes are possible for each row:

- If the data you entered for a payment event isn't complete (e.g., you don't specify a valid account or amount):
 - No payment event is created.
 - A **Message** describing the problem is displayed.
 - All fields on the row remain modifiable.
 - You should correct each such line and then press the **Distribute and Freeze** button.
 - If the data you entered is complete, but the system issues a warning (e.g., the account is considered "cash-only" and a tender type other than cash is remitted, or if the account already has a payment for this amount on this date):
 - No payment event is created.
 - A **Message** containing the warning is displayed.
 - All fields on the row remain modifiable.
-

- You must clear the line and add a payment using the [Payment Event transaction](#) (note, if you use the Account context menu to transfer to the Payment Event page in add mode, you won't have to retype the Account ID when you add the payment event).
- If the data you entered is complete, but the system is not successful in distributing the payment:
 - The system creates a payment event, a payment and a tender.
 - A **Message** describing the problem is displayed.
 - The payment's **Status** is displayed
 - All fields on the row are disabled.
- You must press the adjacent go to button to drill to the payment event where the error can be corrected.
- If the data you entered is complete and the system is successful in distributing the payment:
 - The system creates a payment event, a payment, and a tender.
 - The system distributes the payment amongst the account's service agreements and then freezes the payment.
 - The payment's **Status** is displayed.
 - All fields on the row are disabled.
 - If the tender control's tender source type indicates that this is a cashiering station and your implementation is configured for printing at a cashier station, the [Print Dialog](#) appears, using the **POS Printing - Payment Quick Add** BPA script that is configured in the Point of Sale (POS) Printer Integration master configuration.
- You can press the adjacent go to button to view a payment event.

NOTE:

Separate Commits. This page is unusual in that each payment event is committed to the database independently. For example, if you enter seven payment events and one is invalid, six payment events will be added to the database when you press **Distribute and Freeze**. When the page is redisplayed, the rows containing the valid payments are protected and an indication of their validity is displayed. The row containing the invalid payment remains unprotected. You can correct the erroneous payment and then press the **Distribute and Freeze** button again.

After you've added a group of payments, you should press the [clear button](#) (or Alt-C), to ready the page for the next group of payment events.

Maintaining Payments

Payments and payment segments are automatically created by the system when [payment events](#) are created. You should only need to access this transaction as follows:

- To view a payment's payment segments (i.e., to view how a payment was distributed amongst its account's service agreements).
- To override the distribution of a payment amongst its account's service agreements. Refer to [Distributing A Payment Amongst An Account's Service Agreements](#) for information describing how payments are typically distributed.

The topics in this section describe how to maintain a payment.

Payment - Main

This page contains basic information about a payment. Open this page using **Menu > Financial > Payment > Search**.

WARNING:

Most payments are maintained using the [Payment Event](#) page. The transaction described below is typically only used to view a payment's payment segments and to manually distribute a payment amongst an account's service agreements.

FASTPATH:

The **Description of Page** section below describes the fields on this page. Refer to [How To](#) for instructions on how to perform common maintenance functions.

Description of Page

Payment Info contains a concatenation of the payment date, amount, status, and the name of the main customer on the account.

Payment ID is the system-assigned unique identifier of the payment.

Payment Event ID is the system-assigned unique identifier of the payment event. The adjacent info contains a concatenation of the payment date, amount, and the name of the main customer on the account that remits the event's tender. If multiple tenders exist, the customer's name is not displayed. A warning may also be displayed. The possible warnings are Unfrozen Payments and The Payment Event is unbalanced.

Payment(s) contains the total number and value of payments linked to the payment event.

Tender(s) contains the total number and value of tenders linked to the payment event.

Account ID is the account whose debt is reduced by the payment. The name of the account's main customer is displayed adjacent. This field is gray after the payment is frozen.

Payment Amount is the amount of the payment. This field is gray after the payment is frozen. If the account has exceeded your [cash-only threshold](#), a warning (in red) appears adjacent to **Payment Amount**. Note, a customer's cash-only points are maintained on [Account - Credit Rating](#).

Payment Status is the payment's status. Refer to [Payment Lifecycle](#) for the potential values and how to handle a payment when it exists in a given state. If the payment is in Error, the error message is displayed adjacent. If the payment is canceled, the **Cancel Reason** is displayed adjacent.

Match Type and **Match Value** will only be used if either of the following conditions is true:

- This **Account ID** belongs to an [open item](#) customer class. In this situation, specify a **Match Type** to define how the payment should be matched to the customer's open-items and use **Match Value** to define the open-items covered by the payment. For example, if this payment is in respect of a bill, specify a match type of "bill id" and a match value of the bill id being paid.
- The customer wants to restrict the distribution of the payment to a specific service agreement. In this situation, specify a **Match Type** of "service agreement ID" and a **Match Value** of the respective service agreement ID.

Match Type and **Match Value** are gray after the payment is frozen.

If the payment is linked to an **Account ID** that belongs to a [customer class](#) that is used for non-CIS payments, the following fields appear (note, these fields are gray after the payment is frozen):

- **Name** is the name of the person remitting the payment.
- **Reference Number** is the reference number of the item being paid (e.g., the property tax reference number).
- **Comments** are used to describe anything unusual about the non-CIS payment.

The contents of the **Payment Segments** section depends on the number of payment segments linked to the payment. If more than 25 payment segments exist, a message appears that allows you to navigate to [Payment - Payment Segments](#) where you can view the payment segments (this page has special functionality that allows you to defined which payment segments should be displayed). If 25 or fewer payment segments exist, the grid contains information about each payment segment:

- **Premise** is the address of the service agreement's main premise.

- **SA Information** contains basic information about the service agreement.
- **Distributed Amt** is the amount of the service agreement's debt relieved by the payment.

The following information appears at the bottom of the page:

- **Payment Amount** is the amount of the payment.
- **Distributed Amount** is the sum of the payment segments linked to the payment.
- The **Difference** between the **Payment Amount** and the **Distributed Amount** appears if it is non-zero.
- **Billed Amount** is the amount of the bill preceding the payment date.
- **Delinquent Amount** is the amount of the customer's debt that was due on / before the prior bill's due date.
- **Current Balance** is the account's current balance.

Refer to [Payment Action Codes](#) for information about the action buttons on this page.

Payment - Pay Segments

You can use this page to view all or selected payment segments linked to a payment.

Open **Menu > Financial > Payment > Search** and navigate to the **Payment Segments** page to view this information.

WARNING:

Most payments are maintained using the [Payment Event](#) page. The transaction described below is typically only used to view a payment's payment segments.

NOTE:

If the payment has more than 25 payment segments, the search criteria are intentionally left blank in order to avoid retrieving all payment segments (with the resultant slow response times). You must therefore use the **SA Filter** to define the type of payment segments that should be retrieved. See the Description of page below for more information about this page's search criteria.

Description of page

Payment Info contains a concatenation of important information about the payment.

Payment ID is the system-assigned unique identifier of the payment.

Payment Event ID is the system-assigned unique identifier of the payment event. The adjacent info contains a concatenation of the payment date, amount, and the name of the main customer on the account that remits the event's tender. If multiple tenders exist, the customer's name is not displayed. A warning may also be displayed. The possible warnings are Unfrozen Payments and The Payment Event is unbalanced.

Payment(s) contains the total number and value of payments linked to the payment event.

Tender(s) contains the total number and value of tenders linked to the payment event.

NOTE:

If the payment has more than 25 payment segments, the search criteria are intentionally left blank in order to avoid retrieving all payment segments (with the resultant slow response times). You must therefore use the **SA Filter** to define the type of payment segments that should be retrieved.

Use the **SA Filter** to define the types of service agreements whose payment segments appear in the grid. The following options are available:

- **Address.** Use this option to restrict payment segments to those whose service agreements are linked to service points associated with a given **Address, City** and/or **Postal** code. Note, you can specify any combination of these fields.
- **All.** Use this option if you do not wish to restrict payment segments based on service agreement attributes.
- **Geographic Type.** Use this option to restrict payment segments to those whose service agreements are linked to service points associated with a given **Geographic Type** and **Geographic Value**.
- **SA Type.** Use this option to restrict payment segments to those whose service agreements are linked to a given **CIS Division** and **SA Type**.

Don't forget to click the search button after changing the **SA Filter**.

The grid that follows contains the payment segments that match your search criteria. The following information appears in the grid:

- The **Premise** column contains the characteristic premise associated with the payment segment's service agreement. Refer to [Maintaining Premises](#) for more information about this premise.
- Click the go to button to transfer to view the financial transaction related to the payment segment. This is only available after the payment has been frozen.
- **SA Information** contains summary information about the service agreement.
- **Distributed Amt** is the amount of the service agreement's debt relieved by the distribution.
- **Adjustment ID** is displayed if there is an adjustment associated with the payment. Refer to [Loan Overpayments](#) for an example of when an adjustment is associated with a payment.

The following information appears at the bottom of the page:

- **Payment Amount** is the amount of the payment.
- **Distributed Amount** is the sum of the payment segments linked to the payment.
- The **Difference** between the **Payment Amount** and the **Distributed Amount** appears if it is non-zero.
- **Billed Amount** is the amount of the bill preceding the payment date.
- **Delinquent Amount** is the amount of the customer's debt that was due on / before the prior bill's due date.
- **Current Balance** is the account's current balance.

Payment - Manual Distribution

You can use this page to view service agreements linked to the payment's account and to manually distribute a payment amongst specific service agreements.

Open this page using **Menu > Financial > Payment > Search** and navigate to the **Manual Distribution** page.

WARNING:

Most payments are maintained using the [Payment Event](#) page. The transaction described below is typically only used to view a payment's payment segments and to manually distribute a payment amongst an account's service agreements.

NOTE:

If the payment's account has more than 25 service agreements, the search criteria are intentionally left blank in order to avoid retrieving all service agreements (with the resultant slow response times). You must therefore use the **SA Filter** to define the type of service agreements that should be retrieved. See the Description of page below for more information about this page's search criteria.

Description of page

Payment Info contains a concatenation of important information about the payment.

Payment ID is the system-assigned unique identifier of the payment.

NOTE:

If the payment's account has more than 25 service agreements, the search criteria are intentionally left blank in order to avoid retrieving all service agreements (with the resultant slow response times). You must therefore use the **SA Filter** to define the type of service agreements that should be retrieved.

Use the **SA Filter** to define the types of service agreements that appear in the grid. The following options are available:

- **Address.** Use this option to restrict service agreements to those linked to service points associated with a given **Address**, **City** and/or **Postal** code. Note, you can specify any combination of these fields.
- **All.** Use this option if you want to view all service agreements.
- **Geographic Type.** Use this option to restrict service agreements to those linked to service points associated with a given **Geographic Type** and **Geographic Value**.
- **SA Type.** Use this option to restrict service agreements to those linked to a given **CIS Division** and **SA Type**.

Don't forget to click the search button after changing the **SA Filter**.

The grid that follows contains the service agreements that match your search criteria. The following information appears in the grid:

- **Premise** contains the characteristic premise associated with the service agreement.
 - **SA Information** contains summary information about the service agreement.
 - **Distributed Amt** is the amount of the service agreement's debt relieved by the payment. This field is gray after the payment is frozen.
 - **Billed Amt** is the amount that was billed for the service agreement on the bill preceding the payment date.
 - **Delinquent Amt** is the amount of debt associated with financial transactions that appear on overdue bills.
 - **Current Balance** is the amount currently owing for this service agreement.
-

NOTE:

If the account being paid is an **open item** account, then an alternate grid is displayed. The alternate grid is designed to break down payable balances by individual bill and service agreement. Both unpaid bill balances and new charges are displayed. After distribution, a separate match event will be created for each bill paid or partially paid.

that an implementation can override the type of grid displayed for open item accounts by setting up a Financial Transaction Options [Feature Configuration](#) with an Always Use Manual Payment Distribution By SA option set to Y. With this in place, the system will always display the manual distribution by service agreement grid.

The open item manual distribution grid contains the following columns:

- **Bill Date**
 - Shows bill date if the row contains an account's unpaid bill.
 - Shows '**New Charges**' if the row contains an account's unbilled new charges.
 - Shows '**Payment Segment**' for the following conditions:
 - Row is a pay segment of a cancelled payment.
 - Row is a pay segment of an overpayment to the highest priority SA or an excess credit SA.
 - Row is a pay segment of a balance forward payment distribution.
 - **Premise Information** contains the characteristic premise associated with the service agreement.
-

- **SA Information** contains summary information about the service agreement.
- **Distributed Amount**
 - You can enter an amount to distribute if the payment is non-frozen and non-cancelled, otherwise, this field is protected.
- **Billed Amount**
 - The amount that was billed for the service agreement on the row's bill. If the row does not represent a bill amount then this will be zero.
- **Unpaid Amount**
 - This is determined by the "determine open-item bill amount" algorithm as defined on the installation option.
 - This column will contain zero if:
 - The row is linked to an open non-disputed match event with other bills' FTs on it. In this case, it is not possible to determine the bill amount.
 - The row is linked to an open disputed match event.

For either grid, the following information appears at the bottom of the page:

- **Payment Amount** is the amount of the payment.
- **Distributed Amount** is the sum of the payment segments linked to the payment.
- The **Difference** between the **Payment Amount** and the **Distributed Amount** appears if it is non-zero.
- **Billed Amount** is the amount of the bill preceding the payment date.
- **Delinquent Amount** is the amount of the customer's debt that was due on / before the prior bill's due date.
- **Current Balance** is the account's current balance.

Payment - Characteristics

To update payment characteristics, open **Menu > Financial > Payment > Search** and navigate to the **Characteristics** page.

Description of Page

The **Characteristics** collection contains information that describes miscellaneous information about the payment. The following fields display:

Characteristic Type Indicate the type of characteristic.

Sequence Controls the order in which characteristics of the same type are displayed.

Characteristic Value Indicate the value of the characteristic.

Payment Action Codes

The topics in this section describe each of the actions that appear on the payment pages.

Distribute (A Payment)

Clicking the **Distribute** button causes a payment to be distributed amongst the account's service agreements. Refer to [Distributing A Payment Amongst An Account's Service Agreements](#) for a description of how this is achieved.

This button is enabled if a payment is Incomplete, Error, or Freezable. Refer to [Payment Lifecycle](#) for more information about these status values.

If the payment is distributed appropriately, click the [Freeze](#) button to freeze the payment and its payment segments.

Redistribute (A Payment)

Clicking the **Redistribute** button causes a payment to be redistributed amongst the account's service agreements. Refer to [Distributing A Payment Amongst An Account's Service Agreements](#) for a description of how this is achieved.

This button is enabled if a payment is Incomplete, Error, or Freezable. Refer to [Payment Lifecycle](#) for more information about these status values.

If the payment is distributed appropriately, click the [Freeze](#) button to freeze the payment and its payment segments.

NOTE:

This button is only available on the [Payment - Main](#) and [Payment - Manual Distribution](#) pages.

Confirm (A Payment)

Clicking the **Confirm** button confirms that manually entered amounts associated to certain SAs will relieve their balances. This is the same process that is triggered by clicking **Save**.

This button is enabled if a value is manually entered in a Distributed Amount field.

Freeze (A Payment)

Clicking the **Freeze** button causes a payment and its payment segments to become frozen. Refer to [Payment Lifecycle](#) for more information about freezing.

This button is enabled if the payment is Freezable.

NOTE:

If problems are detected after freezing. A payment may not be changed after it is frozen. All subsequent changes must occur by canceling the frozen payment and creating a new one.

Cancel (A Payment)

Clicking the **Cancel** button causes the payment and its payment segments to be canceled. Canceling a payment (as opposed to canceling a tender) is typically only done if the original distribution was frozen and it's incorrect.

This button is enabled if the payment is Frozen. Refer to [Payment Lifecycle](#) for more information about these status values.

Transfer (A Payment)

The **Transfer** button is enabled if the payment is Frozen. Refer to [Payment Lifecycle](#) for more information about these status values.

If the payment being transferred was created using payment event distribution rule(s), the payment transfer should also be done using the distribution rules method. Hence, a different dialog opens when you click **Transfer** based on whether the payment's payment event is associated with at least one distribution detail or not.

Transfer Payment (No Distribution Details Exist)

Payment transfer causes the payment and its payment segments to be canceled and a new payment to be created. Transferring a payment is typically only done if the original distribution was targeted at the wrong account but all tender information for the pay event is correct. Unlike the [payment event transfer](#), transferring a single payment does not affect the pay event's tender information.

You must specify the following parameters in the **Payment Transfer** window to transfer a payment:

- **Account ID** is the account to which the payment should be transferred.
- **Cancel Reason** defines why you are performing the transfer.
- **Match Type** and **Match Value** are defaulted based on their values for the payment event that you are transferring. If necessary, modify the values appropriately for the account to which you are transferring the payment event. Match Type and Match Value are used for an account that belongs to an [open item](#) customer class or to restrict the distribution of the payment to a specific service agreement. Refer to [Payment Event - Main](#) for more information.
- Turn on **Freeze Payment** if the transferred payment should be frozen automatically. You may want to leave this turned off if you want to examine the payment distribution before freezing the payment.
- **Non CIS Name**, **Reference Number**, and **Non CIS Comments** appear if the **Account ID** belongs to a customer class that is used for non-CIS payments. Refer to [Setting Up Customer Classes](#) for more information.

Clicking **OK** causes the following to take place:

- The original payment and its segments are cancelled.
- A new payment is added for the transfer to account. The payment characteristics associated with the original payment are copied to the new payment.
- The payment is distributed amongst the new account's service agreements.
- If so designated, the new payment is frozen.

Transfer Payment (Distribution Details Exist)

Payment transfer causes the payment to be canceled and new payment(s) to be created using new payment event distribution rule(s). Transferring a payment is typically done when a payment event has multiple payments and one or more payments have been assigned to the wrong SA. Each of the incorrectly directed payments can be transferred to the correct SA(s) using the **Transfer via Distribution Rules** dialog.

Total Amount is the total payment amount to transfer from.

You must specify the following parameters in order to transfer a payment:

- **Distribution Rule** is the service agreement to which the payment should be transferred.
- **Rule Value** is the value associated with the payment and expected by the distribution rule.
- **Amount** is the payment amount.
- **Cancel Reason** defines why you are performing the transfer.

Clicking **OK** causes the following to take place:

- The payment associated with the original account is canceled.
 - The new set of distribution details is processed, creating new payment(s) for the transfer-to service agreement(s). The payment characteristics associated with the original payment are copied to the new payment.
 - The new set of distribution details is added to the payment event. The original distribution details are kept.
-

NOTE:

Distribution rule entries can have a zero amount. Refer to [Rule Value Can Capture Additional Information](#) for more information about how to use distribution details to capture additional payment related information.

Determine Tender Account. This dialog does not call the Determine Tender Account algorithm defined on [distribution rule](#) as this action does not rebuild the payment tender collection.

Delete (A Payment)

The **Delete** button deletes a payment. This button is enabled if the payment is Incomplete, Error, or Freezable.

Payment Portal

The base package is shipped with a configured payment portal that can be used for payment processing. The portal supports the following functionality that is not supported in the base [Payment Event - Add Dialog](#):

- Processing of payments that require authorization (i.e. credit card payments)
 - Creating non CIS payments based on payment templates
 - Processing payment tenders in alternate currencies
-

FASTPATH:

Refer to [The Big Picture of Portals and Zones](#) in the *Oracle Utilities Application Framework Administration Guide* for a description of portal and zone functionality.

Credit Card Payments

The payment portal provides the functionality needed for posting and authorizing customers' credit card charges in real-time. If the credit card authorization is successful, the payment will be added automatically (assuming you selected the appropriate payment freeze action via the portal).

FASTPATH:

Refer to [How To](#) for instructions describing how to add a payment that requires authorization.

Non CIS Payments

The payment portal allows you to add non-CIS payments using a payment template. Payment Templates can be configured for common types of payment allocations to pre-populate the payment distribution, allowing non-CIS payments to be directly allocated against the appropriate distribution codes.

FASTPATH:

Refer to [How To](#) for instructions describing how to add a non-CIS payment using a payment template.

Alternate Currency Payments

The payment portal allows you to process a payment tender remitted in an alternate currency. The system enables conversion of the tendered amount into the account's currency.

FASTPATH:

Refer to [How To](#) for instructions describing how to process a payment in an alternate currency.

How To

The topics in this section describe how to perform common payment maintenance functions.

How To Add A New Payment Event

There are several ways to add a new event:

- You can use [Payment Quick Add](#) to quickly add one or more payment events. You'd use this approach to add simple payments where no manual intervention is required. By "simple payment" we mean:
 - The account is both the tendering account and the account whose debt is being relieved by the payment
 - The payment date is the current date
 - The payment should be [distributed](#) amongst the account's service agreements using standard distribution logic
- If applicable to your business practice, you can use [Payment Event Quick Add](#) to quickly add one or more payment events using [distribution rules](#).
- You can use [Payment Event Maintenance](#) to add a payment event. You would use this approach if multiple forms of payment are remitted (e.g., cash and a check) or if there are multiple payors and/or payees linked to the payment event.

NOTE:

By default the system opens the [Payment Event - Add Dialog](#) when you navigate to this page in add mode. If you have opted to always use the payment event distribution rules method as your [default method](#), the [Payment Event Quick Add \(Single Payment Event\)](#) page appears instead. Refer to these pages for more information.

How To Cash A Check

If you allow customers to cash checks, you'll have a payment event with two tenders:

- The first tender contains information about the check.
- The second tender contains information about the cash refund (the tender amount is a negative amount equal to the amount of the check).

The interesting aspect of this payment event is that it has no payments because the sum of the tenders is zero.

We start this explanation in the middle of [How To Add A New Payment Event](#).

In the **Payment Event Add** dialog, be sure to select Do Not Distribute before clicking **OK**.

- On the **Main** page, click - to remove the payment (cashing a check is a payment event with no payments).
- Transfer to the **Payment Event, Tenders** page.
- **Insert** a row in the tender scroll (click the + button) for the cash refund tender. In this row enter a tender type of "cash" and a tender amount of negative the check amount.
- Save the event (note there is nothing to distribute or freeze).

How To Allocate The Tender Amount To Multiple Accounts

When you add a payment event, the system automatically creates a single payment for the account that remitted the funds. If someone is remitting funds for someone other than themselves, you must change/add payments. This section describes how to do this.

NOTE:

This section assumes you chose to add the payment event using the [Payment Event - Add Dialog](#). Refer to [How To Add A New Payment Event](#) for the complete list of options.

In the [Payment Event - Add Dialog](#), be sure to select Do Not Distribute before clicking **OK**.

On the payment event Main page, do the following:

- If the remitting account shouldn't have received any part of the payment, **Remove** it from the payments grid by clicking the - button. Alternatively, you can just change the account id to reflect the recipient.
- If multiple accounts receive the remitted funds, **Insert** one row in the payments grid (click the + button) for each additional account.
- When the payment event is balanced, **Save** it. Then **Distribute** and **Freeze** the payment(s). Refer to [Payment Event Actions](#) for more information on these action buttons.

How To Print Receipts And Endorsements

The system can be configured to allow you to endorse checks and print receipts using special cashiering station printers. This section describes the print options available.

NOTE:

These options are only available if they have been installed in your system. Installing these options are a delivery and installation issue and are not within the domain of this document. Refer to the Receipt Printing section of the Optional Products Installation Guide for information on printer installation and how to configure the system for printing.

The print functions are available from the [Payment Event](#), [Payment Quick Add](#) and [Payment Event Quick Add](#) transactions. Refer to those sections for more information.

The print dialog functions are described below.

Description of Page

Use the **Endorse** button to endorse checks using the cashier station printer. This is only enabled if one of the tender types indicates a check. If there were multiple checks, use the scroll buttons to select them. Feed the appropriate check in the printer and an endorsement message is printed on the back.

Use the **Receipt** button to print a receipt using the cashier station printer. Choose a **Short** or **Long** option. Use the **Duplicate** button to print a duplicate receipt - this prints the receipt with a "duplicate" label.

Use the **Stub** button to print special information in bill stub format (account, name, amount). Feed a slip of paper into the printer and the special stub information will be printed.

When you are finished, click **Done**; click **Cancel** to exit at any time.

NOTE:

The various text strings that are printed on the receipt and the endorsement are defined on the Payment Receipt Message and Endorse Message installation message types on [Installation Options - Messages](#).

How To Cancel A Tender

If a tender is no longer valid (e.g., a check bounces), the tender must be canceled. The following steps explain how to do this.

WARNING:

These steps only make sense in the context of the page used to maintain tenders. Refer to [Payment Event - Tenders](#) for the details.

You navigate through the pages as follows:

1. Open the payment event - tenders page for the tender in question. Proceed to step 2.
2. Click **Cancel**. Proceed to step 3.
3. Before the system cancels the tender, you must specify the cancel reason. The tender cancel window opens.

In the tender cancel window, select a **Cancel Reason** to describe why the tender is being canceled. The system also needs to know which **Bank Account To Charge** the cancellation against. The system will default the **Bank** and **Bank Account Key** from the original bank information used when the tender was deposited. You can override them here.

When you click the **OK** button, the system cancels the tender and ALL payments linked to the event.

If the cancellation reason you supply is indicated as being "non-sufficient funds", the system will generate an adjustment to levy a NSF charge. Refer to [SA Type - Main Information](#) for more information.

NOTE:

When non-canceled tenders are still linked to the event. If there are multiple tenders linked to the payment event, you must either add new payment(s) that equal the sum of the event's non-canceled tenders or cancel the remaining tenders.

Cancellation after cash back. If a customer tenders a check for \$100, but only owes \$80, the system will recommend returning \$20 in cash to the customer (assuming the tender type for checks allows overpayment). If the tender type for checks is not "like cash", a second tender is created for -\$20 (the first tender is for \$100). If the check subsequently bounces, both tenders must be cancelled.

How To Transfer A Payment From One Account To Another

If you need to transfer a payment amount from one account to another, you can use the **Transfer** button either on the payment event page or the payment page.

FASTPATH:

Refer to [Transferring A Payment](#) for a description of when to use each option.

How To Distribute A Payment To A Specific Service Agreement

When you click **Distribute**, the system uses the payment distribution algorithm defined on the account's customer class to allocate the payment amongst the account's service agreements. In this section, we describe how to override this distribution (e.g., when you need to allocate a payment to specific service agreement(s)).

We start this explanation in the middle of [How To Add A New Payment Event](#).

In the **Payment Event Add** dialog, be sure to select Do Not Distribute before clicking **OK**.

- **Save** the payment event (this also saves the payment and tender information).
- Use the **Payment Amount** context menu to transfer to the **Manual Distribution** page.
- Fill in the desired **Distributed Amt** for each service agreement and save the payment.
- Click **Freeze** to freeze the payment when the amount distributed is equal to the payment amount.

How To Get An Unbalanced Tender Control In Balance (Fixing Over/Under)

In order to balance a tender control that is out-of-balance, you must create a tender for an account associated with your company.

NOTE:

The over / under account. Your organization must set up a company-use account with a service agreement whose SA type references the over/under distribution code. This account should be linked to the person ID associated with company usage.

- If you have more money in the drawer than you have tenders, then you're "over". In this situation, you need to record a payment for the "over" amount and the tender type configured for cash drawer over/under amounts. This will cause cash to be debited by the over amount, and the expense account associated with the account's service agreement to be credited.
 - If you have less money in the drawer than you have tenders, then you're "under". In this situation, you need to record a negative payment for the "under" amount and the tender type configured for cash drawer over/under amounts. This will cause cash to be credited by the over amount, and the expense account associated with the account's service agreement to be debited.
-

IMPORTANT:

A separate tender type is used for recording cash drawer over/under amounts. Once the over/under amount has been determined, you must enter a new tender using your over/under tender type for the company-use account. Check out the following table for an example:

Tender Type	Starting Balance	Tenders Received	Turn Ins	Actual Ending Balance (Entered by Cashier)	Expected Ending Balance	Over/Under Amount
Cash	\$150.50	\$5,000	\$4,000	\$1151	\$1150.50	Over \$0.50
Check	-	\$1,000	\$750	\$249	\$250	Under \$1

Over/Under	-	\$-0.50	-	-	\$-0.50	Over \$0.50
------------	---	---------	---	---	---------	-------------

In this example, you'd have to create a new tender for the company-use account for the amount that will be distributed to the company-use account's service agreement (debit over/under expense, credit cash):

- Tender type: Over/Under, Tender amount: -\$0.50

NOTE:

You must reopen the tender control. Before you can add an over/under tender to a tender control, you must re open the tender control (tenders may only be added to open tender controls).

How To Add A Non-CIS Payment Using A Template

The payment portal allows you to add non-CIS payments using a payment template. Payment Templates can be configured for common types of payment allocations to pre-populate the payment distribution and allowing non-CIS payments to be directly allocated against distribution codes. The following steps explain how to do this.

You navigate through the pages as follows:

- Open **Menu > Financial > Payment Portal**.
- The **Add Non CIS Payment Zone** shows a list of all active payment templates. Use the **Add** button to add a non-CIS payment for a specific payment template.
- Enter the payment and tender details (**Payment Amount**, **Payment Date** defaults to the current date, **Tender Source** is used to find an open tender control when adding the tender).

NOTE:

Authorizing Tenders. If the **Tender Type** selected requires authorization (i.e. credit card payments), additional authorization details are required (e.g. credit card type, credit card number, etc.). Only one tender that requires authorization can exist for a single payment event.

FASTPATH:

For information about tender types requiring authorization, refer to [How To Authorize A Credit Card Tender](#).

- Enter the non-CIS information for the customer remitting the payment (**Customer Name**, **Agreement Number** and **Comments** to describe anything unusual about the non CIS payment).

NOTE:

Payor Account ID. The Non CIS Account Id specified on the payment template is used as the tendering account. If the account has exceeded your [cash-only threshold](#) and the **Tender Type** isn't marked as "like cash", a warning appears advising of such.

Including a CIS payment. If a portion of the tender is for a CIS payment, ensure that the **Add CIS Payment** checkbox is selected. The system will process the non-CIS payment, and then navigate the user to the Payment Event page where the CIS payment can be included.

- The distribution details are defaulted from the payment template but may be overridden. You can add additional distribution lines. Enter the payment amount and Reference Number for each applicable distribution line.
- When you click the **OK** button, the system creates the payment event and tender(s). A single payment is created for each non-zero amount entry in the distribution details list. The payment template is captured as a characteristic on the tender. The corresponding distribution code, GL account and reference number are captured as characteristics on each payment.

When the financial transactions are created for these payments, the distribution code (and GL account) is retrieved from the payment characteristic collection.

How To Authorize A Credit Card Tender

You can use the Payment Portal to add a payment event for a tender that requires authorization. The following steps explain how to do this.

If your organization is using the base tender authorization functionality, you can navigate through the pages as follows:

- Open **Menu > Financial > Payment Portal**.
- The **Add CIS Payment Zone** only expands if there's an account in context. To expand this zone, either search for an account using Control Central or use the Tender Search available on the **Payment Portal**.
- Use the **Add Payment** button to add a payment for the account displayed in the zone.
- The information displayed is the same as that on the [Payment Event - Add Dialog](#), except for the following:
 - Use **Distribute Action** to describe what you'd like to have happen when you click the **OK** button. The dropdown contains the following values - Distribute and Freeze if OK, Manual Distribution and Manual Distribution - Multiple Payments

NOTE:

The **Distribute and Freeze if OK** and **Manual Distribution** options are also present on the **Distribute Action** on the payment event add dialog screen. The third option, **Manual Distribution - Multiple Payments**, is special for credit card authorization processing. This option is similar to the **Manual Distribution** option except that the user is navigated to the **Payment Event** maintenance page after authorization has taken place.

-
- If the **Tender Type** selected requires authorization (e.g., credit card payments), additional authorization details are required (e.g. credit card type, credit card number, etc.). This information is displayed in the **Credit Card Information** section.

NOTE:

Authorizing Tenders. Only one tender that requires authorization can exist for a single payment event.

-
- The **Authorization Override** checkbox is only displayed if the tender type selected requires authorization. Use the **Authorization Override** checkbox to indicate whether or not tender authorization should take place. If **Authorization Override** is checked, an authorization code must be entered and the system bypasses the authorization web service call.
 - Click **OK to save the payment and navigate to the appropriate page**.
 - Assuming the credit card is accepted, the authorization code returned by the credit card authorization provider is captured as a tender characteristic.
 - If the credit card is declined, the tender will not be added.

How To Reverse A Credit Card Tender

The steps required to reverse a credit card tender are the same as the steps for [How To Cancel A Tender](#).

The reversal code from the credit card authorization service is stored as a tender characteristic.

FASTPATH:

For more information on authorizing credit card payments, refer to the following business objects: Tender Type - Credit Card with Authorization, CyberSource - Credit Card Authorization and CyberSource - Credit Card Reversal.

How To Process An Alternate Currency Payment

You can use the Payment Portal to add a payment event for a tender(s) in an alternate currency, i.e. a currency that differs from the account's currency. The following steps explain how to do this.

- **Open Menu > Financial > Payment Portal.**
- The **Add CIS Payment Zone** only expands if there's an account in context. To expand this zone, either search for an account using Control Central or use the Tender Search available on the **Payment Portal**.
- Use the **Add Payment** button to add a payment for the account displayed in the zone.
- The information displayed is the same as that on the [Payment Event - Add Dialog](#), except for the following:
 - If your organization accepts payment tenders in alternate currencies, the **Currency Converter** button appears in the tender list
- Use the **Currency Converter** button to enter the **Tendered Amount** and **Tendered Currency** in the alternate currency and click **OK**. The system will convert the alternate currency amount to the account's currency.
- Click **OK** to save the payment and navigate to the appropriate page.
- When you click the **OK** button, the system creates the payment event and tender(s). Each tender is linked to an appropriate tender control based on the currency of the tender.

FASTPATH:

Refer to [Alternate Currency Payments](#) for more information.

Financial Transactions On A Payment

Open **Menu > Financial Query > Financial Transactions On A Payment** to view the financial transactions on a payment.

NOTE:

You can also open this page using the go to buttons that prefix the financial transaction summaries on [Payment - Main](#).

Description of page

Payment Id is the system-assigned unique identifier of the payment.

Account ID is the payment's account.

The area beneath **AccountID** provides you with options that control which financial transactions appear in the grid. The following points describe the various options:

- Use the **SA Filter** to define the types of service agreements whose financial transactions appear in the grid. The following options are available:
 - **Address.** Use this option to restrict financial transactions to those whose service agreements are linked to service points associated with a given **Address, City** and/or **Postal** code.
 - **All.** Use this option if you do not wish to restrict financial transactions based on service agreement attributes.

- **Geographic Type.** Use this option to restrict financial transactions to those whose service agreements are linked to service points associated with a given **Geo Type** and **Value**.
- **SA ID.** Use this option to restrict financial transactions to those of a specific service agreement.
- **SA Type.** Use this option to restrict financial transactions to those whose service agreements are linked to a given **CIS Division** and **SA Type**.
- Use **Match Event Status Filter** to restrict the financial transactions based on the status of their [match event](#). This filter only appears if the payment's account is an [open-item](#) customer. The following options are available:
 - **All.** This option shows all financial transactions.
 - **Balanced.** This option shows all financial transactions whose match event is balanced.
 - **Disputed.** This option shows all financial transactions whose match event is disputed.
 - **Unbalanced.** This option shows all financial transactions whose match event is unbalanced.
 - **Unmatched.** This option shows all financial transactions that are not linked to a match event.

WARNING:

Don't forget to click the search button after changing the filters or after selecting a new Payment Id.

The grid that follows contains the financial transactions that match your search criteria. The following information is displayed:

- **Match Event Status** shows the status of the financial transaction's [match event](#). This column only appears if the account is an [open-item](#) customer.
- **FT Type** displays the type of financial transaction. Click on the hyperlink to transfer to [Financial Transaction - Main](#). On this page, you can change certain aspects of the FT in question.
- **Accounting Date** is the date the system uses to determine the financial transaction's accounting period in your general ledger.
- **Current Amount** contains the financial transaction's effect on the service agreement's current balance.
- **Payoff Amount** contains the financial transaction's effect on the service agreement's payoff balance. The **Payoff Amount** will be dim if it equals the **Current Amount**.
- **Show on Bill** indicates if information about the financial transaction appears on the customer's bill.
- **SA Information** contains a summary of the respective service agreement.
- **Financial Transaction ID** is the system-assigned unique identifier of the financial transaction.

At the bottom of the page is a summary of the financial transactions that match the search criteria.

Payment History

The payment history page shows all payments that have been distributed to an account's service agreements. Open this page using **Menu > Financial Query > Account Payment History**.

Description of Page

One row is displayed for every payment that has been distributed to an account's service agreements. The payment date, amount, payment status and the tender source associated with the tender's tender control are displayed for each payment.

NOTE:

Tender Source typically contains the description of the cash drawer in which the payment was made or the remittance processor that processed the payment. **Tender source** will be blank for automatic payments until they are interfaced to

the financial institution. Refer to [Downloading Automatic Payments](#) for more information about interfacing automatic payments.

If you need to see more detailed information about the payment, click the Go To button to transfer to the payment event page.

Payment Tender History

The **Payment Tender History** page shows a list of all tenders linked to an open tender control for the current user. Open this page using **Menu > Financial Query > Payment Tender History**.

Description of Page

One row is displayed for every tender that is linked to an open tender control to which the current user has access. The freeze date/time, payor account id, name, tender amount, tender type, pay tender id, tender status and payment date are displayed for each tender.

Payment / Tender Search

This page allows you to look for payments and/or tenders using a combination of search criteria. Open this page using **Menu > Financial Query > Payment / Tender Search**.

Description of Page

The top half of the page is where you enter the criteria used to search for payments and tenders.

NOTE:

Multiple search criteria may be specified. You can search for payments and tenders using a combination of search criteria. For example, if you enter both a **Payment Account** name of Brandon and a **Payment Amount** between 150 and 170; only those payments for customers named Brandon whose amount is between 150 and 170 will be displayed.

WARNING:

Try to be as specific as possible when entering search criteria. Why? Because entering open-ended search criteria may have a severe impact on response times. For example, if you know the payments you're looking for have a payment date sometime in January 2003 and the customer's name is Brazil,John, then enter both of these criteria. If you also know the payment amount is between 150 and 170, enter these values too.

The following table describes each of the different search methods.

Search Method	Description
Search for	Use this field to define if you're searching for Payments, Tenders or both Payments and Tenders. The value entered in this field controls which of the remaining search methods are enabled.
Distribution Rule	Use this field if you're searching for a tender or a payment and know the distribution rule and value used to created it. Note. This section appears only if you have configured your system to allow the payment event distribution rules method to be used.

Payment Account

Use this field if you're searching for a payment and know the account ID or the name of any person linked to the account whose debt is relieved by the payment.

- If you know the payment's account ID, first choose Account in the adjacent dropdown and then enter the account's ID. You must enter all of the account ID.

- If you know the name of any person linked to the account, first choose Person Name in the adjacent dropdown and then enter the person's name. You can enter all or part of the person's name (the more you enter, the faster the search will be). The name search is not case sensitive.

A search method of Person Name defaults.

If you leave the person name or ID blank, the system ignores this search method.

These fields are protected if you've selected a **Search for** of Tender.

Payment Amount

Use this field if you're searching for a payment and know its amount.

- If you know the exact amount, first choose Equal To in the adjacent dropdown and then enter the amount.

- If you know the payment amount is between a given range of values, first choose Between and then enter the range of values.

A search method of Between defaults.

If you leave the amount(s) blank, the system ignores this search method.

These fields are protected if you've selected a **Search for** of Tender.

Payor Account

Use this field if you're searching for a tender and know the account ID or the name of any person linked to the tendering account.

- If you know the tender's account ID, first choose Account in the adjacent dropdown and then enter the account's ID. You must enter all of the account ID.

- If you know the name of any person linked to the tendering account, first choose Person Name in the adjacent dropdown and then enter the person's name. You can enter all or part of the person's name (the more you enter, the faster the search will be). The name search is not case sensitive.

A search method of Person Name defaults.

If you leave the person name or ID blank, the system ignores this search method.

These fields are protected if you've selected a **Search for** of Payment.

Tender Amount

Use this field if you're searching for a tender and know its amount.

- If you know the exact amount, first choose Equal To in the adjacent dropdown and then enter the amount.

- If you know the tender amount is between a given range of values, first choose Between and then enter the range of values.

A search method of Between defaults.

If you leave the amount(s) blank, the system ignores this search method.

	These fields are protected if you've selected a Search for of Payment.
Tender Source	<p>If you're searching for a tender and you know the source of the tender (e.g., the lockbox, cashier, etc.), enter the tender source code.</p> <p>A search method of Equal To defaults.</p> <p>If you leave the tender source blank, the system ignores this search method.</p>
MICR ID	<p>These fields are protected if you've selected a Search for of Payment.</p> <p>Use this field if you're searching for a tender and know its MICR (magnetic ink character recognition) ID.</p> <ul style="list-style-type: none"> - If you know the entire MICR ID, first choose Equal To in the adjacent dropdown and then and enter the entire MICR ID. - If you know the first X characters of the MICR ID, first choose Like in the adjacent dropdown and then and enter the entire MICR ID. <p>A search method of Like defaults.</p> <p>If you leave the MICR ID blank, the system ignores this search method.</p>
Payment Date	<p>These fields are protected if you've selected a Search for of Payment.</p> <p>Use this field if you're searching for a tender or a payment and know its date.</p> <ul style="list-style-type: none"> - If you know the exact date, first choose Equal To in the adjacent dropdown and then enter the date. - If you know the date is between a given range of values, first choose Between and then enter the date range. <p>A search method of Between defaults.</p> <p>If you leave the date(s) blank, the system ignores this search method.</p>

The system shows the total number of payments / tenders that satisfy your search results immediately below the grid.

The first group of payments / tenders is displayed in the grid at the bottom of the page. Different columns appear in the grid depending on the value of **Search for**.

- If you use a **Search for** of Payment, only payment-oriented columns appear in the grid.
- If you use a **Search for** of Tender, only tender-oriented columns appear in the grid.
- If you use a **Search for** of Payment and Tender, both payment-oriented and tender-oriented columns appear in the grid.

WARNING:

If you use the Payment and Tender search method, and the resultant tenders / payments are linked to payment events that have multiple payments or tenders, multiple rows may be displayed for the payment event's tenders and payments. For example, if a tender with multiple payments is selected, a separate row will be displayed for every payment that matches your payment search criteria. If you don't specify any payment search criteria, a row will be displayed for every payment linked to the tender.

Payment Date This contains the date of the payment event associated with the payment / tender. This column appears regardless of the value of **Search for**.

Payment Account Info This contains a concatenation of important information about the account whose debt was relieved by the payment. This column does not appear if you use a **Search for** of Tender .

Payment Amount This contains the amount of the payment. This column does not appear if you use a **Search for** of Tender.

Payment Status This contains the status of the payment. Refer to [Payment Lifecycle](#) for more information. This column does not appear if you use a **Search for** of Tender.

Payment ID This contains the unique identifier of the payment. This column does not appear if you use a **Search for** of Tender.

Payor Account Info This contains a concatenation of important information about the account who tendered the payment. This column does not appear if you use a **Search for** of Payment .

Tender Amount This contains the amount of the tender. This column does not appear if you use a **Search for** of Payment.

Tender Source This contains the source of the tender of the tender. This column does not appear if you use a **Search for** of Payment.

MICR ID This contains the MICR (magnetic ink character recognition) ID of the tender. This column does not appear if you use a **Search for** of Payment .

NOTE: The system supports encryption for MICR ID. If your implementation has configured the system to encrypt MICR ID, the data will be displayed with a masked value; such as, *****. Refer to [Encrypting Sensitive Data](#) for more information.

Tender Status This contains the status of the tender. Refer to [Tender Lifecycle](#) for more information. This column does not appear if you use a **Search for** of Payment.

Pay Tender ID This contains the unique identifier of the tender. This column does not appear if you use a **Search for** of Payment.

Pay Event ID This contains the unique identifier of the payment event.

Maintaining Deposit Controls

Deposit controls exist to give you administrative control over your cash drawers (and all other tender sources) and the subsequent deposit of funds at banks.

FASTPATH:

Refer to [Tender Management and Workstation Cashiering](#) for background information.

NOTE:

The system creates most deposit controls behind-the-scenes. Most deposit controls are created by the system when it processes tenders from your remittance processor and lock boxes. You should only have to access the deposit control pages if you record payments in cash drawers. For information about how the system creates deposit controls, refer to [Managing Payments Interfaced From External Sources](#). Also note that the automatic payment activation process also creates tender and deposit controls. Refer to [Activating Automatic Payments](#) for more information.

The Lifecycle Of A Deposit Control

The following diagram shows the possible lifecycle of a deposit control.

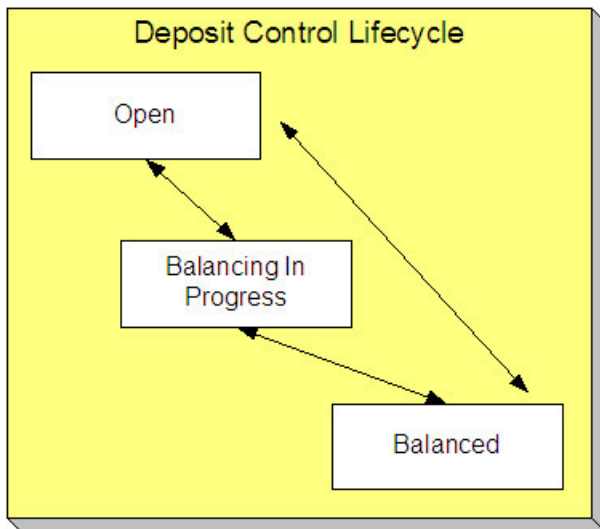

Open A deposit control is initially created in the Open state. While in this state, you may add new deposits to it, change the deposit amount on its deposits, and transfer tender controls into and out of it.

Balancing In Progress You change a deposit control's status to Balancing In Progress when you're ready to balance its contents. While in this state, you can change the deposit amount on its deposits and transfer tender controls out of it. If you need to add new deposits to it or transfer tender controls into it you must return it to the Open state.

Balanced You change a deposit control's status to Balanced when the sum of its tender controls is consistent with the total of its deposits. While in this state, you cannot modify its deposits or its tender controls. If you need to make modifications, you must return it to the Open or Balancing In Progress state.

NOTE:

Background processes and state transition. When payments are interfaced from external sources, the system automatically creates a deposit control and links a tender control to it. When all payments have been successfully loaded, the system changes the state of the respective deposit control to Balanced.

Deposit Control - Main

The Main page contains core deposit control information. Open this page using **Menu > Financial > Deposit Control > Search**.

Description of Page

Deposit Control contains a concatenation of the deposit control's creation date, tender source type, and status.

Deposit Control ID is the system-assigned, unique identifier of the deposit control.

User is the person who created the deposit control.

Create Date/Time is the date and time the deposit control was created.

Tender Source Type is the type of tender control that has been linked to the deposit control. Valid values are: Ad hoc, Auto Pay, Online Cashiering and Lockbox. The system uses this information to prevent tender controls from different sources from being included under the same deposit control. In other words, you can't mix automatic payment, cashiering and lockbox tenders under the same deposit control.

Currency Code is the currency in which the deposit control's tenders are denominated.

NOTE:

Default note. The currency code defaults from the installation record.

The summary information that follows contains a summary of the starting balance and the tenders that are linked to the tender control.

- **Starting Balance** is the sum of the starting balances from all tender controls linked to the deposit control.
- **Total TendersAmount** is the sum of tenders from all tender controls linked to the deposit control.
- **Total Tender Controls** is the number and amount of tender controls linked to the deposit control.
- **Total Tender Deposits** is the number and amount of tender deposits linked to the deposit control.
- **Expected Ending Balance** is the **Total Tender Control** minus **Total Tender Deposits**.
- **Ending Balance** is the actual amount of money in the tender control minus the deposit tender amount. This amount must equal the **Expected Ending Balance** before the tender control can be marked as **Balanced**.
- **Outstanding Over/Under** is **Ending Balance** minus **Expected Ending Balance**.

Deposit Control Status shows the status of the deposit control. Valid values are Open, Balanced, and Balancing In Progress.

FASTPATH:

For more information, refer to [The Lifecycle Of A Deposit Control](#).

The **Balanced User ID** and **Balanced Date/Time** are populated when the status is changed to **Balanced**.

Use **Comments** to describing anything unusual about the deposit control.

Deposit Control - Tender Control

The Tender Control page contains a row for every tender control linked to the deposit control. Open this page using **Menu > Financial > Deposit Control > Search** and navigate to the **Tender Control** page.

Description of Page

Deposit Control contains a concatenation of the deposit control's creation date, tender source type, and status.

Deposit Control ID is the system-assigned, unique identifier of the deposit control.

The grid that follows contains a row for every tender control linked to the deposit control. No information about the tender controls may be modified on this page. To view or modify tender control information, click the **Go To** button.

Deposit Control - Tender Deposit

The Tender Deposit page contains a row for every tender deposit linked to the deposit control. Open this page using **Menu > Financial > Deposit Control > Search** and navigate to the **Tender Deposit** page.

Description of Page

Deposit Control contains a concatenation of the deposit control's creation date, tender source type, and status.

Deposit Control ID is the system-assigned, unique identifier of the deposit control.

The **Tender Deposit** scroll that follows contains one row for every financial institution into which the tenders will be deposited. To insert a new row, click the + button and fill in the following fields:

- **Tender Deposit ID** is maintained by the system. When a deposit is being created, there is no ID number displayed. Once a deposit is entered and saved, the system generates an ID and displays it here.

- **Deposit Amount** contains the amount to be deposited at the bank. **Currency Code** is the currency in which the deposit is denominated.
- **Reference ID** contains the ID of the deposit (if any).
- Use **Bank** and **Bank Account** to define where the tenders will be deposited.

Deposit Control - Turn Ins

The Turn Ins page contains a row for every turn-in event linked to the deposit control. Open this page using **Menu > Financial > Deposit Control > Search** and navigate to the **Turn Ins** page.

FASTPATH:

Refer to [Turn Ins](#) for background information.

Description of Page

Deposit Control contains a concatenation of the deposit control's creation date, tender source type, and status.

Deposit Control ID is the system-assigned, unique identifier of the deposit control.

The turn-ins grid contains one row for every turn-in event associated with the deposit control. A turn-in event is created when moneys originally deposited in respect of a tender control are turned in to the tender control's deposit control. Turn-in events are created and maintained on the [Tender Control - Turn Ins](#) page. Refer to [Turn Ins](#) for background information. The following information is displayed in the grid:

- **Turn In Status** defines if it is a new turn in Awaiting approval or has been Approved by the operator who is responsible for the Deposit Control. Once the turn-in is Approved, this field becomes display-only.
- **Tender Type** is the type of tender that has been turned in. This is a display-only field.
- **Turn In Amount** is the amount of the **Tender Type** that has been turned in. This is a display-only field.
- **Receipt Number** is the ID of the receipt given to the person who turn-in the funds. This is a display-only field.
- **Create Date/Time** contains when the turn-in event was created. This is a display-only field.

Deposit Control - Characteristics

To update deposit control characteristics, open **Menu > Financial > Deposit Control > Search** and navigate to the **Characteristics** page.

Description of Page

Deposit Control contains a concatenation of the deposit control's creation date, tender source type, and status.

Deposit Control ID is the system-assigned, unique identifier of the deposit control.

The **Characteristics** collection contains information that describes miscellaneous information about the deposit control.

The following fields display:

Characteristic Type Indicate the type of characteristic.

Sequence Controls the order in which characteristics of the same type are displayed.

Characteristic Value Indicate the value of the characteristic.

Maintaining Tender Controls

Tender controls exist to give you administrative control over your cash drawers (and all other tender sources).

FASTPATH:

Refer to [Managing Your Cash Drawers](#) for more information.

NOTE:

The system creates most tender controls behind-the-scenes. Most tender controls are created by the system when it processes tenders from the remittance processors and lock boxes. You should only have to access the tender control pages if you record payments in cash drawers. For information about how the system creates tender controls, refer to [Managing Payments Interfaced From External Sources](#). Also note that the automatic payment activation process also creates tender and deposit controls. Refer to [Activating Automatic Payments](#) for more information.

The Lifecycle Of A Tender Control

The following diagram shows the possible lifecycle of a tender control.

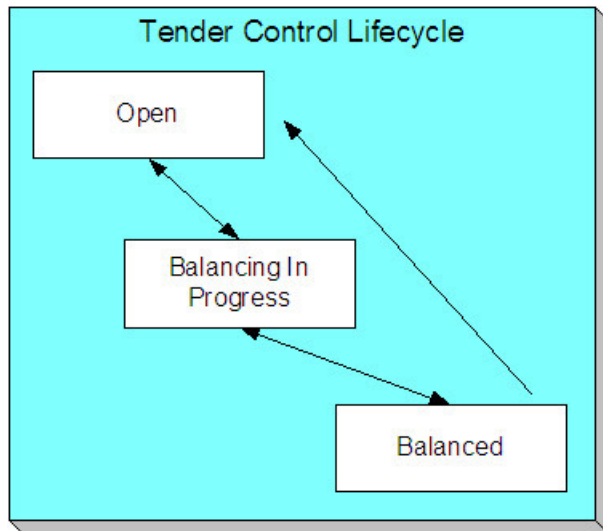

Open A tender control is initially created in the Open state. While in this state, you may add new tenders to it, change the tender amount on its tenders, and transfer tenders into and out of it.

Balancing In Progress You change a tender control's status to Balancing In Progress when you're ready to balance its contents. While in this state, you can change the tender amount on its tenders and transfer tenders out of it. If you need to add new tenders to it or transfer tenders into it, you must return it to the Open state.

Balanced You change a tender control's status to Balanced when the sum of its tenders is consistent with the ending balance in the drawer. While in this state, you cannot modify it or its tenders. If you need to make modifications, you must return it to the Open or Balancing In Progress state.

If the tender control is part of a Balanced deposit control, you may not change its status.

NOTE:

Background processes and state transition. When payments are interfaced from external sources, the system automatically creates a tender control and links tenders to it (one for each payment interfaced). When all payments have been successfully loaded, the system changes the state of the respective tender control to Balanced.

Tender Control - Main

The Main page contains core tender control information. This page is used to balance the tender control.

Open this page using **Menu > Financial > Tender Control > Search.**

NOTE:

Searching For Tender Controls. When you use the **Creation Date** to search for tender controls, the system returns tender controls that are created on or before the date you specify. If the number of records returned exceeds the search limit (i.e. 300 records), only the records that do not exceed search limit are displayed. Therefore, you may need to specify an earlier creation date to find the record you are looking for. If you do not specify a creation date and search based on other criteria, the system uses the most recent date.

FASTPATH:

Refer to [Managing Your Cash Drawers, Turn Ins](#) and [Balancing By Tender Type](#) for more information.

Description of Page

Tender Control contains a concatenation of the tender control's creation date, tender source, and status.

Tender Control ID is the system-assigned, unique identifier of the tender control.

Tender Source is the source of the tenders (e.g., cash drawer 22, lockbox 1 at Bank of America).

Deposit Control ID is the system-assigned, unique identifier of the deposit control that the tender control is part of. The deposit control's **Currency Code** is displayed below.

FASTPATH:

For more information about deposit controls and tender controls, refer to [Managing Your Cash Drawers](#).

Turn on **All Users** if any user may insert tenders into this tender control. Turn this switch off and specify the appropriate **User ID** if only a single user may insert tenders into this tender control.

Create Date/Time is the date and time the tender control was created.

The **Starting Balance** of the tender control is defaulted from the tender source. This may be overridden while the **Tender Control Status** is Open or Balancing in Progress.

The **Tender Control Status** shows the status of the tender control. The **Balanced User ID** and **Balanced Date/Time** are populated when the status is changed to Balanced.

FASTPATH:

For more information, refer to [The Lifecycle Of A Tender Control](#).

The **Balance** button is enabled when the **Tender Control Status** is Balancing in Progress. When this button is clicked, the system checks the following:

- All Turn-Ins have been Approved.
 - The sum of all **Ending Balances** equals the sum of all **Expected Ending Balances**.
-

If the above conditions are true, the status of the tender control is changed to Balanced and all modifiable fields become protected.

The tenders grid contains a summary of the tenders linked to the tender control. One row is displayed for each tender type. Each row contains the number of tenders of this type and their total amount. In order to Balance the tender control, you must enter an appropriate **Ending Balance** for each **Tender Type**. Refer to [Balancing By Tender Type](#) for more information. The following information appears in the grid:

- **Tender Type** represents the type of tender (e.g., cash, credit card). This is a display-only field.
- **Nbr of Tenders** contains the total number of tenders of this type in the tender control. This is a display-only field and is calculated by the system by accumulating the tenders linked to the tender control.
- **Total Tenders** contains the total amount of tenders of this type in the tender control. This is a display-only field and is calculated by the system by accumulating the tenders linked to the tender control. Navigate to the **Tenders** page to see the individual tenders.
- **Turn In Amount** contains the total amount of turn-ins of this type. This is a display-only field and is calculated by the system by accumulating the turn-ins linked to the tender control. Navigate to the **Turn Ins** pages to see the individual turn ins.
- **Starting Balance** contains the starting balance of this type of turn in. This field is only populated on the row defined as the Starting Balance tender type on the Installation Record. This is a display-only field and is equal to the tender control's **Starting Balance**.
- **Expected Ending Bal** is the **Starting Balance** plus **Total Tenders** minus **Turn In Amount** for this type of tender.
- **Ending Bal** is the actual amount of money of this tender type. The cashier must enter this field in order to balance the tender control. This field is protected unless the **Status** of the tender control is Balancing In Progress. This amount must equal the Expected Ending Balance before the tender control can be marked as Balanced. Refer to [How To Get An Unbalanced Tender Control In Balance \(Fixing Over/Under\)](#) for more information.
- **Outstanding Over/Under** is the difference between **Expected Ending Bal** and **Ending Bal**. This is a display-only field.

The summary information beneath the tender type grid contains a summary of the tenders that are linked to the tender control.

- **Total TenderAmount** is the total amount of all tenders linked to the tender control.
- **Ending Balance** is the actual amount of money in the tender control (as defined in the above grid).
- **Expected Ending Balance** is the expected amount of money in the tender control (as defined in the above grid).
- **Outstanding Over/Under** is Ending Balance minus Expected Ending Balance. If this amount is zero, the field is not displayed.

If the tender controls were created for a background process, such as the automatic payment extract, the following information is displayed:

- **Batch Code** is the batch code for which the tender control was created. This field only appears if it contains a value.
- **Batch Number** is the batch number for which the tender control was created. This field only appears if it contains a value.

Use **Comments** to describe anything unusual about the tender control (e.g., to explain why a large over/under amount was created).

Tender Control - Tenders

The Tenders page contains a row for every tender linked to the tender control. Open this page using **Menu > Financial > Tender Control > Search** and navigate to the **Tenders** page.

Description of Page

Tender Control contains a concatenation of the tender control's creation date, tender source, and status.

Tender Control ID is the system-assigned, unique identifier of the tender control.

This grid at the top of the page contains a row for every tender linked to the tender control. When first displayed, the grid is ordered by the Create Date/Time column. No information about the tenders may be modified. To view or modify tender information, click the Go To button.

The grid at the bottom of the page contains a summary by tender type of all tenders linked to the tender control.

Tender Control - Turn Ins

Every time you turn in funds to the deposit control that is associated with your tender control, you create a turn-in event using this page. Open this page using **Menu > Financial > Tender Control > Search** and navigate to the **Turn Ins** page.

FASTPATH:

Refer to [Managing Your Cash Drawers](#) and [Turn Ins](#) for more information.

Description of Page

Tender Control contains a concatenation of the tender control's creation date, tender source, and status.

Tender Control ID is the system-assigned, unique identifier of the tender control.

The turn-ins grid contains one row for every turn-in event associated with the tender control. A turn-in event is created when moneys are physically transferred to the deposit control associated with the tender control. Turn-in events are approved on the [Deposit Control - Turn Ins](#) page. The following information is displayed in the grid:

- **Turn In Status** defines if the turn-in is Awaiting Approval or has been Approved by the operator who is responsible for the Deposit Control. When a turn-in is first created, its status is Awaiting Approval and the following fields should be defined. Once the turn-in is Approved by the user responsible for the deposit control associated with the tender control, all of the following fields become display-only and the turn-in event cannot be deleted.
- **Tender Type** is the type of tender that has been turned in. This field may only be modified when the **Turn In Status** is Awaiting Approval.
- **Turn In Amount** is the amount of the **Tender Type** that has been turned in. This field may only be modified when the **Turn In Status** is Awaiting Approval.
- **Receipt Number** is the ID of the receipt given to the person who turn-in the funds. This field may only be modified when the **Turn In Status** is Awaiting Approval.
- **Create Date/Time** contains when the turn-in event was created. This is a display-only field.

Tender Control - Exceptions

This page contains an entry for every exception (i.e., error) associated with the tender control's payments and payment events. Open this page using **Menu > Financial > Tender Control > Search** and navigate to the **Exceptions** page.

FASTPATH:

Refer to [Exceptions](#) for more information.

Description of Page

This page contains an entry for every exception (i.e., error) associated with the tender control's payments and payment events.

Tender Control - Characteristics

To update tender control characteristics, open **Menu > Financial > Tender Control > Search** and navigate to the **Characteristics** page.

NOTE:

If your tender control is balanced, you cannot update tender control characteristics.

Description of Page

The **Characteristics** collection contains information that describes miscellaneous information about the tender control.

The following fields display:

Characteristic Type Indicate the type of characteristic.

Sequence Controls the order in which characteristics of the same type are displayed.

Characteristic Value Indicate the value of the characteristic.

Interfacing Payments From External Sources

Most payments are NOT added by an operator using the Payment Event page. Rather, they are interfaced from an external source (e.g., a lock box or a remittance processor).

The base-package provides two interfaces to upload payments, each based on a different method of creating payment events.

FASTPATH:

Refer to [Distributing A Payment Event](#) for more information about how payment event distribution is handled in the system.

The topics in this section describe how these payment interfaces work.

Interfacing Payments

The topics in this section describe how the payment interface using the system default method of creating payment events works.

Populating The Payment Upload Staging Records

The following diagram illustrates the processes involved in the uploading of payment into the system.

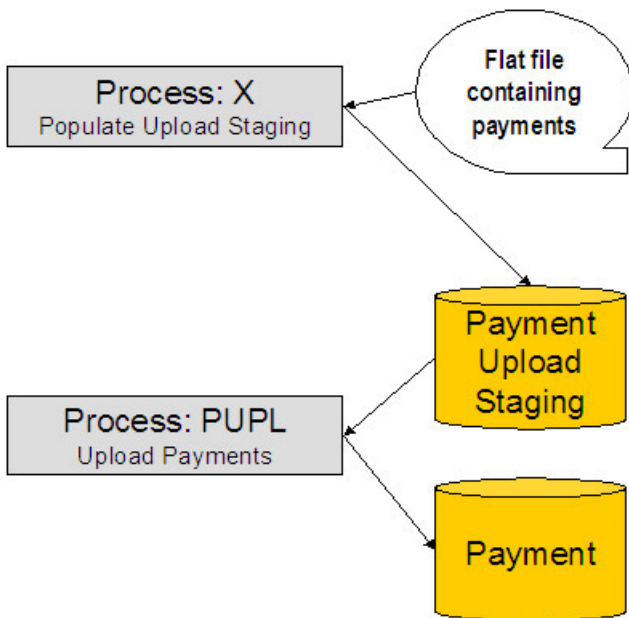

The topics in this section describe each background process referenced above.

Process X - Populate Payment Upload Staging

Process X refers to the mechanism used by your organization to populate the various staging tables (shown in the orange section of the following ERD).

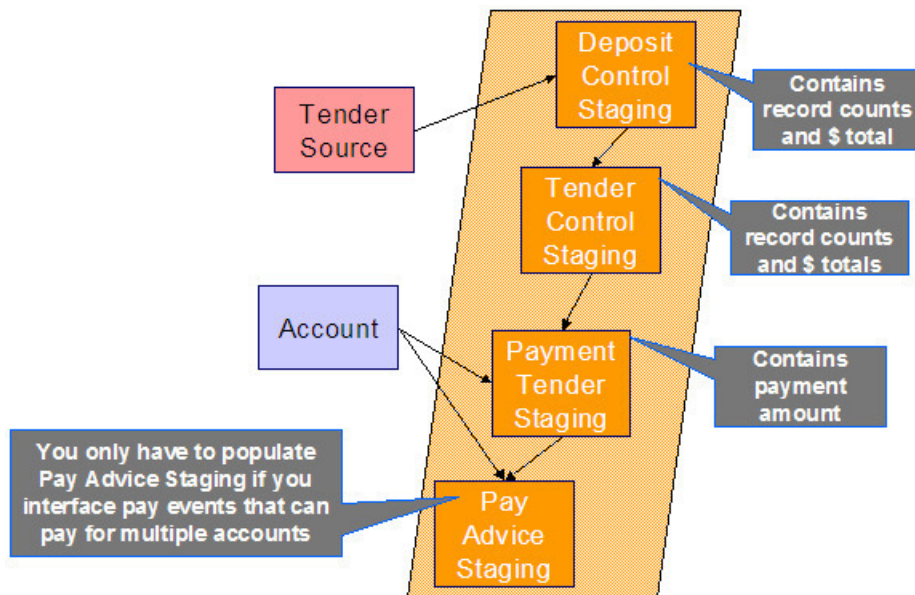

The following topics in this section describe each of these tables:

- [Deposit Control Staging](#)
- [Tender Control Staging](#)
- [Payment Tender Staging](#)
- [Payment Advice Staging](#)

Deposit Control Staging

You must create a deposit control staging record for each batch of payments to be uploaded into the system. The name of this table is CI_DEP_CTL_ST. The following table describes each column on this table.

Column Name	Length	Req'd	Data Type	Comments
EXT_SOURCE_ID	30	Y	A/N	This must correspond with an external source ID on one of the defined tender sources. Refer to Setting Up Tender Sources for more information.
EXT_TRANSMIT_ID	50	Y	A/N	This is the unique identifier of the transmission from the external source. This must be a unique value for each transmission from the source.
DEP_CTL_STG_ST_FLG	2	Y	A/N	This must be set to 20 (20 is the lookup value that corresponds with the Pending state)
DEP_CTL_ID	10	N	N	Leave this column blank. It will be assigned by the system when it creates a deposit control record.
TRANSMIT_DTTM	15	Y	DateTime	Date and time that the file was transmitted.
CURRENCY_CD	3	Y	A/N	This must be a valid currency code (this would be USD for United States dollars).
TOT_TNDR_CTL_AMT	13.2	Y	N	This column must equal the sum of the payment amounts on the tender control staging records associated with this deposit control staging.
TOT_TNDR_CTL_CNT	10	Y	N	This column must equal the number of tender control staging records associated with this deposit control staging.
LAST_UPDATE_INST	10	N	N	This field is populated during the upload. It is the process scheduler instance ID of the process performing the upload.

You must create one or more [Tender Control Staging](#) for this deposit control staging record.

[Top of Page](#)

Tender Control Staging

You must create at least one tender control staging record for each batch of payments to be uploaded into the system. The name of this table is CI_TNDR_CTL_ST. The following table describes each column on this table.

Column Name	Length	Req'd	Data Type	Comments
EXT_SOURCE_ID	30	Y	A/N	This must correspond with the external source ID on the parent deposit control staging record.
EXT_TRANSMIT_ID	50	Y	A/N	This must correspond with the external transmission ID on the parent deposit control staging record.
EXT_BATCH_ID	30	Y	A/N	This is the unique identifier of the batch of payments in respect of the external transmission ID.
TNDR_CTL_STG_ST_FLG	2	Y	A/N	This must be set to 20 (20 is the translate value that corresponds with the Pending state)
TNDR_CTL_ID	10	N	N	Leave this column blank. It will be assigned by the system when it creates a tender control record.
TOT_TNDR_AMT	13.2	Y	N	This column must equal the sum of the payment amounts on the payment tender staging records associated with this tender control staging.
TOT_TNDR_CNT	10	Y	N	This column must equal the number of payment tender staging records associated with this tender control staging.

You must create one or more [Payment Tender Staging](#) records for this tender control staging record.

[Top of Page](#)

Payment Tender Staging

You must create at least one payment tender staging record for each payment associated with the tender control staging record. The name of this table is CI_PAY_TNDR_ST. The following table describes each column on this table.

Column Name	Length	Req'd	Data Type	Comments
EXT_SOURCE_ID	30	Y	A/N	This must correspond with the external source ID on

				the parent deposit control staging record.
EXT_TRANSMIT_ID	50	Y	A/N	This must correspond with the external transmission ID on the parent tender control staging record.
EXT_BATCH_ID	30	Y	A/N	This must correspond with the external batch ID on the parent tender control staging record.
EXT_REFERENCE_ID	30	Y	A/N	This is the unique identifier of the payment in respect of the external batch ID.
PAY_TND_STG_ST_FLG	2	Y	A/N	This must be set to 10 (10 is the translate value that corresponds with the Pending state)
PAY_TENDER_ID	12	N	N	Leave this column blank. It will be assigned by the system when it creates a tender record.
TENDER_AMT	13.2	Y	N	The amount tendered (i.e., the payment amount).
ACCOUNTING_DT	10	Y	Date	This is the date that should be used for accounting purposes. This should correspond with an open accounting period.
TENDER_TYPE_CD	4	Y	A/N	This must correspond with the prime key of one of your tender types. Refer to Setting Up Tender Types for more information.
CUST_ID	15	Y	A/N	This is the account ID or old account number of the customer tendering the payment. If the system cannot find an account ID or old account number that matches this value, the account ID of the tender source's suspense SA will be used on the corresponding tender and payment.

MICR_ID	30	N	A/N	This is the MICR ID associated with the payment.
NAME1	40	N	A/N	This is the customer name on the payment.
CHECK_NBR	10	N	A/N	This is the check number on the payment.

[Top of Page](#)

Payment Advice Staging

You need only populate rows on this table if any of the following conditions apply:

- If you need to distribute a payment tender to an account other than that defined with the CUST_ID on the payment tender staging record, you must create a payment staging record. You may distribute a tender to multiple accounts by creating multiple payment staging records. Note, if you want to distribute the payment tender to the same account, you do NOT need a payment staging record.
- If you want to restrict a payment to a specific service agreement, you must insert a row on this table to indicate the specific the service agreement in question. You do this by populating MATCH_TYPE_CD with a value that indicates that you are paying for a specific service agreement and MATCH_VALUE with the unique ID of the service agreement.
- If you practice [open-item accounting](#), you must insert a row on this table for each to indicate the open-item to which the payment should be matched. Note, because open-item customer typically match payments to bills, you would populate MATCH_TYPE_CD with a value to indicate that you are matching by bill ID and MATCH_VALUE with the unique ID of the bill.

The name of this table is CI_PAY_ST. The following table describes each column on this table.

Column Name	Length	Req'd	Data Type	Comments
EXT_SOURCE_ID	30	Y	A/N	This must correspond with the external source ID on the parent payment tender staging record.
EXT_TRANSMIT_ID	50	Y	A/N	This must correspond with the external transmission ID on the parent payment tender staging record.
EXT_BATCH_ID	30	Y	A/N	This must correspond with the external batch ID on the parent payment tender staging record.
EXT_REFERENCE_ID	30	Y	A/N	This must correspond with the external reference ID on the parent payment tender staging record.
CUST_ID	15	Y	A/N	This is the account ID or old account number of the customer to which the payment should be distributed. If the system cannot find an account ID or old account number

that matches this value, the account ID of the payor is used on the corresponding payment. If the payor's account ID is invalid, the tender source's suspense SA is used.

PAY_AMT	13.2	Y	N	The amount tendered (i.e., the payment amount).
MATCH_TYPE_CD	8	N	A/N	See the description of the MATCH_VALUE field below. Refer to Payments And Match Events for more information about the significance of this field.
MATCH_VALUE	30	N	A/N	MATCH_VALUE and MATCH_TYPE_CD are used in conjunction to indicate that the distribution of the payment should be restricted in some way (i.e., the standard payment distribution algorithm should not be used). MATCH_TYPE_CD indicates how the payment should be distributed (e.g., only distribute to a specific service agreement), MATCH_VALUE contains the ID of the restriction (e.g., the SA ID). If MATCH_TYPE_CD is specified, it must reference a valid Match Type .

Process PUPL - Upload Payments

The background process (PUPL) loads the contents of the various payment staging records into the various payment event tables. The tables that are populated by this process are shown in the left orange section of the following ERD (the right orange section are the staging tables populated by the process described above)

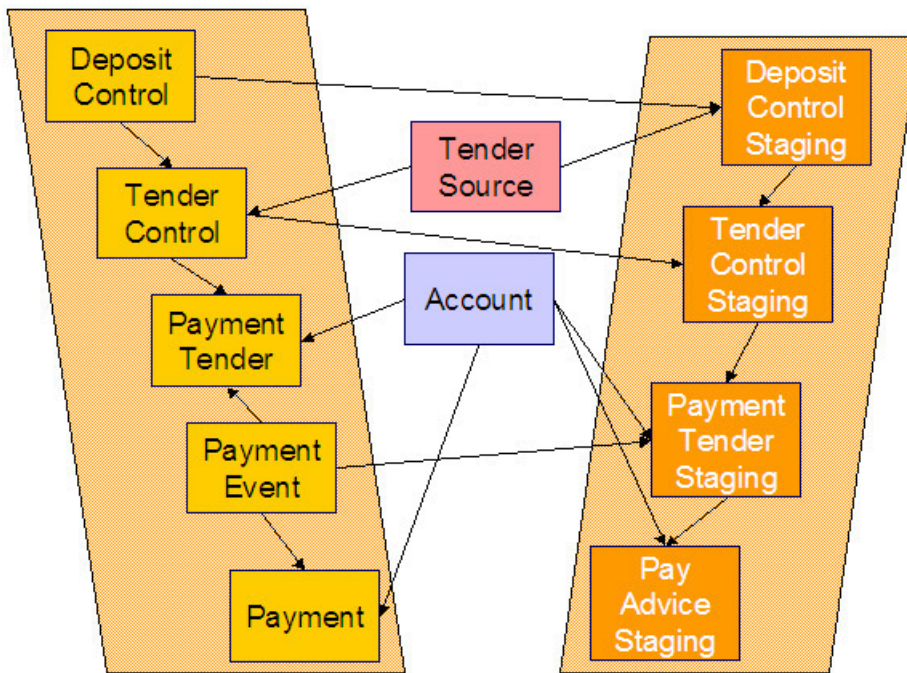

The topics in this section describe how these tables are populated.

[Phase 1 - Create Deposit Control](#)

[Phase 2 - Create Tender Control](#)

[Phase 3 - Create Payment Events, Tenders, Payments, and Payment Segments](#)

Phase 1 - Create Deposit Control

The following points describe, at a high level, the first phase of the payment upload process:

- PUPL checks that the record counts and money totals of tender control stagings add up to the expected amount on deposit control staging. If not,
 - PUPL sets the status of the deposit control staging to be Error . None of the tender controls within the deposit control will be processed until everything adds up. You can fix these on the [Deposit Control Staging](#) page.
 - When PUPL runs next, it will recheck the totals on deposit control stagings that are in Error or Pending
- If the record and dollar amounts are clean,
 - PUPL creates the corresponding deposit control
 - PUPL sets the status of the deposit control staging to be In Progress

[Top of Page](#)

Phase 2 - Create Tender Control

The following points describe, at a high level, the second phase of the payment upload process:

- PUPL checks that record counts and money totals of payment tender staging(s) adds up to expected amount on tender control staging. If not,
 - PUPL sets the status of the tender control staging to be Error . None of the tender controls within the deposit control will be processed until everything adds up for ALL tender controls. You can fix these on the [Tender Control Staging](#) page.

NOTE:

that the Deposit Control Staging record is **not** updated - its status is unchanged. Neither is the Pay Tender Staging record updated - its status also remains unchanged. Only the Tender Control Staging record is updated to be in Error .

- When PUPL runs next, it will recheck the totals of tender control stagings that are in Error or Pending.
- If the record and dollar amounts are clean,
 - PUPL creates the corresponding tender control.
 - PUPL sets the status of the tender control staging to be In Progress .

[Top of Page](#)

Phase 3 - Create Payment Events, Tenders, Payments, and Payment Segments

At this point, all deposit control stagings and tender control stagings are in the state of In Progress. Next, PUPL starts the upload of payment tender staging and payment advice staging. The following points describe, at a high level, this phase of the payment upload process:

- If the payment tender staging record has a future accounting date, the processing for the record is skipped. This prevents uploaded payments from being created and subsequently frozen until their accounting date is reached. (Some external sources may provide advance notification of payments to be made in the future.) A skipped staging record remains in the Pending state until its accounting date is reached.
- PUPL checks money totals of payment advices (if any) adds up to expected amount on payment tender staging.
 - If not, PUPL sets the payment tender staging's status to Error .
 - Any errors are written to the [Payment Upload Exception](#) table. You can fix these errors on the [Payment Upload Staging](#) page and change the record's status back to Pending.
 - When PUPL runs next, it will recheck the totals of the payment tender staging
- If payment tender staging record is clean:
 - PUPL creates a corresponding payment event, tender, and payment.
 - If the account on payment tender staging is wrong, the account on the corresponding tender will be the tender source's suspense SA's account. Refer to [Setting Up Tender Sources](#) for more information. Refer to [How To Transfer A Payment From One Account To Another](#) for how to transfer to payment to the correct account.
 - If the account on payment advice is wrong, the account on the corresponding payment will be the account on the payment tender.
 - PUPL distributes the payment(s) amongst the account's service agreements, and payment segments are created. Note, the payment could be in error if there are no SAs for the account (as well as other reasons). Payments in error are written to the payment exception (CI_PAY_EXCP).
 - PUPL changes the payment tender staging's status to Complete.
- If all payment tender stagings are Complete:
 - PUPL changes the tender control staging's status to Complete.
 - PUPL changes the deposit control staging's status to Complete .
- If there are payment tender staging that are not Complete
 - The status of the tender control staging will still be In progress .
 - The status of the deposit control staging will still be In progress .
- PUPL will attempt to upload the offending payment tender staging records when it next runs.

NOTE: Balancing Control Tables. The balancing of the deposit and tender control tables during payment upload can either be done by PUPL, or after PUPL successfully completes. The latter might be useful for high volume payment uploads that could result in deadlocks on these control tables. If your implementation wishes to execute control table

balancing after PUPL completes, ensure that the necessary batch parameter is set to exclude balancing when PUPL runs and also that the separate balancing batch process (C1-PUBAL) is scheduled after PUPL.

PYUP-PRG - Purge Payment Upload Objects

Completed payment upload staging objects should be periodically purged from the system by executing the [PYUP-PRG](#) background process. This background process allows you to purge all Completed payment upload staging objects older than a given number of days.

We want to stress that there is no system constraint as to the number of Completed payment upload objects that may exist. You can retain these objects for as long as you desire. However we recommend that you periodically purge Completed payment upload objects as they exist only to satisfy auditing and reporting needs.

Maintaining Deposit Control Staging

The Deposit Control Staging page has three purposes:

- You can view historical deposit and tender control staging records associated with uploaded payments.
- You can correct deposit and tender control records that are in error.
- You can add deposit and tender control records to be uploaded by the payment upload background process.

The topics in this section describe this page.

Deposit Control Staging - Main

This page shows the details of a deposit control staging record.

FASTPATH:

Refer to [Populating The Payment Upload Staging Records](#) for more information about this record.

Open this page using **Menu > Financial > Deposit Control Staging > Search.**

Description of Page

External Source ID corresponds with an external source ID on one of the your tender sources. This should be the unique ID of the source of the interfaced payments. Refer to [Setting Up Tender Sources](#) for more information.

External Transmit ID is the unique identifier of the transmission of payments from the external source. This must be a unique value for each transmission from the source.

Status shows the state of the deposit control staging records. Potential values are: Incomplete , Pending, In Progress, Partial Load, Complete, Error.

Deposit Control ID is the system-assigned, unique identifier of the related deposit control. This value is populated after the system creates a deposit control for the upload staging record.

Transmission Date/ Time are when the information was interfaced into the system.

Total Tender Controls must equal the number of tender control staging records associated with this deposit control staging.

Total Tender Control Amount must equal the sum of the payment amounts on the tender control staging records associated with this deposit control staging. The **Currency Code** related to the amount is adjacent.

Deposit Control Staging - Tender Control Staging

This page shows the details of a tender control staging record.

FASTPATH:

Refer to [Populating The Payment Upload Staging Records](#) for more information about this record.

Open this page using **Menu > Financial > Deposit Control Staging > Search** and navigate to the **Tender Control Staging** page.

Description of Page

External Source ID is the external source ID on the parent deposit control staging record.

External Transmit ID is the external transmission ID on the parent deposit control staging record.

The grid that follows contains a row for every tender control staging record linked to the deposit control staging record. The following information is displayed.

External Batch ID This is the unique identifier of the batch of payments in respect of the external transmission ID.

Status This is the state of the tender control staging records. Potential values are: Pending, In Progress, Complete, Error.

Tender Control ID This is the system-assigned, unique identifier of the related tender control. This value is populated after the system creates a tender control for the upload staging record.

Total Tenders Amount This is the sum of the payment amounts on the payment staging records associated with this tender control staging.

Total Number Of Tenders This is the number payment tender staging records associated with this tender control staging.

Payment Upload Staging

The Payment Upload Staging page has three purposes:

- You can view historical payment tender and payment advice staging records associated with uploaded payments.
- You can correct payment tender records that are in error.
- You can add new payment tender and payment advice staging records to be uploaded by the payment upload process.

The topics in this section describe this page.

Payment Upload Staging - Tender Detail

This page shows the details of a payment tender staging record.

FASTPATH:

Refer to [Populating The Payment Upload Staging Records](#) for more information about this record.

Open this page using **Menu > Financial > Payment Upload Staging > Search** to open the **Tender Detail** page.

Description of Page

External Source ID this is the external source ID on the parent tender control staging record.

External Transmission ID is the external transmission ID on the parent tender control staging record.

External Batch ID is the external batch ID on the parent tender control staging record.

Ext. Reference ID is the external source's unique identifier of the payment tender.

Customer ID is the account ID or old account number of the customer tendering the payment. If the system cannot find an account ID or old account number that matches this value, the account ID of the tender source's suspense SA will be used on the corresponding tender and payment.

The **Tender Amount** is the amount tendered (i.e., the payment amount).

Tender Type defines the type of tender. Refer to [Setting Up Tender Types](#) for more information.

NOTE:

Authorizing Tenders. The **Tender Type** dropdown list does not include tender types that require authorization (i.e. credit card payments).

FASTPATH:

For information about tender types requiring authorization, refer to [Credit Card Payments](#).

MICR ID is the MICR ID associated with the tender.

Check Number is the check number on the payment.

Name is the customer's name (as it appeared on the uploaded tender).

Accounting Date is the date that should be used for accounting purposes.

Pay Tender Staging Status shows the state of the tender control staging records. Potential values are: Pending, Complete, Error.

Payment Event ID is the system-assigned, unique identifier of the related payment event. This value is populated after the system creates a payment event for the upload staging record.

Payment Upload Staging - Payment Advice

If a tender was distributed to customers other than that defined on the Tender Detail page, the customers that the tender was distributed to are defined on this page. This page will not contain information if the tender is distributed to the tender detail's customer.

FASTPATH:

Refer to [Populating The Payment Upload Staging Records](#) for more information about this record.

Open this page using **Menu > Financial > Payment Upload Staging > Search** and navigate to the **Payment Advice** page.

Description of Page

External Source ID this is the external source ID on the parent tender control staging record.

External Transmission ID is the external transmission ID on the parent tender control staging record.

External Batch ID is the external batch ID on the parent tender control staging record.

External Reference ID is the external reference ID of the payment tender.

The grid that follows is only populated if the tender is distributed to customer(s) other than the tendering customer. The following information is displayed.

Customer ID This is the account ID or the old account number of the customer to which the payment should be distributed.

Customer Info If the **Customer ID** is an account ID that exists in the system, the name of the primary person and the customer class of the account are displayed here.

Payment Amount This is the amount of the tender to be distributed to the customer.

Match Type and **Match Value** These fields are only used if the distribution of the payment should be restricted in some way (i.e., the standard payment distribution algorithm should not be used). **Match Type** indicates how the payment should be distributed (e.g., only distribute to a specific service agreement), **Match Value** indicates the ID of the restriction (e.g., the service agreement ID). Valid values of **Match Type** are Service Agreement.

Payment Upload Staging- Characteristics

Select **Menu > Financial > Payment Upload Staging > Search** and navigate to the **Characteristics** page.

Description of Page

External Source ID this is the external source ID on the parent tender control staging record.

External Transmission ID is the external transmission ID on the parent tender control staging record.

External Batch ID is the external batch ID on the parent tender control staging record.

Ext. Reference ID is the external source's unique identifier of the payment tender.

Use the characteristics grid to capture additional information about the payment tender staging record.

- Use **Payment Characteristics Entity** to define where each characteristic will be populated on upload. Valid values are: **Payment**, **Payment Event** or **Payment Tender**
- Select a **Characteristic Type** for each payment characteristic entity. You can only choose Characteristic Types defined as permissible for the applicable entity. Refer to [Setting Up Characteristic Types & Their Values](#) for more information.
- Enter a valid **Characteristic Value** for the selected characteristic type. You may enter more than one characteristic row for the same characteristic type, each associated with a unique Sequence number. If not specified, the system defaults it to the next **sequence** number for the characteristic type.

Payment Upload Exception

If errors are detected during the payment upload process, a record is written to the payment upload exception table with a message indicating the nature of the severe error.

To view the messages associated with the exception records, schedule the **TD-PYUPL** background process. This process generates a To Do entry for every record in the payment upload exception table.

You can fix this error using the [Payment Upload Staging](#) page and change the status of the record from Error to Pending. When the payment upload process next runs, it attempts to upload this record again.

Interfacing Payments Using Distribution Rules

The topics in this section describe how the payment interface using distribution rules works.

Populating The Payment Event Upload Staging Records

The following diagram illustrates the processes involved in the uploading of payment event distribution details into the system.

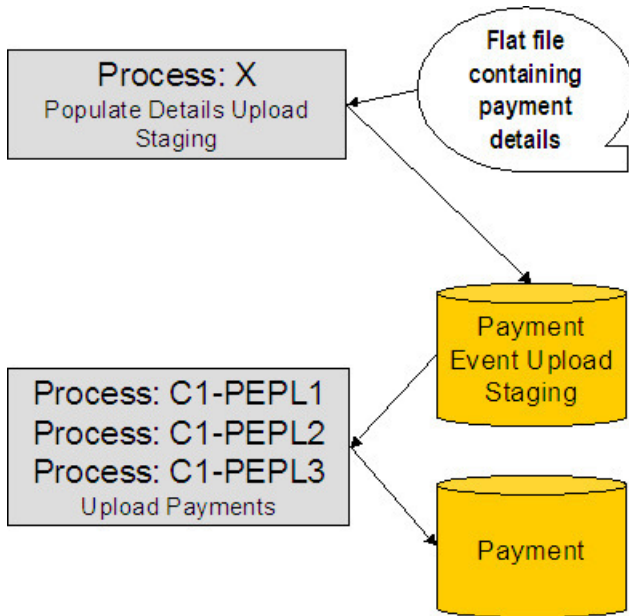

The topics in this section describe each background process referenced above.

Process X - Populate Payment Event Upload Staging

Process X refers to the mechanism used by your organization to populate the payment event upload staging table.

payment Event Upload Staging Table

You must create a payment event upload staging record for each payment distribution detail to be uploaded into the system. The name of this table is CI_PEVT_DTL_ST. The following table describes each column on this table.

Column Name	Length	Req'd	Data Type	Comments
EXT_SOURCE_ID	30	Y	A/N	This must correspond with an external source ID on one of the defined tender sources. Refer to Setting Up Tender Sources for more information.
EXT_TRANSMIT_ID	50	Y	A/N	This is the unique identifier of the transmission from the external source. This must be a unique value for each transmission from the source.
PEVT_DTL_SEQ	12	Y	N	Unique identifier of the detail record within the transmission. The C1-PEPL1 process uses this field to organize the parallel threads.

PEVT_STG_ST_FLG	4	Y	A/N	This must be set to 10 (10 is the lookup value that corresponds with the Incomplete state)
DST_RULE_CD	12	Y	A/N	This must be a valid distribution rule . The distribution rule contains the set of algorithms designed to process the staging detail.
DST_RULE_VALUE	254	Y	A/N	This must be a valid value for the characteristic type defined on the distribution rule.
CURRENCY_CD	3	Y	A/N	This must be a valid currency code (this would be USD for United States dollars).
TENDER_AMT	13.2	Y	N	The amount tendered (i.e., the payment amount).
ACCOUNTING_DT	10	Y	Date	This is the payment date that should be used for accounting purposes. This should correspond with an open accounting period.
TENDER_TYPE_CD	4	Y	A/N	This must be a valid tender type. Refer to Setting Up Tender Types for more information.
CHECK_NBR	10	N	A/N	This is the check number on the payment.
MICR_ID	30	N	A/N	This is the MICR ID associated with the payment tender.
CUST_ID	15	N	A/N	This field may be used to record customer information.
NAME1	30	N	A/N	This field may be used to capture additional payment tender information.
EXT_REFERENCE_ID	30	N	A/N	This field may be used to capture external information associated with the payment tender.
MATCH_TYPE_CD	8	N	A/N	See the description of the MATCH_VALUE field below. Refer to Payments

[And Match Events](#) for more information about the significance of this field.

MATCH_VALUE	30	N	A/N	<p>MATCH_VALUE and MATCH_TYPE_CD are used in conjunction to indicate that the distribution of the payment should be restricted in some way (i.e., the standard payment distribution algorithm should not be used). MATCH_TYPE_CD indicates how the payment should be distributed (e.g., only distribute to a specific service agreement), MATCH_VALUE contains the ID of the restriction (e.g., the SA ID).</p> <p>If MATCH_TYPE_CD is specified, it must reference a valid Match Type.</p>
TNDR_CTL_ID	10	N	A/N	<p>Leave this column blank. It will be assigned by the system when it creates a tender control record.</p>
ACCT_ID	10	N	A/N	<p>This is the tender account. If left blank, the C1-PEPL1 process will populate this field by calling the Determine Tender Account algorithm defined on the distribution rule.</p> <p>Note that this Account ID is not necessarily unique as multiple staging details can reference the same tender account.</p>
PAY_EVENT_ID	12	N	A/N	<p>Leave this column blank. It will be assigned by the system when it creates a payment event record.</p>
PEVT_PROCESS_ID	10	N	A/N	<p>If left blank, the C1-PEPL1 process will set this field equal to the Tender Account ID.</p>

				This field is used for grouping staging records and for organizing parallel threads (in the C1-PEPL2 process). Therefore, it is strongly encouraged that it bears a relationship to the tender account ID.
APAY_SRC_CD	12	N	A/N	This must be a valid auto-pay source code.
EXT_ACCT_ID	50	N	A/N	This is the customer's account number at the financial institution
EXPIRE_DT	10	N	Date	This field is only needed if the Tender Type indicates that an expiration date is necessary (e.g., for a credit card payment)
ENTITY_NAME	64	N	A/N	This is the customer's name in the financial institution's system

Data Setup Examples of Payment Distribution Details

Typically, each staging record will represent a single payment event - with a corresponding payment tender and payment. However, it is possible to specify complex relationships within a set of staging records. For example, it will be straightforward to define a set of staging records that represent a single tender but multiple payments (to model the single payment tender of a welfare agency which covers payments for multiple accounts). Similarly, it is equally possible to define a set of staging records that represent a single payment but multiple tenders (although not a common requirement).

Each staging record can represent:

- Zero or one new payment events. Typically, each detail staging record will represent a single payment event. However, it is possible to define multiple records for a single payment event. All details for a single payment event are identified by a common value on the staging record: **Pay Event Process ID**.

NOTE:

Pay Event Process ID. This field is used for grouping staging records **and** for organizing parallel threads (in the C1-PEPL2 process). Therefore, it is **strongly encouraged** that it bears a relationship to the tender account ID.

- A partial or one new payment tenders. Typically, each detail staging record will represent a single payment tender. However, it is possible to define multiple staging records for a single pay tender. All details for a single tender are identified by a common payment event ID as well as common tender information (tender type, tender account ID, check number, external reference, etc.).
- A partial or many new payments. Typically, each detail staging record will represent a set of one or many new payments. However, it is possible to define multiple staging records for a single payment. All details for a single payment are identified by a common payment event ID as well as common distribution rule and characteristic value information.

The sections below provide examples of a few of these complex payment event configurations. Note that these examples assume the same distribution rule is referenced in all staging records.

- [Staging Entry Example 1: One Payment Event, Two Tenders, Two Payments](#)
- [Staging Entry Example 2: One Payment Event, One Tender, Two Payments](#)
- [Staging Entry Example 3: One Payment Event, Two Tenders, One Payment](#)

Staging Entry Example 1: One Payment Event, Two Tenders, Two Payments

Seq.	Pay Event Process ID	Tender Account ID	Tender Ref.	Date	Rule Value	Amount	Tender Type	Check No
1	1234567890	1234567890	112A	1/1/2006	113-54-8978	30.00	Check	101
2	1234567890	1234567890	112B	1/1/2006	575-40-3030	40.00	Check	102

[Top of Page](#)

Staging Entry Example 2: One Payment Event, One Tender, Two Payments

Seq.	Pay Event Process ID	Tender Account ID	Tender Ref.	Date	Rule Value	Amount	Tender Type	Check No
1	1234567890	1234567890	112A	1/1/2006	113-54-8978	30.00	Check	101
2	1234567890	1234567890	112A	1/1/2006	575-40-3030	40.00	Check	101

[Top of Page](#)

Staging Entry Example 3: One Payment Event, Two Tenders, One Payment

Seq.	Pay Event Process ID	Tender Account ID	Tender Ref.	Date	Rule Value	Amount	Tender Type	Check No
1	1234567890	1234567890	112A	1/1/2006	575-40-3030	30.00	Check	101
2	1234567890	7878787870	888Q	1/1/2006	575-40-3030	40.00	Check	9872

The Lifecycle of a Payment Event Upload Staging Record

The following diagram shows the possible lifecycle of a payment event upload staging record.

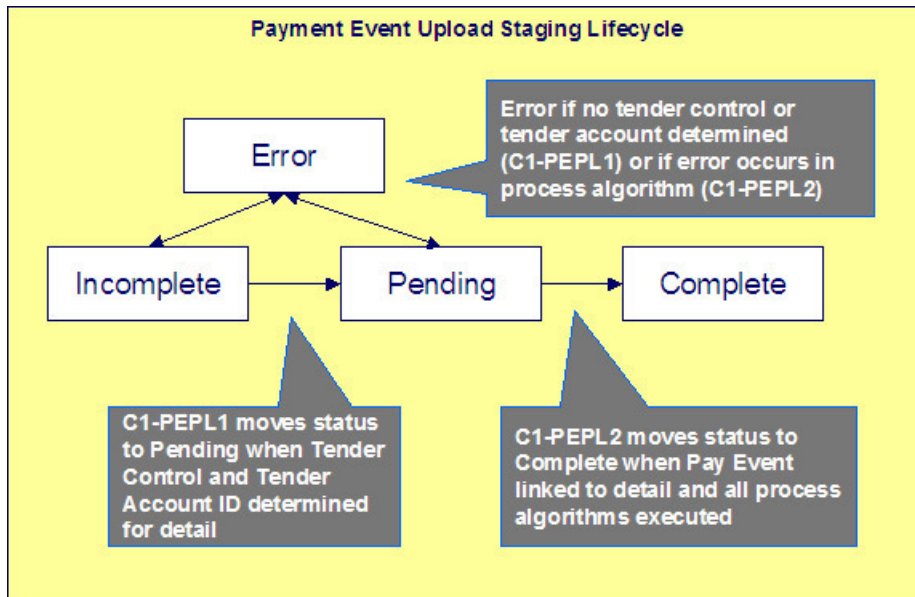

- **Incomplete.** A payment event staging record is initially created in incomplete state. The C1-PEPL1 process sets it to pending once it links it to a tender control and determines its tender account.
- **Pending.** The C1-PEPL2 process sets a pending record to complete once all processing logic is executed and a payment event is linked to it.
- **Complete.** When processing of the staging record is complete the record is in the complete state. This is a final state.
- **Error.** A payment event staging record may be set to Error from Incomplete or Pending states by the C1-PEPL1 and C1-PEPL2 processes respectively.

FASTPATH:

Refer to [To Do Entries Instead of Exceptions](#) for more information on how To Do entries are used to capture processing errors.

To Do Entries Instead of Exception Records

Instead of creating an exception record for staging records in the Error state the C1-PEPL1 and C1-PEPL2 background processes create To Do entries and link them to the offending staging records.

Each process determines the [To Do type](#) to use for reporting errors by looking for the To Do Type defined with this process as its creation process.

Process C1-PEPL1 - Upload Payments (Step 1)

The batch process C1-PEPL1 refers to the first of three background processes that load the contents of the payment event upload staging records into the various payment tables.

The responsibility of this process is to transition the status of the staging records from Incomplete to Pending. The status of a staging record must remain Incomplete until:

- It is linked to a tender control. This process creates a new deposit control record. It creates a new tender control record if the staging record is not currently linked to one. It then updates the payment event upload staging records with the corresponding **Tender Control ID**.

- The **Tender Account ID** field is populated. The Determine Tender Account algorithm defined on the [distribution rule](#) is called and the returned account ID is posted on the staging record.
- The **Pay Event Process ID** field is populated. If left blank this field is set equal to the **Tender Account ID**.

The following diagram and the sections below describe at a high level the processing phases of the C1-PEPL1 background process.

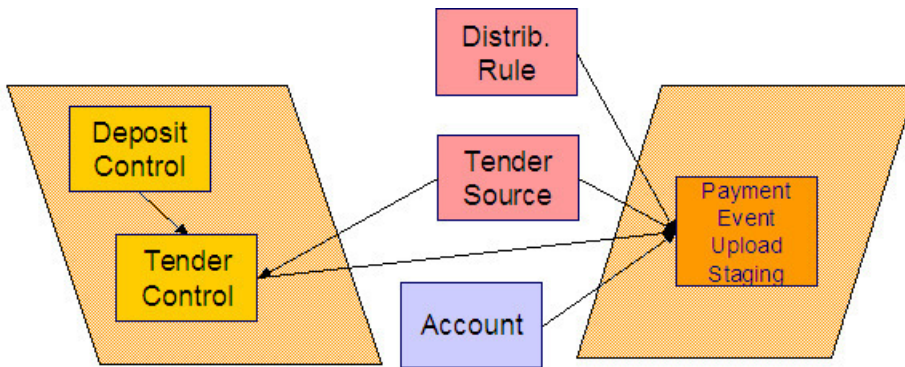

- [Phase 1 - Create Tender Control](#)
- [Phase 2 - Determine Tender Account](#)

Phase 1 - Create Tender Control

NOTE:

This step cannot be bounded by thread range but must execute across the entire population of staging details. Therefore this step in the process is designed so that all parallel threads attempt to execute it at the same time but only one thread succeeds to avoid creating duplicate tender controls.

This step creates all tender controls required by the upload records as follows:

- For each distinct tender source transmissions represented within the incomplete set of upload staging details a deposit control and a tender control are created in an open state. (If the upload record is already linked to a tender control, then that tender control is used and a new one is not created.)
 - If an error occurs at this stage
 - A designated staging record for the transmission group (one is picked at random) is set to Error and a To Do entry is created and linked to it to capture the error message that applies for the whole transmission group. Other records in the group remain incomplete .
 - The process stops.
-

NOTE:

Group Error. This technique allows for an easier recovery from a setup error that may affect a large volume of records in a single transmission. Capturing the error only on a single designated record requires only this record to be set back to Incomplete once the setup issue is corrected. It is important to note that the transmission group is not processed if at least one of the records in the group is in Error status.

- Once a transmission group of records is fully processed, a To Do cleanup processing takes place to complete To Do entries previously raised for its designated staging record.
-

FASTPATH:

Refer to [To Do Entries Instead of Exceptions](#) for more information on how To Do entries are used to capture processing errors.

Phase 2 - Determine Tender Account

After all tender controls have been created the second step attempts to transition all incomplete records to the pending state. Each incomplete staging record is processed as follows:

- If not yet associated with a tender control ID, the process looks for an Open tender control that matches the batch code, batch number and external source ID and links it to the staging record. An error is raised if a matching tender control is not found.
- Execute the Determine Tender Account algorithm defined on the distribution rule and populate the record with the returned account ID. Note that the algorithm is called even when the tender account is populated to provide for a potential override of the initial value when necessary. An error is raised if a tender account may not be determined.
- If not already populated, the **Pay Event Process ID** is set equal to the Tender Account ID. The C1-PEPL2 process uses this field to organize the parallel threads and to group multiple staging details into a single payment event.
- The staging record is moved to pending state.
- If any errors occur set the record to Error and create a To Do entry for the error message.
- If no error occurred, a To Do cleanup processing takes place to complete To Do entries previously raised for the staging record.

FASTPATH:

Refer to [To Do Entries Instead of Exceptions](#) for more information on how To Do entries are used to capture processing errors.

NOTE:

This step is designed to support execution in parallel threads based upon the sequence number portion of the staging table prime key.

Process C1-PEPL2 - Upload Payments (Step 2)

The batch process C1-PEPL2 refers to the second of three background processes that load the contents of the payment event upload staging records into the various payment tables.

The responsibility of the C1-PEPL2 process is to create payment events, payment tenders and payments and transition the corresponding staging records from Pending to Complete.

The following diagram and the section below describe at a high level the processing phases of the C1-PEPL2 background process.

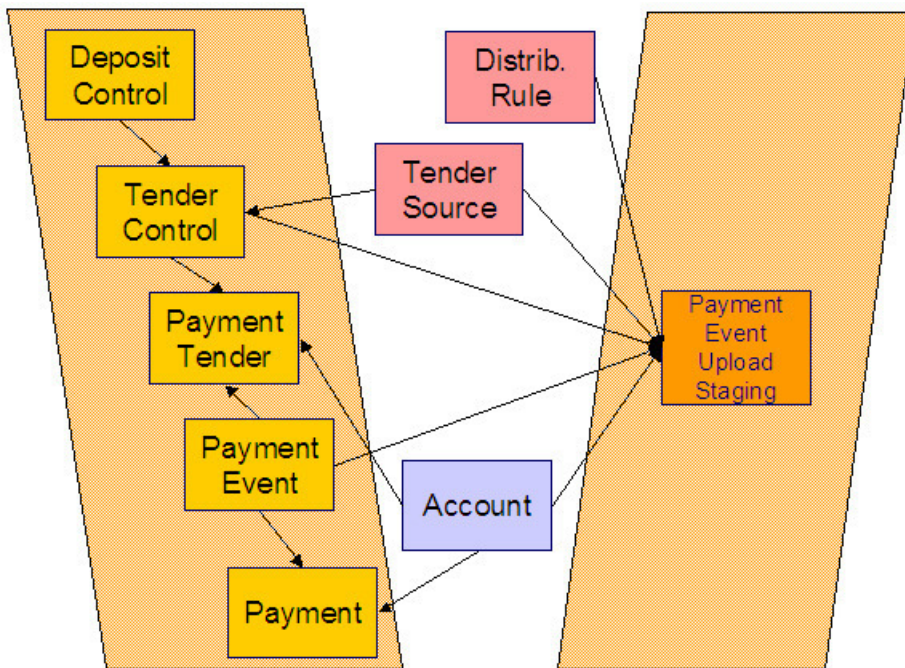

Each distinct group of pending staging records associated with the same external source ID, external transmit ID, accounting date, and pay event process ID is processed as follows:

- A payment event is created for the group and stamped on each of its records.
- A payment tender is created for each distinct set of staging records having the same tender account, tender type and other tender information fields, except for the tender amount.
- The Create Payment algorithm is then called for each distinct group of staging records having the same tender account, [distribution rule](#) and rule value providing it with the total amount for the group.
- The staging record is moved to the complete state.
- If any error occurs a designated staging record for the payment event group (one is picked at random) is set to Error and a To Do entry is created and linked to it to capture the error message that applies for the whole group. Other records in the group remain incomplete .

NOTE:

Group Error. This technique allows for an easier recovery from an error that affects all staging records for a single payment event. Capturing the error only on a single designated record requires only this record to be set back to pending once the issue is corrected. It is important to note that the whole set of records is not processes if at least one of the records in the group is in Error status.

- If no error occurred, a To Do cleanup processing takes place to complete To Do entries previously raised for the designated staging record.
-

FASTPATH:

Refer to [To Do Entries Instead of Exceptions](#) for more information on how To Do entries are used to capture processing errors.

NOTE:

This process is designed to support execution in parallel threads based upon the payment event process ID field.

Process C1-PEPL3 - Upload Payments (Step 3)

The batch process C1-PEPL3 refers to the last of three background processes that load the contents of the payment event upload staging records into the various payment tables.

The responsibility of the C1-PEPL3 process is to update the status of the related deposit and tender controls from open to balanced.

Each distinct tender control for which all associated staging records are in complete status is processed as follows:

- The tender deposit is created.
- The tender control is set to balanced.
- The deposit control is set to balanced.

NOTE:

This process is designed to support execution in parallel threads based upon the Tender Control ID field.

Payment Event Upload Staging

The Payment Event Upload Staging page has three purposes:

- You can view historical payment event upload staging records associated with uploaded payments.
- You can correct payment event upload staging records that are in error.
- You can add new payment event upload staging records to be uploaded by the payment event upload processes.

The topics in this section describe this page.

Payment Event Upload Staging - Main

This page shows the details of a payment event upload staging record.

FASTPATH:

Refer to [Populating The Payment Event Upload Staging Records](#) for more information about this record.

Open this page using **Menu > Financial > Payment Event Upload Staging > Search.**

Description of Page

External Source ID corresponds with an external source ID on one of the your tender sources. This should be the unique ID of the source of the interfaced payments. Refer to [Setting Up Tender Sources](#) for more information.

External Transmission ID is the unique identifier of the transmission of payments from the external source. This must be a unique value for each transmission from the source.

Sequence is the identifier of the record within the transmission. The C1-PEPL1 process uses this field to organize the parallel threads.

Accounting Date is the payment date that should be used for accounting purposes.

Distribution Rule is the rule by which the payment detail is to be processed. A [default distribution rule](#) is displayed if you have set one.

Rule Value is a value associated with the payment and expected by the distribution rule.

Match Type and **Match Value** are only used if the distribution of the payment should be restricted in some way (i.e., the standard payment distribution algorithm should not be used). **Match Type** indicates how the payment should be distributed (e.g., only distribute to a specific service agreement), **Match Value** indicates the ID of the restriction (e.g., the service agreement ID).

Payor Account ID is the tender account. If not populated the C1-PEPL1 process populates this field by calling the Determine Tender Account algorithm defined on the [distribution rule](#).

Tender Amount is the amount tendered (i.e., the payment amount).

Currency Code is the currency of the tendered amount. This should be the same as currency defined on the tender source.

Tender Type defines the form or remittance (e.g., cash, check, etc.). Note that the **Tender Type** defaults from the [installation record](#).

NOTE:

Authorizing Tenders. The **Tender Type** dropdown list does not include tender types that require authorization (i.e. credit card payments).

FASTPATH:

For information about tender types requiring authorization, refer to [Credit Card Payments](#).

Check Number is the check number on the payment.

MICR ID is the value of the magnetic ink character recognition (MICR) line on the payment.

External Reference ID may be used to record external information associated with the payment tender.

Customer ID may be used to record additional customer information.

Name may be used to record additional payment tender information.

Tender Control ID is the tender control associated with the payment. This field is should typically be left for the C1-PEPL1 process to populate.

If the **Tender Type** is associated with an [automatic payment](#), the **Auto Pay** section displays. The system attempts to default automatic payment information from the [account's auto-pay](#) option if the tender type is the same as the tender type on the account's auto-pay source and if the auto pay option is effective on the payment date. If the system is unable to default information, you must specify the source of the funds and the customer's account number / credit card number at the financial institution.

- **Auto Pay Source** is the financial institution / credit card company that receives the automatic payment request.
- **External Account ID** is the customer's account number at the financial institution.
- **Expires On** is only needed if the **Tender Type** indicates that an expiration date is necessary (e.g., for a credit card payment).
- **Name** is the customer's name in the financial institution's system.

Pay Event Process ID is used to group multiple staging records into a single payment event. If not populated, the C1-PEPL1 process sets this field equal to the **Payor Account ID**.

Pay Event Staging Status shows the state of the staging record. Refer to [The Lifecycle of a Payment Event Upload Staging](#) for a state transition overview.

Payment Event ID is the system-assigned, unique identifier of the related payment event. The C1-PEPL2 process populates this field when it creates a payment event for the upload staging record. You can use this field to navigate to the payment event page.

If a staging record is in Error state then the error message associated with the [corresponding To Do entry](#) is displayed.

Adjustments

In this section, we describe when and how to adjust a service agreement's balance.

The Big Picture Of Adjustments

The topics in this section provide background information about a variety of adjustment issues.

FASTPATH:

We strongly recommend familiarizing yourself with the topics described in [The Financial Big Picture](#) to fully appreciate the place of an adjustment in the system's financial architecture. In particular, refer to [Setting Up Adjustment Types](#) and [Setting Up Adjustment Type Profiles](#).

Adjustments - Current Balance versus Payoff Balance

Adjusting how much a customer owes involves changing a service agreement's payoff balance and/or current balance by creating an adjustment. In this section we describe these two balances.

WARNING:

If you do not understand the difference between payoff balance and current balance, refer to [Current Amount versus Payoff Amount](#).

When Current Balance Equals Payoff Balance

For most service agreements, payoff balance and current balance are always the same (or in colloquial speech - the amount the customer thinks they owe equals what they really owe). In this situation, an adjustment is easy: both payoff balance and current balance are adjusted by the same value.

Let's run through a typical example. The values in the payoff balance and current balance columns reflect the amount due after the financial transaction has been applied (i.e., the running balance):

Date	Financial Transaction	Payoff Balance	Current Balance
1-Jan-99	Bill: \$125	125	125
15-Jan-99	Payment: \$150	-25	-25
2-Feb-99	Bill: \$175	150	150
14-Feb-99	Payment: \$150	0	0
3-Mar-99	Bill: \$200	200	200
15-Mar-99	Payment: \$150	50	50
2-Apr-99	Bill: \$225	275	275
27-Apr-99	Adj: Late Payment Charge \$10	285	285

As you can see, payoff balance and current balance are always in sync.

When Current Balance Differs From Payoff Balance

For some service agreements, payoff balance and current balance differ (or in colloquial speech - the amount the customer thinks they owe differs from what they would owe if they wanted to payoff their account).

Let's run through an example of a customer on a budget to illustrate a classic service agreement where these two balances are not the same. The values in the payoff balance and current balance columns reflect the amount due after the financial transaction has been applied:

Date	Financial Transaction	Payoff Balance	Current Balance
1-Jan-99	Bill: \$125, Budget \$150	125	150
15-Jan-99	Payment: \$150	-25	0
2-Feb-99	Bill: \$175, Budget \$150	150	150
14-Feb-99	Payment: \$150	0	0
3-Mar-99	Bill: \$200, Budget \$150	200	150
15-Mar-99	Payment: \$150	50	0
2-Apr-99	Adj: Mar 3, 97 bill incorrect due to meter exchange discrepancies; manual correction of -\$33.	17	0

Notice the adjustment of -\$33 affects only payoff amount. This is because the customer is on a budget. The adjustment will not affect their monthly payment and therefore it doesn't affect how much they think they owe.

The following table describes the various types of service agreements where these balances may differ.

Type Of Service Agreement	What Payoff Balance Holds	What Current Balance Holds
Deposit	Payoff balance holds the amount of deposit you are holding on behalf of the customer's debt. This amount is showed as a credit (with a negative sign) because you truly owe the customer this money.	Current balance holds the amount the customer owes for a deposit.
Charitable contribution	N/A - charitable contribution service agreements never have a payoff balance.	Current balance holds the amount the customer owes for a charitable contribution.
Payment arrangements	Payoff balance holds the total amount of delinquent debt that remains unpaid. When a payment arrangement is started, you transfer the payoff balance from the utility service agreement to the payment arrangement service agreement. Each billing period, the customer pays down this balance.	Current balance holds the amount the customer owes in respect of the billed payment arrangement amounts.
Utility agreements on a budget plan	Payoff balance holds the actual amount owed (actual bills minus payments).	Current balance holds the amount the customer owes in respect of the billed budget amount.
Loans	Payoff balance holds the payoff amount for the loan, which is the current balance (the billed loan amount) plus the principal balance	Current balance holds the amount the customer owes in respect of the billed amount (the periodic payment amount).

(the unbilled loan amount) and any accrued interest charges.

Adjustment Type And Balances

When you create an adjustment, you must define its adjustment type. The adjustment type controls how payoff balance and current balance are affected by the adjustment amount.

You can only pick adjustment types that make sense for the service agreement. For example, if your organization doesn't allow budget billing, all adjustments for a utility service agreement will affect payoff balance and current balance the same (you can't get the balances out-of-sync).

The various types of adjustments that may be linked to a service agreement are controlled by the adjustment profiles defined on the service agreement's SA type.

FASTPATH:

Refer to [Adjustment Type Controls Everything](#) for more information.

Canceling Adjustments

You may cancel any frozen adjustment. Canceling the adjustment creates another financial transaction that reverses the financial effects of the original adjustment. The impact of the cancellation appears on the customer's next bill. You may view both the original financial transaction and its cancellation on the Adjustment page.

Transfer Adjustments

A convenient mechanism exists to transfer moneys between two service agreements. The net effect of such a request is the creation of two adjustments, each of which is linked to the other. Both adjustments are created together, frozen together, and posted to the GL together. This is useful because you can't create one side of the transfer and without the other. Refer to [How To Create A Transfer Adjustment](#) for more information.

NOTE:

Inter or Intra Account. It's important to be aware that the transfer can be inter or intra account (i.e., the accounts on the two adjustments may be different).

Calculated Adjustments

An adjustment can calculate the adjustment amount using an algorithm. A calculated adjustment can be used to calculate:

- Sales or other taxes for a base amount
- Any charge amount based on a user-supplied quantity, such as feet, miles, hours, etc.
- Others.... Any calculation that can be made by a rate can be applied to an adjustment.

When you create a calculated adjustment, you may be asked to supply a base amount. The user may supply the base amount or the amount could be [defaulted](#) from the adjustment type and possibly overridden by the user prior to calculating the adjustment amount.

When the adjustment is generated, the calculation algorithm may use the base amount and calculation date. The base package algorithm calls the rate application and returns the calculated amount with calculation lines and GL distribution codes.

An adjustment's adjustment type controls whether the adjustment is calculated and the algorithm that performs the calculation.

FASTPATH:

For more information, refer to [Adjustment Type Controls Everything](#) and [Setting Up Calculated Adjustment Types](#).

Adjustment Amount May Be Positive, Negative, Or Zero

An adjustment's amount may be positive, negative or zero:

- A positive amount causes the customer's balance(s) to increase.
- A negative amount causes the customer's balance(s) to decrease.
- A zero amount will not affect the customer's balance(s). A zero amount is odd, but necessary when you need to use an adjustment to correct the GL distribution. Refer to [How To Use An Adjustment To Change Amounts Booked In Your GL](#) for more information.

Adjustment Type Controls Everything

When you create an adjustment, you must define its adjustment type. The topics in this section describe how adjustment type controls the behavior of an adjustment.

Controls Which Balance(s) Are Affected

The adjustment type's financial transaction (FT) algorithm controls how payoff balance and current balance are affected by the adjustment amount.

Defines The GL Account Affected By The Adjustment

Most adjustments affect the general ledger (GL) in some way. The following points describe the source of these GL accounts.

- For normal adjustments (i.e., non-calculated adjustments that affect a single service agreement), there is a single accounting entry generated:
 - One side of the accounting entry is taken from the distribution code on the SA type of the service agreement affected by the adjustment. For example, if you are adjusting the payoff balance on a normal service agreement, the A/R account is constructed from the distribution code on the service agreement's SA type.
 - The other side of the accounting entry is taken from the distribution code on the adjustment's adjustment type. For example, if a late payment charge is created, the "late payment charge" adjustment type references this fee's revenue account.
- For transfer adjustments (i.e., adjustments used to transfer moneys between two service agreements), there are two accounting entries generated - one for the "from" side and one for the "to" side. Each adjustment carries its own set of balanced GL accounting details.

- For each adjustment, one side of the entry is taken from the distribution code on the SA type of the service agreement affected by the adjustment (just like for normal adjustments).
- The other sides of both accounting entries have the same GL account. This account should be the intermediate clearing GL account that is to be used for the transfer. The source of this clearing GL account is the distribution code on the adjustment type used to transfer the funds.
- For calculated adjustments (i.e., adjustments where rates may be applied to calculate the adjustment amount), there is a single accounting entry:
 - For each adjustment, one side of the entry is taken from the distribution code on the SA type of the service agreement affected by the adjustment (just like for normal adjustments).
 - The other side of the entry is taken from the distribution codes that resulted from the rate calculation if the adjustment financial transaction algorithm is set up to use the calculation lines as the distribution code source. If the adjustment financial transaction algorithm is set up to use the adjustment type as the distribution code source, the other side of the accounting entry is taken from the distribution code on the adjustment type.

NOTE:

Not all adjustments affect the GL. As a general rule of thumb, only those adjustments that affect a service agreement's payoff balance affect the GL. So, if you adjust a budget customer's current balance, but don't adjust their payoff balance, the GL is not affected.

Defaults The Adjustment Amount

The adjustment type may default the adjustment amount in one of the following ways:

- The adjustment type may specify a default amount. This would be used for those adjustment types that have a standard charge for all customers that receive this adjustment, for example a non-sufficient funds charge.
- The adjustment type may specify a default adjustment amount algorithm. This would be used for those adjustment types that have a charge that varies based on other factors. For example, a non-sufficient funds charge may be based on a customer's credit rating.

When an amount is defaulted onto a new adjustment it may be overridden by a user.

Calculates The Adjustment Amount

Some adjustment types [calculate the adjustment](#) amount. If the adjustment type uses a calculated amount, a base amount is passed to the rate application, which then returns the calculated amount with calculation lines and GL distribution codes.

The adjustment type's generate adjustment algorithm controls which rate is applied to the base amount. A user supplied calculation date controls which version of the rate is used. The user may supply the base amount or it may be [defaulted](#) from the adjustment type and possibly overridden by the user prior to calculating the adjustment amount.

Controls The Interface To A/P & 1099 Reporting

If the adjustment type is associated with a payment (e.g. a refund or a loan disbursement) of money to a customer, the adjustment type indicates such with a reference to an A/P request type.

When an adjustment that references an A/P request type is frozen, an A/P download request record is created. This record is the interface request to ask your A/P system to cut a check. This interface record is marked with a batch process ID and run number.

- The batch process ID is the background process responsible for creating the flat file that contains check request that is interfaced to your account's payable system. The batch process ID is defined on [Installation Options - Financial](#). The base package is supplied with a skeletal background process (APDL) that must be populated with logic to format the records in the format compatible with your accounts payable system.
- The run number is the batch process ID's current run number.

FASTPATH:

Refer to [Accounts Payable Check Request](#) for more information.

If the resultant check needs to be reported for income tax purposes under a specific 1099 category, the category is also specified on the adjustment type. The 1099 category is in turn interfaced to the A/P system (the system does NOT manage 1099 reporting).

Controls Information Printed On The Bill

If the adjustment appears on the customer's next bill, the verbiage is specified on the adjustment type (and may NOT be overridden on the adjustment).

Controls If The Adjustment Can Be Frozen Prior To Bill Completion

Refer to [Preventing SA Balances And The GL From Being Impacted Until Bill Completion](#) for how adjustment type can control whether adjustments of a given type can be frozen prior to bill completion.

Controls If The Adjustment Requires Approval

If an adjustment's adjustment type references an approval profile, the system will not allow the initiating user to freeze the adjustment. Rather, the initiating user can submit the adjustment for approval. When an adjustment is submitted for approval, the system determines the necessary approval levels and notifies the first approver. The system will freeze the adjustment when last approver approves the adjustment (if the adjustment's adjustment type allows it to be frozen prior to the completion of the next bill).

NOTE:

Only online adjustments are subject to approval. The system assumes that no approval is necessary for adjustments created by batch processes even those whose adjustment type references an approval profile.

FASTPATH:

Refer to [The Big Picture of Adjustment Approvals](#) for more information.

Unbilled Adjustments And Aged Debt

A Frozen adjustment waits in limbo until the customer's next bill is produced. This limbo period could be several weeks if the customer is billed infrequently. When the customer's next bill is completed, all limbo adjustments are linked to the bill. A brief description (as defined on the adjustment type) appears on the printed bill.

It is important to stress the following in respect of these limbo adjustments:

- If the adjustment decreases the amount of debt, the customer's aged debt is affected immediately regardless of whether the adjustment appears on a bill.
- If the adjustment increases the amount of debt, the amount the customer owes from an aged debt perspective may or may not be affected by the adjustment. There is a switch on the financial transaction created for the adjustment called New Charge that controls the arrears behavior. When the FT for this type of adjustment is created, the switch is set to on and the customer's aged debt will not reflect the adjustment amount until the adjustment is swept onto a bill. The moment the adjustment is swept onto the customer's bill, the debt starts aging. A user may turn the switch off to cause the debt to start aging sooner. For this case, the date on which the adjustment starts aging must be defined in the Arrears Date field.
- The amount a customer owes in total is immediately affected by the adjustment regardless of whether the adjustment appears on a bill. This means that amount of aged debt may not be in sync with the total amount owed. This seems odd but is useful from a credit and collections perspective. You see, you probably don't want to start aging an adjustment until the customer has actually seen it.

An Adjustment May Affect More Than Just Customer Balances

FASTPATH:

When an adjustment is frozen or cancelled, a customer's current and payoff balances are affected. However, several other objects may be affected when such events occur. Refer to [Obscure Things That Can Happen](#) for more information.

Maintaining Adjustments

An adjustment is used to change the amount of debt stored on a service agreement. The topics in this section describe the pages on which adjustments are maintained.

FASTPATH:

For more information about adjustments, refer to [The Big Picture Of Adjustments](#).

The Lifecycle Of An Adjustment

The following diagram shows the possible lifecycle of an adjustment.

WARNING:

This diagram only makes sense in the context of the page used to maintain Adjustments. Refer to [Adjustment - Main Information](#) for the details.

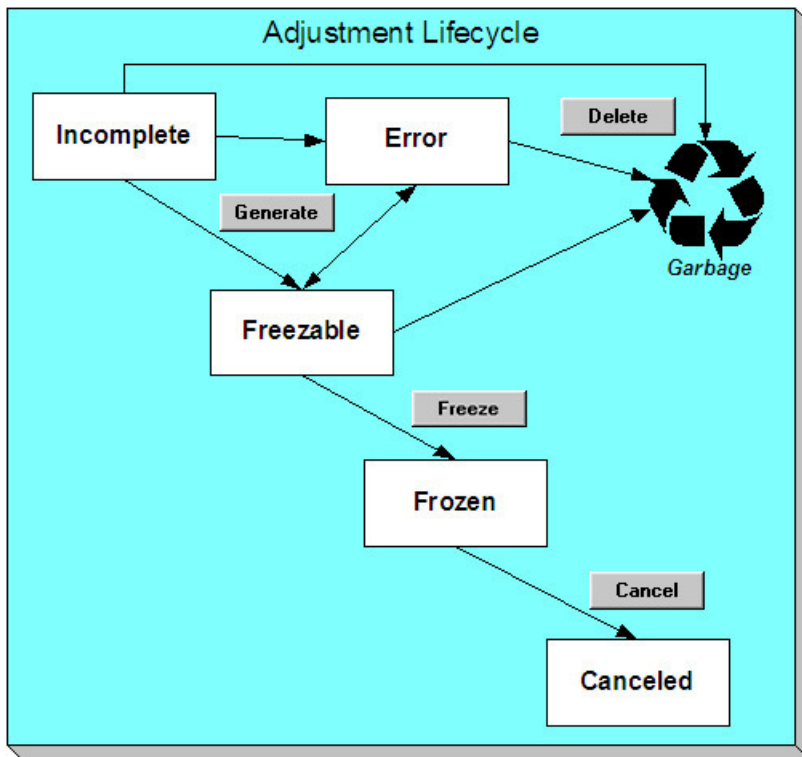

NOTE: Even though New is considered a valid adjustment state, this is only used as default when adding an adjustment. Once the adjustment is saved, it is assigned the appropriate state in the adjustment life cycle. An adjustment will never exist in the New state.

Adjustments are initially created in the Incomplete state. Adjustments in this state don't have a financial transaction. This means, you can change the adjustment type and amount at will.

Click **Generate** to generate a financial transaction for the adjustment. The financial transaction contains the adjustment's effect on the general ledger and on the customer's payoff and current balances. If the adjustment is calculated, the algorithm on the adjustment type's Generate Adjustment event controls how the adjustment is calculated. If the adjustment is calculated, you must specify the calculation date, which is passed as a parameter to the calculation algorithm and is used for calculations that are effective dated (e.g., rate version or bill factor value). The financial transaction (FT) algorithm defined on the adjustment type Adj. Financial Transaction event controls how the financial transaction is constructed. For calculated adjustments, the distribution code may be taken from the adjustment type or the calculation lines.

After generating the financial transaction, the adjustment becomes Freezable. While in this state, you may change the service agreement, adjustment type and amount at will. However, if you change this information, you will have to regenerate the financial transaction (by clicking the Generate button).

In the very rare situation when the system cannot generate the financial transaction because of inconsistent setup data, the adjustment is moved to the Error state. You may regenerate the financial transaction after correcting the source of the error. You may also delete such an adjustment.

Click the delete button to physically remove an Incomplete, Error or Freezable adjustment from the database.

WARNING:

Please be aware that you can prevent specific types of adjustments from being frozen until the account's next bill is completed. Refer to [Preventing SA Balances And The GL From Being Impacted Until Bill Completion](#) for how to enable this feature on your adjustment types.

Click **Freeze** to freeze the adjustment and its financial transaction. After doing this, the adjustment's state becomes Frozen. While in this state, you cannot change the adjustment's type or amount, but you may change:

- When the adjustment starts aging.
- Whether the adjustment appears on a customer's bill.
- The accounting date used to derive the general ledger accounting period(s) to which the financial transaction is booked.

NOTE:

Adjustments may require approval. If the adjustment type referenced on the adjustment has an approval profile, the Freeze button is replaced with a Submit for Approval button. If an adjustment is currently being approved, all action buttons are disabled because the adjustment must be either approved or rejected using the [Adjustment - Approval](#) page.

However, the Delete button is enabled for an adjustment in a freezable state and linked to an approval request that is in a “no approval necessary” state. If the adjustment is deleted a log entry is created on the associated approval request.

Refer to [The Big Picture of Adjustment Approvals](#) for more information.

If you need to remove the financial effects of an adjustment, click **Cancel**. Canceling an adjustment causes the generation of another financial transaction. This new financial transaction reverses the financial impact of the original adjustment.

Adjustment - Main Information

FASTPATH:

The **Description of Page** section below describes the fields on this page. Refer to [How and When To Use An Adjustment](#) for instructions describing how to perform common maintenance functions.

The Main page contains core adjustment information. Open this page using **Menu > Financial > Adjustment > Search**.

WARNING:

All adjustments reference a very important field that controls much validation and processing; this field is called Adjustment Type. Take special care when adding a new adjustment to specify the appropriate Adjustment Type as it affects how the adjustment appears on the customer's bill, how the adjustment is reflected in your general ledger, and much more. After the adjustment is frozen, you may not change its Adjustment Type.

Description of Page

Adjustment Info contains a concatenation of the adjustment amount, adjustment type and status.

NOTE:

Formatting may be performed by a plug-in. The contents of **Adjustment Info** may be formatted by a plug-in algorithm on the [Adjustment Type](#). Refer to the base package's C1-ADT-INFO for an example. If such an algorithm is not plugged-in on the Adjustment Type, the system looks for a corresponding algorithm on the [installation record](#). Refer to the base package's C1-ADI-INFO for examples. If you prefer different formatting logic, your system administrator should configure the system appropriately.

Adjustment ID is the system-assigned, unique identifier of the adjustment.

Account ID is the account to which the adjustment is linked. The name of the main person on the account appears next to the account ID.

Use **Service Agreement ID** to define the service agreement whose value needs to be adjusted. Basic information about the service agreement appears adjacent.

Premise is a display-only field that shows the **Service Agreement's** characteristic premise (i.e., the primary premise associated with the service agreement).

Indicate the **Adjustment Type**. This field is very important as it controls numerous aspects of the adjustment's impact on the customer's balance and your general ledger. This field is gray after the adjustment is frozen.

NOTE:

You can only choose certain adjustment types. The service agreement's SA type has a collection of valid adjustment profiles. You may only reference adjustment types that are listed in one of the adjustment type profiles linked to the SA type.

The list of adjustment types is also restricted to those without a CIS Division and those with a CIS Division that matches the service agreement's CIS Division.

Enter the **Amount** of the adjustment. If the adjustment type is a calculated adjustment, the **Calculated Amount** and **Calculation Date** are displayed. The values of the calculated amount and calculation date are displayed after the adjustment is generated. The calculated amount shows the result of the generate adjustment algorithm. The calculation date is specified when you click Generate for a calculated adjustment type. It is used by the generate adjustment algorithm for any calculations that are effective dated (e.g., rate version calculation group or bill factor value).

NOTE:

Default note. The adjustment amount defaults based on the adjustment type. When you change the adjustment type, the amount changes accordingly. You may change the adjustment amount after it is defaulted.

On Behalf SA ID is a display-only field that is only populated on system-generated adjustments instigated by one customer, but attributed to another customer. For example, if chargeable field work is performed for a customer, but is payable by the customer's meter maintenance service provider, the adjustment will be linked to the service provider and will reference the customer's SA as its **On Behalf SA ID**. This field is only visible if it is populated on the adjustment.

You may not change an adjustment's **Adjustment Status** directly. Rather, you use the buttons in the **Adjustment Actions** area. Refer to [The Lifecycle Of An Adjustment](#) for the details.

If the status is canceled, the **Cancel Reason** is displayed.

Use the **Comments** to describe anything unusual about the adjustment.

The **Creation Date** defines the date on which the adjustment was created.

If the adjustment is subject to approval, a message indicating such appears. Clicking this message navigates the user to the **Approvals** tab. Refer to [The Big Picture of Adjustment Approvals](#) for more information.

The financial transaction (FT) grid contains the financial transactions associated with the adjustment. It only contains information after the adjustment is frozen. If the adjustment is canceled, a second row appears showing the details of the cancellation FT.

- **Financial Transaction ID** is the system-assigned unique identifier of the FT. Click the go to button to transfer to the financial transaction. On this page you can change certain aspects of the FT in question.
- **Arrears Date** is the date the FT starts aging.
- **Accounting Date** is the date the system uses to determine the FT's accounting period in your general ledger.
- **Current Amount** contains the FT's effect on the service agreement's current balance.
- **Payoff Amount** contains the FT's effect on the service agreement's payoff balance.
- **Bill ID** is the bill on which the FT appears (if it has been swept onto a bill). Click the adjacent go to button to transfer to the bill on which the FT appears. Note: an FT is linked to a bill the next time a bill is completed for the service agreement's account.

The **Calculation Lines** grid contains the details of the calculations associated with a [calculated adjustment](#). It only appears if the rate that calculated the adjustment amount created at least one calculation line. One row exists for every calculation

involved in the process. This information is for audit purposes only and cannot be modified. The following information displays in the grid:

- If at least one of the calculation lines has characteristics, **Calc Line Char** displays go to buttons, allowing you to go to characteristics that are linked to a specific adjustment calculation line. This column is only displayed if at least one of the calculation lines has characteristics.
- **Sequence** is the system-assigned unique identifier of the calculation detail row.
- **Description on Bill** is the information about the calculation line that appears on the customer's bill.
- **Calculated Amount** is the calculated amount associated with the calculation line.
- The **Print** switch controls whether information about this line will print on the customer's bill.
- The **Appears in Summary** switch defines if this line's amount also appears on a summary line. This switch plays a part at bill print time - those lines that appear in a summary print in the left dollar column, those that don't appear in a summary print in the right dollar column.
- **Unit of Measure (UOM)** is the unit of measure of the service quantity priced on the calculation line.
- **Time of Use (TOU)** is the time-of-use code of the service quantity priced on the calculation line.
- **SQI** is the service quantity identifier of the service quantity priced on the calculation line.
- **Billable Service Quantity** is the service quantity priced on the calculation line. This quantity differs from the measured consumption if there are pre-processing calculation groups in effect.
- **Base Amount** is used by calculation lines (e.g. taxes) that are cross-referenced to other calculation lines and whose value(s), therefore, depend on the amounts calculated by those other lines. The Base Amount shows the total amount derived from the cross-referenced line(s) that the current line then used to calculate its billed amount.
- **Rate Component Sequence** refers to the sequence number of the rate component on the applicable rate version calculation group that was used to calculate the line. This is only populated if the original rate engine calculated the charges.
- **Calculation Rule** is the rule that calculated the line. This is only populated if the new rate engine calculated the charges.
- **Measures Peak Qty** is checked if the UOM priced on the calculation line is used to measure a peak quantity.
- **Exempt Amount** is the amount of the calculated charge that the customer doesn't have to pay because they are tax exempt.
- **Distribution Code** is the distribution code associated with the calculation line. This distribution code is used to build the general ledger details on the bill segment's financial transaction.
- **Description** describes the characteristic value that was used when the line's amount was calculated. This information is only displayed if the line was calculated using a bill factor (because only bill factors use characteristic values). Refer to [An Illustration Of A Bill Factor And Its Characteristics](#) for more information.

FASTPATH:

For more information, refer to [Calculated Adjustments](#).

The **Adjustment Actions** area contains buttons that you use to commit and cancel the adjustment's financial impact. The adjustment's status controls the button you can see and select. Refer to [The Lifecycle Of An Adjustment](#) for the details.

WARNING:

Please be aware that you can prevent specific types of adjustments from being frozen until the account's next bill is completed. Refer to [Preventing SA Balances And The GL From Being Impacted Until Bill Completion](#) for how to enable this feature on your adjustment types.

Cancel may not be enabled. The cancel button is not enabled if the adjustment is linked to a bill that is written off.

NOTE:

Canceling An Accounts Payable (A/P) Adjustment. If you need to cancel an A/P adjustment (i.e. an adjustment of an adjustment type that has an A/P request type) that has already been extracted by A/P, refer to [How To Cancel An A/P Adjustment After It's Been Selected By A/P](#).

Adjustment - Characteristics

You use this page to link additional information to the adjustment. Open using **Menu > Financial > Adjustment > Search** and navigate to the **Characteristics** page.

Description of Page

The characteristics collection contains information that describes miscellaneous information about the adjustment.

NOTE:

Characteristic Types. You can only choose characteristic types defined on the adjustment's [adjustment type](#).

The following fields display:

Characteristic Type Indicate the type of characteristic.

Characteristic Value Indicate the value of the characteristic.

NOTE:

Default Note. An adjustment's characteristics default from the [adjustment type](#).

Adjustment - Transfer Adjustment

FASTPATH:

The **Description of Page** section below describes the fields on this page. Refer to [How and When To Use An Adjustment](#) for instructions describing how to perform common maintenance functions.

The Transfer Adjustment is used to define the reciprocal adjustment associated with a transfer adjustment (there are always two adjustments associated with a transfer). Open using **Menu > Financial > Adjustment > Search**.

The Main page describes one side of the transfer adjustment; for example, the “transfer from” adjustment. As well, the Transfer Adjustment page describes the reciprocal adjustment; for example, the “transfer to” adjustment.

Description of Page

Adjustment Info contains a concatenation of the adjustment amount, adjustment type and status.

Adjustment ID is the system-assigned, unique identifier of the adjustment.

Account ID is the account to which the adjustment is linked. The name of the main person on the account appears next to the account ID.

Use **Service Agreement ID** to define the transfer to service agreement. Basic information about the service agreement appears adjacent.

Premise is a display-only field that shows the **Service Agreement's** characteristic premise (i.e., the primary premise associated with the service agreement).

The **Adjustment Type** and adjustment **Amount** from the first page are displayed. If you need to change either value, return to the first page.

Adjustment Status shows the status of the transfer to adjustment. If you need to change the adjustment's status, use the action buttons.

Use the **Comments** to describe anything unusual about the adjustment.

Transfer Adj ID is the system-assigned, unique identifier of the adjustment.

The **Creation Date** defines the date on which the adjustment was created.

The financial transaction grid contains the financial transactions associated with the adjustment. It only contains information after the adjustment is frozen. If the adjustment is canceled, a second row appears showing the details of the cancellation FT.

- **Financial Transaction ID** is the system-assigned unique identifier of the FT. Click the go to button to transfer to the financial transaction. On this page you can change certain aspects of the FT in question.
- **Arrears Date** is the date the FT starts aging.
- **Accounting Date** is the date the system uses to determine the FT's accounting period in your general ledger.
- **Current Amount** contains the FT's effect on the service agreement's current balance.
- **Payoff Amount** contains the FT's effect on the service agreement's payoff balance.
- **Bill ID** is the bill on which the FT appears (if it has been swept onto a bill). Click the adjacent go to button to transfer to the bill on which the FT appears. Note: an FT is linked to a bill the next time a bill is completed for the account.

Adjustment - A/P Request

FASTPATH:

The **Description of Page** below describes the fields on this page. Refer to [How and When To Use An Adjustment](#) for instructions describing how to perform common maintenance functions.

The A/P Request page contains information about adjustments used to refund money via an A/P check request. This page is only relevant if:

- The adjustment's adjustment type references an A/P Request Type (i.e., it will be interfaced to your accounts payable system which will cut the check), AND
- The adjustment is frozen.

Open this page using **Menu > Financial > Adjustment > Search** and navigate to the **A/P Request** page.

Description of Page

Adjustment Info contains a concatenation of the adjustment amount, adjustment type and status.

Adjustment ID is the system-assigned, unique identifier of the adjustment.

Account ID is the account to which the adjustment is linked.

NOTE:

Adjustment type controls A/P check requests. The A/P Request information is populated when an adjustment used to refund money via an A/P check request is frozen. Whether or not an adjustment is interfaced to A/P is controlled by the adjustment's adjustment type. The adjustment type's A/P Request Type controls the payment date and the bank.

Name is the name printed on the check. This name is derived from the account's main person:

- If this person has an override mailing name, the first line of the override mailing name is used.

- If this person does not have an override mailing name, the person's primary name is used.

Payment Selection Status is the status of the check request. The values are:

- Not Selected for Payment before it's selected by A/P for payment
- Requested for Payment after it's selected by A/P
- Paid after it's paid by A/P
- Canceled if it's been canceled in A/P
- Hold if it's been held in A/P

Scheduled to Pay is the date on which the check is scheduled to be cut. This is equal to the adjustment date plus the Due Days on the adjustment type's A/P request type.

The following fields are provided in order to support a two-way interface with an A/P system. The system provides the inbound web service C1-UpdateAPCheckRequest that can be used to update these fields.

- **PaymentDate** is the date on which the check was cut in A/P. This field is only populated after A/P cuts the check.
- **Paid Amount** is the amount of the check. This field is only populated after A/P cuts the check.
- **A/P Request ID** is the system-assigned, unique identifier of the A/P check request.
- **Payment Number** is the system-assigned number of the payment in A/P (this number typically appears on the printed check). This field is only populated after A/P cuts the check.

The address information in the bottom frame is the address to which the check is mailed. This is the billing address of the main customer linked to the account. After the adjustment is frozen, this information is automatically populated based on the address information for the account. This information is only modifiable when the Payment Selection Status is Not Selected for Payment.

Adjustment - Adjustment Portal

Select **Menu > Financial > Adjustment > Search** and navigate to the **Adjustment Portal** page to view additional information associated with an Adjustment.

Depending on your implementations requirements, you may define additional zones to appear on this Portal.

The contents of this section describe the zones that are available on this portal page.

General Information

Adjustment ID, **Adjustment Info** are displayed.

Adjustment - Approval

This page only appears after an adjustment has started the approval process. Open this page using **Menu > Financial > Adjustment > Search** and navigate to the **Approval** page.

FASTPATH:

Refer to [The Big Picture of Adjustment Approvals](#) for more information about the approval process.

The topics in this section describe the base-package zones that appear on the Approval Profile portal.

Adjustment Information

The Adjustment Information zone contains display-only information about the adjustment.

Approval Request

The Approval Request zone shows the current and future approvers of an adjustment. This zone only appears if the adjustment is in the approval process.

If the current user has approval authority, the following functions are available:

- **Approve:** to approve the adjustment.
- **Reject:** to reject the adjustment.

Approval Request Log

The Approval Request Log zone contains the history of the adjustment's approval.

Financial - Adjustment Calculation Line Characteristics

This page displays the characteristics that are linked to a specific adjustment calculation line. The information on this page is for audit purposes only and cannot be changed.

Open this page by clicking on the characteristics go to button on the calculation lines grid of the [Adjustment - Main](#) page.

Description of Page

Account is the account to which the adjustment is linked. The name of the main person on the account appears next to the account ID.

The **SA** is the service agreement whose value needs to be adjusted. Basic information about the service agreement appears adjacent.

Premise shows the service agreement's characteristic premise (i.e., the primary premise associated with the service agreement).

The **Adjustment Info** displays information to identify the adjustment, including amount, type, and status.

Adjustment ID displays the identification of the adjustment, and **Calc Line** displays the calculation line with which the characteristics are associated.

The **Description on Bill** displays the description of the calculation line that appears on the customer's bill.

The characteristics grid displays the **Characteristic Types** and the **Characteristic Values** associated with the calculation line.

FASTPATH:

For more information about characteristics, refer to [Setting Up Characteristic Types and Their Values](#).

How and When To Use An Adjustment

NOTE:

A last resort. Adjustments should be viewed as a last resort because you should correct the cause of errors, rather than the effect. For example, if a customer's bill is incorrect, you should fix the customer's rate / meter reads / contract terms and then perform a cancel / rebill. Issuing an adjustment to fudge the balance is really just that - a fudge.

The topics in this section describe how to perform common adjustment maintenance functions.

How To Create A Transfer Adjustment

The following steps describe how to create a transfer adjustment on the Adjustment page.

NOTE:

You cannot use an adjustment type with a calculated amount for transfer adjustments.

WARNING:

These steps only make sense in the context of the page used to maintain Adjustments. Refer to [Adjustment - Main Information](#) for the details.

To create a transfer adjustment:

- Specify the "transfer from" account and service agreement on the Adjustment - Main page.
- Specify the adjustment type and the amount and transfer to the Transfer Adjustment page.
- Specify the "transfer to" service agreement and click the **Generate** and **Freeze** buttons to generate and freeze the adjustments' financial transactions. Please be aware that the **Freeze** button may be disabled for certain types of adjustments. This is because you can prevent specific types of adjustments from being frozen until the account's next bill is completed. Refer to [Preventing SA Balances And The GL From Being Impacted Until Bill Completion](#) for how to enable this feature on your adjustment types.

How To Create A Calculated Adjustment

The following steps describe how to create a [calculated adjustment](#) on the Adjustment page.

WARNING:

These steps only make sense in the context of the page used to maintain Adjustments. Refer to [Adjustment - Main Information](#) for the details.

To create a calculated adjustment:

1. Open **Menu > Financial > Adjustment > Add** and specify the **Service Agreement** that will receive the adjustment.
2. Specify the **Adjustment Type** that calculates the amount, and enter a base **Amount**.
3. Click **Generate**. The **Generate** dialog box opens.
4. In the resulting dialog box, specify an **Accounting Date** and **Generation Reference Date**. Click **Calculate**.
5. Click **Freeze** to freeze the calculated transactions.

The **Calculation Date** that you supply is used by the generate adjustment algorithm for any calculations that are effective dated (e.g., rate version calculation group or bill factor value).

Please be aware that the **Freeze** button may be disabled for certain types of adjustments. This is because you can prevent specific types of adjustments from being frozen until the account's next bill is completed. Refer to [Preventing SA Balances And The GL From Being Impacted Until Bill Completion](#) for how to enable this feature on your adjustment types.

How To Cancel An A/P Adjustment After It Has Been Selected By A/P

Adjustments that are interfaced to A/P (because A/P needs to cut a refund check) sometimes need to be canceled. You may cancel an A/P adjustment in the CIS system while its A/P request is Not Selected. If the A/P request is Requested for Payment or Paid you must first cancel the payment in A/P. Canceling the payment in A/P changes the A/P request in CIS to Canceled. At this point, you can cancel the adjustment in CIS.

How To Correct Normal Service Agreement Debt

If a customer is unhappy with the balance on a "normal" service agreement and you cannot fix the source of their unhappiness (i.e., the bills and payments), create an adjustment. Simply select an adjustment type that describes why you are adjusting the balance and enter the amount of the adjustment (a negative number if you are crediting the customer).

NOTE:

What's normal? There really is no such thing as a "normal" service agreement. We use this term to reference service agreements used to bill for services like utility service, land leases, home warranties, security monitoring, etc. where the current amount is the same as the payoff amount.

WARNING:

A service agreement that is part of a budget plan is NOT normal. Refer to [How To Adjust A Service Agreement On A Budget](#) for more information.

How To Apply Ad Hoc Fees To A Service Agreement

If you need to apply a fee (e.g., late payment charge, connection charge, NSF charge) to a "normal" service agreement, issue an adjustment using the appropriate adjustment type. The adjustment amount should be a positive number so that the customer's balance increases.

WARNING:

Take care if you apply a fee to a service agreement that's on a budget. The adjustment affects current balance and payoff balance by the amount of the fee. If you didn't mean to affect the customer's current balance, you'll have to issue another adjustment to change it.

How To Apply Interest To A Deposit

FASTPATH:

You should only have to issue adjustments to calculate and refund interest if you need to override the system's automated procedures. Refer to [Controls Interest Calculation](#) for the details.

If you need to manually apply interest to a deposit, issue an adjustment using the appropriate adjustment type. The adjustment amount should be a negative number (you are crediting the customer's deposit balance).

If you want to apply the interest to the customer's outstanding balance, refer to [How To Apply A Deposit To Outstanding Debt](#).

If you want to cut a check for the deposit, refer to [How To Refund A Deposit With A Check](#).

How To Apply A Deposit To Outstanding Debt

FASTPATH:

You should only have to issue adjustments to apply a deposit to outstanding debt if you need to override the system's automated procedures. Refer to [Refunding Deposits](#) for the details.

Applying a deposit is a two-step process:

- The deposit service agreement's payoff balance contains the amount of deposit you are holding on behalf of the customer's debt. Its current balance should be zero (i.e., the customer doesn't owe any additional deposit). Before you apply the deposit balance, we recommend making the deposit's current balance equal to the amount to be transferred. You do this by issuing an adjustment that just affects the deposit's current balance. The amount of this adjustment should be a negative number.
 - After the deposit's current balance reflects an appropriate credit amount (equal to the amount to be applied to the customer's debt), use the Transfer Adjustment process to apply the deposit's credit balance to another service agreement's debit balance. The deposit service agreement is the transfer from service agreement; the delinquent service agreement is the transfer to service agreement. The adjustment amount should be a positive number. Refer to [How To Create A Transfer Adjustment](#) for more information.
-

WARNING:

Take care if you apply a deposit to a service agreement that's on a budget. The transfer adjustment affects current balance and payoff balance by the same amount. If you didn't mean to affect the customer's current balance, you'll have to issue another adjustment to change it.

How To Refund A Deposit With A Check

FASTPATH:

You should only have to issue adjustments to apply a deposit to outstanding debt if you need to override the system's automated procedures. Refer to [Refunding Deposits](#) for the details.

Refunding a deposit with a check (cut by your A/P system) is a two step process:

- The deposit service agreement's payoff balance contains the amount of deposit you are holding on behalf of the customer's debt. Its current balance should be zero (i.e., the customer doesn't owe any additional deposit). Before you refund the deposit balance, we recommend making the deposit's current balance equal to the amount to be refunded. You do this by issuing an adjustment that just affects the deposit's current balance. The amount of this adjustment should be a negative number.
- After the deposit's current balance reflects an appropriate credit amount (equal to the amount to be refunded), issue a refund adjustment. The adjustment amount should be a positive number. This adjustment causes a check request to be interfaced to your A/P system.

How To Write-Down Deposit Due

If a customer doesn't pay their deposit and you don't expect them to, create an adjustment to write-down the current balance. Simply select an adjustment type that describes why you are adjusting the balance and enter the amount of the adjustment (a negative number).

How To Refund A Credit Balance With A Check

If you need to refund a credit balance on a "normal" service agreement, issue a refund adjustment using the appropriate adjustment type. The adjustment amount should be a positive number. This adjustment causes a check request to be interfaced to your A/P system.

WARNING:

Take care if you refund a credit balance from a service agreement that's on a budget. The adjustment affects current balance and payoff balance by the amount of the refund. If you didn't mean to affect the customer's current balance, you'll have to issue another adjustment to change it.

How To Transfer A Credit Balance To A Service Agreement In Arrears

Use the Transfer Adjustment process to apply a "normal" service agreement's credit balance to another service agreement's debit balance. The credit service agreement is the transfer from service agreement; the delinquent service agreement is the transfer to service agreement. The adjustment amount should be a positive number. Refer to [How To Create A Transfer Adjustment](#) for more information.

WARNING:

Take care if you apply a credit to a service agreement that's on a budget. The transfer adjustment affects current balance and payoff balance by the transfer amount. If you didn't mean to affect the customer's current balance, you'll have to issue another adjustment to change it.

How To Change The Age Of Debt

If a service agreement's debt is older (or younger) than what it should be (for whatever reason), you should do the following.

- Use the Transfer Adjustment process to re-age the debt. The transfer from and transfer to service agreements will be the same. The adjustment amount should be a negative number. Refer to [How To Create A Transfer Adjustment](#) for more information.
- After creating the transfer adjustment, drill into the transfer to adjustment and populate the arrears date with the day on which the debt should start aging (e.g., if the debt should be 7 days old, the arrears date should be the current date minus 7 days).

WARNING:

Be careful if you transfer debt from a service agreement that's on a budget. Before doing the transfer, you should make the customer's current balance equal their payoff balance.

How To Write-Down A Charitable Contribution Service Agreement Debt

If a customer doesn't want to contribute as much to the charity as the agreed to, create an adjustment to fix the current balance (charity service agreements shouldn't have a payoff balance as the "debt" is voluntary). Simply select an adjustment type that describes why you are adjusting the balance and enter the amount of the adjustment (a negative number).

How To Write-Off Debt

To write-off debt:

WARNING:

You don't have to do the tasks outlined below if you use the [Write Off - Main](#) page. This page does these tasks for you.

- Create a write-off service agreement using the Start Service page (you could also use the Service Agreement page to do this).
 - Use the Transfer Adjustment process to transfer the delinquent debt to the to the write-off service agreement. The original service agreement is the transfer from service agreement; the write-off service agreement is the transfer to service agreement. The adjustment amount should be a negative number. Refer to [Transfer Adjustments](#) for more information.
-

WARNING:

Take care if you transfer debt from a service agreement that's on a budget. Before doing the transfer, you should make the service agreement's current balance equal their payoff balance.

How To Cancel A Service Agreement's Budget

WARNING:

You don't have to do the tasks outlined below if you use the [Account - Budget](#) panel. This panel does these tasks for you.

Canceling a service agreement's budget involves the following steps:

- Update the service agreement to indicate the service agreement is no longer on a budget.
 - Issue an adjustment to make the service agreement's current balance equal the payoff balance.
-

NOTE:

Credit and collections (C&C). You can change the arrears date on the adjustment that synchronizes current and payoff balance to reflect the true age of the debt. You do this on the financial transaction associated with the adjustment. If you do this, C&C will monitor the old debt accordingly.

How To Adjust A Service Agreement On A Budget

If you need to adjust the debt on a service agreement that's on a budget plan, you have to ask yourself why you're adjusting the balance:

- If you're adjusting the balance to correct the payoff balance (for whatever reason), choose an adjustment type that just affects this balance.
- If you're adjusting the balance to correct the current balance (for whatever reason), choose an adjustment type that just affects this balance.
- If you need to adjust both balances equally, choose an adjustment type that affects both.

How To Adjust An Installment Plan Service Agreement

If you need to adjust the debt on a service agreement that's used to bill a total amount in installments, you have to ask yourself why you're adjusting the balance:

- If you're adjusting the balance to correct the payoff balance (for whatever reason), choose an adjustment type that just affects this balance.
- If you're adjusting the balance to correct the current balance (for whatever reason), choose an adjustment type that just affects this balance.

If you need to adjust both balances equally, choose an adjustment type that affects both.

How To Use An Adjustment To Change The GL Distribution

Assume you have a frozen bill segment that affected an incorrect GL distribution code (e.g., it booked revenue to commercial - time-of-use - revenue and it should have booked it to industrial - time-of-use - revenue. You have two ways to correct such a situation:

- You could correct the cause of the incorrect distribution code (probably incorrect GL information on a calculation rule/ pricing rule) and cancel / rebill the bill segment. Refer to [Cancel / Rebill](#) for more information about this method.
- You could create an adjustment that does not impact the customer's balance but does have a GL entry. This GL entry would reverse the effect of the original distribution code and have an offsetting entry to the correct distribution code. The following points explain how to do this:
 - Choose an adjustment type that only impacts the GL (i.e., the adjustment's adjustment type has an FT algorithm that doesn't impact the customer's current or payoff balance, it only impacts the GL).
 - Enter an adjustment amount of zero.
 - Generate the adjustment.
 - Drill into the adjustment's [financial transaction](#) and enter two (or more) GL distribution rows that reflect the redistribution of the amounts.
 - Return to the adjustment and freeze it.

NOTE:

Adjusting statistical amounts. You can use the above approach to change the statistical amount that is interfaced to the general ledger. The statistical amount is simply another column on the financial transaction's GL distribution rows.

Interfacing Adjustments From External Sources

The topics in this section describe how adjustments are uploaded from an external source.

Interfacing Adjustments

The following diagram illustrates the processes involved in the uploading of adjustments into the system.

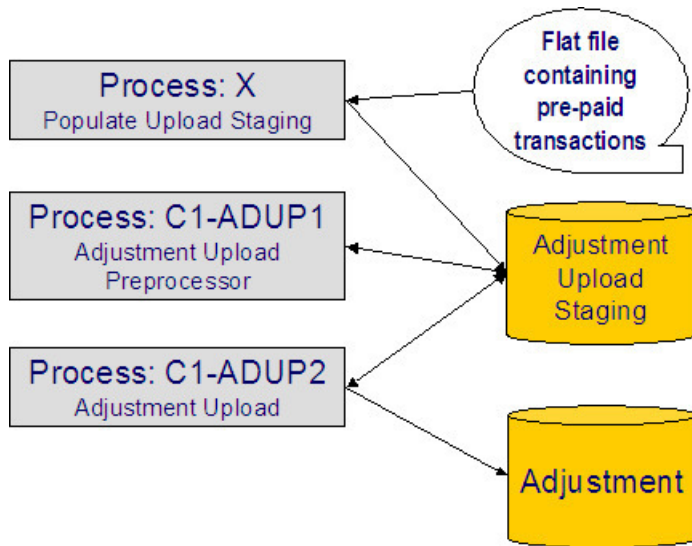

The topics in this section describe how these processes work.

Process X - Populate Adjustment Upload Records

Process X refers to the mechanism used by your organization to populate the various staging tables (shown in the orange section of the following ERD).

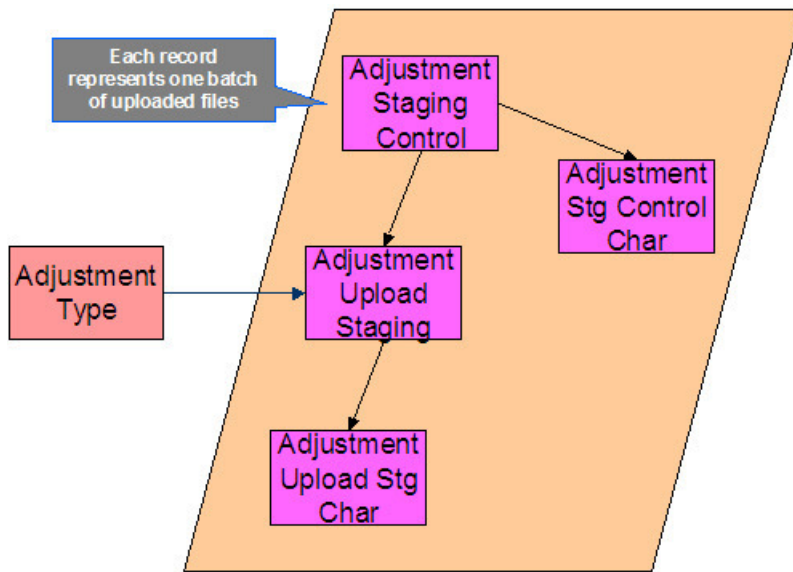

The topics in this section describe each of these tables.

Adjustment Staging Control

You must create an adjustment staging control record for each batch of adjustments to be uploaded into the system. The name of this table is CI_ADJ_STG_CTL. The following describes each column on this table.

Column Name	Length	Req'd	Data Type	Comments
ADJ_STG_CTL_ID	12	Y	N	This is the unique identifier of the adjustment staging control record. This key is a sequential number so you can use a database function to assign the value when populating the table.
CRE_DTTM	15	Y	DateTime	This is the date / time on which the adjustment staging control record was created. This must be populated with the current date / time.
ADJ_STG_CTL_STATUS_FLG	4	Y	A/N	This must be set to P for Pending.
ADJ_STG_UP_REC_CNT	10	Y	N	This is the total number of adjustment upload staging records that are linked to this adjustment staging control.
TOT_ADJ_AMT	13.2	Y	N	This column must equal the sum of

				adjustment amounts on the adjustment upload staging records that are linked to this adjustment staging control.
CURRENCY_CD	3	Y	A/N	This must be a valid currency code in the system. Refer to Defining Currency Codes for more information.
MESSAGE_CATEGORY	5	N	N	Leave this blank. The adjustment upload preprocessor populates this when an error occurs during upload.
MESSAGE_NBR	5	N	N	Leave this blank. The adjustment upload preprocessor populates this when an error occurs during upload.

Adjustment Staging Control Characteristic

You must create an adjustment staging control characteristic record for each characteristic that you would like to link to the adjustment staging control. The name of this table is CI_ADJ_STG_CTL_CHAR. The following describes each column on this table.

Column Name	Length	Req'd	Data Type	Comments
ADJ_STG_CTL_ID	12	Y	N	This must correspond with the prime key of the related CI_ADJ_STG_CTL record.
CHAR_TYPE_CD	8	Y	A/N	This must correspond with a characteristic type that is defined as valid for adjustment staging control. Refer to Setting Up Characteristic Types & Their Values for more information.
SEQ_NUM	3	Y	N	This should be set to 10 unless you have multiple values for a given adjustment staging control and characteristic type.
CHAR_VAL	16	N	A/N	Populate this field if your characteristic type is predefined.

ADHOC_CHAR_VAL	254	N	A/N	Populate this field if your characteristic type is ad-hoc or file location.
CHAR_VAL_FK1 - CHAR_VAL_FK5	50 each	N	A/N	Populate these fields if your characteristic type is foreign key reference. Up to five columns of 50 bytes each are provided to accommodate compound keys.

Adjustment Upload Staging

You must create an adjustment upload staging record for each adjustment you want to upload. The name of this table is CI_ADJ_STG_UP. The following describes each column on this table.

Column Name	Length	Req'd	Data Type	Comments
ADJ_STG_UP_ID	12	Y	N	This is the unique identifier of the adjustment upload staging record. This key is a sequential number so you can use a database function to assign the value when populating the table.
ADJ_STG_CTL_ID	12	Y	N	The ID of the adjustment staging control that is linked to this adjustment upload staging record.
ADJ_TYPE_CD	8	Y	A/N	This must correspond to the prime key of one of your adjustment types. Refer to Setting up Adjustment Types for more information.
ADJ_STG_UP_STATUS_FLG	4	Y	A/N	This must be set to P for Pending.
CREATE_DT	10	Y	Date	The date when the adjustment occurred.
ADJ_AMT	13.2	Y	N	The amount of the adjustment.
ADJ_SUSPENSE_FLG	4	Y	N	This must be set to NSUS for Not In Suspense.
SA_ID	10	N	A/N	This must correspond to a valid service agreement in the system.

If you leave this blank and opt to let the system find the SA during adjustment upload preprocessing, a Determine SA algorithm must be plugged in on the associated adjustment type. This plug-in is meant to derive the SA ID based on supplied miscellaneous information - e.g. information supplied via adjustment characteristic upload staging.

ADJ_ID	10	N	A/N	Leave this blank. The adjustment upload process populates this.
SUSPENSE_ADJ_ID	10	N	A/N	Leave this blank. The adjustment upload process populates this.
MESSAGE_CATEGORY	5	N	N	Leave this blank. The adjustment upload background processes populate this when an error occurs during upload.
MESSAGE_NBR	5	N	N	Leave this blank. The adjustment upload background processes populate this when an error occurs during upload.

Adjustment Characteristic Upload Staging

You must create an adjustment characteristic upload staging record for each characteristic that you would like to link to the adjustment upload staging. The name of this table is CI_ADJ_STG_UP_CHAR. The following describes each column on this table.

Column Name	Length	Req'd	Data Type	Comments
ADJ_STG_UP_ID	12	Y	N	This must correspond with the prime key of the related CI_ADJ_STG_UP record.
CHAR_TYPE_CD	8	Y	A/N	This must correspond with a characteristic type that is defined as valid for adjustment Refer to

[Setting Up Characteristic Types & Their Values](#) for more information.

SEQ_NUM	3	Y	N	This should be set to 10 unless you have multiple values for a given adjustment upload staging and characteristic type.
CHAR_VAL	16	N	A/N	Populate this field if your characteristic type is predefined.
ADHOC_CHAR_VAL	254	N	A/N	Populate this field if your characteristic type is ad-hoc or file location.
CHAR_VAL_FK1 - CHAR_VAL_FK5	50 each	N	A/N	Populate these fields if your characteristic type is foreign key reference. Up to five columns of 50 bytes each are provided to accommodate compound keys.

The Lifecycle of an Adjustment Staging Control Record

The following diagram shows the possible lifecycle of an adjustment staging control record.

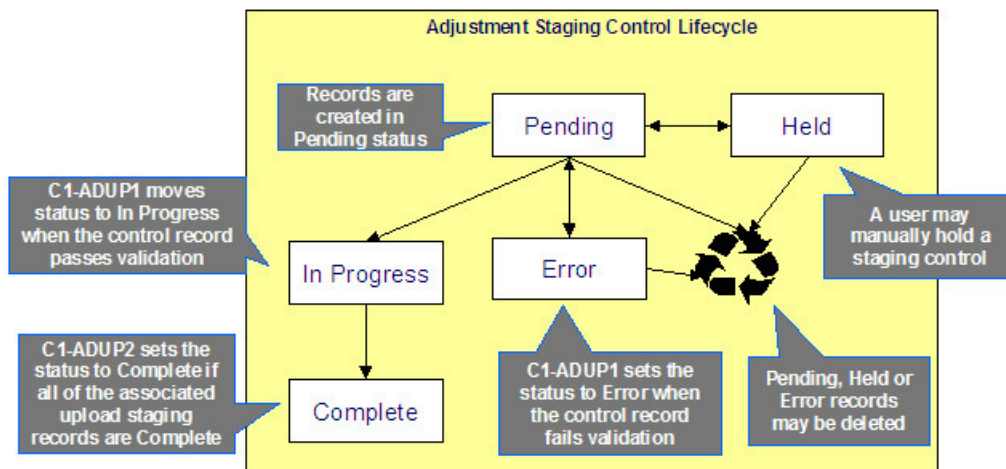

- **Pending.** An adjustment staging control record is created in this state. The C1-ADUP1 process selects pending adjustment staging control records for validation.
- **In Progress.** The C1-ADUP1 process sets a pending record to in progress when the totals on the adjustment staging control are successfully validated against the totals from the associated adjustment upload staging records.
- **Complete.** The C1-ADUP2 process sets the adjustment staging control's status to complete when all adjustment upload staging records linked to the adjustment staging control are complete.

- Error. The C1-ADUP1 process sets a pending record to error if the adjustment staging control fails validation. The status may be set back to pending after the error is fixed.
- Held. The held status is available for situations where you want to prevent or delay the upload of a batch of adjustment staging records. The status may be set back to pending when the batch of records is ready for upload.
- Pending, error and held records may be deleted.

The Lifecycle of an Adjustment Upload Staging Record

The following diagram shows the possible lifecycle of an adjustment upload staging record.

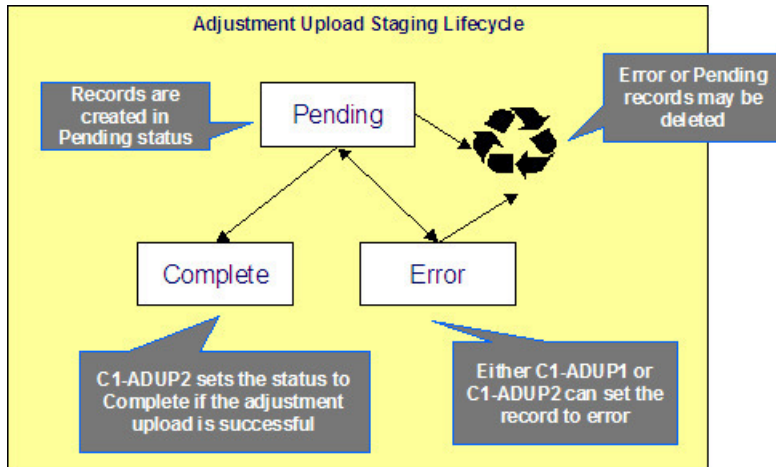

- Pending. Adjustment upload records are created in this state. The C1-ADUP2 process selects pending adjustment upload records and creates adjustments for each of them.
- Complete. The C1-ADUP2 process sets a pending record to complete if an adjustment is successfully created.
- Error. Either C1-ADUP1 or C1-ADUP2 process sets pending record to error when it encounters an error during the upload process. The status may be set back to pending after the error is fixed.
- Pending and error records may be deleted.

Process C1-ADUP1 - Preprocess Adjustment Uploads

The background process (C1-ADUP1) validates adjustment staging control records and populates service agreement IDs on adjustment upload staging records that do not specify an SA ID.

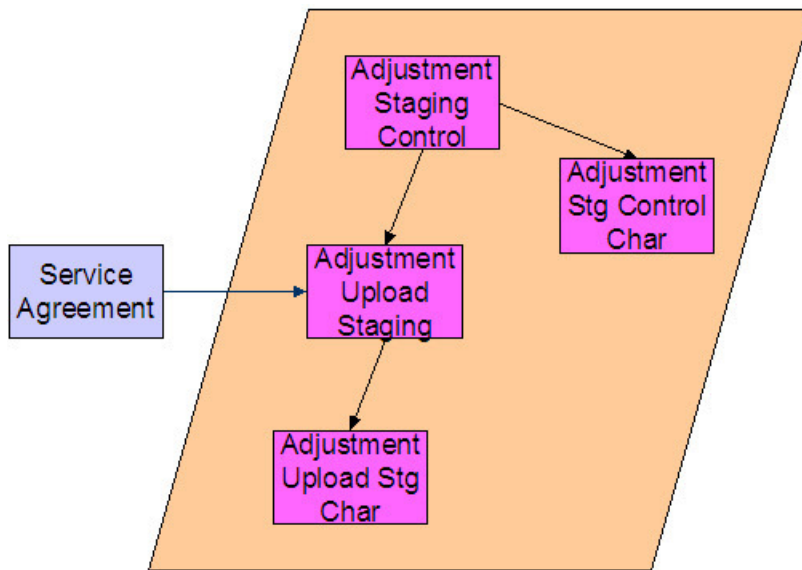

Phase 1 - Validate Adjustment Staging Controls

The following points describe, at a high level, the first phase of the adjustment upload pre-process:

- For each Pending adjustment staging control,
- Check that the record count on the adjustment staging control record equals the number of adjustment upload staging records that are linked to the adjustment staging control.
- Check that the total adjustment amount on the adjustment staging control record equals the sum of the adjustment amounts from the adjustment upload staging records that are linked to the adjustment staging control.
- If the adjustment staging control passes validation, set its status to In Progress. Otherwise, set the status to Error. Create a To Do entry using the inputs To Do type and To Do role (if supplied) for adjustment staging control errors. (Complete any outstanding To Do entries for the adjustment staging control before creating a new To Do entry.)
- If no errors occur, perform To Do cleanup by completing any outstanding To Do entries that were previously created for the adjustment staging control.

NOTE:

You can fix errors by going to the To Do entry and drilling into the adjustment staging control page. Don't forget to change the adjustment staging control's status back to Pending after fixing the error.

Phase 2 - Populate SA ID

The following points describe, at a high level, the second phase of the adjustment upload pre-process:

- For each Pending adjustment upload staging that is linked to an In Progress adjustment staging control AND does not have the SA ID,
- Execute the Determine SA algorithm that is plugged in on the [adjustment type](#).
- If the algorithm returns a valid SA ID, stamp that SA ID onto the adjustment upload staging. If the algorithm also returns an indication that the adjustment is to be put into suspense, set the suspense flag on the adjustment upload staging to In Suspense. Refer to [Suspense Adjustments](#) for more information on how suspense adjustments are handled.

- If the algorithm returns an error, set the adjustment upload staging record's status to Error. Create a To Do entry using the inputs To Do type and To Do role (if supplied) for adjustment upload staging errors. (Complete any outstanding To Do entries for the adjustment upload staging before creating a new To Do entry.)
- If no errors occur, perform To Do cleanup by completing any outstanding To Do entries that were previously created for the adjustment upload staging.

NOTE:

You can fix errors by going to the To Do entry and drilling into the adjustment upload staging page. Don't forget to change the adjustment upload staging's status back to Pending after fixing the error.

Process C1-ADUP2 - Upload Adjustments

The background process (C1-ADUP2) creates adjustments for all adjustment upload staging records that are stamped with an SA ID.

The following diagram and section describe, at a high level, the processing done in the C1-ADUP2 background process.

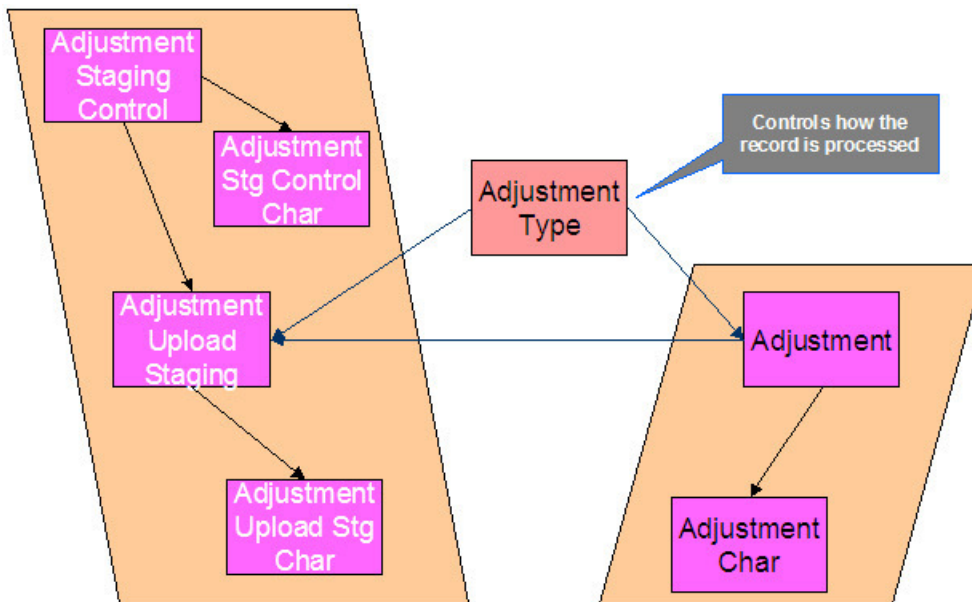

- For each Pending adjustment upload staging that has an SA ID,
- Add a frozen adjustment using the amount, creation date and adjustment type on the staging record.

NOTE:

If the type of adjustment being uploaded is one that is calculated, the algorithm that's plugged in on the adjustment type will calculate the adjustment amount and generate associated calculation lines (if applicable). See [Calculated Adjustments](#) for more information.

- If adjustment creation is successful, update the adjustment ID on the staging record and set the staging record's status to Complete.
- If adjustment creation results in an error, set the staging record's status to Error. Create a To Do entry using the To Do type on which this batch process (C1-ADUP2) is defined as creation process. (Complete any outstanding To Do entries for the adjustment upload staging before creating a new To Do entry.)

- If no errors occur, perform To Do cleanup by completing any outstanding To Do entries that were previously created for the adjustment upload staging.

Suspense Adjustments

What Are Suspense Adjustments?

When the adjustment upload preprocessor is unable to identify a valid SA ID, it can post the adjustment to a suspense SA. This is similar to how a payment is posted to a suspense account when a valid account ID could not be identified during payment upload.

Putting adjustments in suspense is optional. Therefore, this logic sits in a plug-in spot. If suspense adjustments are applicable to you, you must plug in your suspense logic in a Determine SA algorithm on [Adjustment Type](#).

How Are Suspense Adjustments Resolved?

A background process can be run periodically to automatically resolve suspense adjustments. Since rules for resolving suspense may vary, this logic sits in a plug-in spot. You must plug in your resolve logic in a Resolve Suspense algorithm on [Adjustment Type](#).

Process C1-ADURS - Resolve Suspense Adjustments

The batch process refers to the background process (C1-ADURS) that resolves suspense adjustments.

For each adjustment upload staging that is In Suspense, execute the Resolve Suspense algorithm that is plugged in on the [adjustment type](#).

Maintaining Adjustment Staging Control

Use this page to add, view or modify an adjustment staging control record. Open this page using **Menu > Financial > Adjustment Staging Control > Search**

Description of Page

Adjustment Staging Control ID is the unique identifier of the adjustment staging control record.

Create Date/Time is when the adjustment staging control was created. This field is protected after the record is saved.

Number of Staging Records is the number of adjustment upload staging records that are linked to this adjustment staging control record.

Total Adjustment Amount is the total of adjustment amounts from the adjustment upload staging records that are linked to this adjustment staging control record.

Enter the **Currency** for the total adjustment amount on the adjustment staging control. This is also the currency of the adjustment amounts on the associated adjustment upload staging records.

Status shows the state of the adjustment staging control. Possible values are: Pending, In Progress, Complete, Error, and Held.

A **Hold** button appears adjacent to the status description if **Status** is Pending. Click this button to set the status to Held. The adjustment upload process will ignore staging controls in this state.

A **Pend** button appears adjacent to the status description if **Status** is either Held or Error . Click this button to set the status to Pending. An error message box also appears below the status description if **Status** is Error.

Use the **Characteristics** collection to capture miscellaneous information about an adjustment staging control.

- **Characteristic Type** The type of characteristic.
- **Characteristics Value** The value of the characteristic.

NOTE:

You can only choose characteristic types defined as permissible on an adjustment staging control. Refer to [Setting Up Characteristic Types & Their Values](#) for more information.

Maintaining Adjustment Upload Staging

Use this page to add, view, or modify an adjustment upload staging record. Open this page using **Menu > Financial > Adjustment Upload Staging > Search**.

Description of Page

Adjustment Upload ID is the unique identifier of the adjustment upload staging record.

Adjustment Staging Control ID is the identifier of the adjustment staging control to which the adjustment upload staging is linked.

Indicate the **Adjustment Type**. This field is very important as it controls numerous aspects of the adjustment's impact on the customer's balance and your general ledger.

NOTE:

You can only choose certain adjustment types. The service agreement's SA type has a collection of valid adjustment profiles. You may only reference adjustment types that are listed in one of the adjustment type profiles linked to the SA type.

Enter an **Adjustment Amount**.

Creation Date is the date when the adjustment occurred. This will be the creation date on the uploaded adjustment. This field is protected after the record is saved.

Service Agreement indicates the SA to which the adjustment was posted. If the adjustment is in suspense, the label shows **Suspense SA** instead.

Adjustment is a reference to the adjustment that got created from the upload.

Status shows the state of the adjustment upload staging. Possible values are: Pending, Complete, and Error.

If **Status** is Error, a **Pend** button appears adjacent to the status description. In addition, an error message box displays below the status description.

If the adjustment is in suspense, a message appears to indicate the condition and the **Suspense Adjustment** is shown. A different message appears when the suspense is resolved.

Use the **Characteristics** collection to keep miscellaneous information about an adjustment upload staging.

- **Characteristic Type** The type of characteristic.
- **Characteristics Value** The value of the characteristic.

NOTE:

Default Note. An adjustment upload staging's characteristics default from the [adjustment type](#).

Credit & Collection

The system periodically monitors how much your customers owe to ensure they haven't violated your collection criteria. When a violation is detected, the system generates the appropriate events (e.g., letters, disconnect field activities, To Do entries, write-off outstanding debt, etc.). This section describes how to manage your credit & collections processing.

NOTE:

In the section, [The Big Picture Of Credit & Collection \(C&C\)](#), we describe how to set up the control tables that automate most of your credit & collections processing. If you set these tables up properly, the system will manage most of your collection, severance and write-off processes; little or no user intervention should be necessary. You will only access the C&C pages when you need to override what the system does.

The Big Picture Of Credit & Collection

The topics in this section provide background information about a variety of credit & collections issues.

Automating Your C&C Activities

FASTPATH:

Refer to [The Big Picture Of Credit & Collections \(C&C\)](#) to understand how the system monitors overdue debt and initiates the appropriate collection, severance and write-off events when a customer exceeds your debt tolerances.

The Lifecycle Of A Collection Process And Its Events

The following diagram illustrates the lifecycle of a typical collection process and its collection events:

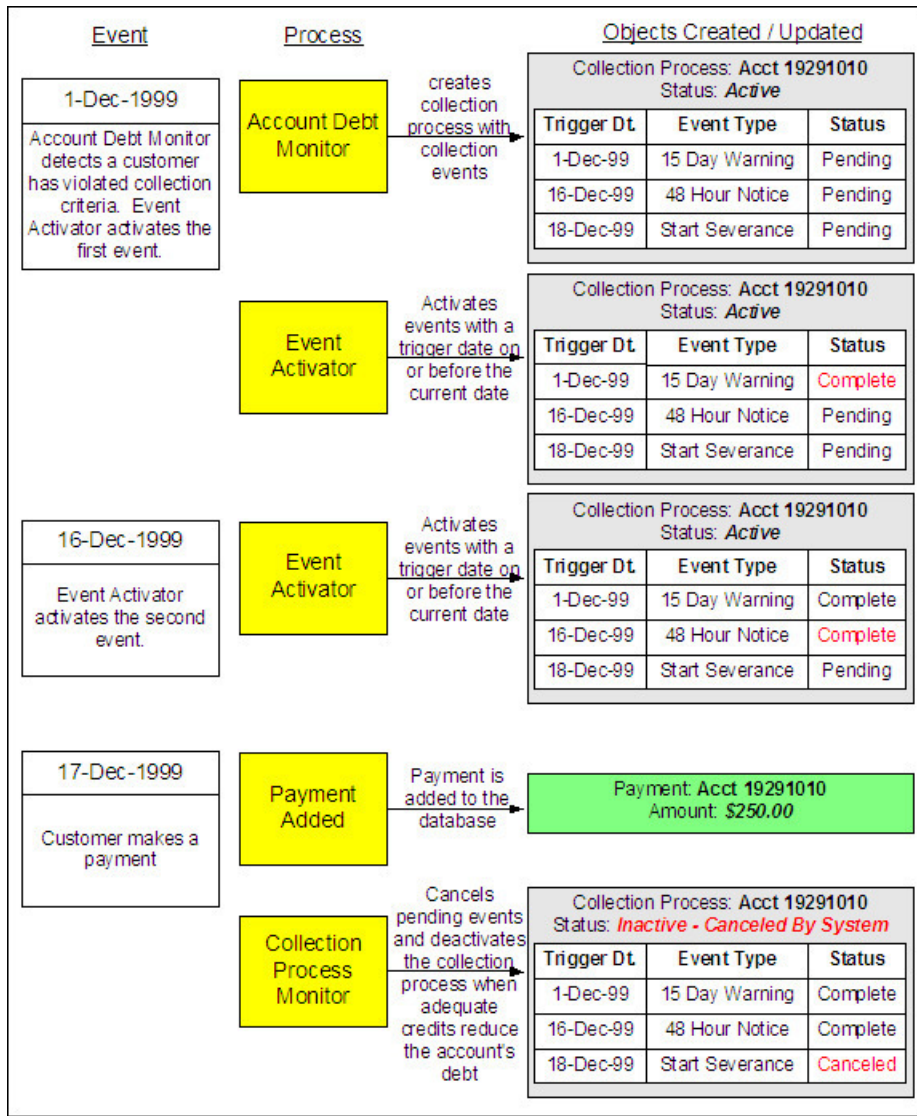

The preceding diagram is referenced in the following topics.

What Is A Collection Process?

A collection process is a series of events (e.g., letters, To Do entries) meant to encourage an account to pay its delinquent debt. Linked to the collection process are the specific service agreements that contributed to the delinquent debt.

How Are Collection Processes Created?

A collection process and its events may be created as follows:

- The Account Debt Monitor is a background process that creates a collection process when an account violates your collection criteria. The collection process has one or more collection event(s). The collection process template associated with the collection process controls the number and type of events.

- A user may create an ad hoc collection process at will. The collection process template controls the number and type of events linked to the collection process.

In the above diagram, the event on 1-Dec-99 shows the creation of a collection process with three collection events. Notice that the events all exist in the Pending state. The events will exist in this state until their trigger date is on or before the current date.

FASTPATH:

Refer to [How Does The Account Debt Monitor Work?](#) to understand how the system monitors overdue debt and initiates the appropriate collection process when a customer exceeds your debt tolerances. Refer to [The Big Picture Of Collection Events](#) for more information about a collection process' events.

When you enable the Control Central alert algorithm, C1-COLLPR-AC, an alert displays when an account has an active collection process. This algorithm is plugged-in on the [installation record](#).

How Are Collection Events Completed?

The event activator runs periodically (at least daily). It looks for collection events with a trigger date on or before the current date. For each such event, the system executes its activity and then completes it.

In the above diagram, the event activator activates pending events on 1-Dec-99 and 16-Dec-99. Notice that the events are moved to the Complete state.

FASTPATH:

Refer to [The Big Picture Of Collection Events](#) for more information about the various types of collection events and what happens when they are completed.

How Are Collection Processes (and their Events) Canceled?

FASTPATH:

Refer to [How Are Collection Processes Cancelled](#) for a description of how and when collection processes are automatically cancelled by the system.

Besides the automated cancellation process, a user may cancel a collection process at will. Refer to [How To Cancel A Collection Process](#) for more information.

What Happens If A Payment Is Not Received?

If a payment (or some other type of credit) is not received by the trigger date of the last event in the process, a severance process is initiated for one or more service agreements. Refer to [The Last Collection Event Should Sever Service Agreement\(s\)](#) for more information.

The Collection Process Background Processes

There are three background processes that automate the creation, activation, and cancellation of collection processes:

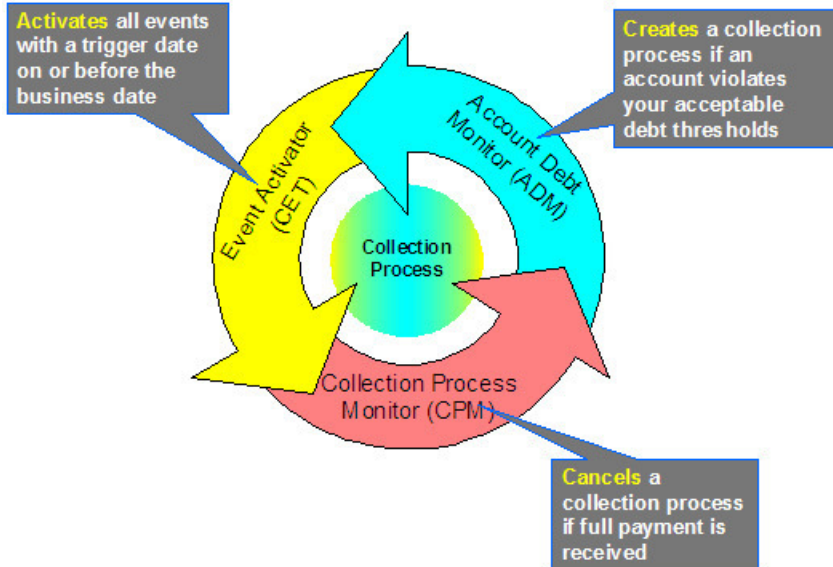

Account Debt Monitor

The Account Debt Monitor (ADM) creates a collection process when an account violates your collection criteria. The collection process has one or more collection event(s). The number and type of events is defined on the collection process's template.

This process has an optional input parameter for CIS Division. It can be used if your implementation requires processing of data by CIS Division. You will need to create a copy of this process's batch control for each CIS Division.

NOTE:

Monitoring account debt is usually done based on a schedule triggered by system events such as a bill or canceled payment. If too much time has gone by since the last debt review, the account can be selected for debt monitoring as well. ADM has an optional input parameter **Include Minimum Days Review**. When set, accounts that have gone too long since their last review are selected along with those scheduled to be reviewed. The minimum days between review is defined on the [customer class](#)

A separate background process (ADM2) only selects accounts based on the minimum days. This process can be used when the option to include minimum days on ADM has not been set. ADM2 does not have an option to be run by CIS Division.

ADM2 does not have an option to be run by CIS Division.

In the above [diagram](#), the account debt monitor creates a collection process (with 3 events) on 1-Dec-99. Notice that the events all exist in the Pending state. The events will exist in this state until their trigger date is on or before the current date.

FASTPATH:

Refer to [How Does The Account Debt Monitor Work](#) for more information.

Collection Event Activator

The Collection Event Activator (CET) runs periodically (at least daily). It looks for collection events with a trigger date on or before the current date. For each such event, the system executes its activity and then completes it.

This process has an optional input parameter for CIS Division. It can be used if your implementation requires processing of data by CIS Division. You will need to create a copy of this process's batch control for each CIS Division.

In the above [diagram](#), the collection event activator activates pending events on 1-Dec-99 and 16-Dec-99. Notice that the events are moved to the Complete state after they are activated.

Collection Process Monitor

The Collection Process Monitor (CPM) runs periodically (at least daily). This process reviews a collection process whenever one of its service agreements' debt is reduced.

This process has an optional input parameter for CIS Division. It can be used if your implementation requires processing of data by CIS Division. You will need to create a copy of this process's batch control for each CIS Division.

At review time, the Collection Process Monitor determines if it can cancel the collection process (because the customer's debt is no longer in a bad state). Refer to [How Does The Collection Process Monitor Work](#) for details describing how this process works.

In the above [diagram](#), the collection process monitor cancels the process on 17-Dec-99. Notice that the events are moved to the Cancelled state and the process becomes Inactive.

The Lifecycle Of A Severance Process And Its Events

The following diagram illustrates the first part of the lifecycle of a typical severance process and its events:

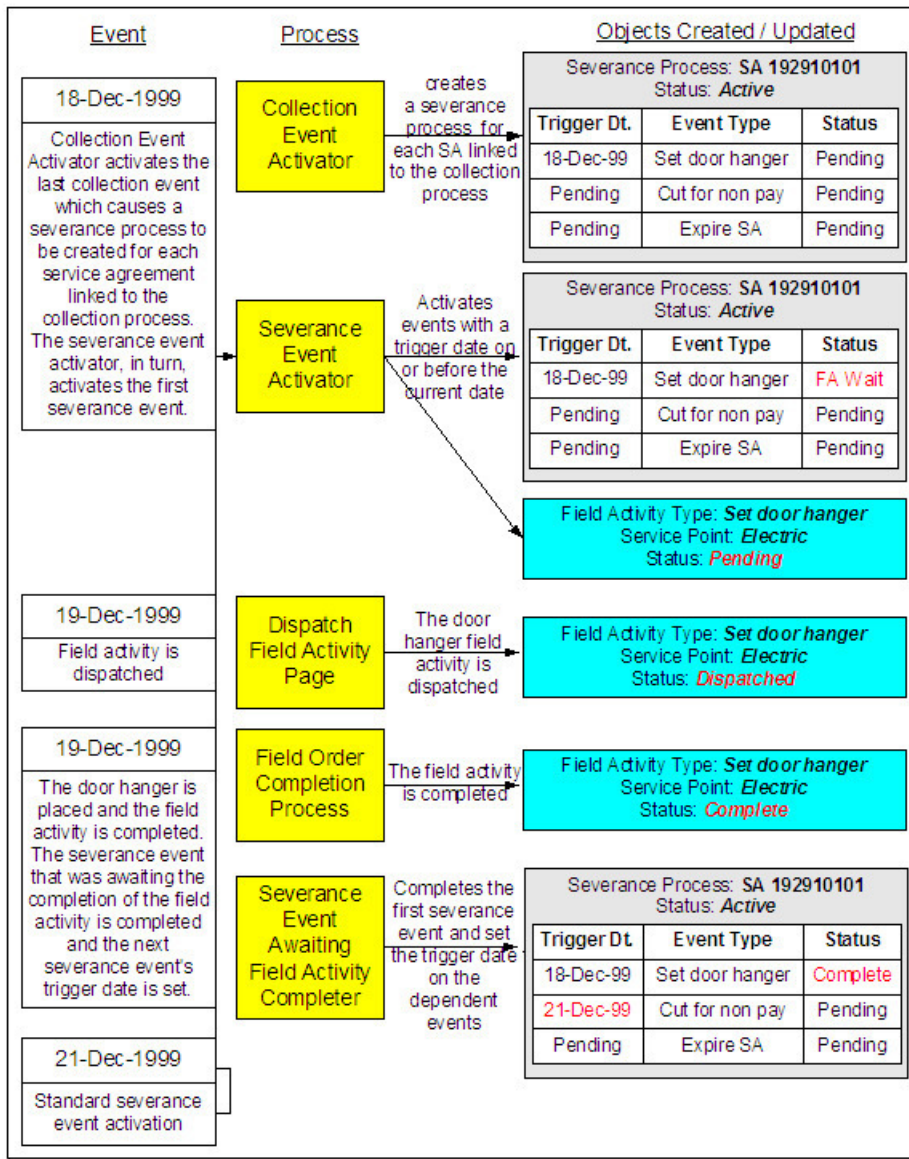

The preceding diagram is referenced in the following topics.

What Is A Severance Process?

A severance process is a series of events (e.g., letters, To Do entries, field activities) that lead to the severance of a service agreement. A separate severance process is required for each service agreement to be severed.

How Are Severance Processes Created?

Severance processes may be created as follows:

- The Collection Event Activator creates a severance process when it completes a "start severance process" collection event. The severance process has one or more severance event(s). The severance process template associated with the severance process controls the number and type of events.

- A user may create an ad hoc severance process at will. The severance process template defined when the severance process is created controls the number and type of events linked to the severance process.

NOTE:

Manual Creation. A user can create a severance process for an account that does not qualify to be on severance according to the cancel criteria algorithm. For example, perhaps your cancel criteria algorithm cancels a severance process when the account's debt falls below a threshold amount. A user can create a severance process for an account whose debt is already below this threshold. Because cancellation is real time, there is no action that will cause this severance process to be canceled. When a manual severance process is created, the system executes the appropriate cancellation criteria algorithm. If the algorithm indicates that the system would have canceled this severance process, a warning is issued. Refer to [How Are Severance Processes Cancelled](#) for more information about cancellation algorithms.

In the above diagram, the event on 18-Dec-99 shows the creation of a severance process with three collection events. Notice that only the first event has a trigger date, this is because the later events' trigger date can only be determined after the first event is completed. Also, notice that the events all exist in the Pending state. The events will exist in this state until their trigger date is on or before the current date.

FASTPATH:

Refer to [How Are Collection Events Completed?](#) for more information about the completion of collection events.

When you enable the Control Central Alert installation algorithm, C1-SEVPR-ACT, an alert displays when an account has an active severance process. This algorithm is plugged-in on the [installation record](#).

How Are Severance Events Completed?

The Severance Event Activator runs periodically (at least daily). It looks for severance events with a trigger date on or before the current date. For each such event, the system executes its activity. The type of severance event dictates what happens to the severance event's state. Refer to [Field Events Versus Office Events](#) for the details.

In the above diagram, the event activator activates a pending event on 18-Dec-99. Take note of the state of the severance event (it becomes Awaiting Field Activity Completion).

FASTPATH:

Refer to [The Big Picture Of Severance Events](#) for more information about the various types of severance events and what happens when they are completed.

How Are Severance Processes (and their Events) Canceled?

FASTPATH:

Refer to [How Are Severance Processes Cancelled](#) for a description of how the system automatically cancels a severance process.

NOTE:

Real time cancellation. Unlike collection processes, the system cancels severance processes real time (i.e., there is no equivalent of the collection process monitor for severance processes). Why are severance processes canceled real time? Because a severance process may have events that create field activities to sever service. These events need to be canceled the moment the FT is frozen, we can't wait until a background process runs. This means that if a customer pays in person for a service agreement that is pending severance, the system will cancel the process and its field activities

(if any) the moment the payment is entered. The logic to cancel the field activities is in an algorithm plugged in on the [installation record](#).

FASTPATH:

Refer to [Setting Up Severance Process Templates](#) for more information about severance process templates. Refer to [Designing Your Reconnection Procedures](#) for more information about how severance processes are used to reconnect services.

Besides the automated cancellation process, a user may cancel a severance process at will.

What Happens If The Customer Does Not Pay?

If a payment (or some other type of credit) is not received by the trigger date of the last event in the severance process, the service agreement is stopped (as long as you've setup your severance process to include an Expire Service Agreement event as the last event). The expiration of the last service agreement will, in turn, trigger a final bill. If the account doesn't pay the final bill, a write-off process will be started.

NOTE:

Final bills. The account will be setup for final billing when the LAST service agreement linked to the account is stopped. Refer to [Finalizing Pending Stops](#) for more information about how the system changes the account's bill cycle when the last service agreement is stopped.

FASTPATH:

Refer to [The Big Picture Of Write Off Processing](#) for more information about the write off process.

The Severance Process Background Processes

The Collection Event Activator creates a severance process when it completes a "start severance process" collection event. The severance process has one or more severance event(s). The severance process template associated with the severance process controls the number and type of events. There are 3 background processes that automate the activation and cancellation of severance events:

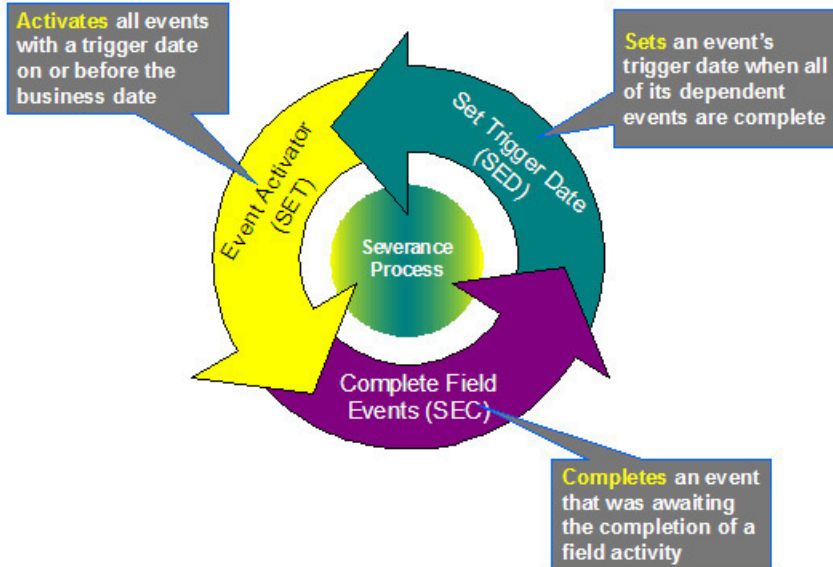

Severance Event Activator

The Severance Event Activator (SET) runs periodically (at least daily). It looks for severance events with a trigger date on or before the current date. For each such event, the system executes its activity. The type of severance event dictates what happens to the severance event's state.

This process has an optional input parameter for CIS Division. It can be used if your implementation requires processing of data by CIS Division. You will need to create a copy of this process's batch control for each CIS Division.

In the above [diagram](#), the event activator activates a pending event on 18-Dec-99. Take note of the state of the severance event (it becomes Awaiting Field Activity Completion).

Completing Severance Events That Are Dependent On The Completion Of A Field Activity

The Complete Field Events (SEC) process runs periodically (at least daily). It looks for severance events that are dependent on the completion of field activities before they can be completed. The system completes each such event when the field activities linked to the event are complete.

This process has an optional input parameter for CIS Division. It can be used if your implementation requires processing of data by CIS Division. You will need to create a copy of this process's batch control for each CIS Division.

In the above [diagram](#), this process completes the event that was Awaiting Field Activity Completion on 19-Dec-99. Take note of the state of the severance event (it becomes Complete).

Set Trigger Date

The Set Trigger Date (SED) process runs periodically (at least daily). It looks for severance events that are dependent on the completion of other events before their trigger date can be set. The system sets the trigger date of each such event when all of its dependent events are complete.

This process has an optional input parameter for CIS Division. It can be used if you implementation requires processing of data by CIS Division. You will need to create a copy of this process's batch control for each CIS Division.

In the above [diagram](#), this process sets the trigger date of the second event on 19-Dec-99.

The Lifecycle Of A Write-Off Process And Its Events

The following diagram illustrates the lifecycle of a typical write-off process and its write-off events:

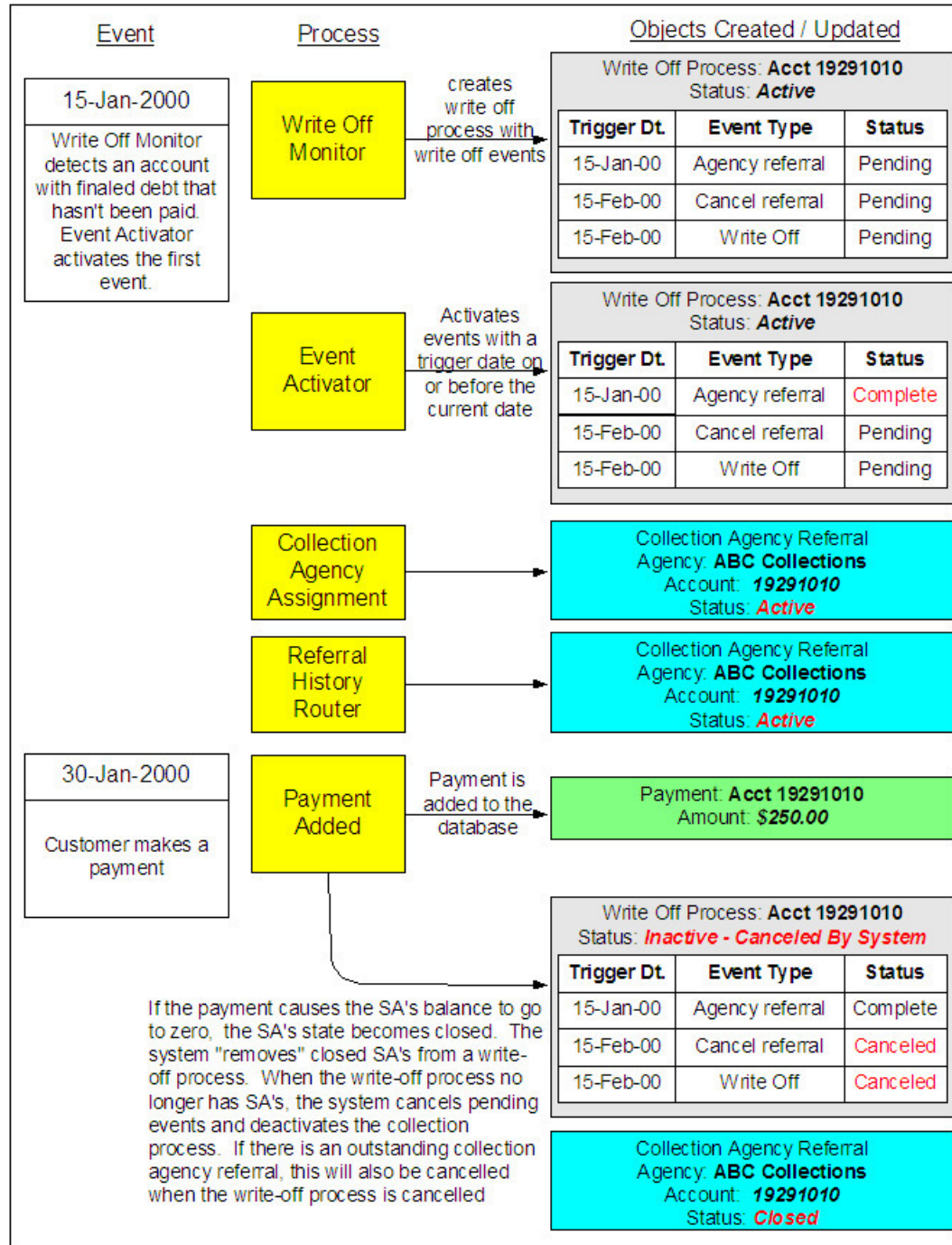

The above diagram is referenced in the following topics.

What Is A Write-Off Process?

A write-off process is a series of events (e.g., letters, collection agency referrals) meant to encourage an account to pay its delinquent debt. Linked to the write-off process are the specific service agreements that contributed to the delinquent debt.

How Are Write-Off Processes Created?

A write-off process and its events may be created as follows:

- The Write Off Monitor is a background process (WPM) that creates a write-off process when an account has finalized, unpaid service agreements. The write-off process has one or more write-off event(s). The write-off process template associated with the write-off process controls the number and type of events.
- A user may create an ad hoc write-off process at will. The write-off process template controls the number and type of events linked to the write-off process.

In the above diagram, the event on 15-Jan-00 shows the creation of a write-off process with three write-off events. Notice that the events all exist in the Pending state. The events will exist in this state until their trigger date is on or before the current date.

FASTPATH:

Refer to [How Does The Write-Off Monitor Work?](#) to understand how the system monitors overdue debt and initiates the appropriate write-off process when a customer has unpaid, finalized service agreements. Refer to [The Big Picture Of Write-off Events](#) for more information about a write-off process' events.

How Are Write-Off Events Completed?

The event activator runs periodically (at least daily). It looks for write-off events with a trigger date on or before the current date. For each such event, the system executes its activity and then completes it.

In the above diagram, the event activator activates a pending event on 15-Jan-00. Notice that the events are moved to the Complete state.

FASTPATH:

Refer to [The Big Picture Of Write-off Events](#) for more information about the various types of write-off events and what happens when they are completed.

How Are Write-Off Processes (and their Events) Canceled?

When a stopped service agreement's balance is reduced to zero (i.e., it closes), the system checks if there is an ongoing write-off process associated with the service agreement. If so:

- The system "removes" the service agreement from the write-off process.
- When the last service agreement is removed from a write-off process, the system cancels all pending write-off events and deactivates the write-off process.
- If the canceled process has collection agency referrals, the system cancels the referrals.

NOTE:

Real time cancellation. Unlike collection processes, the system cancels write-off processes real time (i.e., there is no equivalent of the collection process monitor for write-off processes). This means that if a customer (or collection agency) pays for a service agreement that is linked to write-off process, the system will cancel the process and its collection agency referrals (if any) the moment the payment is entered.

FASTPATH:

Refer to [Setting Up Write Off Process Templates](#) for more information about write off process templates.

Besides the automated cancellation process, a user may cancel a write-off process at will.

What Happens If The Debt Is Not Paid?

If a payment (or some other type of credit) is not received by the trigger date of the last event in the process, the debt will be written off (assuming you designed your write off process template to do such).

NOTE:

The last write-off event should cause debt to be written off. Debt will only be written off if the last write-off event is the type that writes off debt. If the write-off process template contains no such event, nothing further will transpire until the next time the write-off monitor runs (when it will create another write-off process for the unpaid, finaled debt).

FASTPATH:

Refer to [How Is Debt Financially Written-Off?](#) for a description of exactly how debt is written off.

How Is Debt Referred To Collection Agencies

FASTPATH:

Refer to [How Do Collection Agency Referrals Work?](#) for more information about how the system refers debt to a collection agency.

The Write-Off Process Background Processes

There are 2 background processes that automate the creation, activation, and cancellation of write-off processes:

NOTE:

If necessary, you can write-off debt outside of the automated write-off process by simply transferring bad debt to a write-off service agreement using the Write Off transaction.

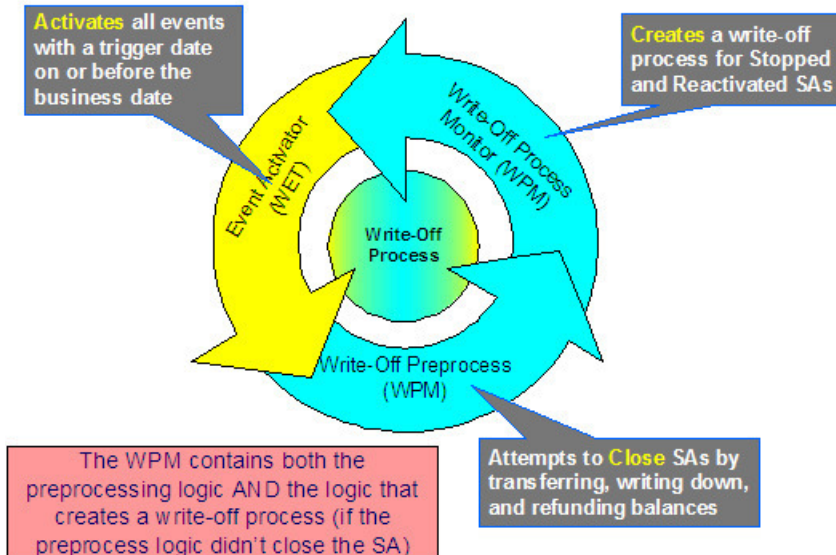

Write-Off Monitor

The Write-Off Monitor (WPM) is a background process that has two functions:

- It attempts to close Stopped and Reactivated service agreements using several methods as described under [Attempt To Close The SA Before Creating A Write Off Process](#).
- If it is unsuccessful at closing a SA, it creates a write-off process. The write-off process has one or more write-off event(s). The write-off process template associated with the write-off process controls the number and type of events.

This process has an optional input parameter for CIS Division. It can be used if your implementation requires processing of data by CIS Division. You will need to create a copy of this process's batch control for each CIS Division.

In the above [diagram](#), the event on 15-Jan-2000 shows the creation of a write-off process with three write-off events. Notice that the events all exist in the Pending state. The events will exist in this state until their trigger date is on or before the current date.

Write-Off Event Activator

The Write-Off Event Activator (WET) runs periodically (at least daily). It looks for write-off events with a trigger date on or before the current date. For each such event, the system executes its activity and then completes it.

This process has an optional input parameter for CIS Division. It can be used if your implementation requires processing of data by CIS Division. You will need to create a copy of this process's batch control for each CIS Division.

In the above [diagram](#), the write-off event activator activates a pending event on 15-Jan-2000. Notice that the event is moved to the Complete state.

Collection Process Maintenance

A collection process is a series of events (e.g., letters, To Do entries) meant to encourage an account to pay its delinquent debt. Linked to the collection process are the specific service agreements that contributed to the delinquent debt. The topics in this section describe the pages on which collection process-related information is maintained.

FASTPATH:

For more information about collection processes, refer to [The Lifecycle Of A Collection Process And Its Events](#).

Collection Process - Main Information

The Main page contains core collection process information. Open this page using **Menu > Credit & Collection > Collection Process > Search**.

FASTPATH:

The **Description of Page** section below describes the fields on this page. Refer to [How To Perform Common Collection Process Functions](#) for more instructions describing how to use this transaction.

Description of Page

Collection Process is a concatenation of summary information about this collection process. It is composed of the name of the main customer on the account, the collection status, the reason code for the collection status, the collection class control name, and the creation date of the process.

Collection Process ID is the unique system-generated identifier for this collection process.

Account ID is the system-generated account number. The name of the main customer on the account and its customer class are displayed next to the ID number.

Collection Status defines the state of the collection process. The following values may exist:

Active The system creates a collection process in the Active state. A collection process remains in this state until the last event linked to the process is complete OR the customer pays the collection amount on the service agreements linked to the process OR you want to stop the process for whatever reason.

Inactive A collection process becomes Inactive when the last event linked to the process is completed OR the customer pays the collection amount on all service agreements linked to the process OR you want to stop the process for whatever reason. The **Reason** field tells you how a collection process became inactive.

FASTPATH:

To completely understand the significance of a collection process' status, refer to [The Lifecycle Of A Collection Process And Its Events](#).

Reason defines how a collection process became Inactive or why a collection process is Active. The following values may exist:

Canceled by User This reason should be used when a user manually inactivates a collection process (for whatever reason).

Canceled by System This reason is populated by the system when it cancels a collection process. The system automatically cancels a collection process when sufficient credits have been posted to the process' service agreements since the process was started.

Events Pending This reason is populated by the system when a process has pending events.

Completed This reason is populated by the system when it completes the last event linked to the collection process.

Collection Class Control defines the debt class (i.e., the type of debt) associated with the collection process. This is important as it controls which service agreements can be linked to the collection process (every service agreement is associated with a specific debt class). This field is gray when there are service agreements linked to the collection process.

NOTE:

Multiple collection processes may be linked to an account. It's important to be aware that if an account's service agreements reference multiple debt classes, a collection process must be created for each debt class that you want to collect.

One collection process per debt class. A given debt class for an account may only have one ongoing collection process at any point in time.

Beneath **Collection Class Control** is displayed a message showing why the system generated the collection process. This information is only displayed for collection processes created by the Account Debt Monitor. If you have plugged in a Collection Process Additional Information algorithm on the [Installation](#) record, the results of the algorithm, if any, is displayed on a separate line.

The following line displays the minimum value payment to the collection process debt class that will cause cancellation of the collection process.

FASTPATH:

For more information, refer to [How Does The Account Debt Monitor Work?](#).

Collection Process Template defines the collection events in the process. You can override these events on the **Events** page.

NOTE:

Changing the template. If you change the template when all events are pending, the system will remove the pending events and replace them with the new template's events.

FASTPATH:

For more information, refer to [Setting Up Collection Process Templates](#).

Creation Date/Time defines the start date/time of the collection process. This is important as it affects the trigger dates of the process' collection events. This field becomes protected after the collection process exists on the database. If you need to change the trigger date on the events you can navigate to the **Events** tab and change the dates manually. Alternatively, you can perform the following "trick":

- Change the **Collection Process Template** to something (anything). Doing this causes the **Create Date/Time** to become unprotected.
- Specify the date of the first collection event in the newly unprotected **Create Date/Time**.
- Change the **Collection Process Template** back to the desired value. When you change the template, the system removes the events and creates new ones using the **Create Date/Time**.

The collection process cancellation logic will cancel a collection process when its account's debt no longer exceeds a given amount (you define this threshold amount when you set up the system). Rather than compare an account's total debt to the threshold amount, the cancellation logic compares the account's debt that is older than X days to the threshold amount. X is the date specified in **Collection Amount Base Date**. You can have the system calculate this date for you by entering the age of the arrears in the field embedded in **Calculate Date Using ___ Days In Arrears**.

FASTPATH:

For more information, refer to [How Are Collection Processes \(and their Events\) Canceled?](#)

Enter any **Comments** about the collection process.

The [tree](#) at the bottom of the page shows a variety of information about the **account** and the collection process including:

- The service agreements linked to the collection process.
- The events linked to the collection process.
- The amount of debt currently associated with the account's debt classes.
- Whether a pay plan exists for the account, or existed at the time the collection process was created.
- The balance for any service agreements linked to the collection process in Inactive status but that have credit balances contributing to the overall debt class arrears for the account.
- A summary of other active collection activities (i.e., collection, severance and write-off processes) associated with the account.

Collection Process - SAs (Service Agreements)

The SA page contains the service agreements whose debt is being collected by the collection process. Open this page using **Menu > Credit & Collection > Collection Process > Search** and navigate to the **SAs** page.

FASTPATH:

The **Description of Page** section below describes the fields on this page. Refer to [How To Perform Common Collection Process Functions](#) for more instructions describing how to use this transaction.

Description of Page

The top portion of every page in this page contains the following information:

Collection Process is a concatenation of summary information about this collection process. It is composed of the name of the main customer on the account, the collection status, the reason code for the collection status, the collection class control name, and the creation date of the process.

ID is the unique system-generated identifier for this collection process.

The **Collection SAs** scroll contains the service agreement being collected under this collection process. To modify a service agreement linked to the collection process, simply move to a field and change its value. To add a new service agreement, press the + button to insert a row, then fill in the information for each field. The following fields display:

Service Agreement ID identifies the service agreement being collected. Information about the service agreement is displayed beneath the SA ID.

Status defines the state of the service agreement in respect of the collection process. The following values may exist:

Active An Active service agreement is one currently being collected by the collection process. The service agreement will remain in this state until the last event linked to the process is complete OR the customer pays the collection amount on the service agreement OR you want to remove the service agreement from the collection process for whatever reason.

Inactive A service agreement becomes Inactive within the collection process when the last event linked to the process is completed OR the customer pays the collection amount on the service agreement OR you want to remove the service agreement from the collection process for whatever reason

The **Collection Amount** is the amount of debt that initially triggered the collection process. This will be zero for collection processes that were created manually.

The **Amount Still Owing** is the amount of debt older than the **Collection Amount Base Date** defined on the Main page.

The **Credit Amount** is displayed if the Amount Still Owing is less than zero.

The **SA Balances** area displays how much is owed for the service agreement. The **Days Old** and **Arrears Amount** information shows how old the current balance is. This information will be blank if the current balance is a credit.

NOTE:

Information about debt balances by age is not applicable to [open-item accounts](#).

Current Balance indicates the amount the customer currently owes for the service. **Payoff Balance** indicates the amount the customer would owe if they wanted to close the service agreement. This value is only displayed when it differs from the current balance.

FASTPATH:

Refer to [Current Amount versus Payoff Amount](#) for more information.

Collection Process - Events

The events page contains the activities that will be performed to persuade the customer to pay the outstanding debt. Open this page using **Menu > Credit & Collection > Collection Process > Search** and navigate to the **Events** page.

FASTPATH:

The **Description of Page** section below describes the fields on this page. Refer to [How To Perform Common Collection Process Functions](#) for more instructions describing how to use this transaction.

NOTE:

We strongly recommend that you understand the information described in [How Are Collection Events Completed?](#) before using this page.

FASTPATH:

The number and type of events associated with a collection process are defined by the process's collection process template (which is defined on the first page). Refer to [Setting Up Collection Process Templates](#) for more information.

Description of Page

The top portion of every page in this page contains the following information:

Collection Process is a concatenation of summary information about this collection process. It is composed of the name of the main customer on the account, the collection status, the reason code for the collection status, the collection class control name, and the creation date of the process.

ID is the unique system-generated identifier for this collection process.

The **Collection Events** scroll contains the collection events that comprise the collection process. Only one event is displayed at a time. The inner scroll controls the display of the customer contacts that were created by the system when a particular collection event was triggered.

Event Sequence is the unique identifier of the event.

Collection EventStatus defines the state of the event. The following diagram shows the possible lifecycle of a collection event:

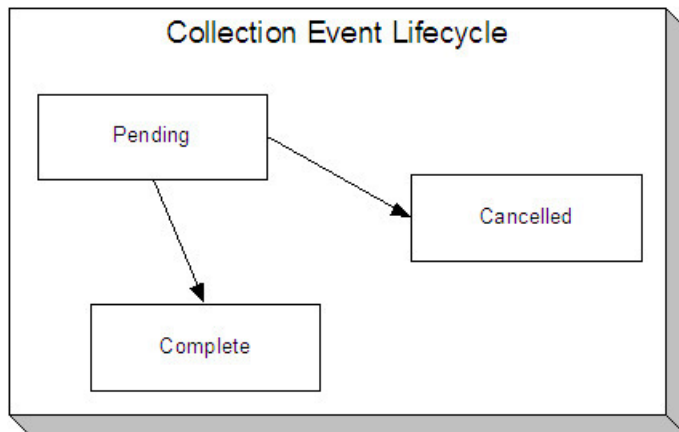

Collection events are initially created in the pending state.

When the system sees a pending event with a **Trigger Date** on or before the current date, the system executes the event's activity and completes the event.

You can cancel an individual collection event by setting the status to cancelled.

The **Collection Event Type** defines the event's activity (e.g., Email sent, a To Do entry is generated, a letter is sent).

FASTPATH:

For more information, refer to [Setting Up Collection Process Templates](#).

The **Trigger Date** defines the date when the system completes (i.e., executes) the event.

FASTPATH:

For more information about a collection event's trigger date, see [Collection Event Trigger Date](#).

If the status of the event is complete, the **Completion Date** is displayed with the date on which the system completes the event. If the status of the event is cancelled, the **Canceled Date** is displayed with the date on which the event was system canceled.

The **Customer Contact** information contains information when the event template causes a letter to be generated (because letters are created by customer contacts).

How To Perform Common Collection Process Functions

The topics in this section describe how to perform common collection process maintenance functions. Refer to [The Lifecycle Of A Collection Process](#) for more information about collection processes. Refer to [The Big Picture Of Collection Processing](#) for high-level information about collection processing.

How To Create A Collection Process

99.9% of all collection processes are created by the [Account Debt Monitor](#) and require no human intervention before they are executed (refer to [How Are Collection Processes Created](#) for information about how the account debt monitor creates collection processes). The other 0.1% are created by users on-line / real time. The following points describe how to create the 0.1%.

- Use **Control Central** to choose the account that requires a new collection process.

- After the account is populated on Control Central, choose the **Collection Process > Add** option on the account context menu to transfer to the collection process transaction in add mode.
- After the Collection Process - Main page appears, specify the appropriate **Collection Class Control**. **Collection Class Control** defines the debt class (i.e., the type of debt) associated with the collection process. This is important as it controls which service agreements can be linked to the collection process (every service agreement is associated with a specific debt class). It's important to be aware that if an account's service agreements reference multiple debt classes, a collection process must be created for each debt class that you want to collect. Also be aware that a given debt class for an account may only have one ongoing collection process at any point in time.
- Choose a **Collection Process Template**. **Collection Process Template** defines the collection events in the process. You can override these events on the Events page. For more information, refer to [Setting Up Collection Process Templates](#).
- Use **Collection Amount Base Date** to define the arrears cutoff date that the system uses when it "removes" a SA from a collection process. The system removes a SA from a collection process when its debt older than X is less than or equal to zero. X is the date specified in **Collection Amount Base Date**. You can have the system calculate this date for you by entering the age of the arrears in the field embedded in **Calculate Date Using ___ Days In Arrears**.
- Navigate to the **SAs** page to define the specific service agreement's whose debt is covered by this collection process. You must define at least one service agreement.
- Save the collection process.

How To Change Collection Events

When a collection process is first created, it has one or more collection events. The events are the activities that will be performed to persuade the customer to pay the outstanding debt.

The number and type of events that are created when a collection process is initiated are defined on the collection process's collection process template. The following points describe how to add / change / delete events on a collection process if the defaulted events are not satisfactory.

- Use **Control Central** to choose the account with the collection process whose events need to be changed.
After the account is populated on Control Central, choose the **Collection Process > Search** option on the account context menu to transfer to the collection process transaction in update mode.

To add a new event, transfer to the **Events** tab and press the + button in the **Collection Events** scroll to add a new event. At this point, the event has not been added to the database; rather, it just exists in memory. Before you add the event to the database, you must specify the following information:
 - Choose an **Event Sequence** so that the new event will be positioned properly in respect of the other events.
 - Choose a **Collection Event Status** of Pending.
 - Choose the desired **Collection Event Type**.
- Use **Trigger Date** to define the date on which the event should be activated (i.e., completed).
To delete an existing event, transfer to the **Events** tab and use the scroll arrows to toggle to the desired collection event. When the desired collection event appears, press the - button to remove the event. At this point, the event has not been removed from the database; rather, it's been removed in memory.

To change an existing event, transfer to the **Events** tab and use the scroll arrows to toggle to the desired collection event. When the desired collection event appears, make the desired changes.

After all desired changes have been made, save the collection process.

How To Cancel A Collection Process

The [Collection Process Monitor](#) will automatically "remove" service agreements from a collection process when their debt has been reduced sufficiently. When all service agreements are "removed" from a collection process, the collection process is canceled. The following points describe how to manually cancel a collection process.

- Use **Control Central** to choose the account with the collection process to be cancelled.
- After the account is populated on Control Central, choose the **Collection Process > Search** option on the account context menu to transfer to the collection process transaction in update mode. A list of all collection processes associated with the account appears. If only one collection process exists, it is automatically selected for you.
- On the **Main** tab, click Cancel.
- When the warning dialog appears, click OK to continue. The collection process and its pending events are canceled.

Severance Process Maintenance

A severance process is a series of events (e.g., field orders, letters, To Do entries) meant to encourage an account to pay its delinquent debt. Linked to the severance process is the specific service agreement being severed. The topics in this section describe the pages on which severance process-related information is maintained.

FASTPATH:

For more information about severance processes, refer to [The Lifecycle Of A Severance Process And Its Events](#).

Severance Process - Main Information

The Main page contains core severance process information. Open this page using **Menu > Credit & Collection > Severance Process > Search**.

FASTPATH:

The **Description of Page** section below describes the fields on this page. Refer to [How To Perform Common Severance Process Functions](#) for more instructions describing how to use this transaction.

Description of Page

The top portion of every page in this page contains the following information:

Severance Process is a concatenation of summary information about this severance process. It is composed of the name of the main customer on the account, the division and SA type, and severance process template code, the process status, the reason code for the process status and the creation date of the process.

Severance Process ID is the unique system-generated identifier for this severance process.

The remaining fields are maintained on the main severance process page.

Service Agreement ID is the system-generated identifier of the service agreement to which the severance process is linked. Adjacent to the ID number is summary information about the SA.

Severance Status defines the state of the severance process. The following values may exist:

Active The system creates a severance process in the Active state. A severance process remains in this state until the last event linked to the process is complete OR the customer pays the collection amount associated with the severance process OR you want to stop the process for whatever reason. The **Reason** field tells you why a severance process is still in the active state.

Inactive A severance process becomes Inactive when the last event linked to the process is completed OR the customer pays the collection amount on the severance process OR you want to stop the process for whatever reason. The **Reason** field tells you how a severance process became inactive.

FASTPATH:

To completely understand the significance of a severance process' status, refer to [The Lifecycle Of A Severance Process And Its Events](#).

Reason defines how a severance process became Inactive or why a severance process is Active. The following values may exist:

Canceled by User This reason should be used when a user manually inactivates a severance process (for whatever reason).

Canceled by System This reason is specified by the system when it cancels a severance process. The system automatically cancels a severance process when sufficient credits have been posted to the process' service agreement since the process was started.

Events Pending This reason is specified by the system when a process has pending events.

Completed This reason is specified by the system when it completes the last event linked to the severance process.

Severance Process Template defines the severance events in the process. You can override these events on the **SeveranceEvents** page. If you change the template after events exist, the system will remove the existing events and replace them with the new template's events.

FASTPATH:

For more information, refer to [Setting Up Severance Process Templates](#).

Create Date/Time defines the start date/time of the severance process. This is important as it affects the trigger dates of the process' severance events. This field becomes protected after the severance process exists on the database. If you need to change the trigger date on the events you can navigate to the **Events** tab and change the dates manually. Alternatively, you can perform the following "trick":

- Change the **Severance Process Template** to something (anything). Doing this causes the **Create Date/Time** to become unprotected.
- Specify the date of the first severance event in the newly unprotected **Create Date/Time**.
- Change the **Severance Process Template** back to the desired value. When you change the template, the system removes the events and creates new ones using the **Create Date/Time**.

The **Collection Amount** is the amount of debt that initially triggered the severance process.

The **Amount Still Owning** is the amount of debt older than the **Severance Amount Base Date**.

The severance process cancellation logic will cancel a severance process when its SA's debt no longer exceeds a given amount (you define this threshold amount when you set up the system). Rather than compare a SA's total debt to the threshold amount, the cancellation logic compares the SA's debt that is older than X days to the threshold amount. X is the date specified in **Severance Amount Base Date**. You can have the system calculate this date for you by entering the age of the arrears in the field embedded in **Calculate Date Using __ Days In Arrears**.

FASTPATH:

For more information, refer to [How Are Severance Processes \(and their Events\) Canceled?](#)

Enter any **Comments** about the severance process.

The [tree](#) at the bottom of the page shows a variety of information about the **service agreement's** account and the severance process including:

- The events linked to the severance process.

- The amount of debt associated with the account's debt classes.
- A summary of other active severance activities (i.e., severance, severance and write-off processes) associated with the **service agreement's** account.

Severance Process - Severance Events

The events page contains the activities that will be performed to persuade the customer to pay the outstanding debt. Open this page using **Menu > Credit & Collection > Severance Process > Search** and navigate to the **Events** page.

FASTPATH:

The **Description of Page** section below describes the fields on this page. Refer to [How To Perform Common Severance Process Functions](#) for more instructions describing how to use this transaction.

NOTE:

We strongly recommend that you understand the information described in [How Are Severance Events Completed?](#) before using this page.

FASTPATH:

The number and type of events associated with a severance process are defined by the process's severance process template (which is defined on the first page). Refer to [Setting Up Severance Process Templates](#) for more information.

Description of Page

The top portion of every page in this page contains the following information:

Severance Process is a concatenation of summary information about this severance process. It is composed of the name of the main customer on the account, the SA business unit and SA type, set ID and severance process template name, the process status, the reason code for the process status and the creation date of the process.

ID is the unique system-generated identifier for this severance process.

The **Severance Events** scroll contains the severance events that comprise the severance process. The grid at the bottom (when visible) shows the events that must be completed before the severance event is triggered. Only one severance event is displayed at a time.

Event Sequence is the unique identifier of the event.

Severance EventStatus defines the state of the event.

FASTPATH:

For more information, refer to [Severance Event Lifecycle](#).

The **Severance Event Type** defines the event's activity (e.g., a field order is generated, a To Do entry is generated, a letter is sent).

FASTPATH:

For more information, refer to [Setting Up Severance Event Templates](#).

If **Dependent on Other Events** is turned on, then the event's trigger date is only determined after the event(s) on which it depends are completed. When this switch is on, a grid appears at the bottom of the page in which you define the event(s) on which this event depends.

FASTPATH:

For more information about dependent events, see [Severance Event Dependencies & Trigger Date](#).

The **Trigger Date** defines the date when the system completes (i.e., executes) the event. This field is gray when the event is dependent on the completion of other events.

FASTPATH:

For more information about a severance event's trigger date, see [Severance Event Dependencies & Trigger Date](#).

Days After Prev Response defines how a dependent event's trigger date is calculated. The trigger date is set equal to X days after the last dependent event is completed, where X is the number in this field. This field is gray when the event is not dependent on other events.

FASTPATH:

For more information about dependent events, see [Severance Event Dependencies & Trigger Date](#).

If the status of the event is complete, the **Completion Date** is displayed with the date on which the system completes the event. If the status of the event is cancelled, the **Canceled Date** is displayed with the date on which the event was canceled. The grid at the bottom of the page contains the events on which this event depends. This grid is only visible when the event is dependent on other events (as defined by the Dependent on Other Events switch). To add additional sequences press the + button (insert row), and define the sequence of the event on which this event depends.

Severance Process - Field Activity/Customer Contact

The Field Activity/Customer Contact page contains information about the objects created when the system completes the event. Open this page using **Menu > Credit & Collection > Severance Process > Search** and navigate to the **FA/CC** page.

FASTPATH:

What happens when a severance event is completed (i.e., executed) is dictated by the severance event's template. Refer to [Types Of Severance Events](#) for more information.

Description of Page

The top portion of every page in this page contains the following information:

Severance Process is a concatenation of summary information about this severance process. It is composed of the name of the main customer on the account, the SA business unit and SA type, set ID and severance process template name, the process status, the reason code for the process status and the creation date of the process.

ID is the unique system-generated identifier for this severance process.

The **Severance Events** scroll contains the severance events that comprise the severance process. The grids show the objects created when the system completes each event.

The **Field Activity/SP** grid contains information about the field activities that were created when the event was activated. This information will only be populated with the event's event type causes a field activity to be generated.

The **Customer Contact** area contains information about the customer contacts that were created when the event was activated. This information will only be populated with the event's event type causes a customer contact to be created (note, letters are generated via the creation of a customer contact).

How To Perform Common Severance Process Functions

The topics in this section describe how to perform common severance process maintenance functions. Refer to [The Lifecycle Of A Severance Process](#) for more information about severance processes. Refer to [The Big Picture Of Severance Processing](#) for high level information about severance processing.

How To Create A Severance Process

99.9% of all severance processes are created when a "start severance" collection event is activated by the [Collection Event Activator](#) and require no human intervention before they are executed (refer to [How Are Severance Processes Created](#) for information about how the account debt monitor creates severance processes). The other 0.1% are created by users on-line / real time. The following points describe how to create the 0.1%.

- Use **Control Central** to choose the account that requires a new severance process.
- After the account is populated on Control Central, choose the **Severance Process > Add** option on the account context menu to transfer to the severance process transaction in add mode. If the account has multiple service agreements, you must select the service agreement to be severed.
- After the Severance Process - Main page appears, specify a **Severance Process Template**. **Severance Process Template** defines the severance events in the process. You can override these events on the Events page. For more information, refer to [Setting Up Severance Process Templates](#).
- Use **Severance Amount Base Date** to define the arrears cutoff date that the system uses when it determines if a severance process can be cancelled. The system cancels a severance process when its SA's debt that is older than X is less than or equal to zero. X is the date specified in **Severance Amount Base Date**. You can have the system calculate this date for you by entering the age of the arrears in the field embedded in **Calculate Date Using ___ Days In Arrears**.
- Save the severance process.

How To Change Severance Events

When a severance process is first created, it has one or more severance events. The events are the activities that will be performed to persuade the customer to pay the outstanding debt.

The number and type of events that are created when a severance process is initiated are defined on the severance process's severance process template. The following points describe how to add / change / delete events on a severance process if the defaulted events are not satisfactory.

- Use **Control Central** to choose the account with the severance process whose events need to be changed. After the account is populated on Control Central, choose the **Severance Process > Search** option on the account context menu to transfer to the severance process transaction in update mode.
- To add a new event, transfer to the **Events** tab and press the + button in the **Severance Events** scroll to add a new event. At this point, the event has not been added to the database; rather, it just exists in memory. Before you add the event to the database, you must specify the following information:
- Choose an **Event Sequence** so that the new event will be positioned properly in respect of the other events.
- Choose a **Severance Event Status** of Pending.
- Choose the desired **Severance Event Type**.

- If the activation of the new event is dependent on the successful completion of earlier events, turn on **Dep on Other Event** and then a) specify the sequences of the dependent events in **Event Dependencies** and b) specify the number of days after the completion of the last dependent event when the new event should be activated.
- If the activation of the new event is NOT dependent on the successful completion of earlier events, turn off **Dep on Other Event** and use **Trigger Date** to define the date on which the event should be activated (i.e., completed).
To delete an existing event, transfer to the **Events** tab and use the scroll arrows to toggle to the desired severance event. When the desired severance event appears, press the - button to remove the event. At this point, the event has not been removed from the database; rather, it's been removed in memory.

To change an existing event, transfer to the **Events** tab and use the scroll arrows to toggle to the desired severance event. When the desired severance event appears, make the desired changes.

After all desired changes have been made, save the severance process.

How To Cancel A Severance Process

The system will automatically cancel a severance process when its service agreement's debt has been reduced sufficiently. Refer to [How Are Severance Processes and Events Cancelled](#) for more information.

The following points describe how to manually cancel a severance process.

- Use **Control Central** to choose the account with the severance process to be cancelled.
- After the account is populated on Control Central, choose the **Severance Process > Search** option on the account context menu to transfer to the severance process transaction in update mode. A list of all severance processes associated with the account appears. If only one severance process exists, it is automatically selected for you.
- On the **Main** tab, click Cancel.
- When the warning dialog appears, click OK to continue. The severance process and its events are canceled.

Write-Off Process Maintenance

A write-off process is a series of events (e.g., letters, collection agency referrals) meant to encourage an account to pay its unpaid, finaled debt. Linked to the write-off process are the specific service agreements that contributed to the delinquent debt. The topics in this section describe the pages on which write-off process-related information is maintained.

FASTPATH:

For more information about write-off processes, refer to [The Lifecycle Of A Write Off Process And Its Events](#).

Write Off Process - Main Information

The Main page contains core write-off process information. Open this page using **Menu > Credit & Collection > Write Off Process > Search**.

FASTPATH:

The **Description of Page** section below describes the fields on this page. Refer to [How To Perform Common Write-Off Process Functions](#) for more instructions describing how to use this transaction.

Description of Page

The top portion of every page contains the following information:

Write Off Process is a concatenation of summary information about this write-off process. It is composed of the name of the main customer on the account, the write-off status, the reason code for the write-off status, the write-off class control name, and the creation date of the process.

Write Off Process ID is the unique system-generated identifier for this write-off process.

The remaining fields are maintained on the main write-off process page.

Account ID is the system-generated account number. The name of the main customer on the account and its customer class are displayed adjacent.

Write-off Status defines the state of the write-off process. The following values may exist:

Active The system creates a write-off process in the Active state. A write-off process remains in this state until the last event linked to the process is complete OR the finalized debt is paid off OR you want to stop the process for whatever reason.

Inactive A write-off process becomes Inactive when the last event linked to the process is completed OR the finalized debt is paid off OR you want to stop the process for whatever reason. The **Reason** field tells you how a write-off process became inactive.

FASTPATH:

To completely understand the significance of a write-off process' status, refer to [The Lifecycle Of A Write Off Process And Its Events](#).

Reason defines how a write-off process became Inactive or why a write-off process is Active. The following values may exist:

Canceled by User This reason should be used when a user manually inactivates a write-off process (for whatever reason).

Canceled by System This reason is populated by the system when it cancels a write-off process. The system automatically cancels a write-off process when all finalized debt associated with the process' service agreements is paid.

Events Pending This reason is populated by the system when a process has pending events.

Completed This reason is populated by the system when it completes the last event linked to the write-off process.

Write Off Control defines the write-off debt class (i.e., the type of debt) associated with the write-off process. This is important as it controls which service agreements can be linked to the write-off process (every service agreement is associated with a specific write-off debt class). This field is gray when there are service agreements linked to the write-off process.

NOTE:

Multiple write-off processes may be linked to an account. It's important to be aware that if an account's service agreements reference multiple write-off debt classes, a write-off process is created for each write-off debt class that you want to write-off.

Multiple write-off processes per write-off debt class. A given write-off debt class for an account may have multiple ongoing write-off processes at any point in time. However, a given service agreement may only be on one active write-off process at any point in time.

Write Off Process Template defines the write-off events in the process. You can override these events on the **Events** page.

NOTE:

Changing the template. If you change the template when all events are pending, the system will remove the pending events and replace them with the new template's events.

FASTPATH:

For more information, refer to [Setting Up Write Off Process Templates](#).

Create Date/Time defines the start date/time of the write-off process. This is important as it affects the trigger dates of the process' write-off events. This field becomes protected after the write-off process exists on the database. If you need to change the trigger date on the events you can navigate to the **Events** tab and change the dates manually. Alternatively, you can perform the following "trick":

- Change the Write-off Process Template to something (anything). Doing this causes the **Create Date/Time** to become unprotected.
- Specify the date of the first write-off event in the newly unprotected **Create Date/Time**.
- Change the **Write-off Process Template** back to the desired value. When you change the template, the system removes the events and creates new ones using the **Create Date/Time**.

Enter any **Comments** about the write-off process.

The [tree](#) at the bottom of the page shows a variety of information about the **account** and the write-off process including:

- The service agreements linked to the write-off process.
- The events linked to the write-off process.
- The amount of debt associated with the account's debt classes.
- A summary of other active collection activities (i.e., collection, severance and write-off processes) associated with the **account**.

Write Off Process - SAs (Service Agreements)

The SA page contains the service agreements whose unpaid, finalized debt is being managed by the write-off process. Open this page using **Menu > Credit & Collections > Write Off Process > Search** and navigate to the **SAs** page.

FASTPATH:

The **Description of Page** section below describes the fields on this page. Refer to [How To Perform Common Write-Off Process Functions](#) for more instructions describing how to use this transaction.

Description of Page

The top portion of every page in this page contains the following information:

Write Off Process is a concatenation of summary information about this write-off process. It is composed of the name of the main customer on the account, the write-off status, the reason code for the write-off status, the write-off control name, and the creation date of the process.

ID is the unique system-generated identifier for this write-off process.

To modify a service agreement linked to the write-off process, simply move to a field and change its value. To add a new service agreement, press + to insert a row, then fill in the information for each field. The following fields display:

Service Agreement identifies the service agreement being collected. Information about the service agreement is displayed adjacent.

Write Off SA Status defines the state of the service agreement in respect of the write-off process. The following values may exist:

Active An Active service agreement is one currently being collected by the write-off process. The service agreement will remain in this state until the last event linked to the process is complete OR the service agreement is closed (due to payment in full) OR you want to remove the service agreement from the write-off process for whatever reason.

Inactive A service agreement becomes Inactive when the last event linked to the process is completed OR the service agreement is closed (due to payment in full) OR you want to remove the service agreement from the write-off process for whatever reason

The **Write Off Amount** is the amount of debt that initially triggered the write-off process.

The **SA Balances** area displays how much is owed for the service agreement. The **Days Old** and **Amount** information shows how old the current balance is. This information will be blank if the current balance is a credit.

Current Balance indicates the amount the customer currently owes for the service. **Payoff Balance** indicates the amount the customer would owe if they wanted to close the service agreement. This value is only displayed when it differs from the current balance.

FASTPATH:

Refer to [Current Amount versus Payoff Amount](#) for more information.

Write Off Process - Events

The events page contains the activities that will be performed to persuade the customer to pay the outstanding debt. Open this page using **Menu > Credit & Collection > Write Off Process > Search** and navigate to the **Events** page.

FASTPATH:

The **Description of Page** section below describes the fields on this page. Refer to [How To Perform Common Write-Off Process Functions](#) for more instructions describing how to use this transaction.

NOTE:

We strongly recommend that you understand the information described in [How Are Write-off Events Completed?](#) before using this page.

FASTPATH:

The number and type of events associated with a write-off process are defined by the process's write-off process template (which is defined on the first page). Refer to [Setting Up Write Off Process Templates](#) for more information.

Description of Page

The top portion of every page in this page contains the following information:

Write Off Process is a concatenation of summary information about this write-off process. It is composed of the name of the main customer on the account, the write-off status, the reason code for the write-off status, the write-off class control name, and the creation date of the process.

ID is the unique system-generated identifier for this write-off process.

The **Write Off Events** scroll contains individual write-off events that comprise the write-off process. Only one event is displayed at a time. The grid contains the customer contacts that were created by the system when a particular write-off event was triggered (if any).

Event Sequence is the unique identifier of the event.

Write Off EventStatus defines the state of the event. The following diagram shows the possible lifecycle of a write-off event:

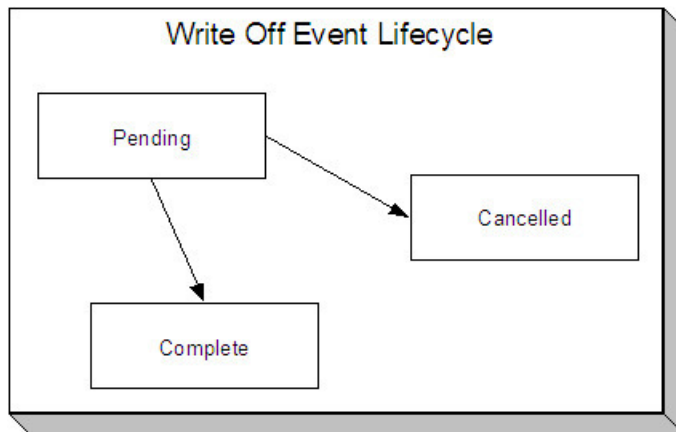

Write-off events are initially created in the pending state.

When the system sees a pending event with a **Trigger Date** on or before the current date, the system executes the event's activity and completes the event.

You can cancel an individual write off event by setting the status to cancelled.

The **Write Off Event Type** defines the event's activity (e.g., the related debt is referred to a collection agency, a To Do entry is generated, a letter is sent).

FASTPATH:

For more information refer to [Setting Up Write Off Process Templates](#).

The **Trigger Date** defines the date when the system completes (i.e., executes) the event.

FASTPATH:

For more information about a write-off event's trigger date, see [Write-off Event Trigger Date](#).

If the status of the event is complete, the **Completion Date** is displayed with the date on which the system completed the event. If the status of the event is cancelled, the **Canceled Date** is displayed with the date on which the event was cancelled.

The **Customer Contact** information contains information when the event template causes a letter to be generated (because letters are created by customer contacts).

How To Perform Common Write-Off Process Functions

The topics in this section describe how to perform common write-off process maintenance functions. Refer to [The Lifecycle Of A Write-off Process](#) for more information about write-off processes. Refer to [The Big Picture Of Write-off Processing](#) for high level information about write-off processing.

How To Create A Write-Off Process

99.9% of all write-off processes are created by the [Write-Off Monitor](#) and require no human intervention before they are executed (refer to [How Are Write-off Processes Created](#) for information about how the account debt monitor creates write-off processes). The other 0.1% are created by users on-line / real time. The following points describe how to create the 0.1%.

- Use **Control Central** to choose the account that requires a new write-off process.

- After the account is populated on Control Central, choose the **Write Off Process > Add** option on the **account context menu** to transfer to the write-off process transaction in add mode.
- After the Write-off Process - Main page appears, specify the appropriate **Write Off Control**. **Write Off Control** defines the debt class (i.e., the type of debt) associated with the write-off process. This is important as it controls which service agreements can be linked to the write-off process (every service agreement is associated with a specific debt class). It's important to be aware that if an account's service agreements reference multiple write-off debt classes, a write-off process must be created for each write-off debt class that you want to collect.
- Choose a **Write Off Process Template**. **Write Off Process Template** defines the write-off events in the process. You can override these events on the Events page. For more information, refer to [Setting Up Write-off Process Templates](#).
- Navigate to the **SAs** page to define the specific service agreement's whose debt is covered by this write-off process. You must define at least one service agreement.
- Save the write-off process.

How To Change Write Off Events

When a write-off process is first created, it has one or more write-off events. The events are the activities that will be performed in the course of the write-off process.

The number and type of events that are created when a write-off process is initiated are defined on the write-off process's write-off process template. The following points describe how to add / change / delete events on a write-off process if the defaulted events are not satisfactory.

- Use **Control Central** to choose the account with the write-off process whose events need to be changed.
After the account is populated on Control Central, choose the **Write Off Process > Search** option on the account context menu to transfer to the write-off process transaction in update mode.

To add a new event, transfer to the **Events** tab and press the + button in the **Write Off Events** scroll to add a new event. At this point, the event has not been added to the database; rather, it just exists in memory. Before you add the event to the database, you must specify the following information:
- Choose an **Event Sequence** so that the new event will be positioned properly in respect of the other events.
- Choose a **Write Off Event Status** of Pending.
- Choose the desired **Write Off Type Code**.
- Use **Trigger Date** to define the date on which the event should be activated (i.e., completed).
To delete an existing event, transfer to the **Events** tab and use the scroll arrows to toggle to the desired write-off event. When the desired write-off event appears, press the - button to remove the event. At this point, the event has not been removed from the database; rather, it's been removed in memory.

To change an existing event, transfer to the **Events** tab and use the scroll arrows to toggle to the desired write-off event. When the desired write-off event appears, make the desired changes.

After all desired changes have been made, save the write-off process.

How To Cancel A Write-Off Process

The system will automatically "remove" service agreements from a write-off process when the close (i.e., when their balance becomes zero). When all service agreements are "removed" from a write-off process, the write-off process is cancelled. Refer to [How Are Write off Processes and Events Cancelled](#) for more information.

The following points describe how to manually cancel a write-off process.

- Use **Control Central** to choose the account with the write-off process to be cancelled.

- After the account is populated on Control Central, choose the **Write Off Process > Search** option on the **account** context menu to transfer to the write-off process transaction in update mode. A list of all write-off processes associated with the account appears. If only one write-off process exists, it is automatically selected for you.
- On the **Main** tab, click Cancel.
- When the warning dialog appears, click OK to continue. The write off process and its pending events are canceled.

Writing Off Uncollectable Debt

The Write-off pages described in this section describe the transaction used to manually transfer bad debt to a write-off service agreement.

Write Off - Main

Most write-offs happen behind-the-scenes as part of the automated write-off processing. If you need to perform a partial write-off or cannot wait for the automated process, open **Menu > Credit & Collection > Write Off > Search**.

FASTPATH:

Refer to [The Big Picture of Write Off Processing](#) for background information about the write-off process.

Description of Page

Account contains the name of the main customer on the account. The **Account ID** is the account whose debt is being written off.

The **Candidate SAs** scroll contains one row for each of the account's service agreements that is eligible for write-off. The system displays the respective age and amount of each SA's debt. The accumulated total of all such debt appears in **Write Off Amount**. The checkbox adjacent to this field is used to confirm that you want to write-off the adjacent debt.

When you click the **Create** button, the system writes off the selected debt by executing the write-off algorithm that's plugged in on the account's **customer class**. Refer to [The Ramifications of Write Offs in the General Ledger](#) for an explanation of how the base-package algorithm (CCWO-DST) works.

How To Manually Write-Off Debt

To manually write-off debt:

- Select the **Account** in question on [Write Off - Main](#).
- Select the debt to be written off for each **Candidate SA**. You do this by turning on the checkbox adjacent to **Write Off Amount**. You can also vary the amount of the **Write Off Amount**.
- Click the **Create** button.

Write Off - Write Off SAs

The Write Off SAs page shows all write-off service agreements linked to the account along with their respective current and payoff balance. Use **Menu > Credit & Collection > Write Off > Search** and navigate to the **Write Off SAs** page.

Description of Page

Account contains the name of the main customer on the account. The **Account ID** is the account associated with the WO SAs displayed below.

The grid contains an entry for every write-off service agreement linked to the account. The following information is displayed for each write-off service agreement:

- The service agreement's **SA Information** is displayed.
- **Current Balance** contains the WO SA's current balance (i.e., the amount written off).
- **Payoff Amount** contains the WO SA's payoff balance (i.e., the amount written off).

NOTE:

Write off SA. There is a field on SA type called **Special Role**. Only those SA types with a role of Write Off are displayed.

Collection Referral

The Collection Referrals page contains information about an account's debt that has been referred to a collection agency.

FASTPATH:

Refer to [How Do Collection Agency Referrals Work?](#) for more information about how the system creates and maintains collection agency referrals as part of the automated write off processing. In theory, you need only access this page if you need to override the automated processing.

Open **Menu > Credit & Collection > Collection Agency Referral > Search** to maintain this information.

Description of Page

The **Agency Referrals** scroll contains one entry for every collection agency referral associated with the account. The following information is defined for each referral.

Use **Collection Agency** to define the agency to which the referral is being sent.

Start Date is the date on which the referral was initially created.

Referral Status defines if the referral is Active or Closed.

Use **Comments** to describe anything unusual about the referral.

The grid contains the history of interactions with the collection agency. Each time an account's debt is referred to a collection agency, the system creates a referral history record.

You can communicate changes about the referral by inserting a new row in the collection. For example,

- If you need to change the referral amount, insert a row and indicate the **Creation Date** and a **Referral History Reason** of Change Referral.
- If you need to cancel the referral, insert a row and indicate a **Referral History Reason** of Referral Cancellation.
- If the customer pays, insert a row and indicate a **Referral History Reason** of Referral Paid.
- If you need to add a new referral, insert a row and indicate a **Referral History Reason** of Initial Referral.

Collection agency referral records are interfaced to the respective collection agency using the batch process defined on the collection agency control record (refer to [Setting Up Collection Agencies](#)). The **Batch Control** process and the respective **Batch Number** in which the records were interfaced to the collection agency are displayed adjacent.

The **System Generated** switch is on for those collection agency referrals created as part of the automated write-off processing. Refer to [How Do Collection Agency Referrals Work?](#) for more information.

Downloading Collection Agency Referrals

Collection referral records need to be periodically extracted and sent to collection agencies.

C1-CAGYX - Collection Agency Referral Extract

This batch was developed using the plug-in driven extract template. It contains a select record and process record algorithm. The records can be extended to include custom fields that your implementation needs. The process records algorithm type delivered with the system, C1-CAGYX-PR, contains instruction for extending the record.

Collection Agency Extract Record

The topics in this section describe the information that appears on each collection agency extract record type.

Collection Agency Referral Record

This section describes the layout of the record created by C1-CAGYX.

Field	Format	Source/Value/Description
Account ID	A10	Collection Agency Referral's Account
Name	A254	Account's Main Person Primary Name
Person Type	A2	Person or Business Indicator (Main Person)
Person Type Description	A60	Description of Person Type
ID Type	A8	Primary ID Type (Main Person)
ID Value	A100	Primary ID Value (Main Person)
Primary Phone Type	A30	Person Contact Type (Main Person)
Primary Phone Number	A254	Primary Phone Person Contact Number (Main Person)
Primary Phone Number Extension	A6	Primary Phone Person Contact Extension (Main Person)
Email Address	A254	Primary Email Person Contact (Main Person)
Mailing Address	A1241	Mailing Address (Main Person). See below for the fields. See Address Subrecord for the fields.
Service Address	A1241	Service Address of Premise linked to SA being written off. One chosen. Stopped SAs given priority. See below for the fields. See Address Subrecord for the fields.
Customer Class	A8	Account's Customer Class
Customer Class Description	A60	Customer Class Description
Currency	A3	Account's Currency
Referral Activity Date	D10	Collection Referral History Create Date
Referral Activity Reason	A4	Collection Referral History Reason
Referral Activity Reason Description	A60	Collection Referral History Reason Description
Referral Activity Amount	N13.2	Collection Referral History Referral Amount

Initial Referral Date	D10	Collection Agency Referral Initial Referral Date
Initial Referral Amount	N13.2	This is the amount on the record marked with a referral reason of initial. If more than one initial record is found the newest one is chosen by default. A parameter on the process record algorithm allows provides the option of choosing the oldest, newest or some of all initial records. Note: additional initial records can be created manually. The system only creates the first one.
Initial Referral Comments	A254	Collection Agency Referral Comments
Connect Date	D10	If the collection agency referral is linked to a write off process, this is the oldest start date for SAs associated with the write off process. If the collection agency referral is not linked to a write off process this is the oldest start date for SAs on the account, giving preference to stopped SAs.
Disconnect Date	D10	If the collection agency referral is linked to a write off process, this is the latest end date for SAs associated with the write off process. If the collection agency referral is not linked to a write off process this is the latest end date for SAs on the account, giving preference to stopped SAs.
Write Off Date	D10	If the collection agency referral is linked to a write off process, this is the creation date for the write off process. If the collection agency referral is not linked to a write off process, the initial referral date is noted here.
Payments Since Last Activity	N13.2	If the collection agency referral is linked to a write off process, this is the sum of pay segment transactions since the last agency referral history record up to the current record. If the collection agency referral is not linked to a write off process, the sum reflects all SAs.
Canceled Payments Since Last Activity	N13.2	If the collection agency referral is linked to a write off process, this is the sum of canceled pay segment transactions since the last agency referral history record up to the current record. If the collection agency referral is not linked to a write off process, the sum reflects all SAs.
Adjustments Since Last Activity	N13.2	If the collection agency referral is linked to a write off process, this is the sum of adjustment and canceled adjustment transactions since the last agency referral history record up to the current record. If the collection agency referral is not linked to a write off process, the sum reflects all SAs.
Fin Resp - Name	A254	Primary Name of Financially Responsible Person on Account
Fin Resp - Person Type	A2	Person or Business Indicator (Financially Responsible Person)
Fin Resp - Person Type Description	A60	Description of Person or Business Indicator (Financially Responsible Person)
Fin Resp - ID Type	A8	Person's Primary ID Type (Financially Responsible Person)
Fin Resp - ID Value	A100	Person's Primary ID Value (Financially Responsible Person)
Fin Resp - Primary Phone Type	A30	Primary Phone Person Contact Type (Financially Responsible Person)
Fin Resp - Primary Phone Number	A254	Primary Phone Person Contact Number (Financially Responsible Person)
Fin Resp - Primary Phone Number Extension	A6	Primary Phone Person Contact Extension (Financially Responsible Person)
Fin Resp - Mailing Address	A1241	Mailing Address (Financially Responsible Person). See Address Subrecord for the fields.

End of File Footer Record

Field	Element Name	Source/Value/Description
Batch Code	A8	
Batch Number	N10	
Thread Number	N10	
Extract Date/Time	A26	
Records Processed	N10	

Address Subrecord

Used in mailing address and service address, total length = 1241 bytes

Field Name	Format	Source/Value/Description
COUNTY	A3	
ADDRESS1	A254	
ADDRESS2	A254	
ADDRESS3	A254	
ADDRESS4	A254	
CITY	A90	
NUM1	A6	
NUM2	A4	
HOUSE_TYPE	A2	
COUNTY	A90	
STATE	A6	
POSTAL	A12	
GEO_CODE	A11	
IN_CITY_LIMIT	A1	

Payment Arrangements and Pay Plans

Payment arrangements and pay plans are very similar concepts in that they are both used to payoff debt. This section describes each method.

NOTE:

To distinguish between payment arrangements and pay plans, it is helpful to understand some terminology: 1) an agreement with a customer to pay off their debt as part of their future bills (sometimes referred to as "current bill plus") is a **payment arrangement**, 2) an agreement with specifically scheduled payments is called a **pay plan**.

Setting Up Payment Arrangement Requests

A payment arrangement request is used to manage the step-by-step process of starting a payment arrangement. These steps can include: checking the account's eligibility for a payment arrangement, capturing the terms of the payment arrangement

(i.e. amount of the outstanding debt to include in the payment arrangement, down payment amount, installment details, etc.), performing required approvals, monitoring the payment of an applicable down payment, and the actual creation of the payment arrangement service agreement. Refer to [The Big Picture Of Payment Arrangement Requests](#) for more information. The topics in this section describe how to set up a payment arrangement request.

Starting A Payment Arrangement Request

There are multiple ways start a payment arrangement request:

- From Control Central:
 - Select the Account.
 - Navigate to the **Payment Agreements** tab page
 - On the **Payment Arrangement Requests** zone, click on the **New Payment Arrangement** button.
- From the Main Menu: Navigate using **Menu > Credit & Collection > Payment Arrangement Request > Add**.
- From the **Payment Arrangement Request Search** portal, click on the **Add** button on the page header.
- From a page/zone that displays the Account: On the Account context menu, navigate using **Go To Payment Arrangement Request > Add**.

All navigation options launch the [Payment Arrangement Request Process Flow](#), which will take you through each of the steps needed to set up a payment arrangement request.

Maintaining Payment Arrangement Requests

A payment arrangement request is used to start a payment arrangement. Aside from capturing the agreed upon terms of the payment arrangement (such as the service agreements and debts to include, number of installments and installment amount), it can also manage any applicable prerequisites for starting the payment arrangement, e.g. down payments, approvals, etc.

Refer to [The Big Picture Of Payment Arrangement Requests](#) for an overview of payment arrangement request functionality.

This section describes how to view and maintain payment arrangement requests.

Navigate using **Menu > Credit & Collection > Payment Arrangement Request > Search**. You are brought to a query portal with options for searching for payment arrangement requests.

Once a payment arrangement request record has been selected, you are brought to the maintenance portal to view and maintain the selected record.

The **Payment Arrangement Request** zone shows the details of the payment arrangement request. Refer to the zone's embedded help for more information.

The **Notes** zone allows users to capture additional notes on the payment arrangement request.

Payment Arrangement Request Process Flow

The base product provides a **Payment Arrangement Request** process flow type that includes three steps:

- Execution of one or more eligibility criteria, to determine whether or not the account is eligible for a payment arrangement. The results of each eligibility criteria and the overall eligibility result are displayed on the first panel of the process flow
- Setting up the terms of the payment arrangement:
 - The service agreements and debt to include in the payment arrangement
 - If a down payment must be paid prior to starting the payment arrangement, the down payment amount can be a percentage or a fixed-amount portion of the total payment arrangement amount

- The remaining payment arrangement amount (after down payment, if applicable)
- The number of installments
- The installment amount
- Review of the eligibility results and the agreed upon payment arrangement terms before submitting the payment arrangement request

Refer to the **Payment Arrangement Request** process flow panels for more details. Also refer to [Understanding Process Flows](#) for information about how process flows work, in general.

Viewing Payment Arrangement Request History

An account's payment arrangement request history can be viewed on the [Payment Arrangement Requests](#) zone of the [Control Central – Payment Agreements](#) page. Refer to this zone's embedded help for more details.

Setting Up Payment Arrangements

A payment arrangement is an agreement with a customer to payoff severely overdue debt in installments. Bills sent to customers with payment arrangements contain charges for both their current services and their payment arrangement installment amount. Refer to [The Big Picture Of Payment Arrangements](#) for information about the financial ramifications of payment arrangements and for a description of how the system monitors payment arrangements.

The topics in this section describe how to set up a payment arrangement and how to break a payment arrangement (if a customer doesn't fulfill their obligations).

Pay Arrangement - Main

NOTE: This page is used to create the payment arrangement service agreement. If you require eligibility checking and other prerequisites for starting a payment arrangement, set up a [Payment Arrangement Request](#) instead.

This page allows you to set up a payment arrangement. When you create a payment arrangement, the system performs the following functions:

- It creates a payment arrangement service agreement (PA SA). It sets the installment amount on this service agreement equal to the installment amount specified on this page.
- It transfers delinquent debt from each delinquent service agreement(s) to the new PA SA.
- As it transfers the debt to the PA SA, it creates synchronizing adjustments to reduce the PA SA's current balance by the amount transferred. Why? Because when delinquent debt is transferred to the PA SA, its current balance increases. Because current balance contains the amount the customer currently owes, this balance must be reduced because the customer is going to payoff the debt in installments (and therefore they don't currently owe anything on the PA SA).

NOTE:

Payment Arrangement Algorithm. The system only performs the above steps if the new PA SA's SA Type does not reference a Payment Arrangement algorithm. If your implementation uses a Payment Arrangement algorithm, then the logic performed when a payment arrangement SA is created will depend on this algorithm.

You could do the above functions by adding a new service agreement (using the service agreement page) and creating transfer adjustments (using the adjustment page). However, this is tedious. Rather, open **Menu > Credit & Collection > Payment Arrangement > Add** to set up a payment arrangement.

Description of Page

SA (service agreement) **Info** and **SA ID** are displayed on every page. These values only appear after the payment arrangement service agreement (PA SA) exists on the database. The **ID** is a system assigned random number that stays with the payment arrangement service agreement for life. The **SA Info** is a concatenation of important details about the payment arrangement service agreement and its account.

The **Current Balance** that appears beneath **SA Info** contains the PA SA's current balance. When you initially set up a PA SA this balance will be zero. It is only non-zero if the customer has not paid a billed installment.

Payoff Balance beneath **SA Info** contains the PA SA's payoff balance. The payoff balance is the total amount to be paid off over the PA SA's life. It is only non-zero after delinquent funds have been transferred to the PA SA. This balance is only displayed when it differs from the **Current Balance**.

FASTPATH:

Refer to [Current Amount versus Payoff Amount](#) for more information.

Account contains the name of the main customer on the account. **Account ID** is the account associated with the PA SA.

The occurrences of **Current** and **Payoff Balance** below **Account** are the account's respective balances. These values are displayed to help you confirm exactly how much the customer currently owes versus how much they will have to payoff over time (remember, after you transfer funds to a payment arrangement, the amount transferred is reduced from the account's current balance).

The **Candidate SAs** scroll contains one row for each of the account's service agreements with aged debt. The system displays the respective age and amount of each SA's debt. All debt that is checked will be transferred to the PA SA when you click **Create**.

WARNING:

The system automatically indicates that all debt that isn't "new" (i.e., debt that the customer has seen on their bills) should be transferred to the payment arrangement. It does this by checking each parcel of aged debt.

Total is the sum of ALL current balances (not just the checked amounts) from all candidate SAs.

The next two fields are used to populate the arrangement amount (i.e., the amount the customer will be billed on each bill).

- The **Installments** field exists to calculate the **Arrange Amount** (the next field) when a time period has been stipulated. Simply enter the number of installments and tab out. When you tab out of the field, the system sets the **Arrange Amount** equal to **New Payoff Balance / Installments**.
-

NOTE:

Arrange Amount may not add up. The **Arrange Amount** is rounded up so that if you multiply the number of installments by the calculated installment amount, the result will be greater than the PA SA's payoff amount. Don't worry - only the actual dollar amount of the PA SA's total debt will be billed by the system. The last installment will be slightly lower than the other installments.

- Use the **Arrange Amount** field to define the payment arrangement's installment amount if a specific dollar amount has been stipulated. For example, if the customer agrees to pay off their delinquent debt by paying an additional \$50 on each bill, you'd enter "50" in this field. Note - If you enter a dollar amount in this field and tab out, the system will calculate the number of installments and display the number in the **Installments** field.

New Payoff Balance contains the PA SA's payoff balance. This is the total amount of debt that will be paid off over the lifetime of the PA SA. This value equals the current payoff balance on the PA SA plus all selected debt from the **Candidate SAs** scroll.

Define the **CISDivision** and **SA Type** of the payment arrangement service agreement.

NOTE:

Payment arrangement SA types. There is a field on SA type called Special Role. Only those SA types with a role of Payment Arrangement may be selected.

Clicking **Create** (or **Change**) causes the system to perform the following:

- It adds / updates a payment arrangement service agreement (PA SA). It sets the installment amount on this service agreement equal to the installment amount specified on the page.
 - It transfers delinquent debt from the delinquent service agreement(s) to the PA SA. The adjustment type used to transfer these funds is defined on the PA SA's SA type.
 - It reduces the current balance on the PA SA by the amount of debt transferred to the PA SA. Why? Because when delinquent debt is transferred to the PA SA, its current balance increases. Because current balance contains the amount the customer currently owes, this balance must be reduced because the customer is going to pay off the debt in installments (and therefore they don't currently owe anything). The adjustment type used to transfer these funds is defined on the PA SA's SA type.
-

NOTE:

Payment Arrangement Algorithm. The system only performs the above steps if the new PA SA's SA Type does not reference a Payment Arrangement algorithm. If your implementation uses a Payment Arrangement algorithm, then the logic performed when a payment arrangement SA is created will depend on this algorithm.

You can transfer to the **History** page to view the transfer adjustments that were created by the system when it transferred the selected debt to the PA SA.

Clicking **Break** causes the PA SA to become broken. Please refer to the note below for what transpires when a PA is broken.

NOTE:

Break logic is in a plug-in. Please be aware that the logic that is executed when a payment arrangement is broken exists in a plug-in algorithm (plugged-in on the PA SA's SA type). An implementation can use either a Break Payment Arrangement algorithm which the system calls when a payment arrangement is broken, or the Payment Arrangement algorithm which the system calls when a payment arrangement is created, canceled or broken. These two algorithms are mutually exclusive on the SA Type.

Break Payment Arrangement Algorithm. The base package algorithm (SAT BREAK PA) expires the PA SA and cancels all related frozen adjustments, returning the debt to the original service agreements. Because this logic is in a plug-in, you can develop alternative logic and plug it in if the base package logic is not satisfactory.

How To Set Up A Payment Arrangement

NOTE: The following steps only apply to setting up payments using the [Payment Arrangement – Main](#) page.

To set up a new payment arrangement:

- Select the **Account** in question.
 - Select the debt to be transferred to the payment arrangement (by turning on/off the checkbox adjacent to the **Candidate SAs** amounts).
 - Enter the number of **Installments** and the total **Arrange Amount**.
 - Define the **CIS Division** and **SA Type** of the new payment arrangement service agreement.
-

NOTE: If the service agreement's account's CIS Division's **Restrict to Account CIS Division** flag is set to *Restricted*, the CIS Division is set to the account's CIS Division and cannot be changed

- Click the **Create** button.

How To Add Additional Debt To A Payment Arrangement

To transfer additional debt to an existing payment arrangement:

- Select the **SA ID** of the existing payment arrangement.
- Select the debt to be transferred to the payment arrangement (by turning on/off the checkbox adjacent to the **Candidate SAs** amounts).
- Enter the number of **Installments** and the total **Arrange Amount**.
- Click the **Create** button.

NOTE:

After transfer. After transferring the funds to the payment arrangement service agreement, confirm the account's payoff and current balances make sense (the payoff balance is the total amount of debt that the account will eventually have to payoff, the current balance is how much they currently owe, i.e., the amount that credit and collections monitors). The account's payoff and current balances are displayed in the page's second section. If you do not understand the difference between payoff balance and current balance, refer to [Current Amount versus Payoff Amount](#).

How To Break A Payment Arrangement

You would break a payment arrangement when a customer doesn't make the agreed payments. Typically, your credit and collections processes will break a payment arrangement behind-the-scenes. Refer to [The Big Picture Of Payment Arrangements](#) for information about how the system monitors payment arrangements.

If you want to manually break a payment arrangement simply select the **SA ID** of the existing payment arrangement and click the **Break** button.

How To Cancel A Payment Arrangement

You would cancel a payment arrangement if you made a mistake and never intended to set up the payment arrangement in the first place. To cancel a payment arrangement

- Select the **SA ID** of the existing payment arrangement and navigate to the **History** tab.
- Click the **Cancel** button to cancel the transfer adjustments that were used to transfer debt to the payment arrangement from the customer's regular service agreements.
- Next, navigate to the payment arrangement SA's (PA SA) financial history page (using the service agreement context menu). You will see that there are a few non-canceled adjustments (these were used to change the PA SA's current balance after debt was transferred to the PA SA). Cancel these adjustments by drilling down on these adjustments and then click the **Cancel** button on the adjustment maintenance transaction.
- Finally, display the PA SA on the service agreement maintenance transaction and cancel the payment arrangement.

NOTE:

Payment Arrangement Algorithm. If the payment arrangement SA's SA Type references a Payment Arrangement algorithm, then the logic performed when the PA SA is canceled will depend on this algorithm.

Pay Arrangement - History

Open **Menu > Credit & Collection > Payment Arrangement > Search** and navigate to the **History** page to view the transfer adjustments that were created by the system when it transferred the selected debt to the PA SA.

Description of Page

SA (service agreement) **Info** and **ID** are displayed on every page in this page. These values only appear after the payment arrangement service agreement (PA SA) exists on the database. The ID is a system-assigned random number that stays with the service agreement for life. The SA Info is a concatenation of important details about the service agreement and its account.

Current Balance beneath **SA Info** contains the PA SA's current balance. When you initially set up a PA SA this balance will be zero. It is only non-zero if the customer has not paid a billed installment.

Payoff Balance beneath **SA Info** contains the PA SA's payoff balance. The payoff balance is the total amount to be paid off over the PA SA's life. It is only non-zero after delinquent funds have been transferred to the PA SA. This balance is only displayed when it differs from the Current Balance.

FASTPATH:

Refer to [Current Amount versus Payoff Amount](#) for more information.

Account contains the name of the main customer on the account. **Account ID** is the account associated with the PA SA.

The occurrences of **Current** and **Payoff Balance** below **Account** are the account's respective balances. These values are displayed to help you confirm exactly how much the customer currently owes versus how much they will have to payoff over time (remember, after you transfer funds to a payment arrangement, the amount transferred is reduced from the account's current balance).

The **Adjustment Details** area contains one row for each transfer adjustment used to transfer delinquent debt to the PA SA. Click the Go To button to transfer to the adjustment page to view the details of an adjustment (or to cancel the adjustment if you want to reinstate the debt on the originating service agreement).

Total Frozen Adj is the total amount of debt transferred to the payment arrangement that has not been canceled.

Clicking **Cancel** causes the system to cancel all related frozen adjustments, returning the debt to the original service agreements. You must specify the cancel reason by selecting it from the drop down list when Payment Arrangement Cancellation window is displayed.

Total Canceled Adj is the total amount of debt transferred to the payment arrangement that has been canceled.

Setting Up Pay Plans

A pay plan (PP) is an agreement with a customer to make specific payments on specific dates (as opposed to payment arrangements where the customer makes fixed payments as part of their regular bills).

Consider the following situations that would require a pay plan:

- A customer makes a request to payoff severely overdue debt in one or more installments. The existence of the pay plan insulates the portion of the debt covered by the plan from C&C processing (specifically, from the account debt monitor).
- A commercial or industrial customer cannot or will not post a deposit. This type of pay plan is not specifically paying off past debt; rather, it can be viewed as an installment plan to prepay a regular service agreement.

The topics in the following section describe how to set up a pay plan.

Pay Plan - Main

The pay plan transaction allows you to set up a pay plan. When you create a pay plan, the system performs the following functions:

- It creates an active pay plan using the pay plan type entered.
- It defaults the customer as the payor if no third party is defined.

FASTPATH:

Refer to [The Big Picture Of Pay Plans](#) for information about the financial ramifications of pay plans and for a description of how the system monitors pay plans.

Open **Menu > Credit & Collection > Pay Plan > Search** to maintain a customer's pay plan.

Description of Page

Pay Plan and **Pay Plan ID** only appear after the pay plan is added to the database. **Pay Plan ID** is a system-assigned random number that stays with the pay plan for life. **Pay Plan** is a concatenation of important details about the pay plan.

Account ID identifies the account of the customer for which the pay plan exists. This field is protected once the pay plan is Active.

The **Status** displays the status of the pay plan. Refer to [The Lifecycle Of A Pay Plan](#) for more information about a pay plan's status.

Created by displays the id of the user who created the pay plan and the date and time on which it was created.

Clicking the **Cancel** button causes the pay plan's status to become cancelled.

Last Updated by displays the id of the user who last modified the pay plan and the date and time on which it was changed.

Select a **Pay Plan Type**. The Pay Plan Type defines the **Debt Class** whose debt is insulated by the pay plan. The account's **Current Balance** in this debt class appears beneath as well as the portion that is considered **Delinquent Debt**.

If a 3rd party is responsible for the pay plan's payment, **Third Party Payor** must be checked, and the associated 3rd party selected.

The **Payor Account Id** contains the account ID and name of the person responsible for making the pay plan's payments. If a **Third Party Payor** is responsible, the payor's account appears; otherwise the account whose debt is insulated by the pay plan appears.

The **Start Date** defines the first day on which the pay plan is tracked; it defaults to the current date.

Pay Method defines the manner in which the customer intends to fulfill payments under this pay plan.

NOTE:

Significance of payment method. A pay method can have a grace period associated with it. This period controls when a scheduled payment is considered to be missed. For example, a pay method of "postal" might have a grace period of 3 days. This would give the customer 3 extra days to make the scheduled payments before the pay plan is broken.

In addition to grace period, pay method also control if the system will automatically create an automatic payment on the scheduled payment date. If the pay method so indicates AND the account has been set up for automatic payment, the PPAPAY background process will create [Automatic Payments](#) on the scheduled payment date.

The **Scheduled Payments** grid contains the pay plan's scheduled payments. The **Scheduled Date** and **Scheduled Amount** must be entered for each scheduled payment. The **Total Amount** of the scheduled payments is displayed at the bottom.

Free format **Comments** can be entered to describe any special notes about the pay plan.

How To Set Up A Pay Plan

To set up a new pay plan:

- Select the **Account** in question on [Pay Plan - Main](#).
- Select the **Pay Plan Type** for the type.
- Identify a **Third Party Payor** if there is one.
- Select a **Pay Method**.
- Enter one or more **Scheduled Payments**. The **Total Amount** of the scheduled payments should cover the customer's **Delinquent Debt** if you want the pay plan to protect the customer from additional credit and collection activity.
- Click the **Save** button.

Reviewing Pay Plans

In addition to using this maintenance page for reviewing pay plans, Control Central has a pay plan tree that can be used to view pay plan history, including current status. Refer to [Pay Plan Tree](#) for more information.

Financial Transactions

In this section, we describe the financial transactions generated as a result of your bills, payments and adjustments.

The Big Picture Of Financial Transactions

The topics in this section provide background information about a variety of financial transaction issues.

FASTPATH:

We strongly recommend familiarizing yourself with the topics described in [The Financial Big Picture](#) to fully appreciate the system's financial architecture.

Bill Segment Financial Transactions

A bill segment has a related financial transaction. The financial transaction contains the financial effects of the bill segment on the service agreement's current and payoff balances and on the general ledger.

If a bill segment is cancelled, another financial transaction is created to reverse the original financial transaction. The cancellation financial transaction appears on the next bill produced for the account as a bill correction.

FASTPATH:

For more information about bill segment financial transactions, refer to [Bill Details](#).

Payment Segment Financial Transactions

A payment segment has a related financial transaction. The financial transaction contains the financial effects of the payment segment on the service agreement's current and payoff balances and on the general ledger.

If a payment segment is cancelled, another financial transaction is created to reverse the original financial transaction. The cancellation financial transaction appears on the next bill produced for the account as a negative payment.

FASTPATH:

For more information about payment segment financial transactions, refer to [Payment Details](#).

Adjustment Financial Transactions

An adjustment has a related financial transaction. The financial transaction contains the financial effects of the adjustment on the service agreement's debt and on the general ledger.

If the adjustment is eventually cancelled, another financial transaction will be linked to the adjustment to reverse its financial effect. The cancellation financial transaction appears on the next bill produced for the account as an adjustment.

FASTPATH:

For more information about adjustment financial transactions, refer to [Adjustment Details](#).

Financial Transactions And Aged Debt

When a financial transaction's related bill segment / payment segment / adjustment is frozen, the financial transaction (FT) is also frozen. When an FT is frozen, its service agreement's debt is impacted. It is important to stress the following in respect of this impact:

- The FT's GL details will be interfaced to the GL when the GL interface next executes.
- If the FT decreases the amount of debt, the customer's aged debt is affected immediately regardless of whether the FT appears on a bill.
- If the FT increases the amount of debt, the amount the customer owes from an aged debt perspective may or may not be affected by the FT. There is a switch on an FT called New Charge that controls the arrears behavior. If this switch is on, the customer's aged debt will not reflect the FT amount until the FT is swept onto a bill. The moment the FT is swept onto the customer's bill, the debt starts aging. If this switch is off, the date on which the FT starts aging must be defined in the Arrears Date field.
- The amount a customer owes in total is immediately affected by the FT regardless of whether the FT appears on a bill. This means that the amount of aged debt may not be in sync with the total amount owed. This seems odd, but is useful from a credit and collections perspective. You see, you probably don't want to start aging a FT until the customer has actually seen it.

FASTPATH:

For more information, refer to [Financial Transactions Created Between Bills](#).

Current Balance versus Payoff Balance

FASTPATH:

For information about current and payoff balance in general, refer to [Current Amount versus Payoff Amount](#).

The topics in this section describe when payoff amount differs from current amount for the various types of financial transactions.

Adjustments - Current Balance versus Payoff Balance

FASTPATH:

For information about current and payoff balance for adjustments, refer to [Adjustments - Current Balance versus Payoff Balance](#).

Billing - Current Balance versus Payoff Balance

FASTPATH:

For information about current and payoff balance for bill segments, refer to [Billing - Current Balance versus Payoff Balance](#).

Payment - Current Balance versus Payoff Balance

FASTPATH:

For information about current and payoff balance for payment segments, refer to [Payment - Current Balance versus Payoff Balance](#).

The Source Of GL Accounts On Financial Transactions

FASTPATH:

For information about the source of the distribution codes used to generate the GL accounts on the financial transactions, refer to [The Source Of GL Accounts On Financial Transactions](#).

Obscure Things That Can Happen

The topics in this section provide information about obscure things that can happen when a financial transaction (FT) is frozen.

A Stopped Service Agreement May Be Closed

If an FT causes a Stopped SA's current and payoff balances to become zero, the system closes the service agreement (i.e., the service agreement's status becomes Closed).

A Closed Service Agreement May Be Reactivated

After a service agreement is closed (i.e., after it's stopped and paid-in-full), it's possible for some types of financial transactions to be linked to the service agreement. These financial transactions could cause the current and/or payoff balances to become non-zero. If this happens, the system reactivates the service agreement (i.e., the service agreement's status becomes reactivated).

When a service agreement becomes reactivated, it becomes eligible for review by the write-off process monitor (when it next runs). The write-off process monitor will, in all likelihood, start a write-off process for the reactivated service agreement.

Financial events that can be linked to a closed service agreement are:

- The cancellation of a bill segment
- The freezing of a payment segment
- The cancellation of a payment segment
- The freezing of an adjustment
- The cancellation of an adjustment

A Write-Off Process May Be Deactivated If The SA Is Closed

When a service agreement becomes Closed, it will be removed from any ongoing write-off processes. This removal could cause the write-off process to become Inactive (if this is the last service agreement linked to the write-off process). The inactivation of the write-off process, could, in turn, cause collection agency referrals associated with the write-off process to be cancelled.

A Reactivated Service Agreement May Be Closed

After a service agreement has been reactivated (refer to the previous section for how this happens), a financial transaction (or transactions) may be linked to it that will cause the current and payoff balance to return to zero. If this happens, the system closes the service agreement (i.e., the service agreement's status becomes Closed).

All types of financial transactions can be posted to a Reactivated service agreement.

A Collection Process May Be Canceled When A Credit FT Is Frozen

Periodically, the system determines if an account's debt violates your collection criteria. If so, a collection process is created using the violated criteria's collection process template.

The Collection Process Monitor reviews an active collection process whenever one of its service agreements' debt is reduced. Financial events that can cause service agreement debt to be reduced are:

- The cancellation of a bill segment
- The freezing of a payment segment
- The freezing of an adjustment that credits a service agreement

At review time, the Collection Process Monitor removes any service agreement from a collection process when the service agreement has no debt older than the arrears date on the collection process. When all service agreements are removed, the collection process is cancelled.

FASTPATH:

Refer to [The C&C Monitors](#) for more information about debt monitoring.

A Severance Process May Be Canceled When A Credit FT Is Frozen

If the customer does not respond to a collection process's prodding, the system creates a severance process for each delinquent service agreement associated with the collection process.

The system reviews an active severance process whenever its service agreements' debt is reduced. Financial events that can cause service agreement debt to be reduced are:

- The cancellation of a bill segment
- The freezing of a payment segment
- The freezing of an adjustment that credits a service agreement

At review time, the system determines if the service agreement has no debt older than the arrears date on the severance process. If so, the system looks at the severance process' severance process template:

- If the severance process template indicates that the process can be **Used to sever service**, the system cancels all pending severance events and deactivates the severance process. Note: the only severance processes that are not used to sever service are those that request reconnection of a cut service.
- If the canceled process has field activities,
- If the field activities are not linked to a field order and are still in the pending status, the system cancels the field activities.
- Otherwise, the system generates worklist entries to alert an operator that field activities have been dispatched. The operator must determine how to handle these activities because they could already be scheduled for dispatch (or completed!).

NOTE:

Real time cancellation. Unlike collection processes, the system cancels severance processes real time (i.e., there is no equivalent of the collection process monitor for severance processes). Why are severance processes canceled real time? Because a severance process may have events that create field activities to sever service. These events need to be canceled the moment the FT is frozen, we can't wait until a background process runs. This means that if a customer pays in person for a service agreement that is pending severance, the system will cancel the process and its field activities (if any) the moment the payment is entered.

FASTPATH:

Refer to [The C&C Monitors](#) for more information about debt monitoring.

One Or More Algorithms May Be Executed

If the FT is linked to a service agreement whose SA type has Freeze Algorithms, these algorithms will be executed when the FT is frozen. Because you can code whatever you please in an algorithm, anything could happen. Examples of such algorithm include:

- An algorithm that routes consumption to third party service providers when a bill is frozen (refer to STG SND CONS for more information). This type of algorithm would be plugged in on SA types whose consumption can be interfaced to other service providers.
- A bill message can be added to the account when the system detects that its deposit has been paid in full (refer to DEP PIF MSG for more information). This type of algorithm would be plugged in on deposit SA types.

In addition, FT freeze algorithms can also be defined on an account's customer class. Because you can code whatever you please in an algorithm, anything could happen. An example of such an algorithm is one that cancels match events when an FT is cancelled (refer to CNCL FT MEVT for more information). This type of algorithm would be plugged in on customer classes associated with open item customers.

The Big Picture of Balance Control

The balance control processes are used to check the financial integrity of your system. The contents of this section describe how these processes work.

The Balance Control Background Processes

The following diagram illustrates the balance control background processes:

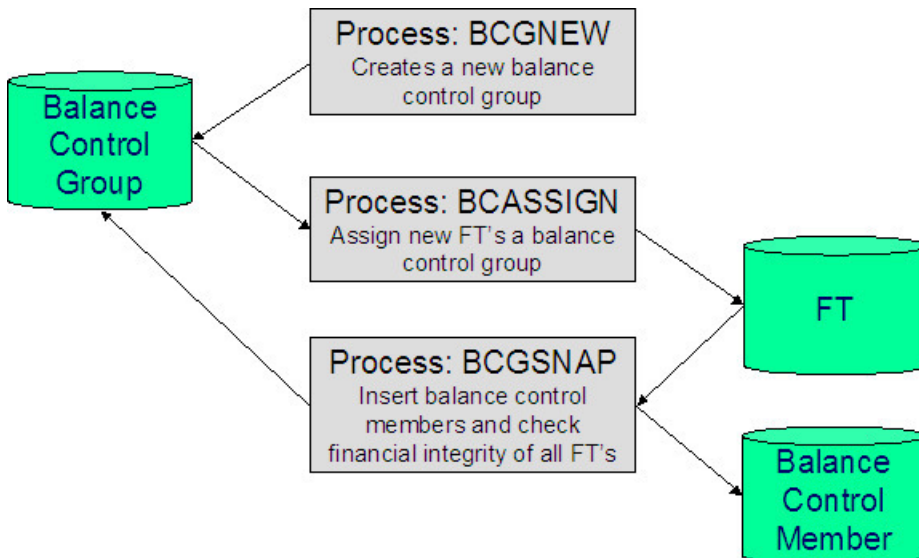

BCGNEW - Create A New Balance Control Group

This process creates a Pending balance control group if one doesn't already exist. You may wonder why an entire process is dedicated to such a trivial task. The reason is because the next process, BCASSIGN, is a multi-threaded (i.e., parallel) process and we only need one Pending balance control group regardless of the number of threads used to assign balance control ID's to financial transactions.

BCASSIGN - Assign New Financial Transactions A Balance Control Group

This multi-threaded (i.e., parallel) process assigns the Pending balance control group to new FTs whose freeze date/time is before the create date/time of the balance control record.

BCGSNAP - Insert BC Members And Check Financial Integrity Of All FTs

This process performs the following two functions:

- It summarizes new financial transactions under the current Pending balance control group as follows:
- It creates a balance control member for every combination of **Division**, **SA Type** and **FT Type** referenced on the financial transactions belonging to the balance control group.
- It updates each balance control member with the following information:
 - The number of financial transactions (FTs)
 - The sum of the total amounts on the FTs in this balance control group.
 - The sum of the current amounts on the FTs in this balance control group.
 - The sum of the total amounts from all FTs (in this and all other balance control groups).
 - The sum of the current amounts from all FTs (in this and all other balance control groups).
- It sets the status of the balance control group to Complete.
- It checks the integrity of the financial transactions in each historical Balance Control Group. It does this by summarizing EVERY financial transaction throughout time and determining if the sums are in sync with the values maintained on the balance control members. If integrity problems are detected, a detailed error message is displayed on the run control associated with the process.

If you opt to run the balance control processes on a nightly basis, you will find that the verification processing will take longer every night (because there are more financial transactions over time). In order to deal with this issue, the **BCGSNAP** process has a parameter that allows you to control which of the above functions is implemented (it's call **VERIFY-ONLY-SW**). In order to speed nightly processing, run this process with the switch set to "G" (this causes new financial transactions to be summarized under a new balance control). Then, once a week (or month), run this process with the switch set to "Y" (this checks the financial integrity of all financial transactions in the system).

If you run the balance control processes less frequently, you can set the **VERIFY-ONLY-SW** to "N" (this causes both of the above functions to execute).

Consider A Backup At This Point

We recommend you backup your database AFTER you run the above processes. Why? So that if a financial integrity problem is spotted in the future, you can compare the current database against the backup to see what changed.

Balance Control Information Is Available Online

Your internal auditors may be interested in the total number and amount of financial transactions that have been posted since a given point in time. You can use the [Balance Control](#) page to see this information.

The GL Interface

The following diagram illustrates the GL Interface.

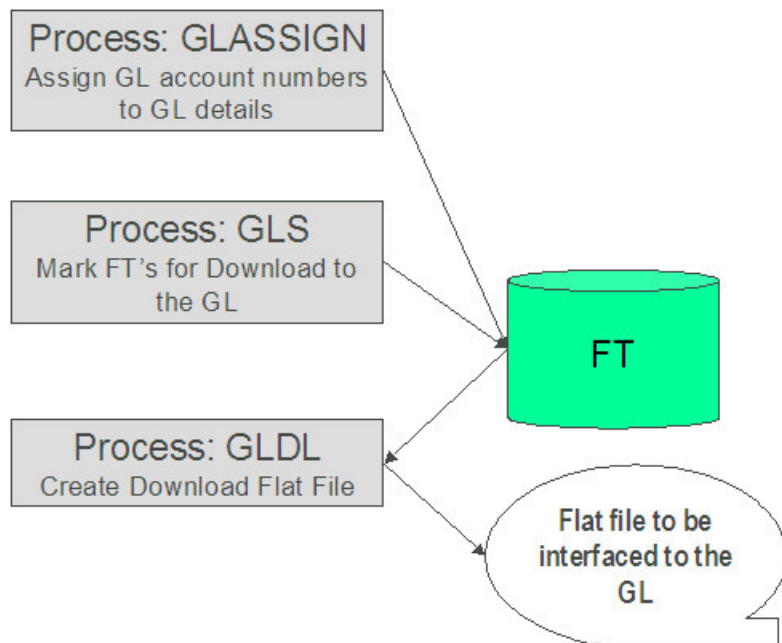

GLASSIGN - Assign GL Account Numbers To GL Details

The GLASSIGN process assigns GL account numbers to the GL details associated with financial transactions. GL account numbers are assigned as follows:

- Every GL detail references a distribution code.
- Every distribution code references a GL assignment algorithm. The base package algorithm simply uses the default GL account associated with the distribution code. However, you can construct your own algorithm(s) to assemble your GL account numbers in your desired fashion. Refer to [Setting Up Distribution Codes](#) for more information about the GL format algorithm.
- The GLASSIGN process simply calls each GL's details distribution code's GL assignment algorithm and updates the GL detail with the result (i.e., the GL account number). This GL account number is then used by the GLDL process when it creates the consolidated journal entry that's interfaced to the GL.

NOTE:

If incorrect GL account numbers get assigned to GL details... If you do not plug in the correct algorithm or your algorithm is wrong, you can correct the GL account numbers that are assigned to the GL details. How? Write a simple program that resets the GL account numbers on the erroneous GL details. Then run GLASSIGN. GLASSIGN will re-execute the distribution code GL assignment algorithm and refresh the account number accordingly.

GLS - Prepare FTs for Download

The GLS process creates FT download staging records for all FTs that are ready to be posted to the GL (the FT download staging records are stored on the FT/Process table). Each FT download staging record is marked with a batch control ID and run number.

- The batch control ID is the process responsible for creating the flat file that contains the consolidated journal entry that is interfaced to your general ledger. The batch control ID is defined on [Installation Options - Financial](#). The system comes with a single GL download program ([GLDL - Create General Ledger Download Flat File](#)). The GL account numbers are provided by the GL account algorithms that are specified on the distribution codes. Refer to [Setting Up Distribution Codes](#) for more information about the GL account algorithm.
- The run number is the batch control ID's current run number.

This process also changes the status of the FT to distributed. You may not change the FT's GL details after this time.

GLDL - Create General Ledger Download Flat File

The GLDL process creates the flat file that contains the consolidated journal entry that is interfaced to your general ledger. One header and multiple detail records are created as described below. At the conclusion of the batch process, a validation is performed to compare debits against credits. If they are not equal, the process terminates with an error.

Header Record Layout

Field Name	Format	Source/Value/Description
REC_TYPE	A1	1 (1 is used for header records)
BATCH_CD	A8	The code for the batch process that created the file. (This value will always be 'GLDL'.)
BATCH_NBR	N10	The batch process will be run many times. This field indicates which of those runs produced a particular output file. This may be thought of as an instance identifier for the batch process.
BATCH_RERUN_NBR	N10	Any given instance of the GLDL batch process may be re-run at any time. If this instance has been re-run, this field will be populated with a number indicating how often.
EXTRACT_DTTM	A26	The date and time of the run that created a particular output file.
DETAIL_REC_CNT	N12	The number of details records
DETAIL_REC_TOTAL_DR	N13.2	This is the sum of FINANCIAL_AMOUNTs from all detail records that were greater than zero (debits).

DETAIL_REC_TOTAL_CR

N13.2

This is the sum of FINANCIAL_AMOUNTs from all detail records that were less than zero (credits).

Detail Record Layout for GLDL

NOTE:

A record is created for each unique occurrence of REC_TYPE, GL_DIVISION, CURRENCY_CD, GL_ACCOUNT and ACCT_PERIOD. If a given GL account has debit and credit FINANCIAL_AMOUNTs, two records will be created - one shows the debit amount, the other shows the credit amount.

Field Name	Format	Source/Value/Description
REC_TYPE	A1	2 (2 is used for detail records)
GL_DIVISION	A5	This is the GL Division from the CI_FT record. It determines a) which Accounting Calendar will be used to calculate the Accounting Period (below) and b) the currency of the FT.
CURRENCY_CD	A3	The currency in which the Amount is denominated.
GL_ACCOUNT	A254	Contains the GL account number as supplied by the distribution code's GL account algorithm .
ACCT_PERIOD	A6	An accounting period in the format YYYYPP where YYYY is the fiscal year and PP is the accounting period. This is derived from the GL detail's FT's accounting date and GL division.
FINANCIAL_AMOUNT	N13.2	This is the debit or credit amount. Debits are represented by positive numbers; credits are represented by negative numbers. If a given GL account has debit and credit entries, two records will be created - one shows the debit amount, the other shows the credit amount.
STAT_CODE	A8	This is the GL distribution code's statistic code (if any)
STAT_AMOUNT	N13.6	This is the statistical amount from the GL detail lines

NOTE:

The GLASSIGN process updates an FT's GL details with the appropriate GL account number.

Financial Transaction

Payment segments, adjustments and bill segment have a corresponding financial transaction. The financial transaction is created by the system when any of the source transactions is created. It contains the financial effects of its corresponding adjustment / bill segment / payment segment.

FASTPATH:

For background information, refer to [The Big Picture Of Financial Transactions](#).

The topics in this section describe the financial transaction page.

Financial Transaction - Main

Use **Menu > Financial > Financial Transaction** to update and maintain financial transaction information.

NOTE:

Navigating from source transactions. On the bill, payment, and adjustment maintenance pages, you can click the financial transaction go to button to transfer to this page.

Description of Page

Most of the attributes on this page are display-only. The following points describe the conditions under which certain fields may be modified:

- **Accounting Date** may be modified until the financial transaction (FT) is interfaced to the GL (i.e., until the **GL Distribution Status** is Distributed).
- **New Charge** may be modified until the FT is swept onto a bill (when the next bill is completed for the FT's account). If **New Charge** is modifiable and turned off, **Arrears Date** must be specified.
- **Show on Bill** and **Correction** can be modified until the FT is frozen.

The remainder of this section defines each of the fields on the page.

FT Type is the type of financial transaction. Values are: Adjustment, Adjustment Cancellation, Bill Segment, Bill Segment Cancellation, Pay Segment, and Pay Segment Cancellation. Click the go to button to view the originating transaction on the adjustment, bill, or payment page.

FT ID is the system-assigned, unique identifier of the financial transaction.

SA ID is the system-assigned, unique identifier of the service agreement to which the financial transaction is linked.

Bill ID is the system-assigned, unique identifier of the bill to which the financial transaction is linked. This field is only populated after the FT is swept onto a bill (and this happens when the next bill is completed for the FT's account).

Sibling ID is the system-assigned, unique identifier of the source transaction associated with the FT.

- If this FT is associated with a bill segment, **Sibling ID** contains the unique identifier of the bill segment.
- If this FT is associated with a payment segment, **Sibling ID** contains the unique identifier of the payment segment.
- If this FT is associated with an adjustment, **Sibling ID** contains the unique identifier of the adjustment.

Parent ID contains the following:

- If this FT is associated with a bill segment, **Parent ID** contains the unique identifier of the bill with which the bill segment is associated.
- If this FT is associated with a payment segment, **Parent ID** contains the unique identifier of the payment with which the payment segment is associated.
- If this FT is associated with an adjustment, **Parent ID** contains the adjustment type.

Create Date/Time are the date and time the FT was created.

Accounting Date is the accounting date that will be used by the general ledger to define the accounting period(s) into which the FT will be booked.

CIS Division is the CIS division associated with the FT. This comes from the CIS division linked to the FT's service agreement's SA type.

GL Division is the GL division associated with the FT. This comes from the GL division linked to the FT's service agreement's SA type.

Show on Bill indicates if the FT will be shown on the customer's bill. You should only turn this off for erroneous FTs that should not be shown to the customer. For example, if you cancel / rebill a bill segment and you want to suppress the resultant FTs on the printed bill, turn this switch off.

New Charge indicates if the FT's charge only starts aging when the FT is swept onto the next bill produced for the account. If you want to manually enter an **Arrears Date** you must turn this switch off. The system leaves this switch set when assigning an arrears date during the bill completion process. This is done so the system knows which FTs were assigned an arrears date during bill completion. If a completed bill is reopened, the arrears date is reassigned when the bill is completed.

Not In Arrears indicates if the FT's financial impact has been canceled and therefore should not be considered for arrears purposes. This switch is turned on by the system when a FT's source transaction is canceled (both the original FT and the cancellation FT are marked as **Not In Arrears**).

Match Event ID is the system-assigned, unique identifier of the match event to which the financial transaction is linked. This field is only enabled for [Open Item Accounts](#). Be aware that changing a financial transaction's match event can result in the balancing / unbalancing of the prior and newly referenced match events.

Arrears Date is the date the FT starts aging. This field is typically blank until the FT is swept onto the account's bill. If you want to start aging an FT on an historical date (for whatever reason), enter the appropriate **Arrears Date**. (Note - you must uncheck the "New Charge" box first in order to do this.) If the arrears date is assigned manually it is not updated during bill completion nor is it adjusted when a bill is reopened and completed again.

Correction causes the FT to be summarized in the correction area of the bill-at-a-glance. This is set by the system automatically when a bill segment is cancelled / rebilled after its parent bill is completed (i.e., sent to the customer).

Redundant indicates if the FT's financial impact is considered irrelevant. This only happens after an FT has reached an age that is no longer relevant for aging purposes (e.g., when the FT is older than 120 days - or whatever age has been set as the Oldest Bucket Age on the Installation Options) and when its balance is exactly equal to zero with respect to other redundant FTs of the service agreement.

Transferred Out indicates if the FT has been transferred to a service provider. This could only happen if the FT is associated with a SA that is associated with a "they bill for us" service provider. Refer to [They Bill For Us](#) for more information.

The **Frozen** switch is turned on when the FT has been frozen (i.e., posted to the service agreement's payoff and/or current balances). If this switch is on, both **Freeze Date/Time** and **Frozen By** are populated.

Current Amount contains the FT's impact on the service agreement's current amount.

Payoff Amount contains the FT's impact on the service agreement's payoff amount.

FASTPATH:

For more information, refer to [Current Balance versus Payoff Balance](#).

Currency Code is the currency code associated with the FT's account.

GL Distribution Status defines the status of the FT in respect of its interface to the general ledger. When an FT is first created, its status is Pending . When an FT is frozen, this value is set to Generated. If you modify the GL details, the status becomes Modified. After it has been marked for interface to the general ledger by the GLS process, the status becomes Distributed.

GL Extract Dates display the **Scheduled** date that the GL details will be marked for interface to the general ledger. Note that this date is typically only set to a future date for FTs associated with automatic payments. **Actual** displays the date that the GL details were actually posted to the general ledger.

The grid at the bottom shows the FT's debits and credits (i.e., the detail journal lines). Debits are shown as positive amounts, credits are negative amounts. The following points describe rules governing if and how the information in the grid can be modified:

- The FT GL details may not be modified if the FT is Pending or Distributed.
- All **Amounts** must sum to zero.
- Multiple FT GL details may be set to affect the **Total Amount** (although they are normally generated with one GL checked to affect total amount).
- All FT GL's checked to affect **Total Amount** must sum to the **Payoff Amount** of the FT.

The following information is displayed:

- **Sequence number** is the system-assigned, unique identifier of the journal line.
- **Total Amount** defines if the journal line contains the total of the other journal lines. For example, on a bill segment for utility service, this would be turned on for the receivable account because its amount equals the sum of the other payable and revenue GL accounts.
- **Distribution Code** is the CIS distribution code from which the GL account constituents are derived.
- If the **GL Account** has been populated, the GL account number is displayed.

FASTPATH:

Refer to [GLASSIGN - Assign GL Account Numbers To GL Details](#) for more information about how the GL account is populated.

- **Amount** defines the journal line's amount.
- **Statistic Amount** defines the statistical amount that will be posted to the GL. This value is only populated on distribution lines created for calculation rules designated as affecting GL statistical quantity.
- **Characteristic Type** and **Characteristic Value** describe the characteristic value that was used when the line's amount was calculated. This information is only displayed if the journal line was derived from bill calculation lines that were calculated using a bill factor (because only bill factor's use characteristic values). Refer to [An Illustration Of A Bill Factor And Its Characteristics](#) for more information.

NOTE:

Tax reporting. A journal line's characteristic value is NOT interfaced to the GL. We have included this attribute on the journal line so that tax reporting can be performed from this system (tax reporting typically necessitates showing each taxing authority - the characteristic value - that participated in a given tax payable GL account).

- If you have configured your installation options to indicate that [fund accounting](#) is practiced, the description of the **Fund** associated with this distribution code is displayed.

Financial Transaction - FT Process

Use **Menu > Financial > Financial Transaction** and navigate to the **FT Process** page to view those ancillary processes that may be triggered as a result of this financial transaction.

NOTE:

Algorithms cause financial transactions to be linked to batch processes. Financial transactions get associated with a given process / batch number when certain algorithms are executed. For example, when a bill segment is frozen, the system executes the freeze algorithms associated with the bill segment's service agreement's SA type. One of these algorithms may check if there are service providers who are interested in the bill segment's consumption, and if so, schedule the consumption to be downloaded by linking the bill segment's financial transaction to the service provider's consumption download process.

Description of Page

This page shows the **Batch Processes** associated with a given **Financial Transaction**. Information on this page may not be modified. This information appears purely for audit purposes.

Account Financial History

This portal shows how an account's current and payoff balance have changed over time. You can access the portal from **Menu > Financial Query > Account Financial History**.

Refer the portal's embedded help for more details.

FASTPATH:

For information about current and payoff balance, refer to [Current Amount versus Payoff Amount](#).

Account Bill / Payment History

This portal shows an account's bills and payments. You can access the portal from **Menu > Financial Query > Account Bill / Payment History**.

For [balance-forward accounts](#), bill rows contain the balance presented on the respective bill, and payment rows contain the amount of the respective payment. However, for [open-item accounts](#), this query behaves differently. Refer to the portal's embedded help for more details.

NOTE:

Credit Notes or Correction Notes. The Bill Correction option on the Installation record controls whether Credit Notes or Correction Notes are allowed. The default transaction type filter displayed is for Credit Note. If your implementation uses Correction Notes, you'll need to change the transaction type filter to reflect this. This is done by overriding the label for lookup value CRNT on the customizable lookup field TXN_FLTR_TYPE_FLG.

SA Financial History

This portal shows how a service agreement's current and payoff balance have changed over time. You can access the portal from **Menu > Financial Query > SA Financial History**.

Refer to the portal's embedded help for more details.

FASTPATH:

For information about current and payoff balance, refer to [Current Amount versus Payoff Amount](#).

SA Non-Accrual Accounting Balance

NOTE:

Only relevant if you practice non-accrual accounting. This transaction is only relevant if you practice non-accrual accounting (e.g., you only pay the taxing authorities when the customer pays you, you defer revenue recognition till a later date, or a combination of the two). Refer to [Payables Cash Accounting](#) and [Deferred Accrual Accounting](#) for more information about non-accrual accounting.

This page displays a grid that shows a service agreement's non-accrual accounting balance for each non-accrual holding distribution code that's been booked to. Use **Menu > Financial Query > SA Non-Accrual Accounting Balance** to open this page.

Description of Page

The following columns are displayed in the grid:

Holding Distribution Code This is a general ledger distribution code used as the holding account for non-accrual accounting. Each holding account that's been used by this service agreement will appear here.

Payable Distribution Code This is the general ledger distribution code to which the payable is (or will be) transferred when the cash event occurs or when the designated revenue recognition date elapses. The system supports revenue recognition on the bill due date.

FASTPATH:

For more information on how the distribution codes are set up, refer to [Setting Up Distribution Codes](#).

Payoff Balance This column shows the service agreement's balance for each non-accrual holding account. If this amount is non-zero, it indicates that for this service agreement we are still holding some payables back until payment is received by the customer, at which time some or all of this amount will be transferred to the payable distribution code.

Accounting Method This column shows which accounting method is used for the distribution.

Accounting Priority This column shows the priority level associated with the distribution code. If more than one distribution code is to receive a payable then the priority level, along with debt age, will determine the order in which the transfers are made.

FASTPATH:

For information about non-accrual accounting, refer to [Payables Cash Accounting](#) and [Deferred Accrual Accounting](#).

Balance Control

This page is used to summarize the financial transactions that belong to a particular balance control group.

FASTPATH:

Refer to [The Big Picture of Balance Control](#) for more information.

NOTE:

Balance Control information is current only as of the Create Date/Time listed. The information displayed on the page is captured when the balance control background process is run. Any financial activity subsequent to the create date and time will not be shown.

Use **Menu > Financial Query > Balance Control** to open this page.

Description of Page

This page displays summarized financial information for a particular balance control group. It also details financial information for all SA Types that belong to the group.

The following fields are displayed on the page:

Group ID This is a sequential value that uniquely identifies a particular balance control run. The Group ID is assigned and incremented automatically every time the Balance Control background process is run.

Status This is the status of the balance control record: Pending, and Complete . The status of the balance control record will only be pending while the balance control background process is being executed. Balance control information is only reliable if the status is complete.

Create Date/Time This is the date and time that the balance control record was created. Financial information displayed on this page will only contain information for financial transactions frozen before this date and time.

Current Amount This is the sum of the current amounts of all FTs that belong to the balance control group.

Payoff Amount This is the sum of the payoff amounts of all FTs that belong to the balance control group.

Current Balance This is the sum of the current amounts of all FTs that belong to this balance control group plus all earlier balance control groups. Therefore this is the instantaneous current balance of the entire CIS as of the create date and time.

Payoff Balance This is the sum of the payoff amounts of all FTs that belong to this balance control group plus all earlier balance control groups. Therefore this is the instantaneous payoff balance of the entire CIS as of the create date and time.

The number of FT information details the number of bill segments, pay segments, adjustments and their cancellations that belong to the balance control group.

Adjustment The total number of adjustments that belong to this balance control group.

Adjustment Cancellation The total number of adjustment cancellations that belong to this balance control group.

Bill Segment The total number of bill segments that belong to this balance control group.

Bill Segment Cancellation The total number of bill cancellations that belong to this balance control group.

Pay Segment The total number of pay segments that belong to this balance control group.

Pay Segment Cancellation The total number of pay cancellations that belong to this balance control group.

The **SA Type** scroll summarizes the FTs that belong to a particular SA Type within the balance control group - otherwise all fields are defined as above. You can scroll through all SA Types that belong to the balance control group.

SA Type The SA Type being summarized.

Match Event

WARNING:

Match Events are only used if you practice [Open Item Accounting](#).

Match events are used to match debit and credit financial transactions together. When financial transactions are linked to a balanced match event, they no longer affect the customer's arrears.

You can use the match event page to do the following:

- Add, change, delete, and cancel match events.
- Add and remove financial transactions from / to a match event.
- Designate financial transactions as being "in dispute" (disputed financial transactions do not affect aged debt until they are resolved).
- View all unmatched financial transactions linked to an account.

FASTPATH:

Refer to [Match Events](#) for a full description of the lifecycle of a match event and a description of how the system automatically creates match events.

Match Event - Main

A typical match event matches a bill's financial transactions with a payment's financial transactions. The **Main** page allows you to define the bill(s) and payment(s) whose financial transactions are matched together. Use **Menu > Financial > Match Event > Search** to open this page.

NOTE:

Debit must equal credits. Before a match event impacts a customer's arrearage, its debits and credits must net to zero for every service agreement referenced on the match event. Until that time, the financial transactions on a match event continue to affect arrearage. The only exception is the case of [disputes](#).

You can match any debit and credit. While the above describes the matching of bills and payments, it's important to remember that a match event matches any type of debit with any type of credit. This means that a match event could match a bill with a credit or correction note, or a payment with a payment cancellation.

You can match any number of payments under a match event. While most match events deal with a single bill and a single payment, there's no limitation to the number of payments on a match event. The only restriction is that the debits and credits must net to zero for all service agreements.

It is better not to mix multiple bills on a single match event. For purposes of bill balance information, it is strongly recommended that you compose your match events with financial transactions limited to a single bill. If you mix financial transactions from multiple bills on a single match event you will not be able to determine the unpaid balance of a partially paid bill.

You can match specific financial transactions. While most match events deal with every financial transaction on a bill and payment, a match event can deal with individual financial transactions. For example, a match event could match a bill segment with a combination of a payment segment and a write-off adjustment. If you need to add or remove a specific financial transaction (i.e., a bill segment, payment segment, or adjustment), navigate to the **FT Details** tab. Perhaps a better way to differentiate between this page and the **FT Details** tab is to consider the example of a bill with 100 bill segments. When you link this bill to a match event, you are actually linking its 100 financial transactions. If you wanted to add only a subset of this bill's financial transactions to the match event, you'd use the **FT Details** tab.

FASTPATH:

Refer to [How To](#) for instructions describing how to perform common match event maintenance functions.

Description of Page

This page is used to maintain the financial transactions (FTs) that are linked to a match event. The remainder of this section defines each of the fields on the page.

Match Event Info and **Match Event ID** only appear after the match event exists on the database. The **ID** is a system assigned random number that stays with the match event for life. **Match Event Info** is a concatenation of important details about the match event and its account.

The next section contains the sum of the **Debit** and **Credit** financial transactions linked to the match event. If the debits and credits do not sum to zero, the **Difference** is also shown.

Account ID defines the account whose financial transactions are matched under this match event. This field is gray after the match event is added to the database.

Match Event Status defines the state of the match event.

- Match events are initially created in the open state. Please note that you may delete an open match event.
- The system automatically changes an open event's status to balanced when the sum of the **Debit(s)** equals the sum of the **Credit(s)** for each service agreement on the match event. It's worth stressing that a match event may contain financial transactions from many service agreements and each service agreement's financial transactions must sum to zero before the match event can become balanced.
- You may re open a balanced event (by adding / removing items so that the match event becomes unbalanced).
- You can cancel a balanced or open match event by changing the **Match Event Status** to cancelled. You must also define a **Cancel Reason** if you cancel a match event. Refer to [How Are Match Events Cancelled?](#) for more information about cancellation.

Turn on **Dispute** if this match event exists to designate certain financial transactions as **disputed**. In addition,

- Describe the reason for the dispute in **Remarks**.
- Link the disputed financial transactions to the match event by selecting the bill(s) below. If only a subset of a bill is disputed:
- Click on the respective hyperlink in the **Unmatched Debits** column grid (this will transfer you to the next tab with these financial transactions displayed).
- Select the bill segments that you want to designate as disputed.
- Press the **Link / Unlink** button to link the selected bill segments to the match event.

NOTE:

Disputing items on a balanced event. The **Dispute** switch will be protected when the match event is Balanced or Cancelled. If the items on a balanced event are being disputed, you must add / remove items so that the match event becomes Open before you can turn on the **Dispute** switch.

The remainder of the page is dynamic depending on the **Match Event Status**:

- If the status is Balanced or Open, a grid appears containing a summary of the bills, payments, credit or correction notes, and payment cancellations that contribute financial transactions to the match event (note, we refer to these collectively as "contributing objects" in the following discussion). The following columns appear in this grid:
- **Transaction Type** defines whether the contributing object is a Bill, Payment, Payment Cancellation, or Credit or Correction Note. In the rare situation when unbilled financial transactions are linked to the match event, a transaction type of Not Billed Yet appears. If the contributing object is a bill its bill id is also displayed. If sequential bill functionality is enabled, the bill's sequential id is displayed instead.
- **Matched Activity Information** contains summary information about the contributing object. This column is blank if the transaction type is Not Billed Yet.
- The remaining columns contain the count and amount of each contributing object's financial transactions categorized as follows (note, you can drill down on the count or amount to see the specific financial transactions (FT's) on the next tab).
- **Matched Debits** summarizes the contributing object's debit FT's that are linked to this match event. A checkbox appears if the count is greater than zero. If you select the checkbox and press the **Link / Unlink** button, these debits will be removed from the match event.

- **Matched Credits** summarizes the contributing object's credit FT's that are linked to this match event. A checkbox appears if the count is greater than zero. If you select the checkbox and press the **Link / Unlink** button, these credits will be removed from the match event.
- **Other Debits** summarizes the contributing object's debit FT's that are NOT linked to this match event.
- **Other Credits** summarizes the contributing object's credit FT's that are NOT linked to this match event.

NOTE:

Adding more financial transactions to a balanced match event. When a match event is Balanced, the grid showing unmatched FT's is suppressed (and therefore you can't add additional FT's to the match event). To expose this grid, simply change the status of the match event to Open.

- If the status is Open, a second grid appears containing a summary of the bills, payments, credit notes, correction notes and payment cancellations with at least one unmatched financial transaction (we refer to these collectively as "unmatched objects" in the following discussion). The following columns appear in this grid:
- **Transaction Type** defines whether the unmatched object is a Bill, Payment, Payment Cancellation, Credit, or Correction Note. A transaction type of Not Billed Yet is used for unbilled financial transactions (e.g., adjustments generated between bills). If the unmatched object is a bill its bill id is also displayed. If sequential bill functionality is enabled, the bill's sequential id is displayed instead.
- **Unmatched Activity Information** contains summary information about the unmatched object. This column is blank if the transaction type is Not Billed Yet.
- The remaining columns contain the count and amount of each unmatched object's financial transactions categorized as follows (note, you can drill down on the count or amount to see the specific financial transactions (FT's) on the next tab).
- **Unmatched Debits** summarizes the unmatched object's debit FT's that are not linked to any match event. A checkbox appears if the count is greater than zero. If you select the checkbox and press the **Link / Unlink** button, these debits will be added to the match event.
- **Unmatched Credits** summarizes the unmatched object's credit FT's that are not linked to any match event. A checkbox appears if the count is greater than zero. If you select the checkbox and press the **Link / Unlink** button, these credits will be added to the match event.
- **Matched Debits** summarizes the unmatched object's debit FT's that are linked to any match event.
- **Matched Credits** summarizes the unmatched object's credit FT's that are linked to any match event.

NOTE:

Credit Notes or Correction Notes. The Bill Correction option on the Installation record controls whether Credit Notes or Correction Notes are allowed. The default Transaction Type displayed is for Credit Note. If your implementation uses Correction Notes, you'll need to change the transaction type filter to reflect this. This is done by overriding the label for lookup value CRNT on the customizable lookup field TXN_FLTR_TYPE_FLG.

The last section contains the running total of the **Debit** and **Credit** financial transactions that have been selected / unselected in the above grids. If debits and credits do not sum to zero, the **Difference** is also shown. These values differ from the values on the top of the page as they are updated when a user selects / unselects an object (whereas the values at the top of the page are only updated when the database is changed).

The **Link / Unlink** button becomes enabled when you select an object in the grids. When you press this button, the financial transactions related to the object are added to / removed from the match event.

Match Event - FT Details

On the **Main** tab, you can add and remove bills, payments, credit notes, correction notes and payment cancellations to / from a match event. When you do this, you are actually adding and removing all of the financial transactions linked to these objects. For example, when you link a bill with 100 bill segments to a match event, you are actually linking its 100 financial transactions.

You need only use the **FT Details** tab when you need to add or remove specific financial transactions. For example, you would use the **FT Details** tab if you need to remove 1 of a bill's 100 financial transactions from a match event.

Use **Menu > Financial > Match Event > Search** and navigate to the **FT Details** page (note, you can also open this page using many of the hyperlinks on the Main and SA Subtotals tabs).

Description of Page

This page is used to maintain the financial transactions (FTs) that are linked to a match event. The remainder of this section defines each of the fields on the page.

Match Event Info and **Match Event ID** only appear after the match event exists on the database. The **ID** is a system assigned random number that stays with a match event for life. The **Match Event Info** is a concatenation of important details about the match event and its account.

The next section contains the sum of the **Debit** and **Credit** financial transactions linked to the match event. If the debits and credits do not sum to zero, the **Difference** is also shown.

The following **Filters** work together to restrict the financial transactions that appear in the grid. The following points describe the various options (note, don't forget to press the search button after specifying the various filter options):

- Use **Transaction Type Filter** to restrict the type of transactions that appear in the grid. The following options are available:
 - All. Use this option if you do not wish to restrict financial transactions based on their transaction type.
 - Bill. This option allows you to view a specific bill's financial transactions. When this option is selected, an input field appears in which you identify the **Bill ID**.
 - Credit Note. This option allows you to view a specific credit note's financial transactions. When this option is selected, an input field appears in which you identify the **Bill ID** (every credit note has a unique bill ID).
 - Correction Note. This option allows you to view a specific correction note's financial transactions. When this option is selected, an input field appears in which you identify the **Bill ID** (every correction note has a unique bill ID).
 - Not Billed Yet. This option allows you to view financial transactions that haven't appeared on a bill yet (e.g., adjustments and corrections).
 - Payment. This option allows you to view a specific payment's financial transactions. When this option is selected, an input field appears in which you identify the **Payment ID**.
 - Payment Cancellations. This option allows you to view a specific canceled payment's financial transactions. When this option is selected, an input field appears in which you identify the **Payment ID**.

NOTE:

Credit Notes or Correction Notes. The Bill Correction option on the Installation record controls whether Credit Notes or Correction Notes are allowed. The default Transaction Type displayed is for Credit Note. If your implementation uses Correction Notes, you'll need to change the transaction type filter to reflect this. This is done by overriding the label for lookup value CRNT on the customizable lookup field TXN_FLTR_TYPE_FLG.

- Use **Linkage Filter** to restrict the transactions based on the match event to which they are linked. The following options are available:
 - All. This option shows all financial transactions regardless of their match event.
 - Linked to another Match Event. This option shows financial transactions linked to a different match event.
 - Linked to any Match Event. This option shows financial transactions linked to any match event.
 - Linked to this Match Event. This option shows financial transactions linked to this match event.

- Unmatched. This option shows financial transactions that are not linked to a match event. This filter is protected and set to Linked to this Match Event if the **Transaction Type Filter** is All.
- Use **Debit / Credit Filter** to restrict the transactions based on whether they are debits or credits. The following options are available:
 - All. This option shows all debit and credit financial transactions.
 - Credit. This option shows all credit financial transactions.
 - Debit. This option shows all debit financial transactions.
- Use the **SA Filter** to define the types of service agreements whose financial transactions appear in the grid. The following options are available:
 - Address. Use this option to restrict financial transactions to those whose service agreements are linked to service points associated with a given **Address, City** and/or **Postal** code. Note, you can specify any combination of these fields.
 - All. Use this option if you do not wish to restrict financial transactions based on service agreement attributes.
 - Geographic Type. Use this option to restrict financial transactions to those whose service agreements are linked to service points associated with a given **Geo Type** and **Value**.
 - SA ID. Use this option to restrict financial transactions to those linked to a specific **Service Agreement**.
 - SA Type. Use this option to restrict financial transactions to those whose service agreements are linked to a given **CIS Division** and **SA Type**.

WARNING:

Don't forget to click the search button after changing the filters.

The **Select All / Clear All** buttons are used to select financial transactions to add to / remove from the match event (note, after selecting the desired financial transactions, you must also press the **Link / Unlink** button at the bottom of the page).

NOTE:

50 financial transactions at a time. Clicking **Select All** selects the first 50 bill segments in the grid. If more than 50 financial transactions exist, you must select them in batches.

The grid that follows contains the financial transactions (FT) that match your search criteria. The following information appears in the grid:

- **Select box.** Select the FT if you want to Link / Unlink it. You implicitly link FT's that are NOT already linked and you implicitly unlink FT's that are already linked. This field is protected if the FT is linked to another match event.
- **FT Amount.** This column contains the amount of the financial transaction.
- **FT Type.** This column indicates the type of financial transaction: Bill Segment, Bill Segment Cancellation, Pay Segment, Pay Segment Cancellation, Adjustment, and Adjustment Cancellation.
- **Arrears Date.** This column contains the financial transaction's arrears date.
- **SA Information.** This column contains a summary of the financial transaction's service agreement.
- **Remarks.** This column highlights the financial transaction's match status: Linked to this match event, Not linked to a match event, Linked to another match event - match event status.
- **Premise Information.** This column contains a summary of the premise (if any) associated with the financial transaction's service agreement.

The last section contains the running total of the **Debit** and **Credit** financial transactions that have been selected / unselected in the grid. If debits and credits do not sum to zero, the **Difference** is calculated. These values differ from the values on the top of the page as they are updated when a user selects / unselects an object (whereas the values at the top of the page are only updated with the database is changed).

The **Link / Unlink** button becomes enabled when you select a row in the grid. When you press this button, the financial transactions related to the object are added to / removed from the match event.

Match Event - Subtotals

Before a match event impacts a customer's arrearage, its debits and credits must net to zero for every service agreement referenced on the match event. This page shows the sum of the debits and credits for every service agreement that contributes at least one financial transaction to the match event. Use **Menu > Financial > Match Event > Search** and navigate to the **Subtotals** page

Description of Page

This page shows the sum of the debits and credits for every service agreement that contributes at least one financial transaction to the match event.

Match Event Info and **Match Event ID** only appear after the match event exists on the database. The **ID** is a system assigned random number that stays with a match event for life. The **Match Event Info** is a concatenation of important details about the match event and its account.

The next section contains the sum of the **Debit** and **Credit** financial transactions linked to the match event. If the debits and credits do not sum to zero, the **Difference** is also shown.

The following **Filters** work together to restrict the service agreements that appear in the grid. The following points describe the various options (note, don't forget to press the search button after specifying the various filter options):

- Use the **SA Filter** to define the types of service agreements whose financial transactions appear in the grid. The following options are available:
 - Address. Use this option to restrict service agreements to those linked to service points associated with a given **Address**, **City** and/or **Postal** code. Note, you can specify any combination of these fields.
 - All. Use this option if you do not wish to restrict service agreements.
 - Geographic Type. Use this option to restrict service agreements to those linked to service points associated with a given **Geo Type** and **Value**.
 - SA ID. Use this option to see a specific **Service Agreement**.
 - SA Type. Use this option to restrict service agreements to those with a given **CIS Division** and **SA Type**.
- Use **Status Filter** to restrict the service agreements based on whether the sum of the debits and credits they contribute to the match event. The following options are available:
 - All. Use this option if you do not wish to restrict service agreements based on this status.
 - Balanced. This option shows only service agreements where the sum of debit and credits nets to zero on this match event.
 - Unbalanced. This option shows only service agreements where the sum of debit and credits do not net to zero on this match event.

WARNING:

Don't forget to click the search button after changing the filters.

The grid that follows contains the service agreements that match your search criteria. The following information appears in the grid:

- **SA Information.** This column contains a summary of important information about the service agreement.
- **Difference.** This column contains the difference between the **Matched Debits** and **Match Credits**. If this is non-zero, the value appears in red.

- **Matched Debits.** This column contains the sum of debit financial transactions that this service agreement contributes to this match event.
- **Matched Credits.** This column contains the sum of credit financial transactions that this service agreement contributes to this match event.
- **Premise Information.** This column contains a summary of the premise (if any) associated with the financial transaction's service agreement.

How To Perform Common Match Event Functions

How To Find The Match Event Associated With A Financial Transaction

If you need to find the match event on which a financial transaction (FT) was matched, display the FT in question on [Financial Transaction - Main](#) and then use the "go to" button adjacent to the **Match Event** to drill to the match event.

NOTE:

The easiest way to display a financial transaction is to find its corresponding [bill](#), [payment](#) or [adjustment](#) and then drill down on the desired transaction.

How To Dispute An Item

Refer to [Disputing Items](#) for background information about disputes.

If a customer wants to dispute an item:

- Turn the match event's dispute switch on.
- Link the disputed financial transaction to the match event.
- Describe in the match event's comments the reason for the dispute.

How To Match A Small Mismatch

Assume the following scenario arises:

- A bill is produced for \$2000
- The customer pays \$1993
- An unbalanced match event will result because the customer didn't pay exactly what is owed

If you want to match this payment to the bill (and leave \$7 for the next bill), do the following:

- Create a transfer adjustment of \$7 where the transfer from / to service agreement is the same. This results in a debit financial transaction (FT) of \$7 and a credit FT of \$7.
- Create a match event (or update the unbalanced match event) where the matched FTs are:
 - The \$1993 payment
 - The credit side of the transfer adjustment (\$7)

- And the \$2000 bill
- Then, if the customer pays their next bill in full, the \$7 debit (associated with the transfer adjustment) will be swept onto it.

NOTE:

Automating small mismatches. The algorithm responsible for matching a payment to a specific bill can have a tolerance amount defined on it. If the payment is within the tolerance limit, this algorithm will do the above for you. In other words, you don't have to manually do the above if you populate the tolerance limit appropriately on this algorithm. Refer to DSOV BILL-ID for more information about this algorithm.

Deposits

In this section, we describe how to manage your deposits.

The Big Picture Of Deposits

The topics in this section provide background information about a variety of deposit issues.

FASTPATH:

We strongly recommend familiarizing yourself with the topics described in [The Financial Big Picture](#) to fully appreciate how deposits fit into the system's financial architecture.

Cash Deposits

Before you can bill a customer for a deposit, there must be a deposit service agreement (SA). Deposit SAs will be created by a CSR using [Start/Stop Service](#) (the same page used to create all other types of service agreements).

Deposit SAs behave just like any other service agreement in that:

- A deposit SA must reference an SA type. Refer to [Service Agreement Type Controls Everything](#) for information about how SA type controls a service agreement's behavior.
- Bill segments will be produced to bill the customer for a deposit. Note, bill segments associated with deposit SAs will appear on the same bill as other bill segments related to its account (i.e., a bill could contain a combination of utility, deposit, and non-utility bill segments).
- When a customer makes a payment, it will be distributed amongst its account's SAs based on each SA's payment distribution priority. This means a single payment could relieve receivable accounts (associated with utility service agreements) and increase a payable account (associated with the deposit service agreement). Refer to [Distributing A Payment Amongst An Account's Service Agreements](#) for more information.
- You can use a transfer adjustment to relieve debt on some other type of service agreement (by transferring all or part of the deposit's credit balance to another service agreement).
- You can use an A/P adjustment to cause a check to be created if you need to manually refund a deposit.
- When you no longer require the deposit, a CSR will stop the deposit SA using [Start/Stop Service](#) (the same page used to stop all other types of service agreements). Refer to [Refunding Deposits](#) for information about how the refund actually takes place.

FASTPATH:

Refer to [Deposit Class Controls Everything for information](#) about deposit interest, the recommended deposit amount algorithm, and how deposits are refunded.

NOTE:

An account can have many deposits. You can view all deposits (both cash and non-cash) linked to an account on [Account - Deposits](#).

Refunding Deposits

To refund a deposit, you simply need to change the deposit SA's state to pending stop. The system does everything else (i.e., calculates interest and refunds the deposit to the customer).

There are three ways in which a deposit SA's state can become pending stop:

- The Deposit Refund background process (DEPRFND) make a deposit service agreement pending stop when it detects that the customer meets the automatic refund criteria. Refer to [Defines The Conditions That Cause The System To Automatically Refund A Deposit](#) for a description of how to define the conditions that control automatic refund.
- An operator, at their discretion, may refund a deposit by stopping the deposit SA using [Start/Stop Service](#) (the same page used to stop all other types of service agreements). This page simply changes the deposit SA's state to pending stop.
- The system changes the state of a deposit service agreement to pending stop when it recognizes that all other SAs of its deposit class have also been stopped. This may be necessary, for example, when a customer's utility service agreements have been severed for non-payment. Refer to [Deposit Seizures When Other SAs Are Stopped](#) for more information.

The system changes the state of a pending stop SA to stopped when the process responsible for [Finalizing Pending Stops](#) next runs.

When a deposit SA becomes stopped, the system calculates interest through the stop date. Refer to [Controls Interest Calculation](#) for a description of how interest is calculated.

NOTE:

If you can't wait for this process to run, simply display the deposit SA on [Service Agreement - Main Information](#) and press the stop button.

When the stopped deposit SA is final billed, the system produces a final bill segment that shows the deposit amount being returned to the customer. When the bill segment's bill is completed, the deposit is refunded to the customer as per the deposit refund algorithm on the deposit's deposit class. Refer to [Controls How Deposits Are Refunded To A Customer](#) for a description of how a deposit is refunded.

WARNING:

None of the base package deposit refund algorithms create an A/P adjustment when the deposit service agreement is final billed. Rather, they depend on the [write-off preprocessing](#) to actually refund the deposit to the customer.

Partial Refunds

You can perform a partial refund by creating an adjustment for the deposit SA. If you want to refund the adjustment with a check, this adjustment should be an A/P adjustment (i.e., one that is interfaced to A/P). If you want to refund the adjustment by offsetting some other service agreement's debt, create a transfer adjustment (transferring from the deposit SA to the SA to be relieved).

After creating the adjustment, you'll find that the deposit SA has a positive current amount due (because you debited the deposit SA to refund the credit amount). You should create another adjustment to return the current amount of the deposit to zero. It's important to use an adjustment type that only affects current amount when you do this.

After getting the deposit's current amount back to an expected amount, you will have to change the deposit SA's Total Amount To Bill to reflect the amount of deposit you want to hold for the customer. So, for example, if you were holding a \$500 deposit and you want to refund \$100, you should change the deposit SA's Total Amount To Bill to be \$400.

Total Amount To Bill

Most deposit service agreements contain a "Total Amount To Bill" field. The label for this field is defined on the SA type (on the Billing tab). For deposit SAs, it should be labeled something like **Cash Deposit Amount**. This field should reflect the deposit amount you WANT to hold on this service agreement. Please be aware of the following in respect of this field:

- If the payoff balance (i.e., the current deposit held) is less than the Total Amount To Bill, the system will generate a bill segment to charge the customer for the deposit.
- If the deposit service agreement uses a recurring charge (i.e., you bill the total amount in installments), the amount billed to the customer will not exceed the recurring charge amount (unless the bill segment is prorated).
- If the deposit service agreement does not use a recurring charge, the amount billed will equal the difference between Total Amount To Bill and the service agreement's payoff balance.
- If you need to bill an incremental deposit on an existing deposit service agreement, simply change the deposit service agreement's Total Amount To Bill.
- If the payoff balance (i.e., the current deposit held) is greater than the Total Amount To Bill, the system will NOT refund the excess deposit.

NOTE:

SA Type and Total Amount to Bill. A deposit service agreement's SA type controls if the deposit service agreement uses Total Amount to Bill. Typically, the only SA types that indicate this field can be used are loan and deposit service agreements.

Current Balance versus Payoff Balance

WARNING:

If you do not understand the difference between payoff balance and current balance, refer to [Current Amount versus Payoff Amount](#).

The current balance on a deposit SA contains the amount of the deposit that has been billed, but not paid. The payoff balance on a deposit SA contains the amount of deposit being held. The payoff balance is a negative number because your company owes this money to the customer.

The financial ramifications of a deposit SA are predictable (if you're an accountant). The following table outlines the different financial events and their impact on the general ledger, arrearage history, and the amounts due (both current and payoff).

NOTE:

It's important to be aware that everything that is shown in this table is controlled by how you set up the deposit SA type's bill segment type, payment segment type, and adjustment types. Refer to [Service Agreement Type Controls Everything](#) for how to do this.

Event	GL Accounting	Arrearage Rule	Effect On Payoff Amt	Effect On Current Amt	Payoff Balance	Current Balance
Deposit billed	N/A - the GL is not affected when a deposit is billed	\$100 starts aging	0	+100	0	100
Payment received	Cash 100 Deposit Payable <100>	\$100 relieved accordingly	-100	-100	-100	0
Interest calculated	Interest Exp 5 Deposit Payable <5>	N/A	-5	0	-105	0

The following points describe the events in the above table:

- **Deposit billed.** In this example, the customer is billed for \$100 deposit.
- The customer really thinks they owe the billed amount, \$100. Therefore, current amount is affected. However, if the customer was to cash out, they wouldn't owe your organization anything, therefore payoff amount is not affected.
- Notice that the GL is not affected when the deposit is billed. This is because most organizations do not show a receivable for billed deposits (as it's not a true receivable).
- Because current amount changed by \$100, arrearage history is affected accordingly.
- **Payment received.** With any luck, the client will pay the \$100 that was billed.
- The payment has a normal affect on the GL (debit cash, credit deposit payable). The deposit payable GL account is defined as the deposit SA type's Distribution Code.
- The amount the customer thinks they owe decreases by \$100, therefore current amount is affected by the payment amount. And, if the customer was to cash out, your organization would owe the customer \$100, therefore payoff amount is affected by the payment amount.
- Because current amount changed by \$100, arrearage history is affected accordingly.
- **Interest calculated.** In this example, the system calculates interest of \$5.
- The interest is posted to the GL (the interest expense distribution code is defined on the respective adjustment type).
- The interest amount didn't affect how much the customer thinks is due them. Therefore current amount is unaffected. However, if the customer was to cash out, your organization would owe them \$100 + \$5 (the interest) therefore payoff amount is affected by \$5.
- Because current amount is not changed, arrearage history is not affected.

Multiple Deposits Linked To A Single Account

The system has been designed to allow your customers to have multiple deposits. This is necessary when a deposit is restricted to a specific type of debt. For example, if separate deposits are held for regulated and unregulated debt (and a customer could hold a combination of regulated and unregulated debt), you'd need one deposit for regulated debt and another for unregulated debt.

NOTE:

Deposit class. A deposit's deposit class controls the service agreements that are covered by a given deposit. A deposit's deposit class is defined on its SA type. Refer to [Designing Your Deposit Classes](#) for more information.

It's important to be aware that if your company has multiple classes of deposits, the system will recommend and refund deposits for each individual deposit class. For example, if you have both regulated and unregulated deposit classes, the system will recommend separate deposits for each class. And at refund time, a deposit will be distributed to only those service agreements associated with its deposit class (i.e., a regulated deposit will not be used to satisfy unregulated debt).

Deposits and Credit & Collections

The [account debt monitor](#) monitors deposit service agreements just as it monitors every other service agreement for overdue debt. If the amount of debt on the deposit SA violates your collection criteria, a collection process will start.

FASTPATH:

Refer to [The Lifecycle Of A Collection Process And Its Events](#) for more information.

It's important to be aware that deposit debt can be treated differently from other types of debt linked to an account by creating a specific debt class for the deposit SA type.

FASTPATH:

Refer to [Designing Your Collection Procedures](#) for more information about how to have different collection criteria for different debt classes.

The type of severance process associated with a deposit SA is probably rather simple - you probably will want a To Do entry generated to advise an operator that a customer hasn't paid their deposit.

FASTPATH:

Refer to [The Lifecycle Of A Severance Process And Its Events](#) for more information.

Please see [Deposit Seizures When Other SAs Are Stopped](#) for a description of how the system seizes an active deposit service agreement when normal (i.e., non-cash deposit) service agreements are stopped.

After a deposit SA is stopped, it will be "final billed" the next time the account is billed. Refer to [Refunding Deposits](#) for more information about how deposit refunds are "final billed". If a credit balance remains on the deposit SA after it is final billed, the [Write-Off Monitor](#) will process the deposit SA just like it processes all unpaid and final billed service agreements. If you set up the deposit SA's [write-off controls](#) properly (i.e., you plug in the appropriate refund and write-down algorithms), the write-off monitor will refund / write-down the credit balance (thus causing the deposit SA to close).

Deposit Seizures When Other SAs Are Stopped

Consider the situation when a severance process cuts a service due to non-payment. At some point, if the customer doesn't pay, you'll want to seize the deposit and apply it to the overdue debt. To implement this, the system simply stops the deposit SA when it stops the last SA in its deposit class (refer to [Finalizing Pending Stops](#) for more information about stopping service agreements). Then, when the account is next billed, the standard deposit refund process will offset outstanding debt before it is refunded to a customer.

Refer to [Refunding Deposits](#) for a complete description of how the system refunds a stopped deposit SA's balance to other service agreements in its deposit class.

NOTE:

Deposit class refund method is the key. It's important to stress that the only way the system will use a deposit to offset overdue debt is if the deposit's deposit class has a refund method that does this. If you've set up a deposit class' refund method to cut a check for the entire deposit amount, the system will not offset outstanding debt. Refer to [Deposit Class - Refund Method](#) for more information.

Non-Cash Deposits

When an account is required to post a deposit, they can remit cash or some other type of surety (e.g., letters of credit, surety bonds, 3 rd party deposits). When cash is remitted, a deposit service agreement is used. When some other type of surety is used, a *non-cash deposit* must be created.

Non-cash deposits are held in respect of an account and an account may have an unlimited number of non-cash deposits (note: cash deposits are held in respect of a deposit service agreement that is linked to remitting account). Refer to [Account - Deposits](#) for more information.

Each non-cash deposit must reference a non-cash deposit type. Besides defining the type of surety, the non-cash deposit type also controls:

- Whether such types of non-cash deposits can be highlighted when they are due to expire via the creation of a To Do entry (refer to TD-NCDEX for more information about this To Do entry).
- Whether a reference to a cash-deposit (i.e., service agreement) must be specified. Refer to [3rd Party Deposits](#) for more information about how a cash deposit can be referenced by another party.

FASTPATH:

Refer to [Setting Up Non-Cash Deposit Types](#) for more information.

In addition to non-cash deposit type, each non-cash deposit must reference a deposit class. Why? Because the system amalgamates cash and non-cash deposits when it determines if an account is holding an adequate deposit.

FASTPATH:

Refer to [What Do Deposit Classes Do?](#) for more information.

If you need to use a non-cash deposit to satisfy an account's debt, you must "cash in" the non-cash deposit. When the cash arrives, create a payment and apply it to the customer's outstanding service agreements.

Third Party Deposits

A third party deposit arises when a third party remits cash to cover the deposit needs of one or more accounts. Both cash and non-cash deposits must be created to record a third party deposit. The following example will explain how to do this.

Assume the Salvation Army remits \$5,000 on behalf of 50 customers (where each customer's account is allocated \$100). In this situation, you'd create the following information in the system:

- The Salvation Army must have an account with a deposit service agreement.
- When the Salvation Army remits the funds:

WARNING:

If you do not understand the difference between payoff balance and current balance, refer to [Current Amount versus Payoff Amount](#).

- Create an adjustment to "bill" the deposit service agreement (causing the deposit SA's current balance to be \$5,000 and the payoff balance to be 0).
 - Add a payment for the \$5,000 against the Salvation Army's account. This payment will cause the deposit SA's current balance to be 0 and the payoff balance to be -\$5,000. Note, if you don't mind the Salvation Army's current balance to be -\$5,000 after the payment is made, you wouldn't have to create the adjustment to "bill" the deposit.
 - Create a non-cash deposit for each of the 50 accounts being covered by the cash deposit. On each non-cash deposit, define the appropriate non-cash deposit type (e.g., 3rd party deposit) and amount \$100 each.
 - Interest will be applied to the Salvation Army's deposit service agreement as per the interest algorithm on the deposit SA's deposit class.
 - If you need to use the Salvation Army's payment to payoff overdue debt, you will use a transfer adjustment(s) to transfer from the deposit service agreement to the respective overdue service agreement(s).
-

IMPORTANT:

Be aware that the system will allow the sum of third party deposits to exceed the amount of the cash deposit (in our previous example, the system would allow you to create \$6,000 worth of third party non-cash deposits even though only \$5,000 of cash was remitted).

Deposit Class Controls Everything

A deposit service agreement's SA type references a deposit class. The topics in this section describe how deposit class controls the behavior of a deposit SA.

FASTPATH:

Refer to [Setting Up Deposit Classes](#) for a complete description of the business rules governed by a deposit class.

Controls Interest Calculation

Interest is applied to a deposit SA when:

- A deposit SA is stopped. Refer to [Refunding Deposits](#) for a description of how a deposit SA can be stopped.
 - The Apply Interest background process (DEPINTRF) determined that sufficient time has passed since interest was last calculated. The amount of time between interest calculations is defined on the deposit class.
A deposit SA's deposit class controls the following interest calculation functions:
 - The frequency of interest calculation.
 - The algorithm used to calculate the amount of interest (note, the interest rate is defined using a bill factor plugged in on this algorithm).
 - The method used to refund the interest.
-

NOTE:

Adjustments are used to apply interest. Interest is applied to a deposit SA using an adjustment (the adjustment type is also defined on the deposit class).

Controls The Recommended Deposit Amount

The following events cause the calculation of the recommended deposit amount:

- The Deposit Review background process (DEPRVW) compares an account's existing deposit (if any) to the recommended amount.
- A user requests a deposit calculation for a new deposit service agreement by pressing the  button on the [Start Confirmation](#).

A deposit service agreement's deposit class controls the algorithm used to derive the suggested deposit amount.

Defines The Conditions That Cause The System To Recommend A New or Additional Deposit

The Deposit Review background process (DEPRVW) will recommend an additional deposit be billed if the customer doesn't satisfy the definition of a *good customer*.

It's important to be aware that if your company has multiple classes of deposits, the system will recommend deposits for each individual deposit class used by an account. For example, if an account has both regulated and unregulated deposit classes, the system will recommend separate deposits for each class.

When the Deposit Review process analyzes an account's debt, it uses the following deposit class attributes:

- The definition of a good customer (the system only recommends deposits for bad customers).
- The tolerance percent that must be exceeded before the system will recommend an additional deposit for a customer. This tolerance percent prevents the recommendation of small amounts.
- The method used to derive the recommended deposit amount.

Assuming the C1-CR-UP-DRR review method algorithm is specified on the deposit class, the system does not automatically produce bills when an additional deposit is needed. Rather, the system's recommendations appear on the [Deposit Review](#) page. To implement a recommendation, an operator should change the deposit SA's [Total Amount To Bill](#) or add a new deposit SA.

NOTE:

Non-cash deposits are included. It's important to be aware that the system compares the recommended deposit amount against the sum of deposits on hand for a given deposit class. When amalgamating the total deposit on hand, the system includes both cash (i.e., deposit SA's payoff balance) and non-cash deposits.

Defines Automatic Refund Conditions

The Deposit Refund background process (DEPRFND) will refund a deposit to a customer when conditions defined on the deposit SA's deposit class are met. For example, a deposit's deposit class may indicate the system should automatically refund a deposit after the deposit has been held for 6 months and the customer is a good customer (the definition of a "good customer" is also on the deposit class).

Controls How Deposits Are Refunded To A Customer

The method used to refund a deposit to a customer is defined on the deposit SA's deposit class. For example, a deposit's deposit class may indicate the system will first apply the deposit to outstanding debt first and, if funds remain, cut a check.

It's important to be aware that if your company refunds deposits by first offsetting outstanding debt, the system will only offset debt within an individual deposit class. For example, if a customer has two deposits - one for regulated debt, the other for unregulated debt - the regulated deposit will only be used to offset regulated debt.

Deposit Background Processes

The topics in this section describe the background processes that automate deposit processing.

Deposit Interest

The Deposit Interest background process (DEPINTRF) examines all cash deposit service agreements (i.e., service agreements with a SA type with a special role of Cash Deposit). If enough time has passed since interest was last calculated, interest will be calculated using the service agreement's deposit class' Interest Refund Algorithm. Note: interest will be automatically calculated every X months where X is defined in the deposit class' Months Between Interest Refund.

Deposit Refund

The Deposit Refund background process (DEPRFND) examines all cash deposit service agreements (i.e., service agreements with a SA type with a special role of Cash Deposit). If the account meets the service agreement's deposit class' Refund Criteria Algorithm, the system changes the service agreement's state to Pending Stop. Refer to [Refunding Deposits](#) for a description of what happens next.

Review Deposits

The Review Deposits background process (DEPRVW) examines all accounts with service agreements that are governed by a deposit class (i.e., service agreements with an SA type that references a deposit class). If the account fails the deposit class' Good Customer Algorithm, the system calculates the recommended deposit amount (using the deposit class' Deposit Recommendation Algorithm). If the recommended amount exceeds the amount of deposit currently requested, the system will request an additional deposit. The deposit class' **Review Method Algorithm** is used to determine what action to take if the system requests an additional deposit. The system's recommendations appear on the [Deposit Review](#) page.

You may optionally provide a Deposit Class as input to restrict the review to account whose service agreements reference that deposit class.

NOTE:

Preventing small recommendations. The system uses the deposit class's Review Tolerance Percentage to prevent the recommendation of small deposits by the Deposit Review background process. For example, if this field contains 10(%), the system would only recommend an additional deposit if the existing requested deposit amount is less than 90% of the recommended amount.

Multiple deposits could be recommended for an account. Because an account can have service agreements that belong to multiple deposit classes, it is possible for a multiple recommendations to be generated for an account.

Deposit Review

The Deposit Review page shows all accounts for which an additional deposit is recommended.

NOTE:

The [Review Deposits](#) background process inserts rows on this query.

Multiple deposits could be recommended for an account. Because an account can have service agreements that belong to multiple deposit classes, it is possible for a multiple recommendations to be generated for an account.

Open this page using **Menu > Financial Query > Deposit Review.**

Description of Page

Use **Account ID** and / or **Deposit Class** to filter the rows. Each row displays an account / deposit class that holds an inadequate deposit.

NOTE:

Rows are also displayed for errors. Please be aware that if the Recommend Additional Deposit background process encounters an error when it attempts to calculate an account's recommended deposit, these errors also appear as rows in this query.

Press the  button to add a new deposit SA for the customer. Pressing this button causes [Start/Stop Service](#) to open. When this page opens, you should create a new deposit service agreement for the customer (by referencing the appropriate division / SA Type).

If the customer has one or more deposit service agreements, the drill button will be enabled. Pressing it will cause the [Service Agreement - Main Information](#) page to open. When this page opens, you can change Total Amount To Bill to reflect the total amount of deposit you want to hold. When billing next runs, it will bill the customer for the marginal difference between the current deposit held and the deposit amount to bill.

FASTPATH:

Refer to [Defines The Conditions That Cause The System To Recommend A New or Additional Deposit](#) for how rows are added to this query.

Statements

In this section, we describe how to manage your customer's statements.

The Big Picture of Complex Statements

Statements allow you to set up a person to receive a consolidated report of the financial activity for one or more accounts and/or service agreements. This allows you to model complex account scenarios, including the following examples.

- Satellite offices for a company are each responsible for paying their own bill, but the head office would like a consolidated report of the bills for all the satellite offices once a month. In this case, each satellite office is set up as an

account covering the services for their office. The head office does not want to receive individual copies of each bill, but rather a consolidated report of the financial activity for all the offices.

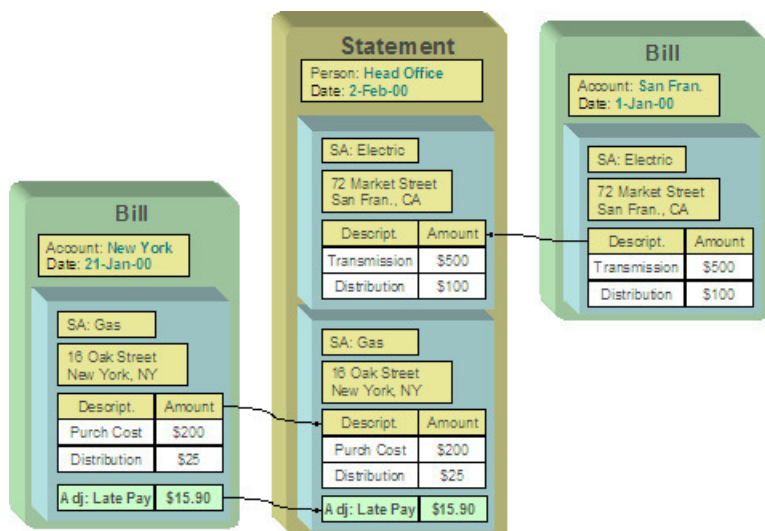

- The head office is responsible for paying the bill. The satellite offices should receive a copy of only their portion of the bill. In this case, a service agreement is set up for each satellite office under the head office's account. Each satellite office should receive a copy of the bill segment information for their office's service agreement.

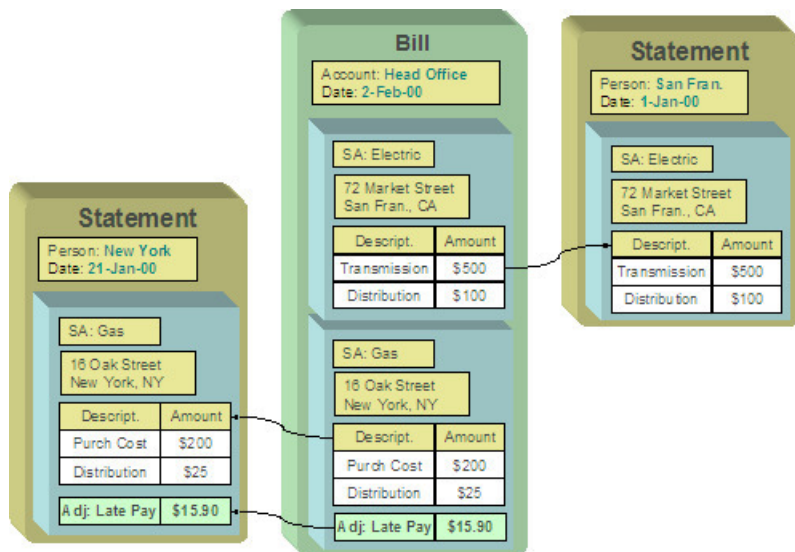

- The head office is responsible for paying the bill. Multiple departments need to see copies of the electric portion of the bill. As illustrated by this scenario, a service agreement or account may appear on many statements.

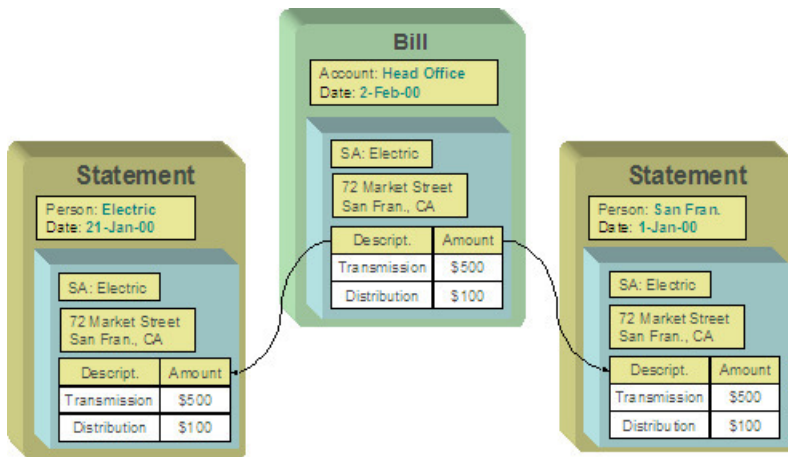

The topics in this section provide additional information about how to set up statements.

Constructing Statements

Statements are produced for a [person](#). Each statement contains the financial transactions for one or more [service agreements](#). The service agreements may belong to any number of [accounts](#). Over time, a person may receive many statements.

When setting up a person to receive statements, it's important to note that a person can receive different statements for different groupings of service agreements. For example, the head office may want a statement of the financial details for the western division offices separately from the eastern division offices.

For each separate statement a person wishes to receive, you will set up a statement construct. On the statement construct, you define the service agreements and/or accounts whose financial information should appear on the statement. If you specify an account on a statement construct, billing information for all the service agreements linked to the account will be included on the statement. The superset of service agreements and accounts defined on a statement construct are called the "construct details".

FASTPATH:

Refer to [Statement Construct Maintenance](#) for more information.

Producing Statements

Statement Cycles

The accounts and service agreements linked to a statement construct may have different bill cycles and as a result, their bills are produced on different dates. So when should a statement containing the consolidation of all this financial information be produced? To answer this question, there is a statement cycle.

Just as with a bill cycle, the statement cycle has a schedule. A statement cycle's schedule controls when a statement should be produced. Each statement construct will point to its own statement cycle.

FASTPATH:

Refer to [Statement Construct Maintenance](#) and [Statement Cycle](#) for more information.

Create Statements Background Process

This statement construction background process (STMPRD) is responsible for periodically creating statements. It works as follows:

- All statement cycles are selected with pending schedules whose production date is on or before the business date.
- For each such cycle, all of its statement constructs are selected. For each statement construct:
 - If a statement already exists for the cycle schedule and construct, it is deleted (this allows for reproduction after a mess up). Note well, this is true even if the statement is printed as you may have only spotted the problem after viewing the printed statement.
 - A statement is created.
 - All SAs associated with the construct details effective on the business date are extracted.
 - All "SA snapshots" associated with bills whose BILL DATE is within the construct detail's start and end dates that are not already linked to one of the construct's statements are linked to the new statement. Note, an "SA snapshot" is created for every service agreement linked to an account when a bill is completed for an account.
 - If no "SA snapshots" are found, the statement is removed.

NOTE:

The following diagram illustrates how the above logic could result in multiple bills for a single service agreement being linked to the same statement.

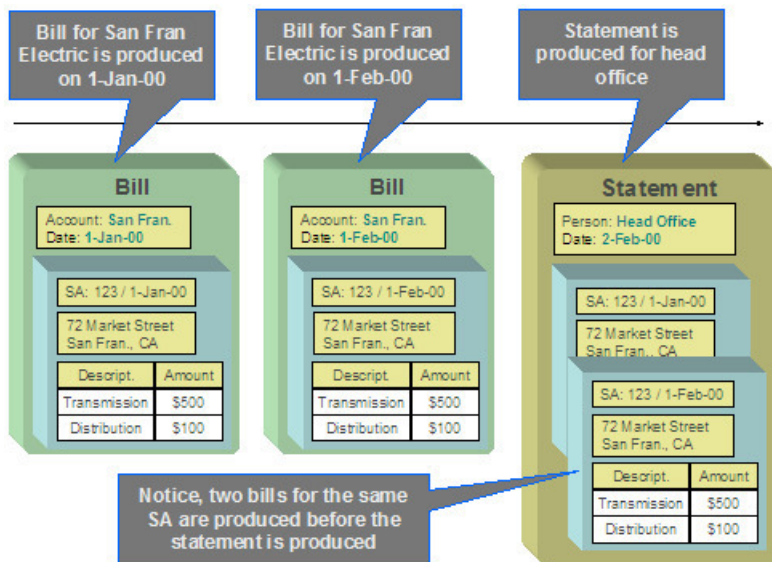

FASTPATH:

Refer to [Statement Maintenance](#) for more information about a statement and its details.

NOTE:

This process is rerunnable. If a problem occurred during the statement creation, simply run the background process again. It will clean up all existing statements for each construct in the current cycle schedule and start again.

FASTPATH:

Refer to [Printing Statements](#) for more information for how a separate background process uses the information snapshot on a statement to construct the extract file used to print the statements.

Statement Routing

Just as with bills, statements require routing information in order for the system to understand how and where to send the statements. For example, the system needs to know the method of routing, the number of copies and the format of the statement. This information is captured on a statement construct.

Where Are Statements Sent

The system extracts a statement's address as per its statement construct's address source. Note, if the address source is Person and the person has a [seasonal address](#) effective on the business date, the seasonal address will be used.

If you need to reprint a statement because it was addressed incorrectly, correct the person's address, and then reprint the statement (by pressing the **Reprint** button on the statement). When you press this button, the statement will be marked for downloading. When your download process next runs, it simply extracts the statement construct's current address.

On-Line Statement Production

Statements may be produced on-line as well as in batch. To produce a statement on-line, simply go to the Statement page, select the correct Construct ID and choose the Generate button.

This statement will include the financial information related to bills for the accounts and service agreements linked to this construct, with the following criteria:

- The bills do not already appear on a statement
- The bill dates fall within the "effective period" for the statement construct. In other words, the bill falls within the start and end period for the statement construct details.

FASTPATH:

Refer to [Statement Maintenance](#) for more information.

How to Regenerate a Specific Statement

There may be times when a specific statement needs to be regenerated. For example, perhaps a cancel / rebill has occurred since the statement was produced, and you wish to recreate the statement to reflect this.

If you need to regenerate a statement using up-to-date information, simply delete the statement and generate a new statement. This may be done on-line.

NOTE:

Statements may be deleted, even if they have already been printed. This enables you to delete and regenerate statements.

FASTPATH:

Refer to [Statement Maintenance](#) for more information.

Printing Statements

The contents of this section describe the technical implementation of printing statements.

Statement Route Types Control The Information Merged Onto Statements

Every statement references a [statement route type](#). The route type controls the following statement print functions:

- It contains an algorithm that is responsible for extracting the information merged onto your statements. Specifically, algorithms of this type create the "flat file records" that are passed to your statement print software. Algorithms of this type are called under the following scenarios:
 - The background process that builds the flat file that's passed to your statement print software calls these algorithms to construct the "flat file records" for each statement.
 - If your statement print software has the ability to construct a real-time image of a statement (in a PDF), you can plug-in an Online Statement Image algorithm on the [Installation Record](#). This type of algorithm will call the statement's dispatch group extract algorithm to extract the information that is merged onto the statement. Refer to [Technical Implementation Of Online Statement Display](#) for the details.
- Refer to [The Statement Extract Records](#) for examples of the record layouts passed to the document composition application.
- It contains the ID of the background process that builds the flat file that's passed to your statement print software. The base package example of this process ([STMDWLD](#)) simply calls each statement's construct's route type's extract algorithm to format the information placed onto the flat file.

Technical Implementation Of Online Statement Display

Users can view an image of any statement if you setup the following:

- Plug-in an Online Statement Display algorithm on the [Installation Record](#). Refer to ONSD-ST for an example of such an algorithm. Note, if your statement print software is not capable of producing a PDF containing an image of a statement, users will not be able to view images of statements.
- Plug-in the appropriate extract algorithm on each [statement route type](#). Algorithms of this type format the records that contain the information that is passed to your printing software. Refer to STEX-TX for an example of such an algorithm.

When you plug-in these algorithms, a button appears on [Statement - Main](#). When a user presses this button, the following takes place:

- The installation record's Online Statement Display algorithm is executed.
- This algorithm calls the statement's route type's extract algorithm. This algorithm constructs the information that's merged onto the statement and returns it to the Online Statement Display algorithm. This algorithm, in turn, passes it to your statement print software.

- Your statement print software renders an image of the statement in a PDF and returns it to the Online Statement Display algorithm.
- And finally, the Online Statement Display algorithm displays the PDF in a separate Adobe session.

Technical Implementation Of Printing Statements In Batch

The background process that extracts statement information ([STMDWLD](#)) reads all statements in a given run number that are marked with its batch control ID. For each statement, it creates numerous records on a flat file. These records contain the information that is merged onto your statements.

The base package example of this process ([STMDWLD](#)) simply calls the extract algorithm on the statement route type to format the information placed onto the flat file. Refer to [Statement Route Types Control The Information On Statements](#) for more information.

NOTE:

If your software doesn't support online statement display. The algorithm that formats statement extract records that's plugged in on [statement route type](#) serves two purposes: 1) it formats the records used to construct online images of a statement, and 2) it formats the records downloaded to your statement print software in batch. If your statement print software does not support the rendering of statement images real time, there is no need to create an extract algorithm. Rather, you should simply develop your own download process that both formats the extract records and downloads them (and then specify this batch process on your statement route type).

Reproducing The Statement Print Flat File

You can reproduce the flat file at any time. Simply request the [STMDWLD](#) process and specify the run number associated with the historic run.

How To Reprint A Specific Statement

If you need to reprint a specific statement, navigate to [Statement - Main](#) and press the **Reprint** button.

If your implementation has [enabled the online creation of statement images](#), you can also press the **Display Statement** button on this page and then print the resultant PDF on your local printer.

The Statement Extract Records

Numerous different types of records are interfaced to the document composition application. However, they all share a common structure:

- The first 4 bytes are called the **Printer Key**. This field is a record type used by the document composition application statement template.
- The next 186 bytes are called the **Sort Key**. This field is used to ensure the various records used to construct a printed statement appear in the correct order in the interface file.
- The next 12 bytes are called the **Mailing Key**. This field is used to control the order in which the formatted statements are printed.
- The remaining bytes contain the **StatementInformation** that appears on the printed statement. The type of information differs for each type of record.

The topics in this section describe each component.

Printer Keys (Record Types)

The following table defines each printer key (i.e., record type) on the statement print flat file.

Record Type	Description	Notes
0010	Global extract information	Required. 1 per flat file.
0100	Statement record	Required. 1 per statement.
0120	Total by currency record	Required. At least one per statement.
0500	Construct detail record	Required. At least one per construct detail linked to the statement construct.
0900	Service agreement record	1 per SA
1100	Bill record	1 per bill
1300	Financial Transaction (FT) record	1 per FT linked to the SA.
3600	End of record type 1100	1 for each bill
3700	End of record type 0900	1 for each SA
5000	End of record type 0500	1 for each statement construct detail
9999	End of record type 0100	1 for each Statement

Sort Key

The following table defines the structure of the sort key that appears on each statement print record. Please note that different components are filled in for each printer key.

Field Name	Format	Record Type	Source/Value/Description
Statement ID	A12	All	Prime key of the statement
Sequence Number	N2	All	Set to "1"
Copy Number	N2	All	Defaulted to "1" on the first copy, set to "1" when a statement is requested on-line
Statement record group	A2	0010	Blank
		0100	10
		0120	20
		0500, 0900, 1100, 1300, 3600, 3700, 5000	30
		9999	60
Construct detail sort sequence 1	N3	0010, 0100, 0120, 9999	blank
		0500, 0900, 1100, 1300, 3600, 3700, 5000	Statement construct's PRT_SEQ
Construct detail sort sequence 2	A10	0010, 0100, 0120, 9999	blank

		0500, 0900, 1100, 1300, 3600, 3700, 5000	Statement construct's STM_CNST_DTL_ID
Premise Indicator	A1	0010, 0100, 0120, 0500, 9999	Blank
		5000	'Z'
		0900, 1100, 1300, 3600, 3700	For a non-premise, this will be 'N' otherwise 'Y'
Premise State	A6	0010, 0100, 0120, 0500, 5000, 9999	Blank
		0900, 1100, 1300, 3600, 3700	Premise's state (if this is for a non-premise, this will be blank)
Premise City	A90	0010, 0100, 0120, 0500, 5000, 9999	Blank
		0900, 1100, 1300, 3600, 3700,	Premise's city (if this is for a non-premise, this will be blank)
Premise Address 1	A58	0010, 0100, 0120, 0500, 5000, 9999	Blank
		0900, 1100, 1300, 3600, 3700	Premise's address line 1 (if this is for a non-premise, this will be blank)
Premise Id	A10	0010, 0100, 0120, 0500, 5000, 9999	Blank
		0900, 1100, 1300, 3600, 3700	Premise's ID (if this is for a non-premise, this will be blank)
SA Print Priority	A2	0010, 0100, 0120, 0500, 5000, 9999	Blank
		0900, 1100, 1300, 3600, 3700	The SA's SA type's print priority
SA Id	A10	0010, 0100, 0120, 0500, 5000, 9999	Blank
		0900, 1100, 1300, 3600, 3700	The SA's SA ID
SA record group	A2	0010, 0100, 0120, 0500, 5000, 9999	Blank
		0900	10
		1100, 1300, 3600	20
		3700	30
Bill Date	A10	0010, 0100, 0120, 0500, 0900, 3700, 5000, 9999	Blank
		1100, 1300, 3600	Bill's bill date in the format YYYYMMDD.
Bill Id	A12	0010, 0100, 0120, 0500, 0900, 3700, 5000, 9999	Blank
		1100, 1300, 3600	Bill's bill id
Bill record group	A2	0010, 0100, 0120, 0500, 0900, 3700, 5000, 9999	Blank
		1100	10

		1300	20
		3600	30
Arrears Date	A10	0010, 0100, 0120, 0500, 0900, 1100, 3600, 3700, 5000, 9999	Blank
		1300	Financial transaction arrears date
FT Type	A2	0010, 0100, 0120, 0500, 0900, 1100, 3600, 3700, 5000, 9999	Blank
		1300	Financial transaction type

Mailing Key

The following table defines the structure of the mailing key that appears on each statement print record.

Field Name	Format	Source/Value/Description
Postal code	A12	This is the postal code on address associated with the statement.

Statement Information

The topics in this section describe the information that appears on each on each statement print record. The following links are provided so that you can move easily to specific topic within this section:

- [Global Extract Information Record \(0010\)](#)
- [Statement Record \(0100\)](#)
- [Total By Currency Record \(0120\)](#)
- [Statement Construct Detail Record \(0500\)](#)
- [Service Agreement Record \(0900\)](#)
- [Bill Record \(1100\)](#)
- [Financial Transaction \(FT\) Record \(1300\)](#)
- [End Bill Record \(3600\)](#)
- [End Service Agreement Record \(3700\)](#)
- [End Statement Construct Detail Record \(5000\)](#)
- [End Statement Record \(9999\)](#)
- [Address Sub-record](#)

Global Extract Information Record (0010)

Field Name	Format	Source/Value/Description
BATCH_CD	A8	Batch Control Code of the extract process.
BATCH_NBR	N10	Batch Number of the extract process
BATCH_RERUN_NBR	N10	Batch Rerun number of the extract process.

STATEMENT_CNT	N10	Count of statements on this extract. Multiple copies of a statement are counted multiple as well.
EXTRACT_DTTM	A31	System time of extraction. Formatted according to user profile.
STMT_ID_START	A12	This is only used when a statement is produced as a result of an online request (from Statement - Main). It contains the Statement Id to extract.
STMT_ID_END	A12	This is only used when a statement is produced as a result of an online request (from Statement - Main). It contains the Statement Id to extract.
THREAD_NBR	N10	This field is only used if statements are extracted in batch. It contains the thread number in which the statement was extracted.
THREAD_CNT	N10	This field is only used if statements are extracted in batch. It contains the total number of threads that were extracted.
STATEMENT_IND	A1	Defaulted to "Y"

[Top of Page](#)

Statement Record (0100)

Field Name	Format	Source/Value/Description
STMT_ID	A12	CI_STM
PER_ID	A10	CI_STM_CNST
STMT_DT	A31	STM_DT from CI_STM. Formatted according to user profile.
COPY_NBR	N1	"1"
NBR_STMT_COPIES	N1	"1"
ENTITY_NAME	A64	Main name of CI_PER (from CI_PER_NAME).
ADDRESS_SBR	A361	Address where the statement should be sent (the address is defined on the statement's statement construct).
ENTITY_NAME1	A64	CI_PER
ENTITY_NAME2	A64	CI_PER
ENTITY_NAME3	A64	CI_PER
DESCR50	A50	CI_STM_CNST

[Top of Page](#)

Total By Currency Record (0120)

One total record will be created for each currency code associated with the FT's associated with the SA snapshots linked to the statement.

Field Name	Format	Source/Value/Description
------------	--------	--------------------------

CURRENCY_CD	A3	This is the currency code associated with the summary information.
CUR_BAL	A30	This is the sum of CUR_AMT snapshot on the SA snapshots (CI_BILL_SA) linked to the statement. SA snapshots (CI_BILL_SAs) are referenced on CI_STM_DTL.
BILL_AMT	A30	This is the sum of CUR_AMT from CI_FT's classified as "corrections" and "current charges" on bill's associated with the statement. Please note, only those FT's associated with SAs linked to the statement will be amalgamated. This is formatted according to user's display profile.
CUR_ADJ_AMT	A30	This is the sum of CUR_AMT from CI_FT's classified as "adjustments" on bills associated with the statement. Please note, only those FT's associated with SAs linked to the statement will be amalgamated. This is formatted according to user's display profile.
CUR_PAY_AMT	A30	This is the sum of CUR_AMT from CI_FT's classified as "payments" on bills associated with the statement. Please note, only those FT's associated with SAs linked to the statement will be amalgamated. This is formatted according to user's display profile.

[Top of Page](#)

Statement Construct Detail Record (0500)

Field Name	Format	Source/Value/Description
STM_CNST_ID	A12	CI_STM_DTL
SA / Account Indicator	A1	A switch to indicate if the statement construct is for a service agreement of an account. 'S' for service agreement, 'A' for account.
Unique ID	A10	The unique identifier of the account or service agreement
SA / Account Info	A160	Contains the standard information about the account or service agreement
STMT_PRT_DESCR	A50	CI_STM_CNST

[Top of Page](#)

Service Agreement Record (0900)

Field Name	Format	Source/Value/Description
SA_ID	A10	CI_SA
Address Information	A120	This is the standard format of a premise address that is displayed throughout the system.

SA Information	A120	This is the standard SA information that is displayed throughout the system
SVC_TYPE_CD	A30	CI_SA_TYPE

[Top of Page](#)

Bill Record (1100)

Field Name	Format	Source/Value/Description
BILL_ID	A12	
Completion Date	A31	Date formatted according to user profile.
Due Date	A31	Date formatted according to user profile.
SA Ending Balance	A30	
FT Exist Indicator	A1	

[Top of Page](#)

Financial Transaction (FT) Record (1300)

Field Name	Format	Source/Value/Description
FT_ID	A12	CI_FT
ARS_DT	A31	CI_FT (The date when the transaction starts aging). Date formatted according to user profile.
AMOUNT	A30	CUR_AMT from CI_FT formatted according to user display profile.
FT_DESCR	A120	Formatted FT information.

[Top of Page](#)

End Bill Record (3600)

Field Name	Format	Source/Value/Description
Dummy field		

[Top of Page](#)

End Service Agreement Record (3700)

Field Name	Format	Source/Value/Description
Dummy field		

[Top of Page](#)

End Statement Construct Detail Record (5000)

Field Name	Format	Source/Value/Description
Dummy field		

[Top of Page](#)

End Statement Record (9999)

Field Name	Format	Source/Value/Description
Dummy field		

[Top of Page](#)

Address Sub-record

The address sub-record that in statement record (0100) is composed of the following:

Field Name	Format	Description
COUNTRY	A3	
ADDRESS1	A64	
ADDRESS2	A64	
ADDRESS3	A64	
ADDRESS4	A64	
CITY	A30	
NUM1	A6	
NUM2	A4	
HOUSE_TYPE	A2	
COUNTY	A30	
STATE	A6	
POSTAL	A12	
GEO_CODE	A11	
IN_CITY_LIMIT	A1	

Statement Construct Maintenance

The statement construct enables you to indicate the collection of accounts and/or service agreements whose financial details should be consolidated for a statement to a given person. The statement construct also contains routing information needed by the system to send the statement to the person in the preferred manner.

Lifecycle of a Statement Construct

The following diagram illustrates the lifecycle of a statement construct.

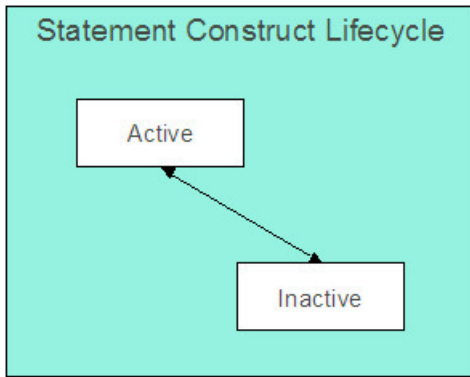

Active: The statement construct will be in this status while a person is actively receiving statements for the accounts and service agreements linked to this construct. A statement construct may transition from this status to inactive.

Inactive: The statement construct will be in this status when a person no longer wishes to receive statements for the accounts and service agreements linked to this construct. A statement construct may transition from this status back to active.

Statement Construct - Main

Open this page using **Menu > Customer Information > Statement Construct > Search.**

Description of Page

Statement Construct is a concatenation of summary information about this record. It is composed of the name of the statement person, the print description and the status.

Statement Construct ID is the unique system-generated identifier for this statement construct.

Person ID is the person who receives the future statements.

NOTE:

A person may be linked to many statement construct records.

Status indicates whether or not this person is currently receiving statements. The values are Active and Inactive.

FASTPATH:

Refer to [Lifecycle of a Statement Construct](#) for more information.

Address Source indicates where the source of the statement's address. The values are Person and Mailing Premise. If the value is person, the person's [mailing address](#) is used. If the value is mailing premise, indicate the **Mailing Premise** to use.

Statement Cycle controls when statements are produced for this statement construct. Refer to [Statement Cycle](#) for a description of how the production schedule is maintained.

Statement Route Type controls how the statement is routed to the **Person** (e.g., via email, postal service, EDI, etc.). Refer to [Statement Route Type](#) for more information on setting up statement route types.

Number of Copies indicates how many copies of the statement the person wishes to receive.

Statement Format indicates if the person receives a Detailed or a Summary statement.

NOTE:

The values for this field are customizable using the Lookup table. The values need to match the formats supported by your statement print software. This field name is STM_FORMAT_FLG.

Print Description is a brief description that can be printed on the statement.

The tree shows the statement construct's details. The nodes expand to show account, premise and service agreement information for the construct details.

NOTE:

Large statement constructs. The tree is hard to use if the statement construct has many details. In this situation, transfer to the adjacent tab page and use the filter to restrict the details that are shown.

Statement Construct - Details

This page is used to maintain the accounts and service agreements where financial transactions should appear on statements produced using this statement construct. Open this page using **Menu > Customer Information > Statement Construct > Search** and navigate to the **Details** page.

Description of Page

Statement Construct is a concatenation of summary information about this record. It is composed of the name of the statement person, the print description and the status.

Statement Construct ID is the unique system-generated identifier for this statement construct.

If a statement construct has a large number of details, you can use the **Details Filter** to limit the details that appear in the grid. The following options are available:

- All. Use this option to view all details linked to the statement construct.
- Person Name. Use this option to restrict details linked to accounts whose main customer has a primary name that matches an input **Name**.
- SAs at an Address. Use this option to only show details linked to service agreements that are linked to service points associated with a given **Address, City** and/or **Postal** code. Note, you can specify any combination of these fields.
- Statement Print Description. Use this option to restrict details to those with a given **Description**.

Don't forget to click the search button after changing the filter.

The grid contains the Accounts and/or Service Agreements whose financial information contributes to this statement construct. Each record in the grid contains the following information:

- **Construct Detail Type** defines if the construct detail is for an entire Account or a single Service Agreement. This field is protected if a statement detail was produced using this construct.
- **Service Agreement/Account** identifies the account (for Account construct details) or the service agreement (for Service Agreement) construct details. This field is protected if a statement detail was produced using this construct.
- **Statement Print Description** is available for use by the extract program to include on the printed statements to help the recipient identify the details.
- **Print Order** control where the financial transactions associated with the account / service agreement appear on the printed statement.
- **Start Date** is the date that this account / service agreement's financial transactions should begin appearing on statements.
- **End Date** is the date that this account / service agreement's financial transactions should stop appearing on statements.

NOTE:

Only financial transactions linked to bills whose BILL DATE is within the construct detail's **Start Date** and **End Dates** will appear on statements.

- **Construct Detail ID** is a system generated unique identifier of the construct detail.

Statement Maintenance

Statements allow you to set up a Person to receive a consolidated report of the financial activity for one or more accounts and/or service agreements. The topics in this section describe how to maintain statements.

NOTE:

The system creates most statements behind-the-scenes. Most statements are created by the system when it processes the statement cycle schedule. You should only have to access the statement pages to regenerate a statement or to add a statement real-time. For information about how the system creates statements, refer to [The Statement Creation Background Process](#).

Lifecycle of a Statement

The following diagram illustrates the lifecycle of a statement.

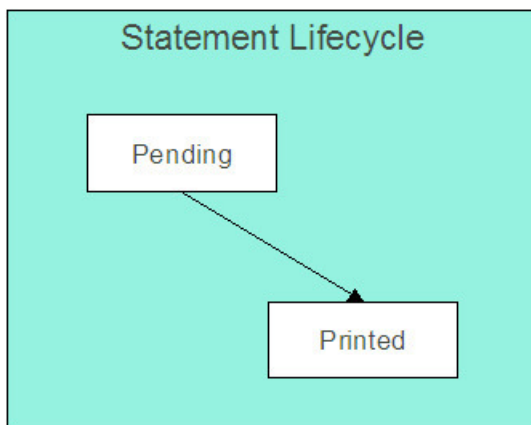

Pending: A statement is created in this state and will remain in this state until the statement details are extracted. When that occurs, it will transition to printed.

Printed: A statement transitions to this state after the details of a statement have been extracted.

Statement - Main

Open this page using **Menu > Financial > Statement > Search**.

NOTE:

Correcting erroneous statements. It's important to be aware that there are very few fields that are directly modifiable by a user. This is because a statement is a summary of financial transactions. If you need to change information on a

statement, you must change the source information (e.g., change the statement's construct or complete additional bills) and then regenerate the statement. Refer to [How To Regenerate A Statement](#) for more information.

Description of Page

Statement is a concatenation of summary information about this record. It is composed of the name of the statement person, the statement construct print description, the create date of the statement and the statement status.

Statement ID is the unique system-generated identifier for this statement.

Indicate the **Construct ID** for the statement construct whose construct details should be included in this statement.

Address is a display-only field that contains the address to which the statement will be sent.

The **Statement Status** indicates the current status of the statement. The values are Pending, Printed.

FASTPATH:

Refer to [Lifecycle of a Statement](#) for more information.

The **Create Date** indicates the date that this statement was created.

The **Batch Control** and **Batch Number** are the batch process and run in which the statement was (or will be) sent to the recipient.

FASTPATH:

Refer to [Printing Statements](#) and to [Statement Route Type](#) for more information.

The **Statement Action** area contains buttons that you use to generate, reprint or delete a statement.

- The **Generate** button enables you to create a statement on-line. Refer to [On-line Statement Production](#) for more information.
 - The **Reprint** button will stamp the latest run number for the statement's batch control. This will enable the statement to be reprinted the next time the batch control process executes. Refer to [How to Reprint A Specific Statement](#) for more information.
 - The **Delete** button will remove the statement and its details from the database. Refer to [How to Regenerate a Specific Statement](#) for more information.
 - The **Display** button will display an online image of the statement when pressed. Refer to [Online Statement Display](#) for more information.
-

NOTE:

You can only use the **Display** button if your system has been configured to display an on-line image; otherwise, a message indicating that the service is not available will appear. This option can only be configured by your technical staff. Refer to [Technical Implementation Of Online Statement Display](#) for more information.

The bottom portion of this page is dedicated to a [tree](#) that shows the statement details. The nodes expand to show every service agreement that will appear on the statement and the financial details that will be swept onto the statement for each service agreement. You may transfer to the details of any of the nodes by selecting that node. Context menus are also available for various nodes to facilitate easy navigation to other pages.

NOTE:

Large statements. The tree will be hard to use if the statement has many service agreements that contributed financial transactions to the statement. In this situation, transfer to the adjacent tab page and use the filter to restrict the service agreements that are shown.

Statement - Details

This page is used to view the service agreements that contributed financial transactions to the statement. Open this page using **Menu > Financial > Statement > Search** and navigate to the **Details** page.

Description of Page

Statement is a concatenation of summary information about the statement. It is composed of the name of the statement person, the statement construct print description, the create date of the statement and the statement status.

Statement ID is this statement's unique system-generated identifier.

If a statement has a large number of service agreements that contributed financial transactions to the statement, you can use the **SA Filter** to limit the service agreements that appear in the grid. The following options are available:

- **All**. Use this option to view all service agreements that contributed financial transactions to the statement.
- **Person Name**. Use this option to only show service agreement linked to accounts whose main customer has a primary name that matches **Person Name**.
- **SAs at an Address**. Use this option to only show service agreements that are linked to service points associated with a given **Address**, **City** and/or **Postal** code. Note, you can specify any combination of these fields.
- **Statement Print Description**. Use this option to only show service agreements associated with a construct detail with a given **Statement Print Description**.

Don't forget to click the search button after changing the filter.

The grid contains service agreements that contributed financial transactions to the statement. If a service agreement's financial transactions appeared on multiple bills, a separate line is displayed for each bill. You can press the go to button adjacent to **Bill Due Date** to be transferred to [Financial Transactions On A Bill](#) where the individual financial transactions associated with the associated service agreement and bill can be viewed. The following information is displayed in the grid:

- **Statement Print Description** is the description of the construct detail associated with the service agreement.
- **Bill's Due Date** is the date of the bill on which the service agreement's financial transactions appear. Press the adjacent go to button to be transferred to [Financial Transactions On A Bill](#) where the individual financial transactions can be viewed.
- **Premise Information** describes the characteristic premise, if any, associated with the service agreement.
- **SA Information** describes the service agreement that contributed financial transactions to the statement.
- **Account Information** describes the account associated with the service agreement whose details appear on the statement.
- **Construct Detail ID** is the unique identifier of the construct detail associated with the service agreement.
- **Statement Detail ID** is the unique identifier of the statement detail on which the service agreement's financial transactions appear.

Sales & Marketing

The sales and marketing functionality satisfies many diverse requirements. For example, you can use this functionality to:

- Enroll new customers using a single transaction (i.e., you don't have to use the person, premise, service point, and start/stop transactions to enroll a new customer who resides at a new premise).
- Sell new products to existing customers.

- Update person, account and premise information using a single transaction.
- Market your services to prospects from a marketing list (and measure the success of your efforts). If the customer responds to your sales efforts, the system will automatically setup the customer, premise and related service agreements.
- Setup marketing surveys and record your customers' responses.
- Quickly create one-time charges.
- Setup [proposals](#) for prospective services (and then send a quotation to the customer for these services).
- And more...

The topics in this section provide more information about the sales and marketing functions.

The Big Picture of Campaigns, Packages, and Orders

Three objects are at the heart of the sales and marketing functionality: **Campaigns**, **Packages**, and **Orders**.

- A **package** defines a basket of goods and services that can be offered to a customer or a prospect.
- A **campaign** is a structured effort to offer a given set of packages to existing customers or new prospects.
- An **order** is created for each customer / prospect to which a campaign is targeted.

The topics in this section provide background information about these objects.

An Overview of Campaigns, Packages and Orders

An order is used to define:

- Demographic information about a customer / prospect.
- Geographic information about the service address.
- The customer's response to eligibility-oriented questions. For example, you can pose questions like: Who is your current energy service provider? / Would you like to pay automatically? / What is your date of birth?

After the above information is defined, the [order transaction](#) presents packages that may be offered to the customer. A package controls the various types of service agreements that will be created if the customer selects the package.

NOTE:

The customer must be eligible for a package. When you setup a [package](#), you define its [eligibility criteria](#). For example, you can setup a package that is only applicable to commercial customers in Toronto who pay automatically and who commit to a one-year service contract.

If the customer elects to take a package, the order transaction sets up / updates the "V" (along with all of the ancillary things that happen when service is initiated, e.g., field activities are created). Please note that in addition to setting up the "V", it's also possible to populate / update other information when a package is selected. For example, you could have the system setup the customer's automatic payment options.

NOTE:

An order can be completed without creating service agreements. It is possible to use the order transaction to simply create / update persons and accounts. Refer to [Marketing Surveys](#) and [Setting up a New Customer Prior To Using Start/Stop](#) for more information.

All orders must reference a campaign. An order's [campaign](#) defines:

- How the campaign's orders use accounts and premises. For example, you can indicate that a given campaign is only targeted at existing premises (thus preventing the creation of a new premise when an order is completed).
- The type of information defaulted onto an order. For example, you can setup a campaign to default a given account management group on all orders linked to the campaign. This account management group will subsequently default onto the new account when the order is completed.
- The validation rules that control how its orders use accounts and premises. Specifically, on a campaign you define if an account / premise is required / optional / not allowed on its orders. In addition, if an account / premise is required or optional, you can control whether new accounts / premises can be created when an order is completed (the alternative is to force each order to use an existing account / premise). These controls prevent the unwanted proliferation of new accounts and premises for campaigns that are targeted at existing accounts and premises.
- The eligibility-oriented questions that are posed to the customer when an order is taken. For example, the questions indicated above - Who is your current energy service provider? / Would you like to pay automatically? / What is your date of birth? - are all defined on the order's campaign.
- The superset of packages that can be offered to a customer whose order references this campaign. An order's campaign defines the types of packages that may be selected.
- In addition to the above, campaigns also control high-level [eligibility rules](#) and [business process flows](#).

NOTE:

Bottom line. Campaigns allow you to define a group of **packages** that a customer is eligible to purchase. Every time a campaign is targeted at a customer, an **Order** is created. The information entered on the order qualifies the customer for one of the campaign's packages. If a customer elects to take a package, the "V" is setup / updated along with all of the ancillary things that happen when service is initiated, e.g., field activities are created, workflow processes are initiated, etc.

Supported Business Processes

Before providing examples of specific business processes, we'd like to highlight that you have control over some aspects of the user-interface flow (i.e., the screen navigation is not hard-coded). The following illustration highlights the potential user-interface flow:

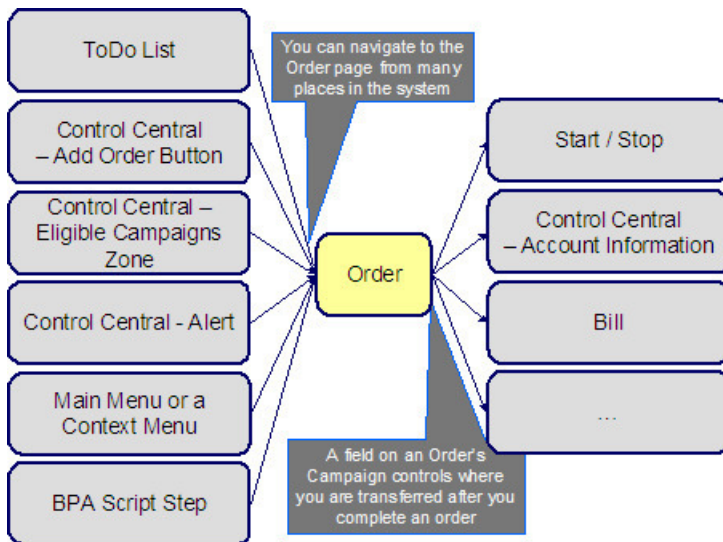

NOTE:

Bottom line. You can navigate to the order transaction from many places in the system. After you complete an order, you are transferred to an appropriate transaction. The specific transaction is controlled by you when you setup the order's campaign.

The topics that follow illustrate specific business process flows that are possible in your implementation of the sales and marketing functionality.

Marketing to Prospects from a Marketing List

The following business process flow illustrates how the sales and marketing functionality would be used to market to prospects uploaded from a marketing database.

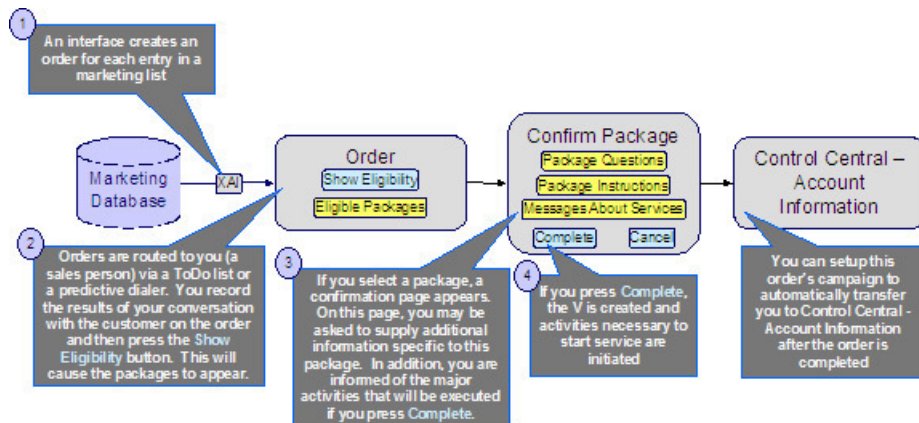

The following points describe the steps in this business process:

- An upload interface creates an [order](#) for each entry in a marketing database.

NOTE:

The system is not supplied with a dedicated interface to upload a marketing list.

- Each [order](#) is routed to a salesperson via a [To Do](#) entry (or via a predictive dialer if your company supports this type of technology).
- The first step in the salesperson's interaction with the prospect will be to confirm the information uploaded from the marketing list (e.g., is your Bob Smith?, is your address 15 Main St?, etc.). Any changes are made to the information saved on the order.
- The salesperson's next step involves posing eligibility-oriented questions related to the campaign. Examples of questions include:
 - **What is your date of birth?** This type of question might be asked if you have packages that are only marketed to senior citizens. Potential answers would be a valid date that's in the past.
 - **Would you be interested in our full-service option (electricity, digital cable and gas)?** Potential options are: yes and no.
 - **Who is your current electric service provider?** Potential answers are: Utility.Com, Reliant Resources, Other.
 - **Would you like to pay automatically?** Potential answers are: Yes, No.
 - **Would you like to pay using a levelized payment plan?** Potential answers are: Yes, No.
 - Etc.

- The gathered information is saved on the order and then the system displays the packages that can be offered to the customer. The available packages may be restricted based on information on the order. For example, some packages are only applicable to senior citizens, while others are only applicable to customers whose current service provider is Utility.com.
- If the customer is interested in a package, the salesperson selects it. Prior to the order being completed, the [package confirmation](#) page is shown. On this page are additional instructions about the package and a description of how the system will be updated if the package is selected (e.g., the types of service agreements will be displayed). In addition, the package may require additional information before it can be chosen. For example, the package may only be selectable if the customer agrees to pay automatically. In this situation, the package confirmation page will require the salesperson to enter the customer's bank and bank account.
- After entering all package-specific information, the order is completed. When the order is completed, the "V" is setup and all work necessary to satisfy the order is initiated (e.g., field activities are created, workflow processes are initiated, etc.).
- And finally, the user is returned to [Control Central - Account Info](#) where an overview of the customer is displayed. From this page, the user can drill down to any service agreement (or to start/stop) to perform any fine-tuning.
- Please be aware that the page to which you are transferred after order completion is controlled by a field on the order's [campaign](#). In our example, it made sense to transfer the user to Control Central as it provides a nice confirmation to the user (it shows a great deal of information about an account). However, you could setup the campaign to take the user to virtually any page in the system. You'll see good examples later in this discussion.

Marketing to Pre-Selected Customers

The following business process flow illustrates how the sales and marketing functionality would be used to market additional services to existing customers selected by a background process.

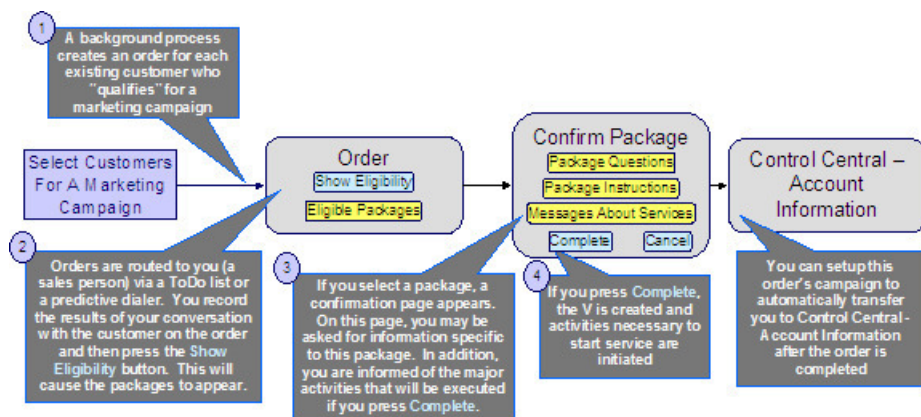

The following points describe the steps in this business process:

- A background process creates an [order](#) for each customer to be targeted under a marketing campaign.

NOTE:

The base package does not have an example of such a background process. Please speak to your support team if you require assistance in developing this type of process.

- Sales people would then process the order as described above.

Real-Time Marketing of Additional Services to a Customer

The following business process flow illustrates how the sales and marketing functionality would be used to market additional services to existing customers when they call in.

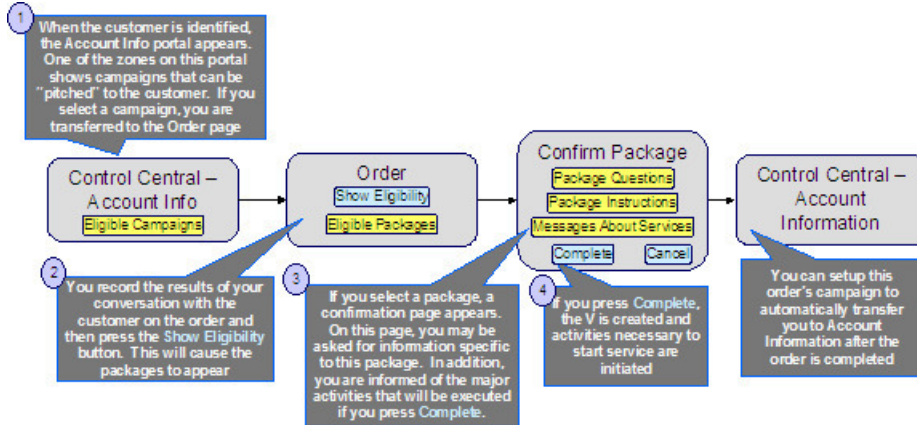

The following points describe the steps in this business process:

- When you find the customer's record on [Control Central - Main](#), you are automatically transferred to the [Account Information](#) portal. One of the zones on this page contains the campaigns that can be offered to the customer.

NOTE:

The "potential campaigns" zone only appears if the CSR has modified their preferences to display this zone.

- If you select a campaign from this zone, you are transferred to the [Order](#) transaction.

NOTE:

An order's campaign controls whether the [Main](#) or [Questions & Misc Fields](#) tab is initially displayed when the order transaction is invoked from this zone. For example, you might want to have the **Main** tab displayed if you want the order-taker to confirm the customer's demographic information before posing questions. Alternatively, you may want to skip this step and immediately present the order-taker with the campaign's questions. Keep in mind that the user can always display the other tab regardless of what is initially displayed.

- You then process the order as described above.

NOTE:

An easy way to create one-time charges. The above business process illustrates how the selection of a package will create one or more new service agreements for a customer. If your organization levies one-time charges (e.g., tree trimming charges, damage assessments, etc.), you can also use the order transaction to create both a "one-time charge" service agreement and create the related billable charge when the order is completed. To do this, setup a campaign with a separate package for each possible one-time charge. If an order is created for this type of campaign and the relevant package is selected, the system will setup the new billable charge service agreement and link the billable charge to it. Refer to [An Easier Way To Create One Time Charges](#) for an example of such a campaign.

Real-Time Marketing of Services to a Prospect

The following business process flow illustrates how the sales and marketing functionality would be used to market services when a new customer calls.

WARNING:

We do not recommend using this business process if your organization's service territory is predefined (i.e., if you've set up the premises and service points for your entire service territory). Why? Because it can result in the creation of new premises and / or service points and you probably don't want this to happen if you've already set everything up. While it is possible to disable the creation of new service points and premises by developing new plug-ins, we'd recommend using the business process described under [How To Add A New Customer From Control Central](#) if a new customer calls in and you have predefined premises and service points.

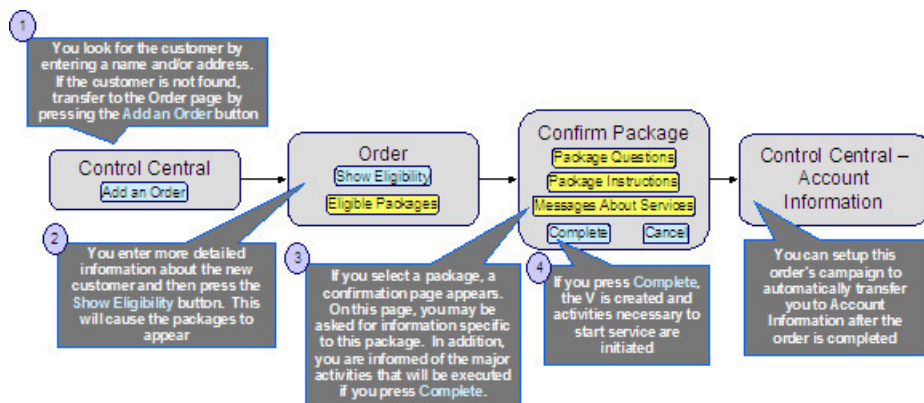

The following points describe the steps in this business process:

- You look for the customer using [Control Central - Main](#). Because the customer is new, you push the Add Order button on Control Central to transfer to the [Order](#) transaction.
- You then process the order as described above.

In order to take advantage of the above business process, it's important that you understand the following points:

- When the order page is opened for a new customer, the order's campaign is defaulted from the [installation record](#). The default campaign on the installation record is "generic" because we don't know anything about the customer (they are new) and therefore we cannot default a campaign targeted to their customer class or geography.
- This default campaign on the installation record must be constructed using one of the following approaches:
 - The default campaign has a package for every potential type of customer who can call up. While this is possible, it's probably not realistic as the data setup burden required to define every type of package could be onerous. However, if you have a limited number of service agreements, this approach is feasible.
 - The default campaign could just be a "dummy" campaign that has no packages. The "real" campaigns will only be shown after basic information about the customer has been recorded on the order and the "show eligibility" button is pressed. These campaigns appear in the order's [eligibility tree](#). The selection of a campaign in this tree will cause the order's campaign to be switched. Note, because the "dummy" campaign has no packages, no packages will appear in the order's eligibility tree when the dummy campaign is referenced on an order.
- The order is then processed as described above.

Setting up a New Customer Prior To Using Start/Stop

The following business process flow illustrates how the sales and marketing functionality would be used to create a new customer prior to using [Start/Stop](#) to start service at an existing premise.

NOTE:

The following business process is similar to that described under [How To Add A New Customer From Control Central](#). The only difference is that the **Order** transaction is used to create a new person and account rather than the **Person** transaction. The order transaction may be a better choice because it lets you define many attributes on person, account and premise that are not accessible on the person page. For example, the order transaction lets you define the customer's automatic payment option, bill after date, override due date, etc. In addition, on an order's campaign, you can define default values of many field values (both real fields and characteristics). These default values are presented on the order transaction and may be overridden by the user at will.

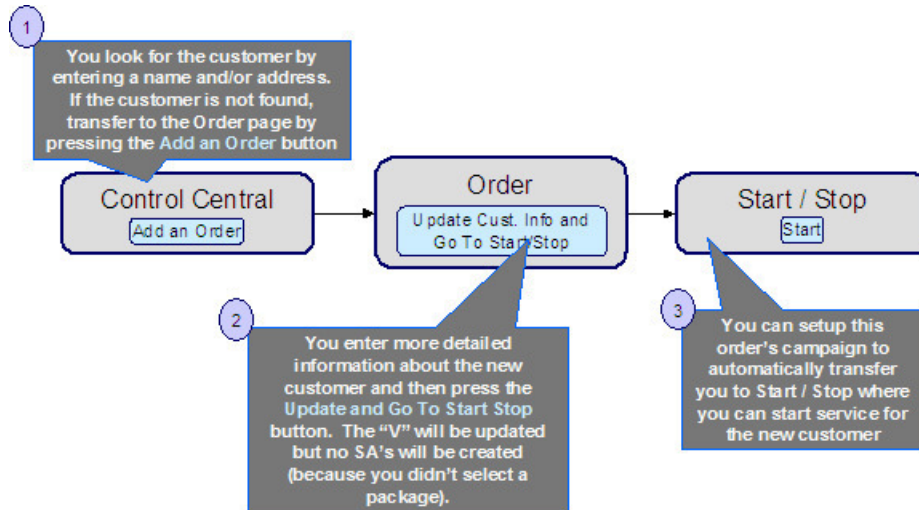

The following points describe the steps in this business process:

- You look for the customer using [Control Central - Main](#). Because the customer is new, you push the "Add Order" button on Control Central to transfer to the [Order](#) transaction.
- You record additional demographic and geographic information about the new customer and confirm all values defaulted from the order's campaign. After all required information is entered, you press the Update Cust. Info and Go To Start/Stop button to create the new person and account and transfer to [Start/Stop](#) to identify the new services desired by the customer.

NOTE:

The button's existence and label are dynamic. In the above example, we indicated that there is a button on the order page called **Update Cust. Info and Go To Start/Stop**. This button's presence on the page and its label are controlled by fields on the [campaign](#). When pressed, the "V" is updated with information on the order and the user is transferred to the "post completion" page (which is also defined on the campaign). You would only enable this button on campaigns whose orders can be completed without selecting a package. In the above example, the campaign doesn't have any packages (because service is intended to be started using Start/Stop). In [Examples of Campaigns and Packages](#) we show other examples of how these fields would be setup for different types of campaigns.

In order to take advantage of the above business process, it's important that you understand the following points:

- When the order page is opened as a result of pressing the Add Order button on [Control Central - Main](#), the order's campaign is defaulted from the [installation record](#). The default campaign on the installation record is "generic" because nothing is known about the new customer and therefore it is impossible to default a campaign targeted to their customer class or geography.
- The campaign on the installation record should be setup to contain default information for the "average" customer. For example, if you typically deal with residential customers, the information on the default campaign should be residential-oriented.

- When a user takes an order for a new customer, they'll change the default information when appropriate. For example, if an industrial customer were being added, they'd change the customer class to "industrial" and then ask to see the campaigns such a customer is eligible to choose (these alternate campaigns are displayed in the order's [eligibility tree](#)). For example, if you've setup campaigns with [eligibility rules](#) that are targeted at industrial customers and the customer class on the order has been changed to "industrial", the user will see these campaigns in the eligibility tree. The user can then change the campaign's order by simply clicking on the desired campaign.

NOTE:

The above example illustrates how an order can be completed without causing the creation of service agreements. Refer to [Marketing Surveys](#) and [Prelude to Start Stop](#) for examples of such campaigns.

Examples of Campaigns and Packages

The topics that follow provide examples of [campaigns](#) and [packages](#) that support several different scenarios. Your organization's campaigns and packages may differ markedly from these examples. Factors that will influence your sales and marketing objects include:

- Whether the type of goods and services marketed to your customers / prospects differs depending on some trait of the customer or the region in which they are located. For example,
 - Your company may have very straightforward packages that only differ based on whether the customer is industrial, residential or commercial. If this describes your company, the setup process will be simple.
 - Alternatively, your company might offer different packages to residential customers based on whether they pay automatically, whether the customer is a senior citizen, whether they purchase multiple services from you, etc. If this describes your company, then you'll have to define the various eligibility criteria and the respective packages applicable to customers who satisfy each criterion.
- Whether premises exist prior to order taking. For example, a company that distributes a commodity has a well-defined geographic area and therefore new premises typically don't arise when orders are taken.
- Whether your company offers many different types of goods and services.
- Whether your rates have charges / discounts that are only applied to some customers. For example, you might have discounts that are applied if the customer is a senior citizen or an employee.
- Which of the [Supported Business Processes](#) you implement.

Use the information that follows to form an intuitive understanding of campaigns and packages. After attaining this understanding, you'll be ready to design your own campaigns and packages.

Campaigns Without Packages

An order that references a campaign without packages will never create service agreements. The following topics describe scenarios when such a campaign would be used.

Marketing Surveys

Some organizations conduct "marketing surveys" to determine general trends amongst their customer base. The following diagram illustrates how such a campaign might look:

Campaign – Residential Survey

Default Info For New Customers / Premises

Not applicable

Questions To Be Posed On Orders

Question	Possible Answers
Electric or gas water heater?	Elec, Gas
How many low-flow toilets?	1 through 9
How many people are in your household?	1 through >12
How would you rate our service?	1 (bad), 2 (OK), 3 (great)
How many outages have you experienced in the last year?	0 through >12

Misc Fields To Be Captured

Not applicable

Campaign Eligibility Rules

Algorithm

Customer class is residential

Potential Packages

Not applicable

Campaign Behavior Controls

Enable button that allows order completion without package selection	Yes
Button Label	Complete Survey
Post completion transaction	Account Info

Note the following about this campaign:

- If the campaign is used to establish new customers, you can define information to default onto orders created for new customers. Because marketing surveys are targeted at existing customers, you don't need new customer default information on the campaign.
- You can define questions to be posed to customers when an order is taken when you setup a campaign. For a "marketing survey" campaign, you'd define each of the survey questions and the permissible answers. When a customer is surveyed, an order is created and their answers are saved on the order.
- On a campaign, you can define additional fields to be updated on persons, accounts and premises when orders associated with the campaign are completed. For example, you could indicate that the account's override due date and automatic payment options should be confirmed when an order is taken. Because marketing surveys are typically only asking questions, you wouldn't need to define additional customer information fields to be confirmed. However, you can if you want.
- All campaigns need at least one eligibility rule. These rules control whether the campaign appears in the "eligible campaigns" [content zone](#) when a customer is selected on Control Central. These rules also control whether the campaign appears on an order's [eligibility tree](#) (campaigns that appear in this tree are alternate campaigns that may be used on the order). Our example has assumed that this is a residential customer survey and therefore it only needs a single eligibility rule. Refer to [The Big Picture Of Campaign Eligibility Rules](#) for more information.
- Because this campaign is used purely to manage a marketing survey, it doesn't need any packages. Packages are only necessary if service agreements are created when an order is completed.

- Because this campaign doesn't have packages, we have indicated that the button that allows orders to be completed without selecting a package is enabled. If you don't enable this button, a user won't be able to complete a marketing survey (and it is only during order completion when the "V" is updated with the information on the order). Notice that we have assigned the button a label of Complete Survey.
- This campaign should be setup to transfer the user to [Control Central - Account Info](#) after the survey is completed.

Prelude to Start/Stop

Consider the example illustrated above under [Setting up a New Customer Prior To Start/Stop](#). In this example, the [order](#) transaction is used to create a new person and account; no service agreements are created when the order is completed. Rather, after the order is completed, the user is automatically transferred to [Start/Stop](#) where they can create service agreements. The following diagram illustrates how such a campaign might look:

Campaign – Add New Customer

Default Info For New Customers / Premises	
Field	Default Value
Customer Class	R
Account Management Group	RE SID

Questions To Be Posed On Orders

Not applicable

Misc Fields To Be Captured

Field	Required / Optional	Default Value
Auto-pay source	Optional	**
Auto-pay account	Optional	**
Date of birth	Optional	**

Campaign Eligibility Rules

Algorithm

This campaign is only used to create new customers

Potential Packages

Not applicable

Campaign Behavior Controls

Enable button that allows order completion without package selection	Yes
Button Label	Update the V / Go To Start
Post completion transaction	Start/Stop

Note the following about this campaign:

- Because this campaign is used to establish new customers, you should define new customer default information. The order taker can override these default values.
- If we assume you don't ask marketing / eligibility-oriented questions when you take-on a new customer then this campaign would not require any questions.

- On a campaign, you can define additional fields to be updated on the related person, account and premise when orders associated with the campaign are completed. For example, you could indicate that the account's override due date and automatic payment options should be confirmed when an order is taken. In our example, we are assuming that we want to define the customer's automatic payment options and his/her date of birth.
- As described under [Marketing Surveys](#), a campaign's eligibility rule(s) control whether the campaign appears in the "eligible campaigns" [content zone](#) and on an order's [eligibility tree](#). This campaign is odd in that we don't want it to ever appear as an "eligible campaign" because it's only used for NEW customers. In order to make this work you must:
 - Define an eligibility algorithm on this campaign that prevents it from appearing as an "eligible campaigns". Refer to [A Campaign That Is Never Eligible](#) for more information.
 - Update the [installation record](#) to indicate that this campaign is the one that should be used on orders created when a user presses the "Add an Order" button on [Control Central - Main](#). Refer to [Setting up a New Customer Prior To Starting Service](#) for more information about the flow of this business process.
- Because this campaign is used purely to add accounts and persons, it doesn't need any packages. Packages are only necessary if service agreements are created when an order is completed.
- Because this campaign doesn't have packages, we have indicated that the button that allows an order to be completed without selecting a package is enabled. If you don't enable this button, a user won't be able to complete the order (and it is only during order completion when the "V" is updated with the information on the order). Notice that we have assigned the button a label of Update The V and Go To Start.
- This campaign should be setup to transfer the user to [Start/Stop](#) after the order is completed.

Campaigns With Simple Packages

As explained under [Campaigns Without Packages](#), there are several situations that might necessitate a campaign without packages. In this section, we describe simple scenarios of campaigns with packages.

An Easier Way To Create One Time Charges

We use the term "one-time charge" to describe ad hoc charges, e.g., tree trimming charges, damage assessments, etc. The following points describe how one-time charges are levied if you don't use the order transaction:

- Determine if the customer to be invoiced already has an appropriate "one-time charge" service agreement. If one doesn't exist, you must create one using [Start/Stop Service](#).
- Next, a billable charge is added to the "one-time charge" service agreement (using [Billable Charge Maintenance](#)). The billable charge contains the invoice lines and amounts. The system will produce the bill for this charge when the account's bill cycle next executes.

Rather than going through the above multi-step process, you can also use the order transaction to create both a "one-time charge" service agreement AND create the billable charge. In addition, if the customer receiving the charge is new, the order transaction will also create a new person and account at the same time.

To take advantage of this facility, you must set up a campaign that has a separate package for each type of one-time charge as illustrated below. When an order is taken for such a campaign, the user simply selects the package that corresponds with the desired one-time charge. The system will then create the necessary customer and financial information when the package is confirmed.

NOTE:

Billing of one-time charges. The order transaction will not cause a bill to be generated for the customer. Rather, the next time the account is billed, the system will see that there's an unbilled billable charge and create a bill segment for it. This bill segment will appear on the customer's regular bill along with their other charges. If you'd prefer to create the bill for the one-time charges immediately, you could setup the campaign to automatically transfer the user to the

bill transaction where they can [create an ad hoc bill](#). If you do this, you'll need to create a new plug-in algorithm on the billable charge SA type to automatically activate the service agreement when it is created (otherwise the user would have to manually activate the billable charge service agreement before the bill can be generated).

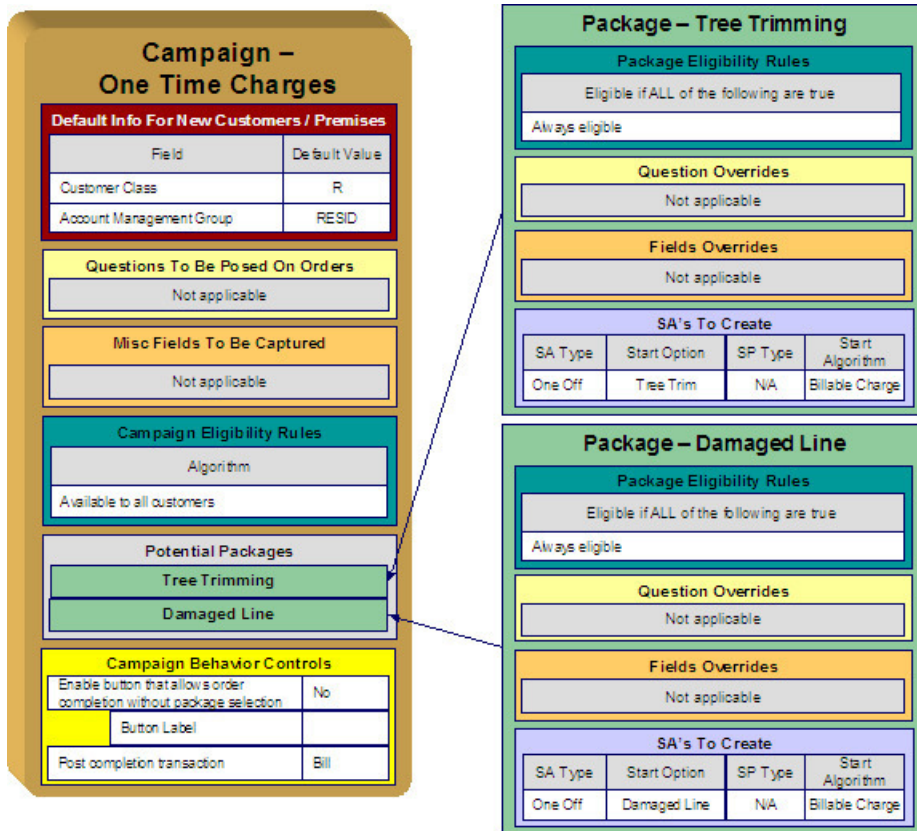

Note the following about this campaign:

- One-time charges can be levied against both new and existing customers. This means that orders associated with this campaign may cause new customers to be created. Therefore, we have specified information to default onto orders for new customers on the campaign. Note that we defined "residential-oriented" default values as the majority of one-time charges are levied against residential customers.
- If we assume you don't ask marketing / eligibility-oriented questions when you levy a one-time charge then this campaign would not require any questions.
- We have assumed that you are not capturing miscellaneous fields when you levy a one-time charge.
- As described under [Marketing Surveys](#), all campaigns need at least one eligibility rule. We have assumed that this campaign's packages can be selected by all types of customers and have therefore specified an eligibility algorithm that will be true for all customers.
- Because this campaign has packages, we have indicated that the button that allows an order to be completed without selecting a package is disabled. This means a user must choose one of the packages to complete the order.
- You might want to setup this campaign to automatically transfer the user to the bill transaction after the order is completed. See the note above the illustration for more information.
- We have assumed that this campaign can be used to levy two kinds of one-time charges - a tree trimming charge and a damaged line charge - and therefore this campaign requires two packages. Note the following about each package:
 - A package's eligibility rules control whether the package can be selected when an order is taken. With more sophisticated campaigns, you may have packages that are only applicable to certain types of customers. In our

example, we've assumed that these types of one-time charges can be levied against all customers and have therefore used "universal" eligibility criteria (i.e., there are no eligibility restrictions). Refer to [A Package That Is Always Eligible](#) for more information.

- On a package, it's possible to define additional questions to be posed if a package is selected. In our example, there are no additional questions to be posed for the one-time charge packages.
- On a package, it's possible to define additional fields to be captured if a package is selected. In our example, there are no additional fields to be captured.
- On a package, you define the types of service agreements to be created if a package is selected. In our example, we only need a single service agreement created / updated if the package is selected and therefore there's just one entry in **SAs To Create**. Please note the following about the information used to create this service agreement:
- The **SA Type** is one that's used for a [billable charge service agreement](#).
- The SA Type's **Start Option** is one that will automatically create a billable charge when a service agreement is created (if a [start option](#) references a [billable charge template](#), a billable charge will be created when this start option is used). In our example, we have assumed a different start option has been setup for each type of one-time charge.
- Billable charge service agreements do not require service points and therefore **SP Type** is not applicable.
- We've indicated a **Start Algorithm** of Billable Charge . Refer to STRM-AS for an example of such an algorithm (type).

Campaigns With Complex Packages

The [Campaigns With Simple Packages](#) illustrated campaigns with very simple packages. In this section, we describe a campaign with more complex packages.

Packages Limited By Answers And Field Values

Assume your organization has a campaign with several packages. Each package has the following restrictions in respect of its use:

- "Package 1" can be offered to residential customers in California who are senior citizens.
- "Package 2" can be offered to residential customers in California who live in single-family homes who are not senior citizens and who heat their homes with electricity.
- "Package 3" can be offered to residential customers in California who live in single-family homes who are not senior citizens and who heat their homes with gas.
- "Package 4" can be offered to residential customers in California who live in multi-family homes who are not senior citizens.

Also assume that all customers are encouraged to pay automatically.

The following diagram illustrates how such a campaign might look:

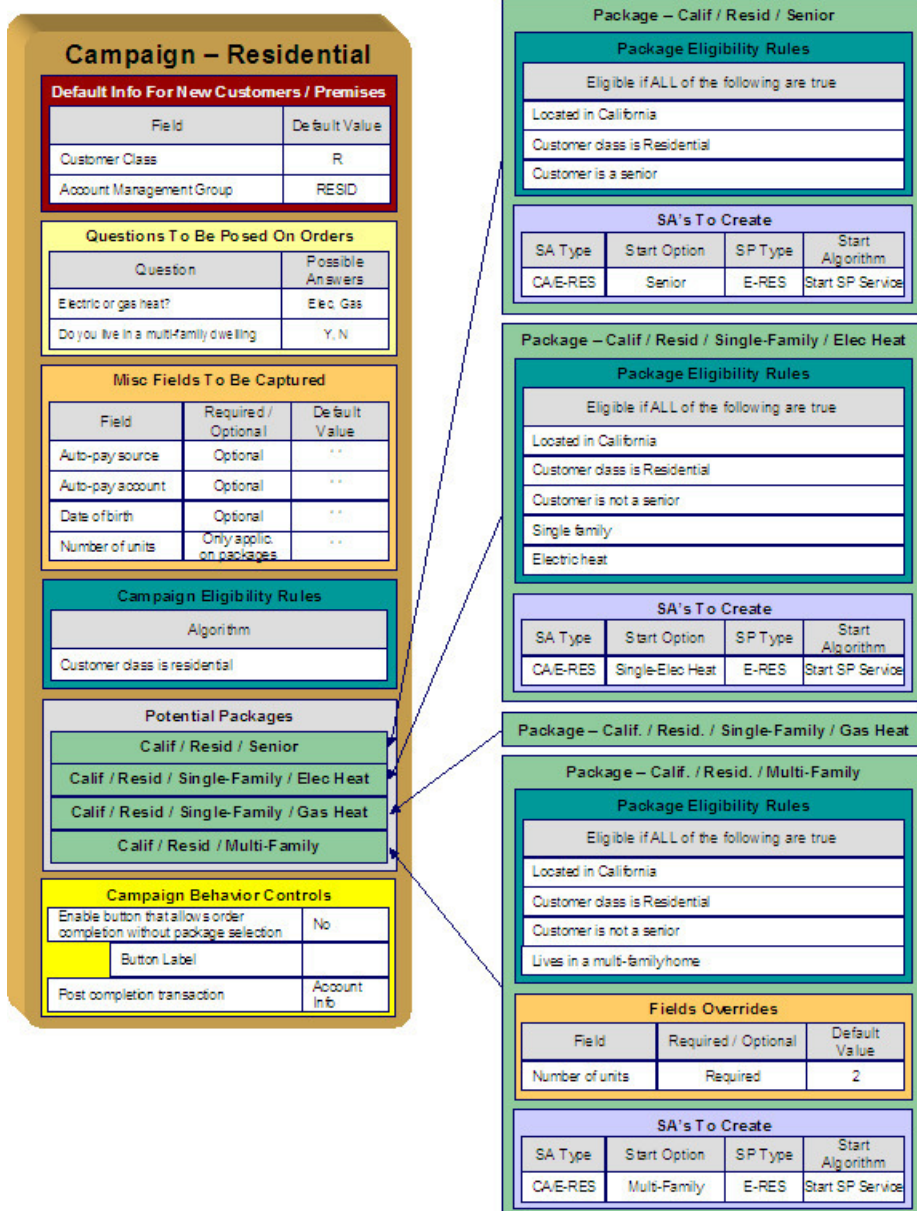

The topics that follow describe the campaign and packages used to support this scenario. We'll start by explaining each package. Then we'll describe how the campaign will be setup. This seems backwards, but it mirrors how you should design this type of campaign:

- [Senior Citizen Package](#)
- [Single-Family Electric Package](#)
- [Single-Family Gas Package](#)
- [Multi-Family Package](#)
- [The Campaign](#)

Senior Citizen Package

The package that is offered to residential customers in California who are senior citizens has the following traits:

- It has eligibility rules that restrict its use to customers who meet the following criteria:

- Customer class = Residential
- Division = California
- Birth date equates to that of a senior citizen
- We only need a single service agreement created if the package is selected and therefore there's just one entry in SAs To Create. Please note the following about the information used to create this service agreement:
 - The **SA Type** is one that's used for an electric residential service agreement (hence the E-RES SA type).
 - The SA Type's **Start Option** is one that will automatically setup the service agreement with the appropriate rate and contract options for a senior citizen.
 - The service agreement needs to be linked to an electric residential service point (hence the E-RES SP type).
 - We've indicated a Start Algorithm of Start SP Service. Refer to STRM-VT for an example of such an algorithm (type).
- We have not shown additional questions or miscellaneous fields in this package. This is because this package doesn't have additional questions or additional fields.

[Top of the Page](#)

Single-Family Electric Package

The package that is offered to residential customers in California who live in single-family homes who are not senior citizens and who heat their homes with electricity has the following traits:

- It has eligibility rules that restrict its use to customers who meet the following criteria:
 - Customer class = Residential
 - Division = California
 - Birth date does not equate to that of a senior citizen
 - The premise is a single-family home
 - The premise is heated with electricity
- We only need a single service agreement created if the package is selected and therefore there's just one entry in SAs To Create. Please note the following about the information used to create this service agreement:
 - The **SA Type** is one that's used for an electric residential service agreement (hence the E-RES SA type).
 - The SA Type's **Start Option** is one that will automatically setup the service agreement with the appropriate rate and contract options for this type of customer.
 - The service agreement needs to be linked to an electric residential service point (hence the E-RES SP type).
 - We've indicated a Start Algorithm of Start SP Service. Refer to STRM-VT for an example of such an algorithm (type).
- We have not shown additional questions or miscellaneous fields in this package. This is because this package doesn't have additional questions or additional fields.

[Top of the Page](#)

Single-Family Gas Package

The package that is offered to residential customers in California who live in single-family homes who are not senior citizens and who heat their homes with gas has the following traits:

- It has eligibility rules that restrict its use to customers who meet the following criteria:
 - Customer class = Residential
 - Division = California

- Birth date does not equate to that of a senior citizen
- The premise is a single-family home
- The premise is heated with gas
- We only need a single service agreement created if the package is selected and therefore there's just one entry in SAs To Create. Please note the following about the information used to create this service agreement:
 - The **SA Type** is one that's used for a gas residential service agreement (hence the G-RES SA type).
 - The SA Type's **Start Option** is one that will automatically setup the service agreement with the appropriate rate and contract options for this type of customer.
 - The service agreement needs to be linked to a gas residential service point (hence the G-RES SP type).
 - We've indicated a Start Algorithm of Start SP Service. Refer to STRM-VT for an example of such an algorithm (type).
- We have not shown additional questions or miscellaneous fields in this package. This is because this package doesn't have additional questions or additional fields.

[Top of the Page](#)

Multi-Family Package

The package that is offered to residential customers in California who live in multi-family homes who are not senior citizens has the following traits:

- It has eligibility rules that restrict its use to customers who meet the following criteria:
 - Customer class = Residential
 - Division = California
 - Birth date does not equates to that of a senior citizen
 - The premise is a multi-family home
- This package requires additional information that was not requested at the campaign-level. We're going to assume that the multi-family rate needs to know the number of units in the building. This means that this package needs an additional field (number of units).
- We only need a single service agreement created if the package is selected and therefore there's just one entry in SAs To Create. Please note the following about the information used to create this service agreement:
 - The **SA Type** is one that's used for an electric residential service agreement (hence the E-RES SA type).
 - The SA Type's **Start Option** is one that will automatically setup the service agreement with the appropriate rate and contract options for this type of customer.
 - The service agreement needs to be linked to an electric residential service point (hence the E-RES SP type).
 - We've indicated a Start Algorithm of Start SP Service. Refer to STRM-VT for an example of such an algorithm (type).
- We have not shown additional questions in this package. This is because this package doesn't have additional questions.

[Top of the Page](#)

The Campaign

Note the following about this campaign:

- Orders can be created for both new and existing customers. Because new customers are possible, we have specified information to default onto orders for new customers. Note that we defined "residential-oriented" default values (but remember, these values can be overridden on the order).

- The questions on the campaign are those whose answers play a part in each package's eligibility. You could also ask additional [marketing survey-oriented](#) questions that have nothing to do with package eligibility.
- The miscellaneous fields highlight an interesting situation. Notice that the date-of-birth and "automatic payment" fields are optional. However the field that holds the number of dwelling units is "only applicable on packages". When a field has this designation, the user will only be prompted to supply this field's value if a package is chosen where this field is applicable. In our example, only the Multi Family Package uses this field. This package will be setup to indicate that this field is required whereas the other packages will be setup to indicate that this field is not used.

NOTE:

Bottom line. The "miscellaneous fields" on a campaign must also include package-specific fields.

- All campaigns need at least one "highlight rule". These rules control whether the campaign appears in the "eligible campaigns" [content zone](#) when a customer is selected on Control Central. Also note that "highlight rules" also control whether the campaign appears on an order's eligibility tree (campaigns that appear in this tree are alternate campaigns that may be used on the order).
- We're going to assume that this is a residential campaign and therefore you would specify a highlight rule that returns true if the customer's customer class is residential.
- Because this campaign has packages, we have indicated that the button that allows an order to be completed without selecting a package is disabled. This means a user must choose one of the packages to complete the order.
- This campaign is setup so that the user will be transferred to [Control Central - Account Info](#) after the order is completed. This is a subjective decision as you could transfer the user to a variety of transactions. It's just that the Account Info page provides a nice confirmation of how the customer looks after the order has updated / created new information.

Packages Limited By Current State Of Service

Assume your organization has a campaign with several packages. Each package has the following restrictions in respect of its use:

- "Package 1" can be offered to residential customers in California who have gas service, but don't have electric service.
- "Package 2" can be offered to residential customers in California who have electric service, but don't have gas service.
- "Package 3" can be offered to residential customers in California who have neither electric nor gas service.

The following diagram illustrates how such a campaign might look:

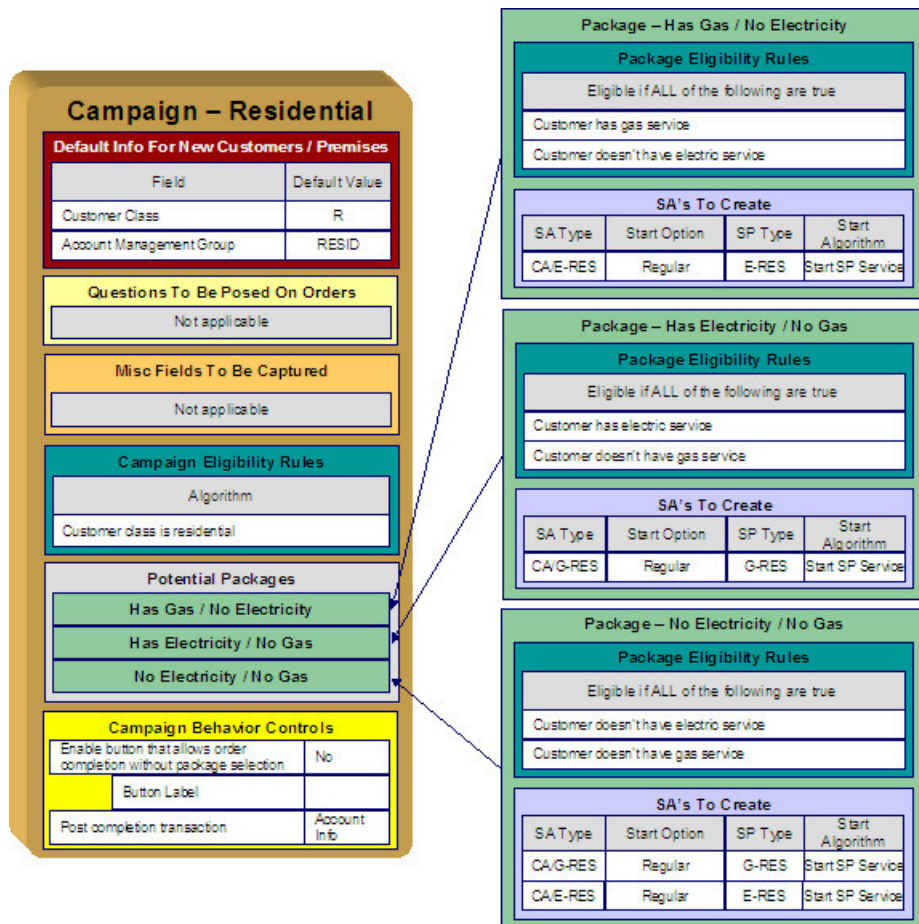

The topics that follow describe the campaign and packages used to support this scenario. We'll start by explaining each package. Then we'll describe how the campaign will be setup. This seems backwards, but it mirrors how you should design this type of campaign:

- [Has Gas / No Electricity Package](#)
- [Has Electricity / No Gas Package](#)
- [No Electricity / No Gas Package](#)

Has Gas / No Electricity Package

The package that is offered to customers that currently have gas service, but don't have electricity service has the following traits:

- It has eligibility rules that restrict its use to customers who meet the following criteria:
 - Customer has gas service
 - Customer doesn't have electricity service
- Refer to [A Package With Service Type Comparisons](#) for more information.
- We only need a single service agreement created if the package is selected and therefore there's just one entry in SAs To Create. Please note the following about the information used to create this service agreement:
 - The **SA Type** is one that's used for an electric residential service agreement (hence the E-RES SA type).
 - The SA Type's **Start Option** is one that will setup the service agreement with the appropriate rate and contract options.
 - The service agreement needs to be linked to an electric residential service point (hence the E-RES SP type).

- We've indicated a Start Algorithm of Start SP Service. Refer to STRM-VT for an example of such an algorithm (type).
- We have not shown additional questions or miscellaneous fields in this package. This is because this package doesn't have additional questions or additional fields.

[Top](#)

Has Electricity / No Gas Package

The package that is offered to customers that currently have electric service, but don't have gas service has the following traits:

- It has eligibility rules that restrict its use to customers who meet the following criteria:
 - Customer has electric service
 - Customer doesn't have gas service
- We only need a single service agreement created if the package is selected and therefore there's just one entry in SAs To Create. Please note the following about the information used to create this service agreement:
 - The **SA Type** is one that's used for a gas residential service agreement (hence the G-RES SA type).
 - The SA Type's **Start Option** is one that will setup the service agreement with the appropriate rate and contract options.
 - The service agreement needs to be linked to a gas residential service point (hence the G-RES SP type).
 - We've indicated a Start Algorithm of Start SP Service. Refer to STRM-VT for an example of such an algorithm (type).
- We have not shown additional questions or miscellaneous fields in this package. This is because this package doesn't have additional questions or additional fields.

[Top](#)

No Electricity / No Gas Package

The package that is offered to customers that don't currently have electricity or gas service has the following traits:

- It has eligibility rules that restrict its use to customers who meet the following criteria:
 - Customer doesn't have electric service
 - Customer doesn't have gas service
- We need two service agreements created (one for electricity, one for gas).
- We have not shown additional questions or miscellaneous fields in this package. This is because this package doesn't have additional questions or additional fields.

The Big Picture Of Package Eligibility Rules

The packages described under [Examples of Campaigns and Packages](#) have a variety of eligibility rules. Designing these rules can be easy or time-consuming; it all depends on the complexity of your business rules. We'll walk you through several examples to help you form an intuitive understanding of how to setup eligibility rules. Once you've acquired this intuition you'll be ready to design the eligibility rules for your own packages.

NOTE:

Don't confuse package eligibility rules with those associated with a campaign. Package eligibility rules control whether a customer is allowed to choose a package on the order transaction. Campaign eligibility rules control whether a campaign is highlighted on the "eligible campaigns" [content zone](#) and on an order's [eligibility tree](#).

Criteria Groups versus Eligibility Criteria

Before we provide concrete examples of eligibility criteria, we need to explain two concepts: Criteria Groups and Eligibility Criteria. A package's criteria groups control whether a customer is eligible to choose a package. At a high level, it works like this:

- A criteria group has one or more eligibility criteria. A group's criteria control whether the group is considered TRUE or FALSE for a given customer.
- When you create a group, you define what should happen if the group is TRUE or FALSE. You have the following choices:
 - The customer is eligible to choose the package
 - The customer is not eligible to choose the package
 - The next group should be checked.

We'll use the following example to help illustrate these points. Assume a package exists that can only be selected if:

- The customer resides in California and their current retail supplier is company A, B or C
- OR, the customer resides in Nevada and their current retail supplier is company X, Y or A

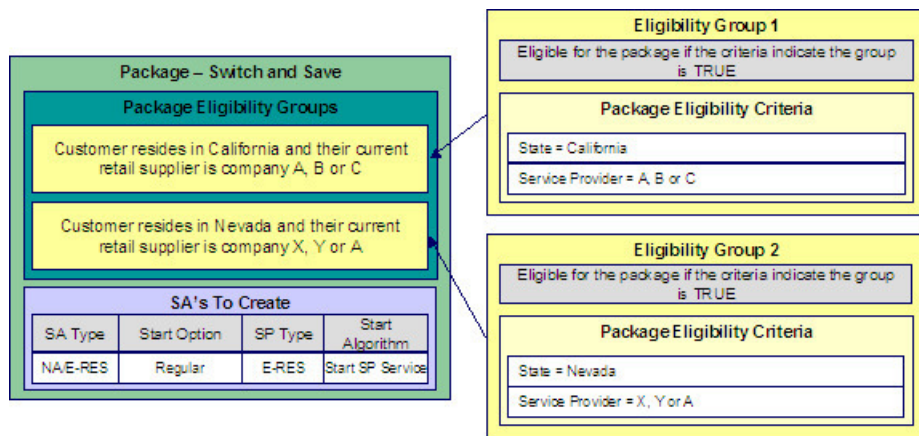

This package requires two eligibility groups because it has two distinct conditions:

- IF (STATE = CALIFORNIA AND (SERVICE PROVIDER IN (A, B, C)))
- IF (STATE = NEVADA AND (SERVICE PROVIDER IN (X, Y, A)))

If either condition is true, then the customer is eligible for the package.

You'd need to setup the following criteria groups in order to support this requirement:

Group No.	Group Description	If Group is TRUE	If Group is FALSE
1	Customer resides in California and their current retail supplier is company A, B or C	Eligible	Check next group

2	Customer resides in Nevada and their current retail supplier is company X, Y or A	Eligible	Ineligible
---	---	----------	------------

The following criteria will be required for each of the above groups:

Group 1: Customer resides in California and their current retail supplier is company A, B or C

Seq	Logical Criteria	If Eligibility Criteria is TRUE	If Eligibility Criteria is FALSE	If Insufficient Data
10	State = California	Check next condition	Group is false	Group is false
20	Electric retail supplier in (A, B, C)	Group is true	Group is false	Group is false

Group 2: Customer resides in Nevada and their current retail supplier is company X, Y or A

Seq	Logical Criteria	If Eligibility Criteria is TRUE	If Eligibility Criteria is FALSE	If Insufficient Data
10	State = Nevada	Check next condition	Group is false	Group is false
20	Electric retail supplier in (X, Y, A)	Group is true	Group is false	Group is false

The next section describes how you'd setup the specific logical criteria in each of the groups.

Defining Logical Criteria

When you setup an eligibility criterion, you must define two things:

- The field to be compared
- The comparison method

You have the following choices in respect of identifying the **field to be compared**:

- You can choose one of the miscellaneous fields on the order (keep in mind that miscellaneous fields also hold the answers to any questions posed on the order).
- You can execute an algorithm to retrieve a field value from someplace else in the system. This is a very powerful feature, but it's not terribly intuitive. We'll present a few examples later in this section to illustrate the power of this approach.

You have the following choices in respect of identifying the **comparison method**:

- You can choose an operator (e.g., >, <, =, BETWEEN, IN, etc.) and a comparison value.
- You can execute an algorithm whose job it will be to perform the comparison (and return TRUE, FALSE or INSUFFICIENT DATA). This is also a very powerful feature, but it's not terribly intuitive. We'll present a few examples later in this section to illustrate the power of this approach.

The [Examples Of Package Eligibility Rules](#) provide numerous examples to help you understand this design.

Examples Of Package Eligibility Rules

The topics in this section provide examples about how to setup package eligibility rules.

A Package That Is Always Eligible

If a package is always eligible, it still needs an eligibility group. Good examples of such packages are shown under [An Easier Way To Create One Time Charges](#). A package that is always eligible would require the following eligibility information:

Group No.	Group Description	If Group is TRUE	If Group is FALSE
1	Always eligible	Eligible	Eligible

The following criteria will be required for this group:

Group 1: Always eligible

Seq	Field to Compare	Comparison Method	If TRUE	If FALSE	If Insufficient Data
10	Algorithm: retrieve order's account	Algorithm: Always true	Group is true	Group is true	Group is true

This group's criterion is odd in that it's not comparing anything. In order to setup this criterion, you have to use the following "trick":

- **Field to Compare.** You can pick any miscellaneous field on the campaign. If the campaign has no miscellaneous fields, you'll need to setup an algorithm to retrieve a field from the order (refer to PKEL-ENRFLD for an example of this type of algorithm). In the above example, we used an algorithm to retrieve the order's account.
- **Comparison Method.** We chose a comparison algorithm that always returns a value of TRUE (refer to PKCC-DEFAULT for an example of this type of algorithm).
- You'll notice that if a value of TRUE is returned, the Group is true (and we've setup the group to indicate a true group means the customer is eligible for the package).

We understand this is a little complicated, but this design provides the power necessary to support very complex criteria. The following sections provide more examples to help you form a better understanding of these concepts.

A Package With A Time Span Comparison

The Senior Citizen Package has the following eligibility rules:

- Customer class = Residential
- Division = California
- Birth date equates to that of a senior citizen

These rules require only one eligibility group on the package. It would look as follows:

Group No.	Group Description	If Group is TRUE	If Group is FALSE
1	Residential, Calif, Senior	Eligible	Ineligible

The following criteria will be required for this group:

Group 1: Residential, Calif, Senior

Seq	Field to Compare	Comparison Method	If TRUE	If FALSE	If Insufficient Data
10	Algorithm: retrieve order's customer class	= R	Check next condition	Group is false	Group is false
20	Algorithm: retrieve order's division	= CA	Check next condition	Group is false	Group is false
30	Misc Field On Order: Date of Birth	Algorithm: True if senior	Group is true	Group is false	Group is false

The first two criteria are easy; they simply retrieve a field on the order and compare it to a given value. If the comparison doesn't result in a TRUE value, the Group is false (and, the group indicates that if the group is false, the customer isn't eligible for the package). If the comparison results in a TRUE value, the next condition is checked.

The last criterion contains a time span comparison. Time span comparisons are used to compare a date to something. In our example, we have to determine the age of the customer based on their birth date. If the resultant age is > 65, they are considered to be a senior citizen. To pull this off, you can take advantage of a comparison algorithm supplied with the base package as described below.

- Field to Compare. The miscellaneous field in which the customer's birth date is held is selected.
- Comparison Method. We chose a comparison algorithm that returns a value of TRUE if the related field value (the customer's date of birth) is greater than 65 years (refer to PKCC-TIMESPN for an example of this type of algorithm).

You'll notice that if a value of TRUE is returned by the True if senior algorithm, the group is true (and we've setup the group to indicate a true group means the customer is eligible).

NOTE:

The time span algorithm can be used to compare days, weeks, months, etc. Refer to PKCC-TIMESPN for more information about this algorithm.

A Package With Service Type Comparison

The Has Gas / No Electricity Package has the following eligibility rules:

- Customer has gas service
- Customer doesn't have electricity service

These rules require only one eligibility group on the package. It would look as follows:

Group No.	Group Description	If Group is TRUE	If Group is FALSE
1	Has Gas, Doesn't Have Electricity	Eligible	Ineligible

The following criteria will be required for this group:

Group 1: Has Gas, Doesn't Have Electricity					
Seq	Field to Compare	Comparison Method	If TRUE	If FALSE	If Insufficient Data
10	Algorithm: check if customer has gas service	= TRUE	Check next condition	Group is false	Group is false

20	Algorithm: check if customer has electric service	= TRUE	Group is false	Group is true	Group is false
----	---	--------	----------------	---------------	----------------

Both criteria are similar - they check if the customer has a given type of service and act accordingly. We used a "field to compare" algorithm to pull this off, but this algorithm is a bit counter intuitive (but understanding it will provide you with another way to implement complex eligibility criteria):

- **Field to Compare.** We chose a "field to compare" algorithm that checks if an account has service agreements that belong to a given set of service types. It returns a value of TRUE if the customer has an active service agreement that matches one of the service types in the algorithm. In our example, the "check if customer has gas service" algorithm returns a value of TRUE if the customer has at least one active service agreement whose SA type references the gas service type. The "check if customer has electric service" algorithm is almost identical, only the service type differs. Refer to PKEL-SVCTYP for an example of this type of algorithm.
- **Comparison Method.** We simply compare the value returned by the algorithm to TRUE and indicate the appropriate response.

NOTE:

Bottom line. The "field to compare" algorithm isn't actually returning a specific field's value. Rather, it's returning a value of TRUE or FALSE (this is not a misspelling). This value is, in turn, compared by the "comparison method" and the group is set to true, false or check next accordingly.

A Package With More Complex Operators

One of the eligibility groups described under [Criteria Groups versus Eligibility Criteria](#) has the following eligibility rules:

- Customer must live in California
- Service provider is A, B or C

The eligibility group in which these rules would be defined looks as follows:

Group No.	Group Description	If Group is TRUE	If Group is FALSE
1	Lives in California, current service provider is either retailer A, B or C	Eligible	Ineligible

The following criteria will be required for this group:

Group 1: Lives in California, current service provider is either retailer A, B or C					
Seq	Field to Compare	Comparison Method	If TRUE	If FALSE	If Insufficient Data
10	Algorithm: retrieve order's state	= CA	Check next condition	Group is false	Group is false
20	Misc Field On Order: Current electric supplier	IN A, B, C	Group is true	Group is false	Group is false

This example is very simple. The only thing worth pointing out is that a number of operators can be used when you define a "comparison method". Refer to [Package - Eligibility](#) for the complete list of operators.

The Big Picture Of Campaign Eligibility Rules

In the previous section, we explained how to [Design Eligibility Rules For A Package](#). In this section, we explain how to design eligibility rules for a campaign.

A campaign's eligibility rules control two things:

- Whether the campaign appears in the Eligible Campaigns [content zone](#). This content zone suggests possible campaigns for the current customer displayed on control central. You might want to use this zone if you have different campaigns that are offered to different types of customers. Refer to [Real-time Marketing of Additional Services to a Customer](#) for an example of how this content zone can be used to "up sell" additional services.
- Whether the campaign appears on an order's [eligibility tree](#). Campaigns that appear in this tree are alternate campaigns that may be used on the order. Refer to [Real-time Marketing of Services to a Prospect](#) for an example of how an order's eligibility tree can contain alternate campaigns for an order.

Designing these criteria can be easy or time-consuming; it all depends on the complexity of your business rules. We'll walk you through several examples to help you form an intuitive understanding of how to setup campaign eligibility rules. Once you've acquired this intuition you'll be ready to design the eligibility rules for your own packages.

NOTE:

Don't confuse eligibility rules for a package with those associated with a campaign. Package eligibility rules control whether a customer is allowed to choose a package. Campaign eligibility rules control whether a campaign is highlighted on the Eligible Campaigns [content zone](#) and on an order's [eligibility tree](#).

Campaign Eligibility Rules Are Not Strictly Enforced

While the system prevents ineligible packages from being selected for an order (based on the [package's eligibility rules](#)), the system does not strictly enforce a campaign's eligibility rules. In other words, a user can change the campaign on an order to any active campaign. This "laxness" is intentional; otherwise it could become impossible to change an order's campaign.

It might be more helpful to think of campaign eligibility rules as "highlight conditions". These "highlight conditions" simply control whether the campaign appears in the Eligible Campaigns [content zone](#) and on an order's [eligibility tree](#).

Campaign Eligibility Rules Are Defined Using Algorithms

You define a campaign's eligibility rules using one or more algorithms on the [campaign](#). These algorithms are relatively straightforward as they simply return one of the following values:

- Eligible. Meaning the customer is eligible for the campaign.
- Ineligible. Meaning the customer is not eligible for the campaign
- Check Next Algorithm. Meaning that the next algorithm should be checked. You'd only design an algorithm to return such a value if multiple algorithms are used to determine a customer's eligibility for a campaign.

NOTE:

Bottom line. A customer is eligible for a campaign if at least one of its eligibility algorithms returns a value of "eligible".

The [Examples Of Campaign Eligibility Rules](#) provide numerous examples to help you understand this design.

Examples Of Campaign Eligibility Rules

The topics in this section provide examples about how to setup campaign eligibility rules.

A Campaign That Is Always Eligible

If a campaign is always eligible, it would require a simple eligibility algorithm that returns an indication that it is always eligible. A good example of such a campaign is shown under [An Easier Way To Create One Time Charges](#). Refer to CAEL-DEFAULT for an example of this type of eligibility algorithm.

A Campaign That Is Never Eligible

If a campaign is never eligible, it would require a simple eligibility algorithm that returns an indication that it is ineligible. A good example of such a campaign is shown under [Prelude To Start/Stop](#). Refer to CAEL-DEFAULT for an example of this type of eligibility algorithm.

A Campaign For Residential Customers

If a campaign should only be targeted at residential customers, it would require a simple eligibility algorithm that returns an indication of eligible if the customer's customer class is residential. A good example of such a campaign is shown under [Marketing Surveys](#). Refer to CAEL-CC for an example of this type of eligibility algorithm.

A Campaign For California, Residential Customers

If a campaign should only be targeted at residential customers in California, it would require two eligibility algorithms:

Algorithm No	Algorithm	Example Algorithm
1	Indicate Check Next Algorithm if customer class is "residential"	Refer to CAEL-CC for an example of this type of eligibility algorithm.
2	Indicate Eligible if division is "California"	Refer to CAEL-DIV for an example of this type of eligibility algorithm.

Designing Campaigns and Packages

Designing [campaigns](#) and [packages](#) can be simple or challenging. Factors that will influence the complexity of the design process include:

- Whether the type of goods and services marketed to your customers / prospects differs depending on some trait of the customer or the region in which they are located. For example,

- Your company may have very straightforward packages that only differ based on whether the customer is industrial, residential or commercial. If this describes your company, the setup process will be simple.
- Alternatively, your company might offer different packages to residential customers based on whether they pay automatically, whether they are a senior citizen, whether they purchase multiple services from you, etc. If this describes your company, then you'll have to define the various eligibility criteria and the respective packages applicable to customers who satisfy each criterion.
- Whether premises exist prior to order taking. For example, a company that distributes a commodity has a well-defined geographic area and therefore new premises typically don't arise when orders are taken.
- Whether your company offers many different types of goods and services.
- Whether your rates have charges / discounts that are only applied to some customers. For example, you might have discounts that are applied if the customer is a senior citizen or an employee.
- Which of the [Supported Business Processes](#) you implement.

The topics in this section provide a structured approach to design your campaigns and packages.

Determine The Place Of Start/Stop

Before you can design your campaigns and packages, you must determine if your organization will use [start / stop](#) to initiate new service agreements or whether new service can be initiated using the [order](#) transaction. Refer to [Order versus Start / Stop](#) for information to help you make this decision.

If you decide to use [start / stop](#) to initiate service, we'd recommend creating the following types of campaigns:

- Create a campaign similar to that described under [Prelude to Start / Stop](#).
- If you levy one-time charges, you may also want to create a campaign similar to that described under [An Easier Way To Create One Time Charges](#).
- If your organization performs marketing surveys, you may also want to create a campaign similar to that described under [Marketing Surveys](#).

If you decide to use the [order](#) transaction to initiate new service, follow the steps outlined in the following sections. Note that we use the example described under [Packages Limited By Answers And Field Values](#) when describing the design process.

Determine Which Types Of Service Agreements Are Created

WARNING:

We have assumed that you have already designed your organization's SP types, SA types, start options and rates. If you have not yet done this, we recommend familiarizing yourself with the concepts described in [Designing SP Types](#), [Rates](#) and [Defining Service Agreement Types](#) before designing your campaigns and packages.

Start off by determining the different types of service agreements that can be created if a package is selected. In our [example campaign](#), only one SA type is used - E-RES (electric residential service).

Determine The Different Start Options That Exist For Each Type Of Service Agreement

After you know which SA types are going to be created, determine the potential [start options](#) that can be used for each SA type. In our [example campaign](#), several start options are possible for the E-RES (electric residential service):

SA Type	Start Option
E-RES	Senior
E-RES	Single-Elec Heat
E-RES	Single-Gas Heat
E-RES	Multi-Family

Determine The SP Type (if any) For Each Service Agreement

The SA types and start options control how the service agreement will look (i.e., they control the rate, contract riders, characteristics, interval profiles, time-of-use maps, etc. defaulted onto new service agreements created when a package is selected). During this step, you define the SP type of the service point that will be linked to the service agreement. If several different types of SP types can be used for a service agreement, you'll have to choose one as this is the type of service point that will be created when the service agreement is created. If you plan to allow the package to be used to start service at an existing premise (and you don't want the system to create new service points), you will have to develop new plug-ins. Please speak to your implementation group if you need more information.

In our [example campaign](#), only one SP type is created (or reused if the premise already has a service point of this type) - E-RES (electric residential service point):

SA Type	Start Option	SP Type
E-RES	Senior	E-RES
E-RES	Single-Elec Heat	E-RES
E-RES	Single-Gas Heat	E-RES
E-RES	Multi-Family	E-RES

NOTE:

Many service agreements don't need SP types. For service agreements that don't use service points (e.g., deposit service agreements, charitable contributions, one-time charges, etc.), you don't have to reference a SP type.

Determine The Method Used To Create Each Service Agreement

For each SA Type / Start Option / SP Type combination, determine the algorithm that will be used to create the service agreement and the service point. The base package is supplied with a limited number of such algorithm types (refer to STRM-AS and STRM-VT for examples).

SA Type	Start Option	SP Type	Start Method
E-RES	Senior	E-RES	Algorithm: Create new service agreement and stop old service agreement if active SA with the same service type exists
E-RES	Single-Elec Heat	E-RES	Algorithm: Create new service agreement and stop old service

E-RES	Single-Gas Heat	E-RES	agreement if active SA with the same service type exists
E-RES	Multi-Family	E-RES	Algorithm: Create new service agreement and stop old service agreement if active SA with the same service type exists

Extract Algorithms From The Start Method

The start methods illustrated above all require the same algorithm:

Algorithm Type	Algorithm	Parameter Values
Create SP and create SA (see STRM-VT)	Always create new SA and stop existing SA	2 (stop existing service)

Determine Which Combinations Can Be Grouped Under A Package

Now you determine which combinations of service agreements can be offered to a customer as a package. In our [example campaign](#), a customer can only choose one type of service agreement (i.e., each entry in our table is mutually exclusive). This means that each entry is a separate package:

Package	SA Type	Start Option	SP Type	Algorithm
1	E-RES	Senior	E-RES	STRM-VT (Switch Option)
2	E-RES	Single-Elec Heat	E-RES	STRM-VT (Switch Option)
3	E-RES	Single-Gas Heat	E-RES	STRM-VT (Switch Option)
4	E-RES	Multi-Family	E-RES	STRM-VT (Switch Option)

FASTPATH:

Refer to [Packages Limited By Current State Of Service](#) for an example of a package that has multiple service agreements.

Determine Package Eligibility Rules

The topics in this section describe the eligibility rules for each package in our [example campaign](#).

NOTE:

Assumption. This section assumes you are comfortable with the information in [The Big Picture Of Package Eligibility](#).

Eligibility Rules For Package 1

Package 1 (the senior package) in our [example campaign](#) has the following eligibility rules:

- Customer class = Residential
- Division = California
- Birth date equates to that of a senior citizen

These rules require only one eligibility group on the package. It would look as follows:

Group No.	Group Description	If Group is TRUE	If Group is FALSE
1	Residential, Calif, Senior	Eligible	Ineligible

The following criteria will be required for this group:

Group 1: Residential, Calif, Senior					
Seq	Field to Compare	Comparison Method	If TRUE	If FALSE	If Insufficient Data
10	Algorithm: retrieve order's customer class	= R	Check next condition	Group is false	Group is false
20	Algorithm: retrieve order's division	= CA	Check next condition	Group is false	Group is false
30	Misc Field On Order: Date of Birth	Algorithm: True if senior	Group is true	Group is false	Group is false

Eligibility Rules For Package 2

Package 2 (the single-family / electric heat package) in our [example campaign](#) has the following eligibility rules:

- Customer class = Residential
- Division = California
- Birth date does not equate to that of a senior citizen
- Lives in a single-family home
- House is heated with electricity

These rules require only one eligibility group on the package. It would look as follows:

Group No.	Group Description	If Group is TRUE	If Group is FALSE
1	Residential, Calif, Non Senior, Single Family, Electric Heat	Eligible	Ineligible

The following criteria will be required for this group:

Group 1: Residential, Calif, Non Senior, Single Family, Electric Heat

Seq	Field to Compare	Comparison Method	If TRUE	If FALSE	If Insufficient Data
10	Algorithm: retrieve order's customer class	= R	Check next condition	Group is false	Group is false
20	Algorithm: retrieve order's division	= CA	Check next condition	Group is false	Group is false
30	Misc Field On Order: Date of Birth	Algorithm: True if senior	Group is false	Check next condition	Group is false
40	Misc Field On Order: Type of Residence	= S (single family home)	Check next condition	Group is false	Group is false
50	Misc Field On Order: Type of Heat	= E (electric)	Group is true	Group is false	Group is false

Eligibility Rules For Package 3

Package 3 (the single-family / gas heat package) in our [example campaign](#) has the following eligibility rules:

- Customer class = Residential
- Division = California
- Birth date does not equate to that of a senior citizen
- Lives in a single-family home
- House is heated with gas

These rules require only one eligibility group on the package. It would look as follows:

Group No.	Group Description	If Group is TRUE	If Group is FALSE
1	Residential, Calif, Non Senior, Single Family, Gas Heat	Eligible	Ineligible

The following criteria will be required for this group:

Group 1: Residential, Calif, Non Senior, Single Family, Gas Heat

Seq	Field to Compare	Comparison Method	If TRUE	If FALSE	If Insufficient Data
10	Algorithm: retrieve order's customer class	= R	Check next condition	Group is false	Group is false
20	Algorithm: retrieve order's division	= CA	Check next condition	Group is false	Group is false
30	Misc Field On Order: Date of Birth	Algorithm: True if senior	Group is false	Check next condition	Group is false
40	Misc Field On Order: Type of Residence	= S (single family home)	Check next condition	Group is false	Group is false

50	Misc Field On Order: Type of Heat	= G (gas)	Group is true	Group is false	Group is false
----	--------------------------------------	-----------	---------------	----------------	----------------

Eligibility Rules For Package 4

Package 4 (the multi-family package) in our [example campaign](#) has the following eligibility rules:

- Customer class = Residential
- Division = California
- Birth date does not equate to that of a senior citizen
- Lives in a multi-family home

These rules require only one eligibility group on the package. It would look as follows:

Group No.	Group Description	If Group is TRUE	If Group is FALSE
1	Residential, Calif, Non Senior, Multi Family	Eligible	Ineligible

The following criteria will be required for this group:

Group 1: Residential, Calif, Non Senior, Single Family, Gas Heat					
Seq	Field to Compare	Comparison Method	If TRUE	If FALSE	If Insufficient Data
10	Algorithm: retrieve order's customer class	= R	Check next condition	Group is false	Group is false
20	Algorithm: retrieve order's division	= CA	Check next condition	Group is false	Group is false
30	Misc Field On Order: Date of Birth	Algorithm: True if senior	Group is false	Check next condition	Group is false
40	Misc Field On Order: Type of Residence	= M (multi family home)	Group is true	Group is false	Group is false

Extract Algorithms From The Eligibility Rules

The eligibility rules illustrated above require the following algorithms:

Algorithm Type	Algorithm	Parameter Values
Retrieve a field from the order for eligibility comparison (see PKEL-ENRFLD)	Retrieve Order's Customer Class	Field name: CUST_CL_CD
Retrieve a field from the order for eligibility comparison (see PKEL-ENRFLD)	Retrieve Order's Division	Field name: CIS_DIVISION
Time span comparison (see PKCC-TIMESPN)	Determine if birth date equates to that of a senior	Time span type: YEAR Operator: >=

Extract Miscellaneous Fields From The Eligibility Rules

During this step, you extract miscellaneous fields that must be captured on the order in order drive your eligibility rules.

Misc. Field	Where Stored	Why Is It Needed
Date of birth	Person characteristic	Numerous eligibility rules use this field to determine if a customer is a senior citizen
Type of Residence	Premise characteristic	Numerous eligibility rules use this field to qualify a customer for a package
Type of Heat	Premise characteristic	Numerous eligibility rules use this field to qualify a customer for a package

NOTE:

Fields explicitly referenced on every order. You'll notice that we didn't list those fields referenced in the eligibility rules that are explicitly referenced on every order (e.g., customer class, state, division, etc.). This is because these types of fields come "for free".

Determine Additional Information That Is Required If A Package Is Selected

During this step, you determine if there's any information that needs to be created when a package is selected that can't be defaulted from its start option. In our [example campaign](#), package 4 (the Multi-Family Home package), also needs to know the number of housing units at the premise (this information is probably needed to calculate a specific charge in the rate). None of the other packages require additional information. The extra field has been appended to our miscellaneous field table.

Misc. Field	Where Stored	Why Is It Needed
Date of birth	Person characteristic	Numerous eligibility rules use this field to determine if a customer is a senior citizen
Type of Residence	Premise characteristic	Numerous eligibility rules use this field to qualify a customer for a package
Type of Heat	Premise characteristic	Numerous eligibility rules use this field to qualify a customer for a package
Number of Units in House	Premise characteristic	The electric SA created by package 4 requires the number of units when it calculates the ongoing bill segments

Determine If There Are Additional Questions / Fields For Your Packages

Our [example campaign](#) indicates that all customers are encouraged to pay automatically. In order to pay automatically several fields are required (Start Date, End Date, Autopay Source (i.e., bank / credit card), Account Number, Account Name, Expiration Date). These fields are not "explicitly referenced" on the order and therefore must be captured as miscellaneous fields. We have appended these fields to our list of miscellaneous fields:

Misc. Field	Where Stored	Why Is It Needed
Date of birth	Person characteristic	Numerous eligibility rules use this field to determine if a customer is a senior citizen
Type of Residence	Premise characteristic	Numerous eligibility rules use this field to qualify a customer for a package
Type of Heat	Premise characteristic	Numerous eligibility rules use this field to qualify a customer for a package
Number of Units in House	Premise characteristic	The electric SA created by package 4 requires the number of units when it calculates the ongoing bill segments
Auto Pay Start Date	Account / Autopay Start Date Column	Used if a customer pays automatically
Auto Pay End Date	Account / Autopay End Date Column	Used if a customer pays automatically
Auto Pay Source	Account / Autopay Source	Used if a customer pays automatically
Auto Pay Account Number	Account / Autopay Account ID	Used if a customer pays automatically
Auto Pay Account Name	Account / Autopay Account Name	Used if a customer pays automatically
Auto Pay Account Expiration Date	Account / Autopay Account Expiration Date	Used if a customer pays automatically

We're going to assume that we don't capture any additional marketing-oriented questions. If we did, we'd need additional fields to hold the response to each question.

Determine If Additional Instructions Should Be Shown

If a package is selected, you can present additional instructions to the user informing them of special tasks they should perform (or special instructions they should give to the customer). For example, you could instruct the user to inform customers who aren't senior citizens that they should call back if they become seniors as they may qualify for a better rate. These instructions can be defined on each package.

For the sake of brevity, we will assume no additional instructions are necessary when a package is selected.

Determine If There Are Campaign-Level Fields / Questions

Next, you determine if there are additional fields that need to be captured regardless of the package that's selected. For example, you may want to capture additional demographic or geographic information for marketing purposes.

While our [example campaign](#) has no such requirement, for illustration purposes we'll assume you ask the customer to rate the quality of service they have experienced (assuming they are a current customer). This additional question requires another entry in our list of miscellaneous fields.

Misc. Field	Where Stored	Why Is It Needed
Date of birth	Person characteristic	Numerous eligibility rules use this field to determine if a customer is a senior citizen

Type of Residence	Premise characteristic	Numerous eligibility rules use this field to qualify a customer for a package
Type of Heat	Premise characteristic	Numerous eligibility rules use this field to qualify a customer for a package
Number of Units in House	Premise characteristic	The electric SA created by package 4 requires the number of units when it calculates the ongoing bill segments
Auto Pay Start Date	Account / Autopay Start Date Column	Used if a customer pays automatically
Auto Pay End Date	Account / Autopay End Date Column	Used if a customer pays automatically
Auto Pay Source	Account / Autopay Source	Used if a customer pays automatically
Auto Pay Account Number	Account / Autopay Account ID	Used if a customer pays automatically
Auto Pay Account Name	Account / Autopay Account Name	Used if a customer pays automatically
Auto Pay Account Expiration Date	Account / Autopay Account Expiration Date	Used if a customer pays automatically
Service Rating	Person characteristic	Campaign level marketing question

Determine The Properties Of Every Miscellaneous Field

At this point, you have amalgamated all miscellaneous fields required for the campaign and its packages. Now you have to define the following for each field:

- Prompt On Order. This is the prompt that will prefix the field when the [order](#) is taken. The following table provides examples.
- Campaign Applicability. This controls whether the field is optional, required, or only applicable on package(s).
 - A value of required means the order taker must enter a valid value before packages are displayed for selection.
 - A value of optional means the order taker can leave the field blank prior to package selection. You can make an optional field required on individual packages. For example, you would probably make **Date of birth** required on the Senior package.
 - A value of only applicable on packages is used for fields that are only captured for specific packages. Fields of this type are suppressed prior to package selection. When you setup a package, you indicate if the field is applicable (if so, the user is only prompted for the field if the package is selected).
- Type Of Response. This controls where the field is stored when the order is completed and how it is validated. You have two options: characteristic or column.
 - If a field is a Characteristic, you must define which entity the characteristic value is to be stored on when the order is completed (Person, Account, Premise or Order). You must also define the **Characteristic Type** as this controls the characteristic value entered by the user.
 - If a field's value resides in a column (as opposed to a characteristic value), you must define the [column reference](#). A field's column reference controls three things:
 - How the field's value is retrieved. A field's value is retrieved when an existing person / account / premise is referenced on an order.
 - How the field's value is validated. A field's value is validated before package eligibility is determined and before the order is completed.
 - How the field's value is posted (i.e., updated on the database). A field's value is posted when an order is completed.

FASTPATH:

Refer to [Extract Column References From Miscellaneous Fields](#) for more information about column references.

- **Default Value On Order.** This controls whether the order taker is supplied with a default value when an order is created. Note well: for optional and only applicable on package fields, you can specify a different default value on each package.

Misc. Field	Prompt On Order	Campaign Applicability	Type Of Response	Default Value On Order
Date of birth	What is your date of birth (used to qualify for senior discount)?	Optional	Characteristic Entity: Person Char Type: Date of birth	
Type of Residence	What type of residence do you live in?	Required	Characteristic Entity: Premise Char Type: Type of residence	S (single family)
Type of Heat	How do you heat your home?	Required	Characteristic Entity: Premise Char Type: Type of heat	E (electric)
Number of Units in House	How many units are in the entire house?	Only applicable on package(s)	Characteristic Entity: Premise Char Type: Number of units in house	
Auto Pay Start Date	What day would you like to start automatic payment processing (YYYY-MM-DD)?	Optional	Column Column Reference: Auto Pay Start Date	
Auto Pay End Date	What day would you like to stop automatic payment processing (leave blank if not applicable)?	Optional	Column Column Reference: Auto Pay End Date	
Auto Pay Source	From what type of credit card / bank will the funds be debited?	Optional	Column Column Reference: Auto Pay Source	
Auto Pay Account Number	What is your credit card / bank account number?	Optional	Column Column Reference: Auto Pay Account Number	
Auto Pay Account Name	What is the name on your account?	Optional	Column Column Reference: Auto Pay Account Name	
Auto Pay Account Expiration Date	If paying with a credit card, what is the expiration date (MM-YYYY)?	Optional	Column Column Reference: Auto Pay Credit Card Expiration Date	
Service Rating	Please rate our service	Optional	Characteristic Entity: Person	1 (excellent)

Extract Characteristic From The Miscellaneous Fields

Characteristic Type	Type	Valid Values	Entities On Which Characteristic Can Be Defined
Date of birth	Ad hoc value: use validation algorithm to confirm date is > 1-Jan-1900 and < 31-Feb-2002	Not applicable	Person, Order
Type of Residence	Predefined value	S: Single-Family M: Multi-Family	Premise, Order
Type of Heat	Predefined value	E: Electric G: Gas	Premise, Order
Number of Units in House	Ad hoc value: use validation algorithm to confirm value is > 0	Not applicable	Premise, Order
Service Rating	Predefined value	0: Not applicable 1: Excellent 2: Very Good 3: Good 4: Poor	Person, Order

Extract Column References From The Miscellaneous Fields

The [miscellaneous fields](#) illustrated above require the following column references (we describe the referenced algorithms at the bottom of the table):

Column Reference	Retrieval Algorithm	Validation Algorithm	Post Algorithm	Foreign Key Reference
Auto Pay Start Date	Retrieve account's current automatic payment information	Validate automatic payment information	Post automatic payment information	
Auto Pay End Date	N/A - this field is handled by the Retrieval Algorithm on Auto Pay Start Date	N/A - this field is handled by the Validation Algorithm on Auto Pay Start Date	N/A - this field is handled by the Post Algorithm on Auto Pay Start Date	
Auto Pay Source	N/A - this field is handled by the Retrieval Algorithm on Auto Pay Start Date	N/A - this field is handled by the Validation Algorithm on Auto Pay Start Date	N/A - this field is handled by the Post Algorithm on Auto Pay Start Date	Auto pay source
Auto Pay Account Number	N/A - this field is handled by the Retrieval Algorithm on Auto Pay Start Date	N/A - this field is handled by the Validation Algorithm on Auto Pay Start Date	N/A - this field is handled by the Post Algorithm on Auto Pay Start Date	

Auto Pay Account Name	N/A - this field is handled by the Retrieval Algorithm on Auto Pay Start Date	N/A - this field is handled by the Validation Algorithm on Auto Pay Start Date	N/A - this field is handled by the Post Algorithm on Auto Pay Start Date
Auto Pay Expiration Date	N/A - this field is handled by the Retrieval Algorithm on Auto Pay Start Date	N/A - this field is handled by the Validation Algorithm on Auto Pay Start Date	N/A - this field is handled by the Post Algorithm on Auto Pay Start Date

There are three types of algorithms referenced in the above table:

- **Retrieval algorithm.** A column's retrieval algorithm retrieves the column's current value from the database. You'll notice that only one of our columns uses a retrieval algorithm. This is because we've used a sophisticated example of a group of columns that are retrieved at the same time. When you have such a group of columns, nominate one of the columns to do the retrieval work and specify the retrieval algorithm on it.
- **Validation algorithm.** A column's validation algorithm validates the column's value prior to the database being updated. You'll notice that only one of our columns uses a validation algorithm. This is because we've used a sophisticated example of a group of columns that are validated as a group. When you have such a group of columns, nominate one of the columns to do the validation work and specify the validation algorithm on it.
- **Post algorithm.** A column's post algorithm updates the column's value on the database when the order is completed. You'll notice that only one of our columns uses a post algorithm. This is because we've used a sophisticated example of a group of columns that are posted together. When you have such a group of columns, nominate one of the columns to do the posting work and specify the posting algorithm on it.

Notice that we have indicated that one of the columns has a "foreign key reference". You declare a "foreign key reference" if the valid values for a column are defined on another table in the system (this also affects the order user interface as a dropdown appears for columns that have foreign key references). In our example, Auto Pay Source is the only column whose valid values are defined on the automatic payment source control table.

Extract Algorithms From The Column References

The column references illustrated above require the following algorithms:

Algorithm Type	Algorithm	Parameter Values
Retrieve automatic payment information from an account (see CRRT-AP)	Retrieve automatic payment information from an account	Param 1 = Auto Pay Start Date Column Reference Param 2 = Auto Pay End Date Column Reference Param 3 = Auto Pay Source Column Reference Param 4 = Auto Pay External Account Id Column Reference Param 5 = Auto Pay Expiration Date Column Reference Param 6 = Auto Pay Name Column Reference
Validate automatic payment information (see CRVL-AP)	Validate automatic payment information	Param 1 = Auto Pay Start Date Column Reference Param 2 = Auto Pay End Date Column Reference

Param 3 = Auto Pay Source Column Reference
 Param 4 = Auto Pay External Account Id Column Reference
 Param 5 = Auto Pay Expiration Date Column Reference
 Param 6 = Auto Pay Name Column Reference

Post automatic payment information (see CRPS-AP)

Post automatic payment information

Param 1 = Auto Pay Start Date Column Reference

Param 2 = Auto Pay End Date Column Reference

Param 3 = Auto Pay Source Column Reference

Param 4 = Auto Pay External Account Id Column Reference

Param 5 = Auto Pay Expiration Date Column Reference

Param 6 = Auto Pay Name Column Reference

Determine Account / Premise Dependency For Each Column Reference

Later in the design process (see [Determine How The Campaign Behaves](#)), you define on the campaign whether an account (and premise) is required, optional or not allowed on its orders. Your selection impacts how you setup column references. This is a little complicated so let's use an example:

- Assume you've setup a campaign to indicate a premise can optionally be defined on its orders.
- If the order-taker doesn't define a premise on an order, any premise-oriented questions and miscellaneous fields (Q&MF) should be suppressed on the order.
- It's easy for the system to know which Q&MFs to suppress when a Q&MF's response is held in a characteristic (because you must define on the campaign if the response will reside in an account, premise, person or order characteristic). For column reference Q&MFs, the system doesn't know if the response is account-oriented, premise-oriented or neither because algorithms handle the validation / updating of the response.
- Therefore, when you use column references on a campaigns Q&MFs, you must define if the responses are account-oriented or premise-oriented (so that the system can suppress the Q&MF when the user doesn't enter an account or premise on the order).

The following table contains the column references defined above as well as their dependency

Column Reference	Question Dependency
Auto Pay Start Date	Must have account
Auto Pay End Date	Must have account
Auto Pay Source	Must have account
Auto Pay Account Number	Must have account
Auto Pay Account Name	Must have account

You'll notice that each column reference is account-oriented (this is because automatic payment fields are stored on the respective account).

Determine If Any Properties Are Overridden On Any Package

At this point, you have defined the properties of all miscellaneous fields at the campaign level. You now need to determine if any of your packages need to override any of these properties. In general, you can only override miscellaneous fields whose campaign applicability is optional or only applicable on package(s).

Our [example campaign](#) has only two overrides:

Package 1 requires the following miscellaneous field overrides:

Misc. Field	Override Prompt (seen if a package is selected)	Override Package Applicability	Override Default Value
Date of birth	Not overridden	Required	Not overridden

Package 4 requires the following miscellaneous field overrides:

Misc. Field	Override Prompt (seen if a package is selected)	Override Package Applicability	Override Default Value
Number of Units in House	Not overridden	Required	2

WARNING:

If you override field properties on a campaign's packages, you will not be able to change the properties of the field at the campaign level.

Determine The Eligibility Rules For The Campaign

NOTE:

Assumption. This section assumes you are comfortable with the information in [The Big Picture Of Campaign Eligibility](#).

The easiest way to determine a campaign's eligibility is to examine each package's eligibility criteria and abstract common eligibility restrictions onto the campaign. It's important to remember that campaign-level eligibility is only used to highlight if the campaign MAY contain applicable packages; campaign-level eligibility is not strictly enforced.

The packages on our [example campaign](#) are all targeted at residential customers in California. Therefore we'll take advantage of two base package algorithms to construct the campaign's eligibility criteria.

Algorithm Type	Algorithm	Parameter Values
Check if account's customer class is in a predefined list (see CAEL-CC)	If customer class is "residential", check next algorithm	If customer's customer class is in list: 30 (check next) If customer's customer class is not in list: 20 (ineligible)

List of customer classes: R

Check if account's division is in a predefined list (see CAEL-DIV)

If division is "California", customer is eligible

If customer's CIS division is in list: 10 (eligible)

If customer's CIS division is not in list: 20 (ineligible)

List of customer classes: CA

Determine How The Campaign Behaves

The final step before you're ready to setup the campaign involves defining a variety of behavioral functions as described below:

- You need to define how the campaign uses accounts and premises. Specifically, on a campaign you define if an account / premise is required / optional / not allowed on its orders. In addition, if an account / premise is required or optional, you can control whether new accounts / premises can be created when an order is completed (the alternative is to force each order to use an existing account / premise). These controls prevent the unwanted proliferation of new accounts and premises for campaigns that are targeted at existing accounts and premises.
- Many fields on an order (e.g., phone type, customer class, division, account management group) can be defaulted on orders created for new customers. You will see these fields on [Order - Main](#). Think about each such field and whether a default value is appropriate. Keep in mind that the order taker can override any of these default values.
- An order taker can indicate that they want to [hold an order](#) if they need to do further research before continuing with an order. A background process (TD-ECBK) will create a [To Do entry](#) for held orders as a reminder to get back in touch with the customer on a future date. You can define the default To Do role assigned to such To Do entries when you create a campaign. Keep in mind that this value can be overridden when the order taker holds an order.
- You can indicate on a campaign the transaction to which the user should be transferred when orders are completed. Refer to [Supported Business Processes](#) for examples of how you might want to use this field.

Setup Sequence

And now you're ready to set up your campaign. The following points describe the order in which this should be done:

WARNING:

We have assumed that you have already designed your organization's SP types, SA types, start options and rates. If you have not yet done this, we recommend familiarizing yourself with the concepts described in [Designing SP Types, Rates and Defining Service Agreement Types](#) before designing your campaigns and packages.

- Setup any new [column references](#) required by the campaign's [miscellaneous fields](#). You will have to leave the retrieve, validate and post algorithms blank until after the next step.
- Setup any new [algorithms](#) required by:
 - The packages' [eligibility rules](#).
 - The packages' [start methods](#).
 - The campaign's [eligibility rules](#).
 - The campaign's [column references](#).
- Update the relevant [column references](#) with the appropriate retrieve, validate and post algorithms.
- Setup any new [characteristic types](#) required by the campaign's [miscellaneous fields](#).

- Create the [campaign](#) using the information you designed above. Specifically:
 - You defined the question and miscellaneous fields under [Determine The Properties Of Every Miscellaneous Field](#).
 - You defined the eligibility rules under [Determine The Eligibility Rules For The Campaign](#).
 - You defined everything else under [Determine How The Campaign Behaves](#).
 - We recommend leaving the campaign's status as Inactive until all packages are entered.
- Create the campaign's [packages](#) using the information you designed above. Specifically:
 - You defined the question and miscellaneous field overrides under [Determine If Any Properties Are Overridden On A Package](#).
 - You defined the eligibility rules under [Determine Package Eligibility Rules](#).
 - You defined the instructions under [Determine If Additional Instructions Are Required](#).
- Change the [campaign's](#) status to Active.

NOTE:

The default campaign on the installation record. If the campaign you've setup is the "default" campaign used when a user presses the Add Order button on [Control Central](#), make sure to specify it as the default campaign on the [installation record](#). Refer to [Setting up a New Customer Prior To Starting Service](#) for more information.

Other Useful Information

The topics in this section contain miscellaneous information about the sales & marketing functions.

Order versus Start/Stop

There are two different ways to start service for a customer:

- As described under [definitions](#), you can use the [order](#) transaction to start service.
- Alternatively, you can use [start / stop](#).

The following table provides insight into the pros and cons of each method (after this table you will find our recommendations):

Issue	Order	Start/Stop
New customer setup	Information about the new customer can be entered on the order page. A person / account will be setup when the order is completed.	A new person and account must be setup prior to using Start/Stop. See How To Add A New Customer From Control Central for more information.
New premise setup	Information about the new premise can be entered on the order page. A premise (and service points) will be setup when the order is completed.	A new premise and service point(s) must be setup prior to using Start/Stop.
Updates to existing customer information	Changes to a customer's existing account and/or person info may be entered on the order page. The related person and/or account will be updated when the order is completed.	Start/Stop cannot be used to update person or account information. Rather, you must transfer to the person or account page and make the necessary changes.

Incomplete orders	The order transaction allows you to record customer information and hold it without starting service. The customer can call back in the future and you can continue where you left off.	You cannot leave a start half-finished - you either have to complete the start or cancel it.
Stop current service, start new service	The order transaction does not currently provide a mechanism for stopping service (it can only be used to start service).	Start/Stop can be used to stop a customer's current service and start new service.
Automatic versus manual start option selection (start options are used to default a great deal of information onto a service agreement)	If a customer selects a package, the system creates service agreements using the start options defined in the package (i.e., you do not have to select a start option for each service agreement that's created).	When you start service, you must define the specific start option for each service agreement created (actually, you only have to do this for those types of service agreements that use start options).
Starting premise and non-premise oriented services	If a customer selects a package, the system can create both premise and non-premise oriented service agreements. For example, when a package is selected, the system can create electric, gas, deposit, and charitable contribution SAs (based on the information defined on the package).	Multiple premise-oriented service agreements can be created in one interaction. However, a separate interaction is required for each non-premise oriented service agreement.
Changes after completion	An order cannot be modified after it is completed. Any changes (cancellations prior to starting service, changes of the start date, etc.) must be performed using the start/stop transaction.	The start/stop transaction allows you to cancel and make changes to pending start service agreements.
Field activity visibility	After an order is completed, the user is transferred to control central where field activities associated with the premise can be seen in trees and context zones.	All field activities associated with all premises associated with all pending starts / stops are shown on the start / stop transaction.
Address changes	Address changes entered on the order transaction are applied when an order is completed (i.e., when a package is selected). They are not held awaiting service agreement activation.	When you enter an address change on the start / stop transaction, this address change is saved until the first pending start or stop is activated. This means that the address change is effectively held until the start/stop is activated.

Based on the above, we'd recommend the following:

- If your organization has well-defined service locations (i.e., premises) AND a premise's service point type controls the types of services offered to the customer, you should probably only use the order transaction to setup new customer information. The new service agreements should be setup using [start / stop](#). See [Prelude To Start/Stop](#) for more information.
- In all other situations, we'd recommend using the [order](#) transaction to start service. If customers typically stop and start service in tandem, we'd recommend the following steps:
 - Stop the customer's existing service using [start / stop](#).
 - Return to [Control Central - Account Info](#) and select the appropriate campaign from the appropriate portal zone. Keep in mind that the portal zones displayed on this page are based on the user's preferences and security profile. Therefore this zone may not be available to all users.
 - When you select the appropriate campaign, you'll be transferred to the [order](#) transaction where you can start the desired package for the customer.

Orders Cannot Be Changed After They Are Completed

The [Lifecycle of an Order](#) indicates that once an order is complete, it cannot become pending again. In addition to this rule, we'd like to stress that once an order is complete, you cannot make any changes to the order except to add new [log entries](#).

Premise and SP Characteristics May Be Populated From Postal Defaults

If you specify a new premise on the order transaction and you complete the order, a new premise will be created. This premise's characteristics can be populated from two different sources:

- You could have designed the campaign to have its orders capture premise characteristics. You do this by adding miscellaneous fields to the campaign that are premise characteristics.
- You could have set up [postal defaults](#) for the premise's country and postal code.

If a given characteristic is referenced on both of the above, the characteristic value on the campaign is used as the premise's characteristic value.

As described above, service points may be created when a package is selected (it depends on the [SA to Create algorithm](#) that you've used on the selected package). The base package algorithms that create a new service point when a package is selected will populate the service point's characteristics using the information on the postal defaults (if specified). Refer to STRM-VT for an example of this type of SA to create algorithm.

To Do List Processing

In the base package, there are two To Do lists that may be affected by orders:

- Highlight pending orders. This To Do list contains orders that are in the pending state. Refer to Pending To Do Entries (TD-EPND) for more information about this To Do list.
- Highlight held orders. This To Do list contains orders that are in the held state. Refer to Held To Do Entries (TD-ECBK) for more information about this To Do list. Refer to [Order - Hold Dialog](#) for more information about holding orders.

Hold and Cancel Reason Codes

In [Lifecycle of an Order](#), we illustrated how a user can hold a pending order. Before a user can hold an order, they must supply an [Order Hold Reason](#).

The same is true if a user wants to cancel a pending or held order (i.e., they must supply a [Order Cancellation Reason](#)).

These reason codes are purely for audit purposes.

Automatically Cancelling Old Orders

The system is delivered with a batch process, Cancel Pending/Held Orders (C1-CNPHO), that can be used to cancel held and/or pending orders that have been open for more than a specified number of days. Refer to the batch control description for more detail.

The delivered process is built using the [Plug-in Driven Background Processes](#) framework. Your implementation can introduce alternate logic, by duplicating this batch control and replacing the select and/or process records algorithms. For example, you can introduce a process record algorithm to create a To Do Entry instead of cancelling the order. Adjust the batch parameters to align with any custom logic you introduce.

Additional Things Can Happen When An Order Is Completed

An optional plug-in spot exists on [customer class](#) where you can introduce additional logic to be executed when an order is completed for an account that belongs to this customer class.

Another optional plug-in spot exists on [campaign](#) where you can introduce additional logic to be executed when an order is completed for the campaign.

New Premises and Accounts Are Only Created if an Order is Completed

It's important to understand that a premise and account are only created when an order is completed. This means you can explore alternatives with a prospect who resides at a new premise without introducing the premise / account. However, the system creates a person if you save an order so that an audit of the customer interaction exists in the system.

Premise Geographic Types Are Populated In An Unusual Way

A [premise's geographic ID's](#) are used by [Control Central](#) when you look for a customer / premise using geographic identifiers.

NOTE:

Geographic coordinates are optional. An [installation option](#) controls whether at least one geographic coordinate is required on every premise.

The following points describe how the geographic ID's are populated on premises that are created when an order is completed:

- If a [postal default](#) exists for the new premise's country / postal code, any geographic identifiers on the postal default are copied onto the new premise.
 - If a postal default hasn't been setup for the new premise's country / postal code, the premise will have a single geographic identifier. It is constructed as follows:
 - The geographic type is defaulted from the [campaign](#).
 - The geographic value is set to ***.
-

NOTE:

Potential error. If neither the campaign nor the postal defaults results in a geographic type AND the [installation record](#) indicates at least one geographic type is required on a premise, an error is generated explaining that either postal defaults or the campaign should be populated with default geographic information.

Account And Premise Usage Are Controlled By The Campaign

When you set up a campaign, you define how the campaign's orders use accounts and premises. Refer to the description of Account Usage and Premise Usage under [Campaign - Main](#) for more information.

Maintaining Orders

The order transaction can be used to satisfy many diverse requirements. For example, you can use an order to:

- Enroll new customers using a single transaction (i.e., you don't have to use the person, premise, service point, and start / stop transactions to enroll a new customer who resides at a new premise).
- Sell new products to existing customers.
- Update existing person, account and premise information using a single transaction.
- Market your services to prospects uploaded from a marketing list (and measure the success of your efforts). If the customer responds to your sales efforts, the system will automatically setup the customer, premise and related service agreements.
- Setup marketing surveys and record your customers' responses.
- Quickly create one-time charges.
- Set up proposals for prospective services (and then send a quotation to the customer for these services).
- And more...

The topics in this section describe the order transaction. Refer to [The Big Picture of Campaigns, Packages and Orders](#) for general information about orders.

Lifecycle of an Order

The following diagram illustrates the lifecycle of an order.

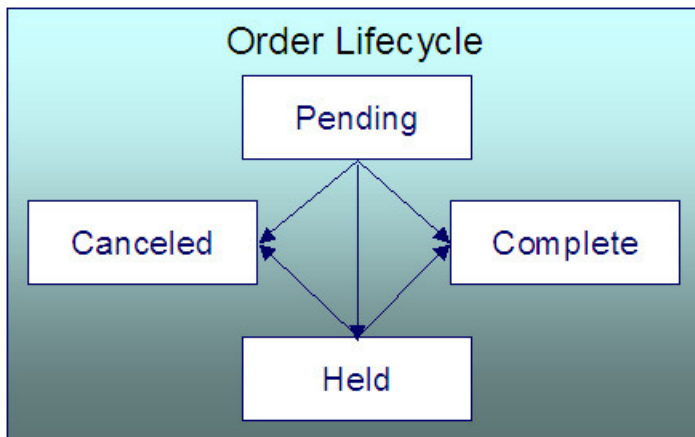

Pending An order starts its life in the Pending state. An order remains in this state until you Cancel, Complete or Hold it.

Held You Hold an order when you want to save an order pending future information. For example, you would hold an order if you need to perform research on the perfect rate for the customer before completing the order. A Held order can be Completed or Canceled.

Complete When a customer selects a package of goods and services, the "V" is updated, service agreements are initiated, and the order becomes Complete. No changes may be made to a Complete order.

Canceled A Pending or Held order may be Canceled.

Order User Interface Flow

The diagram that appears below illustrates the anticipated navigation path used to process an order.

WARNING:

An order's campaign controls many aspects of the user interface flow. The illustration that appears below is a sample of what's possible; it may not mirror how your team has setup your company's campaigns.

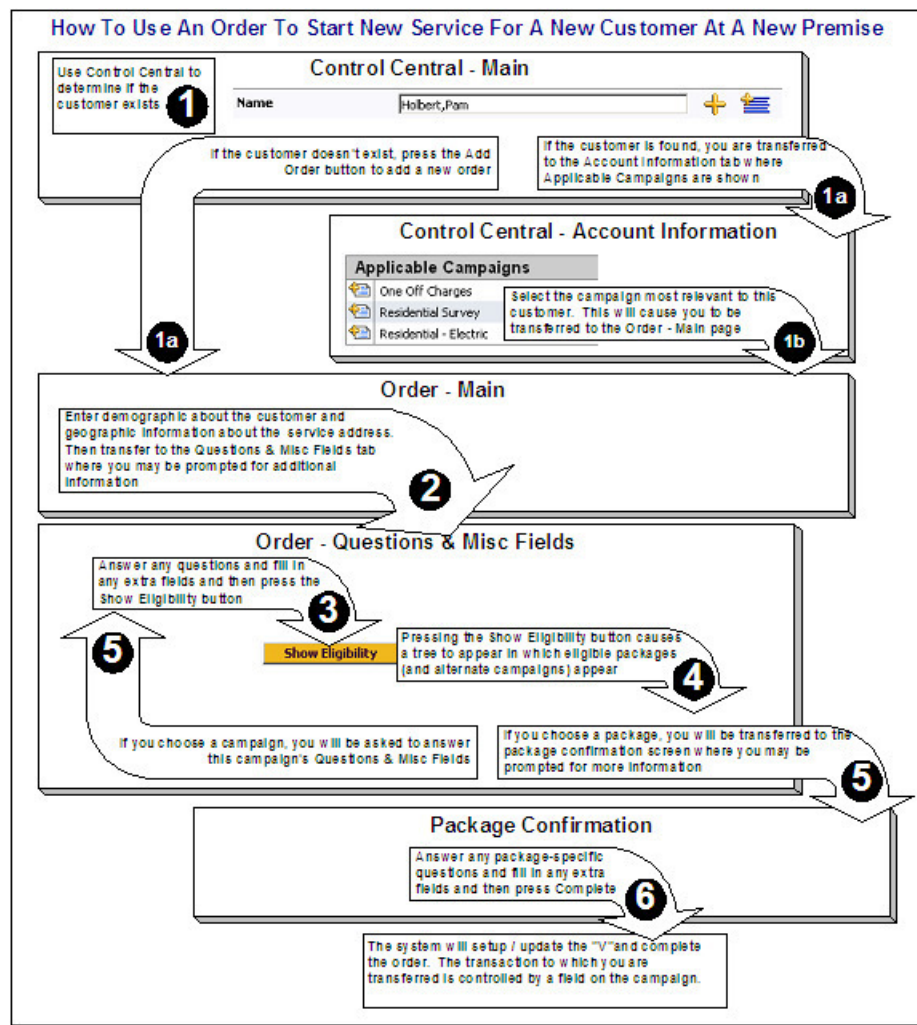

Order - Main

This page is used to define demographic and geographic information about the customer / prospect.

FASTPATH:

Refer to [The Big Picture of Campaigns, Packages and Orders](#) for more information about orders.

Open this page using **Menu > Sales & Marketing > Order > Search.**

FASTPATH:

Refer to [Order User Interface Flow](#) for information about how to use this page.

Description of Page

Order contains a concatenation of the customer's name, campaign, package (if the order is completed), status and start date. **Order ID** is the system-assigned unique identifier of the order. These values only appear after the order is added to the database.

Status contains the state of the order. Refer to [Lifecycle of an Order](#) for information about the valid values and the state transition rules. Additional information may also be displayed based on the status:

- If the order's status is Held, the following information is also displayed: the hold reason, the name of the user who held the order, and the date and time when a reminder for the order is due to be created.
- If the order's status is Canceled, the following information is also displayed: the cancel reason, the name of the user who canceled the order, and the date and time when the order was canceled.
- If the order's status is Complete, the following information is also displayed: the name of the user who completed the order and the date and time when the order was completed.

Press the **Hold** button to hold a Pending order. Refer to [Order - Hold Dialog](#) for a description of the pop-up window used to hold an order.

Press the **Cancel** button to cancel a Pending or Held order. Refer to [Order - Cancel Dialog](#) for a description of the pop-up window used to cancel an order.

If the **Campaign** has been setup to allow the completion of orders without selecting a package, a button appears to the right of **Cancel**. The label that appears in the button is defined on the **Campaign**. When pressed, the order is completed. When the order is completed,

- [The "V"](#) is setup / updated.
- All questions and miscellaneous fields (defined on the next tab) are posted to the appropriate object.
- [Optional plug-ins](#) are executed.
- You will be transferred to the order completion transaction that's defined on the **Campaign** (if any).

If the order references an existing person, account, or premise and the related person / account / premise has changed after their information was snapshot on the order, the **Out of Sync** section appears. This section highlights which objects have changed since the order was last saved. In addition, the **Sync** button appears. When pressed, the order is updated with the current field values for these objects.

An order's **Campaign** controls many aspects of the order's behavior. For example, it controls:

- The type of information defaulted onto an order.
- The eligibility-oriented questions that are displayed on the next tab.
- The superset of packages that can be offered to a customer.

- In addition to the above, campaigns also control high-level [eligibility rules](#) and [business process flows](#).

An order's **Campaign** is defaulted as follows:

- When you select a customer on [Control Central - Main](#), you are automatically transferred to the [Account Information](#) portal. One of the [zones](#) on this portal page contains the campaigns that can be offered to the customer. If you select a campaign from this zone, you are transferred to the [Order](#) transaction with the respective Campaign defaulted. Note, the Applicable Campaigns zone only appears if the CSR has modified their preferences to display this zone.
- In all other situations, the order's campaign defaults from the [Installation Record](#).

You may change an order's **Campaign** at will. Note that changing the campaign will result in the **Questions & Misc Fields** (the next tab) being refreshed with values associated with the new campaign. However, other values typically defaulted from the campaign (such as default customer class) do not get refreshed so that data you may have entered does not get overwritten.

Start Date defines the date on which service will start. This date becomes the start date on service agreements created when this order is completed. If you need to change the start date on these service agreements, transfer to [Start/Stop](#) (where all of the pending start service agreements will appear).

NOTE: Manual date entry is disabled on the start date and the date picker must be used when the Disable Manual Date Entry **Option Type** on the Customer Information Options [Feature Configuration](#) has been enabled.

The topics that follow describe the remaining sections on this page

Order - Main - Person Information

The **Person Information** section contains demographic information about the customer / prospect.

WARNING:

This page contains a subset of person-oriented information. If you need to define other person-oriented information, transfer to [Person - Main](#) after the order is completed.

If this is a new customer, select Create New Person and enter demographic information in the fields that follow. Otherwise, select Use Existing Person and use the **Name** field or press the search button to find the customer. After you select an existing person, the following events takes place:

- The person's name appears beneath the person search (and the person context menu can now be used to drill down to person-oriented pages). Note, the person's name is formatted by a plug-in algorithm on the [installation record](#). Refer to the base package's name format algorithm (PERS-INFO) for an example. If you prefer different formatting logic, your system administrator should configure the system appropriately.
- If any of the Questions & Misc Fields (on the next tab) are used to capture person-oriented characteristics, the person's existing characteristic values are defaulted.
- If the selected person has at least one account, information about the account is displayed in the **Account Information** section (if the **Campaign** makes uses of accounts). In addition, if any of the Questions & Misc Fields (the next tab) are used to capture account-oriented characteristics, the account's existing characteristic values are populated in the respective rows on this tab.
- Information about the person is displayed in the fields that follow.

Use **Person/Business** to indicate if the customer is a Person or a Business. This value controls how the person's primary name is validated. Note, for new customers, this value defaults based on the **Campaign**.

Names are used by [Control Central](#) when you look for a customer based on their name. In addition, a person's primary name is the addressee on the person's bill unless overridden by the **Override Mailing Name** (defined on [Person - Correspondence](#)

[Information](#)). To modify a name, simply move to a field and change its value. To add a new name, press + to insert a row, then fill in the information for each field. The following fields display:

- Use **Name Type** to indicate if the name is an Alias, Alternate Representation, Doing Business As, Legal, or Primary name. Note, for new persons, a value of Primary is defaulted.
- Use **Person Name** to define the person's name. Note well, the name is case sensitive.

NOTE:

Alternate representations of a person's name. You would use an Alternate Representation for a person's name when you have an alternate ways to define the person's primary name. Alternate representations are typically used in countries that use multiple character sets (e.g., the Primary name is entered in Chinese, the Alternate Representation is entered in English). When a person has an alternate name, both the main and alternate names can be used to search for a person. The Alternate Representation **Name Type** only appears if you have enabled alternate addresses on the installation record. Refer to the description of the Alternate Representation field under [Installation - Main](#) for more information.

Validation and formatting are performed by plug-ins. The validation that is applied to **Person Name** (e.g., a comma separating the last and first name - Smith,Patricia) is controlled by a plug-in algorithm on the [installation record](#). More than one algorithm can be plugged into this plug-in spot. Algorithms plugged into this plug-in spot can also perform formatting such as removing special characters that your implementation's business rules do not allow in person names. Other algorithms can be configured to remove or replace text.

-
- The **Do Not Format** switch can be used to bypass any person name formatting done by the algorithms described above. Validation such as requiring name separator is still applied, but no further formatting is applied. Setting the switch only applies while the record is being saved and is then reset. The switch is reset because the formatting is only applied when the record is subsequently changed. This switch is only shown if the Enable Person Name Format Bypass **Option Type** on the Customer Information Options [Feature Configuration](#) has been enabled

Person Contacts are used by Control Central to look for accounts and persons. For new customers, the person contact type(s) default based on the Campaign. To modify a person contact, simply move to a field and change its value. To add a new person contact, press + to insert a row, then fill in the information for each field. The following fields display:

- **Person Contact Type** indicates the type of contact such as, home phone, cell phone, or work email.
- **Contact Information** contains the specific contact information such as, the phone number or email address. Enter the contact information in the format described.

NOTE: Formatting is performed by a plug-in. The format that is applied to **Contact Information** is controlled by the algorithm that is plugged in on the respective person contact type (refer to Setting Up Person Contact Types for more information). If you prefer a different format, your system administrator should configure this algorithm appropriately.

-
- Enter the **Extension**, if any, of the contact information. (This field is only active when the contact's contact routing is phone or fax.)
 - The **Primary** switch must be set for exactly one person contact for each contact routing.
 - **Do Not Disturb (From)** and **Do Not Disturb (To)** indicate the times when a person contact should not be used. (**Note:** these fields are active when the Person Contact Type's Allow Do Not Disturb information is set to *Optional*.)

Phone numbers are used by [Control Central](#) to look for accounts and persons. For new customers, the phone type(s) default based on the **Campaign**. To modify a telephone number, simply move to a field and change its value. To add a new telephone number, press + to insert a row, then fill in the information for each field. The following fields display:

- **Phone Type** indicates the type of phone number, e.g., Home, Mobile, Business, ...
- Use **Phone Number** to define the telephone number. Enter the telephone number in the format described by the **Phone Format**.

NOTE:

Formatting is performed by a plug-in. The format that is applied to a **Phone Number** is controlled by the algorithm that is plugged in on the respective **Phone Type**. You can also have this plug-in convert input values into formatted values, e.g., this algorithm could transform all numbers into a formatted string. If you prefer a different format, your system administrator should configure this algorithm appropriately.

- Enter the **Extension**, if any, of the telephone number.

NOTE: The Person Phone grid appears when the Legacy Person Phone and Email Option Type on the Customer Information Options Feature Configuration has been enabled.

A person's **ID** has several uses:

- It is used by **Control Central** when you look for a customer / premise based on their ID.
- It is used to highlight potential duplicate persons.
- **Control Central** displays a person's primary identification in the search results area to help a user identify the customer when multiple customers match the search criteria.

The person ID usage flag on the **installation record** indicates whether or not at least one id for a person is required or optional. The ID Type defaults from the **installation record** based on the **Person Type** (Person versus Business). The following fields are used to define a customer's primary ID.

- Select the type of identification from the **ID Type** drop down.
- Enter the identification number in the **ID Number** field. Please note that if the ID number should be formatted (e.g., dashes in an American social security number), you do not have to include the delimiter (e.g. dashes). You can enter the ID number as a contiguous value and the system will format it for you. The format is shown adjacent to the **ID Number** field.

NOTE:

Formatting is performed by a plug-in. The format that is applied to a person ID number(e.g., dashes in an American social security number) is controlled by the algorithm that is plugged in on the respective **ID Type**. If you prefer a different format, your system administrator should configure this algorithm appropriately.

A person can have many forms of identification. The order transaction only caters for a single form of ID (as this is the most typical situation). If you want to specify additional person ID's, you must transfer to **Person - Main** after the person is created (persons are created when the order is saved).

Specify the customer's **Email ID** (if any).

NOTE: **EmailID** appears when the Legacy Person Phone and Email Option Type on the Customer Information Options Feature Configuration has been enabled.

Define the **Language** in which the person prefers their bills and correspondence printed.

NOTE:

Default note. The person's language defaults from **Installation Options - Person**.

FASTPATH:

Refer to **Customer Language** for more information on options for supporting multiple languages for your customers.

Use **Life Support / Sensitive Load** to indicate if the person has life support or sensitive load equipment. Valid values are: LS/SL (i.e., the person has life support / sensitive load equipment), None. If the customer has LS/SL equipment, make a note of the type of equipment in the **Life Support / Sensitive Load Notes**.

NOTE:

A premise can also have life support / sensitive load information. If the equipment is physically linked to the premise (e.g., a hospital has life support equipment), you should NOT specify the life support information on the person. Rather, after the premise is added, transfer to [Premise - Misc](#) and specify life support information on the premise.

Life support affects alerts and C&C. If life support / sensitive load information is specified, an alert will appear when the person is displayed on control central. In addition, if a person has life support or sensitive load equipment, it is possible for a different credit & collection severance process to be kicked off if the person's account associated has overdue debt. Refer to [Designing Your Severance Procedures](#) for more information.

Order - Main - Service Address

The **Service Address** section contains geographic information about the service address:

WARNING:

This page contains a subset of premise-oriented information. If you need to define other premise-oriented information, transfer to [Premise - Main](#) after the order is completed.

Whether or not a premise is required or even allowed on an order is controlled by an option on the **Campaign**. If the **Campaign** disallows the use of a premise, this section will be suppressed. If the **Campaign** allows the use of a premise, an indication of whether a premise is optional or required is displayed adjacent to **Service Address**.

If a premise is allowed on the order, use the dropdown at the top of this section to tell the system about this order's premise:

- Select No Premise Information if you do not want to associate a premise with this order (e.g., for a one-time charge).
- Select Create New Premise if this is a new premise. You should enter the new premise's address in the remaining fields in this section.
- Select Use Existing Premise if an existing premise should be used on the order. Use the **Address** and **City** fields or press the search button to find the premise. Refer to [Control Central - Search Facilities](#) for suggestions in respect of how to use these fields. After you select an existing premise, the following events takes place:
 - The premise's description appears beneath the premise search fields (and the premise context menu can now be used to drill down to premise-oriented pages).
 - If any of the Questions & Misc Fields (the next tab) are used to capture premise-oriented characteristics, the premise's existing characteristic values are defaulted.
 - Information about the premise is displayed in the fields that follow.

Use **Premise Type** to describe the type of service location.

The address's constituent fields vary based on the **Country**. Please refer to the [Country](#) page for more information.

Populate **Trend Area** if the **Postal** is blank. The **Postal** and the **Trend Area** cannot both be blank as the **Trend Area** is a required field on the premise and its value is typically defaulted from [postal defaults](#).

NOTE:

Default note. The values of several fields on this and the next page default based on the **Country** and the **Postal**. Refer to [Setting Up Premise & Service Point Postal Defaults](#) for more information. Also note, there are several premise-oriented fields that do not appear on this transaction that will be populated on the premise based on the **Country** and **Postal** (e.g., characteristics, time zone, trend area, geo ID's).

Use **CIS Division** to define the jurisdiction in which the premise is located.

Order - Main - Account Information

The **Account Information** section contains account-oriented information.

WARNING:

This page contains a subset of account-oriented information. If you need to define other account-oriented information, transfer to [Account - Main](#) after the order is completed.

Whether or not an account is required or even allowed on an order is controlled by an option on the **Campaign**. If the **Campaign** disallows the use of an account, this section will be suppressed. If the **Campaign** allows the use of an account, an indication of whether an account is optional or required is displayed adjacent to **Account Information**.

If an account is allowed on the order, use the dropdown at the top of this section to tell the system about this order's account:

- Select No Account Information if you do not want to associate an account with this order (e.g., for a person-oriented marketing survey).
- Select Create New Account if this is a new account. You should enter the new account's information in the remaining fields in this section.
- Select Use Existing Account if an existing account should be used on the order. If an existing person was selected above, one of the person's accounts (if any) will be automatically displayed in the **Account Information**. In addition, if the order references an existing person, the account search will be limited to accounts associated with this person. If an **Existing Account** is selected, the following takes place:
 - Basic information about the account appears beneath the search area (and the account context menu can now be used to drill down to account-oriented pages).
 - If any of the Questions & Misc Fields on the next tab are used to capture account-oriented characteristics, the account's existing characteristic values are defaulted.
 - Information about the account is displayed in the fields that follow.

If you have set the Installation Option CIS Division Control flag, you must define the new account's **CIS Division**. The values are restricted to the user's CIS Division(s). See Users and CIS Division for more information. The value is defaulted to user's primary CIS Division.

Customer Class plays a part in:

- If and when a customer is subject to late payment charges.
- The account's default collection class and when the account debt monitor reviews an account. Refer to [The Big Picture of Credit & Collections](#) for more information about how and when an account's debt is reviewed.
- And several other functions. Refer to [Setting Up Customer Classes](#) for more information.

NOTE:

Default note. For new accounts, the **Campaign** can default the **Customer Class**. If the campaign does not define a customer class, it can be defaulted from the CIS Division, if shown, or installation options.

The optional Account **Management Group** controls the roles assigned to To Do entries associated with an account. Refer to [Setting Up Account Management Groups](#) for more information.

NOTE:

Default note. For new accounts, **Management Group** defaults based on the **Campaign**.

The remaining fields are used to describe how the bill should be routed to the customer.

WARNING:

When an order is completed, several fields that do not appear on this page that reside on [Account - Person](#) are populated. For example, **Account Relationship Type**, **Bill Format**, **Number of Copies**, **Receives Notification** are all populated with default values. If you need to override the default values, transfer to [Account - Person](#) after the account is added.

Use **Bill Route Type** to define how the bill is sent to the customer. This field's value defaults from the [Installation Record](#). This value is important as it controls many options on the remainder of this page. If the **Bill Route Type** indicates that bills are routed via Fax, the person's fax number is displayed adjacent (the system knows which of a [person's phone numbers](#) is a fax number by the **Phone Type**). If the **Bill Route Type** indicates that bills are routed via Email, the person's **Email** address is displayed adjacent. If the **Bill Route Type** indicates that bills are routed via the Postal service, you must choose an appropriate **Address Source** to define which address should be used. Refer to [Setting Up Bill Route Types](#) for more information about bill route types.

If the **Bill Route Type** indicates that bills are routed via the Postal service, you must choose the appropriate **Address Source** to define which address should be used.

- Choose Mailing Premise on Account if bills should be sent to the address associated with the Mailing Premise on the first page. This address is displayed adjacent.
- Choose Person if bills should be sent to the [person's mailing address](#). This address is displayed adjacent.
- Choose Account Override if bills should be sent to an override address specified below. Typically, you would only choose this option if the person has multiple accounts and each account's bills should be sent to a different address.

If you select a **Address Source** of Account Override, you must enter the address to which bills will be sent in the following address constituents. The number and type of address constituents is based on the **Country** (refer to [Defining Countries](#) for more information on address constituents). These fields will be protected for other **Address Sources**. Note, the **Country** defaults from [Installation Options - System](#) and several other constituents default based on the **Country** and **Postal** if a [Postal Default](#) exists for the postal code.

NOTE:

By default, the **Address Source** field is protected on Order – Main page if the **Bill Route Type** is set to a value other than Postal. To enable the **Address Source** field for all **Bill Route Types** in most circumstances, set the Always Enable Address Source option type on the General System Configuration feature configuration to Y.

Regardless of the **Always Enable Address Source** option value, **Address Source** and **Address Information** are displayed but both are disabled when **Bill Routing Method** is *Not Postal* and **Quote Routing Method** (on Account – Persons page) is *Postal*. A message “*The Main Person receives Quotes at this address. To edit it, go to the 'Persons' tab on the Account.*” is displayed next to the **Address Source**.

Order - Questions & Misc. Fields

This page has several purposes:

- The order's Campaign can define questions to be posed to customers when an order is taken. For example, you could ask the customer "marketing survey" questions (e.g., please rate our service, how do you heat your home?, etc.). This page allows you to capture the customer's response.
- The order's Campaign can also be setup to capture additional fields to be updated on the order's person / account / premise when the order is completed. For example, you could indicate that the account's override due date and automatic payment options should be captured when an order is taken. This page allows you to capture these field values.

- The order's Campaign can also be setup to pose eligibility-oriented questions that qualify the customer for packages of goods and services. For example, you might have a campaign with packages that can only be selected if the customer commits to a year's worth of service. This page allows you capture the customer's response to these types of questions.
- After entering the above information (and the information on the Main page), you can use this page to select a package of goods and services for the customer.
- You can use this page to switch the campaign on the order (which would result in new questions and miscellaneous fields appearing).

FASTPATH:

Refer to [The Big Picture of Campaigns, Packages and Orders](#) for more information.

Open this page using **Sales & Marketing, Order** and then navigate to the **Questions & Misc Fields** tab.

FASTPATH:

Refer to [Order User Interface Flow](#) for information about how to use this page.

Description of Page

Order contains a concatenation of the customer's name, campaign, package (if the order is completed), status and start date. **Order ID** is the system-assigned unique identifier of the order. These values only appear after the order is added to the database.

Status contains the state of the order. Refer to [Lifecycle of an Order](#) for information about the valid values and the state transition rules. Additional information may also be displayed based on the status:

- If the order's status is Held, the following information is also displayed: the hold reason, the name of the user who held the order, and the date and time when a reminder for the order is due to be created.
- If the order's status is Canceled, the following information is also displayed: the cancel reason, the name of the user who canceled the order, and the date and time when the order was canceled.
- If the order's status is Complete, the following information is also displayed: the name of the user who completed the order and the date and time when the order was completed.

Press the **Hold** button to hold a Pending order. Refer to [Order - Hold Dialog](#) for a description of the pop-up window used to hold an order.

Press the **Cancel** button to cancel a Pending or Held order. Refer to [Order - Cancel Dialog](#) for a description of the pop-up window used to cancel an order.

If the **Campaign** has been setup to allow the completion of orders without selecting a package, a button appears to the right of **Cancel**. The label that appears in the button is defined on the **Campaign**. When pressed, the order is completed. When the order is completed,

- [The "V"](#) is setup / updated.
- All questions and miscellaneous fields (defined on the next tab) are posted to the appropriate object.
- [Optional plug-ins](#) are executed.
- You will be transferred to the order completion transaction that's defined on the **Campaign** (if any).

If the order references an existing person, account, or premise and the related person / account / premise has changed after their information was snapshot on the order, the **Out of Sync** section appears. This section highlights which objects have changed since the order was last saved. In addition, the **Sync** button appears. When pressed, the order is updated with the current field values for these objects.

The number and type of **Questions & Misc Fields** is controlled by the [Campaign](#).

NOTE:

Some questions can be suppressed. The campaign contains an indication if each question is account-oriented, person-oriented, premise-oriented or order-oriented. If the question is account-oriented and no account is defined on the **Main** tab, the question will be suppressed. If the question is premise-oriented and no premise is defined on the **Main** tab, the question will be suppressed.

Each row in this grid has a **Prompt** and a **Response**. The value of each **Prompt** is defined on the **Campaign**. The **Response** holds the answer supplied by the customer. Please note the following about the **Response** field:

- On a **Campaign**, you can indicate which questions / miscellaneous fields are required. The Response for a required field is prefixed with an asterisk - * .
- The value of a Response can default from a variety of sources:
 - If an existing person was selected on the **Main** page AND the response is used to capture a [person characteristic](#), the existing characteristic value will be defaulted.
 - If an existing premise was selected on the **Main** page AND the response is used to capture a [premise characteristic](#), the existing characteristic value will be defaulted. If no value exists, the characteristic values will default based on the postal defaults associated with the service address's **Country** and **Postal**.
 - If an existing account was selected on the **Main** page AND the response is used to capture an [account characteristic](#), the existing characteristic value will be defaulted.
 - Otherwise, the characteristic value is defaulted from the **Campaign**.
- The type of field used to capture a Response is controlled by the Campaign. Depending on the type of Response you may see [Go To](#) buttons and [Search](#) buttons.

After entering the **Responses** to the **Questions & Misc Fields**, press the **Show Eligibility** button.

The following may occur when this button is pressed:

- If a new customer is specified on the Main page, a warning will advise you that a new person will be added. The system needs to add a new person so that an audit of the customer interaction exists.
- The tree expands to show the Order - Eligibility Tree containing package, ineligible package, error package, and other campaign nodes:
 - Each **Package** node contains a package that is linked to the campaign whose [Eligibility Criteria](#) allows its selection by the customer. You can expand this node to see the various service agreements that will be created if you select the package. Selecting one of these packages causes the [Order - Package Confirmation](#) page to appear in which you can confirm your selection.
 - The **Ineligible Package(s)** node contains packages whose [Eligibility Criteria](#) prevents their selection by the customer.
 - The **Error Packages** node contains packages whose [Eligibility Criteria](#) have returned errors (if any).
 - The **other campaign(s)** node contains alternative campaigns that may be substituted for the current campaign on the package. Selecting one of these campaigns will cause the campaign to be changed on this order. Changing a campaign on an order will result in new questions and miscellaneous fields appearing. Refer to [The Big Picture Of Campaign Eligibility](#) for more information.

NOTE:

Some nodes can be suppressed. To increase page performance with large campaigns, you can define a [feature configuration](#) to suppress the display of the Ineligible Packages, Error Packages or Other Campaign nodes. If a node is suppressed, it does not appear on the eligibility tree and the system does not process the information necessary to display the node.

Order - Log

This page contains an audit trail of significant events that transpired in the history of this order.

Open this page using **Menu > Sales & Marketing > Order > Search** and navigate to the **Log** page.

Description of Page

Order contains a concatenation of the customer's name, campaign, package (if the order is completed), status and start date. **Order ID** is the system-assigned unique identifier of the order. These values only appear after the order is added to the database.

Status contains the state of the order. Refer to [Lifecycle of an Order](#) for information about the valid values and the state transition rules. Additional information may also be displayed based on the status:

- If the order's status is Held, the following information is also displayed: the hold reason, the name of the user who held the order, and the date and time when a reminder for the order is due to be created.
- If the order's status is Canceled, the following information is also displayed: the cancel reason, the name of the user who canceled the order, and the date and time when the order was canceled.
- If the order's status is Complete, the following information is also displayed: the name of the user who completed the order and the date and time when the order was completed.

Press the **Hold** button to hold a Pending order. Refer to [Order - Hold Dialog](#) for a description of the pop-up window used to hold an order.

Press the **Cancel** button to cancel a Pending or Held order. Refer to [Order - Cancel Dialog](#) for a description of the pop-up window used to cancel an order.

Campaign contains basic information about the order's campaign.

Package only appears if the order has been completed. It contains basic information about the package.

Start Date contains the date on which the service agreement's created by the order will be started.

The **Log** contains an audit trail of significant events that transpired in the history of this order. There are two types of entries in the log:

- The system automatically adds log entries when key events occur. These entries may not be removed or changed.
- Users may add log entries by pressing the + button and then specifying the Details.

Order - Package Confirmation

The Package Confirmation page allows you to check the package you selected before [the V](#) is created / updated for the customer. This page opens when you select a package from the eligibility tree on [Order - Questions & Misc Fields](#).

WARNING:

If you press the **Complete** button, a variety of objects may be created (service agreements, service points, a premise, an account, field activities, etc.). If you need to change any of these objects after order completion, you must transfer to the respective page on which the object is maintained. You can also use [Start/Stop](#) to make changes to the service agreements created by this transaction.

Description of Page

Order contains a concatenation of basic information about the order. **Order ID** is the system-assigned unique identifier of the order. These values only appear after the order is added to the database.

Campaign contains basic information about the order's campaign.

Package contains basic information about the package.

Premise is the address at which service will be delivered.

Person is the name of the customer.

Account is the name of the customer and their customer class.

Start Date contains the date on which the service agreement's created by the order will be started.

The **Questions & Misc Fields** grid contains the questions and miscellaneous fields that appeared on the order. Note well, it is possible to design a campaign and a package where some fields are optional on the campaign but required for a specific package. The **Response** of all required fields for the selected package are prefixed with an asterisk. Refer to [Order - Questions & Misc Fields](#) for information about the rows in this grid.

NOTE:

Changing your answers could cause the package to become ineligible. As described earlier, the fields you enter on an order play are what the system uses to determine if a package can be selected for a customer. If you change the answers to the **Questions & Misc Fields**, the package may no longer be eligible and an error will be presented to you. You will have the choice of reverting to the original answers or returning to the order page where you can select an eligible package.

Additional questions / misc fields are possible. It is possible to design a campaign where certain field values are only visible on specific packages. In this scenario, the **Questions & Misc Fields** grid may contain additional rows for a given package. Refer to [Designing Campaigns and Packages](#) for more information.

The **Instructions** grid contains package-specific suggestions. These instructions are defined on the [package](#).

The **Messages** grid contains system-generated messages that summarize what will happen if you press the **Complete** button.

Press the **Complete Order** button if you are satisfied with the information on the order. Otherwise, press **Do Not Use this Package** to change or cancel the order.

Order - Hold Dialog

The **Order - Hold** dialog opens if you press the **Hold** button on the order transaction. You use it to define why the order is being held and when you want to be reminded to check up on the order.

Description of Page

Use **Hold Reason** to define why the order is being held.

The following fields are used to control the [To Do entry](#) that will be created to remind you about this order.

- Use **Reminder Date / Time** to define the latest date on which the To Do entry should be created. The reason we indicated this should be the latest date is because the background process (TD-ECBK) that's responsible for creating these To Do entries has a parameter called "lead time". This parameter is used to define the number of days before the **Reminder Date** that the To Do entry should be created.
- If the To Do entry should be addressed to a group of users, choose a **ReminderType** of Send to Role and enter the user group's **To Do Role**. Note, the To Do Role will default from the order's campaign.
- If the To Do entry should be addressed to a specific user, choose a **ReminderType** of Send to User and enter the user's User ID in **To Do User**.
- **Log Notes** are used to describe why the order is being held. This information appears in the [log entry](#) that is created by the system when you hold an order.

If there are any To Do entries (with a status of Open or Being Worked On) that drill down to this order, a message is displayed indicating that existing To Do entries for this order will be completed. If the order is already in Hold status,

existing To Do entries are completed when you click the OK button and a new To Do entry is created when the background process responsible for creating the To Do entries runs.

Order - Cancel Dialog

The Order - Cancel dialog opens if you press the **Cancel** button on the order transaction. You use it to define why the order is being canceled.

Description of Page

Use **Cancel Reason** to define why the order is being canceled.

Use **Log Notes** to describe why the order is being canceled. This information appears in the [log entry](#) that is created by the system when you cancel an order.

Maintaining Campaigns

When you add an [order](#), you must reference its [campaign](#). An order's campaign controls:

- The type of information defaulted onto an order. For example, you can setup a campaign to default a given account management group on all orders linked to this campaign. This account management group will then default onto accounts created when the campaign's orders are completed.
- The eligibility-oriented questions that are posed to the customer when an order is taken. For example, the questions indicated above - Who is your current energy service provider? / Would you like to pay automatically? / What is your date of birth? - are all defined on the order's campaign.
- The superset of packages that can be offered to a customer whose order references this campaign. An order's campaign defines the types of packages that may be selected.
- In addition to the above, campaigns also control high-level [eligibility rules](#) and [business process flows](#).

The topics in this section describe the campaign transaction.

FASTPATH:

Refer to [The Big Picture of Campaigns, Packages and Orders](#) for general information about campaigns. Refer to [The Big Picture Of Campaign Eligibility Rules](#) for a discussion of how to control which campaigns can be used for different types of customers. Refer to [Designing Campaigns and Packages](#) for guidelines describing how to design your campaigns.

Lifecycle of a Campaign

The following diagram illustrates the lifecycle of a campaign.

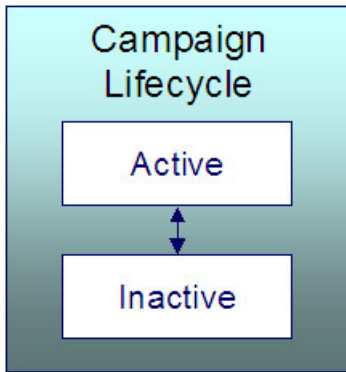

Active An Active campaign may have orders created in respect of it.

Inactive By Inactivating the campaign, you are preventing it from being used on future orders. In addition, Inactive campaigns do not appear in the [Applicable Campaigns](#) zone.

Campaign - Main

This page is used to define basic information about a campaign.

FASTPATH:

Refer to [The Big Picture of Campaigns, Packages and Orders](#) and [Designing Campaigns and Packages](#) for more information.

Open this page using **Menu > Sales & Marketing > Campaign > Search**.

Description of Page

Campaign is the user-defined code that uniquely identifies the campaign. The campaign's description appears adjacent.

Description briefly describes the campaign.

Campaign Status describes the state of the campaign. Refer to [Lifecycle of a Campaign](#) for more information.

The following fields contain values to be defaulted onto this campaign's orders. The user who takes the order may override these default values. Note well, these default values are only applicable for new persons - they will not override field values defined on existing persons.

- The system requires all persons to be defined as either a Person or a Business. Use **Default Person / Business** to define the default value for persons created by this campaign's orders.
- Every person contact defined for a person must reference a person contact type. Use **Default Person Contact Type 1**, **Default Person Contact Type 2**, and **Default Person Contact Type 3** to define the first three [person contact type](#) defaults for persons created by this campaign's orders.

NOTE: Person Contact Types appears when the Legacy Person Phone and Email Option Type on the Customer Information Options Feature Configuration has **not** been enabled

- Every phone number defined for a person must reference a [phone type](#). Use **Default Phone Type 1** and **Default Phone Type 2** to define the first two phone types defaults for persons created by this campaign's orders.

NOTE: Phone Types appears when the Legacy Person Phone and Email Option Type on the Customer Information Options Feature Configuration has been enabled.

Premise Usage controls if and how this campaign's orders use premises. You have the following options:

- Select Not Allowed if this campaign's orders do not reference a premise.
- Select Optional if this campaign's orders do not have to reference a premise. This option also means that a new OR existing premise may be specified on the order. Note, if an order references a new premise, the premise will be created when the order is completed.
- Select Optional - Existing Premise Only if this campaign's orders do not have to reference a premise. This option also means that only an existing premise may be specified on an order.
- Select Required if this campaign's orders must reference a premise. This option also means that a new OR existing premise may be specified on the order. Note, if an order references a new premise, the premise will be created when the order is completed.
- Select Required - Existing Premise Only if this campaign's orders must reference a premise. This option also means that only an existing premise may be specified on an order.

The following fields contain values to be defaulted onto this campaign's orders. The user who takes the order may override these default values. Note well, these default values are only applicable for new premises - they will not override field values defined on existing premises.

- The system requires all premises to reference a [premise type](#). Use **Default Premise Type** to define the default value for premises created by this campaign's orders.
- Every geographic ID defined for a premise must reference a [geographic type](#). Use **Default Premise Geo Type** to define the default value for premises created by this campaign's orders. Refer to [Premise Geographic Types Are Populated In An Unusual Way](#).

Account Usage controls if and how this campaign's orders use accounts. You have the following options:

- Select Not Allowed if this campaign's orders do not reference an account.
- Select Optional if this campaign's orders do not have to reference an account. This option also means that a new OR existing account may be specified on the order. Note, if an order references a new account, the account will be created when the order is completed.
- Select Optional - Existing Account Only if this campaign's orders do not have to reference an account. This option also means that only an existing account may be specified on an order.
- Select Required if this campaign's orders must reference an account. This option also means that a new OR existing account may be specified on the order. Note, if an order references a new account, the account will be created when the order is completed.
- Select Required - Existing Account Only if this campaign's orders must reference an account. This option also means that only an existing account may be specified on an order.

The following fields contain values to be defaulted onto this campaign's orders. The user who takes the order may override these default values. Note well, these default values are only applicable for new accounts - they will not override field values defined on existing accounts.

- The system requires all accounts to belong to a [customer class](#). Use **Default Customer Class** to define the default value for accounts created by this campaign's orders.
- An account may reference an [account management group](#). Use **Default Acct Management Group** to define the default value for accounts created by this campaign's orders.

If a user [holds](#) one of the campaign's orders, they can have a [To Do entry](#) generated on a future date to remind them about the order. Use **Default Hold To Do Role** to define the [group of users](#) to whom the To Do entry will be sent. Note well, the user who holds an order can indicate that the related To Do entry should be addressed to a specific user ID rather than a **Role**.

Use **Order Open Option** to define the page that is displayed when a user adds a new order for this campaign. This field is only relevant when the order transaction is invoked in "add mode" and a campaign is passed to this transaction (e.g., if a user adds an order from the [Applicable Campaigns Zone](#)).

A user can be automatically transferred to a different transaction when they complete an order. Refer to [Supported Business Processes](#) for examples of transactions that we anticipate being used. Use **Navigation Option** to define this transaction. Note,

- Leave **Navigation Option** blank if the user should remain on the order transaction after completion.
- You can setup **Navigation Options** to transfer to the user to a tab other than the main tab.

If a user is allowed to complete this campaign's order's without selecting a package,

- Turn on **Allow Order Compl w/o Package** and
- Use **Order Compl w/o Package Label** to define the message to appear in the button used to complete such orders.

FASTPATH:

Refer to [Campaigns Without Packages](#) for examples of campaigns where you would enable the above fields.

Use **Long Description** to provide an overview of this campaign.

The grid at the bottom of the page summarizes this campaign's questions and miscellaneous fields. To change this information, press the adjacent go to button (which will transfer you to the [Questions and Misc Fields](#) tab). To add additional information, transfer to the [Questions and Misc Fields](#) tab and press the + button.

Campaign - Questions and Misc. Fields

This page is used to define the following type of information:

- An order's campaign can define questions to be posed to customers when an order is taken. For example, you could ask the customer "marketing survey" questions (e.g., please rate our service, how do you heat your home?, etc.).
- An order's campaign can also be setup to capture additional fields to be updated on the order's person / account / premise when the order is completed. For example, you could indicate that the account's override due date and automatic payment options should be captured when an order is taken.
- An order's campaign can also be setup to pose eligibility-oriented questions that qualify the customer for packages of goods and services. For example, you might have a campaign with packages that can only be selected if the customer commits to a year's worth of service.

FASTPATH:

Refer to [Designing Campaigns and Packages](#) for information describing how to design this type of information for your campaigns.

Open this page using **Sales & Marketing, Campaign** and navigate to the **Question & Misc Fields** tab.

Description of Page

WARNING:

This information is not intuitive; we strongly recommend that you follow the guidelines under [Designing Campaigns and Packages](#) before attempting to enter this information.

Campaign is the user-defined code that uniquely identifies the campaign. The campaign's description appears adjacent.

The **Questions & Misc Fields** scroll contains one row for each question / miscellaneous field captured on this campaign's orders. The following fields are used:

- **Prompt on Order** contains the prompt that is shown to the user when the **order** is taken. Refer to [Determine The Properties Of Every Miscellaneous Field](#) for examples.

- **Brief Description** is simply a brief description of the question / miscellaneous field.
- **Sort Sequence** controls the order in which the question appears on the order.
- **Applicability** controls whether the field is Optional , Required, or Only Applicable on Package.
 - A value of Required means the order taker must enter a valid value before packages are displayed for selection.
 - A value of Optional means the order taken can leave the field blank prior to package selection. You can make an Optional field Required on individual packages.
 - A value of Only Applicable on Package is used for fields that are only captured for specific packages. Fields of this type are suppressed prior to package selection. When you setup a [package](#), you indicate if the field is applicable (if so, the user is only prompted for the field if the package is selected).
- **Type of Response** controls where the field is stored when the order is completed and how it is validated. You have two options: Characteristic or Column.
 - If a field is a Characteristic, you must define which entity the characteristic value is to be stored on when the order is completed (Person, Account, Premise or Order). You must also define the **Characteristic Type** as this controls the characteristic value entered by the user.
 - If a field's value resides in a Column (as opposed to a characteristic value), you must define the [column reference](#). A field's **Column Reference** controls three things:
 - How the field's value is retrieved. A field's value is retrieved when an existing person / account / premise is referenced on an order.
 - How the field's value is validated. A field's value is validated before package eligibility is determined and before the order is completed.
 - How the field's value is posted (i.e., updated on the database). A field's value is posted when an order is completed.

FASTPATH:

Refer to [Extract Column References From Miscellaneous Fields](#) for more information about column references.

- If a field's value resides in a Column (as opposed to a characteristic value), you must also define whether the question / field is dependent on the order referencing an account or premise. You do this by populating **Question Dependency** with one of the following values:
 - Select Must Have Account if this question / field should only appear if the order references an account (new OR existing).
 - Select Must Have Premise if this question / field should only appear if the order references a premise (new OR existing).
 - Select No Dependency if this question / field should always appear.

FASTPATH:

Refer to [Determine Account / Premise Dependencies For Column References](#) for more information.

- **Default Column Value / Default Char Value** controls whether the order taker is supplied with a default value when an order is created. Note well: for Optional and Only Applicable on Package fields, you can specify a different default value on each package.

Campaign - Algorithms

This page defines plug-in algorithms that are executed for orders associated with this campaign. Open this page using **Menu** > **Sales & Marketing** > **Campaign** > **Search** and navigate to the **Algorithms** page.

Description of Page

Campaign is the user-defined code that uniquely identifies the campaign. The campaign's description appears adjacent.

The grid contains **Algorithms** that control campaign-oriented functions. You must define the following for each plug-in algorithm:

- Specify the **System Event** with which the algorithm is associated (see the table that follows for a description of all possible events).
- Specify the **Sequence** and **Algorithm** for each **System Event**. You can set the **Sequence Number** to 10 unless you have a **System Event** that has multiple **Algorithms**. In this case, you need to tell the system the **Sequence** in which they should execute.

You can define algorithms for the following **System Events**:

System Event	Optional / Required	Description
Campaign Eligibility	Required	<p>A campaign's eligibility algorithms control two things:</p> <ul style="list-style-type: none"> - Whether the campaign appears in the Applicable Campaigns Zone. This content zone suggests possible campaigns for the current customer displayed on control central. You might want to use this zone if you have different campaigns that are offered to different types of customers. Refer to Real-time Marketing of Additional Services to a Customer for an example of how this content zone can be used to "up sell" additional services. - Whether the campaign appears on an order's eligibility tree. Campaigns that appear in this tree are alternate campaigns that may be used on an order. Refer to Real-time Marketing of Services to a Prospect for an example of how an order's eligibility tree can contain alternate campaigns for an order. <p>Refer to The Big Picture Of Campaign Eligibility for information about these algorithms.</p>
Order Completion	Optional	<p>When an order is completed for this campaign, algorithms plugged into this spot are called to do additional work (e.g., create a customer contact). You need only specify this type of algorithm if you require additional work to be performed when an order is completed for this campaign.</p>

Campaign - Package

A package controls the various types of service agreements that will be created if the customer selects the package. This page summarizes all packages that may be selected on orders associated with this campaign. Open this page using **Menu > Sales & Marketing > Campaign > Search** and navigate to the **Package** page.

Description of Page

Campaign is the user-defined code that uniquely identifies the campaign. The campaign's description appears adjacent.

The grid contains an entry for every package associated with this campaign. To view or change a package, press the adjacent go to button (which will transfer you to [Package - Main](#)). To add a new package, use the **Campaign** context menu to transfer to [Package - Main](#) in add mode.

Maintaining Packages

After a user enters basic information about a customer on an [order](#), they are shown the various packages that may be offered to the customer. A package controls the various types of service agreements that will be created if the customer selects the package.

If the customer elects to take a package, the system sets up / updates the "V" (along with all of the ancillary things that happen when service is initiated, e.g., field activities are created).

The topics in this section describe the package transaction.

FASTPATH:

Refer to [The Big Picture of Campaigns, Packages and Orders](#) for general information about packages. Refer to [The Big Picture Of Package Eligibility Rules](#) for a discussion of how to control which packages can be used for different types of customers. Refer to [Designing Campaigns and Packages](#) for guidelines describing how to design your packages.

NOTE:

An order can be completed without selecting a package. It is possible to use the order transaction to simply create / update persons and accounts. Refer to [Campaigns Without Packages](#) for more information.

Lifecycle of a Package

The following diagram illustrates the lifecycle of a package.

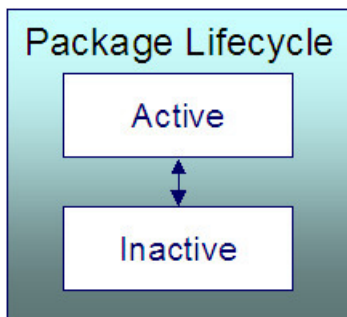

Active An Active package may be selected on an order.

Inactive By Inactivating a package, you are preventing it from being selected on future orders.

Package - Main

This page is used to define basic information about a package.

FASTPATH:

Refer to [The Big Picture of Campaigns, Packages and Orders](#) and [Designing Campaigns and Packages](#) for more information.

Open this page using **Menu > Sales & Marketing > Package > Search**.

Description of Page

Package contains a concatenation of basic information about the package. **Package ID** is the system-assigned unique identifier of the package. These values only appear after the order is added to the database.

Use **Campaign** to define the campaign to which this package belongs.

Use **Description** and **Long Description** to describe the package.

Status defines the state of the package. Refer to [Lifecycle of a Package](#) for information about the valid values and the state transition rules.

The tree at the bottom of the page summarizes the information that appears on the remaining tabs. You can click on a hyperlink to transfer you to the appropriate tab with the relevant information displayed.

Package - SAs To Create

This information on this page controls the type of service agreement(s) / service point(s) that are created if this package is selected on an order.

FASTPATH:

Refer to [The Big Picture of Campaigns, Packages and Orders](#) and [Designing Campaigns and Packages](#) for more information.

Open this page using **Sales & Marketing, Package** and navigate to the **SAs To Create** tab.

Description of Page

Package contains a concatenation of basic information about the package. **Package ID** is the system-assigned unique identifier of the package. These values only appear after the order is added to the database.

WARNING:

This following information is not intuitive; we strongly recommend that you follow the guidelines under [Designing Campaigns and Packages](#) before attempting to enter this information.

The **SAs To Create** scroll contains one row for every service agreement that will be created if this package is selected on an order. The following fields are used:

- **CIS Division** and **SA Type** define the [type of service agreement](#) to be created.
- **Start Option** controls how the system will populate the new service agreement with default values. Refer to [start options](#) for more information.
- **SP Type** defines the type of service point that will be created / reused. Refer to [Designing SP Types](#) for more information.
- **Start Method Algorithm** controls how the system creates the new service agreement and service point. Refer to [Determine The Method Used To Create Service Agreements](#) for more information.
- **Create Proposal SA** controls if the new service agreement is a real or a proposal SA. This switch only appears if the quotation Contract Management module is not [turned off](#). Refer to [Proposal Service Agreements Must Exist](#) for more information.

Package - Questions & Misc Fields

It is possible to design a campaign so that the user is prompted for additional information when a package is selected on an order. This page is used to define how the package overrides the questions and miscellaneous fields defined on the [campaign](#).

FASTPATH:

Refer to [The Big Picture of Campaigns, Packages and Orders](#) and [Designing Campaigns and Packages](#) for more information.

Open this page using **Menu > Sales & Marketing > Package > Search** and navigate to the **Questions & Misc Fields** page.

Description of Page

Package contains a concatenation of basic information about the package. **Package ID** is the system-assigned unique identifier of the package. These values only appear after the order is added to the database.

Campaign contains a concatenation of basic information about the campaign.

WARNING:

The following information is not intuitive; we strongly recommend that you follow the guidelines under [Designing Campaigns and Packages](#) before attempting to enter this information.

The grid contains one row for every [Questions & Misc Field](#) defined on the **Campaign**. You need only modify this information if this package behaves differently than the campaign (e.g., a field is required on the package, but optional on the campaign). To override a field on this package, turn on the **Override** switch and change the appropriate fields. There are several restrictions in respect of what can be overridden as described below:

- If a question / miscellaneous field is Required on the campaign, no fields may be overridden on the package.
 - If a question / miscellaneous field is Optional on the campaign, you may override all field values. However, if the package has been used on a Completed order, you may not change its **Applicability** to be Required.
 - If a question / miscellaneous field is designated as only applicable on package on the campaign, you should designate its applicability as Required, Optional or Not Used On This Package. If the field is either Required or Optional on this package, you may also override the other field values. Please note that if the package has been used on a Completed order, you may not change its **Applicability** to be Required.
-

FASTPATH:

Please refer to the Description of Page that appears under [Campaign - Questions & Misc Fields](#) for a description of the fields on the page.

Package - Eligibility

This page is used to define the conditions under which a package can be selected on an order.

FASTPATH:

Refer to [The Big Picture Of Package Eligibility](#) and [Determine Package Eligibility Rules](#) for more information.

Open this page using **Menu > Sales & Marketing > Package > Search** and navigate to the **Eligibility** page.

Description of Page

Package contains a concatenation of basic information about the package. **Package ID** is the system-assigned unique identifier of the package. These values only appear after the order is added to the database.

WARNING:

The following information is not intuitive; we strongly recommend that you follow the guidelines under [The Big Picture Of Package Eligibility](#) and [Determine Package Eligibility Rules](#) before attempting to enter this information.

The **Eligibility Criteria Group** scroll contains one entry for each group of eligibility criteria. The following fields may be defined for each group:

- Use **Sequence** to control the relative order in which the group is executed when the system determines if the package can be selected on an order (smaller numbers are executed before larger numbers).
- Use **Description** and **Long Description** to describe the criteria group.
- Use **If Group is True** to define what should happen if the eligibility criteria (defined in the following grid) return a value of True.
 - Choose Eligible if this package can be selected on the order.
 - Choose Ineligible if this package cannot be selected on the order.
 - Choose Check Next Group if the next criteria group should be checked.
- Use **If Group is False** to define what should happen if the eligibility criteria (defined in the following grid) return a value of False.
 - Choose Eligible if this package can be selected on the order.
 - Choose Ineligible if this package cannot be selected on the order.
 - Choose Check Next Group if the next criteria group should be checked.

The grid that follows contains the package's eligibility criteria. Think of each row as an "if statement" that can result in the related eligibility group being True or False. For example, you might have a row that indicates the customer is eligible for the package if their customer class is residential. The following bullets provide a brief description of each field on an eligibility criterion. Please refer to [Defining Logical Criteria](#) for several examples of how this information can be used.

- Use **Sequence** to control the order in which the criteria are checked.
- Use **Criteria Field** to define the field to compare:
 - Choose Field if you want to compare a response to a question / miscellaneous field to a given value. Push the adjacent search button to select the field.
 - Choose Algorithm if you want to compare anything other than a response to a question / miscellaneous field. Push the adjacent search button to select the algorithm that is responsible for retrieving the comparison value.
- Use **Criteria Comparison** to define the method of comparison:
 - Choose Algorithm if you want an algorithm to perform the comparison and return a value of True, False or Insufficient Data.
 - Choose any other option if you want to compare the **Criteria Field Type** using a logical operator. The following options are available:
- Use >, <, =, >=, <=, <> (not equal) to compare the **Criteria Field Type** using standard logical operators. Enter the comparison value in the adjacent field.
- Use In to compare the **Criteria Field Type** to a list of values. Each value is separated by a comma. For example, if a field value must equal 1, 3 or 9, you would enter a comparison value of 1,3,9.
- Use Between to compare the **Criteria Field Type** to a range of values. For example, if a field value must be between 1 and 9, you would enter a comparison value of 1,9. Note, the comparison is inclusive of the low and high values.

- The next three fields control whether the related logical criteria cause the eligibility group to be considered True or False:
 - Use **If True** to control what happens if the related logical criterion returns a value of True. You have the options of Group is true, Group is false, or Check next condition. If you indicate Group is true or Group is false, then the package will be judged Ineligible or Eligible based on the values defined above in **If Group is False** and **If Group is True**.
 - Use **If False** to control what happens if the related logical criterion returns a value of False. You have the options of Group is true, Group is false, or Check next condition. If you indicate Group is true or Group is false, then the package will be judged Ineligible or Eligible based on the values defined above in **If Group is False** and **If Group is True**.
 - Use **If Insufficient Data** to control what happens if the related logical criterion returns a value of "Insufficient Data". You have the options of Group is true, Group is false, or Check next condition. If you indicate Group is true or Group is false, then the package will be judged Ineligible or Eligible based on the values defined above in **If Group is False** and **If Group is True**.

Package - Instructions

This page is used to define special instructions that should be presented to the user when they select this package. This information appears on the [Order - Package Confirmation](#) page.

FASTPATH:

Refer to [Determine If Additional Instructions Are Needed](#) for more information.

Open this page using **Menu > Sales & Marketing > Package > Search** and navigate to the **Instructions** page.

Description of Page

Package contains a concatenation of basic information about the package. **Package ID** is the system-assigned unique identifier of the package. These values only appear after the order is added to the database.

The grid contains a row for each instruction to be presented to the user when they select a package. The following fields are used:

- Use **Sort Sequence** to control the relative order of the instruction.
- Use **Display Icon** to control the icon that prefixes the instruction. Refer to [Display Icons](#) for more information.
- Use **Description** to define the text of the instruction.

The Big Picture of Program Management

The program management functionality satisfies many diverse requirements. For example, you can use this functionality to:

- Market your products and/or services to customers and measure the success of your efforts.
- Encourage customers to enroll in various sales and marketing initiatives. For example, you can use program management to organize a campaign to encourage customers to participate in a conservation program, or to sign up for special contract options.
- Set up marketing surveys and record your customer's responses.
- Assign representatives to accounts.
- And more...

The topics in this section provide more information about the program management functionality.

The Big Picture of Initiatives, Leads, and Representatives

Three objects are at the heart of the program management functionality: **Initiatives**, **Leads**, and **Representatives**.

- An **initiative** defines a structured campaign that outlines the efforts to encourage customers to participate in a program targeted at a specific market segment.
- A **lead** is an instance of an initiative for targeted customers.
- There are two types of Representatives:
 - A **Sales Representative** is a user or group of users who can be assigned to follow up or manage leads. This representative is also responsible to sell or encourage the customer to participate in a program.
 - A **Third Party Representative** is a third party (typically external) who can receive assignments to perform specific tasks within a lead; such as, undertaking a visit to a property to perform an inspection, and installation work)

The topics in this section provide background information about these objects.

The Big Picture of Initiatives

An initiative defines a structured campaign designed to encourage customers to participate in a program. An initiative can:

- Target a market segment by specifying criteria that must be satisfied before leads are generated for customers.
- Ensure that customers are still eligible to participate in a program at sign up or enrollment time.
- Define a structured marketing effort for the events or actions that should take place during the life of a lead to encourage a customer to participate in the program.
- Define whether the lead is related to other objects (such as, the premise) in addition to the account.
- Contain sub-initiatives. Together, an initiative and its subsidiary initiatives form an initiative hierarchy. This supports reporting purposes and the analysis of the success of different market segments and marketing efforts.

Refer to [Maintaining Initiatives](#) for more information.

About Initiative Hierarchies

Initiatives form an initiative hierarchy when one initiative is configured as a sub-initiative to a parent initiative. An initiative hierarchy can be used when a program is targeted at several market segments, or when different market segments each require a unique marketing effort to be executed. Initiative hierarchies can be up to five levels deep.

The following is a general example of a multi-level initiative hierarchy:

- Level 1 could be a “strategy” initiative.
- Level 2 could contain multiple campaigns. Each campaign can have a different way of marketing the strategy.
- Level 3 could define multiple marketing efforts. Each effort can have a different method for marketing the campaign.
- Level 4 could contain market segments that are the targets of a marketing effort.

NOTE: The terms used above are just for the example. Your implementation would define the actual terms used for the levels in an initiative hierarchy.

A **parent initiative** may be set up for reporting purposes, in which case you could choose to configure the initiative so that no leads are generated for it. For example, a “strategy” may not have eligibility criteria or lead event type profile defined against it. It may simply have sub-initiatives to define segments, and those segments could be the initiatives for which leads

are generated. Reporting is able to be performed at the multiple levels in order to summarize the effectiveness of the sub-initiatives.

The Components of an Initiative

The topics in this section provide information about the components of an initiative.

About Initiative Eligibility Criteria

Each initiative can define its target market by specifying the criteria that must be satisfied before a customer is invited to participate in a program. It can also confirm that the customer is still eligible to participate in a program at sign up or enrollment time. An initiative may have zero, one, or many eligibility criteria. Each customer is subjected to these criteria to determine whether they will have a lead generated for them for the initiative and/or whether they are still eligible to sign up or enroll into a program.

Designing these criteria can be easy or time-consuming; it all depends on the complexity of your business rules. The base product provides a number of initiative eligibility criteria types. Most of them perform comparisons based on a specific field; for example, one of the criteria types checks whether an account has submitted a rebate claim for a specific conservation program. Some types of eligibility criteria could simply check whether or not a specific condition is true. For instance, a base-supplied eligibility criteria business object checks that there is no active credit and collection process for the account.

Other types of eligibility criteria perform comparisons with scalar values (such as, a number of days, number of kwh) or with derived values (such as, attributes of an account). The base product provides a Freeform Criteria business object that can be used for these purposes. This business object provides flexibility in that the value to supply in the comparison field is driven by a Derive Value Algorithm Type. A number of these algorithm types are delivered with this business object. Your implementations can add to these algorithm types as needed.

Your implementation can decide to use specific criteria business objects (base-supplied and/or implementation-specific), extend the base-supplied Freeform Criteria business object, or a mixture of both. Refer to [Designing Initiative Eligibility Criteria](#) for more details.

To set up an eligibility criterion, you must define the following:

- When the eligibility criterion should be executed - also called criteria execution point
- The field to be compared
- The comparison method

For the **criteria execution point**, the options include:

- Prior to a lead being generated for a customer
- Prior to the customer being signed up or enrolled into a program
- Both of the above

For the **field to be compared**, you can execute an algorithm to:

- Retrieve a field value or values from someplace else in the system (such as, the customer class or types of services associated with the customer)
- Derive a value based on some data from someplace else in the system (such as, the number of days since the last lead was created for the customer)

For the **comparison method**, you select the operator to perform the comparison on the field to be compared. The result from the algorithm will be TRUE, FALSE, or INSUFFICIENT DATA. Each of these results should specify the next action. The valid actions include:

- Indicate that the customer is eligible
- Indicate that the customer is not eligible

- Check the next condition
- Issue an error (this option is only available for Insufficient Data)

Refer to [Defining Eligibility Criteria for an Initiative](#) for more information about setting up eligibility criteria on an initiative.

About Related Object Criteria

Each initiative can define its target market by specifying the criteria that must be satisfied before a customer is invited to participate in a program (see [About Initiative Eligibility Criteria](#) for more information). An initiative may also be targeted at a specific entity (or related object) for that customer; for example, assume a customer has two properties in two different states - one in State A and one in State B. The customer may only be invited to participate, or be eligible, for a program for their specific property located in State A. In this situation, each eligible customer may then be subjected to Related Object Criteria following the execution of Initiative Eligibility Criteria to determine which of their properties are eligible to participate in a program (meaning, have one lead generated just for the account if one of their properties meets the criteria or a lead generated for each of the customer's eligible properties).

An initiative defines the related object(s) to associate with leads via the Object Nomination algorithm on the initiative business object. The lead generation process executes the object nomination algorithm after executing initiative eligibility criteria. The base-supplied Initiative parent business object (C1-Initiative) is configured with an object nomination algorithm that retrieves the premises that are associated with the account's active and pending start service agreement's service points. The algorithm applies the related object criteria (configured on the initiative) to each premise and if the premise is deemed eligible, it is returned as a related object for the lead.

Designing related object criteria can be easy or time-consuming. It all depends on the complexity of your business rules. The base product provides examples of related object criteria that looks for one or more premises to associate with a lead. One example checks for premises with a specific service point type. Another looks for a premise using its geographic value. For additional ways to find premises to link to a lead, implementations can either add specific related object criteria business objects (similar to the base samples) or extend the base-supplied Freeform Premise Criteria business object. The Freeform Premise Criteria business object provides flexibility in that the value to supply in the comparison field is driven by a Derive Value Algorithm Type. A number of these algorithm types are delivered with this business object. Your implementation can add to these algorithm types as needed. Refer to [Designing Related Object Criteria](#) for more details.

When you set up a related object criterion, you must define two things:

- The field to be compared.
- The comparison method.

For the **field to be compared**, you can execute an algorithm to retrieve a field value or values from someplace else in the system; for example, retrieve a premise's service point types for which the customer has service.

For the **comparison method**, select the operator to perform the comparison on the field to be compared. The result from the comparison will be TRUE, FALSE, or INSUFFICIENT DATA. Each of these results should specify the next action. The valid actions include:

- Indicate that the related object is eligible
- Indicate that the related object is not eligible
- Check the next condition
- Issue an error

Refer to [Defining Related Object Criteria for an Initiative](#) for more information.

Examples of Initiative Criteria

The following is an example of how to set up initiative criteria.

Initiative: Smart Rate Program For Residential Customers

The program targets summertime pricing for residential customers. Customers are required to reduce energy use between 2 PM and 7 PM for no more than 15 summer days, which are referred to as smart days. A higher rate is charged during this time period. A discounted rate is applied for all other times during the season.

Initiative Eligibility Criteria

To be eligible for this initiative, the account must be a residential account with an average daily usage that is more than 10 kWh, not currently on a smart rate program, and is on either the ERES1 or ERES2 rate schedule. The account must also not have any active credit and collection process.

Sequence	Description	Criteria Field Algorithm	Operator	Comparison Value	If True	If False	If Insufficient Data	Criteria Execution Point
10	Residential customers	Retrieve Customer Class (Define an algorithm instance for base algorithm type C1-ICGETACEL, Retrieve account attribute)	=	R	Check next condition	Not Eligible	Not Eligible	Both (lead generation and enrollment)
20	Average daily usage > 10 kWh	Retrieve average daily kWh usage (Define an algorithm for base algorithm type C1-ICGETAVSQ, Retrieve average service quantity)	>	10	Check next condition	Not Eligible	Not Eligible	Both (lead generation and enrollment)
30	Not on a smart rate program	Retrieve all contract options (Use base algorithm C1-ICGETCOPT)	=	295076574659 (Contract option for smart day events)	Not Eligible	Check next condition	Not Eligible	Both (lead generation and enrollment)
40	Account is current	Check if Account Is Current (Use base	=	true	Check next condition	Not Eligible	Not Eligible	Both (lead generation and enrollment)

Sequence	Description	Criteria Field Algorithm	Operator	Comparison Value	If True	If False	If Insufficient Data	Criteria Execution Point
		algorithm C1-ICCHKACCU)						
50	Active service on eligible rate	Retrieve all active rates (Use base algorithm C1-GETACTVRT)	IN	ERES1, ERES2	Eligible	Not Eligible	Not Eligible	Both (lead generation and enrollment)

Related Object Criteria

If the account is eligible, the premise(s) associated with the account's active and pending start service agreement's service points of type E-RES will be linked to the lead as related object(s).

Sequence	Description	Criteria Field Algorithm	Operator	Comparison Value	If True	If False	If Insufficient Data
10	Premises with E-RES (electric residential) service points	Retrieve Premise SP Types (Base algorithm C1-ICPRMSPTY)	=	E-RES	Eligible	Not Eligible	Not Eligible

About the Lead Event Type Profile

Each initiative can define a structured marketing effort for the events or actions that should take place during the life of a lead to encourage a customer to participate in a program. Each event or action is defined by a Lead Event Type. For example, one event could be that a letter or an email is sent to a customer. The collection and sequencing of lead event types defined on an initiative is referred to as the Lead Event Type Profile.

Refer to [Creating Initiatives](#) and [Maintaining Initiatives](#) for more information on setting up and maintaining the Lead Event Type Profile on an initiative.

About the Initiative Log

Every initiative has a log holding its history. Entries are added to the log when meaningful events occur, for example:

- When an initiative is created.
- When an initiative's status changes (e.g. transitions to the active, accumulate statistics, inactive states).
- When lead related background processes are submitted for execution.
- When users want to manually add log entries as desired.

The Lifecycle of an Initiative

The following diagram shows the possible lifecycle of an Initiative:

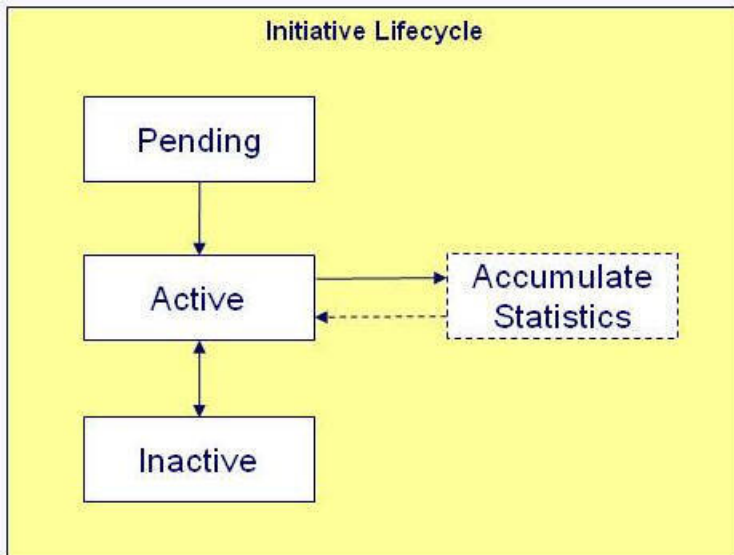

Pending state: An initiative starts out in a pending state.

Active state: An initiative is transitioned manually by a user to the active state. Leads can only be generated for an initiative in an active state.

Accumulate Statistics state: A user or the system may transition an active initiative to a periodically transitioning accumulate statistics state. During this state, statistics for the initiative are accumulated prior to returning back to the active state.

Inactive state: An initiative may be transitioned manually by a user to the inactive state when they want to deactivate the initiative either temporarily or permanently. A user can manually place the initiative back to the active state from the inactive state.

Refer to [Maintaining Initiatives](#) for more information.

Initiative Information Can Be Overridden

“Initiative info” is the concatenated string of information that summarizes an initiative throughout the system. The base-package logic constructs this string by concatenating the following information:

- Initiative description
- Status of the initiative
- Start date and end date (if available) of the initiative

If you'd prefer a different info string, you can develop a new algorithm and plug-it in on the Initiative's maintenance object.

The Big Picture of Leads

A lead is an instance of an initiative for a targeted customer. A lead may contain events or actions that are there to encourage a customer to participate in a program.

Refer to [Maintaining Leads](#) for more information about working with Leads.

How Leads Are Created

Leads are created as follows:

- The system can generate a lead, or leads, for each customer that satisfies the initiative eligibility criteria and/or related object criteria that is defined on an initiative.
- Users can manually create a lead at their discretion.

Refer to section [Creating Leads from an Initiative](#) and [Manually Creating a Lead](#) for more information.

The Components of a Lead

A lead has two components: A **Lead Event** and a **Lead Log**.

Lead Event

A lead has one or more lead events. These events are the actions designed to encourage a customer to participate in a program. For example, one event could be that a letter or an email is sent to a customer.

Refer to [The Big Picture of Lead Events](#) for more information.

Lead Log

Every lead has a log holding its history. Entries are added to the log when meaningful events occur, for example:

- When a lead is created
- When a lead's status changes (e.g. transitions to the active, successful or discarded state)
- When a lead event executes
- Users can manually add log entries as desired.

The Lifecycle of a Lead

The following diagram shows the possible lifecycle of a Lead:

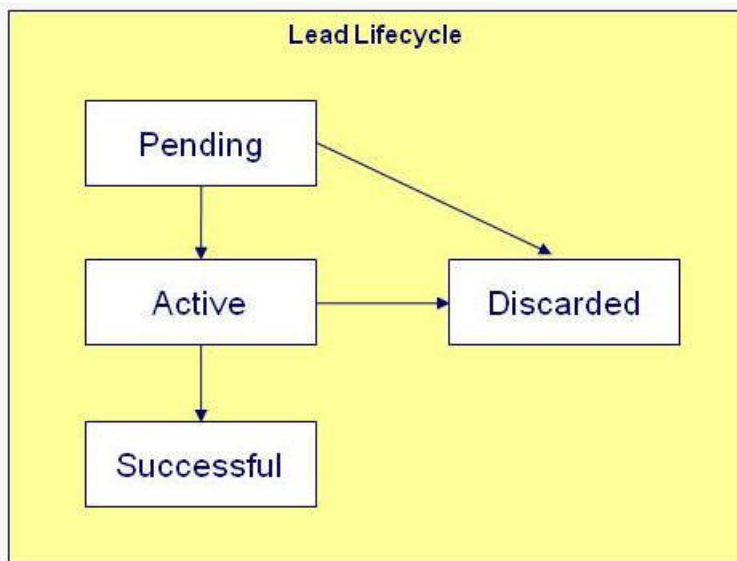

Pending state: Leads can be created in either the **Pending** or **Active** state. By generating them in the **Pending** state, you can verify the targeted customers before actively marketing the initiative.

Active state: Leads can be created in either the **Pending** or **Active** state. When a lead is created or transitioned to the **Active** state, lead events are created to encourage the customers to participate in the initiative. For example, one event could be that a letter or an email is sent to a customer. The lead events and the sequence in which they occur are defined on the initiative's lead event type profile. The lead remains in the active state while it is being actively marketed to the customer.

Successful state: The system infers that a lead has succeeded by the creation of other data in the system, at which time the lead transitions to the **Successful** state. For example:

- If an active lead for a customer is related to a rebate claim conservation program, the lead is determined to be successful when that rebate claim is filed for the customer.
- If an active lead for a customer is related to a contract option, the lead is determined to be successful when the customer's service agreement is linked to that contract option.
- If an active lead for a customer is related to a campaign, the lead is determined to be successful if a completed order exists for the customer for the campaign.
- If an active lead is assigned to a third party representative (to perform one or more tasks), the lead is determined to be successful if the Notify Third Party lead event is completed.

Discarded state: An unsuccessful lead transitions to the **Discarded** state after a certain amount of time has passed, as defined on the initiative. If the initiative does not specify a time period, the lead remains in the active state until a user manually discards it.

Refer to [Maintaining Leads](#) for more information.

Advanced Analysis of Leads

Leads can be sent to an external system (such as Oracle DataRaker) for advanced analysis prior to activating the lead.

The base product provides Advanced Analysis System Lead (C1-AdvancedAnalysisLead) business object for this purpose. Its lifecycle includes steps to send the lead to the external system and activate/discard the lead based on the result of analysis..

Additional configuration is needed in Program Management master configuration to enable external analysis/validation. See master configuration embedded help for more details.

The Lifecycle of a Lead with Advanced Analysis

The following describes the states of a Lead that is sent to an external system for advanced analysis prior to activation..

(Refer to the C1-AdvancedAnalysisLead business object to view the lifecycle diagram.)

Pending state: Leads can be created in either the **Pending** or **Ready for Extract** state. By generating them in the **Pending** state, you can verify the targeted customers before actively marketing the initiative.

Ready for Extract state: At this state, leads are ready to be sent to the external system for analysis. A monitor batch process is defined on this state, to ensure that leads in this state are transitioned only when the batch process runs.

Waiting for Analysis state: When a lead is transitioned to this state, an outbound message containing lead information is sent to the external system.

Error state: The lead is transitioned to this state if the system is unable to send the outbound message. Retry logic on this state will attempt to resend the lead to the external system. Leads in this state can also be **Discarded** if needed.

Active state: When a lead completes external analysis, the External Validation and External Activation Priority flags on the lead are updated. An inbound web service sends back the lead and transitions the lead into the **Active** state. An enter algorithm evaluates the External Activation Priority flag. If the lead is marked as being a priority for activation (based on settings in master configuration), the lead stays in the **Active** state. Otherwise, the lead is **Discarded**.

When a lead is in the **Active** state, lead events are created to encourage the customers to participate in the initiative. For example, one event could be that a letter or an email is sent to a customer. The lead events and the sequence in which they occur are defined on the initiative's lead event type profile. The lead remains in the active state while it is being actively marketed to the customer.

Successful state: The system infers that a lead has succeeded by the creation of other data in the system, at which time the lead transitions to the **Successful** state. For example:

- If an active lead for a customer is related to a rebate claim conservation program, the lead is determined to be successful when that rebate claim is filed for the customer.
- If an active lead for a customer is related to a contract option, the lead is determined to be successful when the customer's service agreement is linked to that contract option.
- If an active lead for a customer is related to a campaign, the lead is determined to be successful if a completed order exists for the customer for the campaign.
- If an active lead is assigned to a third party representative (to perform one or more tasks), the lead is determined to be successful if the Notify Third Party lead event is completed.

An enter algorithm on this state sends an outbound message, to notify the external system about lead success.

Discarded state: Leads that are evaluated as non-priority for activation are transitioned to this state. Unsuccessful leads also transition to this state after a certain amount of time has passed, as defined on the initiative. If the initiative does not specify a time period, unsuccessful leads remain in the **Active** state until a user manually discards it.

Refer to [Maintaining Leads](#) for more information.

Lead Information Can Be Overridden

“Lead info” is the concatenated string of information that summarizes a lead throughout the system. The base-package logic constructs this string by concatenating the following information:

- Initiative description
- Status of the lead
- Creation date/time of the lead.

If you'd prefer a different info string, you can develop a new algorithm and plug-it in on the Lead's maintenance object.

Leads Are Highlighted As Alerts

If you plug-in the appropriate alert algorithm (C1-OPENLDALR) on the Installation record, alert(s) will be shown for open leads associated with the person, account and premise in context. A separate alert is shown for each unique Lead that is in a non-final state. Each alert message shows the Lead's info string.

How and When Are Leads Activated

Leads are activated as follows:

- The system can generate a lead for each customer that satisfies the initiative eligibility criteria and/or related object criteria that is defined on an initiative. The leads can be created in either a Pending or Active state. These leads can then be activated by a background process when required by the user.
- Users can manually activate a lead at their discretion.

Refer to section [Creating Leads from an Initiative](#) and [Maintaining a Lead](#) for more information.

How are Leads Completed

The system infers that a lead has succeeded by the creation of other data in the system, at which time the lead transitions to the **Successful** state. For example:

- If an active lead is related to a rebate claim conservation program, the lead is determined to be successful when that rebate claim is filed for the customer.

- If an active lead is related to a contract option, the lead is determined to be successful when the customer's service agreement is linked to that contract option.
- If an active lead for is related to a campaign, the lead is determined to be successful if a completed order exists for the customer for the campaign.
- If an active lead is assigned to a third party representative, to perform one or more tasks, the lead is determined to be successful if the Notify Third Party lead event is completed.

Users can also manually transition a lead to the Successful state at their discretion. Refer to [Maintaining a Lead](#) for more information about working with Leads.

How Are Leads Discarded

When leads are sent to an external system for analysis prior to lead activation, a possible result of the analysis is that the lead is flagged as non-priority for activation. When this occurs, the lead is discarded.

Unsuccessful leads transition to the Discarded state after a certain amount of time has passed, as defined on the initiative. The initiative's lead event type profile can include an event that automatically discards a lead after a designated number of days. If the initiative does not specify this auto-discard event, the lead remains in the active state until a user manually discards it.

Some types of lead events can also trigger a lead to be discarded when specific conditions are met; for example, a lead that is assigned to a third party representative can be automatically discarded when the third party representative finds that the account is ineligible for the initiative. Refer to [The Lifecycle of a Third Party Representative](#) for more details.

In addition, automatic lead discards capture a lead discard reason. Lead event types that support auto-discard define their respective default lead discard reasons. Refer to [Setting Up Lead Event Types](#) and [Maintaining a Lead](#) for more information

Sign Up Options Can Be Overridden

The lead's Sign Up special action button performs the following:

- Displays a Sign Up UI map (if one exists) to capture additional inputs for sign up processing.
- Executes a Sign Up service script to process the sign up.
- Displays a confirmation map if the sign up is successful.

The Sign Up UI map and Sign Up service script can be overridden via options on the initiative's business object. Refer to [Overriding Initiative Sign Up Options](#) for more details.

The Big Picture of Lead Events

A lead has one or more lead events. These events are the actions designed to encourage a customer to participate in a program. For example, one event could be that a letter or an email is sent to a customer.

You define the number and type of events to be initially inherited by a lead by configuring the Lead Event Type Profile on an initiative. Refer to [About the Lead Event Type Profile](#) for more information.

A lead event can include one or more steps. The lead event type defines a list of step types, if applicable.

The topics in this section provide additional information about lead events.

How are Lead Events Created

If a lead is created in a Pending state, there are no lead events associated with the lead. It is only when leads are created in or transitioned to the Active state, that lead events are created for the lead. The initial number of events and when the events shall occur are inherited from the lead's initiative.

Some types of events can also get created as a result of special actions on the lead. For instance, when a lead process requires a third party representative to perform one or more tasks after signup, the Sign Up action on the Lead portal automatically creates the Notify Third Party lead event.

The Components of a Lead Event

A lead event can have one or more steps. The lead event's business object defines whether or not steps are applicable to that type of event. The corresponding lead event type defines the valid step types. For an example, refer to the Third Party Lead Event (C1-ThirdPartyLeadEvt) and Send Notification to Third Party Lead Event Type (C1-LETypeNotifyThirdParty) business objects provided in base.

Lead Event Log

Every lead event has a log holding its history. Entries are added to the log when meaningful events occur, for example:

- When a lead event is created.
- When a lead event's status changes (e.g. transitions to the completed or cancelled state).
- Details of the content sent (if applicable).
- Users can manually add log entries as desired.

The Lifecycle of a Lead Event

The following diagram shows the possible lifecycle of a Lead Event business object:

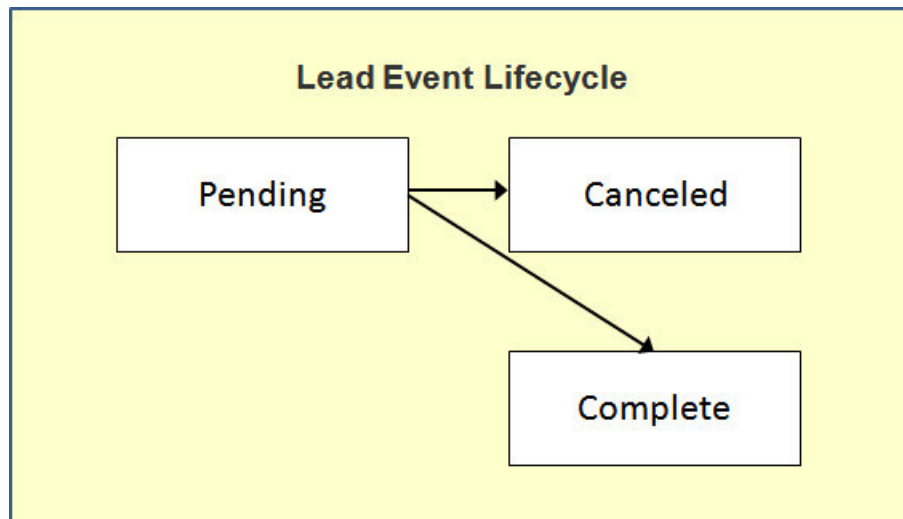

Pending state: Lead events are initially created in the Pending state. A lead event can take a number of paths after it is created; it all depends on how you've configured the system.

Complete state: A lead event contains a date when it should be activated. This is referred to as its trigger date. On this date, the system invokes the algorithm associated with the lead event to execute the event or action. A user may complete a pending event at their discretion.

Cancelled state: A pending event will be cancelled automatically by the system when a lead is canceled. A user may cancel a pending event at their discretion.

Refer to [Maintaining Lead Events](#) for more information.

The Lifecycle of a Third Party Lead Event

The following diagram shows the possible lifecycle of a Third Party Lead Event business object:

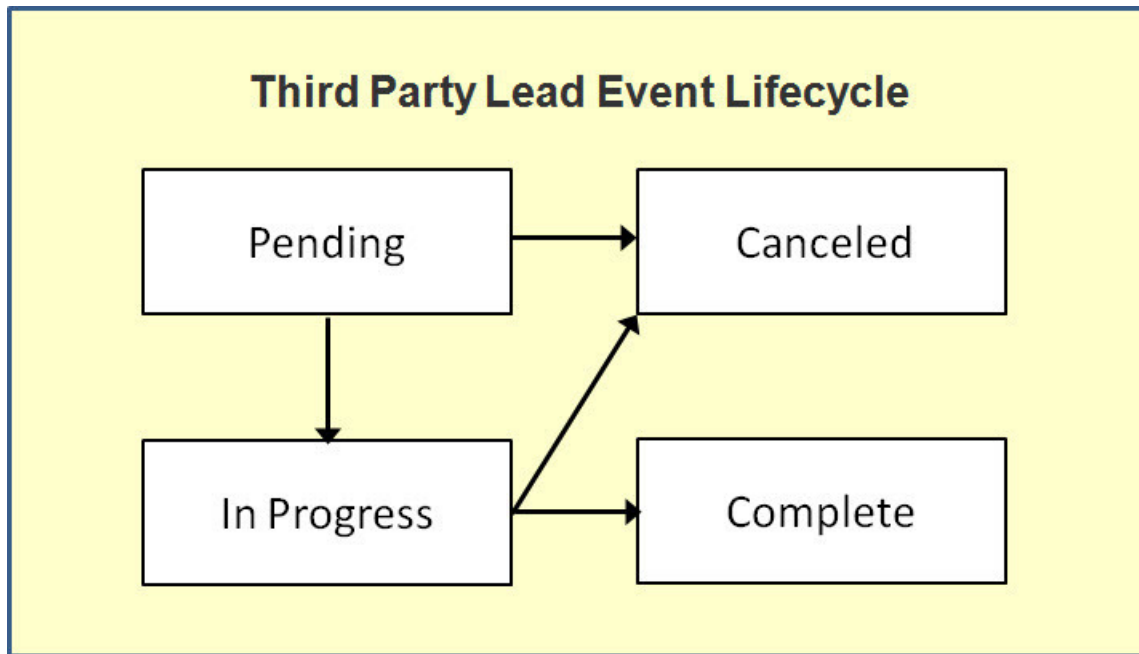

Pending state: Third party lead events are initially created in the Pending state. A third party lead event can take a number of paths after it is created; it all depends on how you've configured the system.

In Progress state: A third party lead event contains a date when it should be activated. This is referred to as its trigger date. On this date, the system invokes the algorithm associated with the lead event to execute the event or action. The lead event is set to In Progress and the lead event is sent to the third party representative.

Complete state: A third party lead event may be completed based on updates received from the third party. In most cases, the third party lead event is completed when all the event steps are complete. In addition, a user may complete an In Progress event at their discretion.

Cancelled state: A Pending or In Progress third party lead event will be cancelled automatically by the system when the lead is canceled. A user may cancel a Pending or In Progress event at their discretion.

Refer to [Maintaining Third Party Lead Events](#) for more information.

Lead Event Information Can Be Overridden

"Lead Event info" is the concatenated string of information that summarizes a lead event throughout the system. The base-package logic constructs this string by concatenating the following information:

- Lead event type description
- Status of the lead event
- Trigger date of the lead event

If you'd prefer a different info string, you can develop a new algorithm and plug-it in on the Lead Event's maintenance object.

Third Party Lead Event Step Information Can Be Overridden

The **Initiative Leads** zone on the **Third Party Representative** portal shows an event step information string for **Last Complete Step** and **Next Pending Step**. A base-package service script constructs this string by concatenating the following information:

- Step type description
- Intended Work Date/Time
- Completion Date/Time

You can override this by specifying an **Override Step Information Script** on the Program Management Master Configuration.

See [Program Management Master Configuration](#) for more details.

How and When Lead Events Are Activated

A lead event contains the date it should be activated; this is referred to as its trigger date. On this date, the Lead Event Periodic Monitor Process (a background process (C1-LDEVT)) invokes the algorithm associated with a lead event's event type. The algorithm, in turn, will decide on the state in which to leave the lead event.

If a user can't wait for the Lead Event Periodic Monitor Process real-time, they can click a button on Lead Event – Main to activate / trigger an event online in real-time. Refer to [Maintaining Lead Events](#) for more information.

You control how a lead event's trigger date is populated by configuring the Lead Event Type profile in an initiative. You indicate the number of days the lead event should be activated after the creation of the lead. Refer to [Maintaining Initiatives](#) for more information.

Activating Events Should Add a Log Entry

As described previously, a lead and lead event have a log holding a history of meaningful events in their lives. Most algorithms associated with a lead event's event type will add an entry to both the lead and lead event logs.

These log entries are more than just an audit trail as they also reference the objects that are created during execution. For example, if an algorithm creates a customer contact, the ID of the customer contact will be referenced on the log (and end-users will be able to drill down on the log entry to see the customer contact).

How Lead Events Are Cancelled

A pending lead event will be cancelled automatically by the system when the lead is canceled.

A user may cancel a pending lead event at their discretion. Refer to [Maintaining Lead Events](#) for more information.

A third party representative can also initiate the cancellation of a lead event. Refer to [The Lifecycle of a Third Party Lead Event](#) for more details.

The Big Picture of Sales Representatives

A sales representative is a group or individual who can be assigned to follow up and manage leads.

Individual sales representatives can be members of one or more groups, and they can be an internal user or an external party.

Groups can be used to control which sales representatives are allocated to the leads for an initiative. For example, you can set up a group whose sales representatives are responsible for industrial customers. Initiatives that target industrial

customers can then be configured so that this group is specified as the only one whose sales representatives can be assigned the initiative's leads.

Because many reports will aggregate information for all sales representatives in a group, you may choose to set up a sales representative group just for reporting purposes.

The topics in this section provide additional information about Sales Representatives.

The Lifecycle of a Sales Representative

The following diagram shows the possible lifecycle of a Sales Representative:

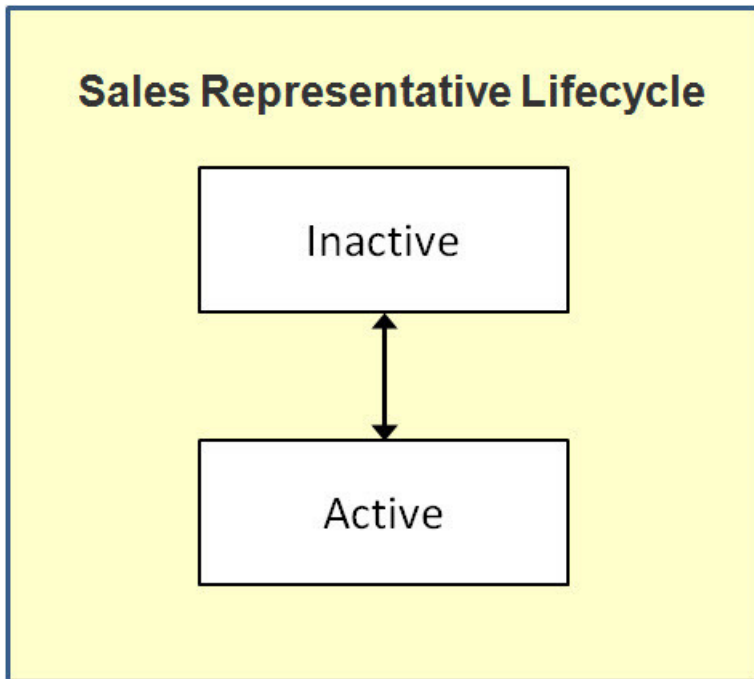

Active state: A Sales Representative starts out in an active state.

Inactive state: A Sales Representative may be transitioned manually by a user to the inactive state when they want to deactivate the Sales Representative either temporarily or permanently. A user can manually place the Sales Representative back to the active state from the inactive state.

Refer to [Maintaining Sales Representatives](#) for more information.

Sales Representative Log

Every Sales Representative has a log holding its history. Entries are added to the log when meaningful events occur, for example:

- When a Sales Representative is created
- When a Sales Representative's status changes (e.g. transitions to the inactive state)
- Users can manually add log entries (you might want to think of these as "diary" entries) as desired.

The Big Picture of Third Party Representatives

A third party representative is similar to a sales representative except that they are typically not internal employees and they have a different set of responsibilities.

Lead-related tasks may be outsourced to a third party representative who is better equipped to perform the work. These tasks may include pre-installation visits, energy audits, equipment installation, and equipment recycling. An initiative's lead event type profile defines whether or not lead-related work is sent to a third party representative.

Work is typically sent to a third party representative when a customer signs up for an initiative. The base product provides an online Sign Up action on active leads. This action creates a Third Party Lead Event that triggers the third party notification.

The third party representative is also responsible for providing updates to the system about the assigned leads. These updates can include event status updates, updates to important date/time information (e.g., completion date/time) and comments. This feedback enables users of the system to monitor the progress of leads and provide any necessary customer service.

Refer to the [The Lifecycle of a Third Party Lead Event](#) for more details on third party lead events.

The topics in this section provide additional information about Third Party Representatives.

The Lifecycle of a Third Party Representative

The following diagram shows the possible lifecycle of a Third Party Representative:

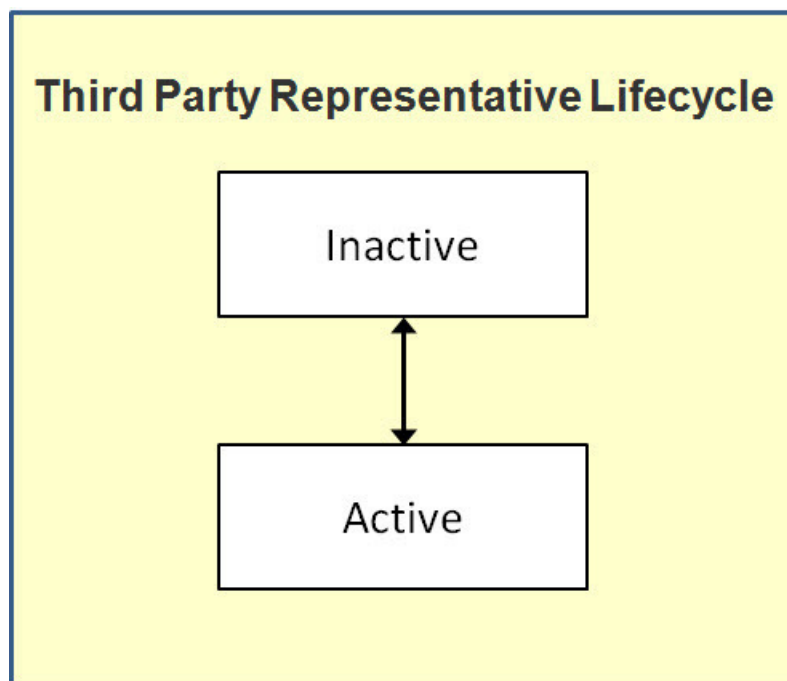

Active state: A Third Party Representative starts out in an active state.

Inactive state: A Third Party Representative may be transitioned manually by a user to the inactive state when they want to deactivate the Third Party Representative either temporarily or permanently. A user can manually place the Third Party Representative back to the active state from the inactive state.

Refer to [Maintaining Third Party Representatives](#) for more information.

Third Party Representative Log

Every Third Party Representative has a log holding its history. Entries are added to the log when meaningful events occur, for example:

- When a Third Party Representative is created.

- When a Third Party Representative's status changes (e.g. transitions to the inactive state).
- Users can manually add log entries as desired.

Maintaining Initiatives

An initiative defines a structured campaign that outlines the efforts to encourage customers to participate in a program targeted at a specific market segment.

Refer to [The Big Picture of Initiatives](#) for more information about initiatives.

Initiative Portal

You use the Initiative portal to maintain initiatives.

The **Main** page contains the following zones:

- **Initiative:** Displays the basic information about the initiative.
- **Initiative Eligibility Criteria Overview:** Displays initiative eligibility criteria associated with the initiative.
- **Related Object Criteria Overview:** Displays criteria for finding one or more related objects (such as, a premise) to link to a lead.
- **Initiative Hierarchy:** Displays the entire hierarchy of initiatives that the selected initiative is a part of.
- **Initiative Leads:** Displays the leads that are associated with the initiative.
- **Lead Processing:** Allows you to submit the lead generation or lead disposition batch process.

The **Statistics** page contains the following

- **Lead Summary by Representative:** Displays the summary of leads for the initiative hierarchy, grouped by representatives.
- **Initiative Leads:** Displays the leads that are associated with the initiative.
- **Lead Outcome Graph:** Displays the number of leads linked to the initiative hierarchy that entered the final state within the last 24 months.
- **Lead Statistics:** Displays statistics for the leads associated with the initiative.
- **Lead Monthly Statistics:** Displays statistics for the leads associated with the initiative on a monthly basis.
- **Unassigned Leads:** Displays leads that are not yet assigned to a sales representative and are not in a final state. (**Note:** Leads can be assigned to a sales representative in bulk.)

How To Perform Common Initiative Functions

The topics in this section describe how to perform common initiative functions from the Initiative portal.

Creating Initiatives

Use this procedure to create a new Initiative.

1. Select **Menu > Sales & Marketing > Initiative > Add.**
2. Select the business object that will define the initiative and click **OK.**
3. Enter the initiative's name, (short) description, detailed description, start date, and end date.
4. Specify if the initiative is a master or a subsidiary initiative.

- a) If the initiative is a **Subsidiary Initiative**, search for and select the initiative that is the parent to this initiative.
5. Specify whether the master initiative will participate in demand-side analytics processing through Contract Option Participation Analysis.
6. Specify whether or not leads can be generated for the initiative.
 - a) If leads can be generated, complete the options regarding communication channel and related object creation.
7. In the Third Party Notification section, specify the Lead Event Type to use to notify a third party. This lead event type is used when creating a third party notification lead event, if applicable, when a customer signs up or enrolls into a program.
8. In the Lead Reassignment Notification section, indicate how the system should respond if a lead is reassigned to another sales representative.
9. In the Statistics Notification section, specify how often, in hours, the statistics for the initiative should be updated.

A background process accumulates the statistics for an initiative when enough time has elapsed since the statistics were last updated. A user may also manually initiate the process to update the statistics for an initiative.
10. If this initiative will have leads, add lead event types in the Lead Event Type Profile section to define the events or actions that will occur during the lifetime of the lead to encourage the customer to participate in the initiative. To add lead event types in the Lead Event Type Profile section:
 - a) Assign an **Event Sequence** to each list entry.
 - b) Search for and select a **Lead Event Type** to indicate the type of lead event to generate for each list entry (for example send customer an email or create a customer contact).
 - c) Specify the number of **Days After Lead Creation** that the related lead event will be triggered.
11. Click **Save**.

Maintaining an Initiative

The topics in this section describe procedures for maintaining an initiative:

Allowable Record Actions on an Initiative

Use this procedure to maintain an initiative using standard record actions.

1. Select **Menu > Sales & Marketing > Initiative > Search**.
2. Enter your search criteria in the Initiative Query zone.
3. Click **Refresh**.
4. In the search results list, click the link for the initiative you want to maintain. The selected initiative opens in the Initiative portal.
5. Click the appropriate record action button:
 - **Edit** – Click the **Edit** button to edit the main attributes of an initiative. When you click **Save**, the system updates the record.
 - **Duplicate** – Click the **Duplicate** button to create a duplicate of the initiative being displayed. Before the new object is added to the database, a window appears asking you to enter the unique identifier of the new object. When you click **OK**, the system creates the record by copying the original record.
 - **Activate** – Click the **Activate** button to transition a pending or inactive initiative to the active state.
 - **Deactivate** – Click to **Deactivate** button to transition an active initiative to an inactive state.

- **Refresh Statistics** - Click the **Refresh Statistics** button to manually initiate the accumulation of the statistics for the initiative.
- **Delete** – Click the **Delete** button and click **OK** to delete the initiative from the database. Before you delete an initiative, the system verifies that the initiative is not referenced anywhere in the system. If it is, you cannot delete it. For example, if you attempt to delete an initiative, the system ensures the initiative has not been referenced on a lead, etc.

Defining Eligibility Criteria for an Initiative

Use this procedure to define eligibility criteria for an initiative. The following steps apply to each criterion.

Prerequisites: You must create an initiative that can have leads before you can define eligibility criteria for the initiative.

1. Select **Menu > Sales & Marketing > Initiative > Search**.
2. Enter your search criteria in the Initiative Query zone.
3. Click **Refresh**.
4. In the search results list, click the link for the initiative that you want to maintain. *(The selected initiative opens in the Initiative portal.)*
5. To define eligibility criteria for the initiative, click the **Add** link in the Initiative Eligibility Criteria Overview zone title bar. *(This zone is displayed for initiatives that can have leads.)*
6. Select the business object that will define the initiative criteria and click **OK**.

The base package provides a number of initiative eligibility criteria business objects. Each business object defines its valid comparison algorithm(s), operator(s), and value(s). Refer to the maintenance maps of these business objects for details. For more information about eligibility criteria types, refer to [About Initiative Eligibility Criteria](#).

7. Enter a sequence number, description, detailed description, and criteria execution point for the criterion.
8. Complete the Criteria Comparison section. Each business object defines the valid selections for: **Algorithm**, **Comparison Operator** and **Comparison Value**.
9. Complete the Comparison Results section. Specify the action for each possible comparison outcome - meaning, **If True**, **If False**, and **If Insufficient Data**.

Refer to the embedded help on the maintenance map for more details on these fields.

Refer to the embedded help on the maintenance map for more details on these fields.

10. Click **Save**.

Repeat steps 5 to 10 to add additional criterion for the initiative.

Defining Related Object Criteria for an Initiative

Use this procedure to define related object criteria for an initiative. The following steps apply to each criterion.

Prerequisites: You must create an initiative that can have leads before you can define related object criteria for the initiative.

1. Select **Menu > Sales & Marketing > Initiative > Search**.
2. Enter your search criteria in the Initiative Query zone.
3. Click **Refresh**.

4. In the search results list, click the link for the initiative you want to maintain. The selected initiative opens in the Initiative portal.
5. To define related object criteria for the initiative, click the **Add** link in the Related Object Criteria Overview zone title bar. *(This zone is displayed for initiatives that can have leads.)*
6. Select the business object that will define the initiative criteria and click **OK**.

The base package provides a number of related object criteria types that attempt to link an account's premise(s) to the lead. Each initiative criteria business object defines its valid comparison algorithm(s), operators and value(s). Refer to the maintenance maps of these business objects for details. For more information on eligibility criteria types, refer to [About Related Object Criteria](#).

7. Enter a sequence number, description, and detailed description for the criterion.
8. Complete the Criteria Comparison section. Each business object defines the valid selections for: **Algorithm**, **Comparison Operator**, and **Comparison Value**.
Refer to the embedded help on the maintenance map for more details on these fields.
9. Complete the Comparison Results section. Specify the action to take for each possible outcome of the comparison - meaning, **If True**, **If False**, and **If Insufficient Data**
Refer to the embedded help on the maintenance map for more details on these fields.
10. Click **Save**.

Repeat steps 5 to 10 to add additional criterion for the initiative.

Viewing Initiative Hierarchy

The Initiative Hierarchy zone on the Initiatives portal displays the hierarchy the selected initiative is a part of. By clicking on any initiative in the hierarchy, you will be navigated to the selected initiative.

Creating Leads from an Initiative

The topics in this section describe how to create leads from an Initiative.

Bulk Creation of Leads

Use this procedure to create leads in bulk.

1. Select **Menu > Sales & Marketing > Initiative > Search**
2. Enter your search criteria in the Initiative Query zone.
3. Click **Refresh**.
4. In the search results list, click the link for the initiative you want to maintain.
The selected initiative opens in the Initiative portal.
5. To create leads for the initiative, click **Lead Generation** on the Lead Generation and Disposition zone. This zone is displayed for initiatives in the active state, can have leads and allows a batch job to be submitted for the creation of leads.
 - Select the **Lead Status** to leave the created leads in. Valid values are Pending or Active. Creating leads in a pending state allows a user to confirm the lead population prior to activating these leads
 - Specify the **Number of Leads to Generate**. This may be used to create a sample set of leads to test the initiative's eligibility criteria.

- Specify the **Email Address**. You may optionally specify an email address if you want to be informed when the batch job completes

6. Click **OK**.

Uploading Leads

NOTE: This functionality is to be used on small volume uploads.

1. Select **Menu > Sales & Marketing > Initiative > Search**.
2. Enter your search criteria in the Initiative Query zone.
3. Click **Refresh**.
4. In the search results list, click the link for the initiative you want to maintain. The selected initiative opens in the Initiative portal.
5. To upload Leads for an initiative, click the **Lead Upload** link in the Initiative Leads zone title bar. This displays the Lead Upload page, which you can use to upload a CSV file containing account IDs for which leads will be generated.
6. Click **Submit**.

Managing Leads from an Initiative

The procedures in this section describe how to manage leads from an initiative.

Viewing Initiative Leads

The Initiative Leads zone is displayed on both the Main page and the Statistics page.

By default, the Initiative Leads zone is populated with all leads for the initiative (or initiative hierarchy group) for all sales representatives.

On the Statistics page, you can limit the set of leads using the Lead Summary by Representative zone. See [Viewing Lead Summary by Representative](#) for details.

The following is displayed in the result set for each lead:

- Basic **Lead** information for the initiative's lead. You can navigate to the lead by clicking on the lead.
- **Customer Information** related to the lead. You can navigate to the account related to the lead by clicking on the customer information.
- The **Last Complete Event**. You can navigate to the lead event by clicking on the last complete event for a lead.
- For open leads, the **Next Pending Event**. You can navigate to the lead event by clicking on the next pending event for a lead.
- The **Sales Representative** shows the representative assigned to the lead.

Activating, Deleting, and Discarding Leads for an Initiative in Bulk

Use the following procedure to activate, delete or discard leads for an initiative.

1. Select **Menu > Sales & Marketing > Initiative > Search**
2. Enter your search criteria in the Initiative Query zone.
3. Click **Refresh**.

4. In the search results list, click the link for the initiative you want to maintain.
The selected initiative opens in the Initiative portal.
5. Scroll, as needed, to the Lead Processing zone.
6. To activate, delete or discard leads for the initiative, click **Lead Disposition**. This allows a batch job to be submitted for the activation, deletion or discarding of leads.
 - Select the **Pending Lead Disposition** to indicate the action to take on pending leads. The possible actions are: Activate (pending leads), Delete (in case of erroneous generation), Ignore.
 - Select the **Active Lead Disposition** to indicate to action to take on active leads. The possible actions Ignore and Discard.
 - Select the **Discard Reason** to be used for any active leads that get discarded. The values are maintained on the Status Reason control table.
 - Specify the **Email Address**. You may optionally specify an email address if you want to be informed when the batch job completes
7. Click **OK**.

Viewing Initiative Statistics

The Statistics page displays statistical information about the leads of the current initiative in context. It shows the following:

- Lead counts by sales representative and status
- List of leads
- Graph of completed and discarded leads over a period of time
- Graph of leads by status
- Graph of active leads per sales representative
- Graph of open, completed and discarded leads over a period of time
- Graph of the top discard reasons over a period of time

The following sections describe these zones. You can also refer to each zone's embedded help for more details.

Viewing Lead Summary by Representative

The Lead Summary by Representative zone displays a summary of leads for the initiative (or initiative hierarchy group) by individual representative. If the Initiative is configured not have a sales representative, the zone will group those leads under 'Leads without Representative'.

To limit the summary of leads by sales representative:

1. Select **Menu > Sales & Marketing > Initiative > Search**.
2. Enter your search criteria in the Initiative Query zone.
3. Click **Refresh**.
4. In the search results list, click the link for the initiative you want to maintain.
The selected initiative opens in the Initiative portal.
5. Go to the **Statistics** page and scroll, as necessary, to view the Lead Summary by Representative zone.
6. Specify **Start Date** and/or **End Date** to limit the summary to leads created within this date range. If specified, start date must be on or before the current date and end date must be on or after the start date. If left blank, end date is defaulted to the current date.

7. If **Include Inactive Leads** is set to No, leads for the initiative (or initiative hierarchy group) regardless of status are included.

The following is displayed in the result set:

- A summary line for the individual sales representative shows the total Lead Count.
- A breakdown is included beneath each sales representative summary line that shows a subtotal Lead Count by lead state.
- An icon is displayed that allows broadcasting of the representative, initiative, date range and lead state (if available) to other zones on the portal. Lead state broadcast is only available on the subtotal lines.

Graphs and Statistics for an Initiative

The following zones display statistics for the initiative's leads.

NOTE: The system periodically refreshes the statistics for an initiative when the time specified on an initiative has lapsed. A user may also manually initiate the refreshing of statistics if required.

Lead Outcome Graph

This Lead Outcome Graph zone shows the number of Leads linked to the initiative (or initiative group hierarchy) that entered the final state in the last 24 months starting from the most recent completed Lead.

The date shown on the X-axis will be the first day of the month. Note that the information displayed here is based on the most recent completed Lead as of the time the Initiative Statistics is accumulated.

Lead Statistics

The Lead Statistics zone has two charts to provide statistics for leads for the initiative:

- **Leads by State:** The chart shows the number of leads for each state in the lead's lifecycle as of the initiative's Statistics Date/Time. Each state can be represented by a unique color. These colors are defined on the Program Management master configuration. Refer to [Program Management Master Configuration](#) for setting up program management options for more information.
- **Active Leads by Representative:** The chart shows the top five individual sales representatives for the initiative (i.e. sales representatives with the largest number of active leads assigned to them as of the Statistics Date/Time). The top five sales representative can be represented by a unique color. These colors are defined on the Program Management master configuration. Refer to [Program Management Master Configuration](#) for setting up program management options for more information.

Lead Monthly Statistics

The Lead Monthly Statistics zone has two charts to provide statistics for leads for the initiative:

- **Leads by State:** The chronological graph highlights the number of open, completed and discarded leads over time for the initiative in context. The date displayed on the x-axis represents the start date of the statistics period. For example, 01-01-2013 shows statistics for the period 01-01-2013 through 01-31-2013. Each State can be represented by a unique color. These colors, along with the number of months to display are defined on the Program Management master configuration. Refer to [Program Management Master Configuration](#) for setting up program management options for more information.
- **Active Leads by Representative:** The chronological graph highlights the top 4 discard reasons over time for the initiative in context. Statistics for all other discard reasons are accumulated in a catch-all bucket. The date displayed on the x-axis represents the start date of the statistics period. For example, 01-01-2013 shows statistics for the period 01-01-2013 through 01-31-2013. Each Discard Reason can be represented by a unique color. These colors, along with the number of months to display are defined on the Program Management master configuration. Refer to [Program Management Master Configuration](#) for setting up program management options for more information.

Displaying and Assigning Unassigned Leads

Use the following procedure to review and assign, as appropriate, non-final and unassigned leads that are associated to the initiative in context.

1. Select **Menu > Sales & Marketing > Initiative > Search**.
2. Enter your search criteria in the Initiative Query zone.
3. Click **Refresh**.
4. In the search results list, click the link for the initiative you want to maintain. The selected initiative opens in the Initiative portal.
5. Go to the **Statistics** page and scroll, as necessary, to view the Unassigned Leads Zone.
6. Enter a Start Date and End Date range that encompasses the desired period.
7. Click **Refresh** to view unassigned leads that were created within the period specified.
8. (optional) Assign one or more leads from the result set:
 - a) Select the unassigned leads from the results set.
 - b) Enter the sales representative that will be assigned the leads.
 - c) Press **Assign to Sales Rep**.
 - d) Select the Sales Representative from the dropdown menu and click **OK**.

Maintaining Leads

A lead is an instance of an initiative for a targeted customer. A lead may contain events or actions that are there to encourage a customer to participate in a program

The topics in this section describe the common functions associated with leads.

My Leads

You can use the My Lead menu item to maintain leads.

- If your User ID is linked to a Sales Representative, you are navigated to the Sales Representative portal with the user in context.
- If your User ID is not linked to a Sales Representative, you are navigated to the Leads Query portal.

Lead Portal

You use the Leads portal to maintain leads. This portal contains the following zones:

- **Lead:** Displays the basic information about the lead.
- **Lead Events:** Displays the events associated with the lead in chronological order.
- **Related Leads:** Displays the leads that are related to the current lead's related objects (e.g. account).
- **Attachments:** Displays uploaded documents that are related to the lead.
- **Notes:** Displays all notes for the lead and its lead events.

- **Third Party Event:** if a third party lead event exists, this zone displays the lead event's information, including the event steps

How To Perform Common Lead Functions

The topics in this section describe how to perform common lead maintenance functions from the Lead portal.

Manually Creating a Lead

Use this procedure to manually create a new lead.

1. Select **Menu > Sales & Marketing > Lead > Add.**
2. Select the lead's Initiative and click **OK.**

The Account Lead page displays so that you can complete the lead.
Enter the following information as required by the Initiative:

3. Search for and select the **sales representative** for the lead.
4. Indicate how the customer requested information about the initiative in the **response channel.**
5. Indicate if the customer has **signed up** for the initiative.
6. Search for and select the **account** that will be associated to the lead.
7. Search for and select the **premise** that will be associated to the lead.
8. Click **Save.**

NOTE: Leads can also be created through the Initiative context menus and Account context menus.

Maintaining a Lead

1. Select **Menu > Sales & Marketing > Lead > Search.**
2. Enter your search criteria in the Lead Query zone.
3. Click **Refresh.**
4. In the search results list (not applicable if Lead ID is specified in the search criteria), click the link for the lead you want to view maintain. The selected lead opens in the Lead portal.

NOTE: You may also navigate to the Lead portal by clicking on the appropriate lead from various portals and zones. Examples include:

- Dashboard Portal: Alerts zone
 - Initiative Portal: Initiative Leads zone
 - Sales Representative Portal: Initiative Leads zone or Initiative Lead Events
-

5. Click the appropriate record action button:

Buttons that appear when the lead is Pending:

- **Edit** – Click the **Edit** button to allow you to edit the main attributes of the lead. When you click **Save**, the system updates the record.

- **Delete** – Click the **Delete** button and click **OK** to delete a pending lead from the database. Before you delete a lead, the system verifies that the lead is not referenced anywhere in the system. If it is, you cannot delete it.
- **Activate** – Click the **Activate** button to transition a pending lead to the active state. When a lead is activated, lead events for the lead are created to encourage the customers to participate in the initiative.

Buttons that appear when the lead is Active:

- **Edit** – *see the description above.*
 - **Discard** – Select the **Discard** button to inactivate an active lead. Select a **Status Reason** indicating why the lead is being inactivated and click **Save**. The values are maintained on the Status Reason control table
 - **Complete** – Click the **Complete** button to indicate that an active lead has been successful.
 - **Sign Up** – Click the **Sign Up** button to initiate a script that is defined on the Initiative’s business object. The base package script **C1-IntvSignU** reevaluates the customer to determine if they are still eligible to participate in a program, indicates the customer has signed up or enrolled on the lead and creates a third party lead event (if applicable) to notify the relevant third party of the actions to be performed. The Response Channel on the lead is also updated for analytical purposes
6. Click the **Add Notes** button, in the Notes zone, to capture additional information for the lead.
 7. The **Third Party Event Zone** displays third party lead event (if any) details along with the steps involved in the lead event

Adding New Lead Events to a Lead

1. Select **Menu > Sales & Marketing > Lead > Search**.
2. Enter your search criteria in the Lead Query zone.
3. Click **Refresh**.
4. In the search results list, click the link for the lead you want to view maintain. The selected lead opens in the Lead portal.
5. To add a lead event to the lead, click the **Add Lead Event** link in the Lead Events zone title bar.
6. Search for and select the appropriate lead event type.
7. Specify the Trigger Date of when the lead event is to be executed.
8. Specify the Communication Channel to indicate what form the event will be sent.
9. Click **Save**.

Repeat steps 5 to 9 for add additional lead events.

Adding Lead Notes

1. Select **Menu > Sales & Marketing > Lead > Search**.
2. Enter your search criteria in the Lead Query zone.
The C1-owned base package search options include:
 - Name and address
 - Related object
 - Representative and initiative

- Lead ID
3. Click **Refresh**.
 4. In the search results list, click the link for the lead you want to view maintain. The selected lead opens in the Lead portal.
 5. Scroll, as necessary, to view the Notes zone.
 6. Click the **Add Notes** link in the zone's title bar.
 7. Enter the desired information in the **Add Notes for Lead** pop-up window and click **Save**.

Maintaining Lead Events

A lead event is an event or action in a lead to take place to encourage a customer to participate in a program. A lead may contain many lead events.

The Lead Event portal is used to maintain lead events. This portal contains the following zones:

- **Lead Event:** Displays the basic information about the lead event.
- **Notes:** Displays user-defined comments about this lead event

To maintain a lead event:

1. Select **Menu > Sales & Marketing > Lead Event > Search**.
2. Enter your search criteria in the Lead Event Query zone.
3. Click **Refresh**.
4. In the search results list, click the link for the lead event you want to maintain. The selected lead opens in the Lead Event portal.

NOTE: You may also navigate to the Lead Event portal by clicking on the appropriate lead event from various portals and zones. Examples include:

- Initiative Portal: Initiative Leads zone
 - Sales Representative Portal: Initiative Leads zone or Initiative Lead Events
-

5. Click the appropriate record action button:
 - **Edit** – Click the **Edit** button to allow you to edit the main attributes of the lead event. When you click Save, the system updates the record.
 - **Complete** – Click the **Complete** button to indicate a pending lead event is completed.
 - **Cancel** - Select the **Cancel** button to cancel a pending lead event.
6. Click the **Add Notes** icon, in the Notes zone, to capture additional information for the lead.

Maintaining Third Party Lead Events

A third party lead event represents an action within a lead to either encourage a customer to participate in a program, or perform an on-site service. A lead may contain one or more third party lead events.

The Lead Event portal is used to maintain third party lead events. This portal contains the following zones:

- **Lead Event:** Displays the basic information about the lead event.

- **Notes:** Displays user-defined comments about this lead event

To maintain a third party lead event:

1. Select **Menu > Sales & Marketing > Lead Event**.

2. Enter your search criteria in the Lead Event Query zone.

The C1-owned base package search options include:

- Name and address
- Related object
- Initiative and representative
- Lead and lead event

3. Click **Refresh**.

4. In the search results list, click the link for the lead event you want to maintain. The selected lead opens in the Lead Event portal.

NOTE: You may also navigate to the Lead Event portal by clicking on the appropriate lead event from various portals and zones. Examples include:

- Initiative Portal: Initiative Leads zone
 - Sales Representative Portal: Initiative Leads zone or Initiative Lead Events
-

5. Click the appropriate record action button:

- **Edit** – Click the **Edit** button to allow you to edit the main attributes of the lead event. When you click Save, the system updates the record.
- **In Progress** – Click the **In Progress** button to initiate the notification process and have the third party lead event sent to the representative.
- **Cancel** - Select the **Cancel** button to cancel a pending lead event.

6. Click the **Add Notes** icon, in the Notes zone, to capture additional information for the lead.

Maintaining Sales Representatives

A Sales Representative is a user or group of users who can be assigned to follow up on leads and responsible for selling the initiatives product or service to the customer.

The topics in this section describe the common functions associated with Sales Representatives.

Sales Representatives Portal

You use the Sales Representative portal to maintain sales representatives. This portal contains the following zones:

- **Sales Representative:** Defines the basic information about the representative.
- **Initiative Lead Summary:** Lists initiatives and information about leads for each initiative for the representative. Clicking the broadcast icon from the summary table in this zone displays the following additional zones:
 - **Initiative Leads:** Displays leads for the initiative and representative.
 - **Initiative Lead Event Summary:** Displays lead event statistics for the initiative lead and representative.
 - **Initiative Lead Events:** Displays lead events for the initiative lead and representative.

- **Group’s Representatives:** This zone is displayed for a representative group and lists the individual representatives who are members of the group.
- **Representative’s Groups:** This zone is displayed for an individual representative and lists the representative groups of which this representative is a member.

How To Perform Common Sales Representative Functions

The topics in this section describe how to perform common sales representative functions from the Sales Representative portal.

Creating Sales Representatives

Use this procedure to create a new sales representative.

1. Select **Menu > Sales & Marketing > Sales Representative > Add.**
2. Select the sales representative type that will define the representative and click **OK.**
3. Enter the appropriate information for the representative:
 - For a Group Sales Representative:
 - Specify the Sales Representative name and description.
 - Search for and select Individual Sales Representative who will be a member of the group.
 - For an Individual Sales Representative:
 - Specify the Sales Representative name and description.
 - Search for and select User for the individual sales representative.
 - Search for and select Group Sales Representative that the individual sales representative will be a member of.
4. Click **Save.**

Maintaining Sales Representatives

1. Select **Menu > Sales & Marketing > Sales Representative > Search.**
2. Enter your search criteria in the Sales Representative Query zone.
3. Click **Refresh.**
4. In the search results list, click the link for the sales representative you want to maintain. The selected sales representative opens in the Sales Representative portal.

NOTE: You may also navigate to the Sales Representative portal by clicking on the appropriate Sales Representative from various portals and zones. Examples include:

- Initiative Portal: The Initiative Zone or the Lead Summary By Representative.
 - Lead Portal: Lead zone
-

5. Click the appropriate record action button:
 - **Edit** – Click the **Edit** button to allow you to edit the main attributes of a sales representative. When you click **Save**, the system updates the record

- **Duplicate** – Click the **Duplicate** button to create a duplicate of the sales representative being displayed. Before the new object is added to the database, a window appears asking you to enter the unique identifier of the new object. When you click **OK**, the system creates the record by copying the original record
 - **Deactivate** – Click the **Deactivate** button to transition an active sales representative to an inactive state
 - **Delete** – Click the **Delete** button and click **OK** to delete the sales representative from the database. Before you delete a sales representative, the system verifies that the sales representative is not referenced anywhere in the system. If this is the case, you cannot delete the representative. For example, if you attempt to delete a sales representative, the system ensures the sales representative is not referenced on a lead, etc.
6. For an individual sales representative, you can add the sales representative to another group by clicking the **Add Rep to Another Group** link in the Representative's Group zones title bar. Select a group sales representative and click **Save**. You can remove the representative from a group (or groups) by selecting the group(s) and clicking the **Remove Rep from Group(s)** button.
 7. For a representative group, you can add a representative to the group by clicking the **Add Rep To This Group** link in the Group's Representatives zone's title bar. Search for and select the individual sales representative to add to the group and click **Save**. You can remove representatives from a group by selecting the representatives and clicking the **Remove Rep(s) from Group** button.

Displaying Leads and Lead Event Information for a Sales Representative

From the Initiative Lead Summary zone on the Sales Representative portal, you can broadcast a representative, initiative, date range and lead state (if available) to other zones on the portal.

Displaying Leads Associated Information for a Sales Representative

The Initiative Lead Summary zone on the Sales Representative portal displays the leads that have been assigned to the sales representative. If the representative is a group, leads are summarized for all individuals in the group.

To limit the summary of leads for the sales representative:

1. Select **Menu > Sales & Marketing > Sales Representative > Search**.
2. Enter your search criteria in the Sales Representative Query zone.
3. Click Refresh.
4. In the search results list, click the link for the sales representative you want to view or manage. The selected sales representative opens in the Sales Representative portal.
5. Specify **Start Date** and/or **End Date** to limit the summary to leads created within this date range. If specified, start date must be on or before the current date and end date must be on or after the start date. If left blank, end date is defaulted to the current date.
6. If **Only Show Active Initiatives** is set to **Yes**, only leads linked to initiatives in the active state are summarized. Otherwise, leads for all initiatives regardless of status are included.
7. Click **Refresh**.

The following is displayed in the result set:

- A summary line for each initiative shows the total **Lead Count** for the individual or group rep.
- A breakdown is included beneath each initiative summary line that shows a subtotal **Lead Count** by lead state.
- An icon is displayed that allows broadcasting of the representative, initiative, date range and lead state (if available) to other zones on the portal. Lead state broadcast is only available on the subtotal lines.

Sales Representative Initiatives Leads Zone

By clicking on one of the broadcast items in the Initiative Lead Summary zone, the Initiative Leads zone on the Sales Representative portal is populated with relevant lead information for the selected item. If the sales representative is a group, leads for all individuals in the group are shown.

The following is displayed in the result set for each lead:

- Basic **Lead** information for the initiative's lead. You can navigate to the lead by clicking on the lead.
- **Customer Information** related to the lead. You can navigate to the account related to the lead by clicking on the customer information.
- The **Last Complete Event**. You can navigate to the lead event by clicking on the last complete event for a lead.
- For open leads, the **Next Pending Event**. You can navigate to the lead event by clicking on the next pending event for a lead.
- The **Sales Representative** shows the rep assigned to each lead.

For information about using this zone to reassign leads to another representative, see [Reassigning Leads for a Sales Representative](#).

Initiatives Lead Event Type Summary

By clicking on one of the broadcast items in the Initiative Lead Summary zone, the Initiative Lead Event Type Summary zone is displayed. If the representative is a group, lead events are accumulated for all individuals in the group. The summary spans the 14 day period on/after the Start Date which defaults to current date if blank. If you want to specify the start date, click Refresh to update the zone.

The following is displayed in the result set:

- The **Event Count** shows the total number of events for a specific Event Type on each day within the 14 day period. You can click on the broadcast icon to see a list of events for the **Event Date** and **Event Type** on the Initiative Lead Events zone.
- The **Event Status** bar provides a breakdown of the total event count by status. Each color segment shown represents a different event status for pending, completed and canceled events. Colors used are defined on the program management master configuration.
 - Hover the mouse pointer over a segment of the bar to see the respective count and status represented by the segment.
 - Click on a segment of the bar to broadcast the event date, event type and event status. Broadcasting from the event status bar instead of the broadcast icon will limit the Initiative Lead Events zone to a particular status.

Initiatives Lead Events Summary

By clicking on one of the broadcast items in the Initiative Lead Event Type Summary zone, the Initiative Lead Events zone is populated. This zone displays lead events for the initiative, representative, lead event type (if available) and status (if available). If the representative is a group, events for all individuals in the group are shown. Only lead events with a trigger date on or after the **Start Date** are displayed.

The following is displayed in the result set:

- **Event Date** and **Lead Event** information is shown for each event. You can navigate to a specific lead event by clicking on a lead event.
- **Lead** shows the lead information for the initiative's lead. You can navigate to the lead by clicking on a lead.

- **Customer Information** related to the lead. You can navigate to the account related to the lead by clicking customer information for a lead.
- The **Sales Representative** shows the representative assigned to the lead.

Reassigning Leads for a Sales Representative

To reassign leads from one sales representative to another sales representative:

1. On the Initiatives Leads zone, select the leads that you want to reassign and click **Reassign Rep.**
2. Select the Sales Representative to reassign the selected lead to and click **Save.**

Maintaining Third Party Representatives

A Third Party Representative is someone who can receive assignments to perform specific tasks within a lead; such as, undertaking a visit to a property to perform an inspection or an installation. Refer to [The Big Picture of Third Party Representatives](#) for more information

The topics in this section describe the common functions associated with Third Party Representatives.

Third Party Representatives Portal

The Third Party Representative portal is used to maintain third party representatives. This portal contains the following zones:

- **Third Party Representative:** Defines the basic information about the third party representative.
- **Initiative Lead Summary:** Displays a summary of initiatives that have leads assigned for the third party representative. Clicking the broadcast icon from the summary table in this zone displays the following additional zones:
 - **Initiative Leads:** Displays leads for the broadcasted initiative and third party representative.
 - **Unassigned Leads:** Displays unassigned leads for the broadcasted initiative that are not yet assigned to a third party representative.

How To Perform Common Third Party Representative Functions

The topics in this section describe how to perform common representative functions from the Third Party Representative portal.

Creating Third Party Representatives

Use this procedure to create a new third party representative.

NOTE: Before adding the third party representative, they must be added as a Person without an account in the system. For more information about this process, see [How To Add A New Customer From Control Central](#).

1. Select **Menu > Sales & Marketing > Third Party Representative > Add.**
2. Enter the appropriate information for the representative:
 - Specify the Third Party Representative name and description.
 - Search for and select the Person record for the third party representative.
 - Select the External System that will be used to communicate to the third party representative.

3. Click **Save**.

Maintaining Third Party Representatives

1. Select **Menu > Sales & Marketing > Third Party Representative**.
2. Enter your search criteria in the Third Party Representative Query zone.
3. Click **Refresh**.
4. In the search results list, click the link for the third party representative you want to maintain. The selected third party representative opens in the Third Party Representative portal.
5. Click the appropriate record action button:
 - **Edit** – Click the **Edit** button to allow you to edit the main attributes of a third party representative. When you click **Save**, the system updates the record
 - **Duplicate** – Click the **Duplicate** button to create a duplicate of the third party representative being displayed. Before the new object is added to the database, a window appears asking you to enter the unique identifier of the new object. When you click **OK**, the system creates the record by copying the original record
 - **Deactivate** – Click the **Deactivate** button to transition an active third party representative to an inactive state
 - **Delete** – Click the **Delete** button and click **OK** to delete the third party representative from the database. Before you delete a third party representative, the system verifies that the third party representative is not referenced anywhere in the system. If it is, you cannot delete it. For example, if you attempt to delete a third party representative, the system ensures the third party representative is not referenced on a lead, etc.

Displaying Leads Associated Information for a Third Party Representative

The Initiative Lead Summary zone on the Third Party Representative portal displays the leads that have been assigned to the Third Party representative.

To limit the summary of leads for the sales representative:

1. Select **Menu > Sales & Marketing > Third Party Representative > Search**.
2. Enter your search criteria in the Third Party Representative Query zone.
3. Click **Refresh**.
4. In the search results list, click the link for the sales representative you want to view or manage. The selected sales representative opens in the Sales Representative portal.
5. Specify **Start Date** and/or **End Date** to limit the summary to leads created within this date range. If specified, start date must be on or before the current date and end date must be on or after the start date. If left blank, end date is defaulted to the current date.
6. If **Only Show Active Initiatives** is set to **Yes**, only leads linked to initiatives in the active state are summarized; otherwise, leads for all initiatives regardless of status are included.
7. Click **Refresh**.

The following is displayed in the result set:

- A summary line for each initiative shows the total **Lead Count** for the third party representative.
- A breakdown is included beneath each initiative summary line that shows a subtotal **Lead Count** by lead state.
- An icon is displayed that allows broadcasting of the third party representative, initiative, date range and lead state (if available) to other zones on the portal. Lead state broadcast is only available on the subtotal lines.

The Initiative Leads zone on the Third Party Representative portal displays the leads that have been assigned to the third party representative. The following is displayed in the result set for each lead:

- Basic **Lead** information for the initiative's lead. You can navigate to the lead by clicking on the lead.
- **Customer Information** related to the lead. You can navigate to the account related to the lead by clicking on the customer information.
- The **Last Completed Step**. You can navigate to the lead event by clicking on the event/step information.
- For active third party lead events, the **Next Pending Step**. You can navigate to the lead event by clicking on the event/step information.
- The **Sales Representative** shows the representative assigned to the lead.

The Unassigned Leads zone on the Third Party Representative portal displays active leads that are not yet assigned to a third party representative. The following is displayed in the result set for each lead:

- Basic **Lead** information for the initiative's lead. You can navigate to the lead by clicking on the lead.
- **Customer Information** related to the lead. You can navigate to the account related to the lead by clicking on the customer information.
- The **Sales Representative** shows the representative assigned to the lead.
- You can assign leads to the third party representative using the **Assign to Third Party** button.

See [Displaying and Assigning Leads to a Third Party Representative](#) for more information.

Displaying and Assigning Leads to a Third Party Representative

Use the following procedure to view leads that are not assigned to a third party representative, and assign one or more of those leads to the third party representative in context.

1. Select **Menu > Sales & Marketing > Third Party Representative > Search**.
2. Enter your search criteria in the Third Party Representative Query zone.
3. Click **Refresh**.
4. In the search results list, click the link for the third party representative you want to view. The selected third party representative opens in the Third Party Representative portal.
5. The **Initiative Lead Summary** zone shows the initiatives that have leads assigned to the third party representative in context. Click the broadcast button on an initiative to view its unassigned leads.
6. Scroll down to view the **Unassigned Leads** zone. This zone will display if there are active leads (for the broadcast initiative) that are not yet assigned to a third party representative.
7. To assign one or more leads to the third party representative in context:
 - a) Select the unassigned lead(s) from the results set.
 - b) Press **Assign to Third Party**.
 - c) Click **OK**.

Rates

When you set up a customer in the system, you create a service agreement for every service that the customer uses. The most important information specified on a service agreement is the rate. The rate controls:

- How the service's charges are calculated.
- How the charges are described on the customer's bills.
- How the general ledger is affected by the charges.

It's important to understand that while *most* service agreements are associated to a rate, you may have service agreements that don't use a rate to calculate their charges; for example, you may have [billable charge](#) service agreements to bill a customer for charges that have been calculated in an external system. Whether or not a service agreement uses a rate and the list of rates that can be specified on a service agreement are controlled by the service agreement's [SA Type](#).

In addition to calculating charges for service, your implementation can also use rates to calculate [adjustments](#).

FASTPATH:

Refer to [How Rates Affect The Information On A Bill](#) for how billing uses the information in a rate to calculate a bill segment. Refer to [Calculated Adjustments](#) for how to use a rate to calculate an adjustment.

NOTE:

Do not equate a rate in your legacy system with a rate in this system. You may find that the system's flexibility will result in fewer rates than you have today. For example, your current rate structure may have three rates for service because there are different prices based on the customer's geographic area. In this system, however, you can set up a single rate and vary the price based on where the customer lives.

This chapter describes the structure and process to configure rates.

NOTE:

If you're using Oracle Utilities Rate Cloud Service, refer to the [Oracle Utilities Rate Cloud Service](#) chapter in the *Business User Guide*, and the [Defining Oracle Utilities Rate Cloud Service Options](#) chapter in the *Administrative User Guide* for information about how the rate functionality works in the context of that cloud service.

Rate schedules created using the new rate engine are referred to as **Calculation Rule-Based Rates** or, simply, **Rates**; and those created using the original rate engine are referred to as **Component-Based Rates**. This chapter focuses on Calculation Rule-Based Rates, unless stated otherwise.

CAUTION:

Component-Based Rates, or classic rates, is not the recommended approach for new implementations. Component-Based Rates is intended for upgrading customers who currently use this rate structure and have not converted to Calculation Rule-Based Rates.

Calculation Rule-Based Rates

Calculation Rule-Based Rates (Rates) offer a flexible and reusable structure to calculate charges, centralize configuration, and reduce your development effort and time.

This chapter describes the structure and process to configure Rates.

All Calculation Rule-Based Rates Share a Common Structure

The basic components used to calculate charges are **Calculation Rules**. Each calculation rule is configured to perform a specific type of calculation, such as calculating tax charges, the number of days in a billing period, or the amount of consumption used by a customer in a billing period.

Calculation rules are organized into **Calculation Groups**, which are logical collections of calculation rules that can be referenced by rate schedules. Calculation rules and groups are commonly "generic" and can be applied to multiple rates.

Furthermore, calculation groups can be nested within other calculation rules. When the parent rule is processed, it executes all the rules that are nested in its referenced group. This strategy allows a single rule to execute any number of nested rules. Nesting also allows common calculations to be encapsulated into a set of calculation rules that can be included in multiple rates.

Calculation groups are defined for a rate schedule in one of three ways:

- **Pre-Processing Calculation Groups** perform initial calculations in preparation for the rate version calculation group.
- **Rate Version Calculation Groups** are effective-dated calculation groups that perform the main calculations of the rate schedule.
- **Post-Processing Calculation Groups** perform calculations after rate version calculation groups are executed.

See [About Calculation Groups](#) for more information.

At the highest level, every rate has a single rate schedule that contains basic information that shouldn't change over time; such as, the billing frequency, currency, and the rate's proration strategy. This information combined with the calculations groups, and other high-level configuration, comprise the Rate Schedule

Control Tables That Must Be Set Up Before Creating a Rate Schedule

This section describes tables that must be set up before you can add a rate schedule.

Master Configuration

The **Rate Engine Configuration** master configuration can be used to define the behavior of the Rate Schedule portals used when creating rate schedules.

To edit this master configuration, select **Admin > Master Configuration**, and click the edit icon for the **Rate Engine Configuration**.

The **Rate Engine Implementation** dropdown list defines which rate engine(s) will be used by your organization.

- **Calculation-Rule Based** indicates that your implementation uses calculation rule-based rates, which require the configuration of rate schedules with calculation groups and calculation rules.
- **Component-Based** indicates that your implementation uses component-based rates, which require the configuration of rate versions with rate components, and rate schedules with SQ and register rules.
- **Both** indicates that your implementation uses both rate engines. If this applies to you, then the system will use this option to ease navigation as follows:
 - Select **Menu > Rates > Rate Schedule > Add** to launch the page to add a new rate schedule. *(A hyperlink is included to take the user to the component-based rate schedule maintenance page, if necessary.)*
 - Select **Menu > Rates > Rate Schedule > Search** to launch the **Rate Schedule Query** portal.
 - The query results attempt to highlight component-based rates by appending **“(Component-Based)”** to the rate schedule's description.
 - Once a rate schedule is selected from the result set, the system navigates the user to either the calculation rule-based **Rate Schedule portal** or the component-based **Rate Schedule page**.

The **External Communication** section is used when the rate engine needs to communicate with an external system. For example, service quantities are needed to test a rate on the **Rate Check** portal. These service quantities may be entered on the portal, retrieved from an existing bill segment, or (in the case of a service agreement that requires bill determinants) request service quantities from Oracle Utilities Meter Data Management.

- **Request Type** identifies the various data requests that can be made to an external system. Request types are defined in the RATE_EXT_REQ_TYPE_FLG lookup field. To introduce additional request types, add appropriate lookup values to this lookup field for each request type you wish to support.

The base package includes the following business objects to be defined on the outbound message types created for such requests:

- **Rate Check Usage**: C1-UsageRequestOutMsg (used to request bill determinants from MDM on the rate check portal)
- **External System** and **Outbound Message Type** are used when creating the outbound message for the data request.

Defining Frequency Codes

When you create a rate schedule, you must enter a code defining the frequency in which the prices are expressed, e.g., monthly, quarterly, biannual, etc. To set up frequency codes, open **Admin > Rates > Frequency**.

Description of Page

Enter a unique **Frequency ID** and **Description** for each frequency.

Before entering the remaining fields, you must analyze the "proration provisions" in your rates. For example, consider a rate used to calculate charges for a "month's worth of service". Assume this rate's charges will not be prorated when the customer's service period is anywhere between 27 and 33 days. This rate requires a frequency that indicates:

- **12 Periods / Year** (because it's a monthly rate).
- **MinimumDays Offset** equal to 3.
- **MaximumDays Offset** equal to 3.

When the system creates a bill using a rate with this frequency, it compares the number of days of consumption on the bill to the minimum and maximum number of days inferred by the rate's frequency. In the example above, the minimum number of days would be 27 (365 days / 12 period per year - 3 offset for minimum days). The maximum number of days would be 33 (365 days / 12 periods per year + 3 offset for maximum days). Therefore, if a bill's consumption period is less than 27 days or more than 33 days, the bill's charges are prorated.

NOTE:

Overriding the system's standard proration logic. If the standard proration logic does not satisfy your requirements, you may plug in an override proration algorithm to calculate the proration factors as required by your implementation. For example, we have encountered companies who treat a year as have 360 days rather than 365 days. Such a company would need to develop an override proration algorithm and plug it on the [Installation](#) record.

Where Used

Every Rate Schedule must have a frequency. Refer to [Defining Rate Schedules](#) for more information.

Setting Up Bill Factors

This section describes bill factors and how they are used to levy the many charges referenced in a rate.

WARNING:

Most bill factors exist to support calculations performed by calculation rules. This means that you must design your calculation rules before you can design your bill factors. We strongly recommend that you design "on paper" how each rate's calculation rules look before attempting to set up bill factors.

An Overview of Bill Factors

The primary reason that calculation rules exist is to define how much to charge for the services sold by your company. When you create calculation rules, you have four ways to indicate how much to charge:

- Specify the value directly in the calculation rule.
- Define that the value is defined in a *bill factor*.
- Define that the value is calculated by a *for calculation purposes only* calculation rule.
- Tell the calculation rule to call an algorithm to get the price.

The remainder of this section describes the bill factor approach. The other methods are discussed in [Case Study: Three Simple Rates](#).

Bill factors are used to pass a value to a calculation rule; such as specifying a tax rate. To further illustrate this, you could specify the current tax rate, say 6%, directly in every rate's calculation rules OR you could indicate every rate should levy the current state tax rate and have the system look up the applicable rate when it calculates bills. The latter approach involves using a bill factor to indicate that the amount to charge should be retrieved from someplace other than the calculation rule when a bill is calculated.

You can use bill factors to define any of the following types of charges:

- A flat amount. This would typically be used to define service charges, minimum charges, and asset charges.
- An amount for a given unit of measure. This would typically be used to define the price for measured consumption (such as, the price per therm).
- A percentage. This would typically be used for tax rates and discount percents.

As a rule of thumb, you would use a bill factor (rather than specify the value in the calculation rule) when any of the following situations exist:

- The same charge exists in many rates. For example, if there are three rates that all contain the same service charge, it would make sense to use a bill factor to levy this charge rather than specify the same value on three calculation rules.
- The amount being charged is dependent upon some physical characteristic of the customer's equipment. For example, if the price differs depending on whether the customer owns the transformer, you would use a bill factor to specify the price.
- The amount being charged is dictated by some external organization and therefore can change independently from the rate. For example, tax percentages and use fees are set by taxing authorities and can be changed at any time (and you don't want to change the rate when these charges change).
- The amount being charged varies depending on WHERE the customer lives. If you have a rate where the price per gallon differs depending on where the customer lives, you should use a bill factor to levy this type of charge.
- A charge (or discount) is only levied for a subset of customers for defined periods of time. For example, if you have a discount that is only given to customers who have had service for more than two years, you would use a bill factor to specify the discount percent.
- The price differs per customer. For example, you may have a rate for large gas customers where the price per therm is different for every customer. In this situation, you would use a bill factor to specify the price.
- The price differs based on the number of weeks of consumption. This typically occurs in a deregulated environment when the price charge is based on the weighted average spot market price in effect during the bill period.

WARNING:

As you can deduce, bill factors are extremely flexible. While the flexibility makes for a very powerful rate engine, it also presents you a dizzying array of options. We have discovered that to take advantage of the flexibility, you need to gain

an overall understanding of the pricing and taxation provisions in ALL of your rates. Only then can you make logical and pragmatic decisions in respect of the number and type of bill factors.

The Structure of a Bill Factor

All bill factors share a common structure as illustrated below:

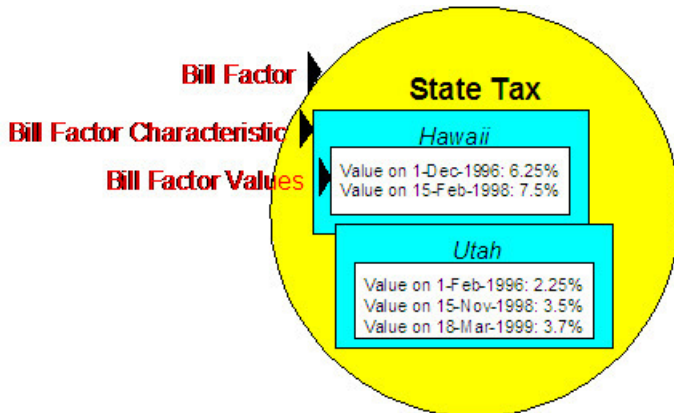

The above example shows a standard bill factor, which is made up of the following tables:

- **Bill Factor.** A **bill factor** contains descriptive information and attributes that control how the bill factor may be used in the system.
- **Bill Factor Characteristic.** All bill factors have the capability of having different values depending on some characteristic of the premise or service point. For example, a bill factor used to levy a state tax would have a different tax rate depending on the state in which the customer resides. A **bill factor characteristic** must exist for every state with a tax (states without a tax will not be linked to the state tax bill factor). At billing time, if the system cannot find a bill factor characteristic that corresponds with the customer's state of residence, the charge will be skipped.
- **Bill Factor Value.** Each bill factor characteristic may have many **bill factor values** over time. To continue with our state tax example, each state with a tax can have different tax rates over time. There are different ways in which a bill factor's values may be defined:
 - For bill factors whose values are applicable to many customers where only one value is effective on a given date (such as, a city tax) the values are defined using bill factor values. Refer to [Defining Bill Factor Values](#) for more information.
 - For bill factors whose value differs per customer, the value is defined in the customer's service agreement. Refer to [Service Agreement - Contract Value](#) for more information about bill factors in contract terms.
 - For bill factors whose values are applicable to many customers where more than one value is effective on a given date (such as, an interval price or a weighted average price) the values are defined on an interval value set. Refer to [Defining Interval Values](#) for more information about interval value sets.

An Illustration of a Bill Factor and Its Characteristics

The following picture illustrates how a bill factor and its characteristics are used to retrieve the relevant state tax at billing time:

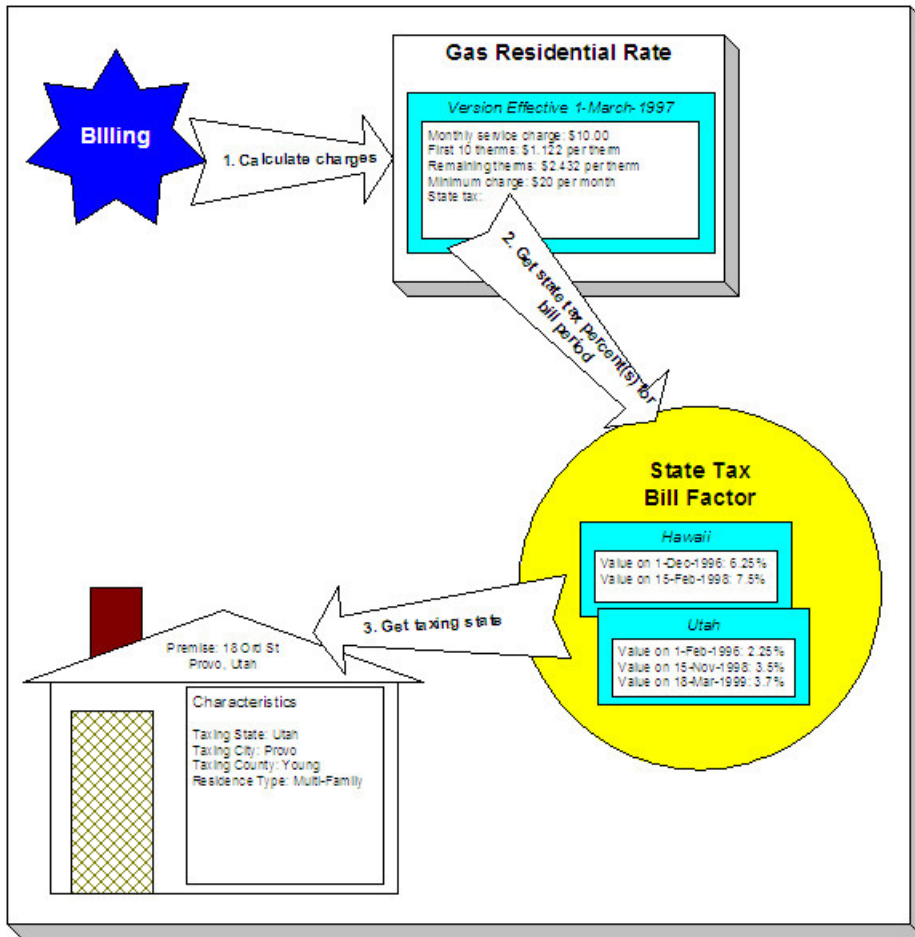

The following points describe the illustration:

- At billing time, the billing engine sends a request to a rate to calculate the charges for a customer's consumption.
- The rate calculates charges without bill factors until it encounters the calculation rule that levies state tax. This calculation rule references a bill factor. This means the rate must get the tax rate(s) in effect during the billing period from this bill factor.
- The state tax bill factor contains an attribute defining that the premise's taxing state characteristic controls the bill factor value. The bill factor therefore extracts the taxing state from the premise.

NOTE:

Deriving characteristic values. Rather than have the system extract the characteristic value from an entity, you can setup the system to derive the characteristic value when the rate is calculated. For example, if all of your customers are located in a single state, you may not want to maintain the taxing state on every premise. To do this, you could setup the rate to "hard code" a taxing state of say Hawaii. This is an advanced topic, but it may prove useful for your implementation. Refer to [Deriving / Passing In Characteristic Values](#) for the details.

- The premise returns the taxing state and the bill factor extracts the tax rate(s) in effect during the bill period and returns them to the rate.
- The rate applies the tax percents and returns the charges to billing.

NOTE:

Some bill factors don't need a characteristic. There are bill factors whose value does not differ based on a characteristic. For example, if your organization offers employee discounts, the discount percent is probably the same

for all employees and therefore this bill factor doesn't need a characteristic to select the bill factor value at billing time. However, because of the relational design of the system, every bill factor value must reference both a bill factor and a characteristic value. Therefore, if you have bill factors whose value is not related to a characteristic, you must specify a characteristic type on the bill factor with a characteristic value that is exactly the same as the characteristic type.

FASTPATH:

For more information about setting up characteristics, see [Setting Up Characteristic Types and Their Values](#) .

Deriving/Passing In Characteristic Values

In [An Illustration of a Bill Factor and Its Characteristics](#), we described how the system retrieves a characteristic value from a premise when a bill factor is encountered that uses a premise characteristic. This is a very common technique and is easy to understand. However, there are situations when an entity in Oracle Utilities Customer Care and Billing doesn't contain the appropriate characteristic value and therefore other techniques must be used. These techniques may not apply to your implementation, but they're worth understanding to help you form an intuitive understanding of rate application:

- There are implementations that only use the Oracle Utilities Customer Care and Billing rate engine. These implementations do not setup accounts, premises, etc. Rather, they simply setup their rate schedules, calculation rules, and bill factors. The rate engine is called from another application. This means the rate engine can't retrieve characteristic values from within Oracle Utilities Customer Care and Billing (because there are no objects where the characteristic values are defined). In this situation, the application that calls the rate engine must supply the characteristic types and values to be used when a bill factor requires this type of information.
- Assume you have a charge that is based on the account's customer class and the service agreement's revenue class. The characteristic value for this type of charge is not extractable through a single entity. Rather, the system must construct the characteristic value in real-time by concatenating information from the account and service agreement that is being billed. In this situation, you can use pre-processing calculation group to derive this characteristic type and value. This calculation group would create a characteristic type and value in real time by concatenating the account's customer class and the service agreement's revenue class. This characteristic type and value only exists in memory while the rate application executes.

When you setup a bill factor to use a characteristic whose value is derived or passed in, you need to define its characteristic source as Characteristics Collection. This source tells the system to extract the characteristic value from memory rather than extracting it from an object within the system.

NOTE:

The plug-in spots on a calculation rule have access to the Characteristics Collection. You might find this useful if you have a calculation rule that needs to calculate characteristic values for subsequent calculation rules.

Defining Bill Factors

You create a bill factor for every type of charge whose value is not specified directly in a calculation rule.

It is recommended to use two windows to set up a bill factor. On the first, you define general information describing how the bill factor is used in the system. On the second, you define all the characteristic values for the bill factor.

Defining General Bill Factor Information

Begin to define a bill factor by selecting **Menu > Rates > Bill Factor > Add**.

Description of Page

Enter a unique **Bill Factor** code and a **Description** for the bill factor.

Use **Bill Factor Type** to indicate if this bill factor uses Regular, Interval (i.e., real-time), or Time of Use values.

- **Regular.** Indicates that this bill factor's values are specified on [Bill Factor Value - Main](#) or on [Service Agreement - Contract Values](#).
- **Interval.** Indicates that this bill factor's values are specified on [Defining Interval Values](#)
- **Time of Use.** Indicates that this bill factor's values are specified on [Bill Factor TOU Values](#) or on [SA Interval Billing Info - TOU Contract Values](#) (**Note:** This option is only applicable to Component-Based Rates).

Enter a **Currency Code** to define the bill factor's denomination, or currency. This field is disabled if the bill factor is referenced on a calculation rule.

NOTE:

Bill factors referenced on a calculation rules must be denominated in the same currency as is the rate.

Select the **Value Type** to define the kind of value maintained by this bill factor. The Value Type options are:

- **Charge.** The value maintained in this bill factor is a fixed amount (e.g., a flat charge).
- **Percentage.** The value maintained in this bill factor is a percentage.
- **Unit Rate.** The value maintained in the bill factor is a price per service quantity.

This field is disabled if the bill factor is already referenced on a calculation rule or if the bill factor already has values

Turn on **Error If No Value** if the system should create a billing error when a bill factor value doesn't exist for the characteristic value linked to the customer. To clarify, understand that there are different types of bill factors:

- Those that should have a value for every customer whose rate references the bill factor. A bill factor used to levy the relevant state tax is a good example (assuming every state has a tax). For this type of bill factor, if the system cannot find a bill factor value for the taxing state, it must generate a billing error because data is missing from the system. You would turn on **Error if No Value** for this type of bill factor.
- Those that only have a value when the customer has a characteristic value that levies a charge. A bill factor used to levy the relevant city tax is a good example (because not all cities levy taxes). For this type of bill factor, if the system cannot find a bill factor value for the city in which the customer lives, the calculation rule will be skipped and no billing error will be generated. You would turn off **Error if No Value** for this type of bill factor

Bill factors used to levy taxes may or may not be eligible for tax exemptions; it's up to the respective taxing authority. Customers who are eligible for the tax exemption will have their tax obligation reduced (or nullified) at billing time. For bill factors that are eligible for tax exemptions, turn on **Tax Exemption**. If a service agreement is fully or partially exempt for the taxes defined by a given bill factor, the bill factor and the exemption information for the customer must be indicated on the Service Agreement page. This field will be disabled if the bill factor is referenced as being tax exempt in a service agreement.

FASTPATH:

For more information about how to make a customer tax exempt, refer to [Service Agreement - Tax Exemptions](#).

Some types of bill factors do not have the same value for all customers. Rather, their value may be unique for every customer or it may be unique for some customers and common for others. For example, you may have rates where the price per kilowatt-hour is defined for every customer using the rate. You may have other rates where certain customers have their own price per kilowatt-hour defined and other customers who use the value defined on the bill factor. For any type of bill factor where a customer may have their own unique price, turn on **Value In Contract Term**. For any service agreement that has a unique value for a given bill factor, the bill factor and the service agreement's value must be indicated on the [Service Agreement](#) page. When applying the rate for a bill factor of this type, the system will first check for the existence of

a contract value for the service agreement and if one is not found, it will use the value on the bill factor. This field will be disabled if a contract term referencing this bill factor exists.

NOTE:

The **Error if No Value** switch also affects what happens if there is no contract term for the bill factor. If the error switch is on, a billing error will be generated. If the error switch is off, no billing error will be generated and the calculation rule will be skipped.

FASTPATH:

For more information about how to specify a bill factor value in a customer's contract, refer to [Service Agreement - Rate Info](#).

Contract riders are used when the charge associated with the bill factor is only applicable to some customers for some period of time. For example, if a bill factor is used to provide a discount during the first 3 months of service, then a contract rider would be used. Turn on **Contract Rider Applicability** if the bill factor's applicability is contingent on the existence of a contract rider. This field will be gray if a contract rider referencing this bill factor exists on a service agreement.

FASTPATH:

For more information about how to establish a contract rider for a customer, refer to [Service Agreement - Contract Riders](#).

The proration information tells the system how to handle changes to bill factor values and their optional contract riders that may occur during a customer's bill period. Turn on **Allow Proration** if changes to the bill factor's value and/or contract riders should be prorated. If the **Bill Factor Type** is not specified as Interval and if changes should **not** be prorated, indicate the **Rate Selection Date Algorithm** to use when the system retrieves bill factor values or determines if contract riders are applicable.

If you have sub service agreements, turn on **Use Sub SA Contract** terms if billing should access contract riders, values, tax exemptions from the sub SA rather than the master. If this switch is off, the system will use the master SA's riders, contract value, and tax exemptions when it creates bills for a sub service agreement. Refer to [Sub Service Agreements](#) for more information.

If the Contract Management module is not **turned off**, which includes [umbrella agreement management](#), and you have checked either Tax Exemption, Value in Contract Term or Contract Rider Availability, indicate the **Terms of Service Usage**. Valid values are Check SA Only, Check TOS Only and Check TOS First, then SA. Refer to [Overriding Rate Terms](#) for details about how to set this value based on your business needs.

Bill Factor Tree

The right half of this page is dedicated to a tree that shows the bill factors characteristics and their respective values (for Regular bill factors) or interval value Sets (for Interval bill factors). You can use this tree to both view high level information about these objects and to transfer to the respective page in which an object is maintained by using the available Go To buttons.

Where Used

Many types of Rate Components may use a Bill Factor to define the price being charged. Refer to [Designing Calculation Groups and Rules](#) for more information.

The BILPC-TOTAL algorithm type that is used to levy late payment charges references the bill factor that defines the late payment charge percent. Refer to [SA Type - Main](#) for more information about this algorithm.

A Service Agreement references Bill Factors as follows:

- When a service agreement's Apply To calculation rule references tax exemptable bill factors AND the customer is tax exempt, the service agreement will define the bill factors from which the customer is exempt. Refer to [Service Agreement - Tax Exemptions](#) for more information.

- When a service agreement's rate references bill factors whose prices are customer-specific (i.e., specified on a contract term), the service agreement will contain prices for these bill factors. Refer to [Service Agreement - Contract Values](#) for more information.
- When a service agreement's rate references bill factors that are contingent on contract riders, the service agreement will define the rider period (if any) for these bill factors. Refer to [Service Agreement - Contract Riders](#) for more information.

Setting Up Bill Factor Characteristics

After defining general information about a bill factor, open **Menu > Rates > Bill Factor > Search** and navigate to the **Bill Factor Characteristics** page to define characteristic values where applicable. For example, a bill factor used to levy the applicable city tax would require the definition of every city that levies a tax.

NOTE:

If all values for a bill factor are specified in contract terms, you do not need to set up Bill Factor Characteristics.

Description of Page

Enter a **Characteristic Type** to indicate the type of characteristic that controls how the bill factor's value is defined. This field will be disabled if Bill Factor Characteristics are specified in the following grid.

The **Characteristic Source** defines where the system retrieves the characteristic value at billing time. The Characteristic Source options are:

Account	The characteristic type's value will be retrieved from the service agreement's account.
Characteristic Collection	Refer to Deriving / Passing In Characteristic Values for an explanation of this value.
Main Person	The characteristic type's value will be retrieved from the main person linked to the service agreement's account.
N/A	The characteristic type's value is the same for all customers using the rate. If this option is used, you must still choose a Characteristic Type. This Characteristic Type should have a single Characteristic Value. The ID of the characteristic value must be identical to the ID of the characteristic type.
Premise	The characteristic type's value will be retrieved from the service agreement's characteristic premise.
SA	The characteristic type's value will be retrieved from the service agreement.
SP	The characteristic type's value will be retrieved from the customer's service point. If multiple service points are linked to the service agreement, one will be chosen at random.

FASTPATH:

For more information about characteristics, see [Setting Up Characteristic Types and Their Values](#) and [An Illustration Of A Bill Factor And Its Characteristics](#).

Use the add and remove buttons to define the **Characteristic Values** that are relevant for the bill factor's Characteristic Type. For example, if the bill factor is used to levy a city tax, you would define the city's that have a city tax in the above collection.

Use the **Minutes Per Interval** if your Bill Factor is of type Interval. This defines, for each characteristic value, the number of minutes expected between each record of interval data.

Use the **External ID** if the values for this characteristic are interfaced to the system from an external source and you want to record an identifier for the source.

NOTE:

If the bill factor's value is the same for all customers, you still must link a "dummy" characteristic value to the bill factor. In other words, you'll have to create a characteristic type called "n/a" and define for it a characteristic value of "n/a". Then, on the bill factor, you reference the "n/a" characteristic type and on the above window, you indicate a characteristic value of "n/a".

Defining Bill Factor Values

After the bill factor and its characteristic values are defined, you define the price / percent and GL distribution associated with each bill factor characteristic. The topics in this section describe the pages used to set up this information.

Bill Factor Value - Main

After the bill factor and its characteristic values are defined, select **Menu > Rates > Bill Factor Value** to define the price / percent applicable to each bill factor characteristic.

IMPORTANT:

You do not set up Bill Factor Values for bill factors whose values are specified in an interval value data set or if all the values are customer specific and are defined as contract terms. Refer to [Defining Interval Values](#) for more information about interval value sets. Refer to [Service Agreement - Contract Value](#) for more information about bill factors in contract terms.

Description of Page

Enter the **Effective Date** and respective **Value** for the bill factor and characteristic value. The first date should be the earliest date on which the bill factor's charges are effective. Subsequent effective dates and values are required whenever the value changes.

NOTE:

Default note. A **Value** of 0, zero, will be defaulted.

Bill Factor Value - GL Distribution

Select **Menu > Rates > Bill Factor Value** and navigate to the **GL Distribution** page to define the GL account affected by the bill factor characteristic.

Description of Page

If the bill factor characteristic's charges are booked to a different GL account depending on the characteristic value, specify the appropriate **DistributionCode** for each **Revenue Class**.

IMPORTANT:

Specifying distribution codes on a bill factor is optional. You would only do this if the GL distribution code differs based on the characteristic value (such as, the city tax payable GL account differs depending on the city). If you do not enter the above information, the distribution code will be used.

The GL distribution code on the bill factor's value will not be used in the following cases:

- Value derived solely on contract value or contract value in combination with contract rider and/or tax exemption, where characteristic value is no longer used to determine the bill factor value.
 - Value derived in calculate service quantity and math calculation rules where multiple bill factors may be configured in the rule resulting to multiple values contributing to the calculation of the line amount.
-

Rate Schedule Execution

When a rate schedule is executed, the system executes the calculation rules contained in the calculation groups defined for the rate schedule as follows:

1. First, the system executes the calculation rules defined within Pre-Processing Calculation Groups.

- The rate engine may a bill segment calculation header for pre-processing calculations, if bill calculation lines are to be created.
- Calculation groups are executed in order according to the Sequence defined on the rate schedule.
- Calculation rules within each group are executed according to the Sequence configured within the group.

2. Next, the system executes the calculation rules within the Rate Version Calculation Groups. The system uses the Effective Date on each calculation group to determine which group(s) to execute. If more than one version of a calculation group is in effect during the billing period, the system may prorate the calculations, based on the configuration of the rate schedule.

- The rate engine creates a separate bill segment calculation header for each rate version calculation group.
- Calculation rules within each group are executed according to the Sequence configured within the group.

3. Finally, the system executes the calculation rules defined within Post-Processing Calculation Groups.

- The rate engine creates a separate bill segment calculation header for post-processing calculations.
- Calculation groups are executed in order according to the Sequence defined on the rate schedule.
- Calculation rules within each group are executed according to the Sequence configured within the group.

Additional Information.

- After every rate version calculation group is processed, the rate application returns the calculation details to the process that called it. This point is important as it means that rate application executes in memory (i.e., it does NOT insert the calculation details on the database, rather, it returns them to whatever process called rate application). Because rate application executes in memory, it can be used to perform billing calculations in many parts of the system. For example:
- Both online and batch billing use rate application to calculate the charges that are eventually saved on the bill's bill segments.
- The [Rate Check](#) transaction calls rate application when you want to check a rate real-time. When you use this transaction, you enter the consumption that's passed into rate application and then rate application shows you the calculation details that result.
- Plug-ins exist that call rate application to estimate bill segments when adequate billing history doesn't exist. For example, the BUDCALC-PH budget recommendation algorithm calls rate application to calculate a budget amount for a customer without adequate history. Another example is the DEPRECOM-MBT deposit recommendation algorithm. This plug-in calls rate application to calculate a recommended deposit amount for a customer without adequate history.

Understanding Calculation Groups and Rules

This section provides descriptions of calculation groups and calculation rules, and describes how to identify components of rates that can be defined using calculation rules and groups.

About Calculation Groups and Rules

This section includes descriptions of calculation groups and calculation rules.

About Calculation Groups

Calculation groups are collections of calculation rules that are applied to calculate quantities for billing and billing charges for service agreements.

As noted previously, calculation groups are associated with specific rate schedules in one of three ways:

- **Pre-Processing Calculation Groups:** These are generally used to derive service quantities or measure measured quantities. The following illustrate some use cases of when a pre-processing calculation group might be needed:
 - When a rate contains prices for things that aren't measured directly by the customers' meters. For example, if the rate calculates a charge based on a service agreement's contracted quantity.
 - When a meter measures something in a unit of measure that has to be converted into a different unit of measure before it can be rated. For example, a meter measures gas in cubic feet, but the rate contains prices in therms. During billing, a separate bill segment calculation header is produced for each Rate Version Calculation Group used to calculate charges. An additional calculation header is added if Pre-Processing Calculation Groups create bill calculation lines and by default, all these calculation lines are linked to a single calculation header. Before invoking the rate's Pre-Processing Calculation Groups, the rate engine processor builds the initial service quantity (SQ) collection based on the item collection and final values in the read collection.
- **Rate Version Calculation Groups:** These are the calculation groups used create a bill segment for the service agreement. Calculation rules that support rate version proration such as Service Quantity, Stepped Service Quantity, Item Type, Flat Charge, Maximum and Minimum Charge, must be executed only in a rate version calculation group. When the system creates a bill segment for a service agreement, it checks if multiple Rate Version Calculation Groups are in effect during the bill period. If so, it uses the rate's **Allow RV Proration** and **RV Selection Date** values to determine if it should prorate the various Rate Version Calculation Groups, or if it should pick one of the Rate Version Calculation Groups effective during the bill period. Rate Version Calculation Groups are executed after the rate's pre-processing calculation groups.
 - **Effective Date:** defines the date on which each rate version calculation group becomes effective.
 - **Description on Bill:** Specifies the description of the rate version calculation group on the bill. This description is saved on bill calculation details created using this rate version calculation group. Substitution characters may be used to substitute variables into the description during billing. Refer to [How To Use Description on Bill](#) in the [Defining Calculation Rules](#) chapter for a discussion of the various substitution variables.
- **Post-Processing Calculation Groups:** These are similar to Pre-Processing Calculation Groups, except that these are executed after the Rate Version Calculation Groups. The intended types of functionality include applying taxes on calculated charges, or deriving more complex GL distribution. Calculation rules that support rate version proration such as Service Quantity, Stepped Service Quantity, Item Type, Flat Charge, Maximum and Minimum Charge, are not designed to be executed in post and pre-processing calculation groups. During billing, a separate bill segment calculation header is produced for each Rate Version Calculation Group used to calculate charges. An additional calculation header is added if Post-Processing Calculation Groups create bill calculation lines and by default, all these calculation lines are linked to a single calculation header.

Calculation groups can also be referenced by "Execute Calculation Group" calculation rules. See "Execute Calculation Group Rules - Nesting Calculation Rules" in [About Calculation Rules](#) for more information.

About Calculation Rules

Calculation rules are standard and custom rules that perform calculations used when calculating quantities for billing and billing charges for a customer's service agreements.

Calculation rules are created for a specific calculation group. For example, if you were configuring two calculation groups and both included a specific calculation rule, you would need to create two instances of the calculation rule, one for each group.

Attributes used to define calculation rules typically include the following:

- **Basic Information:** Basic information about the calculation rule, including its name and description, the calculation group to which the rule belongs, the sequence of the rule within the group, the description that appears on the bill, and other information. This information is standard for most calculation rules.
- **Parameters:** The parameters used by the rule. Parameters are specific to each rule. See [Base Package Calculation Rule Descriptions](#) for details about the calculation rules included with the base package.

Execute Calculation Group Rules - Nesting Calculation Rules

Execute Calculation Group rules are used to define business logic to allow reference to a separated specified calculation group. This allows rules that are used frequently to be bunched under a single calculation group, which can be referenced / called by other rules as needed. For example, if a set of standard rules should be applied to all rate schedules, this set of rules can be configured as part of a calculation group, which is referenced by a single calculation rule of this type. Execute Calculation Group rules use the following options:

- **Referred Calculation Group:** defines the calculation group referenced by the rule.
- **Characteristics:** defines additional calculation rule attributes that may be used in rate processing or for reporting purposes. A calculation rule's characteristics are copied onto the resultant bill lines for those characteristic types that are allowed on bill segment calculation lines.

Eligibility Criteria

Calculation rule eligibility criteria are user-definable conditions that could cause a given calculation rule to be applied or skipped. This can involve the evaluation of some attribute of the service agreement, or service point, or something else entirely.

A calculation rule can have multiple eligibility criteria for determining if the rule should be applied or skipped, based on a user-defined sequence. Each eligibility criteria uses the following settings:

- **Criteria Comparison:** defines the specific comparison for the criteria, based on the following:
 - **Criteria Field Type:** the means used to retrieve the value of the criteria field (algorithm, bill factor, calculation line, characteristic, contract quantity, service quantity, or historic service quantity)
 - **Comparison Operator:** the operator used in the comparison
 - **Comparison Value:** a user-specified value to which the retrieved value is compared (using the comparison operator)
- **Comparison Results:** defines how the rule should behave, based on the results of the comparison defined under Criteria Comparison:
 - **If True:** the action to take if the comparison is true
 - **If False:** the action to take if the comparison is false
 - **If Insufficient Data:** the action to take if there is insufficient data to perform the comparison

Calculation Line Category Types

Calculation line category types are used to establish connections between calculation rules. Calculation rules can specify a member category and value to which they belong. When this same category and value are referenced as a "Target Category" by other rules (the rule is applied to the results of rate version calculation rules (defined in the same rate schedule) that belong to the category and value.

For example, calculation rules whose results are subject to taxes might belong to the "Subject to Tax" (TAXABLE) category and "County Tax" value. Apply To calculation rules defined for the same rate schedule with a target category of "Subject to Tax" and "County Tax" values are applied to "Subject to Tax" member rules.

Calculation Line Category Types are defined by the following:

- **Calculation Line Category Type:** The unique identifier of a calculation line category type definition
- **Description:** The description of the calculation line category type.
- **Category Values:** The valid category values for the calculation line category type.

Base Package Calculation Rules

Oracle Utilities Customer Care and Billing includes the following base package calculation rule types that can be used when creating calculation rules:

- **Apply To:** Used to create bill lines that levy charges based on amounts calculated on other bill lines.
- **Calculate Final Reading Values:** Used to determine the final values for readings based on user-defined UOM/TOU/SQI.
- **Calculate Service Quantity:** Used to derive or calculate a service quantity that is eventually inserted into the bill segment SQ collection.
- **Copy Service Quantity From Master Bill Segment:** Used to copy all the entries from the master bill segment SQ collection to the sub bill segment SQ collection.
- **Execute Calculation Group:** Used to call and pass parameters to another calculation group.
- **Flat Charge:** Used to create bill lines that levy service charges and fees that aren't based on how much the customer uses.
- **Item Type:** Used to create bill lines that levy charges based on the number and type of items used by a customer. The system keeps track of items on the service point(s) linked to the customer's service agreement.
- **Math:** Used to derive interval data based on a formula, and apply TOU mappings and/or other operations to the derived data to calculate service quantities
- **Maximum Charge:** Used to create bill lines that levy charges only when the sum of previously calculated lines is more than the maximum charge amount.
- **Minimum Charge:** Used to create bill lines that levy charges only when the sum of previously calculated lines is less than the minimum charge amount.
- **Service Quantity:** Used to create bill lines that levy charges based on some type of consumption.
- **Simple Summary:** Used to create a "subtotal" on the bill, by summarizing bill lines produced by other calculation rules in the same calculation group.
- **Stepped Service Quantity:** Used to create bill lines that levy charges based on some type of consumption when different prices are applied to different ranges of consumption (for example, the first 50 kWh are \$0.43 per kWh, anything in excess of 50 kWh is charged at \$0.71 per kWh)
- **Summary:** Used to create a "subtotal" on the bill. It exists purely for reporting and informational purposes.

See [Base Package Calculation Rule Descriptions](#) for details about each of these calculation rules.

Designing Calculation Groups and Rules

Before starting to design calculation groups and rules for your rates, please review the concepts outlines in the **Designing Rate Components** section in the [Rates](#) chapter. That section provides a good background for understanding how to break down rates into component pieces that can be modeled by calculation groups and rules.

This section provides guidelines for how to design and plan the calculation groups and rules you will need for your rates, and provides a simple case study of how to define the calculation rules and groups you might use for a set of rates for a small municipal electric company.

Analyzing Your Rates and Identifying Calculation Rules and Groups

One of the steps you will go through when implementing your rates is to look at the bill lines for your rates and ask yourself what are the variables that cause each line's charges to be calculated the way they are. After you've determined all of the potential bill lines you can start designing your calculation groups and rules. Typically, you create one calculation rule for every line that can appear on the customer's bill. These rules can be grouped in different configurations based on how you want your bills to appear and the needs of your implementation. Recall that bill segment calculation headers are created for Pre-Processing, Rate Version, and Post-Processing calculation groups. In addition, most rules can be configured generate a bill line.

Best Practices

When designing calculation groups and rules, the following general rules apply:

- **Pre-Processing Calculation Groups.** Perform any initial processing or conversions that should occur before the rate version calculation group. This can include:
 - Calculating the number of days in a billing period (Calculate Service Quantity)
 - Calculating service quantities that are not measured (demand, kVa, etc.) (Calculate Final Reading Values, Calculate Service Quantity, Math)
 - Validating that consumption is within tolerances set by the rate (residential limits, etc.) (Calculate Service Quantity, with eligibility criteria)
- Calculations processed by calculation rules should be performed by **Rate Version Calculation Groups**. This includes most charge calculations, including:
 - Charges based on service quantities (Service Quantity, Stepped Service Quantity)
 - Customer charges (Flat Charge)
 - Minimum/maximum charges (Minimum Charge, Maximum Charge)
 - Discounts (Apply To)
 - Taxes (Apply To)
 - Summaries (Summary, Simple Summary)
- Additional processing should be performed by **Post-Processing Calculation Groups**. This can include:
 - Allocating consumption/revenue (energy revenue vs. demand revenue) (Service Quantity)

Example Configurations

Let's look at a couple of different possible configurations for a simple electric rate that includes the following:

- Customer Charge
- Service Charge (price per kWh)

- Minimum Charge
- Discount

This rate could be set up in the following ways:

- A single Rate Version calculation group that contains a calculation rule for each of the above
- A set of Rate Version calculation groups as follows:
 - A calculation group for "flat" charges, such as the Customer Charge
 - A calculation group for consumption-based charges (including the Service Charge and Minimum Charge).
 - A calculation group for discounts or other charges applied to the total of other charges (which would include the Discount)

There are no hard and fast rules concerning how calculation rules should be grouped. How this is done should be based on the specific needs of the implementation but it's a good idea to look for ways to keep your configuration simple for maintenance and upkeep purposes. This includes changes to existing rates as well as adding/removing rates over time.

Reusing Calculation Rules

One of the steps you will go through when implementing your rates is to look at the bill lines for your rates and ask yourself what are the variables that cause each line's charges to be calculated the way they are. After you've determined all of the potential bill lines you can start designing your calculation groups and rules. Typically, you create one calculation rule for every line that can appear on the customer's bill. These rules can be grouped in different configurations based on how you want your bills to appear and the needs of your implementation. Recall that bill segment calculation headers are created for Pre-Processing, Rate Version, and Post-Processing calculation groups. In addition, most rules can be configured generate a bill line.

Identifying Calculation Rules that can be Shared/Reused

As you analyze the bill lines used by your rates, you should look for bill lines that utilize similar or identical variables or calculations. These calculations are candidates for reuse. For example, if all of your residential rates offer a discount for early payment, you would want to create a single rule to calculate that discount, and then use it each of the rates to which it applies.

How to Reuse Calculation Rules

There are two approaches that can be used to reuse calculation rules.

- **Encapsulating Rules in a Calculation Group**

This approach involves grouping rules that can be applied to more than one rate into a single calculation group. You would use this approach when you identify charges and other components in your rates that apply to multiple rates, but that can be grouped together. Taxes for multiple types of jurisdictions (for example, State, County, and City) would be suitable for this approach.

To use this approach, you simply create a calculation group that contains the rules to be applied to more than one rate. For the tax example, you might create the following group and rules:

Calculation Group: Taxes, which includes:

Calculation Rule: State Tax (Apply To)

Calculation Rule: County Tax (Apply To)

Calculation Rule: City Tax (Apply To)

This "Taxes" calculation group can be included as a Rate Version Calculation Group in each of the rates to which the taxes apply. This calculation group could also be referenced by an "Execute Calculation Group" rule, as outlined below.

- **Using "Execute Calculation Group" Rules**

This approach involves creating a calculation group that contains one or more rules, which is then referenced by another "Execute Calculation Group" rule. This approach can be used when you identify a charge or calculation that could be applicable within one or more calculation groups. For example, if multiple rates involve calculating peak demand (or some other quantity that is not measured by your customers' meters), you could create a "Calculate Demand" rule and include it in a group that is then referenced by an "Execute Calculation Group" rule.

To use this approach, you create a calculation group that contains the calculation rules to be used within multiple calculation groups. You then create an "Execute Calculation Group" rule that references the group. Last, you include this "Execute Calculation Group" rule in the calculation groups to which it applies. For the calculate demand example, you might create the following:

Calculation Rule: Calculate Demand (Execute Calculation Group), which references:

Calculation Group: Calculate Demand, which includes:

Calculation Rule: Calculate Demand (Calculate Service Quantity)

The "Calculate Demand" Execute Calculation Group rule can be included in any calculation group used to calculate service quantities that includes calculating peak demand.

"Execute Calculation Group" rules can be used with any calculation group. To return the taxes example from above, if you wanted to include your "Taxes" calculation group within other groups, you could use the following:

Calculation Rule: Taxes (Execute Calculation Group), which references:

Calculation Group: Taxes, which includes:

Calculation Rule: State Tax (Apply To)

Calculation Rule: County Tax (Apply To)

Calculation Rule: City Tax (Apply To)

See "Execute Calculation Group Rules - Nesting Calculation Rules" in [About Calculation Rules](#) for more information about Execute Calculation Group rules.

Leveraging Eligibility Criteria to Dynamically Apply Calculation Rules

Another tool to consider when creating your calculation groups and rules is Eligibility Criteria. Eligibility criteria allow you to define rules that determine the conditions under which a calculation rule is applied or not.

For example, if you need to calculate demand for one or more of your rates, you might create separate calculation rules to calculate demand based on interval values of different units of measure (kWh vs kVarh for instance). You could create rules for each and include them in a single "Calculate Demand" calculation group, but assign eligibility criteria to each such that they are only executed when processing for the specified unit of measure.

See Eligibility Criteria in [About Calculation Rules](#) for more information about eligibility criteria and how they can be used with calculation rules. In addition, refer to **The Big Picture of Rate Component Eligibility Rules** in the [Rates](#) chapter for additional background on eligibility criteria.

Case Study: Three Sample Rates

Let's look at a sample set of rates, and how they might be implemented. We'll also look at which components of these rates can be shared.

Rates

The following rates are electric rates offered by a small municipal electric company.

Rate	Domestic Rate A	Commercial Rate B	Power Rate C
Cost of Service	Stepped charges, as follows:	Stepped charges, as follows:	1. Customer Charge:\$52.00

Rate	Domestic Rate A	Commercial Rate B	Power Rate C
	<p>\$3.08 for the first 10 kWh or less, plus</p> <p>19.23 cents per kWh for the next 40 kWh, plus</p> <p>15.44 cents per kWh for the next 150 kWh, plus</p> <p>14.93 cents per kWh for the next 300 kWh, plus</p> <p>14.71 cents per kWh for all kWh in excess of 500 kWh</p>	<p>\$2.95 for the first 10 kWh or less, plus</p> <p>19.23 cents per kWh for the next 40 kWh, plus</p> <p>18.85 cents per kWh for the next 50 kWh, plus</p> <p>16.86 cents per kWh for the next 400 kWh, plus</p> <p>15.45 cents per kWh for the next 3,000 kWh, plus</p> <p>14.87 cents per kWh for all kWh in excess of 3,500 kWh.</p>	<p>2. Demand: \$11.44 per KW</p> <p>3. Energy: \$11.28 cents per KWH</p> <p>Billing Demand</p> <p>The Billing Demand for any month shall be the greater of the following:</p> <ol style="list-style-type: none"> 1. The maximum 15 minute measured demand during the month as measured in kilowatts, or 2. 70% of the maximum 15 minute measured demand as so determined during the preceding 11 months.
Discount	<p>Discount of ½ cent per kilowatt-hour after the first 10 kilowatt-hours, if paid on or before the discount expiration date.</p> <p>For qualifying elderly residents, an additional 10% discount is allowed on the basic rate if paid on or before the discount expiration date and no arrears exist on their accounts.</p>	Discount of ½ cent per kilowatt-hour after the first 10 kilowatt-hours, if paid on or before the discount expiration date.	Discount of 10% exclusive of purchased power and fuel adjustment charge paid on or before the discount expiration date.
Purchased Power and Fuel Adjustment	<p>An upward or downward adjustment applied to all kWh sold, based on the total cost of purchased power and fuel compared to the portion of that cost contained in the base rate (11.615 cents/kWh).</p> <p>The purchase power and fuel adjustment shall be rounded to the sixth decimal place and shall be applied to all kilowatt-hours sold in the following month.</p>	See Domestic Rate A	See Domestic Rate A
Misc.	N/A	N/A	Minimum Bill The Customer Charge
Taxes	State, County, and City Taxes	State, County, and City Taxes	State, County, and City Taxes

Calculation Rules

Now let's look at these same rates in terms of how we might implement them using calculation rules. The table below lists the type of calculation rule used for each item on the rate.

Rate	Domestic Rate A	Commercial Rate B	Power Rate C
Cost of Service	Stepped Charges:	Stepped Charges:	Customer Charge: <ul style="list-style-type: none"> • Flat Charge calculation rule

Rate	Domestic Rate A	Commercial Rate B	Power Rate C
	<ul style="list-style-type: none"> Stepped Service Quantity calculation rule Minimum Charge calculation rule (note that the first tier is a fixed price for the first 10 kWh or less) 	<ul style="list-style-type: none"> Stepped Service Quantity calculation rule Minimum Charge calculation rule (note that the first tier is a fixed price for the first 10 kWh or less) 	Demand: <ul style="list-style-type: none"> Service Quantity calculation rule Math calculation rule (to calculate demand from interval values)* Energy: <ul style="list-style-type: none"> Service Quantity calculation rule *Could be included in either a Pre-Processing or Rate Version Calculation Group
Discount	Discount: <ul style="list-style-type: none"> Apply To calculation rule Elderly Discount: <ul style="list-style-type: none"> Apply To calculation rule 	Discount: <ul style="list-style-type: none"> Apply To calculation rule 	Discount: <ul style="list-style-type: none"> Apply To calculation rule
Purchased Power and Fuel Adjustment	PPF Adjustment: <ul style="list-style-type: none"> Service Quantity calculation rule Note: The PPF adjustment rate would be defined as a Bill Factor, updated monthly based on the prior month's total cost.	PPF Adjustment: <ul style="list-style-type: none"> Service Quantity calculation rule 	PPF Adjustment: <ul style="list-style-type: none"> Service Quantity calculation rule
Misc.	N/A	N/A	Minimum Bill: <ul style="list-style-type: none"> Minimum Charge calculation rule
Taxes	State, County, and City Taxes: <ul style="list-style-type: none"> Apply To calculation rule (one for each type of tax) 	State, County, and City Taxes: <ul style="list-style-type: none"> Apply To calculation rule (one for each type of tax) 	State, County, and City Taxes: <ul style="list-style-type: none"> Apply To calculation rule (one for each type of tax)

Shared Components

Now, let's look at the components of these rates that can be shared.

Discounts: Rates A and B both use the same discount, so we could create a single "AB Discount" calculation rule that could be used with both rates. Note: Either this could be in its own calculation group that is listed among the Rate Version Calculation Groups for each rate, or the group could be referenced by an "Execute Calculation Group" rule which in turn would be included in one of the other Rate Version Calculation Groups used in each rate.

Purchased Power and Fuel Adjustment: Rates A, B, and C all use the same adjustment for purchased power and fuel, so we could create a single "PPF Adjustment" calculation rule that could be used with all three rates. Again, this calculation rule could be in its own calculation group listed on the rate, or in a group referenced by an "Execute Calculation Group" rule included in another group.

Taxes: Rates A, B, and C are all subject to the same taxes, so we could create calculation rules for each type of tax (State, County, and City) in a single group that could be used with all three rates. Again, these calculation rules could be in their

own calculation group listed on the rate, or in a group referenced by an "Execute Calculation Group" rule included in another group.

The Big Picture of Calculation Rule Eligibility Rules

You can use eligibility rules to define the criteria when a calculation rule should be applied (or skipped); for example,

- You may have a calculation rule that generates an employee discount. This calculation rule may have eligibility criteria that requires the person to have a given characteristic type and value (this assumes you use a person characteristic to identify employees) before the calculation rule is applied.
- You may have a calculation rule that applies a surcharge if the customer uses 25% more than they used in the same period in prior year.

NOTE:

Eligibility rules are optional. If you add eligibility rules to a calculation rule, the calculation rule will be skipped or applied per the instructions in the rules. If you don't add eligibility rules to a calculation rule, however, the calculation rule will be executed – this is because calculation rules are eligible by default

The topics in this section describe eligibility rules.

A Rate Component is Eligible by Default

If you don't want to setup eligibility rules, you don't have to. If you don't specify eligibility rules on a calculation rule, it's eligible and will be processed by rate application.

Defining Logical Eligibility Criteria

When you setup an eligibility criterion, you must define three things:

- The field to be compared
- The comparison method
- The comparison results

Criteria Comparison

You have the following choices in respect of identifying the **Criteria Field Type**:

- **Algorithm.** You can execute an algorithm to retrieve a field value from someplace else in the system. This is a very powerful feature, but it's not terribly intuitive. We'll present an example later in this section to illustrate the power of this approach.
- **Bill Factor.** You can retrieve a bill factor value to use as a field value in the comparison.
- **Calc Line.** You can retrieve a calculation line amount to use as a field value. The value is derived by summing calculation lines defined as members of a target category.
- **Characteristic.** You can retrieve a characteristic value linked to any of the following:
 - The service agreement being billed
 - The service agreement's account
 - The main person linked to the service agreement's account

- The characteristic premise linked to the service agreement
- One of the service points linked to the service agreement
- In addition, you can retrieve a characteristic value from the Characteristic Collection where values are derived while the rate is being calculated (characteristic values can be created by calculation rules)
- **Contract Quantity.** You can retrieve a contract quantity for the service agreement.
- **Service Quantity.** You can retrieve the value of a given service quantity from the SQ collection based on a specified UOM / TOU / SQL.
- **Historical Quantity.** You can derive a value based on the service agreement's historical bill segment service quantities for the specified UOM / TOU / SQL.

You have the following choices in respect of identifying the **Comparison Method**:

- You can choose an operator (e.g., >, <, =, BETWEEN, IN, etc.) and a comparison value

Comparison Results

Once you have this information and have applied your comparison, you must define what action should be taken. You must specify what to do if the results are True, False, or Insufficient Data.

- **If True or False.** You have the option to apply the rule or not, or check the next condition.
- **If Insufficient Data.** You have the option apply the rule or not, check the next condition, or generate an error.

See [Examples of Calculation Rule Eligibility Rules](#) for illustrations of these rules.

Examples of Calculation Rule Eligibility Rules

The topics in this section provide examples about how to setup calculation rule eligibility rules.

A Calculation Rule with a Service Quantity Comparison

Imagine a calculation rule that is only eligible if the customer is a low-income customer and has used more than 1,000 kWh. This calculation rule would need the following eligibility rules:

- Customer is a low income customer
- The customer has used more than 1,000 kWh during the bill period

These rules will look as follows:

Seq	Field to Compare	Comparison Method	If TRUE	If FALSE	If Insufficient Data
10	Main person characteristic: Characteristic type = Low income indicator	= YES	Check next condition	Do Not Apply Rule	Do Not Apply Rule
20	SQ value: UOM = KWH	>= 1,000	Apply Rule	Do Not Apply Rule	Error

The criteria are similar - they retrieve a value and compare it to something:

The first criterion is fairly simple:

- **Field to Compare.** We indicate that the value of the Low Income Indicator characteristic is kept on the main person linked to the account should be retrieved. We assumed that this characteristic type has values of YES and NO.
- **Comparison Method and Results.** We indicate that if the person has a characteristic value of YES, then we should check the next condition; otherwise, we indicate if the eligibility rule is false or there is insufficient data, the calculation rule is skipped.

The second criterion works similarly:

- **Field to Compare.** We indicate the service quantity (SQ) that holds the total amount of KWH that should be retrieved.
- **Comparison Method and Results.** We simply compare the value to 1,000. If the SQ is greater than or equal to 1000, the eligibility rule is True and the calculation rule is applied. If the SQ is less than 1000, the eligibility rule is false and the calculation rule is skipped. If there is insufficient data, there is an error generated.

A Calculation Rule with a Characteristic Lookup and Consumption Comparison

Imagine a calculation rule that is eligible for customers who have signed up for a consumption reduction program and have low consumption. This would require the following criteria:

- Check that the customer has signed up for the reduction program.
- Check to see that the customer's consumption is lower than the threshold.

These rules will look as follows:

Seq	Field to Compare	Comparison Method	If TRUE	If FALSE	If Insufficient Data
10	Check if the customer has signed up for the reduction program	= Y	Check next condition	Do Not Apply Rule	Do Not Apply Rule
20	Check if consumption is less than the threshold	< = 100 Kilowatt	Apply Rule	Do Not Apply Rule	Do Not Apply Rule

The criteria are similar - they retrieve a value and compare it to something:

The first criterion works as follows:

- **Field to Compare.** We indicate the value of the reduction program characteristic type (CI_CLMSM) is found on the service agreement. We assumed that this characteristic type has values of Y and N.
- **Comparison Method and Results.** Comparison Method and Results. We indicate that if the service agreement has a characteristic value of Y, then we should check the next condition. If the condition is false or insufficient data, the calculation rule is skipped.

The second criterion works as follows:

- **Field to Compare.** We indicate the service quantity (SQ) that holds the total amount of KW that should be retrieved.
- **Comparison Method and Results.** We indicate that we want to compare the service quantity to the threshold (100 kW). If the service agreement's bill segment has a service quantity that is less than or equal to 100 kW, it is True and the calculation rule is applied. If the condition is false or insufficient data, the calculation rule is skipped.

A Calculation Rule with a Discount for Being on Autopay

Imagine a calculation rule that is only eligible if the current customer has signed up for Autopay. This calculation rule would need the following eligibility rule:

- Customer has Autopay

This rule will look as follows:

Seq	Field to Compare	Comparison Method	If TRUE	If FALSE	If Insufficient Data
10	Algorithm: check if customer has Autopay	= Y	Apply Rule	Do Not Apply Rule	Do Not Apply Rule

The criterion calls an algorithm that performs a logical comparison.

The criterion works as follows:

- **Field to Compare.** We chose a "field to compare" algorithm that checks if the account associated with the bill segment is on Autopay. If an autopay setup exists, then it returns a value of Y. If not, however, it returns N
- **Comparison Method and Results.** We simply compare the value returned by the algorithm to Y and indicate the appropriate response. If the condition is true, the calculation rule is applied. If the condition is false or insufficient data, the calculation rule is skipped.

NOTE:

Refer to CI_CHK_APAY for more information about this algorithm.

Working with Calculation Groups and Rules

This section outlines how users work with calculation groups and calculation rules.

Defining Calculation Groups

Use this procedure to define calculation groups.

- Select **Menu > Rates > Calculation Group > Add.**
- Enter a **Name** for the calculation group.
- Enter a short **Description** and **Detailed Description** for the group.
- Click **Save.**

NOTE: You can also add a calculation group directly from the Rate Schedule portal. The **Add Calculation Group** action on the Pre-Processing Calculation Groups, Rate Version Calculation Groups and Post-Processing Calculation Groups sections allows you to create the calculation group and link the new group to the Rate Schedule.

To add a calculation rule to the calculation group, click the **Add Rule** link in the **Calculation Rules List** zone title bar. See [Defining Calculation Rules](#) for more information about creating calculation rules.

You can now create calculation rules for this group.

See [About Calculation Groups](#) for more information about calculation groups.

Searching and Maintaining Calculation Groups

Use this procedure to search for and view a calculation group.

- Select **Menu > Rates > Calculation Group > Search.**
- Enter your search criteria.

You can search by **Calculation Group** name or **Description**.

- Click **Refresh**.
- In the search results list, click the **Description** link for the calculation group you want to view or edit. The selected calculation group is displayed in the **Calculation Group** portal. You use this portal to maintain calculation groups. This portal includes the following zones:
 - **Calculation Group**: Defines basic information about calculation group
 - **Calculation Rules List**: lists the calculation rules belonging to the group. Eligibility criteria referenced by a calculation rule are listed indented beneath each rule. If a calculation rule in turn references a calculation group, the calculation group executed by the rule is displayed.
 - **Referencing Rates Schedules List**: lists the rates schedules that reference the group
 - **Referencing Calculation Rules List**: lists the calculation rules that reference the group

Use this procedure to maintain a calculation group:

- Select **Menu > Rates > Calculation Group > Search** to navigate to the Calculation Group Query portal.
- Search for and select the appropriate calculation group.
- Click **Edit**, **Delete**, or **Duplicate** as appropriate.
- To add a calculation rule to the calculation group, click the **Add Rule** link in the **Calculation Rules List** zone title bar. See [Defining Calculation Rules](#) for more information about creating calculation rules.
- To update the sequence values for all calculation rules in the group, click the **Resequence All Rules** link in the **Calculation Rules List** zone title bar.
 - Edit the sequence values for all rules by specifying new **Start Sequence** and **Increment By** values.
 - Click **OK** to update the calculation rules with new sequence numbers.
- To Edit or Delete a specific calculation rule in the group, select the **Edit** or **Delete** icon in the Calculation Rules List zone as appropriate.
- To Delete one or more of the calculation rules in the group:
 - Select one or more of the calculation rules you want to delete.
 - Click **Delete Calc Rules**.
 - Click **OK** to delete the selected calculation rules
- To update the bill print details for one or more of the calculation rules in the group:
 - Select one or more of the calculation rules for which you want to change the bill print details.
 - Click **Update Bill Print**.
 - Edit the bill print details for the selected calculation rules.
 - Click **Save** to update the selected calculation rules with the new bill print details.
- To change the sequence values for one or more of the calculation rules in the group:
 - Select one or more of the calculation rules for which you want to change the sequence values.
 - Click **Resequence Rules**.
 - Edit the sequence values for all the selected calculation rules.
 - Click **Save** to update the selected calculation rules with the new sequence values.

See [About Calculation Groups](#) for more information about calculation groups.

Defining Calculation Line Category Types

Use this procedure to define calculation line category types.

- Select **Menu > Rates > Calculation Line Category Type > Add.**
- Enter a **Category Type** name for the category type.
- Enter a short **Description** and **Detailed Description** for the category type.
- Define the **Category Value** and **Description** for each value for the category type.
- Click **Save.**

You can now reference this category and its values as either the Member Category or Target Category on calculation rules.

See "Calculation Line Category Types" in [About Calculation Rules](#) for more information about calculation line category types.

Maintaining Calculation Line Category Types

Use this procedure to search for and maintain calculation line category types.

- Select **Menu > Rates > Calculation Line Category Type > Search.**
The **Calculation Line Category Type List** zone displays the calculation line category types defined in the system.
- Click the broadcast icon for the calculation line category type you wish to view and/or edit.
The selected calculation line category type is displayed in the **Calculation Line Category Type** zone.
- Click **Edit, Delete,** or **Duplicate** as appropriate.

See "Calculation Line Category Types" in [About Calculation Rules](#) for more information about calculation line category types.

Defining Calculation Rules

Use this procedure to define calculation rules.

- Select **Menu > Rates > Calculation Rule > Add.**
- Select the **Calculation Group** to which the rule will belong.
- Select the **Calculation Rule BO** for the calculation rule.
Refer to [Base Package Calculation Rule Descriptions](#) for detailed descriptions of the available calculation rules and their associated business objects.
- Enter name for the **Calculation Rule.**
- Enter the **Sequence** for the rule. This designates the order in which the rule will be executed within its parent calculation group.
- Enter a short **Description** and **Detailed Description** for the rule.
- Enter or select other parameters for the rule as appropriate.
Refer to [Base Package Calculation Rule Descriptions](#) for detailed descriptions of the available calculation rules and the parameters used by each.
- Click **Save.**

See [About Calculation Rules](#) for more information about calculation rules.

How to Use Description on Bill

Enter the verbiage to appear on the bill segment in the **Description On Bill**. Turn on **Print** if the verbiage should appear on the printed bill.

NOTE:

Suppressing calculation details on the printed bill. Only calculation rules that are used to calculate intermediate values are typically suppressed on a bill. For these types of calculation rules, we recommend using **Description on Bill** to show users how the line was calculated, but select No from the **Print** dropdown menu. This way, users will see the calculation details on the [Bill Segment - Calc Lines](#) window, but the customer won't see it on their bill.

Many lines that appear on a bill do not contain static verbiage. Rather, the printed lines contain information from the calculation process. For example, the bill line for state tax would typically contain the tax percent.

You control exactly what is substituted in the bill line by entering one or more of the following substitution variables in the **Description on Bill** field:

NOTE: If none of the following substitution characters satisfy your need, there is a plug-in option on the calculation rule business object that allows customer modified variables. Algorithms can be attached to the business object as a Build Line Description system event.

Substitution Character	What It Does
%A	<p>Replaces the substitution character with the amount of the bill line.</p> <p>Please be aware of the following:</p> <ul style="list-style-type: none">• If the calculation rule isn't designated as being "for calculation purposes only" (FCPO), all trailing zeroes up to the decimal position of the rate's currency will be removed. If the calculation rule is designated as being "for calculation purposes only" (FCPO), the number of decimal places as defined in the calculation rule's precision will be shown.• All leading zeroes will be removed unless the value is between 1 and -1 in which case a leading 0 will appear before the decimal place.• The Symbol on the Currency control table will prefix the value.• The position of the negative sign and currency symbol is dependent on the display profile of the user who generate the bill (or who submitted the batch billing process).
%B	<p>Replaces the substitution character with the begin/start date covered by the bill calculation line.</p> <p>If the charge is proratable, %B may be used in conjunction with %E to display the period covered by the bill calculation line.</p>
%C	<p>Replaces the substitution character with the number of items being billed. Leading zeroes are suppressed.</p>
%D	<p>Replaces the substitution character with message 10101 from message category 11109. This message is maintained in the standard message table.</p>

We recommend this message be set to "(prorated for %1 of %2 days)" where %1 will be substituted with the number of days of prorated consumption charged on the bill line and %2 will be the "normal" days associated with the rate's prices. This message will only be substituted when the calculation rule is prorated. Note, neither %1 nor %2 are required.

Either this character OR %F should be used when you desire to substitute the price / percent into the bill line.

If the charge is proratable, %D should be used in conjunction with %R to print an appropriate message when the charges are prorated.

%E

Replaces the substitution character with the end date covered by the bill calculation line.

If the charge is proratable, %E may be used in conjunction with %B to display the period covered by the bill calculation line.

%F

Replaces the substitution character with message 10102 from message category 11109. This message is maintained in the standard message table.

We recommend this message be set to "(prorated by %1)" where %1 will be substituted with the factor used to prorate the charge. This message will only be substituted when the calculation rule is prorated. Note, %1 is not required.

If the charge is proratable, %F should be used in conjunction with %I to print an appropriate message when the charges are prorated.

%H

Replaces the substitution character with the high value defined on the calculation rule used to calculate the specific stepped charge on the bill line.

%I

Replaces the substitution character with the value specified in the calculation rule / bill factor.

If the value is a percent,

- all leading and trailing zeroes will be suppressed,
- and a "%" will be suffixed to the resultant value.

If the value is not a percent,

- all trailing zeroes up to the decimal position of the rate's currency will be removed,
- and all leading zeroes will be removed unless the value is between 1 and -1 in which case a leading 0 will appear before the decimal place,
- and note that the position of the negative sign and currency symbol is dependent on the display profile of the user who generate the bill (or who submitted the batch billing process).

Either this character OR %R should be used when you desire to substitute the price / percent into the bill line. Using %I will cause the value as specified in the calculation rule to be substituted regardless of whether the charges are prorated.

If the charge is proratable, %I should be used in conjunction with %F to print an appropriate message when the charges are prorated.

%L	Replaces the substitution character with the low value defined on the calculation rule used to calculate the specific stepped charge on the bill line.
%M	Replaces the substitution character with the item type defined on the calculation rule used to calculate the specific item type charge on the bill line. This is only applicable to calculation rule-based rates.
%O	Replaces the substitution character with the description of the time-of-use (TOU) code being billed on this line
%Q	Replaces the substitution character with the service quantity being billed. Leading zeroes are suppressed. The decimal places shown are specified in a field on the Unit Of Measure control table. If you wish to suppress trailing zeroes after the decimal, you must set up the Allow Consumption Zero Suppression In Bill Description option type on the Financial Transaction Options Feature Configuration .
%R	Replaces the substitution character with the value specified in the calculation rule / bill factor. Either this character OR %I should be used when you desire to substitute the price / percent into the bill line. Using %R causes the prorated price / percent to be printed in the bill line (%I causes the price / percent as specified in the rate to be printed during proration situations). If the charge is proratable, %R should be used in conjunction with %D to print an appropriate message when the charges are prorated.
%S	Replaces the substitution character with the summed amount. All trailing zeroes up to the decimal position of the rate's currency will be removed. All leading zeroes will be removed unless the value is between 1 and -1 in which case a leading 0 will appear before the decimal place. The Symbol on the Currency control table will prefix the value. If the value is negative, a "-" will prefix the value. This character should only be used with Minimum, Apply To, and Summary calculation rules.
%T	Replaces the substitution character with message 10103 from message category 11109. This message is maintained in the standard message table. We recommend this message be set to "(%1% exempt)" where %1 will be substituted with the tax exemption percent as specified in the service agreement. This message will only be substituted when the calculation rule's bill factor is eligible for tax exemptions AND the customer is exempt from the tax. Note, %1 is not required.
%V	Replaces the substitution character with the "C1-ADDSC" characteristic ad hoc value retrieved by the calculation rule used to calculate the charge on the bill line.
Lines that don't print	If the bill line is not printed (as defined by the Print option), message 10104 from message category 4 will be appended to the bill line. This message is maintained in the standard message table. We recommend this message be "NOT SEEN BY CUSTOMER!" This message appears in the bill line that appears in the billing windows but does not appear on the customer's bill.

The following are examples of the content of common **Description on Bills** along with how the line would look on the customer's bill:

Description on Bill On Calculation Rule	How It Looks On A Bill
%C lamp pole(s) at %I per pole %F	1,234 lamp pole(s) at \$5.00 per pole (prorated by .3333)
%C lamp pole(s) at %R per pole %D	1,234 lamp pole(s) at \$1.50 per pole (prorated for 10 of 30 days)
First %Q kWh at %I per kWh %F	First 100.32 kWh at \$0.12349 per kWh (prorated by .3333)
First %Q kWh at %R per kWh %D	First 100.32 kWh at \$0.12349 per kWh (prorated for 10 of 30 days)
%Q kWh at %I per kWh	100.32 kWh at \$0.12349 per kWh
State sales tax %R %T	State sales tax 6.25% (50% exempt)
Minimum charge of %I %F	Minimum charge of \$10.00 (prorated by .3333)
Subtotal of %S	Subtotal of \$1,123.23
Charges for %O: %Q kW at %I per kW	Charges for Off Peak Winter: 234.43 kW at \$0.05 per kW

The prorated references will only appear if the calculation rule's charges are prorated due to a short or long bill period.

Searching and Maintaining Calculation Rules

Use this procedure to search for and maintain calculation rules.

- Select **Menu > Rates > Calculation Rule > Search.**
- Enter your search criteria.
Available query options include **Calculation Rule** and **Calculation Rule BO**.
 - When searching by **Calculation Rule**, you can search by **Calculation Group**, **Calculation Rule** name, or **Description**.
 - When searching by **Calculation Rule BO**, you can search by **Business Object**, or **Description**.
- Click **Refresh**.
- In the search results list, click the **Description** link for the calculation rule you want to view or edit. To navigate to the rule's calculation group, click the **Calculation Group** link.
The selected calculation rule is displayed in the **Calculation Rule** portal. You use this portal to maintain calculation rules. This portal includes the following zones:
 - **Calculation Rule:** Defines basic information about calculation rule
 - **Eligibility Criteria List:** Lists optional eligibility criteria for the current calculation rule. Eligibility criteria are used to determine whether a calculation rule should be applied (or skipped) during rate processing.

Use this procedure to maintain a calculation rule:

- Select **Menu > Rates > Calculation Rule > Search** to navigate to the Calculation Rule Query portal.
- Search for and select the appropriate calculation rule.
- Click **Edit**, **Delete**, or **Duplicate** as appropriate.
- To define eligibility criteria for the rule, click the **Add** link in the **Eligibility Criteria List** zone title bar. See "Eligibility Criteria" in [About Calculation Rules](#) for more information.

See [About Calculation Rules](#) for more information about calculation rules.

Defining Calculation Rule Eligibility Criteria

Use this procedure to define eligibility criteria for a calculation rule.

Prerequisites: You must create a calculation rule before you can define eligibility criteria.

- Click the **Add** link in the **Eligibility Criteria List** zone title bar.
- Enter a **Sequence** number, **Description**, and **Detailed Description** for the criteria.
- Complete the **Criteria Comparison** section as follows:
 - **Criteria Field:** the means used to retrieve the value of the criteria field (algorithm, bill factor, calculation line, characteristic, contract quantity, service quantity, or historic service quantity)
 - **Comparison Operator:** the operator used in the comparison
 - **Value:** a user-specified value to which the retrieved value is compared (using the comparison operator)
- Complete the **Comparison Results** section as follows:
 - **If True:** the action to take if the comparison is true
 - **If False:** the action to take if the comparison is false
 - **If Insufficient Data:** the action to take if there is insufficient data to perform the comparison
- Click **Save**.

See [The Big Picture of Calculation Rule Eligibility Rules](#) for more information.

Creating Rate Schedules

This section outlines how users work with rate schedules.

Defining Rate Schedules

Use this procedure to define rate schedules.

Prerequisites: You must configure an instance of the **Rate Engine Configuration** master configuration in order to create and/or maintain rate schedules.

- Select **Menu > Rates > Rate Schedule > Add**.
The Rate Schedule maintenance screen opens. To navigate to the Component-Based Rate Schedule page, click **Switch to Component-Based**.
- Enter a code for the **Rate Schedule**.
- Enter a short **Description** for the rate schedule.
- Select the **Service Type** (Electric Service, Gas Service, etc.) for the rate schedule.
- Select the **Frequency** (monthly, quarterly, etc.) for the rate schedule
- Select the **Currency Code** used with the rate schedule.
- Select whether or not the rate schedule will **Allow Estimates** when performing calculations.
- Select whether or not the rate schedule will **Allow RV Proration** when performing calculations.
- Select the **RV Proration Date**, used if the rate schedule does NOT allow RV proration. Valid options include Accounting Date, Bill End Date, and Bill Start Date.

- Define the **Pre-Processing Calculation Groups** used by the rate schedule. If the calculation groups do not exist yet, use the **Add Calculation Group** action to add each new calculation group and link it to the rate schedule. Refer to the embedded help for more information.

For each pre-processing calculation group, specify:

- **Sequence:** The sequence in which the group is executed when the pre-processing groups are processed.
- **Description:** A description of the calculation group
- **Calculation Group:** The calculation group.

Use the **Add/Remove Links** action on each calculation group to maintain the cross-references between the rules in the group. This action includes an ability to maintain a rule's target categories.

- Define the **Rate Version Calculation Groups** used by the rate schedule. If the calculation groups do not exist yet, use the **Add Calculation Group** action to add each new calculation group and link it to the rate schedule. Refer to the embedded help for more information.

For each rate version calculation group, specify:

- **Effective Date:** The date on which each rate version calculation group becomes effective
- **Description on Bill:** Specifies the description of the rate version calculation group on the bill. This description is saved on bill calculation details created using this rate version calculation group. Substitution characters may be used to substitute variables into the description during billing. Refer to [How To Use Description on Bill](#) for a discussion of the various substitution variables.
- **Calculation Group:** The calculation group.

Use the **Add/Remove Links** action on each calculation group to maintain the cross-references between the rules in the group. This action includes an ability to maintain a rule's target categories.

- Define the **Post-Processing Calculation Groups** used by the rate schedule. If the calculation groups do not exist yet, use the **Add Calculation Group** action to add each new calculation group and link it to the rate schedule. Refer to the embedded help for more information.

For each post-processing calculation group, specify:

- **Sequence:** The sequence in which the group is executed when the post-processing groups are processed.
- **Description:** A description of the calculation group
- **Calculation Group:** The calculation group.

Use the **Add/Remove Links** action on each calculation group to maintain the cross-references between the rules in the group. This action includes an ability to maintain a rule's target categories.

- Define one more recommended **Meter Configuration Types** for meters linked to service agreements (by way of their service points) for the rate schedule.
- Define one or more **Bill Messages** that should appear on bills that use the rate schedule. For each message, specify
 - **Bill Message:** The message that should appear on the bill.
 - The **Start Date** and **End Date** when the bill message should appear on the bill. Leave **End Date** blank if the message should appear indefinitely,
- Click **Save**.

This rate schedule can now be referenced on service agreements.

Searching and Maintaining Rate Schedules

Use this procedure to search for and view a rate schedule.

Prerequisites: You must configure an instance of the **Rate Engine Configuration** master configuration in order to create and/or maintain rate schedules.

- Select **Menu > Rates > Rate Schedule > Search**.
- Enter your search criteria.
You can search by **Rate Schedule**, **Description**, or **Rate Engine** (Calculation Rule-Based or Component-Based).
- Click **Search**.
- In the search results list, click the **Description** link for the rate schedule you want to view or edit.

NOTE: Component-based rate schedules will be highlighted by having "(Component-Based)" appended to their listing in the search results.

- The selected rate schedule is displayed in the (Calculation Rule-Based) **Rate Schedule** portal. You use this portal to maintain rate schedule. This portal includes the following zones:
 - **Rate Schedule:** Defines basic information about the rate schedule.
 - **Rate Schedule Tree:** Displays the hierarchy of Calculation Groups and Calculation Rules for the Rate Schedule. Only the most recent rate version calculation group is initially displayed. In this zone you can:
 - Click a calculation group or calculation rule link to go to the Calculation Group or Calculation Rule portal for the associated calculation group or calculation rule.
 - Click the Broadcast icon for a calculation rule to open the Cross Reference Rule zone. This zone displays the rate schedule's calculation rules that are members of the broadcast calculation rule's target category.
 - Click the **Show All Rate Versions** button to display all rate versions for the rate schedule. This will also display the **Show Effective Rate Version** button, which you can use to display the information for the most recent rate version.

Use this procedure to maintain a rate schedule:

- Select **Menu > Rates > Rate Schedule > Search** to navigate to the Rate Schedule Query portal.
- Search for and select the appropriate rate schedule.
 - The selected rate schedule is displayed in the (new) **Rate Schedule** portal.
 - Click **Edit**, **Delete**, or **Duplicate** as appropriate.

NOTE:

If you select a component-based rate schedule, the selected rate schedule is displayed in the (component-based) **Rate Schedule** page.

Base Package Calculation Rule Descriptions

This section provides detailed descriptions of each of the base package calculation rules provided with Oracle Utilities Customer Care and Billing. The descriptions of the calculation rules below contain the following information

- **Rule Name:** The name of the rule
- **Base Package Calculation Rule Business Object:** The base package business object used by the rule
- **Apply Calculation Rule Algorithm Type / Algorithm:** The base package algorithm type and algorithm specified in the "Apply Calc Rule" system event for the rule
- **Rule Parameters:** Parameters used to define the rule (if applicable). Does not include common parameters used by all rules (see Common Parameters).

- **Example:** One or more example configurations of the rule. Note that all examples use default values for all Apply Calculation Rule Algorithm Parameters.

Common Parameters

All calculation rules use the following common parameters:

- **Calculation Group:** The calculation group to which the rule belongs
- **Calculation Rule:** The user-defined name given to the calculation rule
- **Sequence:** The relative position of the calculation rule in respect of the other rules in the calculation group. This controls the order in which the system performs the calculation.
- **Description:** A short description of the rule. This is used as the Information String for the rule in the user interface.
- **Detailed Description:** A detailed description of the rule.

In addition, several of the base package calculation rules also use the following parameters:

- **Description On Bill:** The text that appears on the bill line generated for this calculation rule. Variables can be used to dynamically generate text (such as, price and quantity) when billing calculates the charges. Refer to [How To Use Description on Bill](#) for more information about available substitution variables.
- **Print (Yes or No):** A flag that specifies if the bill line created by this calculation rule should appear on the customer's bill. All bill lines are shown on Bill Segment - Calculation Details. However, only those lines marked as Print are presented to the customer.
- **Print If Zero (Yes or No):** A flag that specifies if a bill line should be printed if the bill line's value is zero.
- **Rounding Type:** This flag specifies if the calculated value should be rounded Down, Up, or Nearest. Used with Precision to control how the system rounds the rule's calculated value.
- **Precision:** This field defaults to a value consistent with the decimal positions defined on the rate schedule's currency code. Used with Rounding Type to control how the system rounds the rule's calculated value.
- **FCPO (For Calculation Purposes Only):** A flag that indicates if this calculation rule exists purely to calculate a value used by another calculation rule. When set to Yes, the system does not include the calculated amount in the bill total. The following are required when FCPO is set to Yes:
 - **Create Bill Line:** Determines if a bill line should be created for the rule (if there is no need to show the results to the customer or a user, there is no need to create a bill line).
 - **FCPO Retention Rule:** If a bill line created, this defines if the FCPO amount should be set to zero on the bill line or whether the bill line's amount should be set equal to the FCPO amount.
- **Override Proration:** A flag that specifies if an override proration algorithm should be used. This is used in situations when the standard proration logic does not satisfy your requirements. In this case, you may plug in an override proration algorithm to calculate the proration factors required by your implementation. This algorithm can be specified on the calculation rule business object or on the parent calculation rule business object if the override proration applies to all rates.
- **Seasonal (Yes or No):** A flag that specifies if charges associated with the calculation rule are only levied during a specific season. If set to "Yes", the following must be specified:
 - **Season Start:** Defines the start of the season for the calculation rule.
 - **Season End:** Defines the end of the season for the calculation rule.
 - **Seasonal Prorate Method:** Defines how the system should prorate a seasonal charge when a bill segment's period is not entirely within the seasonal period. The following options are available:
 - **Accounting Date, Consumption End Date and Consumption Start Date** options will not prorate the charge calculated by the calculation rule. Rather, it will only calculate the charge if the accounting date associated with the

bill segment is within the seasonal period, or if the consumption period's end date is within the seasonal period, or if the consumption period's start date is within the seasonal period respectively.

- **Prorate** will prorate the calculation rule charge based on number of days in the season that is included in the bill period.
- The **Prorate Seasonal SQ** option is only pertinent if you have:
 - Seasonal service quantity (SQ) charges, AND
 - Meters that measure seasonal consumption on separate registers, AND
 - You have a bill that crosses seasonal boundaries, AND
 - You have multiple rate version calculation groups effective across the bill period.

If the Prorate Seasonal SQ option is used, the system will prorate the charge calculated by a SQ calculation rule based on the number of days in the season that is included in the rate version calculation group's period.

- **GL Distribution:** If the charge calculated by the calculation rule impacts the general ledger, you must define the distribution code used to construct the GL account.
 - **Distribution Code Source:** Specifies the type of GL distribution to use for this calculation rule. If the calculation rule's charges should be booked to a single GL account regardless of the service agreement's SA Type's revenue class, select the **Specific Distribution Code** source and enter a **Distribution Code**.
If the calculation rule's charges are booked to a different GL account depending on the service agreement's revenue class, select the **Revenue Class** source and insert the appropriate **Revenue Class** and **Distribution Code** for each that uses the rate.
- **Cross Reference:** Defines the calculation line categories that the resultant calculation details belong to. For example, for a rate that calculates city and state taxes on consumption and demand based charges, the following categories could be used to calculate these taxes:
 - A calculation line category type called "Taxable" with a category value for City Tax and another for State Tax.
 - Each of the rate's calculation rules used for consumption and demand based charges should define the Member Category(s) that it belongs to ("Taxable - City Tax" and "Taxable - State Tax"). In other words, these rules would be defined as a member of the city tax and state tax categories.
 - The Apply To rules used to calculate city tax and state tax should define the respective Target Category(s) ("Taxable - City Tax" and "Taxable - State Tax") that they are applied to.
There are two types of cross-reference categories:
 - **Target Category:** Specifies the category that the calculation rule targets. Used with Apply To, Maximum Charge, and Minimum Charge calculation rules.
 - **Member Category:** Specifies the category to which the calculation rule belongs.
- **Characteristics:** Defines additional calculation rule attributes that may be used in rate processing or for reporting purposes. A calculation rule's characteristics are copied onto the resultant bill lines for those characteristic types that are allowed on bill segment calc lines. You can indicate that "C1-ADDSC" characteristic ad hoc value of a bill line should be substituted into the bill line's description by using the %V substitution variable in the calculation rule's **Description On Bill** field.

Calculation Rule Validation

All calculation rules are validated when created to ensure they contain proper data needed to perform their calculations. The algorithms used to perform these validations are performed by the algorithms specified in the "Validation" system event on the calculation rule's business object. Details concerning the validation algorithms and the parameters they used can be viewed using the Application Viewer.

Calculation Rules

This section provides descriptions for the base package calculation rules.

Apply To

Apply To calculation rules create bill lines that levy charges based on amounts calculated on other bill lines. Apply To calculation rules must define the respective target category that they are applied to. The calculation rule(s) that compute charges to which "Apply To" rules will be applied must be defined as members of the target category. See **Cross-Reference** under [Common Parameters](#) for more information about Member and Target categories.

- **Rule Name:** Apply To
- **Base Package Calculation Rule Business Object:** C1-ApplyTo
- **Apply Calculation Rule Algorithm Type / Algorithm:** C1-APPLYTO
- **Rule Parameters:**
 - **Calculation Details:** Details regarding how the calculation rule performs its calculations:
 - **Error If No Value:** Indicates what should happen if the system cannot find any calculation rules that are members of the target category at billing time.
 - **Seasonal:** See [Common Parameters](#).
 - **Value Type:** Defines if the price is a Charge, Percentage or Unit Rate.
 - **Value Source:** specifies the source of the price. Depending on the value source selected, either a Bill Factor, Value, or Value Algorithm is required.
 - **Example:** The following calculation rule applies a county tax other calculation rules that belong the "Taxable - County Tax" category.
Calculation Group: Taxes
Calculation Rule: CNTYTAX
Sequence: 530
Description: County Tax
Description On Bill: County sales tax %R %T
Print: Yes
Print if Zero: No
Rounding Type: Nearest
Precision: 0.01
FCPO: No
Override Proration: No
Calculation Details:
 - **Error If No Value:** No
 - **Seasonal:** No
 - **Value Type:** Percentage
 - **Value Source:** Bill Factor
 - **Bill Factor:** County Tax
GL Distribution:

- **Distribution Source Code:** Specific Distribution Code
- **Distribution Code:** Payable - County Tax
Cross Reference:
- **Target Category (Category Type / Value):** Taxable / County Tax
- **Member Category (Category Type/Value):** Summary Item / Summary Line

Calculate Final Reading Values

Calculate Final Reading Values calculation rules determine the final values for readings based on user-defined UOM/TOU/SQI.

- **Rule Name:** Calculate Final Reading Values
- **Base Package Calculation Rule Business Object:** C1-CalculateFinalValue
- **Apply Calculation Rule Algorithm Type / Algorithm:** C1-CALCFNVL
- **Rule Parameters:**
 - **Calculation Details:** Details regarding how the calculation rule performs its calculations:
 - **Unit of Measure:** The unit of measure for the measured quantity.
 - **Time of Use:** The time of use for the measured quantity.
 - **Service Quantity Identifier:** The service quantity identifier for the measured quantity.
 - **Retain Measured SQ:** indicates whether to save the accumulated measured quantity entry in the SQ collection. If this value is set to No, it means the value will be removed from the SQ collection. Before any pre-processing rule is executed, the rate engine will place the sum / max value of the read details into the SQ collection. For example, if the read details contain entries for measured CCF, there will be an entry in the SQ collection for the total CCF from all read details. This might be what is needed, but it may be extraneous if a rule converts the measured quantity into therms. In this situation, the SQ collection only needs therms and the CCF entry can be removed.
 - **Formula:** Defines the formula used to calculate the final read quantity. Bill Factors (or scalar variables) to be used in the calculation are designated as Vn, where n matches the number assigned to the variable (i.e. V1 = Bill Factor 1, V2 = Bill Factor 2, etc.). Measured Quantity is referenced as MQ in the formula. Mathematical operations supported include addition, subtraction, multiplication and division. For example: $(MQ * V1)$ would be the formula to convert CCF to THERM.
 - **Scalar Variables:** Defines the scalar variables or Bill Factors to be used in the calculation. When referenced in the formula, scalar variables are designated as Vn, where n matches the number assigned to the variable (i.e. V1 = Bill Factor 1, V2 = Bill Factor 2, etc.). Note that only regular bill factors may be used in the formula. Interval and Time of Use bill factors are not supported.
 - **Sequence:** Designates the number of the variable (V1, V2, etc.)
 - **Bill Factor:** The Bill Factor used for the variable.
 - **Result:** Defines the type of data (**Unit of Measure, Time of Use, and/or Service Quantity Identifier**) to be used for the final quantity calculated by the rule.
 - **Processing:** The following processing takes place:
 - The rule will process each read detail whose initial UOM matches the measured quantity UOM.
 - It substitutes the reference to MQ in the formula with each read's measured quantity and then calls the formula service passing the defined bill factors as variables 1 to n. The read's end date is passed as the effective date.
 - It then populates each read's final value with the results of the formula and it populates the final UOM / TOU / SQI with the values defined on the rule.

- It populates the SQ collection with the results (this will either add a new value if the Final UOM / TOU / SQI is not present in the SQ collection, OR it will update the existing SQ quantity with the sum or max of the calculated value depending on the Final UOM's measure's peak value). Note, the initial and final values of such an SQ will be the calculated value.
- It then removes the measured UOM / TOU / SQI from the SQ collection if the rule has been configured as such.
- **Example:** This calculation rule converts CCF (as recorded on the meter) to therms for billing purposes.

Calculation Group: CCF to Therm Conversion (Calculate SQ - SQ and BF)

Calculation Rule: CCF2TH

Sequence: 10

Description: Convert CCF to TH

Calculation Details:

- **Unit of Measure:** 100 cubic feet of gas
- **Retain Measured SQ:** Yes
- **Formula:** $MQ * V1 * V2$
Scalar Variables (Sequence / Bill Factor):
 - 1 / Pressure adjustment zone
 - 2 / Take point for therm conv.fac
- **Result:**
- **Unit of Measure:** Thermal units

Calculate Service Quantity

Calculate Service Quantity calculation rules derive or calculate a service quantity that is eventually inserted into the bill segment SQ collection. Calculate Service Quantity calculation rules are generally used to either manipulate measured consumption, or to derive quantities that are not measured by a meter.

- **Rule Name:** Calculate Service Quantity
- **Base Package Calculation Rule Business Object:** C1-CalculateServiceQuantity
- **Apply Calculation Rule Algorithm Type / Algorithm:** C1-CALC-SQ
- **Rule Parameters:**
 - **Scalar Variable 1 (Scalar Variable 2, Scalar Variable 3, ... Scalar Variable 5):** Defines one of the scalar variables to be used in the calculation. When used in formulas, scalar variables are designated as Vn, where n matches the number assigned to the variable (i.e. V1 = Scalar Variable 1, V2 = Scalar Variable 2, etc.).
 - **Type:** Defines the type of variable and can be one of the following:
 - **Algorithm:** an algorithm is responsible for retrieving the scalar variable value, e.g. calculate number of days in the bill period.
 - **Bill Factor:** the value for a specified bill factor that is in effect for the period.
 - **Calculated Line:** the value is derived by summing previously calculated lines defined as members of a target category.
 - **Characteristic Value:** the value is derived by summing characteristic values of a given characteristic type.
 - **Contract Quantity:** the value for a given contract quantity type specified on a service agreement.
 - **Historical Service Quantity:** the value is derived based on the SA's historical bill segment service quantities for the specified UOM / TOU / SQI. The Aggregate Function defines the calculation to perform on the set of

historical service quantities retrieved to derive a single value. Average, Maximum, Minimum and Sum are supported.

- **Service Quantity:** service quantities from the bill period's SQ collection, based on a specified UOM / TOU / SQL. This type of variable allows this rule to make use of values calculated by other rules.
- **Previous Quantity:** the value is derived from the SA's most recent frozen bill segment service quantities for the specified UOM / TOU / SQL.
- **Missing Value Action:** Defines what should take place if the system is unable to retrieve or derive a value for a particular scalar variable. Valid options are as follows:
 - Select **Error** to create an exception
 - Select **Skip** to exit the rule and process the next rule
 - Select **Use Default Value** if the scalar variable should be set to the default value specified
- **Calculation Details:** Details regarding how the calculation rule performs its calculations:
 - **Calculation Rule Processing:** Indicates if the rule is **Always** executed by rate application, even if the consumption details on the original bill segment are to be used when the system recalculates a bill segment. If the rule should not be executed when the consumption details on the original bill segment are used, indicate that the calculation rule should only be executed on the **Initial SQ Calculation**.
 - **Fail Action:** Indicates the action to take if an error is encountered when applying the rule's formula. Available options are to either create a bill segment **Error**, or to **Skip** the calculation rule.
 - **Calculation Rule Output:** Specifies whether calculation rule should add or update a **Service Quantity** entry in the bill period's SQ collection, or create a bill **Calculation Line**, or **Both**.
 - **Retain SQ:** Indicates whether to save the calculated value on the bill segment. If this value is set to **No**, it means the value will only exist in the SQ collection while the rate engine is calculating. A value of **No** should be used for SQ entries that do not have to be retained for audit or analytic purposes.
 - **Formula Source:** Specifies the type of formula to use for the rule. Valid options include "Simple Formula" and "Conditional Formula".
 - **Formula:** Specify the **Simple Formula** to apply. Scalar variables to be used in the calculation are designated as Vn, where n matches the number assigned to the variable (i.e. V1 = Scalar Variable 1, V2 = Scalar Variable 2, etc.). Mathematical operations supported include addition, subtraction, multiplication and division. For example: $(V1*V2)/2$.
 - **Conditional Formula:** this allows comparison between one or more pairs of operands to determine the specific formula to execute. A conditional formula can utilize one or more conditions. Each condition comprises the following:
 - **Operand 1:** the first operand in the condition. Can reference an expression with one or more scalar variables (designated as Vn), e.g. $[V1+V2]$ or $[(V1/V2)*V3]$.
 - **Operator:** the operator used to compare Operand 1 with Operand 2.
 - **Operand 2:** the second operand in the condition. Can reference an expression with one or more scalar variables, or a constant (similar to Operand 1).
 - **True Action:** indicates how to proceed if the comparison between the operands is true. Can be one of the following:
 - **Apply True Formula:** indicates that the True Formula be executed.
 - **Check Next Condition:** indicates that the next condition should be checked.
 - **True Formula:** the formula to apply if True Action is set to Apply True Formula. Can reference an expression with one or more scalar variables (designated as Vn), or a constant.
 - **False Action:** indicates how to proceed if the comparison between the operands is false. Can be one of the following:

Apply False Formula: indicates that the False Formula be executed.

- **Check Next Condition:** indicates that the next condition should be checked.
- **False Formula:** the formula to apply if the False Action is set to Apply False Formula. Can reference a vector (designated as IVn, where n is the number of the vector) or an expression referencing one or more vectors or a scalar variable (designated as Vn).
- **Result:** Define the **Unit of Measure**, **Time of Use** and/or **Service Quantity Identifier** to be used if this calculation rule inserts or updates a service quantity in the bill period's SQ collection.
- **Example:** This calculation rule calculates total kWh from On Peak and Off Peak service quantities.

Calculation Group: Calculate KWH

Calculation Rule: TOTKWH

Sequence: 10

Description: Total amount of KWH (On Peak + Off Peak)

Scalar Variable 1:

- **Type:** Service Quantity
- **Missing Value Action:** Error
- **Unit of Measure:** Kilowatt hour
- **Time of Use:** On Peak
- **SQ To Use:** Billable

Scalar Variable 2:

- **Type:** Service Quantity
- **Missing Value Action:** Error
- **Unit of Measure:** Kilowatt hour
- **Time of Use:** Off Peak
- **SQ To Use:** Billable

Calculation Details:

- **Calculation Rule Processing:** Always
- **Fail Action:** Error
- **Calculation Rule Output:** Service Quantity
- **Retain SQ:** No
- **Formula Source:** Simple Formula
- **Formula:** V1 + V2

Result:

- **Unit of Measure:** Kilowatt hour

Copy Service Quantity from Master Bill Segment

Calculate Final Reading Values calculation rules determine the final values for readings based on user-defined UOM/TOU/SQ.

- **Rule Name:** Copy Service Quantity From Master Bill Segment
- **Base Package Calculation Rule Business Object:** C1-CopySQFromMasterBillSegment
- **Apply Calculation Rule Algorithm Type / Algorithm:** C1-CPY-MB-SQ

- **Rule Parameters:**
 - **Characteristics:** Defines characteristic(s) and corresponding value(s) that are to be passed to the referenced calculation group.
 - **Characteristic Type:** Defines the characteristic type that is to be associated to the calculation rule.

NOTE:

Characteristic Types for rates must be configured to be used on a calculation rule and/or in the characteristic collection. See [Characteristic Type - Characteristic Entities](#) for more information.

- **Characteristic Value:** Defines the parameter value that will be associated to the characteristic type.

Execute Calc Group

Execute Calc Group calculation rules call another calculation group, and pass characteristics and their values to the referenced calculation group.

- **Rule Name:** Execute Calculation Group
- **Base Package Calculation Rule Business Object:** C1-CalcRuleReferredCalcGroup
- **Apply Calculation Rule Algorithm Type / Algorithm:** C1-ACALR-RFG
- **Rule Parameters:**
 - **Referenced Calculation Group:** Defines the calculation group that's being called.
 - **Calculation Group:** Defines the calculation group that's being called.
 - **Characteristics:** Defines characteristic(s) and corresponding value(s) that are to be passed to the referenced calculation group.
 - **Characteristic Type:** Defines the characteristic type that is to be passed to the referenced calculation group.

NOTE:

Characteristic Types for rates must be configured to be used on a calculation rule and/or in the characteristic collection. See [Characteristic Type - Characteristic Entities](#) for more information.

- **Characteristic Value:** Defines the parameter value that will be associated to the characteristic type.

Flat Charge

Flat Charge calculation rules create bill lines that levy service charges and fees that aren't based on how much the customer uses. For example a flat charge calculation rule may be used to apply a monthly service charge of \$10 to a customer's bill.

- **Rule Name:** Flat Charge
- **Base Package Calculation Rule Business Object:** C1-FlatCharge
- **Apply Calculation Rule Algorithm Type / Algorithm:** C1-FLAT-CHRG
- **Rule Parameters:**
 - **Calculation Details:** Details regarding how the calculation rule performs its calculations:
 - **Seasonal:** See [Common Parameters](#).
 - **Value Type:** Defines the type of value to use for the rule. For Flat Charge rules, this should be set to **Charge**.

- **Value Source:** Specifies the source of the price used to calculate the charge. Depending on the source selected, this will be a Bill Factor, Value, or Algorithm.
- **Example:** This calculation rule levies a customer charge.
Calculation Group: Customer Charge
Calculation Rule: CSTCHG
Sequence: 20
Description: Customer Charge
Description On Bill: Customer Charge
Print: Yes
Print if Zero: No
Rounding Type: Nearest
Precision: 0.01
FCPO: No
Override Proration: No
Calculation Details:
 - **Seasonal:** No
 - **Value Type:** Charge
 - **Value Source:** Value
 - **Value:** 5**GL Distribution:**
 - **Distribution Source Code:** Specific Distribution Code
 - **Distribution Code:** Revenue - Energy**Cross Reference:**
 - **Member Category (Category Type / Value):** Subject to tax / City taxable

Item Type

Item Type calculation rules create bill lines that levy charges based on the number and type of items used by a customer. The system keeps track of items on the service point(s) linked to the customer's service agreement.

- **Rule Name:** Item Type
- **Base Package Calculation Rule Business Object:** C1-ItemType
- **Apply Calculation Rule Algorithm Type / Algorithm:** C1-ITEMTYPE
- **Rule Parameters:**
 - **Calculation Details:** Details regarding how the calculation rule performs its calculations:
 - **Seasonal:** See [Common Parameters](#).
 - **Item Type:** Defines the types of items to which charges are applied. When defining more than one item type on a single calculation rule, you can indicate that the item type of a bill line should be substituted into the bill line's description by using the %M substitution variable in the calculation rule's **Description On Bill** field.
 - **Error If No Value:** A flag that indicates (Yes or No) if a bill error should be generated if the item type specified on the calculation rule was not supplied at billing time.
 - **Value Type:** Defines the type of charge. Valid options include Charge, Percentage, or Unit Rate.

- **Value Source:** Defines the source of the price used to calculate the charge. Depending on the source selected, this will be a Bill Factor, Value, or Algorithm.
 - **Value/Bill Factor/Algorithm:** The specific Value, Bill Factor, or Algorithm that serves as the source of the price used to calculate the charge.
- **Example:** This calculation rule calculates charges for light poles.
Calculation Group: Lamp Charges
Calculation Rule: POLE CHARGE
Sequence: 10
Description: Pole Charge
Description On Bill: %C lamp poles at %R per pole %D %I
Print: Yes
Print if Zero: No
Rounding Type: Nearest
Precision: 0.01
FCPO: No
Override Proration: No
Calculation Details:
- **Seasonal:** No
 - **Items:**
 - **Item Type:** Pole(s)
 - **Error If No Value:** No
 - **Value Type:** Unit Rate
 - **Value Source:** Value
 - **Value / Bill Factor /Algorithm:** 3
GL Distribution:
 - **Distribution Source Code:** Specific Distribution Code
 - **Distribution Code:** Revenue - Area Lighting
Cross Reference:
 - **Member Category (Category Type / Value):** Charges / Total Charges
 - **Member Category (Category Type / Value):** Charges / Lamp Charges

Math

Math calculation rules derive interval data based on a formula, and apply TOU mappings and/or other operations to the derived data to calculate service quantities.

- **Rule Name:** Math
- **Base Package Calculation Rule Business Object:** C1-Math
- **Apply Calculation Rule Algorithm Type / Algorithm:** C1-MATH
- **Rule Parameters:**
 - **Vector 1 (Vector 2, Vector 3, ..., Vector 5):** Defines one of the vectors (Vector 1, 2, 3, ..., 5) to be used in the calculation. When used in formulas, interval values for vectors are designated as IV1, IV2, IV3, ..., IV5.

- **Vector Type:** Defines the type of vector. Valid options include **Interval Bill Factor** and **Interval Service Quantity**.
- **Bill Factor:** Defines the Interval Bill Factor from which interval values are derived for the vector.
- **Unit of Measure/Time of Use/Service Quantity Identifier:** The UOM/TOU/SQI used to retrieve interval values from either the usage request service quantity entries given a usage request ID and usage period, or from the rate engine buffer populated prior to calling rate application.
- **Missing Interval Data Action:** Defines the action to take (**Error** or **Skip**) if interval data is missing for the expected period
- **Scalars:** Defines scalar variables to be used in the calculation. When used in formulas, scalar variables are designated as Vn, where n is the number of the variable (based on the sequence in which they are defined in the list).
 - **Scalar Type:** Defines the type of variable. Can be one of the following:
 - **Bill Factor:** The value for a specified bill factor that is in effect for the billing period.
 - **Set Function:** The result of applying a function to a set of interval measurement values (defined as a vector).
 - **Service Quantity:** Service quantities from the current SQ list, based on a specified UOM, TOU, or SQI. This type of variable allows this rule to make use of values calculated by other rules.
 - **Bill Factor:** Defines the bill factor used to retrieve the variable value (applicable only if Scalar Type is Bill Factor)
 - **Unit of Measure:** Defines the UOM for service quantities to retrieve from the SQ list (applicable only if Scalar Type is Service Quantity).
 - **Time of Use:** Defines the TOU for service quantities to retrieve from the SQ list (applicable only if Scalar Type is Service Quantity).
 - **Service Quantity Identifier:** Defines the SQI for service quantities to retrieve from the SQ list (applicable only if Scalar Type is Service Quantity).
 - **SQ to Use:** Every service quantity supplied to a rate has two quantities; the quantity initially measured, and the quantity that should be priced by the rate. Most of the time these two amounts will be the same, unless another rule has executed and caused the billable quantity to change. Each rule needs to know if it should use the **Initial** or **Billable** quantity.
 - **Set Function:** Defines the function used to calculate a scalar value from a set of interval values (defined as a vector). This is applicable only if Scalar Type is Set Function). Can be one of the following:
 - **Average:** calculates the average of the vector's interval measurement values.
 - **Count:** returns the number of interval measurements.
 - **Max:** returns the maximum value from the vector's interval measurement values.
 - **Min:** returns the minimum value from the vector's interval measurement values.
 - **Total:** calculates the total of the vector's interval measurement values.
 - **Vector:** the vector to be used for this variable (applicable only if Scalar Type is Set Function). Can be one of the following:
 - **FV** (Final Vector Interval Value): the vector containing the results of the formula defined in the Calculation Details section.
 - **IV1** (Vector 1 Interval Value): the vector defined as Vector 1.
 - **IV2** (Vector 2 Interval Value): the vector defined as Vector 2.
 - **IV3** (Vector 3 Interval Value): the vector defined as Vector 3.
 - **IV4** (Vector 4 Interval Value): the vector defined as Vector 4.
 - **IV5** (Vector 5 Interval Value): the vector defined as Vector 5.

- **Missing Value Action:** Defines the action to take (**Error**, **Skip**, or **Use Default Value**) if data is missing for the scalar variable for the expected period
- **Default Value:** The default value to use if data is missing for the scalar variable. Applicable only if Missing Value Action is Use Default Value.
- **Calculation Details:** Details regarding how the calculation rule performs its calculations:
 - **Calculation Rule Processing:** Indicates if the rule is **Always** executed by rate application, even if the consumption details on the original bill segment are to be used when the system recalculates a bill segment. If the rule should not be executed when the consumption details on the original bill segment are used, indicate that the calculation rule should only be executed on the **Initial SQ Calculation**.
 - **Fail Action:** Indicates the action to take if an error is encountered when applying the rule's formula. Available options are to either create a bill segment **Error**, or to **Skip** the calculation rule.
 - **Calculation Rule Output:** Specifies whether calculation rule should add or update a **Service Quantity** entry in the bill period's SQ collection, or create a bill **Calculation Line**, or **Both**.
 - **Retain SQ:** Indicates whether to save the calculated value on the bill segment. If this value is set to **No**, it means the value will only exist in the SQ collection while the rate engine is calculating. A value of **No** should be used for SQ entries that do not have to be retained for audit or analytic purposes.
 - **Formula Source:** Specifies the type of formula to use for the rule. Valid options include "Simple Formula" and "Conditional Formula".
 - **Formula:** Specify the **Simple Formula** to apply. Scalar variables to be used in the calculation are designated as V_n , where n matches the number assigned to the variable (i.e. V_1 = Scalar Variable 1, V_2 = Scalar Variable 2, etc.). Mathematical operations supported include addition, subtraction, multiplication and division. For example: $(V_1 * V_2) / 2$.
 - **Conditional Formula:** this allows comparison between one or more pairs of operands to determine the specific formula to execute. A conditional formula can utilize one or more conditions. Each condition comprises the following:
 - **Operand 1:** the first operand in the condition. Can reference an expression with one or more scalar variables (designated as V_n), e.g. $[V_1 + V_2]$ or $[(V_1 / V_2) * V_3]$.
 - **Operator:** the operator used to compare Operand 1 with Operand 2.
 - **Operand 2:** the second operand in the condition. Can reference an expression with one or more scalar variables, or a constant (similar to Operand 1).
 - **True Action:** indicates how to proceed if the comparison between the operands is true. Can be one of the following:
 - Apply True Formula:** indicates that the True Formula be executed.
 - Check Next Condition:** indicates that the next condition should be checked.
 - **True Formula:** the formula to apply if True Action is set to Apply True Formula. Can reference an expression with one or more scalar variables (designated as V_n), or a constant.
 - **False Action:** indicates how to proceed if the comparison between the operands is false. Can be one of the following:
 - Apply False Formula:** indicates that the False Formula be executed.
 - Check Next Condition:** indicates that the next condition should be checked.
 - **False Formula:** the formula to apply if the False Action is set to Apply False Formula. Can reference a vector (designated as $I V_n$, where n is the number of the vector) or an expression referencing one or more vectors or a scalar variable (designated as V_n).
- **Result:** Defines how service quantities are inserted into the SQ list. Math calculation rules can insert one or more entries into the SQ list.

- **Result Source:** Defines the method to use to calculate for the service quantity. Can be one of the following:
 - **Set Function Against Derived Vector:** Applies a function to the derived interval values. The function to be applied is specified in the Set Function field.
 - **Scalar Formula Result:** Applies a user-defined formula. The formula is specified in the Scalar Formula field.
- **Set Function:** the function to apply to the derived interval values (applicable only if Result Source is set to Set Function Against Derived Vector). Can be one of the following:
 - **Average:** Calculates the average of the derived interval measurement values.
 - **Count:** Returns the number of derived interval measurements.
 - **Max:** Returns the maximum value from the derived interval measurement values.
 - **Min:** Returns the minimum value from the derived interval measurement values.
 - **Total:** Calculates the total of the derived interval measurement values.
- **Scalar Formula:** the formula to apply (applicable only if Result Source is set to Scalar Formula). Variables used in this formula must be defined in the Scalars section. When referenced in formulas, scalar variables are designated as Vn (where n is the number of the variable).
- **Unit of Measure:** the UOM to be used when inserting service quantity entries
- **Time of Use:** the TOU to be used when inserting service quantity entries
- **Service Quantity Identifier:** the SQI to be used when inserting service quantity entries
- **Apply TOU Map:** Indicates if a TOU map should be applied to the derived interval values. If TOU periods and values are returned as a result of TOU mapping, then service quantity entries are inserted.
- **TOU Map:** Defines the TOU Map to apply to the derived interval values (applicable only if Apply TOU Map is set to Yes).
- **TOU Mapping Function:** Defines the function to apply to the derived interval values when calculating for the time of use values (applicable only if Apply TOU Map is set to Yes). Can be one of the following:
 - **Max:** Returns the maximum value from the derived interval values for each TOU period.
 - **Sum:** Returns the sum of the derived interval values for each TOU period.
- **Processing:**

Math rules derive interval values based on a formula, and apply TOU mappings and/or other operations to the derived data to calculate billing quantities. Examples include the following:

 - Derive an interval data curve (vector) given a formula. For example, derive a power factor curve given a formula using kWh and kVarh curves.
 - Apply TOU mapping to a derived interval data curve. For example, after deriving the power factor curve, perform TOU mapping on the result.
 - Perform mathematical operations on SQ entries. For example, get total kWh consumption by adding "kWh On Peak", "kWh Off Peak", and "kWh Shoulder Peak" where "kWh On Peak", "kWh Off Peak", and "kWh Shoulder Peak" were calculated by a previous calculation rule.

Each interval data curve is defined as a vector parameter (the rule can define up to 5 vectors). Mathematical operations defined by the "Vector Processing" parameters can be performed between vectors (e.g. IV1 * IV2) and between vectors and scalar variables (e.g. IV1 * V1).
- **Example:** This calculation rule calculates prices for interval usage by multiplying an interval service quantity times an interval price bill factor.

Calculation Group: Electric Commercial - Interval Pricing

Calculation Rule: INTDPRICING

Sequence: 10

Description: KWH Interval Prices

Description On Bill: kWh Interval Prices

Print: Yes

Print if Zero: No

Rounding Type: Nearest

Precision: 0.01

FCPO: No

Vector 1:

- **Vector Type:** Interval Service Quantity

- **Unit of Measure:** Kilowatt hour

- **Missing Interval Data Action:** Error

Vector 2:

- **Vector Type:** Interval Bill Factor

- **Bill Factor:** Interval Prices

- **Missing Interval Data Action:** Error

Calculation Details:

- **Calculation Rule Processing:** Always

- **Fail Action:** Error

- **Calculation Rule Output:** Calculation Line

- **Formula Source:** Simple Formula

- **Simple Formula:** IV1 * IV2

Result:

- **Result Source:** Set Function Against Derived Vector

- **Set Function:** Total

GL Distribution:

- **Distribution Source Code:** Specific Distribution Code

- **Distribution Code:** Revenue - Energy

Maximum Charge

Maximum Charge calculation rules are used to create bill lines that levy charges only when the sum of previously calculated lines is more than the maximum charge amount. Maximum charge calculation rules must define the respective target category that they are applied to. The calculation rule(s) that compute charges that the maximum is levied on must be defined as members of the target category. See **Cross-Reference** under [Common Parameters](#) for more information about Member and Target categories.

Note that if the values being compared are negative values, the comparison is NOT done on the absolute values, but rather on the actual values. For example, imagine you have a maximum discount of \$ -2.00 and previous calculation rules have calculated a discount of \$ -3.00. You want a calculation rule to create a bill line for \$1.00 to reduce the discount. A maximum charge calculation rule will not work in this case because -3 is considered less than -2. For this business scenario you should use a Minimum Charge calculation rule.

Note: Maximum Charge calculation rules are rare. You tend to only see them in deregulated markets where customers have agreed to pay the market rate but want a cap on the maximum they'll pay each bill period.

- **Rule Name:** Maximum Charge

- **Base Package Calculation Rule Business Object:** C1-Maximum
- **Apply Calculation Rule Algorithm Type / Algorithm:** C1-MAXIMUM
- **Rule Parameters:**
 - **Calculation Details:** Details regarding how the calculation rule performs its calculations:
 - **Error If No Value:** Indicates what should happen if the system cannot find any calculation rules that are members of the target category at billing time.
 - **Seasonal:** See [Common Parameters](#).
 - **Value Type:** Defines the type of value to use for the maximum value for the rule. For Maximum Charge rules, this should be set to **Charge**.
 - **Value Source:** Specifies the source of the price used to calculate the charge. Depending on the source selected, this will be a Bill Factor, Value, or Algorithm.
 - **Example:** This calculation rule sets a maximum charge for area lighting.

Calculation Group: Customer-Owned Street & Highway Lighting

Calculation Rule: MAXCHRG

Sequence: 20

Description: Maximum Charge - Area Lighting

Description On Bill: Maximum Charge

Print: Yes

Print if Zero: No

Rounding Type: Nearest

Precision: 0.01

FCPO: No

Override Proration: No

Calculation Details:

- **Error If No Value:** No
- **Seasonal:** No
- **Value Type:** Charge
- **Value Source:** Value
- **Value:** 100
- **GL Distribution:**
 - **Distribution Source Code:** Specific Distribution Code
 - **Distribution Code:** Revenue - Area Lighting
- **Cross Reference:**
- **Target Category (Category Type / Value):** Revenue / Maximum Consumption Charge

Minimum Charge

Minimum Charge calculation rules create bill lines that levy charges only when the sum of previously calculated lines is less than the minimum charge amount. Minimum charge calculation rules must define the respective target category that they are applied to. The calculation rule(s) that compute charges that the minimum is levied on must be defined as members of the target category. See **Cross-Reference** under [Common Parameters](#) for more information about Member and Target categories.

Note that if the values being compared are negative values, the comparison is NOT done on the absolute values, but rather on the actual values. For example, imagine you have a minimum discount of \$ -2.00 and previous calculation rules have calculated a discount of \$ -1.00. You want a calculation rule to create a bill line for \$ -1.00 to apply a further discount. A minimum charge calculation rule will not work in this case because -1 is considered more than -2. For this business scenario you should use a maximum charge calculation rule.

- **Rule Name:** Minimum Charge
- **Base Package Calculation Rule Business Object:** C1-Minimum
- **Apply Calculation Rule Algorithm Type / Algorithm:** C1-MINIMUM
- **Rule Parameters:**
 - **Calculation Details:** Details regarding how the calculation rule performs its calculations:
 - **Error If No Value:** Indicates what should happen if the system cannot find any calculation rules that are members of the target category at billing time.
 - **Seasonal:** See [Common Parameters](#).
 - **Value Type:** Defines the type of value to use for the minimum value for the rule. For Minimum Charge rules, this should be set to **Charge**.
 - **Value Source:** Specifies the source of the price used to calculate the charge. Depending on the source selected, this will be a Bill Factor, Value, or Algorithm.
 - **Example:** This calculation rule defines a minimum charge for use with residential electric rates.
Calculation Group: Electric Residential
Calculation Rule: MINCHRG
Sequence: 50
Description: Minimum Charge
Description On Bill: Minimum Charge
Print: Yes
Print if Zero: No
Rounding Type: Nearest
Precision: 0.01
FCPO: No
Override Proration: No
Calculation Details:
 - **Error If No Value:** No
 - **Seasonal:** No
 - **Value Type:** Charge
 - **Value Source:** Value
 - **Value:** 75
GL Distribution:
 - **Distribution Source Code:** Specific Distribution Code
 - **Distribution Code:** Revenue - Miscellaneous
 - **Cross Reference:**
 - **Target Category (Category Type / Value):** Charges / Energy Charges
 - **Member Category (Category Type / Value):** Summary Item / Summary Line

- **Member Category (Category Type / Value):** Taxable - State Tax
- **Member Category (Category Type / Value):** Taxable - City Tab

Service Quantity

Service Quantity calculation rules create bill lines that levy charges based on some type of consumption.

Frequently the amount consumed is measured by a meter's registers and sometimes it's calculated using Pre-Processing calculation and sometimes it's derived based on the type of item (such as, lamps). Regardless of how the amount consumed is calculated, the charge for the consumption amount is levied using this type of calculation rule.

- **Rule Name:** Service Quantity
- **Base Package Calculation Rule Business Object:** C1-ServiceQuantity
- **Apply Calculation Rule Algorithm Type / Algorithm:** C1-SQ
- **Rule Parameters:**
 - **Calculation Details:** Details regarding how the calculation rule performs its calculations:
 - **Unit of Measure:** The UOM used as the service quantity that the price is applied to.
 - **Time of Use:** The TOU used as the service quantity that the price is applied to.
 - **Service Quantity Identifier:** The SQI used as the service quantity that the price is applied to.
 - **Error If No Value:** A flag that indicates (Yes or No) if a bill error should be generated if the UOM/TOU/SQI specified on the rule was not supplied at billing time.
 - **Measures Peak:** Indicates (Yes or No) if the UOM/TOU/SQI specified for the rule is used to measure peak (demand) values.
 - **GL Statistical Qty:** A flag that specifies (Yes or No) if GL journal lines generated for this calculation rule should also contain the service quantity amount as a statistical quantity. You would use this option if you keep track of both dollar amounts and consumption units in your general ledger.
 - **Seasonal:** See [Common Parameters](#).
 - **Value Type:** Defines the type of price to be used in the rule's calculations. Valid options include Charge, Percentage, or Unit Rate.
 - **Value Source:** Defines the source of the price used in the rule's calculations. Depending on the source selected, this will be a Bill Factor, Value, or Algorithm.

- **Example:** This calculation rule calculates charges based a customer's KWH consumption.

Calculation Group: Electric Residential Charges

Calculation Rule: KWHCHRG

Sequence: 10

Description: kWh Unit Rate

Description On Bill: Usage %Q at %R per kWh

Print: Yes

Print if Zero: No

Rounding Type: Nearest

Precision: 0.01000

FCPO: No

Override Proration: No

Calculation Details:

- **Unit of Measure:** Kilowatt hour
- **Error If No Value:** Yes
- **Measures Peak:** No
- **GL Statistical Qty:** Yes
- **Seasonal:** No
- **Value Type:** Unit Rate
- **Value Source:** Value
- **Value:** 0.0482000
- **GL Distribution:**
 - **Distribution Source Code:** Specific Distribution Code
 - **Distribution Code:** Revenue - Electric - Residential
- **Cross Reference:**
 - **Target Category:**
 - **Category Type:**
 - **Category Value:**
 - **Member Category (Category Type / Value):** Revenue / Consumption Charge

Simple Summary

Simple Summary calculation rules create a "subtotal" on the bill by summarizing bill lines produced by other calculation rules in the same calculation group.

- **Rule Name:** Simple Summary
- **Base Package Calculation Rule Business Object:** C1-SimpleSummary
- **Apply Calculation Rule Algorithm Type / Algorithm:** C1-SIMP-SUMM
- **Rule Parameters:**
 - **Referenced Calculation Rules:** Defines the calculation rules that should be included in the summary. Note that any calculation rules listed here must belong to the same calculation group as the Summary rule.
- **Example:** This calculation rule creates a summary of TOU-based charges (based on rules within the same calculation group as this rule).

Calculation Group: Commercial TOU Electric Charges

Calculation Rule: KWHTOT

Sequence: 40

Description: Consumption Subtotal

Description On Bill: Consumption Subtotal

Print: Yes

Print if Zero: No

Rounding Type: Nearest

Precision: 0.01

FCPO: No

Referenced Calculation Rules:

- Off Peak - kWh
- On Peak - kWh
- Shoulder Peak - kWh

Cross Reference:

- **Member Category (Category Type / Value):** Taxable / State Tax

Stepped Service Quantity

Stepped Service Quantity calculation rules create bill lines that levy charges based on some type of consumption when different prices are applied to different ranges of consumption (for example, the first 50 kWh are \$0.43 per kWh, anything in excess of 50 kWh is charged at \$0.71 per kWh)

- **Rule Name:** Stepped Service Quantity
- **Base Package Calculation Rule Business Object:** C1-SteppedSQ
- **Apply Calculation Rule Algorithm Type / Algorithm:** C1-STPD-SQ
- **Rule Parameters:**
 - **Calculation Details:** Details regarding how the calculation rule performs its calculations:
 - **Unit of Measure:** The UOM used as the service quantity that the price is applied to.
 - **Time of Use:** The TOU used as the service quantity that the price is applied to.
 - **Service Quantity Identifier:** The SQI used as the service quantity that the price is applied to.
 - **Error If No Value:** A flag that indicates (Yes or No) if a bill error should be generated if the UOM/TOU/SQI specified on the rule was not supplied at billing time.
 - **Measures Peak:** Indicates (Yes or No) if the UOM/TOU/SQI specified for the rule is used to measure peak (demand) values.
 - **GL Statistical Qty:** A flag that specifies (Yes or No) if GL journal lines generated for this calculation rule should also contain the service quantity amount as a statistical quantity. You would use this option if you keep track of both dollar amounts and consumption units in your general ledger.
 - **Create Step Summary:** Stepped service quantity calculation rules may be configured with either a single step or multiple steps. The Create Step Summary flag is used to produce a summary bill segment calculation line if the calculation rule has multiple steps. Valid options include:
 - **Summarize Step Lines, Print:** Creates a stepped charge summary bill line that will appear on the customer's bill.
 - **Summarize Step Lines, Do Not Print:** Creates a stepped charge summary bill line that will be shown on Bill Segment - Calculation Details, but not appear on the customer's bill.
 - **Step Calculation Details:**
 - **Seasonal:** See [Common Parameters](#).
 - **Step Multiplier Algorithm:** Specifies the algorithm that will be used calculate the step boundaries. Used only if step boundaries are dynamic and are calculated based on something that's only known at billing time.
 - **Values:** Defines the values associated with each of the ranges (steps) of consumption used by the rule. For example, if the charge is applicable to the first 300 kilowatt-hours, you would enter Low Value 0 and High Value 300. When multiple tiers exist, the high value of the first tier is the low value of the second tier (and so on). To extend our example, the second tier would have a low value of 300; the high value may be left blank (the system assumes a blank high value means "to infinity").

- **Low Value:** Defines the low value for the consumption range. This field supports values of up to 14 digits and 4 decimal places (e.g. a maximum value of 99,999,999,999,999.9999).
You can indicate that the low value of a bill line should be substituted into the bill line's description by using the %L substitution variable in the calculation rule's **Description On Bill** field.
 - **High Value:** Defines the high value for the consumption range. This field supports values of up to 14 digits and 4 decimal places (e.g. a maximum value of 99,999,999,999,999.9999).
You can indicate that the high value of a bill line should be substituted into the bill line's description by using the %H substitution variable in the calculation rule's **Description On Bill** field.
 - **Value Type:** Defines the type of price to be applied to the consumption range in the rule's calculations. Valid options include Charge, or Unit Rate.
 - **Value Source:** Defines the source of the price to be applied to the consumption range in the rule's calculations. Depending on the source selected, this will be a Bill Factor, Value, or Algorithm.
 - **Value/Bill Factor/Algorithm:** Specifies the Bill Factor, Value, or Algorithm used when calculating charges for the consumption range.
- **Example:** This calculation rule calculates charges for electric service based on stepped charges for kWh consumption during the Fall
Calculation Group: Electric Residential - Stepped
Calculation Rule: KWHSTFL
Sequence: 10
Description: Fall kWh Stepped Charges
Description On Bill: Usage %Q kWh at %I per kWh %F
Print: Yes
Print if Zero: No
Rounding Type: Nearest
Precision: 0.01000
FCPO: No
Override Proration: No
Calculation Details:
 - **Unit of Measure:** Kilowatt hour
 - **Error If No Value:** No
 - **Measures Peak:** No
 - **GL Statistical Qty:** Yes
 - **Create Step Summary:** Create Summary, Do Not Print
Step Calculation Details:
 - **Seasonal:** Yes
 - **Seasonal Prorate Method:** Accounting Date
 - **Season Start:** 09-01
 - **Season End:** 11-30
 - **Value 1:**
 - **Low Value:** 0
 - **High Value:** 300

- **Value Type:** Unit Rate
- **Value Source:** Value
- **Value / Bill Factor / Algorithm:** 0.0485
- **Value 2:**
 - **Low Value:** 300
 - **High Value:** [blank]
 - **Value Type:** Unit Rate
 - **Value Source:** Value
 - **Value / Bill Factor / Algorithm:** 0.0564
- **GL Distribution:**
- **Distribution Source Code:** Specific Distribution Code
- **Distribution Code:** Revenue - Electric - Residential
- **Cross Reference:**
- **Member Category (Category Type / Value):** Revenue / Consumption Charge

Summary

Summary calculation rules create a "subtotal" on the bill. It exists purely for reporting and informational purposes. Summary calculation rules must define the respective target category that they are applied to. The calculation rule(s) that compute charges should be included in the summary must be defined as members of the target category. See **Cross-Reference** under [Common Parameters](#) for more information about Member and Target categories.

- **Rule Name:** Summary
- **Base Package Calculation Rule Business Object:** C1-Summary
- **Apply Calculation Rule Algorithm Type / Algorithm:** C1-SUMMARY
- **Rule Parameters:**
 - **Calculation Details:** Details regarding how the calculation rule performs its calculations:
 - **Error If No Value:** Indicates what should happen if the system cannot find any calculation rules that are members of the target category at billing time.
- **Example:** This calculation rule creates a consumption summary on the bill based on other calculation rules included in the rate that belong to the "Revenue / Consumption Charge" category.

Calculation Group: Electric Residential Charges

Calculation Rule: USGSUM

Sequence: 30

Description: Usage Summary

Description On Bill: Summary

Print: Yes

Print if Zero: No

Rounding Type: Nearest

Precision: 0.01000

FCPO: No

Calculation Details:

- **Error If No Value:** No
Cross Reference:
- **Target Category (Category Type / Value):** Revenue / Consumption Charge
- **Member Category (Category Type / Value):** Summary / Summary of Consumption Charge

Rate Check

This section describes the features and functionality of Rate Check.

About Rate Check

The **Rate Check** feature allows you to test your rate schedules under different scenarios. For example, you can test your rates for an existing account using previous bill segments, or by providing user-specified bill period and service quantities.

Performing a Rate Check

NOTE: The Rate Check portal works with both calculation rule-based and component-based rate schedules.

Use this procedure to perform a rate check.

- Select **Menu > Rates > Rate Check**.
- Select the **Rate Schedule** for the rate check.
- Select the **Service Agreement** for the rate check.
- Select the **Bill Segment** for the rate check (if you wish to base the rate check on an existing bill segment).
- Enter the **Start Date**, **End Date**, and **Accounting Date** for the rate check.
- Select the **Revenue Class** for the rate check.
- If you are basing the rate check on user-specified **Service Quantities**, enter the following for each as applicable:
 - **UOM:** The unit of measure applicable for the rate check (based on the specified rate schedule)
 - **TOU:** The time of use applicable for the rate check (based on the specified rate schedule)
 - **SQL:** The service quantity identifier applicable for the rate check (based on the specified rate schedule)
 - **Measured Quantity:** The amount of the service quantity specified.
- **Service Point ID:** The service point which recorded the service quantities, if applicable
Note: If you specified a Service Agreement and Bill Segment, this section is populated based on the selected data, but can be manually overwritten.
- Specify characteristic types and values for any **Characteristics** are applicable to the rate check. Characteristic types and values are used to apply appropriate bill factor values during rate processing.
- If you are using a calculation rule-based rate schedule, specify if the system **Should Trace** the process. This produces logs that outline the calculation groups and rules used by the rate schedule.
- Execute the rate check:
 - If you wish to execute the rate check using a specified bill segment or service quantities, click **Check Rate**.
 - If you wish to execute the rate check using billing determinants retrieved from an external system (such as Oracle Utilities Meter Data Management), select the appropriate function from the **Select Function** dropdown list.

Viewing the Results of a Rate Check

The outcome of the rate check process is displayed on the **Results** tab. This tab contains the following zones:

- **Main:** Displays results of the rate check, including:
 - **Rate Schedule:** The rate schedule used in the rate check
 - **Revenue Class:** The revenue class used for the rate check.
 - **Bill Period:** The start and end dates for the bill period used by the rate check.
 - **Consumption Period:** The start and dates for the consumption period used by the rate check.
 - **Accounting Date:** The Accounting Date used by the rate check.
 - **Calculated Amount:** The calculated total for the rate check
- **Calculation Lines:** Displays the bill calculation headers and lines for the rate schedule.
- **Read Details:** Displays meter read details for the consumption used in the rate calculation.
- **SQ Details:** Displays a list of service quantities used in the rate calculation.
- **Characteristics:** Displays characteristics referenced by the rate calculation (if applicable).
- **Trace Log:** Displays logs that outline the calculation groups and rules used by the rate schedule. This zone is populated only if using a calculation rule-based rate schedule, and if the Should Trace dropdown list is set to "No".

Effective Dates and Price Proration

This section describes how proration applies to different types of calculation rules. Proration implies assessing charges proportionately.

The term "proration" describes two different issues:

- Prorating a charge whose value changes during a bill period. For example, if a tax rate changes during a bill period and you've indicated that such changes should be prorated, the system prorates the tax change (e.g., 20 days at 5% and 10 days at 6%).
- Prorating charges when the time period being billed is not in sync with the time period in which the charges were defined in the rate. For example, if a rate contains a flat monthly charge and the bill period spans two months, the flat charge must be prorated.

This is a complicated topic as it's possible for many proration issues to exist on a single bill. For example, on a single bill:

- The rate structure can change several times during the bill period (i.e., multiple rate versions are effective).
- The taxing authority changes the tax rate.
- The customer's tax exemption changes.
- The customer-specific price can change.
- etc.

Types of Proration

The following section describes the types of proration performed by applying a rate.

FASTPATH:

For more information on how prorated charges are presented on the printed bill, refer to [How To Use Description On Bill](#).

Consumption Period Proration

A rate schedule specifies its frequency. Bill segments generated using a rate are expected to have a consumption period that corresponds to this frequency. When a bill segment's consumption period falls outside of the rate frequency's normal period, proratable service quantities may be adjusted to match the normal period for calculation. The service quantities are then re-adjusted based on calculation period proration.

FASTPATH:

Refer to [Service Quantity Proration](#) for more information about these calculations.

Calculation Period Proration

There can be multiple versions of a given rate over time. Each version has an effective date. When the system detects that a rate schedule has multiple versions of a rate in effect during a bill period, it may or may not prorate the charges. You control exactly how the system handles this situation using the rate schedule's proration parameters.

If multiple rate versions are effective during the consumption period and the rate schedule is configured to prorate the rate versions, a given bill segment will contain a set of bill calculation lines for each rate version. You should consider quite carefully how to handle this situation on your printed bills as rate version proration can confuse a customer.

FASTPATH:

Refer to [Defining Calculation Rules](#) for more information.

Bill Factor Proration

A rate contains calculation rules. The primary reason a calculation rule exists is to define how much to charge for the services sold by your company. When you create calculation rules, you have two ways to indicate how much to charge:

- You can specify the value directly in a calculation rule.
- You can have the calculation rule use a bill factor that contains the value.

Bill factors are effective-dated (meaning, their values may change over time). When the system detects that a calculation rule's bill factor has multiple values in effect during a bill period, it may or may not prorate the charges. You control exactly how the system handles this situation using the bill factor's proration parameters.

FASTPATH:

Refer to [Defining Bill Factors](#) and [Bill Factor Value Proration](#) for more information.

Tax Exemption Proration

Bill factors that levy taxes may or may not be eligible for tax exemptions; it's up to the respective taxing authority. Customers who are eligible for tax exemptions will have their tax obligation reduced (or nullified) at billing time.

Whether or not a customer is tax exempt (and the percent exempt) is defined on the service agreement's tax exemption page. A customer's tax exemptability is effective-dated (it may change over time). If a customer's tax exemptability changes during a bill period, the system may or may not prorate the charges. You control exactly how the system handles this situation using the bill factor's proration parameters.

Contract Value Proration

Some types of bill factors do not have the same value for all customers. For example, you may have rates where the price per kilowatt-hour can be different for every customer using the rate.

For bill factors whose value is customer-specific, the value is defined on the service agreement's contract value page. The contract value is effective-dated (it may change over time). If a customer's contract value changes during a bill period, the system may or may not prorate the changes. You control exactly how the system handles this situation using the bill factor's proration parameters.

Contract Rider Proration

Contract riders are used when the charge associated with a bill factor is only applicable to some customers for some period of time. For example, if a bill factor is used to provide a discount during the first three months of service, then a contract rider would be used.

A customer's contract rider applicability period is defined on the service agreement's contract rider page. A rider's applicability may change during a customer's bill period. You control exactly what the system does when a rider's applicability changes during a bill period using the bill factor's proration parameters.

A Service Agreement's Rate Changes Are Not Prorated

A service agreement's rate is effective-dated (it may change over time). When the system calculates a service agreement's bill segment when multiple rates are effective during the bill period, it will use a single rate from the service agreement's rate history. The system chooses the rate as per the service agreement's SA type's rate selection date.

FASTPATH:

Refer to [SA Type - Rate](#) for more information.

Proration Factors

The purpose of calculation rules is to generate bill calculation lines. When rate application builds bill calculation lines, it may also prorate the charges.

There are multiple types of proration performed by rate application. Service quantities, step boundaries, rate values, and bill factor values may all be prorated as part of applying a rate.

We need to establish some terms in order to understand the calculations.

Normal Days

As mentioned previously, the rate schedule references a frequency that specifies the number of times per year that service agreements referencing the rate are expected to bill. The following formula dictates a rate frequency's normal days: $365 \text{ days} / \text{number of periods per year}$.

Example:

- For a monthly frequency (12 periods per year), $365 / 12 = 30$ days.
- For a quarterly frequency (4 periods per year), $365 / 4 = 91$ days.

FASTPATH:

Refer to [Defining Frequency Codes](#) for more information.

Consumption Period Factor

Before applying a rate, the bill segment's consumption period is determined. The ratio of normal days to consumption period days is the consumption period factor.

The system uses the Minimum and Maximum Days Offset on the rate's [Frequency](#) to determine whether or not the calculation rule should be prorated due to a short or long consumption period.

If the number of days in the consumption period is within the tolerance of days determined by the specified on the rate's frequency, the consumption period factor is 1 (not applicable).

Example:

If the consumption period spans 60 days and the rate's normal days equals 30 days then the consumption period factor is:

- $30 \text{ days} / 60 \text{ days} = 0.5$

If the consumption period spans 31 days and the rate's normal days equals 30 days and the maximum offset is 3 days, the consumption period factor is 1 (not applicable) because the consumption period days falls within the tolerance specified on the frequency.

FASTPATH:

For more information on how a bill segment's consumption period is determined, refer to . For more information on specifying minimum and maximum offset days on frequency, refer to [Defining Frequency Codes](#).

Calculation Period Factor

The calculation period is the date range where a rate version is effective during the consumption period. For each rate version that is effective during the consumption period, a bill segment calculation period is created. A set of bill calculation lines is created for each calculation period.

A calculation period factor is determined for each calculation period. The calculation period factor is the ratio of calculation period days to normal days. If the consumption period factor is 1 (not applicable), then the calculation period factor is the ratio of calculation period days to consumption period days.

Example:

If the consumption period covers April 1 to April 30 and there was a new effective rate version as of April 21, there are two calculation periods.

- Calculation period April 1 to April 20, calculation period factor = $20 \text{ days} / 30 \text{ days} = 0.6666667$.
- Calculation period April 21 to April 30, calculation period factor = $10 \text{ days} / 30 \text{ days} = 0.3333333$.

BF Value Period Factor

The bill factor value period is the date range where a proratable bill factor value is effective during the calculation period.

When a bill factor value changes during the calculation period, the results is that multiple bill calculation lines are generated for the same calculation rule.

The ratio of the number of days within the calculation period that a distinct value is effective to the number of days in the calculation period determines the BF value period factor. When the bill factor is set up not to prorate, the BF value period factor is 1 (not applicable).

Example:

If the state tax rate changes from 6% to 6.5% on April 16 and the calculation period is April 1 to April 30, there are two bill factor value periods.

- Bill factor value period April 1 to April 15, BF value period factor = 15 days / 30 days = 0.5.
- Bill factor value period April 16 to April 30, BF value period factor = 15 days / 30 days = 0.5.

FASTPATH:

Refer to [Defining Bill Factors](#) for more information on specifying whether the bill factor allows proration.

Overriding Proration Factors

If the system logic for determining proration factors does not satisfy your requirements, you may plug in an override proration algorithm to calculate the proration factors as required by your implementation.

- For Calculation Rule-Based Rates, the override proration algorithm is specified in the calculation rule's business object.
- For Component-Based Rates, the overriding proration algorithm is specified in the [Installation](#) record.

The system is delivered with an algorithm type that sets the proration factors to 1 (not applicable) when a predefined characteristic is specified on a calculation rule. Refer to OVPF-NOPROR for more information.

Service Quantity Proration

When a bill calculation line is generated for a service quantity type calculation rule, the applicable service quantity is multiplied by the consumption period factor. That product is then multiplied by the calculation period factor to determine the prorated service quantity for the bill calculation line.

Example:

Customer's electricity bill segment's consumption period is from April 1 through May 15. A new rate version for the rate schedule is effective as of April 16. 100 kWh is consumed.

Assuming a monthly frequency, if the consumption period spans 45 days and the first calculation period spans 15 days, and the applicable service quantity is 100 kWh; then:

- Consumption period factor = 30 normal days / 45 days = 0.6666667.
- Calculation period factor = 15 days / 30 normal days = 0.5.
- Prorated service quantity = 100 kWh x 0.6666667 x 0.5 = 33 kWh.

The next calculation period extends to the end of the consumption period (30 days):

- Consumption period factor does not change = 0.6666667.
- Calculation period factor = 30 days / 30 days = 1.0.
- Prorated service quantity = 100 kWh x 0.6666667 x 1.0 = 67 kWh.

Measures Peak

If the calculation rule specifies that the service quantity measures peak, then service quantity proration is not performed. Although service quantities are not prorated if a calculation rule measures peak, calculation rule values (like price per kW) are prorated.

FASTPATH:

Refer to [Calculation Rule Value Proration](#) for more information.

Step Proration

If a calculation rule's charges are based on stepped pricing then the step boundaries are also prorated (as long as the calculation rule is not marked as measures peak). Step boundaries are multiplied by the calculation period factor to determine the adjusted steps boundaries.

Example:

Assuming a monthly frequency, if the calculation rule's step boundaries are 100 kWh to 300 kWh, and the calculation period is 45 days; the step boundaries are prorated as:

- $45 \text{ days} / 30 \text{ days} \times 100 \text{ kWh} = 150 \text{ kWh}$.
- $45 \text{ days} / 30 \text{ days} \times 300 \text{ kWh} = 450 \text{ kWh}$.

Step Multipliers

If the calculation rule specifies that the steps be multiplied by the result value of another calculation rule, step proration is not performed. It is assumed that the result value from the referenced calculation rule has already been prorated, as the referenced step calculation rule is subject to [Calculation Rule Value Proration](#).

Calculation Rule Value Proration

Except for summary type calculation rules (which are not prorated at all), a value is specified on the calculation rule. The value may be a unit rate, percentage or charge. The value may be specified directly on the calculation rule, derived from a bill factor, derived from another calculation rule, or calculated by an algorithm.

Regardless of where the calculation rule value comes from, it will be multiplied by the calculation period factor when determining the charge on a bill calculation line. Exceptions to this rule are:

- Unit rate values where the calculation rule's measures peak attribute is not checked.
- Percentage values.
- Calculation rule values derived from another calculation rule.

Even though the calculation rule values are not prorated for unit rate and percentage value types, if these rate values change during the calculation period due to a bill factor value change, bill factor value proration still applies.

Values derived from another calculation rule are not subject to rate value proration, as calculation rule value proration was already performed on the referenced calculation rule. Again, if the bill factor value changed on the referenced calculation rule, bill factor value proration still applies.

Example:

A calculation rule charges \$2.00 per kW. The rate schedule's normal days equals 30, and the calculation period spans 15 days. The peak kW service quantity is 50 kW.

- The calculation period factor is 0.5 (15 days / 30 days).
- Calculation rule value proration yields $\$2.00 \times 0.5 = \1.00 per kW.

FASTPATH:

For more information on bill factor value proration, refer to [Bill Factor Value Proration](#).

Bill Factor Value Proration

Bill factor value proration behaves the same way any time a bill factor value changes within a calculation period. This could be due to a change in a tax rate, a contract rider becoming effective, a tax exemption expiring, etc.

Multiple bill calculation lines are generated for a given calculation rule when a prorable bill factor value changes during the calculation period.

Example:

If the state tax rate changes from 6% to 6.5% on April 16, and the calculation period is April 1 to April 30.

- The first BF value factor period April 1 to April 15, so BF value period factor is 0.5.
- The value used in the first bill calculation line for state tax is $6\% \times 0.5 = 3\%$.
- The second bill factor value period is April 16 to April 30, so the BF value period factor is 0.5.
- The value used in the second bill calculation line for state tax is $6.5\% \times 0.5 = 3.25\%$.

Example of Generating Prorated Bill Calculation Lines

Let's say that 1200 kWh was consumed from March 17 to April 30. The peak kW for the consumption period is 20 kW.

A monthly rate schedule E-COM1 exists with two rate versions.

Rate version effective prior to April 1 has the following components:

- \$0.05 per kWh.
- \$1.00 per kW.

Rate version effective as of April 1 has the following calculation rules:

- \$0.04 per kWh; as of April 16, \$0.07 per kWh (new effective bill factor value).
- \$1.50 per kW; as of April 16, \$1.25 per kW (new effective bill factor value).

Calculation Period March 17 to March 31

The consumption period spans 45 days, so the consumption period factor is $30 \text{ normal days} / 45 \text{ days} = 0.6666667$.

This calculation period spans 15 days, so the calculation period factor is 0.5.

Service quantity proration for the first calculation period yields:

- $1200 \text{ kWh} \times 0.6666667 \text{ (consumption period factor)} \times 0.5 \text{ (calculation period factor)} = 400 \text{ kWh}$.

- $20 \text{ kW} \times 1$ (not applicable) = 20 kW.

Calculation rule value proration for the first calculation period yields:

- $\$0.05 \times 1$ (not applicable) = \$.05 per kWh.
- $\$1.00 \times 0.5$ (calculation period factor) = \$0.50 per kW.

First Set of Bill Calculation Lines

Bill calculation line 1: $400 \text{ kWh} \times \$0.05 = \20.00 .

Bill calculation line 2: $20 \text{ kW} \times \$0.50 = \10.00 .

Calculation Period April 1 to April 30

This calculation period spans 30 days, so the calculation period factor is 1.

Service quantity proration for the calculation period yields:

- $1200 \text{ kWh} \times 0.6666667$ (consumption period factor) $\times 1$ (calculation period factor) = 800 kWh.
- $20 \text{ kW} \times 1$ (not applicable) = 20 kW.

Calculation rule value proration for the first calculation period yields:

- $\$0.04 \times 1$ (not applicable) $\times 0.5$ (BF value period factor) = \$0.02 per kWh.
- $\$0.07 \times 1$ (not applicable) $\times 0.5$ (BF value period factor) = \$0.035 per kWh.
- $\$1.50 \times 1$ (calculation period factor) $\times 0.5$ (BF value period factor) = \$0.75 per kW.
- $\$1.25 \times 1$ (calculation period factor) $\times 0.5$ (BF value period factor) = \$0.625 per kW.

Second Set of Bill Calculation Lines

Bill calculation line 1: $800 \text{ kWh} \times \$0.02 \text{ per kWh} = \16.00 .

Bill calculation line 2: $800 \text{ kWh} \times \$0.035 \text{ per kWh} = \26.00 .

Bill calculation line 3: $20 \text{ kW} \times \$0.75 \text{ per kW} = \15.00 .

Bill calculation line 4: $20 \text{ kW} \times \$0.625 \text{ per kW} = \12.50 .

Seasonal Proration

Seasonal proration adds another layer of complexity. If calculation rules are specified to prorate seasonally, the seasonal period specified on a given seasonal calculation rule dictates how a calculation rule's value or associated service quantity is prorated.

There are two proration methods, Prorate and Prorate Seasonal SQ, which may be specified on seasonal calculation rules. Both of these proration methods behave the same way with respect to calculation rule value proration. If a given seasonal calculation rule is eligible for [Calculation Rule Value Proration](#), the ratio of days in the season that are applicable during the calculation period to the days in the calculation period determines the seasonal factor. When it comes to service quantity proration, the two proration methods are different. If a given seasonal calculation rule is eligible for [Service Quantity Proration](#), it prorates the service quantities as follows:

- Prorate. A seasonal factor is calculated as the ratio of days in the season that are applicable during the calculation period to the days in the calculation period. This ratio is applied along with the consumption period factor and calculation period factor to determine the prorated service quantity.
- Prorate seasonal SQ. In this case, it is assumed that either the meter measures seasonal consumption on separate registers or the consumption has been split into separate service quantities by other means (like an SQ rule). To determine a prorated seasonal service quantity, the seasonal proration factor is calculated as for a Prorate seasonal calculation rule. The seasonal factor is then multiplied by another ratio of total consumption period days to days in the season that are

applicable for the total consumption period. This modified seasonal factor is applied along with the consumption period factor and calculation period factor to determine the prorated service quantity.

NOTE:

Prorate seasonal SQ. Specify this option only if you can determine the seasonal consumption as an independent service quantity for use by rate application. Because the service quantities themselves dictate the applicability of the calculation rule, a given service quantity need not appear in rate versions effective outside the season (i.e. a rate version effective on October 1 may not include calculation rules that charge for kWh/summer).

Override Seasonal Proration. If the seasonal functionality provided with the system does not work for your organization, you may override the logic using the Override Seasonal Proration plug-in spot on the [installation](#) record. For example, perhaps the seasonal period is determined dynamically based on the scheduled meter read date of the bill cycle.

Example (Prorate):

Let's say that 600 kWh and 50 kW are the billable service quantities for a consumption period from April 1 to April 30. Prorate seasonal calculation rules are defined on a monthly rate that charge \$0.05 per kWh and \$0.75 per kW from January 1 to April 15. Prorate seasonal calculation rules are defined on the same rate version that charge \$0.06 per kWh and \$0.80 per kW between April 16 and December 31. Assume only one rate version is effective for the consumption period.

- The consumption period factor is 1 (not applicable).
- The calculation period factor is 1.0.
- The seasonal factor for the kWh calculation rule whose season is effective from January 1 to April 15 is 0.5 (15 season days in calculation period / 30 days in the calculation period).
- The resulting bill calculation line uses service quantity proration:
 - $600 \text{ kWh} \times 0.5 \text{ (seasonal factor)} \times \$0.05 = \$15.00.$
- The seasonal factor for the kW calculation rule whose season is effective from January 1 to April 15 is also 0.5.
- The resulting bill calculation line uses calculation rule value proration:
 - $50 \text{ kW} \times \$0.75 \times 0.5 \text{ (seasonal factor)} = \$18.75.$
- The seasonal factor for the kWh calculation rule whose season is effective from April 16 to December 31 is 0.5.
- The resulting bill calculation line uses service quantity proration:
 - $600 \text{ kWh} \times 0.5 \text{ (seasonal factor)} \times \$0.06 = \$18.00.$
- The seasonal factor for the kW calculation rule whose season is effective from April 16 to December 31 is also 0.5.
- The resulting bill calculation line uses calculation rule value proration:
 - $50 \text{ kW} \times \$0.80 \times 0.5 \text{ (seasonal factor)} = \$20.00.$

Example (Prorate seasonal SQ):

Let's say that a given meter measures winter consumption separate from summer consumption. The meter itself measures kWh/summer on a register between June 21 and September 18, and measure kWh/winter on another register at other times of the year.

We are generating a bill segment with a consumption period from September 2 to October 30. A monthly rate schedule has two rate versions effective during the consumption period. The latest rate version is effective on October 1.

Each of the rate version calculation groups have Prorate seasonal SQ seasonal calculation rules defined. The first rate version's calculation rules charge \$0.06 per kWh/summer and \$0.05 per kWh/winter. The second rate version calculation group has a single calculation rule that charges \$0.05 per kWh/winter.

Assume that the billable service quantities are 800 kWh/summer and 1600 kWh/winter.

First set of bill calculation lines (September 2 to September 30):

- The consumption period factor is 30 normal days / 60 consumption days = 0.5.
- The calculation period factor is 30 calculation days / 30 normal days = 1.0.
- calculation rule 1 (\$0.06 per kWh/summer):
- The seasonal factor 17 seasonal days / 30 calculation days = 0.5666667.
- The modified seasonal factor is 0.5666667 x 60 consumption days / 17 seasonal days = 2.0.
- The resulting bill calculation line:
- 800 kWh/summer x 0.5 (consumption period factor) x 2.0 (modified seasonal factor) x \$0.06 = \$48.00.
- calculation rule 2 (\$0.05 per kWh/winter):
- The seasonal factor is 12 seasonal days / 30 calculation days = 0.4.
- The modified seasonal factor is 0.4 x 60 consumption days / 42 seasonal days = 0.571428.
- The resulting bill calculation line:
- 1600 kWh/winter x 0.5 (consumption period factor) x 0.571428 (modified seasonal factor) x \$0.05 = \$22.86.

Second set of bill calculation lines (October 1 to October 30):

- The consumption period factor is 30 normal days / 60 consumption days = 0.5.
- The calculation period factor is 30 calculation days / 30 normal days = 1.0.
- Calculation rule 1 (\$0.05 per kWh/winter):
- The seasonal factor 30 seasonal days / 30 calculation days = 1.0.
- The modified seasonal factor is 1.0 x 60 consumption days / 42 seasonal days = 1.428571.
- The resulting bill calculation line:
- 1600 kWh/winter x 0.5 (consumption period factor) x 1.428571 (modified seasonal factor) x \$0.05 = \$57.14.

FASTPATH:

For more information on specifying seasonal proration options, refer to [Defining Calculation Rules](#).

Price Changes and Interval Quantities

All of the above sections described situations where the service quantities will be prorated due to changes in the price during the billing period. The above sections assume that the bill contains a simple metering scenario, where reads will not exist on the date of the price break.

However, consider an interval billing example. There are two basic pricing scenarios for interval quantities:

Setting Up Estimated Consumption for Items

Some types of physical devices (such as, items) use power but a meter does NOT measure the power consumed. The most common example is a street light. If this situation exists for your company AND if the amount charged for the lamp varies based on the amount of estimated power used, then you will have to maintain estimated DAILY consumption for each type of item. The system uses this information at billing time to estimate how much power was used by the customer's items and then prices the estimated consumption as per the terms in the service quantity calculation rule.

Select **Admin > Rates > Item Type SQ Estimate** to define estimated consumption.

Description of Page

Select the **Item Type** using the search.

Enter the estimated daily consumption in the **Daily Service Quantity**. Each Service Quantity has an **Effective Date** so that changes in the estimated quantities may be recorded over time.

NOTE:

The unit of measure of the daily service quantity is displayed adjacent to the item type description. This value is defined on the item type table.

Where Used

This information is used when the system calculates a bill segment for a service agreement that references service points with items. If the items reference item types for which the system should estimate consumption, the system extracts the daily consumption amount from this table.

Setting Up Degree Days (and Average Temperatures)

Many organizations print degree-day and/or average temperature information on their customers' bills. Select **Admin > Billing > Degree Days > Search** to define these values for a given trend area.

Description of Page

The easiest way to define degree days is to select a **Trend Area** and **Month In Year** and tab out of the field. The system generates one row in the **Degree Days** collection for each day of the month. After the days exist in the collection, you should define the following for each day:

Degree Day This is a unit of measure used to express the extent to which temperatures vary from a specific reference temperature on a given date.

Maximum Temperature This is the maximum temperature on a given date.

Minimum Temperature This is the minimum temperature on a given date.

Average Temperature This is the average temperature on a given date.

Where Used

This information may be used by your bill print routines.

United Kingdom VAT and CCL

The topics in this section provide information about value added tax (VAT) and climate change levy (CCL) charges that are specific to non-domestic customers in the United Kingdom market.

NOTE:

Applicable for UK market. This section is only relevant for the United Kingdom market. Other markets may disregard this section.

UK VAT Overview

Two rates of VAT, referred to as standard rate VAT and reduced rate VAT, are applicable to energy related charges in the UK. Domestic (i.e., residential) customers always pay VAT at the reduced rate. Non-domestic customers on the other hand normally pay standard rate VAT. However, part or all of the energy related charges for a non-domestic customer might be

subject to reduced rate VAT. De minimis and VAT declarations affect the percentage of the energy related charges that is subject to each VAT rate:

- If average daily usage at a premise for a given service type does not exceed a certain threshold (the de minimis limit), all energy related charges at that premise / service type are taxed at the reduced rate.
- Some non-domestic customers, such as those with a mixed-use premise, may be eligible to pay reduced rate VAT on part or all of their energy related charges. Customers may file a VAT declaration specifying the percentage of their energy related charges that are eligible for reduced rate VAT - refer to [Maintaining Declarations](#) for more information. If the declared percentage exceeds a given threshold, the declared percentage is deemed to be 100% and the customer pays VAT at the reduced rate on all energy related charges at that premise. VAT declarations are non-transferable and must be filed for each account, premise, and service type combination.

In addition to the potential for different rates of VAT to be applicable on a bill, UK tax regulations require that excess credits are considered a prepayment of energy related charges together with VAT. Refer to [Excess Credits and UK VAT](#) for more information.

The system comes supplied with various algorithms types that can be used to perform the VAT calculations.

UK CCL Overview

The climate change levy (CCL) is based on the amount of energy used that is subject to standard rate VAT. Similarly to VAT declarations, customers may file for exemption from CCL. A CCL declaration specifies the percentage of the CCL charges that the customer is exempt from - refer to [Maintaining Declarations](#) for more information. CCL declarations are non-transferable and must be filed for each account, premise, and service type combination.

CCL charges themselves are subject to standard rate VAT.

UK VAT and CCL Bill Examples

The following examples show how a bill for a non-domestic customer is affected by de minimis, VAT declarations, and CCL declarations. In the examples, standard rate VAT of 17.5%, reduced rate VAT of 5%, a VAT declaration threshold of 60%, and a CCL charge of 0.43p per unit of energy are used.

Example 1 - Normal Account

This example shows the bill for a normal non-domestic account with no declarations and consumption above the de minimis limit. Standard rate VAT is applied to all energy related charges (the standing charge and the per unit charge) and to the CCL charge.

Bill Line	Amount
Standing Charge	10.00
2,000 units @ 10p	200.00
CCL on 2,000 units @ 0.43p	8.60
VAT @ 17.5% on 218.60	38.25
Total	256.85

Example 2 - Account with Consumption Under the De Minimis Limit

In this example, consumption does not exceed the de minimis limit and therefore reduced rate VAT is applied to all the energy related charges. There is no climate change levy because only units subject to standard rate VAT are subject to CCL.

Bill Line	Amount
Standing Charge	10.00
2,000 units @ 10p	200.00
VAT @ 5% on £210.00	10.05
Total	220.05

Example 3 - Account with VAT Declaration

This example is for a non-domestic account with a VAT declaration of 20%. Consumption is above the de minimis limit. CCL applies to only 80% of the total units as 20% is subject to reduced rate VAT and therefore exempt. 80% of the energy related charges (the standing charge and the per unit charge) and all of the CCL charge are subject to standard rate VAT. 20% of the energy related charges are subject to reduced rate VAT.

Bill Line	Amount
Standing Charge	10.00
2,000 units @ 10p	200.00
CCL on 1,600 units @ 0.43p	6.88
VAT @ 17.5% on £174.88	30.60
VAT @ 5% on £42.00	2.10
Total	249.58

Example 4 - Account with VAT Declaration and CCL Declaration

This example is for a non-domestic account with a VAT declaration of 20% and a CCL declaration of 10%. Consumption is above the de minimis limit. CCL applies to only 80% of the total units as 20% is subject to reduced rate VAT and therefore exempt. The customer gets a credit (CCL relief) for 10% of the CCL charges as a result of the CCL declaration. 80% of the energy related charges (the standing charge and the per unit charge) and all of the CCL charge less the CCL reliefs are subject to standard rate VAT. 20% of the energy related charges are subject to reduced rate VAT.

Bill Line	Amount
Standing Charge	10.00
2,000 units @ 10p	200.00
CCL on 1,600 units @ 0.43p	6.88
CCL relief	<0.68>
VAT @ 17.5% on £174.20	30.48

VAT @ 5% on £42.00

2.10

Total

248.78

Billing and UK VAT

The following sections describe how VAT rules are implemented when a bill is produced.

Application of De Minimis

The de minimis rule specifies that all energy related charges at a premise be subject to reduced rate VAT if the total usage at a premise does not exceed a certain threshold. To determine if de minimis applies, the total billed consumption for a premise must therefore be known. However, energy usage at a premise may be measured with several meters and billed by multiple service agreements. To ensure that the final billed consumption for the premise is used to determine if de minimis applies, all service agreements for an account of a given service type at a given premise should be billed together and de minimis should be checked after the bill segments have been generated. In addition, all bill segments on one bill for consumption at a given premise must be for the same bill period.

NOTE:

Bill segments from different periods may not appear on the same bill. If a bill segment is canceled, all bill segments associated with consumption at a given premise for the same service type must be canceled and re-billed together. You cannot re-bill the bill segment on a bill for a different period.

An **Apply De Minimis Rule** Customer Class – Pre Bill Completion algorithm type CPBC-DMCH is supplied with the base package that checks for de minimis at bill completion time. The base bill completion algorithm type checks that for any service agreement that was billed, bill segments for all the account's service agreements with the same service type and characteristic premise exist on the bill. It then calculates the total consumption for the premise and determines if de minimis applies. If de minimis applies, it sets a bill characteristic whose value is the premise ID to indicate that de minimis applies and regenerates the bill segment. Refer to the **Apply De Minimis Rule** algorithm type CPBC-DMCH for more information on how this type of algorithm operates.

For calculation rule-based rates, the **Apply VAT to Cross-Referenced Charges** calculation rule business object (C1-ApplyVatToCrossRefCharge) calculates standard and reduced rate VAT and applies the de minimis rule if the bill characteristic for de minimis is found. Refer to [Calculation of VAT](#) for more information. Note that during the initial generation of each bill segment, the characteristic will not exist and standard rate VAT will be applied. This means that if you look at a bill before it is complete, VAT may not be accurately reflected.

NOTE:

Batch billing cannot regenerate re-billed bill segments. If you cancel and rebill a bill segment, you should complete the bill on-line so that the re-billed bill segments can be regenerated if de minimis applies.

Calculation of VAT

To calculate VAT, the percentages of energy related charges subject to standard rate VAT and reduced rate VAT must be determined. As these percentages vary from customer to customer and even from one bill to the next for the same customer, their calculation must take place at billing time and is handled by the following:

For calculation rule-based rates, the **Apply VAT to Cross Referenced Charges** business object (C1–**ApplyVatToCrossRefCharge**) is provided to calculate the percentages of energy related charges subject to standard rate and reduced rate VAT, taking into account de minimis and any VAT declaration that is in effect for the service type, account, and premise. The percentages can then be applied to the appropriate charges that are cross-referenced.

Calculation of CCL

CCL is a charge per unit of energy subject to standard rate VAT. It is therefore dependent on the same percentage of energy related charges subject to standard rate VAT determined during the calculation of VAT.

For calculation rule-based rates, a **Calculate Climate Levy and Relief Charges** calculation rule business object (C1–**ApplyCCLCharges**) is provided to calculate CCL charges and CCL relief, taking into account any CCL declarations that are in effect for the service type, account, and premise.

Excess Credits and UK VAT

When a financial transaction that results in a credit balance for a service agreement is frozen, the amount of the excess credit must be accounted for as a prepayment of energy related charges and VAT. VAT is calculated at the reduced rate for domestic customers and at the standard rate for non-domestic customers. When the excess credit is used, the VAT liability is reversed.

A **Create Excess Credit GL Details** Customer Class FT freeze algorithm type CFTZ-VAT-GL is provided to create additional GL detail entries for unbilled revenue and VAT liability when the freezing of an FT results in a credit balance or a change to a service agreement's credit balance.

Excess Credit GL Accounting Example

The following example shows the additional GL details that are created when a service agreement's balance changes and the starting or ending balance is a credit. For this example, a single VAT rate of 10% is used simply to illustrate the principle.

The service agreement has a zero starting balance. Note the following:

- When the first payment is received, the overpayment results in a credit balance and additional GL entries are created to recognize the unbilled energy revenue and unbilled VAT liability.
- When the second bill segment is created, the credit balance is reduced and additional GL entries are created to back out the unbilled GL entries, up to the amount of the credit balance.
- When the bill segment is canceled, the service agreement again has a credit balance and additional GL entries are created to recognize the unbilled energy revenue and unbilled VAT liability.

Event	Normal GL Accounting	Additional GL Accounting	SA Balance
Bill segment for £110 created	A/R 110		110
	Revenue <100>		
	VAT <10>		
Payment of £330 is received	Cash 330	A/R 220	<220>
	A/R <330>	Unbilled Energy <200>	
		Unbilled VAT <20>	
Bill segment for £275 created	A/R 275	A/R <220>	55
	Revenue <250>	Unbilled Energy 200	

	VAT <25>	Unbilled VAT 20	
Payment of £55 is received	Cash 55		0
	A/R <55>		
Bill segment for £275 is canceled	A/R <275>	A/R 275	<275>
	Revenue 250	Unbilled Energy <250>	
	VAT 25	Unbilled VAT <25>	

Setting Up The System For UK VAT and CCL

The following sections provide an overview of how to configure the system to apply UK VAT and CCL charges for non-domestic customers.

Bill Segment Freeze Installation Option

Select Freeze at Bill Completion as the bill segment freeze option. The system determines if de minimis applies at bill completion time and has to regenerate the bill segments as necessary.

Customer Class

Create a separate customer classes for non-domestic customers.

Service Agreements

You must configure the system so that each service agreement that must be checked for de minimis is only linked to service points at a single premise. The service agreement must reference that premise as its characteristic premise. Refer to [Application of De Minimis](#) for more information.

Bill Factors for UK VAT and CCL

- Standard Rate VAT
- Reduced Rate VAT
- VAT Declaration Percentage Threshold. Set up a separate bill factor for each service type as the thresholds differ based on service type.
- De Minimis Average Daily Amount Threshold. Set up a separate bill factor for each service type as the de minimis amounts differ based on service type.
- Climate Change Levy (CCL) Per Unit Price. Set up a separate bill factor for each service type as the CCL per unit prices differ based on service type.

Characteristic Type for De Minimis Amounts

Set up a characteristic type to use for the bill characteristic that indicates when de minimis applies. Define the type of characteristic value as a Foreign Key Value and specify a foreign key reference that points to the premise table. Specify this characteristic type as parameters to the algorithms that apply the de minimis rule and that apply VAT.

You need to define a characteristic type for every service type that is subject to the de minimis rule, as the de minimis limit may apply for one service type but not another on the same bill.

NOTE: A **De Minimis Premise** Characteristic Type is provided that may be used for a specific service type. For additional service types, additional characteristic types will need to be defined.

Distribution Code

Define the following distribution codes:

- Unbilled Prepaid Energy Related Charges
- Unbilled Prepaid VAT

These distribution codes are required as parameters to the algorithms to create the GL details for excess credit.

UOM / TOU / SQI

If using calculation rule-based rates, the calculation rule that calculates CCL requires the consumption that is subject to standard rate VAT as a service quantity.

Define the UOM / TOU / SQI used to store these service quantities.

Service Quantities

If using calculation rules-based rates, the algorithm that checks if the de minimis applies, requires a service quantity containing the total consumption. Unless you have registers that measure the total consumption independent of time of use or interval, you will need to set up a pre-processing calculation group with a calculation rule to aggregate the usage into one service quantity.

Algorithms for UK VAT and CCL

Add the following [algorithms](#):

- Apply De Minimis Rule. Define an algorithm for each service type for which de minimis should be checked. Plug the algorithm(s) in on the customer class for the Pre Bill Completion system event. Refer to the CPBC-DMCH algorithm type for more information about the base package algorithm.
- Create Excess Credit GL Details. Plug this algorithm in on the customer class for the FT Freeze system event. Refer to the CFTZ-VAT-GL algorithm type for more information about the base package algorithm.
- Highlight Effective Declarations for Account and Premise. Plug this algorithm in on the installation option for the Control Central Alert system event. Refer to the CCAL-DECL algorithm type for more information about the base package algorithm.

Calculation Rules to Charge VAT and CCL

Four additional calculation rules are required to charge for VAT and CCL on non-domestic rates:

- Calculate standard rate VAT
 - Calculation Rule Type= Apply VAT to Cross Referenced Charges
 - VAT Calculation Type = Standard Rate
 - Specify the De Minimis Characteristic Type
 - Specify Declaration Percentage Threshold Bill Factor
 - Specify Value Source. It is recommended that you use a value source of Bill Factor and reference the bill factor you set up for standard rate VAT.
 - Note that the calculation rule overrides description on bill
 - Cross-reference the calculation line category for energy related charges that are subject to VAT
- Calculate reduced rate VAT
 - Calculation Rule Type = Apply VAT to Cross Referenced Charges
 - VAT Calculation Type = Reduced Rate
 - Specify the De Minimis Characteristic Type
 - Specify Declaration Percentage Threshold Bill Factor
 - Specify Value Source. It is recommended that you use a value source of Bill Factor and reference the bill factor you set up for standard rate VAT.
 - Note that the calculation rule overrides description on bill
 - Cross-reference the calculation line category for energy related charges that are subject to VAT
- Calculate CCL and CCL Relief
 - Calculation Rule Type = Calculate Climate Change Levy and Relief Charges
 - UOM/TOU/SQI = the identifier of the service quantity that the prices applies to
 - Specify Value Source. It is recommended that you use a value source of Bill Factor and reference the bill factor you set up for standard rate VAT.
 - Note that the calculation rule overrides description on bill
- VAT on CCL
 - Calculation Rule Type = Apply To
 - Value type = Percentage
 - Specify Value Source. It is recommended that you use a value source of Bill Factor and reference the bill factor you set up for standard rate VAT.
 - Cross-reference the calculation line category for the total CCL and CCL Relief related charges

Setting up the calculation rules as above produces separate lines for VAT on energy related charges and on CCL (i.e., lines will be created for standard rate VAT on energy related charges, reduced rate VAT on energy related charges, and standard rate VAT on CCL charges).

You can set up rates to calculate standard rate VAT on energy related charges and CCL together as follows:

- Calculate standard rate VAT charges
 - Calculation Rule Type = Apply VAT to Cross Referenced Charges

- FCPO = Yes
- VAT Calculation Type = Standard Rate
- Specify the De Minimis Characteristic Type
- Specify Declaration Percentage Threshold Bill Factor
- Value Source = Value
- Value = 100
- Note that the calculation rule overrides description on bill
- Cross-reference the calculation line category for energy related charges that are subject to VAT
- Calculate CCL and CCL Relief
 - Calculation Rule Type = Calculate Climate Change Levy and Relief Charges
 - UOM/TOU/SQI = the identifier of the service quantity that the prices applies to
 - Specify Value Source. It is recommended that you use a value source of Bill Factor and reference the bill factor you set up for standard rate VAT.
 - Note that the calculation rule overrides description on bill
- Calculate standard rate VAT
 - Calculation Rule Type = Apply To
 - Value type = Percentage
 - Specify Value Source. It is recommended that you use a value source of Bill Factor and reference the bill factor you set up for standard rate VAT.
 - Cross-reference the calculation line category for the total CCL and CCL Relief related charges
- Calculate reduced rate VAT:
 - Calculation Rule Type = Apply VAT to Cross Referenced Charges
 - VAT Calculation Type = Reduced Rate
 - Specify the De Minimis Characteristic Type
 - Specify Declaration Percentage Threshold Bill Factor
 - Specify Value Source. It is recommended that you use a value source of Bill Factor and reference the bill factor you set up for standard rate VAT.
 - Note that the calculation rule overrides description on bill
 - Cross-reference the calculation line category for energy related charges that are subject to VAT

Quotes

A quote allows you to show a customer how their bill segments will look if a given set of pricing terms is applied to a given amount of consumption. If the customer accepts a quote, one or more real service agreements are created.

FASTPATH:

Refer to [Defining Quotation Options](#) for how to setup the system to enable quotation functionality.

NOTE:

Separate module. Please note that the quoting functionality is part of the Contract Management module. If this module is not applicable to your business you may turn it off. Refer to [Turn Off A Function Module](#) for more information.

The topics in this section describe the quotation functionality.

The Big Picture Of Quotations

The topics in this section provide background information about a variety of quotation features and functions.

WARNING:

If you are not familiar with the concepts described under [Sales and Marketing](#), [Billing](#), [Rates](#) the quotation functionality will be difficult to understand.

Basic Quotation Concepts

The section describes basic quotation concepts.

A Quote Shows How Bill Segments Might Look

A quote shows how a customer's bill segments will look if a given set of pricing terms is applied to a given amount of consumption. The following example illustrates how a quote might look that provides a customer with two different options for their electric service. If the customer elects either option, a new service agreement would be created.

The screenshot shows a 'Quote' window for account '1231231123 - ABC Supply'. It is divided into two columns: 'Quote Detail 1' and 'Quote Detail 2'. Both details share the same SA Type (Electric) and Rate (EQ-10 for Detail 1, AA-34 for Detail 2), and the same address (72 Market Street, San Fran., CA). Each detail shows two time periods with associated bill segments and amounts.

Quote Detail 1		Quote Detail 2	
SA Type: Electric	Rate: EQ-10	SA Type: Electric	Rate: AA-34
72 Market Street San Fran., CA		72 Market Street San Fran., CA	
Period: 1-Jan-00 - 31-Jan-00		Period: 1-Jan-00 - 31-Jan-00	
Descript.	Amount	Descript.	Amount
Usage < Cap	\$500	Hedge	\$400
Usage > Cap	\$100	> Hedge	\$201
Period: 1-Feb-00 - 28-Feb-00		Period: 1-Feb-00 - 28-Feb-00	
Descript.	Amount	Descript.	Amount
Usage < Cap	\$525	Hedge	\$625
Usage > Cap	\$111	> Hedge	\$1

Please note the following about a quote:

- A quote is related to an account.

- A quote can contain many quote details. A quote detail shows how bill segments will look if a given set of pricing terms (e.g., rates, riders, contract quantities, contract options, etc.) is applied to a given amount of consumption.
- A quote detail may contain many simulated bill segments. For example, a quote detail could show the customer what their monthly bills would be if a given set of pricing terms were used over the course of several months (where each month has different consumption levels and different prices).
- A quote may contain multiple quote details for the same service. For example, a quote can contain four different pricing options for the same service (where each option is shown using a separate quote detail). The customer can then compare them and choose the optimum option.
- A quote may contain quote details for multiple premises and multiple services at each premise. For example, a quote can contain quote details for electric and gas service at multiple premises.

Proposal Service Agreements Must Exist

You cannot create a quote unless its account has at least one proposal service agreement (SA). A proposal SA contains the pricing terms, legal terms, and template consumption used to generate the simulated bill segments that appear on a quote. It might be helpful to view a proposal SA as special type of service agreement that is ignored when a bill is produced for an account.

The topics in this section provide detailed information about proposal SAs.

Proposal SAs Contain Pricing Terms

The pricing terms (e.g., rates, contract quantities, riders, bill factor values, etc.) used to generate a quote detail's simulated bill segments reside on a special type of service agreement (SA) referred to as a "proposal SA". Proposal SAs are like real SAs in many respects. In fact, you can view and change a proposal SAs pricing terms using the same transaction used to maintain real service agreements (i.e., [service agreement maintenance](#)).

NOTE:

Quote details are rather empty. A quote detail doesn't contain the pricing terms or template consumption. Rather, a quote detail references a proposal SA and the proposal SA contains the pricing terms and template consumption.

Legal Terms and Conditions May Be Specified On Both Proposal And Real SAs

In addition to containing pricing terms, proposal SAs also contain the legal terms and conditions (T&Cs) that govern the proposal.

Proposal Service Agreement

SA Type: **Electric**

72 Market Street
San Fran., CA

Rate: **EQ-10**

Quantity Type	Value
Subscribed Demand	10
Hedge Percentage	15

Terms & Conditions

This quote requires a commitment of at least 6 months. Early cancellation results in a fee of 2 times the average bill amount.

This quote was calculated using historical market prices. The historical market prices should not be assumed to be the same in the future

Your master list of terms and conditions are defined when you setup your control tables. The system defaults a service agreement's T&Cs from the [start option](#) used to initially create it. You can change a SA's T&Cs at will.

NOTE:

Real SAs and proposal SAs can reference T&Cs. Both proposal and real SAs can reference T&Cs. The T&Cs on a proposal SA are those that will apply if the customer accepts the related quote detail. The T&Cs on a real SA are those that apply while the SA is active.

Proposal SAs Contain Billing Scenarios And Template Consumption

In addition to the pricing terms and the legal terms and conditions, a proposal SA also contains [billing scenarios](#). A billing scenario defines:

- The number of simulated bill segments that will be generated when a quote detail is produced for the proposal SA.
- The bill period of each simulated bill segment.

A proposal SA's billing scenarios can be created as follows:

- A plug-in spot exists on [SA type](#) called Proposal SA Creation. Algorithms plugged into this spot can setup billing scenarios. Refer to [Enabling The Automatic Generation Of Billing Scenarios](#) for more information about how to do this.
- A user can add / change / delete billing scenarios on a proposal SA using [Service Agreement - Billing Scenario](#).

Proposal SAs Differ From Real SAs

A proposal SA is just like any other SA in that it contains the pricing terms that are used to generate how much the customer owes for service. In fact, the [service agreement maintenance transaction](#) is used to maintain both types of service agreements (however, you cannot use this transaction to create a proposal SA; proposal SAs can only be created using the [order transaction](#)).

However, there are differences between proposal SAs and real SAs:

- Billing ignores proposal SAs.

- Proposal SAs cannot have financial transactions.
- Proposal SAs are not subject to credit and collections.
- Proposal SAs do not appear on lists of "active" SAs in the system's various zones, grids and trees.
- Fieldwork is not performed for proposal SAs.
- A proposal SA's state transition is very different from a real SA. Refer to [The Lifecycle Of A Service Agreement](#) for an illustration of a real SAs state transition. Refer to [Proposal SA State Transition](#) for an illustration of a proposal SAs state transition.

Proposal SA State Transition

The following diagram shows the possible lifecycle of a proposal SA.

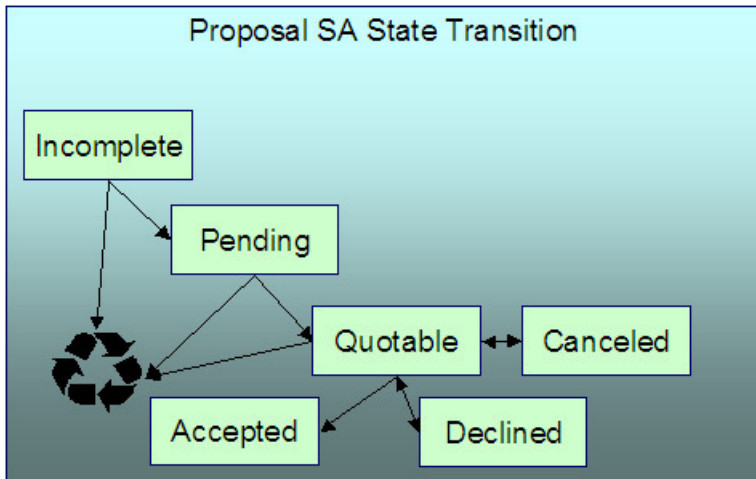

You should never see an Incomplete proposal SA as this is a transitory state used when a proposal is first initiated using the [Order](#) transaction. The system always transitions such proposal SAs to the Pending state. Please note that when a proposal SA becomes Pending, the system executes any Proposal SA Creation algorithms plugged in on the proposal SA's SA type. You might use such algorithms to generate billing scenarios or initiate a workflow process that requests template consumption from the prospect.

A proposal SA exists in the Pending state while you are working on the proposal. For example, you might want to leave the proposal SA in this state while you wait for the prospect to send you their historical consumption.

A proposal SA is Quotable when a quote detail can be generated for it (at least one billing scenario must be linked to the proposal SA before it can become Quotable). Note, proposal SAs can be modified when they are Quotable.

NOTE:

Automatically transitioning a proposal SA to the Quotable state when it's first created. As described earlier, you can setup a proposal SA creation algorithm to automatically create billing scenarios when a proposal SA is created. The base package algorithm can also automatically transition the proposal SA to the Quotable state (thus making it ready for quotation). Refer to [Enabling The Automatic Generation Of Billing Scenarios](#) for more information.

A proposal SA becomes Accepted when a customer accepts one of its quote details.

A proposal SA becomes Declined when a customer declines one of its quote details (or its quote expires). A Declined proposal SA can be "reopened" (by making it Quotable). You may need to do this if you want to change a proposal SA's terms in preparation of generating a new quote detail.

A proposal SA becomes Canceled when a quote detail is withdrawn (or its quote expires). You may need to do this if you want to change a proposal SA's terms in preparation of generating a new quote detail.

Incomplete, Pending and Quotable proposal SAs may be deleted.

Orders Are Used To Create Proposal SAs

Proposal SAs can only be created using the [order](#) transaction. This transaction allows a user to pose eligibility-oriented questions to a customer or prospect. The system determines which [packages](#) of goods and services for which they are eligible based on the answers to the questions. If the customer is interested in receiving a package, one or more SAs (real and/or proposal) are created using the [SAs To Create](#) information defined on the selected package.

NOTE:

You must setup campaigns and packages before you can create an order. If you are not familiar with the [order](#) transaction, you should take the time to form an intuitive understanding of the concepts described under [Sales & Marketing](#). With this knowledge in place, you can design and set up the campaigns and packages necessary to allow an order to create proposal SAs. Keep in mind that a single switch controls whether real SAs or a proposal SAs are created when a package is selected on the order transaction. This switch resides on [Package - SAs To Create](#).

A package could create a combination of real and proposal SAs. When a customer elects to take a package of goods and services (via the [order](#) transaction), the system creates a service agreement for each SA type / start options defined on the package's [SAs To Create](#). It is possible to setup a package to create both real and proposal SAs. For example, the customer may be calling you to start electric service, but they may also be interested in seeing a proposal for gas service.

You don't create special SA types for proposal SAs. The SA type on a proposal SA is the same as the SA type on the real SA that's created when the proposal SA is accepted. This is because the business rules on your SA types govern both real and proposal SAs.

You don't need special start options for proposal SAs. The start options that you setup to default information onto new, real service agreements are also referenced on the [SA To Create](#) information used to create proposal SAs.

Proposal SAs May Be Grouped Under An Umbrella Agreement

Each proposal SA may be part of a larger contract for multiple services that you are negotiating with a customer or group of customers. You may use an [umbrella agreement](#) and its collection of terms of service records to group together multiple proposal service agreements.

Creating Quotes And Quote Details

Once an account has quotable proposal SAs, you can generate a quote for the account using the quote maintenance transaction. When you generate a quote for an account, you can include quote details for any / all of the account's quotable proposal SAs.

The logic used to create a quote detail's simulated bill segments is not hard-coded. Rather, the system calls the algorithm plugged in on the proposal SA's [SA type](#) in the Proposal SA - Bill Segment Generation plug-in spot. Refer to [Enabling The Generation Of Simulated Bill Segments](#) for information about this plug-in spot.

The major difference between a bill segment linked to a quote detail and one linked to a bill is that a quote detail's bill segments are calculated using simulated consumption. This means that the financial information on quote details is not a guess - it's what the bill would be if a given amount of consumption was priced using the pricing terms (as long as you opt to use rate application to calculate the simulated bill segments).

In addition to this major difference, there are a few minor differences between a real bill segment and a simulated bill segment:

- A quote detail bill segment does not have a foreign key to a bill. Rather, it references a quote detail.

- A quote detail bill segment's prime key is inherited from its quote detail (rather than its bill).
- A quote detail bill segment can never have a financial transaction linked to it.
- A quote detail bill segment doesn't have read details.
- A quote detail bill segment's state transition is simpler (it's either in the Error state or OK).

Completing A Quote Creates Quote Routings (And More)

When a quote's quote details are all OK, you change the status of the quote to complete to indicate the quote is ready to be sent to the customer or prospect.

When a quote is completed, the system creates a [quote routing](#) for each person who receives a copy of the account's quotes. When you indicate a person should receive a copy of the account's quotes, you define the routing method (e.g., email, fax, post) and the appropriate address.

NOTE:

Recipients of quotes. You define who receives a copy of an account's quotes on the [Account - Persons](#) page. The system assumes (by default) that the main person linked to the account should receive the account's quotes. You can subsequently indicate any person linked to the account should receive its quotes (and turn off the creation of quotes for the main person). In addition, you can manually add additional quote routings to a quote if you need to send the quote to individuals not currently linked to the account. Refer to [How To Reprint A Quote](#) for more information.

The information that appears on the quote routing record is controlled by the [quote route type](#) specified on the respective account / person information:

- If the quote route type's routing method is email or fax and the system has been configured to use notification preferences for quote routing, a quote routing is created for each active contact preference whose notification type is associated with the **quote route type** specified on the respective account / person information. Refer to *Bill and Quote Routing in Designing Notification Types* for more information. Otherwise, quote routings are created as follows:
 - If the quote route type indicates the person's quotes are routed via fax, the person's fax number is used as the routing information. The system knows which of a person's person contacts is a fax number is by the contact routing or which of a person's phone numbers is a fax number by the phone type.
 - If the quote route type indicates the person's quotes are routed via email, the person's [Email address](#) is used as the routing information. The system knows which of a person's person contacts is an email or knows where to find the person email.
- If the quote route type indicates the person's quotes are routed via the postal service, the address constituents are populated with the address specified on the **bill** address source that is also specified on the [account / person information](#). Note, if the person has a [seasonal address](#) effective on the business date, the seasonal address will be used regardless of the value of **bill address source**.

Regardless of whether the quote is routed via fax, email or post; the routing record is also stamped with the batch process and run number that performs the download of the quote information. The batch process is defined on the quote route type. Refer to [Printing Quotes](#) for more information about this batch process.

In addition to creating routing information at completion time, the system executes any quote completion algorithms plugged in on the account's customer class. For example, you may want to create a workflow process to manage the processing of the quote. To do this, you plug in a Quote Completion Algorithm that creates a workflow process on the respective [customer class](#).

Accepting / Declining Quote Details

A customer can accept or decline each quote detail on a quote.

When a quote detail is accepted, the system:

- Changes the state of the related proposal SA to accepted.
- Executes the Proposal SA - Acceptance algorithms plugged in on the proposal SA's SA type. The base package algorithm creates a real SA by copying the information from the proposal SA. The real SA is created in the pending start state. This new SA behaves similarly to a pending start SA that's created via the [Order](#) or [Start/Stop](#) transactions (e.g., field activities are initiated if the SA type has been setup accordingly).

When a quote detail is declined, the user must supply a decline reason. The system then changes the state of the related proposal SA to declined.

FASTPATH:

Refer to [Proposal SA State Transition](#) for more information about a proposal SA's states.

NOTE:

Reopening a declined proposal SA. If a customer changes their mind about a declined proposal SA, you can return it to the quotable state using the [service agreement maintenance transaction](#).

Rejecting an entire quote. If all details on a quote are being declined, you can simply change the state of the quote to closed rather than reject each quote detail. Refer to [Closing Quotes](#) for more information.

Tinkering With Proposal SAs After Quote Generation

The system allows a quotable proposal SA to be changed, EVEN IF QUOTE DETAILS HAVE BEEN GENERATED. This is intentional as otherwise you would have to create an entirely new proposal SA if you wanted to send another quote for slightly different terms. Your technical team could always introduce a user exit to prevent this from happening if you really didn't want this to take place.

Because the system allows this, a potential issue is that the customer may end up accepting a proposal SA that differs from the terms on his quote (e.g., you could change the SA after the quote detail is generated). For this reason, we snapshot the version number of the proposal SA on the quote detail at the time it's generated. If a proposal SA is accepted and its version number differs from the value on its quote details, a warning is produced.

A warning is also issued if you change a proposal SA and a quote detail exists (reminding you to generate a new quote / quote detail).

In addition to the above, it's also important to understand that the system intentionally allows multiple quotes to reference a given proposal SA. This allows you to leave multiple quotes open that reference the same proposal SA(s).

Closing Quotes

Every quote has an expiration date. The [CLOSEQTE](#) background process closes quotes on their expiration date. This process changes the state of all related proposal SAs to canceled or declined (an input parameter of this process controls which state is used).

You can also close a quote real time using the quote maintenance transaction. When you do this, the system asks if the related proposal SAs should be left as quotable or if they should be changed to canceled or declined.

NOTE:

Reopening a declined proposal SA. If a customer changes their mind about a declined proposal SA, you can return it to the quotable state using the [service agreement maintenance transaction](#).

Alerts

The [alert zone](#) highlights if:

- The selected account has pending or complete quotes. Refer to [Quote Lifecycle](#) for more information.
- The selected account has pending or quotable proposal SAs. Refer to [Proposal SA State Transition](#) for more information.

Trees

The [account tree](#) highlights:

- The existence of non-closed quotes
- The existence of proposal SAs and their related quote details

Printing Quotes

The contents of this section describe the technical implementation of printing quotes.

Quote Routings Are Created For Each Recipient Of A Quote

Refer to [Completing A Quote Creates Quote Routings](#) for a description of how the system constructs the information used to route a quote to one or more recipients.

Quote Route Types Control The Information Merged Onto Quotes

Every quote routing references a [quote route type](#).

The quote route type controls the following quote functions:

- It contains an algorithm that is responsible for extracting the information merged onto your quotes. Specifically, algorithms of this type create the "flat file records" that are passed to your quote-print software. Algorithms of this type are called under the following scenarios:
 - The background process that builds the flat file that's passed to your quote-print software calls these algorithms to construct the "flat file records" for each quote. Refer to [Technical Implementation of Printing Quotes In Batch](#) for the details.
 - If your quote-print software has the ability to construct a real-time image of a quote (in a PDF), you can plug in an Online Quote Display algorithm on the [Installation Record](#). This type of algorithm calls the quote's dispatch group extract algorithm to extract the information that is merged onto the quote. Refer to [Technical Implementation Of Online Quote Display](#) for the details.
- Refer to [The Quote Extract Records](#) for examples of the record layouts passed to the document composition application.

- It contains the ID of the background process that builds the flat file that's passed to your quote-print software. The base package example of this background process ([QUOTROUT](#)) simply calls the extract algorithm on the routing record's route type to format the information placed onto the flat file.

NOTE: CIS Division can override the extract algorithm and/or the background process found on the quote route type. The system processes first check the quote's account's CIS Division for an override specific for the quote route type.

Technical Implementation Of Online Quote Display

Users can view an image of any quote if you set up the following:

- Plug in an Online Quote Display construction algorithm on the [Installation Record](#). Refer to ONQD-DOC1 for an example of such an algorithm. Note if your quote-print software is not capable of producing a PDF containing an image of a quote, users will not be able to view images of quotes.
- Plug in the appropriate extract algorithm on each [quote route type](#). Algorithms of this type format the records that contain the information that is passed to your printing software. Refer to QTEX-EX for an example of such an algorithm.

When you plug in these algorithms, a button appears on [Quote - Main](#). When a user clicks this button, the following takes place:

- The installation record's Online Quote Display algorithm is executed.
- This algorithm calls the quote's route type's extract algorithm. This algorithm constructs the information that's merged onto the quote and returns it to the Online Quote Display algorithm. This algorithm, in turn, passes it to the quote-print software.
- The quote-print software renders an image of the quote in a PDF and returns it to the Online Quote Display algorithm.
- And finally, the Online Quote Display algorithm displays the PDF in a browser session. Note that the client must have Adobe Acrobat Reader installed to view PDF files.

Technical Implementation Of Printing Quotes In Batch

The batch process that extracts quote information reads all quote routing records in a given run number that are marked with its batch control ID. For each quote routing record, it creates numerous records on a flat file. These records contain the information that is merged onto your quotes.

The base package example of this process ([QUOTROUT](#)) simply calls the extract algorithm on the routing record's route type to format the information placed onto the flat file. Refer to [Quote Route Types Control The Information On Quotes](#) for more information.

NOTE:

If your software doesn't support online quote display. The algorithm that formats quote extract records that's plugged in on [quote route type](#) serves two purposes: 1) it formats the records used to construct online images of a quote, and 2) it formats the records downloaded to your quote print software in batch. If your quote printing software does not support the rendering of quote images real time, there is no need to create an extract algorithm. Rather, you should simply develop your own download process that both formats the extract records and downloads them (and then specify this batch process on your quote route type).

Reproducing The Quote Print Flat File

You can reproduce the flat file at any time. Simply request the quote production background process and specify the run number associated with the historic run.

How To Reprint A Quote (For The Original Recipients or For Someone New)

A copy of a quote is sent to every individual / business specified in the [quote's routing details](#). The system creates the routing details when a quote is completed. Refer to [Completing A Quote Creates Quote Routings](#) for more information about how this information is compiled during quote completion.

If you want to reprint a quote OR if you want to send a quote to someone other than the original recipients:

- Navigate to the [Quote - Main](#) page.
- Transfer to the [Quote - Quote Routings](#) tab.
- Insert a new row (click the + button). Note that you can only insert information on a quote that is Complete.
- Specify the name and address to which the quote should be sent. If you want to send the quote to someone other than the original recipient, specify the individual's name and address.
- Save the quote.

If a quote is Complete but the print process hasn't yet executed, you may change the name and address on the original routing details; you don't have to insert a new routing row.

The Quote Extract Records

Numerous different types of records are interfaced to the document composition application. However, they all share a common structure:

- The first 4 bytes are called the **Printer Key**. This field is a record type used by the document composition application quote template.
- The next X bytes are called the **Sort Key**. This field is used to ensure the various records used to construct a printed quote appear in the correct order in the interface file.
- The next 12 bytes are called the **Mailing Key**. This field is used to control the order in which the formatted quotes are printed.
- The remaining bytes contain the **QuoteInformation** that appears on the printed quote. The type of information differs for each type of record.

The topics in this section describe each component.

Printer Key (Record Types)

The following table defines each printer key (i.e., record type) on the quote print flat file.

Record Type	Description	Notes
0010	Global extract information	Required. 1 per flat file
0100	Quote record	Required. 1 per Quote.
0200	Quote Detail record	1 per quote detail.

0300	Terms and Conditions record	1 per terms and conditions linked to the proposal SA.
0400	Bill segment record	1 per bill segment linked to the quote detail.
0500	Bill calculation header	1 per bill calculation header linked to the bill segment.
0600	Bill calculation line	1 per bill calculation line linked to the bill calculation header.
0700	End of record type 0500	1 for each bill calculation header
0800	Read detail	1 for each meter read detail linked to the bill segment.
0900	SQ detail	1 for each service quantity detail linked to the bill segment.
1000	End of record type 0400	1 for each bill segment.
1100	End of record type 0200	1 for each quote detail.
9999	End of record type 0100	1 for each quote.

Sort Key

The following table defines the structure of the sort key that appears on each quote print record. Please note that different components are filled in for each printer key.

Field Name	Format	Source/Value/Description
Quote ID	A12	
Sequence Number	N2	The sequence number of the account / person information associated with this quote routing information.
Quote record group	A2	10 Quote 20 Quote Detail 30 Quote end
Quote Detail ID	A12	
Quote Detail record group	A2	10 Quote Detail record 20 SA Terms and Conditions 30 Bill Segment 40 Quote Detail record end
SA T&C Short Description	A60	
Bill Segment End Date	A10	
Bill Segment Id	A12	
Bill Segment Group	A2	10 Bill segment 20 Bill segment calculation group 30 Bill segment read detail 40 Bill segment SQ detail

		50 Bill segment end
Bill Calc Header Sequence	N2	
Bill Calc Header Group	A2	10 Bill calculation header 20 Bill calculation line 30 Bill calculation end
Line Seq	N4	Defines order of rows for similar record types

Mailing Key

The following table defines the structure of the mailing key that appears on each quote print record.

Field Name	Format	Source/Value/Description
Postal code	A12	This is the postal code on the quote routing record.

Quote Information

The topics in this section describe the information that appears on each on each print record. The following links are provided so that you can move easily to specific topic within this section:

- [Global Extract Information \(0010\) Record Definition](#)
- [Quote \(0100\) Record Definition](#)
- [Quote Detail \(0200\) Record Definition](#)
- [SA Terms and Conditions \(0300\) Record Definition](#)
- [Bill Segment \(0400\) Record Definition](#)
- [Bill Calculation Header \(0500\) Record Definition](#)
- [Bill Calculation Line \(0600\) Record Definition](#)
- [End of Bill Calculation Header \(0700\) Record Definition](#)
- [Bill Segment Read \(0800\) Record Definition](#)
- [Bill Segment SQ \(0900\) Record Definition](#)
- [End of Bill Segment \(1000\) Record Definition](#)
- [End of Quote Detail \(1100\) Record Definition](#)
- [End of Quote \(9999\) Record Definition](#)
- [Address Sub-Record Definition](#)

Global Extract Information (0010) Record Definition

This is a "header" record that contains information about the extract run as a whole.

NOTE:

Please be aware that if you do not sort your extract file by **CIS Sort Key** after it is produced, this record will physically be the last record on the extract file.

Field Name	Format	Source/Value/Description
BATCH_CD	A8	Batch Control Code of the extract process.
BATCH_NBR	N10	Batch Number of the extract process
BATCH_RERUN_NBR	N10	Batch Rerun number of the extract process.
QTE_CNT	N10	Count of quotes on this extract.
EXTRACT_DTTM	A26	System time of extraction.
QUOTE_ID_START	A12	This is only used when a quote is produced as a result of an online request (from Quote - Main). It contains the Quote Id to extract.
QUOTE_ID_END	A12	This is only used when a quote is produced as a result of an online request (from Quote - Main). It contains the Quote Id to extract.
THREAD_NBR	N10	This field is only used if quotes are extracted in batch. It contains the thread number in which the quote was extracted.
THREAD_CNT	N10	This field is only used if quotes are extracted in batch. It contains the total number of threads that were extracted.

[Top of Page](#)

Quote (0100) Record Definition

Field Name	Format	Source/Value/Description
QUOTE_ID	A12	CI_QUOTE
ACCT_ID	A10	CI_QUOTE
EXPIRE_DTTM	A26	CI_QUOTE
QUOTE_STAT_FLG	A2	CI_QUOTE
CURRENCY_CD	A3	CI_ACCT
CUR_SYMBOL	A4	CI_CURRENCY_CD
ENTITY_NAME1	A64	CI_QUOTE_RTG. Mailing Entity Name1.
ENTITY_NAME2	A64	CI_QUOTE_RTG. Mailing Entity Name2.
ENTITY_NAME3	A64	CI_QUOTE_RTG. Mailing Entity Name3.
ADDRESS_SBR	A361	CI_QUOTE_RTG. Refer to its components in a later section.
EMAILID	A254	CI_QUOTE_RTG
PHONE-FAX	A64	CI_QUOTE_RTG

[Top of Page](#)

Quote Detail (0200) Record Definition

Field Name	Format	Source/Value/Description
------------	--------	--------------------------

QUOTE_DTL_ID	A12	CI_QUOTE_DTL
SA_ID	A10	CI_QUOTE_DTL
TOTAL_AMT	N13.2	CI_BSEG_CALC. Sum of all calculation amounts (quote detail's bill segments).
PREMISE_ID	A10	CI_SA (Characteristic Premise)
ADDRESS_SBR	A361	CI_PREM. Refer to its components in a later section.
SA_TYPE_DESCR	A60	CI_SA_TYPE_L
SVC_TYPE_CD	A30	CI_SVC_TYPE_L
SA_VERSION	N5	CI_QUOTE_DTL
QTE_DTL_SA_VERSION	N5	CI_QUOTE_DTL
RS_DESCR	A60	CI_RS_L. Description of Rate effective on SA start date.

[Top of Page](#)

SA Terms and Conditions (0300) Record Definition

Field Name	Format	Source/Value/Description
START_DT	A10	CI_SA_TC
END_DT	A10	CI_SA_TC
TC_TYPE_CD	A12	CI_TC
DESCR	A60	CI_TC_L
TC_TYPE_TXT	A2000	CI_TC_L

[Top of Page](#)

Bill Segment (0400) Record Definition

Field Name	Format	Source/Value/Description
START_DT	A10	CI_BSEG
END_DT	A10	CI_BSEG
BSEG_STAT_FLG	A2	CI_BSEG
BSEG_AMT	S13.2	CI_BSEG_CALC_LN

[Top of Page](#)

Bill Calculation Header (0500) Record Definition

Field Name	Format	Source/Value/Description
START_DT	A10	CI_BSEG_CALC
END_DT	A10	CI_BSEG_CALC
RS_CD	A8	CI_BSEG_CALC
CALC_AMT	S13.2	CI_BSEG_CALC
DESCR_ON_BILL	A254	CI_BSEG_CALC

[Top of Page](#)

Bill Calculation Line (0600) Record Definition

Field Name	Format	Source/Value/Description
APP_IN_SUMM_SW	A1	CI_BSEG_CALC_LN
CALC_AMT	S13.2	CI_BSEG_CALC_LN
EXEMPT_AMT	S13.2	CI_BSEG_CALC_LN
UOM_CD	A30	CI_BSEG_CALC_LN
TOU_CD	A30	CI_BSEG_CALC_LN
SQI_CD	A30	CI_BSEG_CALC_LN
BILL_SQ	S12.6	CI_BSEG_CALC_LN
DESCR_ON_BILL	A254	CI_BSEG_CALC_LN

[Top of Page](#)

End of Bill Calculation Header (0700) Record Definition

Field Name	Format	Source/Value/Description
Dummy field		

[Top of Page](#)

Bill Segment Read (0800) Record Definition

[Top of Page](#)

Bill Segment SQ (0900) Record Definition

Field Name	Format	Source/Value/Description
UOM_CD	A30	CI_BSEG_SQ
TOU_CD	A30	CI_BSEG_SQ
SQI_CD	A30	CI_BSEG_SQ
SQ_DEC_POS	N1	CI_BSEG_SQ
BILL_SQ	S12.6	CI_BSEG_SQ

[Top of Page](#)

End of Bill Segment (1000) Record Definition

Field Name	Format	Source/Value/Description
Dummy field		

[Top of Page](#)

End of Quote Detail (1100) Record Definition

Field Name	Format	Source/Value/Description
Dummy field		

[Top of Page](#)

End of Quote (9999) Record Definition

Field Name	Format	Source/Value/Description
Dummy field		

[Top of Page](#)

Address Sub-Record Definition

The address that appears in both the quote record (0100) and the quote detail record (0200) is composed of the following:

Field Name	Format	Description
COUNTRY	A3	
ADDRESS1	A64	Refer to Completing A Quote Creates Quote Routings for a description of conditions when this field will contain a fax number or an Email address rather than the first line of a postal address (this only occurs for a bill record (0100)).
ADDRESS2	A64	
ADDRESS3	A64	
ADDRESS4	A64	
CITY	A30	
NUM1	A6	
NUM2	A4	
HOUSE_TYPE	A2	
COUNTY	A30	
STATE	A6	
POSTAL	A12	
GEO_CODE	A11	
IN_CITY_LIMIT	A1	

[Top of Page](#)

Maintaining Quotes

A quote allows you to show a customer how their bill segments will look if a given set of pricing terms is applied to a given amount of consumption. If the customer accepts the quote, real service agreements are created.

FASTPATH:

Refer to [The Big Picture Of Quotations](#) for background information about quotes.

The topics in this section describe how to maintain quotes.

The Lifecycle Of A Quote And Quote Detail

The topics in this section describe the lifecycle of the various quote objects.

Quote Lifecycle

The following diagram shows the possible lifecycle of a quote.

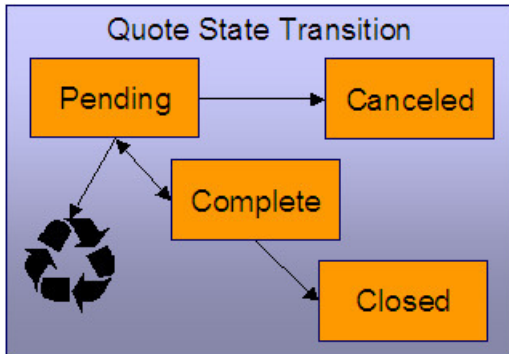

Pending A quote starts its life in the Pending state. Refer to [Creating Quotes And Quote Details](#) for more information.

A quote remains Pending until you Cancel or Complete it.

You may delete a Pending quote. Deleting a pending quote also deletes its quote details.

Canceled You cancel a quote if you want a record of a Pending quote that was never sent to a customer.

Complete A quote becomes Complete when it is ready to be sent to a customer. No changes may be made to a Complete quote. Refer to [Completing A Quote](#) for a description of what happens when a quote is completed.

A Complete quote may be reopened. You would only do this if you need to prevent blatant errors from being sent to the customer. For example, if you notice an incorrect quote detail, you could reopen the quote, regenerate or delete the erroneous quote details, and then recomplete the quote.

Closed A Complete quote becomes Closed when its terms are no longer valid. Refer to [Closing Quotes](#) for more information.

Quote Detail Lifecycle

The following diagram shows the possible lifecycle of a quote detail.

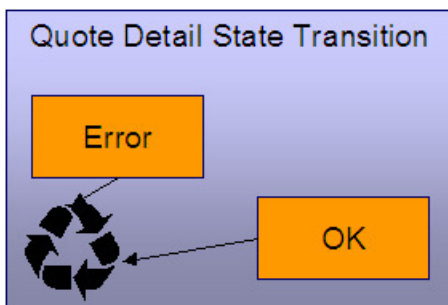

When a quote detail is generated, it is placed in the Error or Ok state depending on whether the system successfully generated simulated bill segments for each billing scenario linked to the related proposal SA. A quote detail may be deleted if its parent quote is Pending. Refer to [Creating Quotes And Quote Details](#) for more information.

Quote - Main

This page is used to maintain quotes. This page provides many diverse functions:

- You can [generate](#), [complete](#), [close](#), reopen, and cancel a quote.
- You can regenerate and delete quote details.
- You can [accept](#), [decline](#) and cancel the proposal SAs that contribute a quote detail to the quote.

You should not attempt to use this transaction until you are comfortable with the concepts described under [The Big Picture of Quotations](#).

Open this page using **Menu > Sales & Marketing > Quote > Search**.

Description of Page

Quote Info contains a concatenation of important information about the quote (e.g., its expiration date and status). **Quote ID** is the system-assigned unique identifier of the quote. These values only appear after the quote is added to the database.

Account ID identifies the customer or prospect associated with the quote. The name of the account's main customer appears adjacent.

Quote Status contains the state of the quote. Refer to [Quote Lifecycle](#) for information about the valid values and the state transition rules.

If your system has been configured to display an online image of a quote, a **Display Quote** button appears adjacent to the quote's status. When clicked, an online image of the quote is displayed. Refer to [Technical Implementation Of Online Quote Production](#) for how to enable this feature.

Expiration Date / Time identifies when the quote's terms are no longer valid. Refer to [Closing Quotes](#) for how the system uses this information to automatically close a quote.

Refer to [Quote Actions](#) for a description of each **Quote Action** button.

This transaction has sophisticated logic that can be used to perform mass updates to the quote's quote details and their related proposal SAs. These mass update actions are executed by selecting quoted details (in the grid) and then clicking the desired action button at the bottom the page. The remainder of this section describes how to use this mass update functionality.

The **Select All / Clear All** buttons are used to select / unselect the quote details. These buttons are disabled when the quote is Closed.

NOTE:

100 quote details at a time. Clicking **Select All** selects the first 100 quote details in the grid. If more than 100 quote details exist, you must select them in batches.

The grid that follows contains the quote details linked to the quote. The following information appears in the grid:

- **Select box.** Before you can perform any of the mass update actions at the bottom of the page, at least one quote detail must be selected. This field is disabled when the quote is Closed. You can use the **Select All** and **Clear All** buttons to change the value of the switch for all quote details in the grid.
- **Click the go to button** to transfer to the [Quote - Quote Detail](#) tab with the corresponding quote detail positioned in the scroll. On this page, you can see the details of the quote detail's simulated bill segments (and, from there, drill down into the details of each bill segment).

- The **Quote Detail Info** column contains a concatenation of a quote detail's division, SA type, start option, status, start date, and premise information (this information comes from the quote detail's proposal SA).
- The **Total Amount** column contains the sum of the quote detail's simulated bill segments.
- The **Remarks** column highlights special circumstances associated with the quote detail.
 - Proposal SA has been changed since the quote was created appears if the proposal SA was modified after the quote detail was generated. If you'd like to recalculate this quote detail, select this row and click the **Regenerate** button at the bottom of the page to regenerate the quote detail's simulated bill segments.
 - Quote detail contains bill segments in error appears if any of the simulated bill segments linked to the quote detail are in error . Click the adjacent go to button to transfer to the [Quote - Quote Detail](#) tab where the state of each simulated bill segment is shown. You can correct simulated bill segments that are in error by **Regenerating** the quote detail (and you do this by selecting the quote detail and clicking the Regenerate button at the bottom of the page).

The **Quote Detail Actions** and **Proposal SA Actions** can be used to perform mass updates to the selected quote details in the grid. Refer to [Quote Detail Actions](#) and [Proposal SA Actions](#) for the details.

Action Buttons On Quote Main

The topics in this section describe the various action buttons on the [Quote - Main](#) page.

Quote Actions

The topics in this section describe the **Quote Action** buttons on the [Quote - Main](#) page. The following links are provided so that you can move easily to specific topic within this section:

- [Generate](#)
- [Complete](#)
- [Close](#)
- [Reopen](#)
- [Cancel \(Quote\)](#)

Generate

The **Generate** button causes one or more quote details to be created for the account's Quotable proposal SAs. This button is enabled when there is at least one Quotable proposal SA linked to the selected **Account ID**.

When clicked, the **Generate Quote** window opens.

You must specify the following parameters to generate quote details:

- Indicate if quote details should be created for All Proposal SAs or for a Specific Proposal SA.
- If you indicated a quote detail should be generated for a Specific Proposal SA, also specify the **Proposal SA ID**.

After specifying the parameters, click **Generate** to create the quote details for quotable proposal SAs.

FASTPATH:

Refer to [Creating Quotes And Quote Details](#) for more information.

WARNING:

If the quote has existing quote details for the designated proposal SAs, they are deleted when you generate quote details (i.e., the system regenerates existing quote details). You can also regenerate quote details by selecting them on the Main page and clicking the **Regenerate** button.

[Top of Page](#)

Complete

The **Complete** button causes the quote to become complete. This button is enabled when the quote is pending and all quote details linked to the quote are OK.

FASTPATH:

Refer to [Completing A Quote Creates Quote Routings](#) for a description of what happens during quote completion.

[Top of Page](#)

Close

A quote is closed when its terms are no longer valid (i.e., when the related proposal SAs can no longer be accepted). Most quotes are closed automatically by the system (refer to [Closing Quotes](#) for how this takes place).

If you want to close a quote real time, click the **Close** button. When this button is clicked, the system opens the **Close Quote** window and asks if anything should be done with the related proposal SAs.

In the resulting window, you must specify one of the following **Proposal SA Actions**:

- Choose No Action if you don't want to change the status of the related proposal SAs.
- Choose Decline if you want the status of the proposal SAs that have contributed quote details to the quote to be changed to declined . You must also define a **Decline Reason**.
- Choose Cancel if you want the status of the proposal SAs that have contributed quote details to the quote to be changed to canceled .

[Top of Page](#)

Reopen

The **Reopen** button causes a quote to return to the pending state. You would only reopen a quote if you need to prevent blatant errors from being sent to the customer. For example, if you notice an incorrect quote detail, you could reopen the quote, regenerate or delete the erroneous quote detail, and then recomplete the quote.

This button is enabled if the quote is complete.

[Top of Page](#)

Cancel (Quote)

The **Cancel** button causes the quote to become canceled. You would cancel a quote if you want a record of a pending quote that was never sent to a customer. This button is enabled when the quote is pending.

Canceling the quote does NOT cancel the related proposal SAs. If you want to cancel the related proposal SAs, you have the following options:

- You can click the [Close](#) button rather than the **Cancel** button. When you close a quote, you are given the option of also canceling the proposal SAs that contributed a quote detail to the quote.
- Before canceling the quote, you can select the quote details and click the [Cancel](#) button at the bottom of the page (in the Proposal SA Actions section). When you click this button, the system cancels the proposal SAs linked to the quote details.
- You can transfer to the [Quote - Quote Details](#) tab and then drill down to the each proposal SA (using the SA context menu button). This transfers you to [Service Agreement - Main](#) where you can cancel the proposal SA.

Quote Detail Actions

The topics in this section describe the **Quote Detail Action** buttons on the [Quote - Main](#) page. These buttons are used to perform a given action to the quote details that are selected in the quote details grid.

- The **Regenerate** button is used to delete and recreate the selected quote details. This button is enabled if the quote is pending and at least one row in the quote details grid is selected.
- The **Delete** button is used to delete the selected quote details. This button is enabled if the quote is pending and at least one row in the quote details grid is selected.

Proposal SA Actions

The topics in this section describe the various **Proposal SA Action** buttons on the [Quote - Main](#) page. These buttons are used to perform a given action to the proposal SAs associated with the selected quote details.

The **Accept** button is used to accept the proposal SA associated with the quote detail. This button is enabled if the quote is pending or complete and at least one row in the quote details grid is selected.

When you accept a proposal SA, you are asked to supply the **Start Date** of the real service agreement that will be created.

Refer to [Accepting / Declining Quote Details](#) for more information about how accepting a quote detail causes a real service agreement to be created.

Decline

The **Decline** button is used to decline the proposal SA associated with the quote detail. This button is enabled if the quote is pending or complete and at least one row in the quote details grid is selected. When you decline a proposal SA, you are asked to supply a **Decline Reason**.

Refer to [Accepting / Declining Quote Details](#) for more information about declining a quote detail.

Cancel

The **Cancel** button is used to cancel the proposal SA associated with the quote detail. This button is enabled if the quote is pending or complete and at least one row in the quote details grid is selected.

Quote - Quote Details

This page is used to view a summary of the simulated bill segments linked to a quote detail.

Open this page using **Menu > Sales & Marketing > Quote > Search** and navigate to the **Quote Details** page to define this information. You can also display a quote detail by clicking the respective go to button in the quote details grid on the main tab.

Description of Page

Quote Info contains a concatenation of important information about the quote (e.g., its expiration date and status). **Quote ID** is the system-assigned unique identifier of the quote. These values only appear after the quote is added to the database.

The **Quote Details** scroll contains one entry for every quote detail linked to the quote (a summary of these quote details also appears on the Main tab). The remainder of this section describes the information displayed for each quote detail.

NOTE:

You don't have to use the scroll. If the quote has many quote details, you don't have to use the scroll to work through them. Rather, you can use the go to button in the quote details grid on the main tab to position the respective quote

detail in the following scroll. Also note, you can use Alt - and Alt + to scroll to the next and previous quote details in the scroll.

You cannot maintain quote details on this page. All maintenance functions (generate, delete, accept, decline and cancel) are performed on the **Main** tab.

Premise Info is the address of the main premise associated with the service agreement (as defined on the service agreement's characteristic premise). It's important to note that the service agreement may cover service at multiple premises, but only one may be defined as the main premise.

Quote Detail ID is the system-assigned unique identifier of the quote detail.

SA Info is a concatenation of the proposal SA's division, SA type, start option (if any), status and start date.

SA Version is a snapshot of the proposal SA's version number at the time the quote detail was generated. This information is used by the system to detect if the proposal SA was modified after the quote detail was created.

Total Amount is the sum of the quote detail's simulated bill segments.

Create Date / Time is the date and time the quote detail was generated.

Remarks highlight special circumstances associated with the quote detail. Please see the description of this field on the main tab for more information.

The grid contains a row for each simulated bill segment linked to the quote detail. The following information appears in the grid:

- The first go to button transfers you to the [bill segment page](#) where the details of the simulated bill segment are shown.
- **Bill Segment Period** defines the start and end dates of the simulated bill segment.
- **Amount** contains the amount of the bill segment.
- **Remarks** highlight special circumstances associated with the bill segment.
- **Billing Scenario ID** allows you to go to the proposal [SA's billing scenario](#) where you can tinker with consumption and the bill segment period used to generate this bill segment. Refer to [Proposal SAs Contain Billing Scenarios](#) for more information.

Quote - Quote Routings

This page is used to view the recipients of a quote. Refer to [Printing Quotes](#) for a discussion of how this information is used to produce quote images.

This page is also used to request a new copy of a quote.

NOTE:

No routing information until completion. A quote has no routing information until it is complete. At [completion time](#), the system creates a routing detail for every person linked to the account that receives a copy of its quotes. Refer to [Printing Quotes](#) for more information about how this information is constructed.

Use **Menu > Sales & Marketing > Quote > Search** and navigate to the **Quote Routings** page.

Description of Page

Quote Info contains a concatenation of important information about the quote (e.g., its expiration date and status). **Quote ID** is the system-assigned unique identifier of the quote. These values only appear after the quote is added to the database.

The **Quote Routing Information** scroll contains an entry for each recipient of the quote. This information is disabled after the quote has been routed to the recipient. The remainder of this discussion describes the fields that can be defined for each recipient of the quote.

Person ID identifies the person who was originally associated with the routing record. You may change the **Person ID** to any person in the system as this information is only used to default the recipient's name and address information, below.

The **Quote Routing Parameters** area contains information explaining how and when the quote is routed to the recipient. This information is gray when the quote routing information has been extracted or if a quote is reopened:

- **Quote Route Type** is the method used to transmit the quote to the customer. This information defaults from [Account - Person Information](#).
- **Batch Control** is the identifier of the batch of quotes in which the recipient's copy was downloaded. Embedded in this identifier is the batch control ID and the batch number. Note, this batch process is defined on the Quote Route Type or CIS Division.
- **Sequence** is the system-assigned identifier assigned to this quote routing.
- Turn on **Do Not Extract** if the quote should not be routed to the individual for whatever reason.
- **Reprint** is checked if an operator created this routing. This switch is populated by the system and is always protected.
- **Extract Date/Time** is the date and time the quote was downloaded. This information only appears after the download has commenced.

The **Mailing Address Information** area contains the recipient's name and address.

- If the recipient has an [override mailing name](#), **Name1**, **Name2** and **Name3** contain the person's override mailing name. Otherwise, **Name1** contains the recipient's primary name (this name might also include a prefix or suffix if the related [Account - Person](#) relationship has these fields defined).
- The remaining fields are the recipient's address. Refer to [Completing A Quote Creates Quote Routings \(And More\)](#) for information about how the system constructs the recipient's address
- If the recipient's address is a mailing address (as opposed to fax or email), the **Country** associated with the address controls the fields that appear in the address. Refer to [Defining Countries](#) for more information on the address constituents.
- If a user manually adds a routing record, the mailing address information defaults from the information on the current routing record.
- If a user specifies a **Person ID** that is linked to the quote's account, the **Quote Route Type** defined for this person on the account is defaulted.
- If a user specifies a **Person ID** that is not linked to the quote's account, the **Quote Route Type** on the [installation record](#) is defaulted. Note, if the quote route indicates the quote is routed via the postal service, the system will only be able to default the person's address if the person has an override mailing address on their [correspondence information](#).
- If the user changes the **Quote Route Type** after the initial default, the system populates the address information as described above.

Service Credits

"Service credits" is a term used to describe a special program designed to reward a customer for service along with benefits related to such a program. For each program that a customer participates in, there is a service credit membership record. Service credit events are used to record the "points" earned and redeemed for the membership. The topics in this section provide further details related to the service credit functionality.

FASTPATH:

For information about designing and setting up your control tables for configuring service credit functionality, refer to [Designing Your Service Credit Options](#).

NOTE:

Service credits are optional. Service credits may not be set up in your system; they are only used if your company offers rewards programs to customers.

Penalty Points. The service credits functionality is described in the documentation with the assumption that it is used for accumulating points to reward your customers. However, if your company has a business need to record penalty points for a customer, the service credits functionality may be used for that purpose as well.

The Big Picture Of Service Credit Membership

If a customer is participating in a rewards program, the customer has a service credit membership. The topics in this section provide background information about a variety of service credit membership features and functions.

Who are the Members?

Each membership has one or more "members". The members are defined by the accounts linked to the membership and by the financially responsible person(s) linked to each account.

A typical membership is linked to only one account. However, in some cases more than one account is linked to the membership. For example, a customer may have one account for residential service and one for commercial service, but both accounts are part of the same membership. In this example, one person with multiple accounts is linked to the membership, so there is only one member.

For each account linked to the membership, the service related to the account may be used to calculate the accumulated credits for the membership. Refer to [How Are Service Credits Earned?](#) for more information.

NOTE:

An account may not be linked to more than one membership of the SAME membership type at a given point in time. In other words, an account may not have two United Airlines frequent flier memberships (otherwise, the account would accumulate double miles). However, an account may be linked to more than one membership if they are of different membership types. For example, an account may have a capital credits membership and a United Airlines frequent flier membership.

When you find a customer's record on [Control Central - Main](#), you are transferred to the [Account Information](#) portal. One of the zones on this page contains information about memberships for the customer.

NOTE:

Portal Preferences. The service credit membership zone only appears if you have modified your preferences to display this zone. Refer to [Portal Preferences](#) for more information.

Joint Membership

It is possible for more than one person to belong to the same membership. These persons may be linked to the same account or to different accounts. A typical scenario would be a married couple that shares in a membership. This is considered a "joint" membership.

The number of "members" for a membership is mainly for information purposes and typically has no bearing on the service credit amounts calculated for the membership. There may be legal restrictions or business practice restrictions controlling how you may set up your members. For example:

- In an airline's frequent flier program, a separate frequent flier account would exist for each customer. It is possible for you to create a frequent flier membership with more than one "member", but for the system, the important information is the external frequent flier miles number linked to the membership. The customer linked to this number accumulates the miles. For this case, your business practice may be that the person with the frequent flier account must be the only financially responsible person.
- For a capital credits membership, you may be required to distinguish between "single" memberships and "joint" memberships. If a single person gets married and would like the spouse to be added as a member, your practice may be to expire the single membership and to create a new "joint" membership to include both spouses.

NOTE:

Co-op Members. Do not confuse the "members" of a co-op with the members linked to a service credit membership. At a cooperative, most customers are considered "members" of the co-op. However, in the system, separate membership records are created for each single or joint membership.

Changing the Membership Accounts

The link between the accounts and the membership is NOT effective dated. This means that if the list of accounts for a membership changes, you need to stop the membership and start a new one with the new list of accounts.

NOTE:

Stopping Memberships. Stopping a membership does not necessarily prevent new service credits from accumulating. Refer to [Stopping a Membership vs. Inactivating a Membership](#) for more information.

Membership Application

Your business practice may dictate that the customer complete an enrollment form. Depending on your practice, the form may need to be received prior to starting membership or it may simply be a mechanism to gather supplemental information once the membership has begun.

Either way, you may consider setting up the system to handle forms as follows:

- Design your membership type to include a creation algorithm that generates a letter when the membership is created. The letter template could include the form to be filled out.
- Create the new membership in pending status. The letter and form are sent to the customer and the pending status indicates that you are waiting for the completed form. Refer to the [Lifecycle of a Membership](#) for more information.
- When the paperwork is received, change the status of the membership to active.

NOTE:

Membership Events for Pending Memberships. The system allows events to be created for pending memberships assuming that paperwork is supplemental information that should not prevent service credits from accumulating. If your business practice dictates that the paperwork must be received prior to accumulating service credits, the algorithm or background process that creates events for memberships of this type should be coded to only create events for active memberships. Refer to [How Events Are Created](#) for more information.

Creation of a Membership

Memberships may be created using the [membership](#) page when a customer has signed up for a special program. In addition, it may be your business practice to automatically create a membership under certain circumstances when a customer has signed up for service.

For example, if you are a co-op, perhaps every new customer is automatically enrolled in a capital credits membership. Or perhaps signing up for cable service automatically entitles your customers to membership in the free pay-per-view movies program. For these cases, the recommendation is to use the [order](#) page to start service for your customer and to use questions and miscellaneous fields to record information needed to set up the new membership correctly. Refer to [Using Campaigns & Packages to Create a Membership](#).

Membership Fees

Some memberships may require a fee to be paid by the customer when joining. The behavior of this fee may differ depending on whether it is refundable or not.

- If the fee is nonrefundable, you create an SA with a simple adjustment or a one time billable charge to levy the fee. Refer to [Defining Control Tables for a Nonrefundable Fee](#).
- If the fee is refundable, in addition to defining the SA to hold the fee, you need to put code in place to initiate the refund. Refer to [Setting Up a Refundable Fee](#) for more information.

Stopping a Membership vs. Inactivating a Membership

You may stop a membership by entering an end date for the membership. However, depending on how events are created for your membership, stopping the membership may not prevent new events from being created. For example:

- If you stop a frequent flier membership on May 15th and a bill is subsequently created for the period May 1st through June 1st, your business rules may dictate that frequent flier miles should be accumulated for this bill because the membership was active for part of the period covered by the bill.
- For a capital credits membership, capital credit allocations are calculated for the prior year. If a membership stopped in the middle of the previous year, the membership should still get capital credits for the part of the year that the membership was still in effect.
- Capital credit retirements are calculated based on capital credit allocations accumulated in the past. If a membership has been expired, the members are still eligible for retirement amounts for the accumulated capital credit allocations. These retirements may continue for many years after a membership is stopped.

NOTE:

Membership Status. For all the above scenarios, the system assumes that the status of the membership remains active.

You may have some circumstances where you do not want new events to accumulate after a membership is stopped. To prevent new events from being created, you must change the status of the membership to inactive.

If a customer moves away or otherwise stops service with your company, your business rules dictate whether or not the membership should be stopped or changed to inactive. The following issues must be considered:

- Will service credit events still get created for these memberships? If so, is that acceptable?

- For frequent flier memberships, the miles are calculated based on new bill amounts for the membership's service agreements. If the SAs that contribute to the membership are expired, no new bills are generated so no new miles are accumulated.
- For capital credits, after a customer moves away, the capital credit allocation for the final year of the customer's service may still need to be calculated. In addition, this customer is eligible for the capital credit retirement amounts, even though they are no longer a customer.
- What happens if the customer returns to your company and signs on for service again? Assuming that the same account number is used, is it ok for the membership to be automatically reinstated? Or should the customer reapply? If the customer should reapply, you may consider updating the membership with a stop date when the customer originally stopped service.

NOTE:

There is nothing in the system logic that automatically updates the membership stop date or the status when service agreements that contribute to the membership are stopped.

The Big Picture of SC Events

The service credit events record the accumulation and redemption of awards earned by the membership. The topics in this section provide background information about a variety of service credit event features and functions.

NOTE:

Events. For convenience, this document often refers to service credit events simply as "events".

Event Amounts May Contribute to a Balance

The event amount may be positive or negative, based on whether the event is accumulating points earned for the membership or redeeming points for the membership. For some types of memberships, these credit and debit amounts should be added together to produce the overall balance for the membership.

For some types of memberships, a balance is not applicable. This is true for memberships where the redemption of the points does not occur within the system. For example, if the membership accumulates frequent flier miles on behalf of an airline, the customer redeems the earned miles with the airline, not with your company. As a result, there is no need to calculate a balance for the membership.

If you want the system to calculate a balance, you must set a switch on the [membership type](#) page. For memberships that calculate a balance, the balance may be viewed on the membership page.

Events May Indicate a Fiscal Year

For some types of memberships, the amount of each event is associated with a specific fiscal year. This is true for capital credit memberships where capital credit allocations are calculated for a fiscal year. When the capital credits are redeemed (also called retired), the retirement events must also indicate a fiscal year. Because all events for this type of membership are related to a fiscal year, the system can calculate the balance for the events by fiscal year.

If you want the system to require a fiscal year for every event in the membership, you must set a switch on the [membership type](#) page. For memberships that calculate a balance and indicate a fiscal year, the balance for each fiscal year may be viewed on the membership page.

Events May Indicate a Subcategory

For some types of memberships, the amount of each event is further grouped by a subcategory. This is common for capital credit memberships where multiple capital credit allocations are calculated. For example, each year, you may calculate allocations for generation and for transmission. Events for memberships of this type must indicate a subcategory.

Cooperatives that allocate capital credits for more than one subcategory, typically want to view the balance of the events over time broken down into these subcategories. When the capital credits are redeemed or retired, the retirement events must also indicate a subcategory. Because all events for this type of membership are related to a subcategory, the system can calculate the balance for the events by subcategory.

NOTE:

Partial Retirement. For some cooperatives, it is common that certain capital credit allocations are never retired. Refer to [Partial Retirement](#) for more information.

If you want the system to require a subcategory for every event in the membership, you must define the valid subcategories on the [membership type](#) page. For memberships that calculate a balance and indicate a subcategory, the balance for each subcategory may be viewed on the membership page.

NOTE:

Calculating Subcategory Balances. If events for your membership indicate a subcategory and fiscal year, balances for the membership are calculated for both groupings.

An Event May Cause Other Actions to Occur

When an event is generated, there are often other actions that need to take place. For example:

- If an event is created that allocates points for the customer, you may want to generate a temporary message on the customer's next bill.
- If a capital credit allocation event is created, the general ledger is affected so an adjustment must be created to post to the general ledger. Refer to [Financial Transactions for an Event](#) for more information.
- If an event is created to add frequent flier miles, the event must be marked for extraction so that the information is sent to the appropriate airline. Refer to [Interface Membership Information to a Third Party](#) for more information.
- If an event to retire capital credits is created, the customer's balance is affected so an adjustment must be created to transfer the capital credit to the members' service agreements. Refer to [Financial Transactions for an Event](#) for more information.

The system relies on algorithms linked to the event type to perform the actions described above and any other action that may be required by your business.

FASTPATH:

Refer to [Service Credit Event Types](#) for more information about the algorithms provided with the base product.

NOTE:

Event Cancellation Algorithms. The event type also defines algorithms to be executed when an event is canceled.

Financial Transactions for an Event

An event may be related to financial transactions. There are two types of financial transactions that may be linked to the event:

- Financial transactions that contributed to the event. These are bills, payments or adjustments that caused the event to be created. For example, if you generate an event for frequent flier miles as a result of some amount billed for the customer, the bill segments associated with the billed amount are linked to the event. The FTs are linked to the event for audit purposes.
- Financial transactions that are created by the event. In [an event may cause other actions to occur](#), we saw examples where an event completion algorithm may cause adjustments to be created. The FT ID for these adjustments is linked to the event as audit.

NOTE:

Automatically Canceling Event Financial Transaction. The created by financial transactions may get canceled if the event is canceled AND you have plugged in an appropriate [Event Cancellation Algorithm](#).

For financial transactions that are created by the event, the system must post the financial transactions to one or more appropriate service agreements. The service agreement to use depends on your business rules. For example:

- If the event affects the balance of accounts linked to the membership, the event completion algorithm may create adjustments for [service agreements that contribute to the membership](#).
- If the event affects the general ledger and does not affect any balance for the account, the event completion algorithm simply needs a service agreement to use for the resulting adjustment. Rather than arbitrarily picking any service agreement in this case, a special [miscellaneous service agreement](#) should be linked directly to the membership for such adjustments.

How Events Are Created

Although a user may create an event manually on the [service credit event](#) page, most events are created automatically by an algorithm or by a background process. The following topics further describe these options.

Events Created by an Algorithm

You would design an algorithm to create your events if the event should be triggered by an occurrence in the system, such as starting service or generating a bill. For example, perhaps every time you are billed for electric and/or gas service, the system adds one frequent flier mile for every \$10 spent on service. Refer to [How Are Service Credits Earned?](#) for more information.

The base product provides a bill completion algorithm to create an event as a result of the amount billed for service agreements linked to the membership. Refer to CBCM-SC for more information.

Events Created as a Result of a Background Process

You would use a background process to create the event if the calculation is done periodically or on an ad-hoc basis and does not get triggered by something occurring in the system. For example, the capital credit allocation and retirement processes are typically run once a year, when the business has determined that they are ready to calculate these amounts.

FASTPATH:

Refer to [Allocating Capital Credits](#) and [Capital Credit Retirement](#) for more information.

Creating Pending Events

Events may be created in pending or complete status. Only complete events cause the completion event algorithms to run and [cause other actions to occur](#). You may use the status of pending if you want to review the calculated amount prior to completing the event.

For example, when a cooperative runs the background process to [allocate capital credits](#), it may create the new events in the pending status. This allows the co-op to review the total amount of capital credits calculated for all members. If this total is in line with the co-op's expectations, they run the background process again creating the new events in complete status. Only at this point do the completion event algorithms run.

Events May Be Transferred

In some situations, you may want to transfer service credit events from one membership to another on the [service credit event](#) page. For example, if a member dies, you may decide to transfer earned service credits to the membership for a beneficiary. When transferring a service credit:

- The target membership must be of the same membership type as the original membership.
- The original service credit event is canceled and any event cancellation algorithms linked to the [SC event type](#) are executed.
- A new service credit event is created and completed and any event completion algorithms linked to the [SC event type](#) are executed.
- The new service credit event references the original event ID in the **Transferred From** event field.

NOTE:

Contributed to FTs linked to the original event are not transferred to the new event. If you have created by FTs linked to the original event, the recommendation is to ensure that an event cancellation algorithm cancels this FT and that an event completion algorithm for the new event creates an appropriate new FT for the new membership.

CPCRALOC - Allocating Capital Credits

The base product provides a background process (CPCRALOC) that allocates capital credits to members of a cooperative. The result of this process is the creation of new service credit events for capital credit memberships. This background process is typically run after the profits for the previous year are calculated. During that time, this job could be run a number of times for any of the following reasons:

- At the beginning of the allocation process, you may know the total amount to allocate to all members; however, you may estimate the allocation factor that determines the individual amounts that get distributed to the members. You may need to change your estimate and rerun the process until all the individual allocations add up to the desired total amount. To run the job with the estimated allocation factors, indicate that you want events created as pending. When you confirm the correct allocation factor, a final run should be executed with an indication that the events should be created as complete.

Every time the process runs, it will first remove any pending events for the same input event type, subcategory and fiscal year. Refer to [Creating Pending Events](#) for more information.

- If the cooperative has more than one subcategory, the process must be run for each subcategory. In fact, the above trial-and-error process may need to be followed for each subcategory.

You must provide the [service credit event type](#) to use for the new events. This process determines the membership type related to the event type. The process then finds all pending and active memberships for this membership type. To calculate the capital credit allocation, the system finds all applicable bill segments for each [service agreement that contributes to the membership](#).

Capital credit allocations are calculated for a specific [fiscal year](#). The fiscal year is input to the background process and is stamped on any new events created by the process. The system also uses the fiscal year to determine the applicable bill segments for the membership's SAs. It uses the bill segment's accounting date and the [accounting calendar](#) to determine the fiscal year for each bill segment.

NOTE:

Canceled Bill Segments. Any bill segments that were canceled in the fiscal year are included as well.

Accounting Calendar. This process assumes that only one accounting calendar exists for the company. This is the case for companies that operate in a single jurisdiction, which is true for cooperatives.

Allocation Period. If the membership was only effective for part of the fiscal year, the allocations are only calculated for the period of time that the membership was in effect.

For each applicable bill segment, the system determines the SQ total and the total sales amount for each segment. To calculate the totals correctly, a characteristic type and value to identify SQ bill lines must be provided to the background process and a characteristic type and value to identify bill lines contributing to the total sales amount must be provided to the background process.

FASTPATH:

Refer to [Identifying SQ and Sales Information for Historical Bill Segments](#) for more information.

If your membership type indicates subcategories to be used for the events, you must provide a subcategory as input. If you have multiple subcategories for your membership, this process must be run once for each subcategory.

The calculation of the capital credit allocation amount typically uses an allocation factor. This factor is often different for each subcategory. You will probably define a different bill factor for each subcategory and use the appropriate bill factor when submitting the process for each subcategory.

This process also assumes that the allocation factor differs by the customer's revenue class. It assumes that the bill factor's characteristic type is revenue class. Refer to [Designing Bill Factors for Credit Allocation](#) for more information. For each service agreement linked to the membership, the appropriate allocation factor is determined based on the revenue class for the SA type.

Capital credits for the input subcategory are calculated as follows:

Fiscal year sales amount - (fiscal year SQ amount * revenue class allocation factor) = Allocation Amount

The calculated amount is compared against a minimum amount, input to the background process. If the calculated amount is less than the minimum, no event is stored for this amount.

After determining the amount, a new service credit event is created for the membership. The event is stamped with the input subcategory, service credit event type and fiscal year.

The FTs for all the bill segments used to determine the allocation amount are linked to the event as contributed to FTs. Refer to [Financial Transactions for an Event](#) for more information.

NOTE:

Rerunnable Process. This process is restartable and rerunnable. When running the process, for each membership the system checks whether there is already a complete event for the input service credit event type, subcategory and fiscal year. If so, it does not create a new event.

FASTPATH:

Refer to CPCRALOC for more information.

CPCRRETR - Capital Credit Retirement

NOTE:

Calculation Method. There are various calculations that different cooperatives may use when determining the amount to retire. The base product has provided one calculation method.

This background process is run when a cooperative is ready to pay out allocated capital credits to its members. This process is referred to as retirement. The result of this process is the creation of new service credit events for capital credit memberships. Capital credits are paid as the cooperative's financial position permits. During that time, this job could be run a number of times for any of the following reasons:

- You may choose to run the process and [create pending events](#) to review the results prior to finalizing the retirement. When you are happy with the results, a final run should be executed with an indication that the events should be created as complete. Every time the process runs, it will first remove any pending events for the same input event type and subcategory.
 - If the cooperative has more than one subcategory, the process may be run separately for each subcategory. You may also run the process with no subcategory indicated and then all subcategories are processed.
-

NOTE:

Partial Retirement. For some cooperatives there may be capital credits for some allocated amounts that are never retired. If that is the case, simply run this process for each subcategory whose amounts do get retired.

You must provide the [service credit event type](#) to use for the new events. This process determines the membership type related to the event type. The process then finds all pending and active memberships for this membership type.

This process receives a percentage to retire as input. It determines the current balance of all completed events for the subcategory. The retirement amount for the subcategory is calculated as the current balance * input percentage to retire. The process then determines the outstanding balance for each subcategory and fiscal year combination. For every combination that still has a balance, the process creates events to relieve the outstanding balance for the oldest fiscal year first. It creates events for subsequent fiscal years until the full retirement amount is used.

In order for the process to be rerunnable and restartable, a Control ID is used to mark retirement events that are created by the process. The Control ID is input to the routine and is determined by the user. When the process runs, it determines whether an event already exists for the subcategory / Control ID combination. If so, new events are not created for that subcategory. If you run the process multiple times for the reasons described above, you should use the same Control ID each time. This way the system knows that the process is being run again for the same retirement calculation.

FASTPATH:

Refer to CPCRRETR for more information.

Maintaining Service Credit Memberships and Their Events

The topics in this section describe how to maintain a service credit membership and its events.

FASTPATH:

Refer to [The Big Picture Of Service Credits](#) for background information about service credits.

Service Credit Membership

The topics in this section describe how to maintain service credit memberships. Refer to [The Big Picture Of Service Credit Membership](#) for background information about memberships.

Lifecycle of a Membership

The following diagram shows the possible lifecycle of a service credit membership.

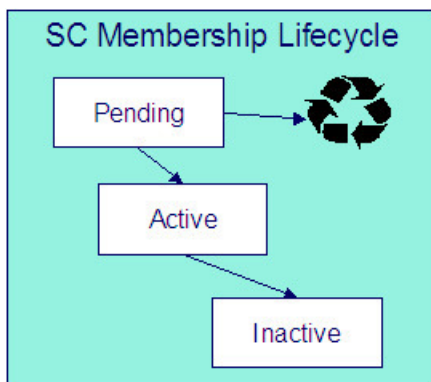

Pending A service credit membership may start out in the Pending state. A membership is typically created in this state if the creation of the membership requires approval or any manual step (e.g. waiting for paperwork) that needs to be completed prior to activation.

NOTE:

Events for Pending Memberships. Service credit events may still be created for membership records in the Pending state.

Active A service credit membership is in the Active state when a customer is actively participating in a service credit membership. A membership may be created in the Active state or it may transition to the Active state from Pending when all the necessary approval or paperwork is complete.

NOTE:

Manual Activation Only. There is no system functionality that automatically changes the status of a membership from Pending to Active. This is a manual step.

Inactive If a customer is no longer actively participating in a service credit membership, change the status to Inactive. This will prevent any new events from being created for the membership.

Service Credit Membership - Main

This page is used to maintain and display general information about a service credit membership. Open this page using **Menu > Customer Information > Service Credit Membership > Search**.

Description of Page

Membership Info and **Membership ID** are displayed on every page. These values only appear after the membership exists on the database. The **ID** is a system-assigned random number. The **Membership Info** is a concatenation of important details about the membership.

Membership Status defines the state of the membership.

FASTPATH:

Refer to [Lifecycle of a Membership](#) for more information about membership status.

Click the **Activate** button to activate a Pending membership. When this button is clicked, the system executes any Membership Activation algorithms that are linked to the [service credit membership type](#).

Click the **Inactivate** button to transition an Active membership to Inactive. When this button is clicked, you are prompted to provide an **Inactive Reason** and the system executes any Membership Inactivation algorithms that are linked to the [service credit membership type](#).

Indicate the **SC Membership Type**. This field is important as it controls numerous aspects of the behavior of the membership and its events.

FASTPATH:

For more information about what the membership type controls, refer to [Setting Up Service Credit Membership Types](#).

Indicate the **Start Date** and **End Date**, which define the period for which this membership is effective. Leave the end date blank if this membership is effective indefinitely. Refer to [Stopping a Membership vs. Inactivating a Membership](#) for more information.

If this membership is related to a record in an external system, use the **External ID** to indicate the unique identifier of the record in the external system.

If events linked to your membership may generate miscellaneous adjustments, indicate the **Service Agreement** to use for these [miscellaneous transactions](#). The account for this service agreement must be one of the accounts linked to the membership.

The **Events** grid displays the events linked to the membership. To view any of the events use the drill down button.

If your SCM type indicates that the membership has a balance, the tree at the bottom displays information about the balance of the membership based on the amounts for completed events. If the SCM Type indicates subcategories and/or a fiscal year is required, subtotals for completed events are also displayed for each subcategory / fiscal year and by fiscal year / subcategory, if applicable. If any pending events exist, the tree includes a node with information about these events.

Service Credit Membership - Account

This page is used to maintain the accounts linked to a service credit membership. Open this page using **Menu > Customer Information > Service Credit Membership > Search** and navigate to the **Account** page.

Description of Page

Indicate the **Account ID** for each account linked to this membership. Typically a membership will be linked to only one account. However, if a person has multiple accounts and the service credits should span the accounts, multiple accounts are linked to the same membership.

The Service Credit Membership zone on the Account Information portal contains information about memberships for the current customer. (When you find one of the customer's records on [Control Central - Main](#), you are automatically transferred to the [Account Information](#) portal.)

NOTE:

Portal Preferences. The Service Credit Membership zone only appears if you have modified your preferences to display this zone.

Service Credit Membership - Characteristics

The characteristics page contains information that describes miscellaneous information about the service credit membership. Open this page using **Menu > Customer Information > Service Credit Membership > Search** and navigate to the **Characteristics** page.

Description of Page

NOTE:

Characteristic Types. You can only choose characteristic types defined as permissible on the service credit membership record. Refer to [Setting Up Characteristic Types & Their Values](#) for more information.

To modify a characteristic, simply move to a field and change its value. To add a new characteristic, click + to insert a row then fill in the information for each field. The following fields display:

Effective Date Define the date on which the characteristic becomes effective. The effective date defaults from the [Installation Record](#).

Characteristic Type Indicate the type of characteristic.

Characteristic Value Indicate the value of the characteristic.

NOTE:

Default Note. A service credit membership's characteristics default from the [service credit membership type](#).

Service Credit Membership - Membership Tree

The membership tree page displays accounts, SAs and persons linked to the service credit membership. Open this page using **Menu > Customer Information > Service Credit Membership > Search** and navigate to the **Membership Tree** page.

Description of Page

The tree displays each account linked to the membership. For each account, a node exists for:

- Each service agreement whose SA type is included in the service credit [membership type](#) 's SA type collection.
- Each financially responsible person linked to the account. These persons are considered the [members](#).

Maintaining Service Credit Events

Service credit events record credits earned or redeemed for a given membership. The topics in this section describe how to maintain service credit events. Refer to [The Big Picture of Service Credit Events](#) for background information about memberships and their events.

Lifecycle of a Service Credit Event

The following diagram shows the possible lifecycle of a service credit event.

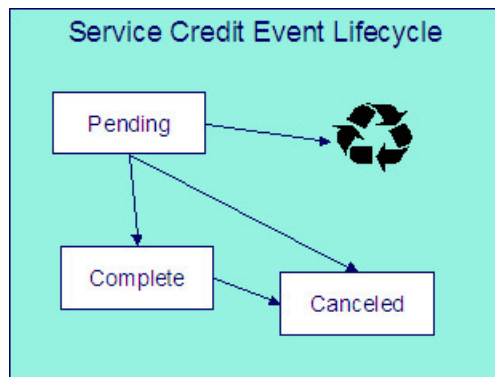

Pending A service credit event may start out in the Pending state. An event is typically created in this state when a review of the event is desired before completing it. Refer to [Creating Pending Events](#) for more information.

Complete A service credit event is typically created in the Complete state. When an event is completed, the system executes any event completion algorithms indicated on the [service credit event type](#).

Canceled If a service credit event is no longer valid, it may be Canceled. When an event is canceled, the system executes any event cancellation algorithms indicated on the [service credit event type](#).

Service Credit Event - Main

Open this page using **Menu > Customer Information > Service Credit Event > Search**.

Description of Page

The **Service Credit Event Info** is a concatenation of important details about the service credit event. The **Service Credit Event ID** is a unique system-assigned random number. These values only appear after the service credit event exists on the database.

Service Credit Event Status defines the state of the service credit event.

FASTPATH:

Refer to [Lifecycle of a Service Credit Event](#) for more information.

Click the **Complete** button to change a Pending event to Complete. When this button is clicked, the system executes any event completion algorithms that are linked to the [service credit event type](#).

Click the **Transfer** button to transfer this event to another membership. When this button is clicked, you are prompted to provide the membership ID to transfer the event to. The new membership must have the same membership type as the original membership. Refer to [Events May Be Transferred](#) for more information.

Click the **Cancel** button to cancel this event. When this button is clicked, the system executes any event cancellation algorithms that are linked to the [service credit event type](#).

The **Create Date/Time** captures the date and time that this event was created. This defaults to the system date/time.

Indicate the service credit **Membership ID** to which this event should be linked.

Indicate the **Service Credit Event Type**. This field may define algorithms to be executed when the event is completed or canceled. Refer to [Setting Up Service Credit Event Types](#) for more information.

If your [service credit membership type](#) indicates one or more subcategories to be associated with events for this type of membership, indicate the appropriate **Subcategory Name** for this event.

If your [service credit membership type](#) indicates that fiscal year is required, indicate the appropriate **Fiscal Year** for this event.

Enter the **Service Credit Event Amount**. If your [service credit membership type](#) indicates that your membership has a balance, this amount is used to calculate the overall balance for the membership as well as a balance for the subcategory and/or fiscal year, if applicable.

If this event was created as a result of a transfer from another membership, the **Transferred From Event ID** is displayed.

If the information about this event may be [downloaded to a third party](#) system, you should have an event completion algorithm that stamps the appropriate **Batch Control** and **Batch Number** onto the event.

The FT collection displays information about [financial transactions related to this event](#). Two different categories of financial transactions may be linked to the event.

- FTs that contributed to this event. These financial transactions played a part in the creation of this event. For example, if frequent flier miles are earned as a result of newly created bill segments, the FTs related to these bill segments are linked to the event and marked as contributed to FTs. This information is purely for audit purposes. It is the responsibility of the algorithm or background process that creates the event to populate the collection of contributed to FTs. Refer to [How Events Are Created](#) for more information.

NOTE:

The amount of the contributed to FTs will not necessarily add up to the amount of the event. Refer to the algorithm or background process that calculates the amount of the event to understand how the event amount is calculated based on the amount of the contributed to FTs

-
- FTs that were created by this event. These financial transactions are created as a result of this event. For example, if you have generated a capital credit allocation event, perhaps you need to post information to the general ledger. An allocation event should therefore generate an adjustment to post the effect on the GL. The adjustment's FT is linked to the event as an audit. In order to create a financial transaction related to this event, you must plug in an appropriate event completion algorithm on your [service credit event type](#).

FASTPATH:

Refer to [An Event May Cause Other Actions to Occur](#) for more information.

Loans

There are many reasons why your company may loan money to customers. For example, your company may loan money to:

- Finance service upgrades (e.g., to change to dual fuel)
 - Support economic development (e.g., to extend a power line)
 - Promote energy conservation (e.g., customers borrow to insulate their house)
-

NOTE:

Loans are optional. You need only set up loans if your organization loans money to customers. For information on setting up the system to enable loans, refer to [Defining Loan Options](#).

The Big Picture Of Loans

The topics in this section provide background information about loans.

Loans Are Service Agreements

Loans are initiated by creating a loan service agreement for a customer. The loan service agreement (and its SA type) contains the loan's terms, including the loan amount, periodic payment amount, the number of amortization periods, the interest rate, and the periodicity of the bills. Loan service agreements are just like other service agreements in many ways:

- The system bills the customer for the periodic payment amount using information on the service agreement.
- The customer pays the billed amount.
- If the customer doesn't pay, [credit and collections](#) may start a collection process to encourage the customer to pay (depending upon how the loan debt class has been set up on your system).

Loan service agreements differ from other service agreements in the following ways:

- Loans have [interest charges](#).
 - Loans have [amortization schedules](#).
 - Loan SAs are maintained on a separate transaction (refer to [Loan - Main](#) for more information).
-

NOTE:

Loan service agreements are created using Start/Stop. Loan service agreements are created using [start/stop](#) just like all other service agreements. The start/stop transaction has special loan functionality that allows an operator to specify the service agreement-specific loan terms described above. A start option can be specified to override the SA type's interest bill factor.

Loan Interest Charges

When a bill is generated for a loan, the interest charge is calculated using an algorithm. The base package loan interest charge algorithm type (LINT-SI) calculates simple interest based on:

- Unbilled principal (i.e., the payoff balance minus the current balance)
 - The number of billing periods covered by the bill
 - The interest rate
-

NOTE:

No interest on interest and no interest on past due amounts. Just like a classic home loan, the base package algorithm does not calculate interest on interest, nor does it calculate interest on past due amounts. However, your system may be set up to levy a late payment charge.

After the interest charge is calculated, the bill segment FT algorithm generates the financial transactions for the bill. The base package FT algorithm generates a financial transaction that adds the interest charge to the payoff balance. In other words, if the customer wanted to pay off the loan, they would owe the principal balance plus the interest charge.

FASTPATH:

For more information, refer to [Billing For Loans And Interest Calculation](#).

Loan Amortization Schedules

A loan's periodic payment amount is calculated such that the customer repays the loan in equal amounts over the term of the loan (with the exception of the first and last bill segments, which are typically for different amounts). The amortization schedule is a projection of the amount of principal and interest in each payment over the life of the loan. The amortization schedule may change, for example if the interest rate changes or the customer makes an overpayment (reducing the principal balance).

The amortization schedule is a theoretical projection of the future. The term theoretical is used because the customer's actual payments can cause the schedule to change. For example, if a customer overpays a bill, the loan's length decreases and the amount of principal and interest in each scheduled payment changes.

A loan's amortization schedule is calculated when you click the **Calculate** button on [Loan - Main](#). When this button is clicked, an algorithm plugged in on the loan SA type actually calculates the amortization schedule.

You can view a loan's latest amortization schedule using [Loan - Main](#). You can also change the loan's payment periods or periodic payment amount on this page and recalculate the loan's amortization schedule.

Negative Amortization

The system does not allow you to use a periodic payment amount that is less than the periodic interest amount. If it did, the customer's payoff balance would increase over time (this is referred to as "negative amortization"). There are two methods you can use to specify a payment amount in the system. Depending on which method you use, the system informs you of negative amortization differently:

- If you enter a payment amount that is too small on the Start confirmation page or in the **Renegotiate Future Payments** grid on [Loan maintenance](#), you get an error message when you click the **Calculate** button. You must fix the payment amount before you can start the loan or save your changes.
- If you manually override the **Payment Amount** on [Loan maintenance](#), you can save a payment amount that is too small to cover the interest charges. However, the system notifies you that it is not able to calculate the **Forecasted Schedule** because of negative amortization. Additionally, bill segments for the loan SA are produced in error until the payment amount is adjusted appropriately.

Loan Overpayments

Overpayments reduce the principal amount (the amount owed on the loan), which follows the philosophy adopted by a typical home loan. When the payment is made, any overpayments are distributed according to the overpayment distribution

algorithm defined for the customer class. Typically, loan service agreements should be set up so that the overpayment is applied to the principal balance.

When the payment transaction is frozen, the system checks to see if there is a credit amount on the loan SA's current balance. If a credit exists, the customer has made an overpayment and an adjustment is created to transfer the amount of the credit from the SA's current balance to its payoff balance, thus reducing the principal by the amount of the overpayment.

FASTPATH:

For more information about the adjustments created for loan overpayments, refer to [Overpayments On Loans](#).

NOTE:

Overpayments and interest. The base package interest calculation algorithm (plugged in on the loan's SA type) does not take into consideration the exact date that the overpayment is made when calculating the interest for the period.

It only takes into consideration the outstanding principal amount (payoff balance - current balance) at the time of the interest calculation.

The Lifecycle Of A Loan

Loans have the same [lifecycle as other service agreements](#) (e.g., pending start, active, pending stop). You should rarely have to manually change a loan service agreement's status. Why? Just like other service agreements, the system changes the status behind-the-scenes when various events take place. For example, loans in the pending start state are automatically activated by a system background process.

If you need to manually change a loan service agreement's status (e.g., you need to cancel a loan that was inadvertently started), you can do so from [Service Agreement - Main](#).

Finalizing And Closing A Loan

A loan SA is automatically stopped when the last bill segment is generated for the loan. If the remaining principal balance (plus accrued interest) is less than or equal to the loan payment amount, the SA status is changed to pending stop and the bill segment is marked as the closing bill segment. The SA can then be stopped by the user (manually using the SA page) or by the SA activation background process. When the customer pays the last bill, the loan SA is closed.

FASTPATH:

For more information about transitioning SAs from pending stopped, refer to [Finalizing Pending Stops](#).

Navigating To The Loan Maintenance Page

Any of the following methods can be used to navigate to the [Loan Maintenance](#) transaction:

- A user can set up a [favorite link](#) associated with the loan transaction.
- Via any of the following menus:
 - Account context menu
 - Service agreement context menu
 - Menu

NOTE:

Alerts and Loans. If the loan SA type is set up with an alert, the [Alert Zone](#) highlights if a loan exists for the current account. You are transferred to the SA maintenance transaction (not the loan maintenance transaction) if you drill down on the alert.

Loan Maintenance

You can use loan maintenance to view the loan's amortization schedule and financial history as well as to change the terms of a loan, including the loan amount (prior to SA activation only), interest rate, payment amount and number of payment periods.

NOTE:

Starting Loans. You cannot start a loan from Loan - Main; you must use Start/Stop. Refer to [How To Start A Loan Service Agreement](#) for information.

Open **Menu > Customer Information > Loan > Search** to maintain a loan.

Description of Page

The fields at the top of the page are informational only. The **Payoff Balance** is the total amount owed by the customer (excluding any interest that may have accrued since the last bill). The **Current Balance** is the amount currently owed by the customer. The **Principal Balance** is the total principal amount left unbilled. Refer to [Payoff Balance and Current Balance for Loans](#) for more information.

The **Loan Amount** is the amount originally loaned to the customer. The **Standard Interest Rate** is the standard interest rate defined on the loan's SA type. If the SA type allows, the standard interest rate may be overridden by a start option and/or manually. The **Next Payment Amount** is the effective periodic payment amount as of the next bill.

The **Payment(s)** shows the number of payments that were used to calculate the original loan schedule.

The **Override Interest Rate** grid is used to override the standard interest rate. The interest rate can only be modified if the loan's SA type allows it. Note that changing the interest rate changes the loan amortization schedule. To override the interest rate:

- Specify an **End Date** for the override rate in effect if there is one.
- Click + and specify the **Start Date** and the new **Interest Rate**. You can also specify the **End Date** of the new override rate, but this is not required.

The **Payment Amount** grid is used to maintain the effective periodic payment amount. Note that changing the payment amount changes the amortization schedule. To change the payment amount:

- Click + and specify the **Effective Date** and the new payment **Amount**.

NOTE:

Entering a payment amount that is too small. If you save a payment amount that is too small to cover the periodic interest charges, this causes [negative amortization](#). The system is not able to recalculate the amortization schedule and bill segments are produced in error until the problem is corrected.

The **History** grid shows the loan's financial history in reverse chronological order. The financial history grid displays the following information:

- The **Arrears Date** is used to compute how many days old the debt is. In the context of a loan, debt only refers to the billed amount (the amount the customer needs to pay to stay current).

- **Financial Transaction Type** displays the type of financial transaction except for adjustments. For adjustments, the adjustment type's description is shown.
- **Current Amount** is the effect of the FT on the service agreement's current balance.
- **Current Balance** is the amount owed by the customer at the time of the transaction.
- **Payoff Amount** is the effect of the FT on the service agreement's payoff balance. The value is grayed out if it is the same as the current amount.
- **Payoff Balance** is the total amount owed by the customer. The value is grayed out if it is the same as the current balance.

WARNING:

If you do not understand the difference between payoff balance and current balance, refer to [Payoff Balance And Current Balance For Loans](#).

The **Forecasted Schedule** displays the loan amortization schedule. The first row of the schedule shows the current cumulative interest, current cumulative principal and the current principal balance. All other rows show the future amortization schedule based on the loan details. The forecasted schedule includes the following information:

- The **Loan Period** displays the forecasted payment period dates based on the billing frequency and the payment periodicity. The Loan Period is blank for the first row, which shows current cumulative amounts.
- The **Amount** displays the projected amount of that payment. The Amount is zero for the first row, which shows current cumulative amounts only.
- The **Interest** displays the projected amount of interest in the payment amount. The Amount is zero for the first row, which shows current cumulative amounts only.
- The **Principal** displays the projected amount of principal in the payment amount. The Amount is zero for the first row, which shows current cumulative amounts only.
- The **Cumulative Interest** is the total interest amount that would theoretically be billed at that loan period.
- The **Cumulative Principal** is the total principal amount that would theoretically be billed at that loan period.
- The **Principal Balance** is the remaining principal balance that would theoretically be remaining at the loan period.

NOTE:

Forecasted schedule. The loan schedule algorithm calculates the values in the forecasted schedule. Depending on the algorithm set up for your installation, the values may have a different meaning.

The **Renegotiate Future Payments** area allows you to change the terms of the loan. You can modify the following options:

- You can modify the **Loan Amount** only if the SA has not been activated. After the SA is activated, this field is for information only.
- The **Interest Rate** allows you to change the interest rate. When changing the interest rate, specify either the number of payment amounts or the payment amount and click Calculate to recalculate the amortization schedule.
- The **Number of Payment Periods** allows you to change the number of periods remaining in the loan's term. The **Frequency** displays the periodicity of the payments. If you change the number of payment periods, use the Calculate button to recalculate the payment amount.
- The **Payment Amount** allows you to change the amount of individual payments. If you change the payment amount, use the Calculate button to recalculate the number of periods.
- The **Calculate** button recalculates the payment amount (when you specify the interest rate and the number of payment periods) or the number of payment periods (when you specify the interest rate and the payment amount) and recomputes the loan amortization schedule based on these new terms.

NOTE:

Implementing New Loan Terms. The changes that you make using **Override Interest Rate, Payment Amount** and **Renegotiate Future Payments** do not take effect until you save the loan. Changes made to the **Renegotiate Future Payments** section are only valid for save after you click Calculate, and they override any other changes.

Saving Renegotiated Future Payments. When you save a loan that has renegotiated payments, the system may add new records for the override interest rate, payment amount, or both. It uses the start date of the next loan period as the start date of the new interest rate and/or as the effective date of the new payment amount. If the loan has not yet been billed, the system updates the interest rate and/or payment amount created when the loan was started.

How To

The topics in this section describe how to perform common loan functions.

How To Start A Loan Service Agreement

Loan service agreements are created using [start/stop](#) just like all other service agreements. The start/stop transaction has special loan functionality that allows an operator to specify the service agreement-specific loan terms described above.

Creating a loan service agreement involves the following steps:

- Select the account on Control Central then open Start/Stop.
- Enter a **Start Date** and a **Start Method** of Start a SA.
- Indicate the **CIS Division / SA Type** of the loan service agreement and click the **Start** button.

NOTE: If the service agreement's account's CIS Division's **Restrict to Account CIS Division** flag is set to *Restricted*, the CIS Division is set to the account's CIS Division and cannot be changed.

- After you click **Start**, the Start Confirmation page appears. When you select a loan service agreement type, the Start Confirmation page displays special fields that allow you to specify the loan's terms.
- Select a loan **Start Option**. The start option includes the adjustment type for booking the principal amount, and can also include defaults for the initial loan amount, periodic payment amount, payment periods, and interest rate. The system uses the information on the start option to populate the service agreement's default parameters. You can manually override these parameters:
 - Enter the **Loan Amount** (the amount that the customer is borrowing). Note that the label for the Total Amount To Bill (e.g., Loan Amount) may appear differently depending on how the SA type was defined.
 - The system can automatically calculate either the payment amount (based on the loan amount and the payment periods) or the payment periods (based on the loan amount and the payment amount). Enter either the **Payment Amount** or the **Payment Periods** and click **Calculate**. Note that the label for the Recurring Charge (e.g., Payment Amount) may appear differently depending on how the SA type was defined.
 - Once the loan parameters are populated, click **Start**.

The loan is created in the pending start state. The next time the SA activation process runs, it will activate the loan SA. If you want to activate the loan immediately, navigate to the service agreement page and click **Activate SA**.

NOTE:

Overriding the Interest Rate. The **Interest Rate** is a display only field. The interest rate is taken from the value of the interest bill factor defined on the SA type or the contract value of the interest bill factor on the start option if one is defined. After starting a loan, you can manually override the interest rate using [Loan - Main](#) if the SA type allows it.

Changing The Loan Amount. You can use loan maintenance to change the loan amount for an SA as long as the SA has not yet been activated. It may be helpful to transfer to [Loan - Main](#), and verify the amortization schedule before activating the SA.

How To Modify The Terms Of A Loan

After a loan is active, you may want to modify its terms. You can change number of payment periods, the payment amount, and the interest rate (if allowed by the SA type). To modify the terms of a loan:

- Navigate to the [Loan maintenance](#) page.
- If you used the account context menu, the loan you want to modify may be displayed. If not, use the search dialog that appears to search for and select the loan you want to modify.
- In the **Renegotiate Future Payments** section, change the interest rate (if allowed), the number of payments, or the payment amount. Note that either the number of payments or payment amount must be blank.
- Click **Calculate**. The **Forecasted Schedule** is recalculated along with either the new payment amount or the new number of payments (depending on which was left blank).
- If the renegotiated payments are satisfactory to the customer, save the changes.

When you save the changes, appropriate entries are made in the **Override Interest Rate** and **Payment Amount** grids.

NOTE:

Saving Loan Modifications. You must save the renegotiated payments after clicking Calculate for the loan modifications to be effective.

How To Adjust Loans

You issue ad hoc adjustments if you need to change a loan's principal and/or current balance outside of the normal billing and payment functions.

An adjustment can:

- Change a loan's payoff balance.
 - Change a loan's current balance (i.e., how much the customer thinks they currently owe).
 - Change both the loan's payoff and current balance.
-

FASTPATH:

For details about the adjustment types to apply, refer to [Adjusting Loan Amounts](#). For information about creating adjustments, refer to [Adjustments](#).

How To Stop A Loan Service Agreement

Normally, a loan SA is automatically stopped when the bill segment for the last payment in the amortization schedule is generated for the loan (refer to [Finalizing And Closing A Loan](#)).

If a customer decides to payoff a loan before the term is complete, you can:

- Transfer to the SA maintenance page for the loan service agreement, specify an **End Date** for the loan, and click Save. This transitions the loan SA to pending stop.

NOTE:

End Date. The loan SA cannot be stopped until the specified end date is reached, so do not specify an end date that is in the future unless you do not want to stop the loan until that date.

Once the loan is in pending stop and the end date has been reached, the system transitions the loan SA to stopped. On the service agreement's normal bill cycle, the system final bills the SA for any outstanding balance plus accrued interest charges.

If you want to stop the loan and create the final bill immediately, complete these additional steps:

- On the loan's SA maintenance page, click the Stop SA button to transition the loan SA to stopped.
- Manually, [create a bill](#) for the loan service agreement. Remember that if you only want to generate a bill segment for a specific service agreement (e.g., the loan service agreement), transfer to the bill segment page. From there, you can generate and freeze a bill segment for a specific service agreement. When finished, return to the bill page and complete the bill.

When the customer pays the final bill, the loan SA is closed by the system.

FASTPATH:

For more information about SA states, refer to [The Lifecycle Of A Service Agreement](#).

Non-Billed Budgets

A Non-Billed Budget (NBB) is a payment plan used to level out a customer's payments over time. Non-billed budgets are typically used when your company bills on an infrequent basis and you want to provide your customers with a mechanism to make smaller payments more frequently. For example:

- Rather than receive a bill once a quarter, a customer could set up a Non-Billed Budget to pay fortnightly
- Rather than pay two large bills a year, the customer could set up a Non-Billed Budget to pay 10 out of 12 months (sparing themselves during the holiday season)

Non-Billed Budgets can cover one or more service agreements linked to the same account. You can have multiple active Non-Billed Budgets for an account, but any given service agreement can only be covered by a single Non-Billed Budget at any point in time.

NOTE:

Non-Billed Budgets are optional. The business processes described in this section are only relevant if your organization offers Non-Billed Budgets to its customers.

FASTPATH:

For information about setting up non-billed budget functionality for your system, refer to [Defining Non-Billed Budget Options](#).

The Big Picture Of Non-Billed Budgets

The following topics provide background information about Non-Billed Budgets.

Non-Billed Budget Service Agreements

Non-Billed Budgets are initiated by creating a Non-Billed Budget service agreement for a customer. The Non-Billed Budget SA and its SA type maintain the details of the Non-Billed Budget, such as recommendation rules, covered SAs, scheduled payments and credit balance. Non-Billed Budgets are just like other service agreements in some ways:

- Non-Billed Budgets have a current and a payoff balance.
- If the customer doesn't pay a monitored Non-Billed Budget, credit & collections may start a collection process to encourage the customer to pay (depending upon how the debt class has been set up on your system).

Non-Billed Budgets differ from other service agreements in the following ways:

- Non-Billed Budgets have a special role of Non-Billed Budget.
- Non-Billed Budgets have scheduled payments.
- Non-Billed Budgets maintain a list of covered SAs (utility and other service agreements to which the Non-Billed Budget applies)
- Non-Billed Budgets are started and maintained on a separate transaction (refer to [Non-Billed Budget - Main](#) for more information).

Which SAs Are Covered By A Non-Billed Budget?

A Non-Billed Budget can apply towards one or more of the account's billable SAs whose SA type is flagged as Eligible for Non-Billed Budget. SAs can be added to or removed from a Non-Billed Budget at any time. Additionally, an SA can be linked to more than one Non-Billed Budget as long as the Non-Billed Budgets to which it is linked do not have overlapping start and end dates.

A list of the SAs covered by a non-billed budget is maintained with the Non-Billed Budget SA. This list is used at bill completion to determine the financial transactions that should occur.

Non-Billed Budgets Versus Other Plans For Payment

Unlike a regular budget but like a payment plan, a Non-Billed Budget has one or more scheduled payments. However, unlike payment plans, bills are not produced for the scheduled payment amounts. Instead, customers are simply notified of the payment schedule and it is their responsibility to make the scheduled payments. In general, the following statements highlight the differences between Non-Billed Budgets and other payment plans.

- There is a payment schedule that is not dependent on billing, unlike [budget plans](#).
- Non-Billed Budgets are not limited to SAs of a single debt class, unlike [pay plans](#).
- Debt is not transferred from regular SAs to the non-billed budgets, unlike [payment arrangements](#).

WARNING:

Non-Billed Budgets and Budget Plans! An SA should not be on a Non-Billed Budget if it is on a [budget plan](#). A Non-Billed Budget overrides any budget functionality in most cases. However, placing an SA that is on a budget on a Non-Billed Budget may result in indeterminate results. For example, when the Non-Billed Budget is broken, the stop algorithm for the Non-Billed Budget syncs current and payoff balances for those utility SAs that were covered by the Non-Billed Budget.

There Are Two Types Of Non-Billed Budgets

There are two types of Non-Billed Budgets: monitored and unmonitored. As the terms suggest, the difference between monitored and unmonitored Non-Billed Budgets is whether they are monitored by the account debt monitor. However, this also means that monitored and unmonitored Non-Billed Budgets receive different financial treatment by the system.

In general, monitored Non-Billed Budgets have their current balances monitored by the account debt monitor while the current balances of any covered SAs are zero (and therefore don't violate any debt collection criteria). With monitored Non-Billed Budgets, customers make required prepayments that are applied towards their utility bills (until the Non-Billed Budget is stopped). They are responsible for making sure the payments on their Non-Billed Budget are up to date, but they do not have to payoff any balances on covered SAs.

Unmonitored Non-Billed Budgets do not have their current balances monitored by the account debt monitor while the current balances of any covered SAs are maintained and therefore subject to the account debt monitor. When customers are set up on an unmonitored Non-Billed Budget, the payments that they make towards the budget are optional. They are, however, financially responsible for paying the current balances of any covered SAs.

FASTPATH:

Refer to [Financial Transactions For Unmonitored Non-Billed Budgets](#) for detailed information about the financial differences between monitored and unmonitored Non-Billed Budgets.

NOTE:

SA Type Determines Monitored Status. The SA type that you select when setting up a Non-Billed Budget determines whether it is monitored or unmonitored (i.e., it's a setting on the SA type). Your company may choose to implement only monitored non-billed budgets, only unmonitored Non-Billed Budgets, or both.

Navigating To The Non-Billed Budget Maintenance Page

Any of the following methods can be used to navigate to the [Non-billed Budget Maintenance](#) transaction:

- An alert in the [Alert Zone](#) highlights if a Non-Billed Budget exists for the current account. You are transferred to the non-billed budget transaction if you drill down on the alert.
- You can setup an order's [campaign](#) to automatically transfer a user to the Non-Billed Budget transaction whenever an order is completed for a given SA. This might be useful for campaigns that are associated with services that are typically on a Non-Billed Budget.
- A user can setup a [favorite link](#) associated with the Non-Billed Budget transaction.
- Via any of the following menus:
 - Account context menu
 - Service agreement context menu
 - Menu menu

Recommending Scheduled Payments

When creating a Non-Billed Budget, you must select a recommendation rule. The recommendation rule establishes the amount to be paid and the dates on which the payments are due. In other words, the recommendation rule creates a recommended payment schedule.

The recommendation rules that you can use are specific to your implementation. The recommendation rule that you select can have default values for its parameters. If your implementation allows, you can manually override one or more of these default values. For example, you may be able to specify the period covered by the Non-Billed Budget and the day of the month on which the payments are due.

If your implementation allows, you can manually modify the recommended payment schedule to suit the needs of a particular customer.

FASTPATH:

Refer to [Designing Recommendation Rules](#) for more information.

Maintaining Non-Billed Budgets

Non-Billed Budget service agreements are started and maintained on a different transaction than other SAs. The topics in this section explain how to start and maintain Non-Billed Budgets.

Non-Billed Budget - Main

The Main page contains basic information about the Non-Billed Budget. Open **Menu > Customer Information > Non-Billed Budget > Search** to maintain this information.

Description of Page

Non-Billed Budget SA (service agreement) information and **SA ID** are displayed on each page. These values only appear after the service agreement exists on the database. The **SA ID** is a system assigned random number that stays with a service agreement for life. The **Non-Billed Budget SA** information is a concatenation of important details about the service agreement and its account.

The **Account ID** is identification of the account that is financially responsible for the service agreement.

Indicate the **CIS Division** and **SA Type**. These fields control aspects of the service agreement's behavior, such as whether the Non-Billed Budget is monitored or unmonitored. These fields are gray when the status is not Pending Start.

NOTE: If the service agreement's account's CIS Division's **Restrict to Account CIS Division** flag is set to *Restricted*, the CIS Division is set to the account's CIS Division and cannot be changed.

FASTPATH:

For more information about Non-Billed Budget SA types, refer to [Defining Non-Billed Budget Options](#).

If **Scheduled Payment Auto Pay** is Included in Auto Pay and the account is set up for automatic payment, the scheduled payments are covered by auto pay. If Excluded from Auto Pay, the scheduled payments are excluded from auto pay if it is set up for the account.

Recommendation Rule is used to create a recommended payment amount and payment schedule. The SA type controls which recommendation rules are allowed for the Non-Billed Budget SA.

Current Balance indicates the amount the customer currently owes on the Non-Billed Budget. If the Non-Billed Budget is unmonitored, the current balance is always zero.

Payoff Balance displays the total amount the customer would owe if they wanted to close the service agreement. For Non-Billed Budgets, the payoff balance typically represents an accumulated credit that has not yet been distributed to the covered SAs (at bill completion time or when the Non-Billed Budget is stopped).

The **Start Date** defines when the financial relationship begins. The **End Date** is a display only field that indicates when the financial relationship terminates. The **Expiration Date** is the date on which the SA expires. The **Renewal Date** is the date on which the SA is scheduled to be renewed by the SA renewal background process. If the SA is not renewed by the expiration date, the stop process is initiated.

The **Recommendation Rule Parameter Values** grid specifies the parameters and their values to use for the selected recommendation rule:

- **Parameter** is the name of the parameter from the recommendation rule algorithm type.
- **Value** is the value used for the parameter. If the recommendation rule allows, you can override the default values by specifying your own.

NOTE:

The recommendation rule's payment schedule algorithm type (NBPS-MON) controls the number and type of parameters. The recommendation rule controls the default values and whether they can be overridden.

The **Covered Service Agreements** grid lists the utility and other SAs that are on the Non-Billed Budget. You must create the list of covered SAs before the recommendation rule can recommend a payment amount and list of scheduled payments. The grid displays the **SA ID**, **SA Information**, **Current Balance** and **Payoff Balance** for covered SAs.

The scheduled payments grid displays the scheduled payments created by the recommendation rule (after you click the Recommend NBB button). You can manually create or modify the **Scheduled Date** and or **Scheduled Amount** of any scheduled payment in the list. The **Total of Scheduled Payments** shows the total of all scheduled payments in the list.

FASTPATH:

Refer to [Scheduled And Actual Payments On The Non-Billed Budget](#) for more information on what occurs when the base [Non-Billed Budget scheduled payment background process](#) processes scheduled payments that are due.

In the Action grid:

- Click **Recommend** to create a recommended payment schedule based on the recommendation rule.
- Click **Renew** to manually renew the Non-Billed Budget. This executes the SA renewal algorithm for the SA type and returns new renewal and expiration dates for the SA.
- Click **Break** to manually cancel the Non-Billed Budget. This executes the break Non-Billed Budget algorithm defined for the SA type, and changes the status of the SA to pending stop.

Non-Billed Budget - History

The Financial History page displays the Non-Billed Budget's historical financial transactions. Open **Menu > Customer Information > Non-Billed Budget > Search** and navigate to the **History** page to view this information.

Description of Page

Non-Billed Budget SA (service agreement) information and **SA ID** are displayed on each page. These values only appear after the service agreement exists on the database. The SA ID is a system assigned random number that stays with a service agreement for life. The Non-Billed Budget SA information is a concatenation of important details about the service agreement and its account.

The **Account ID** identifies who is financially responsible for the service agreement.

The grid shows the Non-Billed Budget's financial history in reverse chronological order, including:

- The **Arrears Date** is used to compute how many days old the debt is. For monitored Non-Billed Budgets, debt refers to the scheduled payment amounts (i.e., the customer only owes the scheduled payment amounts up to the most recent scheduled payment date). The arrears date for a schedule payment is the scheduled payment date.
- **Financial Transaction Type** displays the type of financial transaction except for adjustments. For adjustments, the adjustment type's description is shown.
- **Current Amount** is the effect of the FT on the service agreement's current balance.
- **Current Balance** is the amount owed by the customer at the time of the transaction.

How To

The topics in this section describe how to perform common Non-Billed Budget functions.

How To Start A Non-Billed Budget Service Agreement

To set up a new Non-Billed Budget:

- Navigate to the Non-Billed Budget maintenance page.
- If the account is not already specified, select the **Account** for which you want to start the Non-Billed Budget.
- Define the **CIS Division** and **SA Type** to use for the Non-Billed Budget service agreement.
- If necessary, change the **Start Date** (the current date is defaulted).
- Select the **Recommendation Rule** to use and modify any of the default parameters to meet the needs of the customer.
- Verify the list of **Covered Service Agreements**. All the account's SAs that are eligible for Non-Billed Budget are listed. Click  to remove unwanted SAs from the list.
- Click **Recommend**.
- On the pop-up dialog, specify the **Schedule Start Date** and click **Recommend**.
- Make any necessary changes to the expiration date, renewal date and scheduled payments grid and click Save.

How To Cancel / Stop Non-Billed Budget SAs

To stop a Non-Billed Budget:

- Navigate to the Non-Billed Budget maintenance page.
- If the account with the Non-Billed Budget you want to stop is not specified, select the **Account** of the Non-Billed Budget you want to stop.
- If the account has more than one Non-Billed Budget SA, select the Non-Billed Budget you want to stop.
- Click **Break**.

How To Renew Non-Billed Budgets

Most Non-Billed Budgets are renewed automatically by a background process. However, you may manually renew Non-Billed Budgets that are eligible for renewal if desired.

To renew a Non-Billed Budget:

- Navigate to the Non-Billed Budget maintenance page.
- If the account with the Non-Billed Budget you want to renew is not specified, select the **account** of the Non-Billed Budget you want to renew.
- If the account has more than one Non-Billed Budget SA, select the Non-Billed Budget you want to renew.
- If desired, change the recommendation rule or any of the parameters.
- Click **Renew**.

The new expiration and renewal dates are calculated and the new payment schedule is appended to the list of scheduled payments.

How To Set Up Automatic Payment For A Non-Billed Budget

If a customer wants to pay their non-billed budget scheduled payments automatically:

- Set up the account for automatic payment (as described under [How To Set Up A Customer To Pay Automatically](#)).
- Navigate to the Non-Billed Budget Maintenance page and select the Non-Billed Budget for the account.
- Set the **Scheduled Payment Auto Pay** field to indicate that the scheduled payments are Included in Auto Pay.

Case Management

NOTE:

Separate module. The Case Management functionality is associated with a separate Case Management module. If this module is not applicable to your business you may turn it off. Refer to [Turn Off A Function Module](#) for more information.

Your organization can use case management functionality to manage a variety of situations, such as:

- a high-bill complaint,
 - a bankruptcy,
 - an inspection of a premise,
 - a customer's request for literature,
 - a contractor's request to extend a line,
 - a customer's rejection of a quote,
 - a customer's request to change information on a future date,
 - the processing of a market message in a deregulated environment
-

NOTE:

Your implementation controls how your cases behave. Since virtually all aspects of case management functionality are controlled by your implementation, you can use it to handle a myriad of business requirements. Refer to [Defining Case Management Options](#) for the details.

Background Topics

The topics in this section provide background information about case management functionality.

Case Type

A case is controlled by the case type that it references. Some aspects of the case that are controlled by the case type include:

- The [lifecycle](#) of the case
- The [applicability](#) of a person, account, and/or premise on the case
- Which [fields are required](#) during the various stages of a case's life
- Which users can [access cases](#) of a given type
- Additional processing that should take place when a case enters or leaves a given state

Refer to [Case Type Controls Everything](#) for a description of the business rules that you control when you set up your case types.

Creating Cases

To create a case, open the [case management](#) page in add mode, select the appropriate case type, fill in the other necessary fields, and click save. Oracle Utilities Customer Care and Billing also includes scripts that can help create cases. Refer to [Scripts and Cases](#) for more information.

You can also develop plug-ins and user exits to so that the system will create cases when specific events take place. For example, you could set the system to create a case when an umbrella agreement is ready for renewal or when a quote is created.

Please refer to [Maintaining Cases](#) for a detailed description of the case page and field descriptions.

Log Information

A case log contains an entry for every recorded event during the lifecycle of the case. There are two types of log entries:

- **Automatic entries.** The system automatically creates an entry in the log when a case is created or there is a [status change](#). Users cannot modify or delete these log entries.
- **Manual entries.** Users can add manual entries to record significant events at their discretion.

Refer to [Case - Main](#) for the page used to view the log.

Refer to [Case Statistics for a Given Status](#) for information about a report that uses the log to provide productivity statistics.

Alerts

The [alert zone](#) will highlight if the person / account / premise in context have cases in a state that is configured as "alertable" if you plug-in the appropriate algorithm on the installation record. Refer to [Alert Info Is Controlled By An Installation Plug-In](#) for the details.

To Do's and Cases

You can configure the system to inform users of cases that require their attention. Refer to [To Do's and Cases](#) for the details.

Reports

Several reports summarize case information. Refer to the [Reports](#) chapter for the details.

Maintaining Cases

Your organization can use the case management functionality to manage a variety of situations, such as:

- a high-bill complaint,
- a bankruptcy,
- an inspection of a premise,
- a customer's request for literature,
- a contractor's request to extend a line,
- a customer's rejection of a quote,
- a customer's request to change information on a future date,
- the processing of a market message in a deregulated environment

NOTE:

Since an implementation can configure virtually every aspect of a case, the look and feel of the case management page are dynamic based on how [case types](#) have been configured.

Case - Main

Open the case management page by selecting **Menu > Customer Information > Case > Search**.

Main Information

Case Info contains a concatenation of important information about the case. **CaseID** is the system-assigned unique identifier of the case. These values only appear after the case is added to the database.

NOTE:

Formatting may be performed by a plug-in. Refer to [Case Info May Be Formatted By An Algorithm](#) for more information.

Case Type defines the type of case. This field is protected after the case has been added. Refer to [Case Type Controls Everything](#) for more information.

NOTE: Available case types can be restricted by CIS Division. The restriction of case type by CIS division is dynamic. It is based on the account in context, the premise in context, or the current user. The restriction of case type is applied using these rules in sequence.

- If there is an account in context and that account has a CIS Division, that CIS Division is used to restrict the case types that appear.
 - If there is a premise in context and that premise has a CIS Division, that CIS Division is used to restrict the case types that appear. Note: If there are both an account and premise in context, the account CIS Division is used.
 - If there is no account or premise in context with a CIS Division and the current user is associated with CIS Division(s) those CIS Division(s) are used to restrict the case types that appear. See [Users and CIS Division](#) for more information.
-

Status shows the current state of the case. Refer to [Case Lifecycle](#) for more information.

If the case has any To Do entries associated with it, a hyperlink will appear summarizing the number and status of the entries. You can select the link to view these entries. Refer to [To Do's and Cases](#) for more information.

Date / Time Opened shows when the case was created. If the case is in a final state, the **Date / Time Closed** will also be shown. Refer to [One Initial State and Multiple Final States](#) for more information.

Script references the business process assistant script that can help you work on the case. You can click on the hyperlink to execute this script. This field is hidden if no script is associated with this case's current Status. Refer to [Scripts and Cases](#) for more information.

The **Actions** section contains buttons you can use to action the case. This area is suppressed if no actions can be performed for the case given its current status. A button will be gray if you do not have security rights to the action. Refer to [Buttons Are Used To Transition A Case](#) for more information.

When the user adds a new case or changes the state of a case manually the system attempts to auto-transition the case to subsequent statuses as necessary. If auto-transition rules apply to the new state (and to subsequent ones) they would be executed right away. If the case has been automatically transitioned to its current state the following message area appears right after the action area. If an error is encountered in the process a corresponding error message is displayed in the Auto-transition Message Area. Refer to [Automatic Transition Rules](#) for more information.

NOTE:

The Auto-transition Message Area only appears when a case has just been automatically transitioned to its current state online. It only remains visible until the data for the case is refreshed.

Use the **Comments** area to describe anything interesting or unusual about the case.

Person references the person associated with this case. This field is suppressed if the Case Type indicates that a person is not allowed on cases of this type. This field is protected if the case is closed (i.e., if its status is defined as being final). This value is defaulted to the Person currently displayed in the Dashboard.

Account references the account associated with this case. This field is suppressed if the Case Type indicates that an account is not allowed on cases of this type. This field is protected if the case is closed (i.e., if its status is defined as being final). This value is defaulted to the Account currently displayed in the Dashboard.

Premise references the premise associated with this case. This field is suppressed if the Case Type indicates that a premise is not allowed on cases of this type. This field is protected if the case is closed (i.e., if its status is defined as being final). This value is defaulted to the Premise currently displayed in the Dashboard.

NOTE:

The case type controls the relationship validation among person, account, and premise.

Responsible User references the user who has overall responsibility for the case. This field is suppressed if the Case Type indicates that a responsible user is not allowed on cases of this type. This field is protected if the case is closed (i.e., if its status is defined as being final).

The **Contact Information** area is used to define how to contact the individual who initiated the case. These fields are suppressed if contact information is not allowed on cases of this type. The fields cannot be modified if the case is in a closed status. The following information can be defined.

Contact Person references the person who should be contacted. This defaults to the Person defined above.

Preferred Contact Method indicates how the person prefers to be contacted. The following options are available:

- Not Applicable. If the person doesn't want to be contacted (or the contact method is unusual), use this option. You might want to consider describing the situation in the Contact Instructions.
- Person Contact. If this method is selected, select a person contact related to the Person link to the customer contact. The customer contact must contain a Person to use this method.
- Postal. If this method is selected, the Contact Person's address appears. Refer to [Where Does The Address Come From](#) for a description of which address the system displays.

The following methods appear when the Legacy Person Phone and Email **Option Type** on the Customer Information Options [Feature Configuration](#) has been enabled.

- Email. If this method is selected, the Contact Person's email address appears adjacent.
- Phone. If this method is selected, the Contact Person's phone number appears.
- Fax. If this method is selected, the Contact Person's fax number appears (the system knows which of a person's phone numbers is a fax number by the phone type).
- SMS. If this method is selected, the Contact Person's short message service (SMS) information displays.

NOTE: While on a case, users can add a person contact by selecting Add Person Contact from a Person Context menu. This will open a portal-based page that allows a person contact to be added. This process will not lose context or information that has been added to the case. The new person contact can be used within the case.

Contact Instructions indicates any special instructions indicated for when or how to return a call.

Callback Phone Type, Callback Phone Number, and Extension indicate the actual phone number and phone type that should be used to call.

Characteristics

The **Characteristics** grid contains fields that contain important information about the case. This grid is suppressed if the Case Type does not use characteristics. This grid is protected if the case is closed (i.e., if its status is defined as being final).

You can only choose **Characteristic Types** defined as permissible for this case type. Refer to [Additional Information](#) for more information. If you attempt to use an **Action** to transition a case into a status that requires additional information, a pop-up will prompt you for the additional fields. Refer to [Required Fields Before A Case Enters A State](#) for more information.

Case - Case Portal

Select **Menu** > **Customer Information** > **Case** > **Search** and navigate to the **Case Portal** page view additional information associated with a case.

Depending on your implementations requirements, you may define additional zones to appear on this Portal.

The contents of this section describe the zones that are available on this portal page.

General Information displays the Case ID and Case Info.

Object Portal When information associated with the case has been stored in the case Character Large Object (CLOB) field (such as the data associated with a market message), the Object Portal displays this information “as-is.” You cannot modify the case CLOB field data from this page, but a case type algorithms can be configured to work with this data. For information on mapping data into CLOB fields, refer to the Business Object tips document **Schema Nodes and Attributes**.

Case - Log

To view the log entries associated with a case, open by selecting **Menu > Customer Information > Case > Search** and navigate to the **Log** page.

Description of Page

The **Log** grid displays log entries (in reverse chronological order) that audit the progress of the case. Please note the following about the entries in this grid:

- The system automatically creates log entries when a case is created, every time its status changes, or whenever an error occurs during the transition of a case. Algorithms plugged into a case type state can also be configured to create log entries. You cannot modify or delete the log entries.
- You can manually add a log entry by pressing the + button and enter the **Details**. You cannot modify or delete this information after saving it.
- The following information appears in the grid:
- **Log Date/Time** contains the date and time the log entry was created.
- **Details** contains user-specified or system-generated information about the log entry.
- **Related Object** is populated on log entries that were created to record the creation of some other object. For example, if a case plug-in creates a customer contact, the related object contains information about the customer contact. Please note that if the object description is shown in blue, you can click on the object's description to drill down to the object.
- **Log User** contains the user who caused the log entry to be created.
- **Log Type** indicates how the log entry was created. The possible values are:
 - Created. Only one entry per case will be of this type. This entry is automatically created by the system when the case is created.
 - User Details. A user creates this type of entry manually.
 - Status Transition. This type of entry is created by the system each time the case's status is changed (as a result of pressing one of the Action buttons).
 - System. An algorithm on the case type state may be designed/configured to create this type of entry when it does something auditable. For example, an algorithm that creates a customer contact could insert a log entry to show that it did this (it will also populate the FK to the customer contact, which will appear in the **Related Object** column).
 - Transition Error. The background status transition process creates an entry of this type if an error occurs when automatically updating a case to a subsequent status (as directed by either an Enter Status algorithm or an Auto-Transition algorithm). An entry of this type lists the case states involved with the failed transition, and the algorithm in which the error was generated.
 - Exception. The background status transition process creates an entry of this type under the same circumstances as a Transition Error. A log entry of this type indicates why the background transition failed.

NOTE:

The values for this field are customizable using the Lookup table. This field name is CASE_LOG_TYPE_FLG.

Premise Management

NOTE:

Separate module. The Premise Management functionality is associated with a separate Premise Management module. If this module is not applicable to your business you may turn it off. Refer to [Turn Off A Function Module](#) for more information.

The premise management functionality facilitates the following:

- Grouping premises together under a single parent premise
- Quick & efficient setup and maintenance of apartment complexes and high-rises
- A single view of properties for a landlord, including service status
- Ability to change the landlord or service status for a group of premises in one transaction
- And more...

The topics in this section describe premise management functionality.

Overview

The topics in this section provide background information about premise management functionality.

Define Premise Hierarchy

Premise management allows you to define premise hierarchy. For example, you could also have the notion of

- A building
- Multiple floors
- Multiple apartments per floor

To define this hierarchy you must create a [premise](#) for each level in the hierarchy and for each "child" premise, indicate its appropriate parent premise. Once you have set up your premise hierarchies, you may view the hierarchies on trees on the premise page and on the control central [premise tree](#).

In addition, the system provides the following [alerts](#):

- When viewing a parent premise, an alert indicates how many child premises exist
- When viewing a child premise, an alert indicates that it is linked to a parent premise.

Manage Premises for a Landlord

The premise management page provides the ability to view all the premises for the landlord along with information about the accounts linked to each premise.

You may use this page to assign, change or remove the landlord agreement for multiple premises in a single action. For example if a landlord sells his properties to another person, this page facilitates updating all premises with one action rather than changing the landlord for each premise separately. For example, if the landlord sells only a portion of his properties.

This page may also be used to start or stop service for one or more premises for the landlord. For example, a landlord plans to sell a high-rise apartment complex with 100 apartments. Imagine that 8 of these apartments are vacant and the landlord's account is currently paying for any usage to these apartments. In addition to changing the landlord agreement for all 100 apartments to the new landlord, the service for the vacant apartments should be transferred to the new landlord. A user can go to premise management, use the search criteria to view all premises for this landlord in a given apartment complex whose service is currently being paid for by the landlord and start service for these premise for the new landlord. (Using the back-to-back start/stop functionality, service will be stopped for the old landlord.)

Manage Groups of Premises

The powerful search criteria on the premise management page allows you to view different groups of premises based on any combination of account information, landlord information, parent premise address information and general geographic type information. You may also define search criteria such as "premises **not** linked to account 1234567890" or "premises linked to **any** landlord" or "premises **not** linked to any parent premise". For example, you could display all premises in a given latitude / longitude that are not linked to any parent premise.

Once your search results display the desired list of premises, you could perform mass updates such as assigning a parent premise or starting service. Following are examples of situations where this page would be helpful:

- The developer of a high-rise condominium complex is ready to start service for a group of condos. A user uses the premise management search criteria to display the premises linked to a give parent premise (representing the condo complex) that are not linked to any account. The user selects the premises in this list that the developer would like to start and starts service for all premises at once.
- There is a shopping mall in your service territory and each store in an individual premise. You may decide to define a parent premise for the entire shopping mall and link each store's premise to the parent. Once the parent premise is defined, a user navigates to the premise management page and displays the individual premises based on a similar address or based on a similar geographic type. The user then assigns the parent premise for all the individual premises using a single action.

Premise Management Page

This page allows you to display a list of premises using a combination of search criteria. In addition, you can perform actions on one or more of the resulting premises, including:

- Assigning a parent premise to one or more premises
- Removing the link to a parent premise from one or more premises
- Assigning a landlord to one or more premises
- Removing the link to a landlord from one or more premises
- Start service for one or more premises
- Stop service for one or more premises

Open this page using **Menu > Customer Information > Premise Management**.

Description of Page

The top half of the page is where you enter the criteria used to search for premises.

NOTE:

Multiple search criteria may be specified. You can search for premises using a combination of search criteria. For example, if you enter both a **Parent Premise Filter** of Linked To Any Premise and an **Account Filter** of Not Linked to Any Account; only those premises that have a parent premise but are not linked to an account will be displayed.

At least one positive criterion is required. You may not define your search criteria to only use filter values that start with "Not Linked...". At least one "positive" filter value is required.

The following table describes each of the different search methods.

Search Method	Description
Landlord Filter	<p>Use this filter to narrow down your search based on landlord. Enter one of the following values:</p> <p>Not Applicable</p> <p>Linked To This Landlord - for this option, you must enter a Landlord Agreement</p> <p>Not Linked To This Landlord - for this option, you must enter a Landlord Agreement</p> <p>Linked To Any Landlord</p> <p>Not Linked To Any Landlord.</p> <p>A filter value of Not Applicable defaults.</p>
Parent Premise Filter	<p>Use this filter to narrow down your search based on parent premise. Enter one of the following values:</p> <p>Not Applicable</p> <p>Linked To This Parent Premise - for this option, you must enter a Premise ID for the parent premise</p> <p>Not Linked To This Parent Premise - for this option, you must enter a Premise ID for the parent premise</p> <p>Linked To Any Parent Premise</p> <p>Not Linked To Any Parent Premise.</p> <p>A filter value of Not Applicable defaults.</p>
Account Filter	<p>Use this filter to narrow down your search based on account. Enter one of the following values:</p> <p>Not Applicable</p> <p>Linked To This Account - for this option, you must enter an Account ID</p> <p>Not Linked To This Account - for this option, you must enter an Account ID</p> <p>Linked To Any Account</p> <p>Not Linked To Any Account.</p> <p>A filter value of Not Applicable defaults.</p>
Premise Filter	<p>Use this filter to narrow down your search based on account. Enter one of the following values:</p> <p>Located At This Address - for this option, you must enter address constituents</p> <p>Located At This Geographic Type / Value - for this option, you must enter a Geo Type and Value</p> <p>Not Applicable</p>

Show This Specific Premise - for this option, you must enter a **Premise ID**

A filter value of Not Applicable defaults.

The **Select All** / **Clear All** buttons are used to select premises if you plan on issuing any of the mass update actions at the bottom of the page. Refer to the description of the "mass update" actions below for more information.

NOTE:

50 premises at a time. Clicking **Select All** selects the first 50 premises in the grid. If more than 50 premises exist, you must select them in batches.

The grid that follows contains the premises that match your search criteria. The following information appears in the grid:

- Select box. Use this checkbox to select premises for mass update actions.
- The **Premise Information** column shows information about each premise. Click the hyperlink to transfer to the [Premise](#) page where you can update information about the premise in question.
- The **Account Information** column shows information about all accounts linked to the premise, if any. Only accounts with non-canceled, non-closed service agreements linked to this premise are displayed. The column displays the name of the customer's main person followed by a list of status values for any of the account's service agreements linked to this premise. For example, you may see Customer A (pending stop), Customer B (pending start). If multiple service agreements linked to the account & premise have the same status, the status is only displayed once.
- The **Parent Premise Information** column displays information about the premise's parent premise, if one exists.
- The **Landlord Information** column displays the landlord agreement description for the premise's landlord, if there is one.

This transaction has sophisticated logic that can be used to perform "mass updates" to the premises that appear in the grid using the buttons at the bottom of the page. The buttons are enabled if you select at least one row from the premise grid. The following points describe these mass update actions:

Start Service

The **Start Service** button is used to start service for one or more premises. When clicked, the **Start SA Groups Confirmation** window opens.

NOTE:

Similar to Start/Stop. This page is similar to the Start SA Confirmation page that appears on start/stop. The differences are to accommodate starting multiple premises.

In order to start service for the selected premises, select the **Account ID**.

The **Start Date** is the date on which the service is scheduled to start.

Use **Start Requested By** to indicate the name of the person who requested the start.

Check **Include Child Premises** if all the child premises in the hierarchy below the selected premises should also be started for this account.

Click **Show SA Groups** to populate the remainder of the page.

The **Service Points** section summarizes the service points that exist for all the chosen premises. A row is displayed for each different **SP Type** along with a **Count** of the number of service points of that type. By default, all rows are checked, assuming that you want to start service for all service points (and the SA Groups To Start scroll below displays proposed

SAs to start for each SP type). You may uncheck any SP Type row if you do not wish to start service for that SP type. Click **Show SA Groups** to rebuild the SA Groups To Start information.

WARNING:

This page displays summary information about the service agreements and service points that are being turned on. It is recommended that you start groups of premises that have similar service point configurations. If you attempt to start service for many premises, each with different service point configurations, the start logic may be very complicated to verify on this page.

The **SA Groups To Start** scroll contains an entry for every service agreement that will be created if you click the **Start** button. If you do not want a service agreement to be created, click the - button or uncheck **Start this SA Group**. If you would like to start service agreements that are not SP-based service agreements (for example a deposit or a connection charge), click the + button to add a new SA group. The system assumes that you want to create a new service agreement for each selected premise.

Turn on the **Start this SA Group** switch if you want service agreements of this type to be created. If this is the first customer at the selected premises, this switch is checked for all service agreements that appear in the scroll. For each premise that was linked to a previous customer, this switch is on only for those types of service agreements used by the previous customer(s). (We assume the new customers only want the services used by the previous customers). Service agreements that are possible, but were not used by the previous customers, appear in the scroll with this switch turned off.

If Start This SA Group is checked, the system displays a message indicating the number of service agreements (for the number of service points) that will be created if you choose Start.

For a description of the remaining fields, refer to [Start/Stop - Start Confirmation](#).

Click **Start**. Standard [start](#) logic is followed when clicking start.

NOTE:

The start button is disabled if changes are made to fields on the page that may impact the SA Groups To Start collection. You must click **Show SA Groups** to rebuild the SA groups and enable the start button.

Stop Service

The **Stop Service** button is used to stop service for one or more premises.

NOTE:

that this functionality stops service for any account linked to the selected premises. If you want to stop service at the selected premises for only certain accounts, use the account filter criteria to narrow down the selection of premises prior to clicking Stop Service.

When clicked, the **Stop SA Group Confirmation** window opens.

In order to stop service for the selected premises, enter a **Stop Date**.

Enter a **Restrict to Account** if you want to stop only service agreements linked to this account. If not specified, all active services agreements for the premise are stopped regardless of the account.

Use **Stop Requested By** to indicate the name of the person who requested the stop.

Check **Include Child Premises** if the child premises in the hierarchy below the selected premises should also be stopped.

Click **Show SA Groups** to populate the remainder of the page.

The system builds a collection of service agreements currently linked to the service points for the selected premises. The grid contains the **CIS Division** and **SA Type** for each SA "group" and displays the number of service agreements in the **SA Group Summary**.

By default, the system checks each SA group assuming that you want to stop service for all SAs. You may uncheck any of the SA groups to not stop service for those SAs.

Click **Stop**. Standard [stop](#) logic is followed when clicking stop.

NOTE:

The stop button is disabled if changes are made to fields on the page that may impact the SA collection. You must click **Show SA Groups** to rebuild the SA collection and enable the stop button.

Assign Parent Premise

The **Assign Parent Premise** button is used to assign a parent premise to one or more premises. When clicked, the **Assign Parent Premise** window opens.

Specify the **Parent Premise ID** and click **Assign**.

Remove Parent Premise

The **Remove Parent Premise** button is used to remove the parent premise from one or more premises. When clicked, the parent premise ID of all selected premises is reset.

Assign Landlord

The **Assign Landlord** button is used to assign a landlord to one or more premises. When clicked, the **Assign Landlord** window opens.

Specify the **Landlord** agreement ID.

Check **Include Child Premises** if the child premises in the hierarchy below the selected premises should also be assigned this landlord.

Click **Assign**.

Remove Landlord

The **Remove Landlord** button is used to remove the landlord agreement from one or more premises. When clicked, the **Remove Landlord** window opens.

Check **Include Child Premises** if all the child premises in the hierarchy below the selected premises should also have their landlord agreement removed.

Click **Remove**.

Umbrella Agreement Management

Your organization may use umbrella agreement functionality to manage many situations, including (but not limited to) the following:

- Creating a "negotiated contract" with a large customer with many sites.
- Creating a "negotiated contract" with all customers in a common geographic area, for example a specific city or an apartment complex
- Grouping and managing the proposal service agreements created during the quoting process
- Managing the renewal process for special contracts
- Applying override rate terms to one or more service agreements for a given effective period
- more...

NOTE:

Separate module. The umbrella agreement functionality is part of the Contract Management module. If this module is not applicable to your business you may turn it off. Refer to [Turn Off A Function Module](#) for more information.

Overview Of Umbrella Agreement & Terms Of Service

An umbrella agreement is used to group together terms for a contract. It contains high level information about the contract such as the effective dates, the renewal date, if applicable and an account management group, if applicable. You may also define characteristics and [contacts](#) for the umbrella agreement.

The terms of the umbrella agreement are defined using one or more terms of service (TOS) records. For each TOS record, you must link one or more service agreements to indicate the services covered under the TOS.

UA

ID: 41786547792 Descr: McDonald's Contract
 UA Type: Large Cust Contract Period: 01-Oct-04 - 03-Sep-04

Terms of Service ID: 4553269781		
Descr: Grouping of McDonald's electric services		
TOS Type: Electric Template SA: n/a		
SA	Description	
3994822544	CA/E-COM, ECOM-1, Active, 6-1-98	
3994829303	CA/E-COM, ECOM-1, Active, 2-14-99	
Covered Entity	Value	Description
Person	1548779358	McDonald's Corp
Service Type	E	Electric

Terms of Service ID: 455324166		
Descr: Grouping of McDonald's gas services		
TOS Type: Gas Template SA: n/a		
SA	Description	
3994827536	CA/G-COM, GCOM-1, Active, 6-1-98	
3994822521	CA/G-COM, GCOM-1, Active, 2-14-99	
Covered Entity	Value	Description
Person	1548779358	McDonald's Corp
Service Type	G	Gas

The Terms of Service may point to a 'template service agreement' as a way to specify the rating terms and conditions to be used by all service agreements linked to the TOS. If a TOS does not define a template SA, then the TOS is used largely as a grouping mechanism rather than a billing mechanism.

Umbrella agreements and their terms of service records are used to support specific business scenarios that your organization supports.

Umbrella Agreement - Contacts

The contacts page defines persons associated with the umbrella agreement. Open this page using **Menu > Umbrella Agreement Management > Umbrella Agreement > Search** and navigate to the **Contacts** page.

Description of Page

The contacts collection allows you to define persons that are associated with the umbrella agreement. For each contact, define the **Person ID** for the person record that contains the demographic information for the contact. For each contact, use the **Comments** to define information about the contact.

TOS Covered Entities

Your implementation may configure a Terms of Service type to require that entities "covered" by the terms of service record be referenced on the TOS. For example, imagine that you define an umbrella agreement to provide special discounts to all the McDonalds franchises in your service area. When creating the terms of service record for the umbrella agreement, you may link the person record representing the McDonalds corporate entity as a covered entity for the TOS.

NOTE:

that there is no base product functionality that uses this collection. However, your implementation may use this information in an algorithm, for example, it could be used in a campaign / package eligibility algorithm.

Refer to [Terms Of Service Covered Entities](#) for information about defining covered entities for a terms of service type.

Rate Terms Overridden By Terms Of Service

Your organization may require rate information to be temporarily overridden for a service agreement that is linked to a TOS. In order to do this, the TOS record must reference a template SA. Refer to [Overriding Rate Terms](#) for information about defining your Terms of Service types to support template service agreements.

The topics in this section further describe the possible rate term overrides that may occur when a service agreement is linked to a terms of service record.

Rate Schedule Override by TOS

If a service agreement is linked to a terms of service, you may configure the system to use the rate schedule from the terms of service record's template SA rather than the one from the customer's service agreement. The customer's SA type controls this option.

FASTPATH:

Refer to [Configure SA Types for Umbrella Agreements](#) for more information.

If a service agreement is linked to a terms of service record, the rate information tree on the service agreement's rate info tab tells the user whether the rate from the service agreement or from the template SA on the TOS is currently applicable.

If a given service agreement's rate schedule is being taken from the terms of service record's template SA, then the override rate schedule is used not just in bill calculations, but for any logic that requires the service agreement's rate schedule. For example, one of the recommended budget amount algorithms may estimate consumption and apply the service agreement's rate. In this case, the rate used by the algorithm is the one linked to the terms of service record's template SA.

Override Of Other Rate Terms By TOS

There are other terms associated with a rate that may change when linking a service agreement to a terms of service record that has a template SA. These include contract riders, contract terms and tax exemptions.

When applying the rate to create the customer's bill segment, if a bill factor on any of the calculation rules indicates that it is eligible for tax exemptions, contract terms or contract riders, a flag on the bill factor indicates where the system should look for the appropriate value. The Terms of Service Usage flag tells the system to find applicable information either on the TOS's template SA only, on the customer's SA only or it should first check the TOS, then check the customer's SA.

FASTPATH:

Refer to [Configure Bill Factors for Umbrella Agreements](#) for more information.

NOTE:

Independent of rate source. The flag values on the bill factors are independent of the rate source setting for the SA type. For example, your implementation may configure the SA type's rate source to indicate that rate should be taken from the TOS template SA. However, if a bill factor is eligible for tax exemptions, your implementation may configure the bill factor to indicate that the exemption information should be taken from the customer's SA, not the template SA.

Umbrella Agreement Renewal

Although umbrella agreement records require an end date, your organization probably allows for renewal of agreements. A renewal may involve full re-negotiation of all terms, or may be as simple as extending the current terms. If umbrella agreements of a given type are eligible to be renewed, you configure the UA type to indicate how to calculate the renewal date and which algorithm to execute when the renewal date is reached.

Umbrella Agreement Renewal Background Process

The UA renewal background process ([UARENEW](#)) finds complete umbrella agreements whose renewal date has arrived and executes the renewal algorithm for the associated UA type.

NOTE:

It is the responsibility of the renewal algorithm to update the renewal date as per the business practice. Refer to [Renewable Umbrella Agreements](#) for more information.

Umbrella Agreements & Proposals

Umbrella agreements and their terms of service records may reference proposal service agreements. This functionality allows you to create the full contract for your customer during the quoting stage.

Additional Umbrella Agreement Topics

The following topics describe additional functionality related to umbrella agreements.

Umbrella Agreement Alerts

The [alert zone](#) will highlight if any of the account's SAs are linked to an effective umbrella agreement (via a non-canceled terms of service record).

Orders And Umbrella Agreements

When starting new service for a given account and premise, you may know ahead of time that the new service should be linked to an existing umbrella agreement. For example, perhaps all the service in a specific low income housing area qualifies for a special negotiated contract for the next year.

The system provides algorithms to allow you to add a new service agreement to an existing terms of service record when using the [Order](#) transaction to start service.

Refer to [Configure A Campaign To Link An SA To A Terms Of Service](#) for more information.

Umbrella Agreement Reports

The system supplies a [Report](#) providing umbrella agreement information for one or more umbrella agreements.

Umbrella Agreement Maintenance

Umbrella agreements help you manage your contracts by allowing you to group together service agreements for the contract with one or more terms of service records for the umbrella agreement.

Lifecycle Of An Umbrella Agreement

The following diagram illustrates the lifecycle of an umbrella agreement.

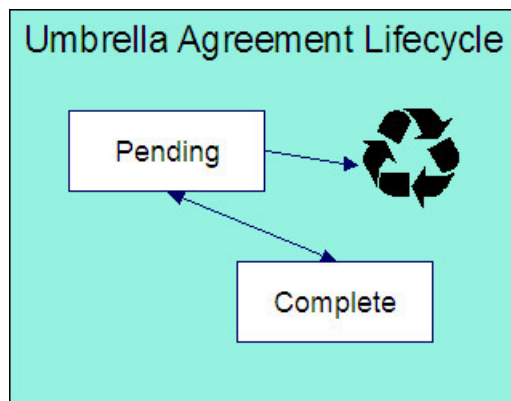

Pending The umbrella agreement is created in pending status.

You may delete a pending umbrella agreement. Deleting a UA also deletes its terms of service records.

Complete Only complete umbrella agreements are considered effective. You may transition a UA to complete if there is at least one terms of service record linked to it and if none of its TOS records are in pending status.

Under unusual circumstances, a complete umbrella agreement may be changed back to pending to correct errors.

Umbrella Agreement - Main

Open this page using **Menu > Umbrella Agreement Management > Umbrella Agreement > Search**.

Description of Page

Umbrella Agreement Info contains a concatenation of important information about the umbrella agreement. **Umbrella AgreementID** is the system-assigned unique identifier of the umbrella agreement. These values only appear after the UA is added to the database.

Umbrella Agreement Status shows the current state of the UA. The buttons adjacent to the status allow you to transition the UA's status.

- Click **Complete** to change the status of a pending umbrella agreement to complete.
- Click **Reopen** to change the status of a complete umbrella agreement back to pending.

FASTPATH:

Refer to [Lifecycle of an Umbrella Agreement](#) for more information.

Enter a **Description** for the umbrella agreement.

The **Umbrella Agreement Type** defines the type of umbrella agreement. Refer to [Setting Up Umbrella Agreement Types](#) for more information.

The **Start Date** and **End Date** define the effective dates of the contract. If the UA type is renewable, the **Renewal Date** indicates the date the umbrella agreement is processed by the [renewal background process](#).

You may assign an **AccountManagement Group** to this umbrella agreement. The AMG controls the roles assigned to [To Do entries](#) associated with the umbrella agreement. Refer to [Setting Up Account Management Groups](#) for more information.

Use the **Comments** area to describe anything interesting or unusual about the umbrella agreement.

This bottom of this page contains a [tree](#) that shows the various objects linked to the umbrella agreement. You can use this tree to both view high-level information about these objects and to transfer to the respective page in which an object is maintained.

Umbrella Agreement - Contacts

The contacts page defines persons associated with the umbrella agreement. Open this page using **Menu > Umbrella Agreement Management > Umbrella Agreement > Search** and navigate to the **Contacts** page.

Description of Page

The contacts collection allows you to define persons that are associated with the umbrella agreement. For each contact, define the **Person ID** for the person record that contains the demographic information for the contact. For each contact, use the **Comments** to define information about the contact.

Umbrella Agreement - Characteristics

The characteristics page contains information that describes miscellaneous information about the umbrella agreement. Open this page using **Menu > Umbrella Agreement Management > Umbrella Agreement > Search** and navigate to the **Characteristics** page.

Description of Page

NOTE:

Characteristic Types. You can only choose characteristic types defined on umbrella agreement's [umbrella agreement type](#).

The following fields display:

Characteristic Type Indicate the type of characteristic.

Characteristic Value Indicate the value of the characteristic.

NOTE:

Default Note. An umbrella agreement's characteristics default from the [umbrella agreement type](#).

Terms Of Service Maintenance

A terms of service (TOS) record defines one or more service agreements participating in a given umbrella agreement. The TOS record may also reference a template SA that could be used to override rate terms for the participating service agreements.

Lifecycle Of Terms Of Service

The following diagram illustrates the lifecycle of a terms of service record.

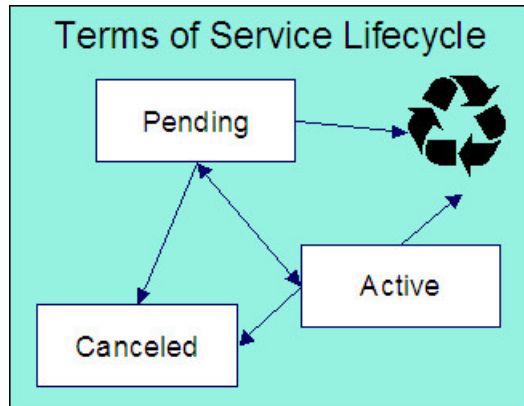

Pending The terms of service record is created in pending status. You may delete a pending TOS. If you want to keep a record of the TOS, you may cancel it rather than deleting it.

Active Only active terms of service records are considered effective. Change the status to active when you have entered all the desired information for this TOS. You may delete an active terms of service if the umbrella agreement is still pending. (Otherwise you must cancel the TOS.)

Canceled You may cancel a pending or active terms of service if it should no longer be used. Canceling a terms of service record unlinks all its service agreements.

Terms Of Service - Main

Open this page using **Menu > Umbrella Agreement Management > Terms of Service > Search.**

Description of Page

Terms of Service Info contains a concatenation of important information about the terms of service record. **Terms of ServiceID** is the system-assigned unique identifier of the terms of service record. These values only appear after the TOS is added to the database.

The **Umbrella Agreement ID** defines the umbrella agreement to which this terms of service is linked.

Status shows the current state of the terms of service record. The buttons adjacent to the status allow you to transition the TOS record's status.

- Click **Activate** to change the status of a pending terms of service record to active.
- Click **Pend** to change the status of an active terms of service record back to pending.
- Click **Cancel** to change the status of a pending or active terms of service record to canceled.

FASTPATH:

Refer to [Lifecycle Of Terms of Service](#) for more information.

Enter a **Description** for the terms of service record.

The **Terms of Service Type** defines the type of terms of service record. Refer to [Setting Up Terms of Service Types](#) for more information.

Use the **Comments** area to describe anything interesting or unusual about the umbrella agreement.

The **Characteristics** collection contains information that describes miscellaneous information about the terms of service record.

NOTE:

Characteristic Types. You can only choose characteristic types defined on the terms of service record's [terms of service type](#).

The following fields display:

Characteristic Type Indicate the type of characteristic.

Characteristic Value Indicate the value of the characteristic.

NOTE:

Default Note. A terms of service record's characteristics default from the [terms of service type](#).

The **Covered Entities** collection allows you to define specific entities that are "covered" by this terms of service record. Refer to [TOS Covered Entities](#) for more information.

NOTE:

Characteristic Types. You can only choose covered entity characteristic types defined on the terms of service record's [terms of service type](#).

The following fields display:

Covered Entity Characteristic Type Indicate the type of characteristic used to define this covered entity type.

Characteristic Value Indicate the value of the characteristic used to define the covered entity value.

NOTE:

Default Note. A terms of service record's covered entity types default from the [terms of service type](#).

Terms Of Service - SAs

This page is used to maintain the service agreements linked to the terms of service record.

Open this page using **Menu > Umbrella Agreement Management > Terms of Service > Search** and navigate to the **SAs** page.

Description of Page

Terms of Service Info contains a concatenation of important information about the terms of service record. **Terms of ServiceID** is the system-assigned unique identifier of the terms of service record.

The filters control the service agreements that appear in the grid. The following points describe the various options:

- Use the **SA Filter** to define the types of service agreements that appear in the grid. The following options are available:
 - **Account.** Use this option to restrict service agreements to those linked to a given **Account ID**.
 - **Address.** Use this option to restrict service agreements to those linked to service points associated with a given **Address, City** and/or **Postal** code. Note, you can specify any combination of these fields.
 - **All.** Use this option if you do not wish to restrict service agreements based on service agreement attributes.
 - **All Proposals.** Use this option to restrict service agreements to only proposal service agreements.
 - **All Real SAs.** Use this option to restrict service agreements to only "real" service agreements (i.e., not proposal SAs).
 - **Geographic Type.** Use this option to restrict service agreements to those linked to service points associated with a given **Geographic Type** and **Geographic Value**.
 - **SA Type.** Use this option to restrict service agreements to those linked to a given **CIS Division** and **SA Type**.
 - **Specific SA.** Use this option to reference a specific **SA ID**.
- Use **Status Filter** to restrict the service agreements based on their status. Status values for both proposal service agreements and regular service agreements are included in the filter. The following options are available:
 - **All.** This option shows all service agreements, including proposal service agreements, regardless of status.
 - Refer to [Service Agreement Lifecycle](#) for the various status values for real service agreements.
 - Refer to [Proposal SA State Transition](#) for more information about status values for proposal service agreements.

Don't forget to click the search button after changing the filters.

The grid that follows contains the **Service Agreements** that match your search criteria along with its **Account Info**.

Use the "+" to link new service agreements to the terms of service record.

NOTE:

Link SA Using Order. You may also [link a service agreement to a TOS through orders](#) if you have configured an appropriate campaign and package.

Note you may remove a service agreement from the TOS using the delete button as long as the change has not been committed to the database. As soon as the SA's link to the TOS has been committed to the database, you must use the **Remove** action to unlink the service agreement.

The **Select All / Clear All** buttons are used to select service agreements if you plan on issuing the mass update action **Remove** at the bottom of the page. Clicking **Remove** removes the service agreement from the terms of service record.

Overdue Financial Obligations

The system periodically monitors how much your customers owe to ensure they haven't violated your overdue rules. When a violation is detected, the system creates an overdue process. The overdue process contains the events meant to prod the customer to pay (e.g., letters, disconnect field activities, To Do entries, write-off outstanding debt, etc.). This section describes how to manage your overdue (i.e., collections) processing.

NOTE:

The overdue processing module has been designed to collect on virtually anything from an unpaid bill to an unmatched financial transaction. You tell the system what you collect on by configuring the various overdue processing control tables. In this release, the base-package is delivered with the algorithms that support collecting on overdue bills. If your organization practices [balance-forward accounting](#) (i.e., collection is based on overdue service agreement balances), you will not use this functionality. Rather, you will use the functionality described under [Credit and Collections](#).

Overdue Processing Background Information

In the section, [The Big Picture Of Overdue Processing](#), we describe how overdue processing works and how to set up the control tables that automate most functions. You will find that many of your questions regarding when and how overdue and cut processes are created and canceled are described in this section.

Overdue Process Maintenance

An overdue process is a series of events (e.g., letters, To Do entries) meant to encourage an account to pay its delinquent debt. The topics in this section describe the pages on which overdue processes are maintained.

FASTPATH:

Refer to [The Big Picture Of Overdue Processes](#) for background information.

Overdue Process - Main

The Main page contains core overdue process information. Open this page using **Menu > Credit & Collection. > Overdue Process > Search**

Description of Page

NOTE:

Refer to [How To Perform Common Overdue Process Functions](#) for more instructions describing how to use this page.

Overdue Process contains a concatenation of important information about the process. **Overdue ProcessID** is the system-assigned unique identifier of the process. These values only appear after the overdue process is added to the database.

NOTE:

Summary information may be overridden. Refer to [Overdue Process Information Is Overridable](#) for how your implementation can override the summary information that appears throughout the system.

Account ID identifies the overdue process's account.

NOTE:

Multiple overdue processes may be linked to an account. It's important to be aware that it's possible for multiple, active overdue processes to be linked to an account. The [Alert zone](#) will contain a summary of the account's overdue processes.

Status defines the state of the overdue process. The following values may exist:

- Active, Events Pending. Overdue processes are initially created in this state. An overdue process remains in this state until there are no Pending or Waiting events.
- Inactive, Canceled by User. An overdue process will exist in this state when it's been manually canceled by a user. Navigate to the **Log** tab to see when this happened and who did it.
- Inactive, Canceled by System. An overdue process will exist in this state when it's been canceled by the system (typically because the overdue obligations were satisfied). Navigate to the **Log** tab to see when this happened.
- Inactive, Completed. An overdue process will exist in this state when the system completes its last event. Navigate to the **Log** tab to see when this happened.

The **Cancel** button appears if the overdue process is Active, Events Pending and the process's **Overdue Process Template** has a Cancel Logic plug-in. Click this button to [cancel the process](#).

The **Trigger Events** button appears if the overdue process is Active, Events Pending. Click this button to activate all pending events that are [ready for activation](#).

NOTE:

If you can't wait for the Overdue / Cut Event Manager to run. The [Overdue / Cut Event Manager](#) is a background process that activates events on their trigger date. If you don't want to wait for this process to run, you can click the **Trigger Events** button on the **Main** tab to activate the process's events (that are ready for activation).

Overdue Process Template defines the template that was used to [create the overdue process's events](#). You can override these events on the **Events** page. This field is unprotected when the process is Active and all events are in either the Pending or Canceled states.

NOTE:

Changing the template. If you change the template, the system will delete the events and replace them with the new template's events.

Start Date/Time defines the start date/time of the overdue process. This field is protected after the overdue process is saved on the database. This field is used to derive the trigger date of some overdue events when the process is first created. Subsequent changes to the start date change the trigger dates on the events accordingly.

Inactive Date/Time is the date and time that the overdue process became Inactive. This field is hidden if the process is Active. You can see more details about when and how the inactivation occurred by navigating to the **Log** tab.

Base Date is reserved for future releases. This field is protected when the overdue process is Inactive.

Enter any **Comments** about the overdue process. This field is protected when the overdue process is Inactive.

The **Collecting On** grid holds the [overdue objects](#). For example, if this process manages overdue bills, the grid contains a list of the bills being collected on by this process. This grid is unprotected when the process is Active. The following points describe the columns that appear in the grid:

- Press the + button to add a new overdue object to the process.

- Press the - button to remove an overdue object to the process.
- The next column contains the unique identifier of the overdue object. For example, if this process manages overdue bills, this column will contain the bill ID. The type of object that's specified in this column is control by the [overdue process template](#).
- **Original Amount** contains the [original amount](#) of the overdue object.
- **Unpaid Amount** contains the [unpaid amount](#) of the overdue object.

The [Trees](#) at the bottom of the page shows a variety of information about the overdue process including its events and cut processes. You can click on hyperlinked tree nodes to navigate to the page on which the related object is maintained.

Overdue Process - Events

This page contains the activities that are performed to persuade the customer to pay the outstanding debt. Open this page using **Menu > Credit & Collection > Overdue Process > Search** and navigate to the **Events** page.

Description of Page

NOTE:

Refer to [How To Perform Common Overdue Process Functions](#) for more instructions describing how to use this page.

Refer to the first tab for a description of **Overdue Process** and **Overdue Process ID**.

The **Overdue Events** scroll contains the process's overdue events. Refer to [Overdue Processes Are Created From Templates](#) for information about how the system defaults a process's events from its template.

- Note, all information in the scroll is protected if the event's Status is Complete or Canceled.
- **Event Sequence** is the unique identifier of the event.
- **Status** defines the [state of the event](#).
- The **Cancel** button appears if the event is Pending or Waiting, and the event's **Overdue Event Type** has a Cancel Logic plug-in. Click this button to cancel the event.
- The **Overdue Event Type** defines the event's activity (e.g., Email sent, a To Do entry is generated, a letter is sent).
- The remaining fields work in unison:
 - If **Dependent on Other Events** is turned on, the event can only be triggered after the events specified in the **Event Dependencies** grid are all Complete or Canceled. You use the **Days After** field to define when this event is activated. For example, if you enter 5, this event will be activated 5 days after all of the dependent events are completed / cancelled. If you enter 0, this event will be activated immediately after the dependent events are completed / cancelled. Refer to [Calendar vs Work Days](#) for a descriptions of how days are counted.

If all dependent events are already Completed or Canceled , you cannot specify **Days After**. Rather, you must enter the desired activation date in the **Trigger Date** field.

- If **Dependent on Other Events** is turned off, enter the desired activation date in the **Trigger Date** field. If this field is off, the **Days After** field and the **Event Dependencies** grid are hidden.

NOTE:

If you can't wait for the Overdue / Cut Event Manager to run. The [Overdue / Cut Event Manager](#) is a background process that activates events on their trigger date. If you don't want to wait for this process to run, you can click the **Trigger Events** button to activate the process's events (that are ready for activation).

Overdue Process - Log

This page contains [log entries](#) that highlight significant events in the process's life. Open this page using **Menu > Credit & Collection > Overdue Process > Search** and navigate to the **Log** page.

Description of Page

Please note the following about the entries in this grid:

- The system automatically creates log entries when significant events occur. Refer to [Overdue Log](#) for more information.
- You can manually add a log entry to an Active process by pressing the + button and enter the **Details**. You cannot modify or delete this information after saving it.
- The following information appears in the grid:
 - **Date/Time** contains the date and time the log entry was created.
 - **Details** contain the user-specified or system-generated information about the log entry.
 - **Relate Object** is populated on log entries that were created to record the creation of some other object. For example, if an overdue event creates a customer contact, the related object contains information about the customer contact. Please note that if the object description is shown in blue, you can click on the object's description to drill down to the object.
 - **Related Process / Event** appears if the log entry was created by an overdue event, a cut process or a cut event. It references the unique identifier of the process / event.
 - **Log User** contains the user who caused the log entry to be created.
 - **Log Type** indicates how the log entry was created. The possible values are:
 - User. A user manually created this entry.
 - System. This system created this entry.

How To Perform Common Overdue Process Functions

The topics in this section describe how to perform common overdue process maintenance functions. Refer to [The Big Picture Of Overdue Processing](#) for high-level information about overdue processing.

How To Create An Overdue Process

99.9% of all overdue processes are created by the [Overdue Monitor](#) and require no human intervention. The other 0.1% are created by users on-line / real time. The following points describe how to create the 0.1%.

- Use **Control Central** to choose the account that requires a new overdue process.
- After the account is populated on Control Central, choose the **Overdue Process +** option on the account context menu to transfer to the overdue process transaction in add mode for the account.
- After the [Overdue Process - Main](#) page appears, specify the appropriate **Overdue Process Template**. The template is used to default the process's events (the template also controls numerous business rules, for example, when it will be canceled, how it will be canceled, etc). Refer to [How To Change Overdue Events](#) for a description of how you can override these events.
- Enter the overdue object(s) in the **Collecting On** grid. You must define at least one object.

- Save the overdue process.

How To Change Overdue Events

When an overdue process is first created, it has one or more overdue events. The events are the activities that will be performed to persuade the customer to pay the outstanding debt.

The number and type of events that are created when an overdue process is initiated are defined on the overdue process's overdue process template. The following points describe how to add / change / delete events on an overdue process if the defaulted events are not satisfactory.

- Use **Control Central** to choose the account with the overdue process whose events need to be changed.
- After the account is populated on Control Central, choose the **Overdue Process** option on the account context menu to transfer to the overdue process transaction in update mode for the account. Note, an account's Active overdue processes can be selected from the [Alerts zone](#).
- To add a new event, transfer to the [Overdue Process - Events](#) tab and press the + button in the **Overdue Events** scroll. At this point, the event has not been added to the database; rather, it just exists in memory. Before you add the event to the database, you must specify the following information:
 - Choose an **Event Sequence** so that the new event will be positioned properly in respect of the other events.
 - Choose a **Status** of Pending.
 - Choose the desired **Overdue Event Type**.
- If the activation of the new event is dependent on the successful completion of earlier events, turn on **Dep on Other Event** and then:
 - specify the sequences of the dependent events in **Event Dependencies** and
 - specify the how many days after the completion of the last dependent event that the new event should be triggered.
 - If the activation of the new event is NOT dependent on the successful completion of earlier events, turn off **Dep on Other Event** and use **Trigger Date** to define the date on which the event should be activated (i.e., completed).
- To delete an existing event, click on the event in the tree on [Overdue Process - Main](#). This will transfer you to the **Events** tab where you can click the - button to remove the event. At this point, the event has not been removed from the database; rather, it's been removed in memory.
- To change an existing event, click on the event in the tree on [Overdue Process - Main](#). This will transfer you to the **Events** tab where you can make the desired changes.
- After all desired changes have been made, save the overdue process.

How To Cancel An Overdue Process

The system will cancel an overdue process when the [cancel criteria defined on the overdue process are satisfied](#). The following points describe how to manually cancel an overdue process.

- Use **Control Central** to choose the account with the overdue process to be cancelled.
- After the account is populated on Control Central, choose the **Overdue Process** option on the account context menu to transfer to the overdue process transaction in update mode for the account. A list of all overdue processes associated with the account appears. If only one overdue process exists, it is automatically selected for you. Note, an account's Active overdue processes can be selected from the [Alerts zone](#).
- On the **Main** tab, click Cancel and answer any prompts.

Cut Process Maintenance

A cut process contains the activities to stop a service agreement (in the hopes that lack of service will inspire the customer to pay). It should be noted that a separate cut process is created for each service agreement. The topics in this section describe the pages on which cut processes are maintained.

FASTPATH:

Refer to [The Big Picture Of Cut Processes](#) for background information.

Cut Process - Main

The Main page contains core cut process information. Open this page using **Menu > Credit & Collections > Cut Process > Search**.

Description of Page

NOTE:

Refer to [How To Perform Common Cut Process Functions](#) for more instructions describing how to use this page.

Cut Process contains a concatenation of important information about the process. **Cut ProcessID** is the system-assigned unique identifier of the process. These values only appear after the cut process is added to the database.

NOTE:

Summary information may be overridden. Refer to [Cut Process Information Is Overridable](#) for how your implementation can override the summary information that appears throughout the system.

Overdue Process and **Overdue Event** define overdue event that created the process. Refer to [Cut Processes Exist Under An Overdue Process](#) for more information.

Service Agreement identifies the service agreement being cut.

Premise identifies the service agreement's characteristic premise (if any).

NOTE:

Multiple cut processes may be linked to an overdue process / event. It's important to be aware that it's possible for multiple, active cut processes to be linked to the overdue event. You can see all cut processes associated with an overdue process on the tree of [Overdue Process - Main](#). The **Alert zone** will contain a summary of the account's cut processes.

Status defines the state of the cut process. The following values may exist:

- Active, Events Pending. Cut processes are initially created in this state. A cut process remains in this state until there are no Pending or Waiting events.
- Inactive, Canceled by User. A cut process will exist in this state when it's been manually canceled by a user. Navigate to the overdue process's **Log** tab to see when this happened and who did it.
- Inactive, Canceled by System. A cut process will exist in this state when it's been canceled by the system (typically because the overdue obligations on the overdue process were satisfied). Navigate to the **Log** tab to see when this happened.

- Inactive, Completed. A cut process will exist in this state when the system completes its last event. Navigate to the overdue process's [Log](#) tab to see when this happened.

The **Cancel** button appears if the cut process is Active, Events Pending and the process's **Cut Process Template** has a Cancel Logic plug-in. Click this button to [cancel the process](#).

The **Trigger Events** button appears if the cut process is Active, Events Pending. Click this button to activate all pending events that are [ready for activation](#).

NOTE:

If you can't wait for the Overdue / Cut Event Manager to run. The [Overdue / Cut Event Manager](#) is a background process that activates events on their trigger date. If you don't want to wait for this process to run, you can click the **Trigger Events** button to activate the process's events (that are ready for activation).

Cut Process Template defines the template that was used to [create the cut process's events](#). You can override these events on the **Events** page. This field is unprotected when the process is Active and all events are in either the Pending or Canceled states.

NOTE:

Changing the template. If you change the template, the system will delete the events and replace them with the new template's events.

Start Date/Time defines the start date/time of the cut process. This field is protected after the cut process is saved on the database. This field is used to derive the trigger date of some cut events when the process is first created. If you need to subsequently change the trigger date on the events, navigate to the **Events** tab and change the dates manually. Alternatively, you can perform the following "trick":

- Change the **Cut Process Template** to something (anything). Doing this causes the **Start Date/Time** to become unprotected.
- Specify the base date of the cut events in the newly unprotected **Start Date/Time**.
- Change the **Cut Process Template** back to the desired value. When you change the template, the system removes the events and creates new ones using the **Start Date/Time**.

Inactive Date/Time is the date and time that the cut process became Inactive. This field is hidden if the process is Active. You can see more details about when and how the inactivation occurred by navigating to the overdue process's [Log](#) tab.

Enter any **Comments** about the cut process. This field is protected when the cut process is Inactive .

The [tree](#) at the bottom of the page shows a variety of information about the cut process including its events. You can click on hyperlinked tree nodes to navigate to the page on which the related object is maintained.

Cut Process - Events

This page contains the activities that are performed to cut the service agreement. Open this page using **Menu > Credit & Collection > Cut Process > Search** and navigate to the **Events** page.

Description of Page

NOTE:

Refer to [How To Perform Common Cut Process Functions](#) for more instructions describing how to use this page.

Refer to the first tab for a description of **Cut Process** and **Cut Process ID**.

The **Cut Events** scroll contains the process's cut events. Refer to [Cut Processes Are Created From Templates](#) for information about how the system defaults a process's events from its template.

- Note, all information in the scroll is protected if the event's Status is Complete or Canceled.
- **Event Sequence** is the unique identifier of the event.
- **Status** defines the [state of the event](#).
- The **Cancel** button appears if the event is Pending or Waiting, and the event's **Cut Event Type** has a Cancel Logic plugin. Click this button to cancel the event.
- The **Cut Event Type** defines the event's activity (e.g., Email sent, a To Do entry is generated, a letter is sent).
- The remaining fields work in unison:
 - If **Dependent on Other Events** is turned on, the event can only be triggered after the events specified in the **Event Dependencies** grid are all Complete or Canceled. You use the **Days After** field to define when this event is activated. For example, if you enter 5, this event will be activated 5 days after all of the dependent events are completed / cancelled. If you enter 0 (zero), this event will be activated immediately after the dependent events are completed / cancelled. Refer to [Calendar vs Work Days](#) for a descriptions of how days are counted.

If all dependent events are already Completed or Canceled , you cannot specify **Days After**. Rather, you must enter the desired activation date in the **Trigger Date** field.

- If **Dependent on Other Events** is turned off, enter the desired activation date in the **Trigger Date** field. If this field is off, the **Days After** field and the **Event Dependencies** grid are hidden.

NOTE:

If you can't wait for the Overdue / Cut Event Manager to run. The [Overdue / Cut Event Manager](#) is a background process that activates events on their trigger date. If you don't want to wait for this process to run, you can click the **Trigger Events** button on the **Main** tab to activate the process's events (that are ready for activation).

How To Perform Common Cut Process Functions

The topics in this section describe how to perform common cut process maintenance functions. Refer to [The Big Picture Of Cut Processing](#) for high-level information about cut processing.

How To Create A Cut Process

Cut processes are created when an overdue event is activated. You cannot create an ad hoc cut process.

How To Change Cut Events

When a cut process is first created, it has one or more cut events. The events are the activities that will be performed to persuade the customer to pay the outstanding debt.

The number and type of events that are created when a cut process is initiated are defined on the cut process's cut process template. The following points describe how to add / change / delete events on a cut process if the defaulted events are not satisfactory.

- Use **Control Central** to choose the account with the cut process whose events need to be changed.
- After the account is populated on Control Central, choose the **Cut Process** option on the account or service agreement context menus to transfer to the cut process transaction in update mode. Note, an account's Active cut processes can be selected from the [Credit and Collections zone](#).

- To add a new event, transfer to the [Cut Process - Events](#) tab and press the + button in the **Cut Events** scroll. At this point, the event has not been added to the database; rather, it just exists in memory. Before you add the event to the database, you must specify the following information:
 - Choose an **Event Sequence** so that the new event will be positioned properly in respect of the other events.
 - Choose a **Status** of Pending.
 - Choose the desired **Cut Event Type**.
- If the activation of the new event is dependent on the successful completion of earlier events, turn on **Dep on Other Event** and then:
 - specify the sequences of the dependent events in **Event Dependencies** and
 - specify the how many days after the completion of the last dependent event that the new event should be triggered.
- If the activation of the new event is NOT dependent on the successful completion of earlier events, turn off **Dep on Other Event** and use **Trigger Date** to define the date on which the event should be activated (i.e., completed).
- To delete an existing event, click on the event in the tree on [Cut Process - Main](#). This will transfer you to the **Events** tab where you can click the - button to remove the event. At this point, the event has not been removed from the database; rather, it's been removed in memory.
- To change an existing event, click on the event in the tree on [Cut Process - Main](#). This will transfer you to the **Events** tab where you can make the desired changes.
- After all desired changes have been made, save the cut process.

How To Cancel A Cut Process

The system will cancel a cut process when the [cancel criteria defined on the overdue process are satisfied](#). The following points describe how to manually cancel a cut process.

- Use **Control Central** to choose the account with the cut process to be cancelled.
- After the account is populated on Control Central, choose the **Cut Process** option on the account or service agreement context menu to transfer to the cut process transaction in update mode for the account. A list of all cut processes associated with the account appears. If only one cut process exists, it is automatically selected for you. Note, an account's Active cut processes can be selected from the [Credit and Collections zone](#).
- On the **Main** tab, click Cancel and answer any prompts.

Payment Arrangement for Bills

A payment arrangement is an agreement with a customer to payoff severely overdue debt in installments. Bills sent to customers with payment arrangements contain charges for both their current services and their payment arrangement installment amount.

Organizations that practice [open-item accounting](#) who collect on overdue bills may allow customers to pay off their overdue bills in installments by setting up a payment arrangement for one or more bills. This transaction is used to maintain bill-oriented payment arrangements.

FASTPATH:

Refer to [Bill-Oriented Payment Arrangements](#) for background information.

Open this page using **Menu > Credit & Collection > Payment Arrangement for Bills > Search** page.

Description of Page

The **SA** (service agreement) **Info** is a concatenation of important details about the payment arrangement service agreement (PA SA). The **SAID** is the unique identifier of the PA SA. These values only appear after the PA SA exists on the database.

The **Current Balance** that appears beneath **SA Info** contains the PA SA's current balance. When you initially set up a PA SA this balance will be zero. It is only non-zero if the customer has not paid a billed installment.

Payoff Balance beneath **SA Info** contains the PA SA's payoff balance. The payoff balance is the total amount to be paid off over the PA SA's life. It is only non-zero after delinquent funds have been transferred to the PA SA. This balance is only displayed when it differs from the **Current Balance**.

FASTPATH:

Refer to [Current Amount versus Payoff Amount](#) for more information.

Account ID is the account associated with the PA SA.

The occurrences of **Current** and **Payoff Balance** beneath **Account** are the account's respective balances. These values are displayed to help you confirm exactly how much the customer currently owes versus how much they will have to payoff over time (remember, after you transfer funds to a payment arrangement, the amount transferred is reduced from the account's current balance).

The **Unpaid Bills** grid contains a row for each of the account's unpaid bills.

Adjacent to each Unpaid Bill is its **Unpaid Amount** and a check box used to select the bill. Every selected bill's unpaid amount will be transferred to the PA SA when you click the **Create** button.

WARNING:

The system automatically indicates that all unpaid debt should be transferred to the payment arrangement. It does this by checking each bill by default.

Total Candidates is the sum of ALL unpaid bills (not just the selected bills).

New Payoff Balance contains the PA SA's payoff balance. This is the total amount of debt that will be paid off over the lifetime of the PA SA. This value equals the current payoff balance on the PA SA plus all selected debt from the **Candidate SAs** scroll.

The next fields work in unison.

- If you want to define the number of future bills that the customer has to payoff the selected unpaid amount, enter the number of **Installments**. When you tab out of the field, the system sets the **Arrange Amount** equal to **New Payoff Balance / Installments**.

NOTE:

Arrange Amount may not add up. The **Arrange Amount** is rounded up so that if you multiply the number of installments by the calculated installment amount, the result will be greater than the PA SA's payoff amount. Don't worry - only the actual dollar amount of the PA SA's total debt will be billed by the system. The last installment will be slightly lower than the other installments.

- If you want to define the amount charged on future bills to payoff the unpaid amount, enter the **Arrange Amount**. For example, if the customer agrees to pay off their delinquent debt by paying an additional \$50 on each bill, you'd enter "50" in this field. Note - If you enter a dollar amount in this field and tab out, the system will calculate the number of installments and display the number in the **Installments** field.

Define the **CISDivision** and **SA Type** of the payment arrangement service agreement.

NOTE:

Payment arrangement SA types. There is a field on SA type called [Special Role](#). Only those SA types with a role of Payment Arrangement may be selected.

Clicking the **Create** (or **Change**) button causes the system to perform the following:

- It creates / updates a payment arrangement service agreement (PA SA). It sets the installment amount on this service agreement equal to the installment amount specified on the page.
- It transfers unpaid debt from the selected bills to the PA SA. The adjustment type used to transfer these funds is defined on the PA SA's SA type.
- It links the "transfer from" adjustments to the unpaid financial transactions on the bills. This will cause the unpaid FT's to be linked to Balanced match events. This means that any Active Overdue Processes for the bills should Inactivate (i.e., cancel) because the bills will no longer be consider unpaid. Refer to [How Are Overdue Processes Cancelled](#) for more information..
- It reduces the current balance on the PA SA by the amount of debt transferred to the PA SA. Why? Because when delinquent debt is transferred to the PA SA, its current balance increases. Because current balance contains the amount the customer currently owes, this balance must be reduced because the customer is going to pay off the debt in installments (and therefore they don't currently owe anything). The adjustment type used to transfer these funds is defined on the PA SA's SA type.

Clicking **Break** causes the PA SA to become broken. Please refer to the note below for what transpires when a PA is broken.

NOTE:

Break logic is in a plug-in. Please be aware that the logic that is executed when a payment arrangement is broken exists in a plug-in algorithm (plugged-in on the account's [Collection Class Overdue Rules](#)). The base package algorithm performs many functions (refer to [Breaking A Bill Oriented Payment Arrangement](#) for the details). The bottom line is that when a PA SA is broken, the originating bills will have their debt reinstated and this will again be subject to the [Overdue Monitor](#). Because this logic is in a plug-in, you can develop alternative logic and plug it in if the base package logic is not satisfactory.

Clicking **Cancel** causes the PA SA to become canceled. Cancellation should be used when you want to "logically delete" a PA SA because it shouldn't have been created.

The logic described above for breaking a payment arrangement is executed when a user cancels a payment arrangement; the only difference is that the PA SA is marked with a different characteristic type / value than when it is broken.

How To Set Up A Payment Arrangement

To set up a new payment arrangement:

- Open [Payment Arrangement for Bills](#) in add mode.
- Select the **Account** in question.
- Select the debt to be transferred to the payment arrangement (by turning on/off the checkboxes adjacent to the **Unpaid Bills**).
- Enter the number of **Installments** or the **Arrange Amount**.
- Define the **CIS Division** and **SA Type** of the new payment arrangement service agreement.
- Click the **Create** button.

How To Add Additional Debt To A Payment Arrangement

To transfer additional debt to an existing payment arrangement:

- Open [Payment Arrangement for Bills](#) in update mode.
- Select the existing payment arrangement in the search.
- Select the debt to be transferred to the payment arrangement (by turning on/off the checkboxes adjacent to the **Unpaid Bills** amounts).
- Enter the number of **Installments** or the **Arrange Amount**.
- Click the **Change** button.

NOTE:

After transfer. After transferring the funds to the payment arrangement service agreement, confirm the account's payoff and current balances make sense (the payoff balance is the total amount of debt that the account will eventually have to payoff, the current balance is how much they currently owe. The account's payoff and current balances are displayed in the page's second section. If you do not understand the difference between payoff balance and current balance, refer to [Current Amount versus Payoff Amount](#).

How To Break A Payment Arrangement

You would break a payment arrangement when a customer doesn't make the agreed payments. Typically, your overdue processes will break a payment arrangement behind-the-scenes if a customer doesn't pay. Refer to [Breaking A Bill Oriented Payment Arrangement](#) for information about how the system monitors payment arrangements.

If you want to manually break a payment arrangement,

- Open [Payment Arrangement for Bills](#) in update mode.
- Select the existing payment arrangement in the search.
- Click the **Break** button.

How To Cancel A Payment Arrangement

You would cancel a payment arrangement if you made a mistake and never intended to set up the payment arrangement in the first place. To cancel a payment arrangement

- Open [Payment Arrangement for Bills](#) in update mode.
- Select the existing payment arrangement in the search.
- Click the **Cancel** button.

Rebate Claims

The Rebate Claims feature allows you to search, view, and maintain rebate claims submitted as part of a conservation program.

FASTPATH:

For more information about conservation programs, see [Conservation Programs](#).

Rebate Claim Query Portal

You use the Rebate Claim Query Portal to search for rebate claims. Use the following procedure to search for rebate claims:

- Select **Menu > Customer Information > Rebate Claim > Search** to open the Rebate Claim Query portal.
- Enter search criteria in the Rebate Claim Search zone and click **Refresh**. You can search by:
 - Customer Name
 - Account ID
 - Conservation Program
 - Start and End Dates
- A list of rebate claims matching the search criteria appears, displaying the following for each:
 - Claim Date
 - Rebate Claim (Status, Claim Date, Conservation Program, and Total Amount)
 - Account (Name, Customer Class, Current Balance, and Account ID)
 - Total Rebate Amount
- To view a rebate claim, click the **Rebate Claim** link. The selected rebate claim opens in the Rebate Claim portal.

Rebate Claim Portal

You use the Rebate Claim portal to view, edit, and maintain rebate claims. To add a rebate claim, open **Menu > Customer Information > Rebate Claim > Search**.

The topics in this section describe the base-package zones that appear on the Rebate Claim portal.

Rebate Claim Zone

You use the Rebate Claim zone to view the details of rebate claims. The Rebate Claim zone opens when you first create a new rebate claim, or when you select a rebate claim on the Rebate Claim Search zone. The Rebate Claim zone displays the following information about the selected rebate claim:

- Basic Information: information about the claim, including:
 - Conservation Program
 - Status (Pending, Issue Detected, Approval in Progress, Receipt Verification, Complete, or Canceled)
 - Rebate Claim number
 - Claim Date
 - Total Rebate Amount
- Customer Details: details about the customer who submitted the claim, including:

- Person
- Account
- Premise
- Mailing Address
- Contact Details: contact information for customer who submitted the claim, including:
 - Name
 - Phone Number
 - Fax Number
 - Email Address
- Premise Information: information about the physical premise of the customer who submitted the claim, including:
 - Premise Property Type
 - Residential Property Type
 - Building Vintage
- Payment Release Authorization Details: details about the person to whom the rebate payment should be made, including:
 - Authorized By
 - Authorization Date
 - Payee Name
 - Phone Number
 - Mailing Address
- Issue Details: issues related to the rebate claim, including manually submitted issues as well as those detected through the Verify action.
- Approval Details: details related to users assigned to approve the rebate claim, including:
 - Current Approver
- Reject Details: details related to why a claim was rejected, including:
 - Reject Reason
 - Date Rejected
 - Rejected By

To view a different rebate claim, select the rebate claim from the **Select a Rebate Claim** drop- down list and click **Go**.

Rebate Claim Status

Rebate claims are assigned a status to indicate the current state of the claim within the system. Valid statuses include:

- **Pending** indicates the claim is pending. This is the initial state of a rebate claim when first created.
- **Issue Detected** indicates that one or more issues have been detected with the claim. Issues can include those manually created as well as issues detected through the Verify action.
- **Approval in Progress** indicates the claim is awaiting approval.
- **Receipt Verification** indicates that receipts associated with the rebate claim's claim lines need verification.
- **Complete** indicates the claim was approved and is complete.

- **Rejected** indicates the claim was rejected.
- **Canceled** indicates the claim has been canceled.

Rebate Claim Actions

You can perform a number of actions on a rebate claim, including:

- **Edit:** Used to edit the details of the rebate claim.
- **Verify:** Used to verify the supplied details of the rebate claim, and change its status to either Approval in Progress (if the claim passes the verification) or Issue Detected (if any issues are detected). This helps ensure the rebate claim has been properly set up.
- **Approve:** Used to approve a submitted rebate claim, and change its status to Complete or Receipt Verification (if receipts had not been previously verified).
- **Reject:** Used to reject a submitted rebate claim, and change its status to Complete.
- **Issue Detected:** Used to note an issue related to the rebate claim, and change its status to Issue Detected.
- **Cancel:** Cancels a rebate claim, changing its status to Canceled.

The actions available are based on the current status of the rebate claim. The table below summarizes the actions available at each status.

Status	Valid Action
Pending	Edit, Verify, Issue Detected, Cancel
Issue Detected	Edit, Verify, Cancel
Approval in Progress	Approve, Reject, Issue Detected
Receipt Verification	Issue Detected
Completed	None
Rejected	Issue Detected
Canceled	None

Editing Rebate Claims

Use the following procedure to edit a rebate claim:

- Click **Edit**.
- Edit the details of the rebate claim as needed.
- Click **Save**.

Verifying Rebate Claims

To verify a rebate claim, click **Verify**.

Approving Rebate Claims

To approve a rebate claim, click **Approve**.

Rejecting Rebate Claims

Use the following procedure to reject a rebate claim:

- Click **Reject**.
- Select the **Reject Reason** on the Reject Rebate Claim dialog.
- Click **OK**. To close the dialog without rejecting the claim, click **Cancel**.

Noting Issues Related to a Rebate Claim

Use the following procedure to note an issue related to a rebate claim:

- Click **Issue Detected**.
- Enter details about the issue in the Comments field of the Issue Comments dialog.
- Click **OK**. To close the dialog without saving the comment, click **Cancel**.

Canceling Rebate Claims

Use the following procedure to cancel a rebate claim:

- Click **Cancel**.
- Select the **Cancel Reason** on the Cancel Rebate Claim dialog.
- Click **OK**. To close the dialog without cancelling the rebate claim, click **Cancel**.

Adding Rebate Claims

You can also add rebate claims from the Rebate Claim Query portal. Use the following procedure to add a rebate claim:

- Select **Menu > Customer Information > Rebate Claim > Add**, or click **Add** on the title bar of the Rebate Claim Search zone. The user is navigated to Control Central to select the customer filling the rebate claim. Click **Continue** once the correct account is in context.
- Select the Conservation Program associated with the rebate claim and click **OK**.
- Complete the Rebate Claim details, including:
 - Claim Date for the rebate claim
 - Customer Details
 - Contact Details
 - Premise Information

- Payment Release Authorization Details
- Click **Save**. The rebate claim is displayed on the Rebate Claim portal.
- Edit the claim as needed in the Rebate Claim zone.
- Add claim lines to the claim using the Rebate Claim Line zone.

Rebate Claim Line Zone

You use the Rebate Claim Line zone to add, view, and edit rebate claim lines associated with a rebate claim. A rebate claim can have one or more claim lines, one for each item for which a rebate is requested. For example, if a customer purchases new energy efficient appliances (such as a washing machine and dryer), the rebate claim they submit would have a rebate claim line for each appliance. The Rebate Claim Line zone displays the following details for each claim line:

- Rebate Definition
- Manufacturer/Model
- Rebate Amount
- Icons to Edit, Delete, and Verify claim lines

Adding Rebate Claim Lines

Use the following procedure to add a rebate claim line to a rebate claim:

- Click **Add Rebate Claim Line** in the title bar of the Rebate Claim Line zone.
- Select the **Service Agreement** associated with the claim line from the dropdown list.
- Select the **Rebate Definition** for the claim line from the dropdown list. This list is filtered based on the Conservation Program associated with the rebate claim.
- Select the **Manufacturer/Model** for the claim line from the dropdown list. This list is filtered by the Rebate Definition selected.
- Enter the **Install Date** for the claim line.
- Enter the **Number of Units** being claimed.
- Click **Save**. To return to the Rebate Claim Line zone without adding the claim line, click **Cancel**.

Deleting Rebate Claim Lines

Use the following procedure to delete a rebate claim line from a rebate claim:

- Click the delete icon for the claim line you wish to delete.
- Click **OK** on the Confirm Delete dialog. To close the dialog without deleting the claim line, click **Cancel**.

NOTE:

You can delete a rebate claim line only when the rebate claim is in Pending status.

Editing Rebate Claim Lines

Use the following procedure to edit an existing rebate claim line on a rebate claim:

- Click the edit icon for the claim line you wish to edit.
- Edit the details of the claim line as appropriate.
- If you are revising the data based on updated information, check the **Data Revised** checkbox and select the reason for the revision from the **Data Revised Reason** dropdown list. The **Original Data Details** section displays the data originally entered for the claim line.
- If the claim line contained bad data, check the **Bad Line** checkbox and select the reason for the revision from the **Bad Line Reason** dropdown list. The **Original Data Details** section displays the data originally entered for the claim line.
- Click **Save**. To return to the Rebate Claim Line zone without changing the claim line, click **Cancel**.

NOTE:

You can edit a rebate claim line only when the rebate claim is in Pending status. In addition, you cannot edit a rebate claim line after it has been verified.

Verifying Rebate Claim Lines

Use the following procedure to verify a rebate claim line on a rebate claim:

- Click the **Verify** button for the claim line you wish to verify.
- Verify that the details of the claim line match the submitted receipts.
- Click **Verify**. To return to the Rebate Claim Line zone without adding the claim line, click **Cancel**.

NOTE:

You cannot edit a rebate claim line after it has been verified.

Rebate Claim Log Zone

This is a standard [log zone](#). You use the Rebate Claim Log zone to view logging details associated with a rebate claim.

Adding Rebate Claim Log Entries

Use the following procedure to add a rebate claim log entry:

- Click **Add Log Entry** in the title bar of the Rebate Claim Log zone.
- Enter the log entry details in the Add Rebate Claim User Log dialog.
- Click **OK**. To close the dialog without saving the log entry, click **Cancel**.

Communications

Device Events

About Device Events

Device events are developments that have taken place relative to a device, and can include power outages, power restorations, tampering alerts, command completions, among others.

Attributes used to define device events include the following:

- **Device Event Date/Time:** the date and time of the event. This date/time is flexible in its interpretation. For single events it is the moment the event took place. For events that are paired, like a power up and a power down, it will represent the start of the event when received with the first of the pair and the end of the event when received with the second of the pair. For an event that includes the duration, where the device event end date/time is also supplied, this date/time represents the start date/time.
- **Device Event End Date/Time:** the end date and time of events with durations. This will only be populated if the device event date/time is also populated.
- In addition, device events also reference details specific to the head-end system that sent the event, including the following:
- **Sender:** the head-end system (defined as a service provider in Oracle Utilities Smart Grid Gateway) from which the event was sent.
- **External Sender ID:** the external ID for the head-end system that sent the event.
- **External Event Name:** the external, head-end-specific name for the event. This name is translated into a "standard" event name within Oracle Utilities Smart Grid Gateway.
- **External Source Identifier:** an identifier for the source of the event.

Standard Event Names

When the system is loading a device event, it first determines which head-end system sent it, and then determines which device produced it. The system then maps the device event name sent by the head-end system to a standard event name that corresponds to the event. Standard event names are beneficial because the event names sent by head-end systems vary, even when the events are essentially the same. What one head-end system calls "Primary Power Down," another system may call "Last Gasp." Creating a standard event name, such as "Power Outage - Device," makes it easier to send the device events to an external system such as Oracle Utilities Network Management System. In this way, the external systems that receive the events do not need to be configured to accept all of the possible names for a single type of event.

Refer to [Understanding Device Event Types](#) for additional information about how the device events are mapped using standard event names.

Processing Device Events

Device Events received from external systems are processed through two major stages:

- **Device Event Seeder:** This is the common interface point that receives all device event information and performs critical validations and conversions. During this process the device event seeder identifies the appropriate specific device event

business object for further processing. The choice is made based on the originating external system and the type of event being received. For example, a device event for a "Last Gasp" would result in the paired event first device event being selected.

- If for some reason the device event seeder encounters an error an instance of the device event eeder will be created to manage the resolution of that error.
- **Specific Device Event:** Each specific device event has the appropriate logic for the type of event that has been received. A tamper event might create a service issue monitor while a "Last Gasp" might create an outage activity.

Device Event Seeder Processing

The device event seeder receives device event data in a common structure, however, the content of the data (identifiers, date/times, etc) can vary depending on the system and the particular device that generated it. To accurately translate the external content to values understood by the system the device event seeder leverages the configuration of the service provider (aka head end or external system) and the device.

The service provider specifies the following inputs into device event seeder processing:

- **Identifier Types:** Each device event must identify the device the event has been generated from. The system supports a multitude of identifiers for the device. The service provider configuration specifies which identifier type is used for the device which enables the device event seeder to search for the correct destination for the device event. For example, a service provider might indicate that devices are identified by a serial number.
- **Date/Time Format:** The service provider configuration will identify whether the date/times that were sent included specific time zone designations. This allows the system to accurately handle any time zone conversions that may be necessary.
- **Processing Methods:** A service provider has the following processing methods that are used in the evaluation of the device event:
 - Device Event Mapping - Maps a given external device event name to a standard event name. That standard event name is eventually used to identify the appropriate device event for specific processing.
 - Time Zone Translation - Identifies the extendable lookup to be used in mapping the service provider specific time zone to the interval time zone.

The device specifies the following inputs into IMD Seeder processing:

- **Incoming Data Shift:** This value is either specified directly on the device or can be defaulted via fallback on the device type. It identifies whether the incoming date/time information has is "Shifted" meaning it has been adjusted for Daylight Savings Time (DST) when in effect, or it is "Not Shifted" which means it will never be adjusted for DST. This plays an important role in the date/time processing since all incoming device event date/times will be stored without an adjustment for DST.

With these inputs the device event seeder is able to translate the external identifiers into the appropriate identifiers to tie the device event to the originating device in the system..

Device Event Seeder Critical Validations

For device events to continue on to specific device event processing they must pass the critical validations:

- The device must be identified.
- The device event must have an event date/time.

If either of the critical validations fails the device event processing will be halted and an instance of the device event seeder will be created

Note: There is special logic that exists for handling the situation where either the device event date/time or the device event end date/time falls on the duplicate hour that occurs when a time zone transitions out of daylight savings time.

Device Event Seeder Time Zone Translation and Conversion

To provide the most accurate tracking of device events all device event data is stored in a single time zone without an adjustment for Daylight Savings Time (DST). As utilities can have multiple head end systems that each send date/time information in different ways and some utilities operate in multiple time zones the device event seeder contains functionality to convert incoming date/times from a source time zone into the time zone of Oracle Utilities Meter Data Management (as indicated by the base time zone)

There are three components to identifying the source time zone of the incoming device event:

- **Service Provider IMD Import Date/Time Format:** When the device event date/times are sent in a format that identifies the time zone for each date/time the date/times will be delivered to the device event seeder already converted.
- **Incoming Data Shift:** This indicates whether the date/times will be adjusted for DST while it is in effect. A value of "Always in Local Time" indicates that the date/times are adjusted for DST. A value of "Always in Standard Time" indicates that the date/times are not adjusted for DST
- **Time Zone:** The time zone of the incoming data is identified using the follow order of precedence:
 1. The time zone as indicated by the device event data
 2. The service point time zone
 3. The device configuration time zone
 4. The base time zone

Once the time zone and the data shift of the incoming date/times is identified all date/times will be converted from that time zone and shift into the base time zone in standard time.

Specific Device Event Processing

Types of Device Events

Standard

Momentary device events, such as a tamper alert, are processed using the standard device event. These device events do not provide any special processing.

Paired Device Events

Device events with a duration are defined using paired event device events: paired event first and paired event last. With the first of the pair representing the start of the event, and the last of the pair representing the end of the event. Events of this type can be configured to create or complete activities that represent the event. For example, a "Last Gasp" event might create an outage activity that is completed when "Power Restoration" event is received.

When pairs of events arrive in rapid succession (such as a last gasp followed quickly by a power restoration), these "paired event" business objects are designed to prevent them from being sent to subscribing applications.

Communication Response

The communication response is a special type of event used for head end systems that respond to smart meter commands with device events. When received these events create a communication in that will initiate the completion of the originating smart meter command.

Refer to [About Communication In](#) for more information on a communication in.

Sending Device Events to Subscribing Systems

When device events are received, they are typically passed onto to another subscribing system, such as Oracle Utilities Meter Data Management, a customer information system (such as Oracle Utilities Customer Care and Billing), an outage system (such as Oracle Utilities Network Management System), or some other application.

The means of sending device event information to subscribing system is defined in the "How to Send Device Event Related Information" processing method for the service provider representing the subscribing system. Device event information can be sent via outbound communication business object, outbound communication, or batch process.

The method for sending device events to subscribing systems (business object, outbound message, or batch process) can be defined for each device event category, and can be overridden for individual device event types (including the ability to exclude specific device event types within a category). In addition, a default event processing method can be also be configured that applies when methods of transmission aren't specified at the individual category level.

The "Subscribe to Device Event" business service is used to process device event subscription requests, and allow external applications to manage the categories of events they receive.

Refer to [About Device Event Notification Suppressions](#) for more information on a suppression device event notifications.

Creating Service Issue Monitors and Service Investigative Orders

Device events can be configured to create service issue monitors and service investigative orders. The service issue monitor type to create is defined on the device event type. When a device event is received, an Enter algorithm on the device event's Processed state creates the service issue monitor, based on the Service Issue Monitor Type specified for the device event type.

Refer to [Understanding Service Task Types](#) for more information on configuring service issue monitor types.

Device Event Prioritization

By default, device events are created and/or received into the system in an initial state is "Pending" and are transitioned to subsequent states via the batch processing. This batch processing can be skipped by setting the Execution Method flag on the device event to "Real Time" (DIRT), in which case an Enter algorithm transitions the device event to the next state in its lifecycle immediately. This feature can be used to prioritize processing of certain types of device events.

The Execution Method flag can be set in in unsolicited device events sent from the head-end system, or can be inserted during Oracle Utilities Smart Grid Gateway Adapter processing.

Oracle Utilities Smart Grid Gateway Adapters set this flag to "Real Time" on all device events created as the result of smart meter commands.

Activities

About Activities

Activities cover a range of functional process within the system from smart meter commands, synchronization of consumption between related measuring components, service order management activities, and statistics and aggregations.

The table below provides the full list of activity type categories supported and a brief description of how they are used:

Activity Type Category	Activities of this type category are used to
Bulk Activity	Initiate a smart meter command for a group of meters using Oracle Utilities Smart Grid Gateway

Command Request	Initiate a smart meter command for an individual meter using Oracle Utilities Smart Grid Gateway
Consumption Sync	Trigger related measuring component estimation synchronization
Device Event Activity	Represent a device event. These are used when viewing usage and events with the Oracle Utilities Meter Data Management 360 Degree View.
Dimension Scanner	Trigger dimension scanning when aggregating usage, statistics, and other data.
Error Activity	Represent errors in activity processing.
Extract Request	Retrieve usage and device events from a head-end system using Oracle Utilities Smart Grid Gateway
Field Activity	Initiate field work via a message to an external field work system. Activities of this type are most often created by a request orchestration activity.
Meter Read Download Activity	Download a list of meters to be read.
Multi Device Command Request	Initiate a smart meter command for multiple meters (for head-end systems that support multi-device commands) using Oracle Utilities Smart Grid Gateway
Non-Dispatchable Activity	Represent steps or stages in a larger process in which the system is waiting for a resolution from another system. Examples include "Wait for Measurement" or "Wait for Scheduled Read."
Orchestration Maintenance	Update or cancel an active service order activity.
Payload Statistics	Calculate processing statistics for usage and device event import processing
Request Orchestration	Orchestrate the steps necessary to fulfill a service request, based on the current state of the service point related to the request.
Suppression	Suppress sending of device events to subscribing systems (such as Oracle Utilities Network Management System)
Usage Transaction Correction Processor	Trigger correction processing for usage transactions when corrected usage is received that would impact an existing usage transaction

Maintaining Activities

The Activity portal is used to maintain activities.

Refer to About Activities for additional functional information.

You can access the portal from the **Main > Communication > Activity**. You are brought to a query portal with options for searching. Once your record has been selected you are brought to the maintenance portal to view and maintain the selected record.

This portal includes the following zones:

- **Activity:** defines the basic attributes of the Activity
- **Activity Hierarchy:** a tree that displays the activity and related activities (including field activities and smart meter commands), inbound and outbound communications, and completion events.

Communications

About Communication Out

These transactions are typically created from an activity and are tasked with sending a message to an external system. They follow one of two communication patterns:

- Two-way: these messages are sent to the external system without an expectation of an immediate response, or a response is received but it is only an acknowledgement of a successful receipt of the message. The true response to the message is expected to be received in a process detached from the communication out. For the full lifecycle of the communication to be complete a communication in must be received.
- One-way: these messages are sent to the external system and responded to in full within a single transaction. No communication in will be received.

The format of the message sent to the external system is typically driven by a processing method for that external system and the transportation method is controlled by the external system's message options.

If an error is encountered sending the message to the external system the communication out can perform automated retry of the messages for a configurable rate of retry and number of retry attempts.

For one-way communications the communication out will be responsible for creating the completion event.

Once the message has been communicated and a response received the outbound communication will update the initiating activity with the result.

NOTE:

Refer to the following topics for additional information on communications functionality:

- [Understanding Processing Methods](#) for additional information on how processing methods are configured.
- See [About Completion Events](#) for details on completion events.
- See [External Systems](#) in the Oracle Utilities Application Framework *Administrative User Guide* for additional information on configuring communication between your system and external systems.

About Communication In

These transactions represent a message sent from an external system and are received in two situations:

- In response to a communication that had been sent to the external system. This is the most common usage of the communication in.
- An unsolicited message received from an external system such as a real time event. Note: this is not a common pattern.
- Upon receipt the communication in will link itself to the communication out that initiated it. The response message will then be validated to ensure that it is technically and functionally correct.
- For many smart meter commands and field activities executed by service order management the communication in is responsible for creating the appropriate completion events. For example, if the response was for the On Demand Read smart meter command a completion event will be created that will generate the appropriate initial measurement data.
- Similar to the communication out a communication in that encounters an error can perform an automated retry with a configurable rate of retry and number of retry attempts.

Maintaining Communications

The Communication portal is used to maintain communication in and communication out records.

Refer to [About Communication Out](#) and [About Communication In](#) for additional functional information.

You can access the portal from the **Main > Communication > Communication**. You are brought to a query portal with options for searching. Once your record has been selected you are brought to the maintenance portal to view and maintain the selected record.

This portal includes the following zones:

- **Communication**: defines the basic attributes of the Communication

- **Communication Hierarchy:** a tree that displays the communication and related activities (including field activities and smart meter commands), inbound and outbound communications, and completion events.

Completion Events

About Completion Events

Completion events are used to implement the outcome of an activity. They are created by either the communication out (for one-way communication) or the communication in (for two-way communication). Completion events are executed by the activity orchestrating the communication with the external system.

Some examples of the tasks a completion event will perform are:

- Commissioning, decommissioning, connecting, disconnecting a smart meter
- Installing or Removing a meter or item
- Creating initial measurement data
- Updating a device or service point

Maintaining Completion Events

The Completion Event portal is used to maintain completion events.

Refer to [About Completion Events](#) additional functional information.

You can access the portal from the **Main > Communication > Completion Event**. You are brought to a query portal with options for searching. Once your record has been selected you are brought to the maintenance portal to view and maintain the selected record.

This portal includes the following zones:

- **Completion Event:** defines the basic attributes of the Completion Event
- **Completion Event Related Objects:** displays data related to the completion event such as a device, service point, or initial measurement.

NotificationSuppressions

About Device Event Notification Suppressions

When a device event is processed by the system it can be sent to one or many external applications interested in being notified about the event. A prime example of this is the Outage Management System subscribing to any device events related to a meter either losing power or regaining power.

There are situations, such as a field worker performing maintenance on a meter or on a node that impacts many meters, that will result in a large amount of device events being created, processed, and distributed to subscribers.

Device event notification suppressions provides a way for a subscribing system, in anticipation of scheduled maintenance, to suppress notification of certain device events (power down, power up, tamper, etc) from one or more meters.

Maintaining Notification Suppressions

The **Activity** portal is used to maintain notification suppressions records.

Refer to [About Device Event Notification Suppressions](#) for additional functional information.

You can access the portal from the **Main > Communication > Notification Suppression**. You are brought to a query portal with options for searching. Once your record has been selected you are brought to the maintenance portal to view and maintain the selected record.

This portal includes the following zones:

- **Activity:** defines the basic attributes of a notification suppression activity

Integrations

Business Flags

About Business Flags

Business flags provide a view into the status of a service point across applications (e.g. Oracle Utilities Meter Data Management, Oracle DataRaker, Oracle Utilities Customer Care and Billing). Business flags are currently available in two forms:

- **Service Point Business Flags:** are often informational in nature but also allow for manual investigation to be taken.
- **Service Point Monitor Business Flags:** are seen as symptomatic of an issue that needs to be investigated. These business flags feed into a service issue monitor and may result in a service investigative order being created.

For additional details see [About Business Flags](#) in the Oracle Utilities Application Framework *Administrative User Guide*.

Business Flag Allowed Actions

Allowed actions are implemented presented to the user as selectable options that will guide the user through a particular method of investigating or resolving the business flag. The following actions are supported:

- **Create Field Activity:** This will initiate a field activity associated to the business flag's service point. The type of field task will be selected by the user. Note: this option requires Oracle Utilities Service Order Management.
- **Request Customer Notification:** This will initiate a message to the appropriate external system (e.g. Oracle Utilities Customer Care and Billing) that will identify a notification to be sent to the customer. The type of communication will be determined by the notification type selected by the user.

Note: not all business flags support allowed actions and not all business flags that support allowed actions support all allowed actions.

Maintaining Business Flags

Information for this functionality is available in the [Business Flags](#) section in the Oracle Utilities Application Framework *Administrative User Guide*.

Aggregations

Standard Aggregations

About Aggregations

Aggregations are measurements that represent a summarization of other measurements from a set of devices, items, and/or measuring components. For example, an aggregation may be based on the sum of the electric consumption of all residential customers in a particular postal code within the utility's service territory. The group of related measuring components for which measurements are summarized are referred to as constituent measuring components.

Every type of aggregation has one or more dimensions. For example, an aggregation might be defined with three dimensions as follows:

- Substation
- Feeder
- Transformer

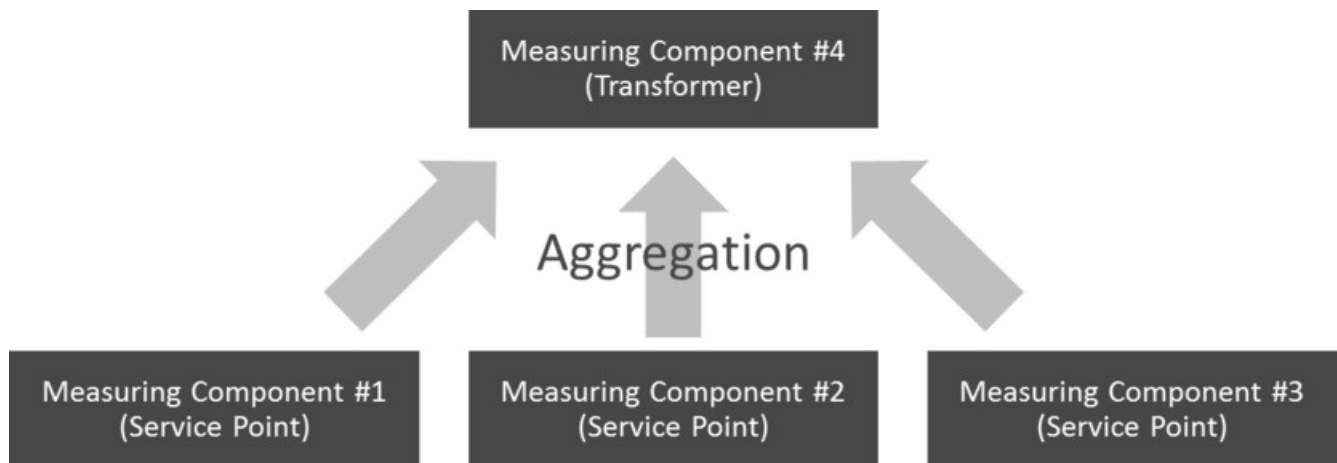

Aggregations are defined by aggregator measuring components. A separate aggregator measuring component should be defined for every distinct combination of dimensions for a given type of aggregation. For example, the transformer aggregation described above would require an aggregator measuring component for every distinct combination of substation / feeder / transformer found among the electric Service Points.

Aggregations can also be aggregated. For example, the aggregator measuring components for each substation / feeder / transformer combination can in turn be used to aggregate consumption at each substation / feeder combination. In this case, a distinct aggregator measuring component would be defined for each unique substation / feeder combination. Likewise, the aggregator measuring components for each substation / feeder combination could be used to aggregate consumption at each substation, in which case, distinct aggregator measuring components would be defined for every unique substation. Finally, the aggregator measuring components for each substation can be used to aggregate total consumption for all substations, with an aggregator measuring component defined to represent the entire service area.

Aggregation Calculations

The system periodically aggregates consumption via batch process, using a deferred monitor on the aggregator measuring components. In addition, users can re-aggregate data in real-time if they don't wish to wait for the batch process, or if the original aggregation needs to be re-calculated due to incorrect data. Users can also create ad hoc aggregations "on the fly" and these will persist in the database in the same manner as other aggregations.

Understanding Aggregation Periods

The start and end dates and times for aggregation calculations are based on the following:

- Aggregation Horizon
- Aggregation Lag
- Aggregation Cut Off Time

Whenever aggregation is performed for an aggregator measuring component, consumption is aggregated for every day in its "Aggregation Horizon." The "Aggregation Horizon" is the number of days during which there's a potential change in measurement data for one or more of the measuring components associated an aggregator measuring component.

Aggregation calculations typically lag behind the current date by a few days to give the system time to upload and perform validations and create final measurements. The amount of lag time is referred to as the "Aggregation Lag" and is the number of days between the date on which aggregation calculations are performed and the end date of the aggregation period. This defines the time period between the aggregation calculation date and the end of the aggregation horizon that serves to allow all measurements to arrive. This together with the Aggregation Horizon is used to determine the start and end dates of an aggregation period. For example, with an Aggregation Horizon of 5 and an Aggregation Lag of 2, aggregation calculations performed on January 9 would be for an aggregation period of January 3 through January 7. The next day (January 10), the aggregation period would shift to January 4 through January 8.

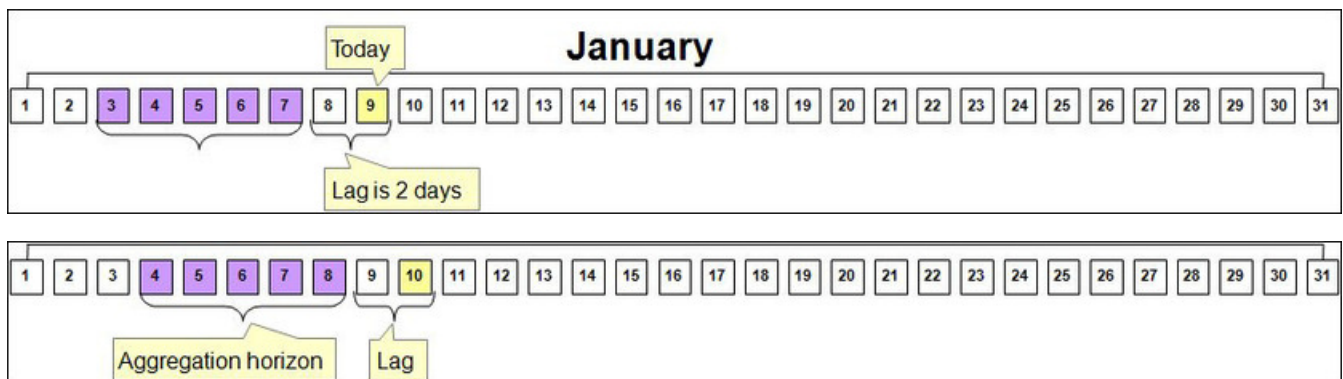

Aggregation is always performed through a given "through time" (such as 12:00 AM) rather than through the actual time of the aggregation calculation. This time is referred to as the "Aggregation Cut Off Time." For example, the stop time for aggregation calculations with an Aggregation Lag of 2, and an Aggregation Cut Off Time of 10:00 PM will always be 10:00 PM 2 days prior to the date on which the calculations are performed. In the above examples, aggregations performed on January 9 would have an end date/time of 10:00 PM on January 7, and aggregations performed on January 10 would have an end date/time of 10:00 PM on January 8.

Aggregation and Re-Aggregation

The use of the aggregation horizon means that aggregated totals for some days will be re-aggregated until those days are no longer covered by the aggregation horizon. For example, with an aggregation horizon of 5 days and an aggregation lag of 2 days, on the night of January 9 the aggregation period would be January 3 through January 7 (as in the above example).

On the night of January 10, the horizon will shift 1 day (to January 4 through January 8, again as above). This means the following:

- The totals for January 3 calculated on January 9 will be untouched (January 3 now falls outside the aggregation horizon)
- The totals for January 4 through January 7 will be re-derived because corrections may have occurred (and they still fall within the aggregation horizon)
- The totals for January 8 will be calculated for the first time (because it now is within the aggregation horizon).

Manually Read Meters and Aggregation Lag

Aggregations that include manually read meters often have much longer aggregation lags than those for automatically read meters. This allows more time for manual meter readings to be imported into the system for use in aggregations.

For example, suppose a situation where manual meter reads arrive approximately 1 month after the date of the reading. In this case, it wouldn't be until a meter read upload on February 7 that the last manual reads including consumption from January 6 will exist. Since we don't want to perform aggregations for January 6 until there's a decent chance that all consumption for that date exists, an aggregation lag of 32 days ensures that the data for January 6 is in the system when the aggregation is performed on February 7.

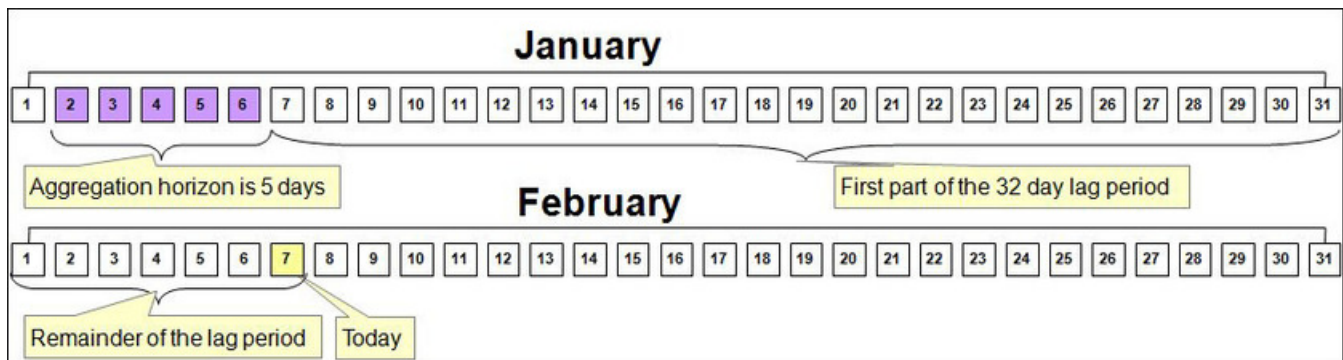

When An Aggregator Measuring Component Contains Both Manual and AMI Measuring Components

The previous section suggests that if an aggregator measuring component contains both manually read and AMI measuring components, the aggregator measuring component should have a long lag time rather than the short time shown in the earlier example.

While this is one possible approach, an alternative approach could allow users to see timely aggregations of the AMI channels and only lag the manual channels. To do this they could configure the system as follows:

- Create an aggregator measuring component that only aggregates manual measuring component types (horizon: 5 days, lag: 31 days)
- Create a separate aggregator measuring component that only aggregates interval measuring component type: 5 days types (horizon: 5 days, lag: 2 days)
- Create a third aggregator measuring component that aggregates the above aggregator measuring component types (horizon: 5 days, lag 31 days)

Expanding The Aggregation Horizon Periodically

Even with a 30-ish day aggregation lag, it's possible for an account with several months of estimated consumption to have its consumption "invalidated" when real readings arrive whose dial readings are less than the estimated readings (or when major retroactive data change takes place). Another similar situation is when a user manually corrects consumption after the aggregation horizon has moved forward.

To address situations like these, the use of ad-hoc aggregations with a user-specified aggregation horizon supports the notion of periodically (such as once a month or once a week) aggregating with a long aggregation horizon (up to 90 days) to catch as many retroactive changes as possible.

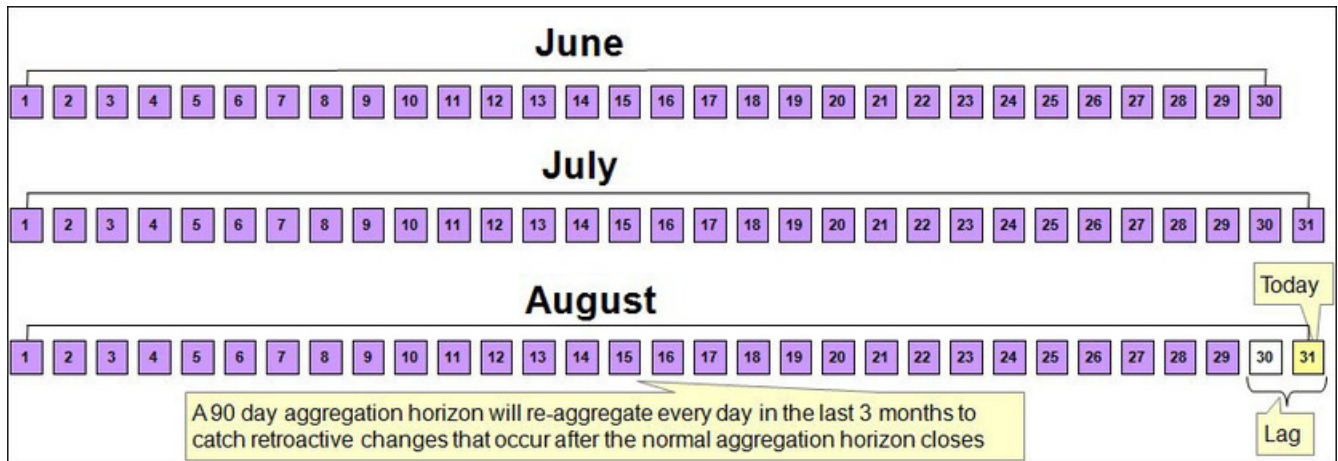

A Note About Using Non-Effective Dated Dimensions

Be aware that whenever aggregation takes place, the system uses master data that exists as of that date. For example, if an aggregation is performed using non effective-dated master data attributes (for example, aggregating by measuring component type) and a measuring component's type is changed, all days in the aggregation horizon will reflect the change regardless of when the user makes the change, because the measuring component type relationship is not effective-dated.

The impact of this depends on the nature of the change:

- If the master data was wrong, this provides a way to re-aggregate the data to accurately reflect the master data.
- If the change occurred effective as of a given date (but there's no effective dated attribute), this can result in incorrect aggregation values.

Because of this, it is recommended that where possible dimensions used in aggregations be effective-dated.

For information on configuration, reference the related section for [Aggregations](#) in the Administration Guide.

Creating Aggregators

There are two ways in which aggregator measuring components are created:

- Automatically: The system will periodically create new aggregator measuring components when new "dimensional values" are detected. For example, if a new substation is added to the system, a new aggregator measuring component will be created for the substation.
- Manually: An end-user can create an aggregator measuring component at their discretion

Automatic Creation of Aggregator Measuring Components

The system automatically creates aggregator measuring components when it detects new instances of the dimension(s) being aggregated. This activity is referred to as dimension scanning. For example, if the system is configured to aggregate individual substations, a user will NOT have to manually set up an aggregator measuring component when a new substation is referenced on a service point. Rather, the system will create the new aggregator when it detects a substation on a service point that doesn't have an aggregator measuring component.

Similarly, if is configured to aggregate distinct combinations of rate class (on usage subscription type) and postal code (on service point), the system will create an aggregator measuring component when it detects new combinations of rate class and postal code.

The periodic monitoring to ensure sufficient aggregation measuring components exist is implemented via monitoring algorithms on a related activity business object that references a corresponding measuring component type. This means

that there must be a separate activity type / activity combination for every type of aggregation performed. These monitor algorithms include:

- A Monitor algorithm on the Active state that simply transitions the activity to the transitory Scan state. Users can manually transition the activity to the Scan state by clicking the "Scan" button on the activity.
- An Enter algorithm on the Scan state finds the distinct combinations of dimensional values for this type of aggregation and checks that an aggregator measuring component that references the activity's aggregator measuring component type exists for every instance and creates new aggregator measuring components as appropriate. The algorithm also populates the dimensional values on the new measuring components (mapped to searchable characteristics), and sets the Consumption Aggregated Through Date/Time field on the new aggregator measuring components to the current date and the Aggregation Cut Off Time on the aggregator measuring component type.

Hard-Wiring Service Types for Aggregations

If the dimensions used for aggregation do not include at least one service type-specific dimension (for example, in the case of aggregating by postal code only) AND the aggregation should not commingle measurements of different service types, it's important to:

- Declare the specific service type for the aggregation on the dimension scanner activity instance
- Declare the desired service type-specific measuring component types on the aggregator measuring component type

For example, if an electric and gas implementation aggregates consumption by postal code, they will need 2 activities: one will reference the Electric service type and the desired aggregator measuring component type, the other will reference the Gas service type and its aggregator measuring component type. The aggregator measuring components will have two dimensional attributes: postal code and service type.

Manual Creation Of Aggregator Measuring Components

Users can also create aggregator measuring component manually. This is useful when an ad hoc aggregation for an ad hoc time period is required, or when there is no activity that automatically creates instances of a given combination of dimensions. To do this, the user simply clicks the "Add" link on the Aggregator Search zone title bar. The BPA script:

- Prompts the user to define the type of aggregation (this will present a list of measuring component types whose measuring component category is aggregator)
- Prompts the user to define the dimensional value(s), the desired aggregation time, and if this aggregation should be performed indefinitely or if it is a "one time"

Base Product Aggregators

A number of standard aggregation processes are delivered as part of the base product. These provide a means of aggregating measurement data by postal code and service type for both physical meters and items.

Aggregator Name	Description
Aggregator - Postal and Service Type	Aggregates measurement quantities for constituent measuring components from physical meter based on postal code and service type dimensions.
Item Aggregator - Postal and Service Type	Aggregates measurement quantities for constituent measuring component from items based on postal code and service type dimensions.

Other aggregators shown below are delivered for use by Oracle Utilities Analytics. These aggregate measurement data (including quantities and counts) for constituent measuring components based on the following dimensions: Postal, City, Head-End, Device Type, Usage Calculation Group, Market and Service Provider, and Service Type.

Aggregator Name	Description
Measurement Measured Quantity Aggregator	Aggregates measurement quantities and distributes the constituents' measurements across Value Identifiers based on condition codes.

Measurement Quality Count Aggregator

Aggregates measurement counts and distributes the constituents' counts across Value Identifiers based on condition codes.

Measurement Timeliness Count Aggregator

Aggregates measurement counts that arrived on time or are late.

Measurement Timeliness Quantity Aggregator

Aggregates measurement quantities that arrived on time or are late.

Maintaining Aggregations

This portal is used to display and maintain Aggregations.

Refer to [About Aggregations](#) for additional functional information.

You can access the portal from the **Main > Totals and Trends > Consumption Statistics**. You are brought to a query portal with options for searching. Once your record has been selected you are brought to the maintenance portal to view and maintain the selected record.

The following zones may appear as part of the portal's **Main** tab page:

- **Measuring Component:** defines the basic attributes of the aggregator measuring component.
- **Measuring Component Attributes:** displays attributes that describe the dimensions and criteria for the aggregation measuring component (applies to dynamic aggregation measuring components only)
- **Measurements — Interval:** displays aggregated measurement data for the selected aggregator measuring component.
- **Interval - Audit View:** allows users to view an interval measurement curve for a given period overlaid with the count of audit records for each individual measurement.
- **Final Values Overlay:** displays final measurements for a measuring component, and provides the ability to overlay the graphed data with final measurements from other measuring components.
- **Time of Use Overlay:** displays an overlay of the TOU periods on a final interval measurement along with totalized TOU consumption based on a user-defined time period and TOU map
- **Related Measuring Component Sets:** lists measuring components sets of which the aggregator measuring component is a member (applies to dynamic aggregation measuring components only)
- **Usage Subscriptions Directly Linked to MC:** lists usage subscriptions that are directly linked to current measuring component

A few functions are available in many of these zones that allow you to interact with the measurement data. For more information of these functions refer to the [Applying Measurement Functions](#) section.

Dynamic Aggregation

Dynamic Aggregation Overview

Standard aggregation processing uses specific algorithms configured to work with a specified set of dimensions. For example, the base package Service Type and Postal aggregation uses specific algorithms for dimension scanning and finding constituent measuring components. In contrast, dynamic aggregation uses dynamic queries for the dimension scanning, find constituents, and aggregation processes.

Dynamic aggregation can be used for analysis (to view aggregated data to understand load demand, for instance) as well as settlement processing performed by Oracle Utilities Market Settlements Management.

Understanding Dynamic Aggregation Execution

This section provides an overview of how dynamic aggregation processing is executed, including descriptions of the different types of dynamic aggregation processing and the different types of data that can be aggregated.

Dynamic Aggregation Execution: Aggregation Groups and Aggregation Group Runs

Aggregation processing is managed via aggregation groups. [Aggregation Groups](#) outline the sequence of aggregations that must occur for a given aggregation process. Each aggregation group includes a set of [Measuring Component Sets](#), each of which has one or more related [Aggregation Measuring Components](#).

When processing is initiated for an aggregation group, the system creates an Aggregation Group Run record to track the status and progress of the aggregation processing. This record is used to manage the aggregation process for each group and track which Measuring Component Sets should be executed next and when the aggregation is complete.

The following steps outlines the aggregation process:

1. The Dimension Scan and Aggregation monitor batch control (D1-DSAEM) initiates processing for all Aggregation Groups. This should be scheduled at least once per day. This monitor process runs all monitor algorithms on each aggregation group. The base package aggregation group has two monitor algorithms:
 - Aggregation Group Run Maintenance (D1-AGRM)
 - Aggregation Group Dimension Scanner (D1-AGDS)
2. The Aggregation Group Run Maintenance algorithm verifies if the Aggregation Group is ready to aggregate by looking at the processing timetable defined for the aggregation group and the last scheduled execution. If it is time for the next aggregation then the algorithm creates a pending Aggregation Group Run which will then be used to track the status of the Measuring Component Sets for the aggregation.
3. The Dimension Scanner algorithm detects the pending Aggregation Group Run and runs to find any new dimensions for all of the Measuring Component Sets for the Aggregation Group.
4. At the completion of the Aggregation Group Dimension Scan and Aggregation monitor batch process, the Aggregate Next Measuring Component Set (D1-AGGNXMCS) post-processing algorithm searches for any Aggregation Group Run entries that are in progress where the next Measuring Component Set is not manual. If at least one is found then it will initiate the Aggregation by MC Set Monitor batch process (D1-AMCS).
5. The Aggregation by MC Set Monitor batch process identifies the next Measuring Component Set for each Aggregation Group Run that is in progress. If that next Measuring Component Set is not manual then it will retrieve each Aggregation Measuring Component for the Measuring Component Set and execute the monitor algorithms for that Aggregation Measuring Component. These include an aggregation algorithm (specific to the type of data to be aggregated such as interval, billed quantities, etc.) and in some cases a value derivation algorithm.
6. For each Aggregation Measuring Component that is monitored by the Aggregation by MC Set Monitor batch process, the aggregation process:
 - a. Executes the appropriate Find Constituents algorithm to find the list of constituents that are to be aggregated
 - b. Extracts the data for those constituents that should be aggregated
 - c. Executes the appropriate aggregation algorithm against that data and store the results
 - d. Executes validation algorithms if applicable
 - e. Executes value derivation algorithms if applicable
7. The Advance Aggregation Group Run (D1-ADVAGR) post-processing algorithm on the Aggregation by MC Set Monitor batch process updates the Aggregation Group Run the batch information for each Measuring Component Set that was aggregated, and requests the Dimension Scan and Aggregation monitor batch process to run again.

8. This again executes the monitor algorithms for all the Aggregation Groups which will do one of several things:
 - If the Aggregation Group Run is in progress and the next Measuring Component Set is Automatic then nothing will happen.
 - If the Aggregation Group Run is in progress and the next Measuring Component Set is Manual it will create a To Do.
 - If the Aggregation Group Run does not have a next Measuring Component Set, it will set the Aggregation Group Run to Complete

NOTE: The Dimension Scanner algorithm will be executed again but since there will not be a pending Aggregation Group Run it will not do anything.

9. Once all Measuring Component Sets are complete the Aggregation Group Run Maintenance algorithm marks the Aggregation Group Run as complete.

Aggregation Scheduling

Refer to [Understanding Aggregation Periods](#) for basics about aggregation periods.

Aggregation Scheduling for Aggregation Groups can be based on either a Defined Lag, or a Processing Timetable.

- **Defined Lag** scheduling uses the following parameters:
 - **Aggregation Cut Off Time:** The end time for aggregation calculations performed for Aggregation Measuring Components for Measuring Component Sets associated with the Aggregation Group. This is used to ensure a consistent end time for aggregation periods. This is especially useful when aggregating other aggregations.
 - **Aggregation Lag:** The number of days between the date on which aggregation calculations are performed and the end date of the aggregation period. This defines the time period between the aggregation calculation date and the aggregation horizon that serves to allow all measurements to arrive. This together with the Aggregation Horizon is used to determine the start and end dates of an aggregation period. For example, with an Aggregation Horizon of 5 and an Aggregation Lag of 2, aggregation calculations performed on January 9 would be for an aggregation period of January 3 through January 7. The next day (January 10), the aggregation period would shift to January 4 through January 8.
 - **Aggregation Horizon:** The number of days in the aggregation period for Aggregation Measuring Components for Measuring Component Sets associated with the Aggregation Group. This reflects the time period during which there's a potential change in measurement data for one or more of the measuring components associated with Aggregation Measuring Components. This together with the Aggregation Lag is used to determine the start and end dates of an aggregation period.
- **Processing Timetable** scheduling uses a Processing Timetable Type to drive aggregation schedule.

With dynamic aggregation, the aggregation period is consistent for all members of an Aggregation Group when an aggregation is performed. This is despite the fact that there may be differences between Measuring Component Sets and even Measuring Components within an Measuring Component Set as to how far the data has been aggregated through. In addition, individual Aggregation Measuring Components all use the same aggregation period when aggregation is performed.

Dynamic Aggregation Processing

This section provides additional details around the specific types of processing used with dynamic aggregation.

Similar to standard aggregation, dynamic aggregation processing comprises three primary types of processes:

- **Dimension Scanning:** a process that searches for unique combinations of dimensions that are not yet represented by an Aggregation Measuring Component.
- **Find Constituents:** a process that finds all source data to be aggregated for a given Aggregation Measuring Component, based on the Aggregation Measuring Component's dimensions.

- **Aggregation:** a process that aggregates source data that corresponds to the Aggregation Measuring Component's dimensions.

Dynamic aggregation processing is driven by the following types of administrative data:

- **Data Sources** define the source of data to be aggregated, such as measurement data from usage subscriptions linked to a service point, badged or unbadged items, or other sources of data.
- **Aggregation Measuring Component Types** define the most important properties of aggregation measuring components used to store aggregated data.
- **Aggregation Groups** define the ordering of a series of related aggregations and the schedule of aggregation.
- **Measuring Component Sets** define the dimensions and criteria by which aggregation will be performed.

Refer to [Dynamic Aggregation Configuration Overview](#) for more information about configuration of this data.

Dynamic SQL

Dynamic aggregation uses dynamic SQL queries to perform dimension scanning, find constituents, and aggregation processing. These dynamic queries are based on configuration of:

- [Data Sources](#)
- [Aggregation Measuring Component Types](#)
- [Measuring Component Sets](#)

The Source of Dynamic SQL

Data sources provide template SQL that is used as the basis for dynamic queries. This template SQL is extended by additional SQL generated from the data source configuration as well as configuration defined for measuring component sets, measuring components, and measuring component types that reference the data source. The ways in which the template SQL is extended is based on the type of process:

- **Dimension Scanning:** The data source template SQL is extended by the criteria, dimensions, and individually managed items configured on the measuring component sets being processed.
- **Find Constituents:** The data source template SQL is extended by attributes defined on the aggregation measuring components being processed.
- **Aggregation:** The data source template SQL is extended by the value identifiers defined on the measuring component type of the aggregation measuring components being processed.

Dimension Scanning

The dimension scanning process analyzes master data to identify unique dimension combinations and create an aggregation measuring component for each. Several objects play a role in this process:

- The Aggregation Group holds the monitor algorithm that performs the scanning
- The Data Source defines the template SQL for identifying dimensions
- Measuring Component Sets define the dimensions and criteria for identifying the dimension combinations

See [Dynamic SQL](#) for more about the role of data sources and measuring component sets in generating dynamic SQL queries for dimension scanning.

This process is executed when aggregation is initiated for an Aggregation Group. This process should be run on a frequent basis (daily or more frequent) and should be executed prior to aggregation processing being run. Each time it is executed the dimension scanning process takes the following high level steps:

1. Identifies all Measuring Component Sets for the Aggregation Group that are not imported from an external source

2. Identifies all yet to be represented dimension combinations
3. Creates an Aggregation Measuring Component based on the Measuring Component Set's Measuring Component Type for each dimension combination identified in step 2.
4. Adds Attributes for each Aggregation Measuring Component created to describe the dimensions and criteria for that Measuring Component
5. Adds an entry in the Measuring Component Set participants table for each Aggregation Measuring Component created

This processing is performed by a monitor algorithm (Aggregation Group Dimension Scanner: D1-AGDS) on the Finalized status of the Aggregation Group business object.

Find Constituents

The Find Constituents process finds all source data to be aggregated for a given aggregation measuring component, based on the Aggregation Measuring Component's dimensions. The queries used for this process are based on data source template SQL extended by attributes defined on the Aggregation Measuring Components being processed.

The Find Constituents process is initiated by the aggregation algorithm on the Aggregation Measuring Component (each type of Aggregation Measuring Component — interval, item, billed quantities — has its own aggregation algorithm), and is performed by algorithms defined for the Find Constituents system event on the Aggregation Measuring Component business object.

This process differs slightly when finding constituents for interval and scalar measurements stored on measuring components, item data, and billed quantities.

Measuring Components

The Find Constituents process for measuring components uses the Find Constituents for Dynamic Aggregation (D1-FINDCONST) algorithm which retrieves data based on the following:

- Attributes on the Aggregation Measuring Component based on the Measuring Component Set configuration
- Measuring Component Types on the Data Source

Measuring component constituents are inserted into a global temporary table (GTT1) with the following information:

- Measuring Component ID
- Horizon Start Date/Time
- Horizon End Date/Time
- Time Zone

NOTE: The aggregation period for each is adjusted by the source Measuring Component's installation history.

Items

The Find Constituents process for items uses the Find Constituents for Items (D1-FICONITEM) algorithm which retrieves data based on the following:

- Attributes on the Measuring Component based on the Measuring Component Set configuration
- Item Types / Service Point Types on the Data Source (for badged vs. unbadged items, respectively)

Item constituents are inserted into a global temporary table (GTT3) with the following information:

- Maintenance Object (Device or Service Point)
- Device Type: Item Type
- Item Count

- Horizon Start Date/Time
- Horizon End Date/Time
- Time Zone

NOTE: The aggregation period for each is adjusted by the source Item's installation history.

Billed Quantities

The Find Constituents process for billed quantities uses the Find Constituents for Billing Data (D1-FINDCONSB) algorithm which retrieves data based on the following:

- Attributes on the Aggregation Measuring Component based on the Measuring Component Set configuration
- Usage Subscription Types on the Data Source

Billed quantity constituents are inserted into a global temporary table (GTT5) with the following information:

- Usage Subscription ID
- Usage ID
- Horizon Start Date/Time
- Horizon End Date/Time
- Time Zone

NOTE: The aggregation period for each is adjusted by the source Usage Subscription's installation history.

Aggregation Calculation

The aggregation calculations process aggregates source data that correspond to the Aggregation Measuring Component's dimensions. The queries used for this process are based on data source template SQL extended by the value identifiers defined on the measuring component type of the Aggregation Measuring Components being processed.

The aggregation calculation process is initiated by Aggregation by MC Set Monitor batch process (D1-AMCS), and is performed by monitor algorithms defined on the Active state of the Aggregation Measuring Component business object. The algorithms used by each type of Aggregation Measuring Component are as follows:

Aggregation Measuring Component Business Object	Aggregation Algorithm
Dynamic Aggregator - Billed Quantities (D1-AggBilledServiceQuantities)	Aggregate Billed Service Quantities (D1_AGGBSQ)
Dynamic Aggregator - Composite (D1-AggregatorComposite)	Aggregate Interval Measurements (D1_AGGINT)
Dynamic Aggregator - Customer Quantities (D1-AggregatorCustomerQuantity)	Aggregate Customer Specific Quantities (D1_AGGCSQ)
Dynamic Aggregator - Interval (D1-AggregatorInterval)	Aggregate Interval Measurements (D1_AGGINT)
Dynamic Aggregator - Items (D1-AggregatorItems)	Aggregate Item Data (D1_AGGITEM)
Dynamic Aggregator - Scalar (D1-AggregatorScalar)	Aggregate Scalar (D1_AGGSCLR)

See [Types of Aggregation](#) for more information about aggregation calculations for each type.

Other Calculations

In addition to basic aggregation processing, other calculations can be performed on aggregated measurements as needed. For instance, a common step in aggregating data for use in market settlements is applying a loss factor to aggregated data to reflect system losses (line loss, etc.) between generation-level quantities and end consumption quantities.

These types of calculations can be performed by value derivation algorithms. These are algorithms based on the Derive Aggregated Quantity Using a Formula (D1-DERAGGQTY) algorithm type which apply a configured formula to aggregated

measurement values. For instance, to apply a loss factor, an algorithm can retrieve effective-dated factor values for a loss factor and multiply each aggregated measurement value by the appropriate factor value.

The Execute Aggregation Value Derivation (D1-EAGGVALD) algorithm on Aggregation Measuring Components executes any value derivation algorithms specified for Value Identifiers on the Aggregation Measuring Component Type.

Foundation and Composite Aggregation

Dynamic aggregation supports two “levels” of aggregation. Aggregating source data, from measuring components, items, or billed quantities is referred to as “Foundation” aggregation. Aggregation of aggregated data is known as “Composite” aggregation. Composite aggregation provides the ability to aggregate data from a set of other aggregations.

The diagram below illustrates a simple example of the relationship between foundation and composite measuring component sets. Each of the three foundation measuring component sets has a number of aggregation measuring component participants that aggregate data based on a set of dimensions and a particular supplier and rate class. Those in turn are participants in the composite measuring component set that aggregates based on the supplier (including data for all rate classes).

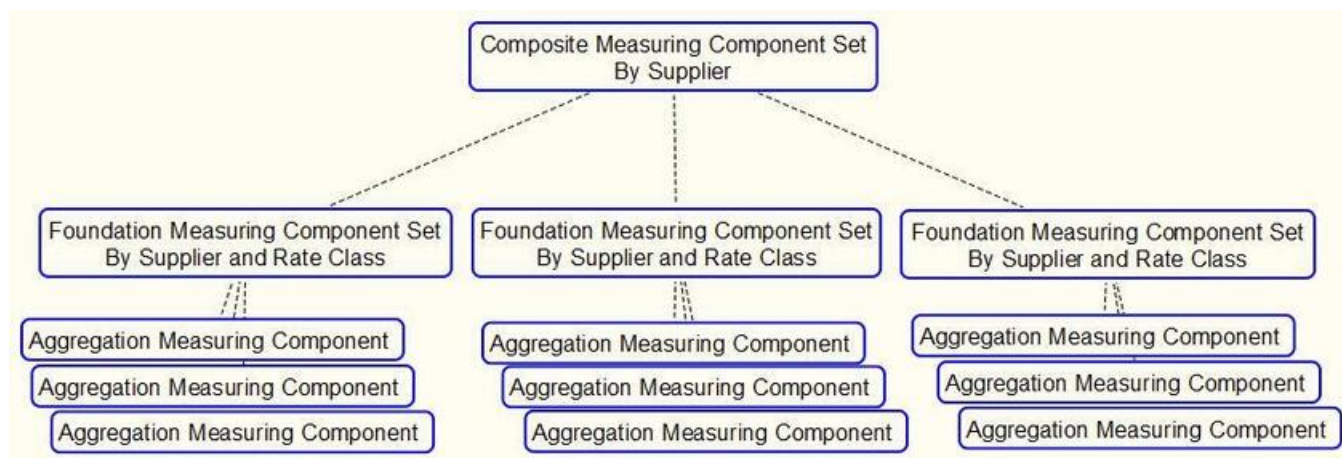

A common scenario where composite aggregation would be used is to consolidate data across several foundation aggregation measuring component sets that pulled data from a set of data sources ordered by precedence such that the best data was sourced when available and when not the aggregations fell back to a lesser quality data source:

- Foundation: Interval measurements from usage subscriptions and / or service points
- Foundation: Scalar measurement from usage subscriptions and / or service points
- Foundation: Interval measurements from estimations (backcasted using actual weather)
- Composite: Aggregation by supplier

In this example the goal of the first aggregation would be to retrieve as much interval data as possible where that interval data covered the entire period being settled for. The second aggregation would take scalar data for those instances where interval data was not available and apply a profile to produce the appropriate intervals. The third aggregation would fill in any remaining gaps that were not covered by interval or scalar data with estimations based various forecasting models.

At the completion of those first three aggregations there would be the full resolution of data for the customer base. However, the values would be spread out across many aggregation measuring components tied to those measuring component sets. This is where the composite aggregation functionality comes into play. The composite aggregation measuring component would reference the first three foundation aggregations and sum together the data from each aggregation into a single instance that represents the total usage for the period being settled.

Let's look at a slightly more involved example. The diagram below illustrates a set of foundation aggregations based on:

- Rate Class

- Strata
- Procurement Class

This shows how the physical measuring component data (designated by Customer A, Customer B, etc.) will be aggregated into separate aggregation measuring components based on source of data (interval or scalar). Then it shows how those aggregations are then aggregated to produce a total number that represents all 3 aggregation sources merged together.

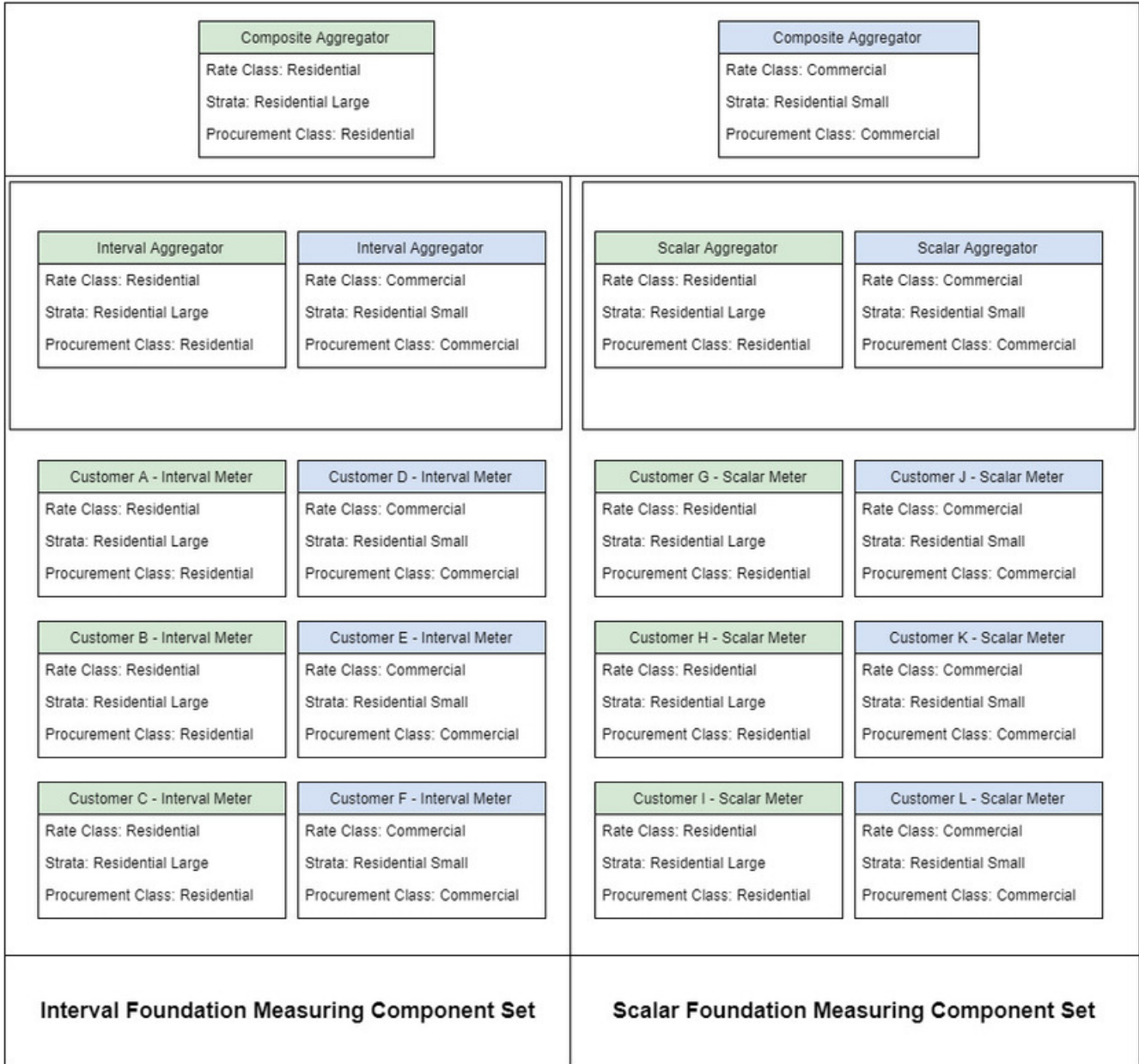

Types of Aggregations

This section describes the processing used by different types of aggregations, including:

- Aggregating Measurement Data (Interval and Scalar)
- Aggregating Item Data
- Aggregating Billed Service Quantities

- Aggregating Aggregated Data (Composite Aggregation)

Aggregating Measurement Data

Aggregating measurement data involves identifying constituent measuring components for an Aggregation Measuring Component, identifying the measurement data that falls within the aggregation period, and aggregating that data. The process varies slightly between interval and scalar measuring components.

Interval Measuring Components

Aggregation of interval measurements is handled by the Aggregate Interval Measurements (D1_AGGINT) algorithm. The algorithm performs the following steps:

- It calls the Find Constituents for Dynamic Aggregation (D1-FINDCONST) algorithm and populates the GTT1 global temporary table (see [Find Constituents](#) for more details about this process).
- It deletes any constituents from the GTT1 table that do not have 100% coverage for the dates in the aggregation period.
- For each remaining constituent in GTT1, the algorithm inserts its measurements for the aggregation period into the GTT2 global temporary table. If the SPI and UOM are different from that of the Aggregation Measuring Component, the measurements are converted to a common SPI using Axis Conversion.
- It performs aggregation calculations on the measurement data in the GTT2 table, using data source template SQL, extended by the value identifiers defined on the measuring component type of the Aggregation Measuring Component.
- It either inserts or updates the results to the appropriate measurement table (the standard Measurement table, or the Aggregation Measurement table)
- If there is no data for any dates in the aggregation period and previously aggregated measurements exist, those measurements are deleted to indicate the absence of data.
- It updates the **Most Recent Measurement Date/Time** and **Latest Measurement Date/Time** values on the Aggregation Measuring Component.

Scalar Measuring Components

Aggregation of scalar measurements is handled by the Aggregate Scalar Measurements (D1_AGGSCAL) algorithm. The algorithm performs the following steps:

- It calls the Find Constituents for Dynamic Aggregation (D1-FINDCONST) algorithm and populates the GTT1 global temporary table (see [Find Constituents](#) for more details about this process).
- It deletes any constituents from the GTT1 table that do not have 100% coverage for the dates in the aggregation period.
- For each remaining constituent in GTT1, the algorithm inserts its measurements for the aggregation period into the GTT2 global temporary table. If the UOM is different from that of the Aggregation Measuring Component, the measurement is converted to a common UOM before being inserted into GTT1.
- It performs aggregation calculations on the measurement data in the GTT2 table, using data source template SQL, extended by the value identifiers defined on the measuring component type of the Aggregation Measuring Component.
- It applies a profile to the aggregated scalar values to create interval measurements with the same SPI as the Aggregation Measuring Component.
- It either inserts or updates the results to the appropriate measurement table (the standard Measurement table, or the Aggregation Measurement table)
- If there is no data for any dates in the aggregation period and previously aggregated measurements exist, those measurements are deleted to indicate the absence of data.
- It updates the **Most Recent Measurement Date/Time** and **Latest Measurement Date/Time** values on the Aggregation Measuring Component.

Aggregating Item Data

Aggregating item data involves identifying constituent items for an Aggregation Measuring Component, calculate item measurement data for the aggregation period, and aggregating that data.

Aggregation of interval measurements is handled by the Aggregate Item Data (D1_AGGITEM) algorithm. The algorithm performs the following steps:

- It calls the Find Constituents for Items (D1-FICONITEM) algorithm and populates the GTT3 global temporary table with groups of device types (for badged items) and/or service point types (for unbadged items) (see [Find Constituents](#) for more details about this process).
- It deletes any constituents from the GTT3 table that do not have 100% coverage for the dates in the aggregation period.
- For each remaining constituent in GTT3, the algorithm calculates measurements for the aggregation period and inserts them into the GTT4 global temporary table by applying the item counts for each group to the item interval (profile) data. If the SPI and UOM are different from that of the Aggregation Measuring Component, the measurements are converted to a common SPI using Axis Conversion.
- It performs aggregation calculations on the measurement data in the GTT4 table, using data source template SQL, extended by the value identifiers defined on the measuring component type of the Aggregation Measuring Component.
- It either inserts or updates the results to the appropriate measurement table (the standard Measurement table, or the Aggregation Measurement table)
- If there is no data for any dates in the aggregation period and previously aggregated measurements exist, those measurements are deleted to indicate the absence of data.
- It updates the **Most Recent Measurement Date/Time** and **Latest Measurement Date/Time** values on the Aggregation Measuring Component.

Aggregating Billed Quantities

Aggregating billed service quantities involves identifying constituent usage transactions for an Aggregation Measuring Component, retrieving the service quantity data that falls within the aggregation period, and aggregating that data.

Aggregation of billed quantities is handled by the Aggregate Billed Service Quantities (D1_AGGBSQ) algorithm. The algorithm performs the following steps:

- It calls the Find Constituents for Billing Data (D1-FINDCONSB) algorithm and populates the GTT5 global temporary table (see [Find Constituents](#) for more details about this process).
- It deletes any constituents from the GTT5 table that do not have 100% coverage for the dates in the aggregation period.
- For each remaining constituent in GTT5, the algorithm retrieves billing data for the aggregation period (based on the service quantity configuration on the data source) and inserts it into the GTT6 global temporary table. If the UOM is different from that of the Aggregation Measuring Component, the service quantities are converted to a common UOM.
- It performs aggregation calculations on the measurement data in the GTT6 table, using data source template SQL, extended by the value identifiers defined on the measuring component type of the Aggregation Measuring Component.
- It applies a profile to the aggregated values to create interval measurements with the same SPI as the Aggregation Measuring Component.
- It either inserts or updates the results to the appropriate measurement table (the standard Measurement table, or the Aggregation Measurement table)
- If there is no data for any dates in the aggregation period and previously aggregated measurements exist, those measurements are deleted to indicate the absence of data.
- It updates the **Most Recent Measurement Date/Time** and **Latest Measurement Date/Time** values on the Aggregation Measuring Component.

Aggregating Aggregated Data

Aggregating aggregated data, also known as composite aggregation, involves identifying constituent aggregation measuring components for a composite Aggregation Measuring Component, identifying the measurement data that falls within the aggregation period, and aggregating that data.

Composite aggregation is very similar to aggregating interval measurement data, and uses the Aggregate Interval Measurements (D1_AGGINT) Find Constituents for Dynamic Aggregation (D1-FINDCONST) algorithm.

Aggregation Measuring Components

About Aggregation Measuring Components

Aggregation Measuring Components are measuring components used to store aggregated data. Aggregation measuring components do not use initial measurements. Aggregated measurements are stored in the Measurement or Aggregation Measurement table (based on the Measurement Business Object defined for the aggregation measuring component's type).

Aggregation Measuring Components are defined by the following:

- **Initiating Measuring Component Set:** The measuring component set that triggered creation of the aggregation measuring component via the Dimension Scanning process (see [Dimension Scanning](#) for more information).
- **Processing Information:** Details of aggregation processing for the aggregation measuring component, including the date and time through which aggregation has been performed.
- **VEE Groups:** The VEE groups used when performing validation, editing, and estimation for the aggregation measuring component.
- **Measuring Component Attributes:** Attributes that describe the dimensions and criteria for the aggregation measuring component (identified by the Dimension Scanning process)

The base package includes the following aggregation measuring component business objects for use with dynamic aggregation:

- **Aggregator Interval (D1–AggregatorInterval):** Used to aggregate interval measurements from interval measuring components
- **Aggregator Scalar (D1–AggregatorScalar):** Used to aggregate scalar measurements from scalar measuring components
- **Aggregator Items Measuring Component (D1–AggregatorItems):** Used to aggregate item data
- **Aggregator Billed Service Quantities (D1–AggBilledServiceQuantities):** Used to aggregate billed service quantities from usage transactions
- **Aggregator Customer Quantities (D1–AggregatorCustomerQuantity):** Used to aggregate specific types of customer quantities such as Peak Load Contribution (PLC) and usage factors
- **Aggregator Composite (D1–AggregatorComposite):** Used to aggregate aggregated data from aggregation measuring components (composite aggregation)

These business objects define the Find Constituents and Aggregation algorithms used for aggregation calculations.

Maintaining Aggregation Measuring Components

You use the **Totals and Trends View** portal to maintain aggregation measuring components.

Refer to [About Aggregation Measuring Components](#) for additional information.

You can access this portal by selecting an aggregation measuring component from the **Measuring Component Set Participants** zone in the **Measuring Component Set** portal. Once your record has been selected you are brought to the maintenance portal to view and maintain the selected record.

This portal includes the following zones:

- **Measuring Component:** This zone displays the basic attributes of the aggregation measuring component
- **Measuring Component Attributes:** This zone displays attributes that describe the dimensions and criteria for the aggregation measuring component
- **Related Measuring Component Sets:** This zone displays the measuring component sets related to the aggregation measuring component
- **Final Values Overlay:** This zone graphs final measurements for a measuring component, and provides the ability to overlay the graphed data with final measurements from other measuring components. The zone also permits overlaying data from the same measuring component for different time periods, as well as data from measuring components that measuring different quantities, such as temperature.
- **Interval - Audit View:** This zone allows users to view an interval measurement curve for a given period overlaid with the count of audit records for each individual measurement. It also allows users to magnify a portion of the curve and see how the measurements looked at different points in time.
- **Measurements - Interval:** This zone displays measurement details for the aggregation measuring component
- **Usage Subscriptions Directly Linked to MC:** This zone displays usage subscriptions that are directly linked to the aggregation measuring component
- **Time of Use Overlay:** This zone displays an overlay of the TOU periods on measurement data along with totalized TOU consumption based on a user-defined time period and TOU map

Master Data Synchronization

The synchronization of master data in Customer To Meter is covered in detail in the [Customer To Meter Master Data Synchronization](#) section of the *Oracle Utilities Customer to Meter Administrative User Guide*.

Outage Storm Mode

About Outage Storm Mode

Unfortunately, utilities and their customers are often subject to natural disasters that cause disruptions to AMI networks. These outage events can be related to hurricanes, tornadoes, ice storms, earthquakes, tsunamis, etc. During these severe outages, AMI systems do not always provide outage and restoration events from the devices. Without these outage and restoration events, Oracle Utilities Meter Data Management processes could estimate measurements that would be billed by the CIS. This will lead to unhappy customers, potentially bad press, and lots of manual cleanup work after the fact.

While this is a problem for major outage events, this can also occur with smaller outages (smaller blackouts, planned outages, etc.). This can potentially become an issue anytime the AMI network has a significant number of devices failing to communicate.

This module includes outage processing to improve estimation accuracy during major outages. The system will automatically stop estimations when the number of meter readings coming is less than a user defined tolerance. This tolerance is based on a significant drop in the read percentage for all devices in a similar postal code, service type, and Head End. Estimations will automatically resume when the device returns to normal operation. This can occur through a number

of actions: read percentage for the surrounding area returns to normal, regular data is received from the device, or a power restoration device event is received from the device.

Oracle Utilities Meter Data Management also includes the ability to manually override "storm mode". This override will allow estimations to resume even if the outage hasn't been fully resolved. This will be useful if network fixes take too long and the utility has decided that customers should be billed on an estimate after a few days pass.

NOTE: For information on configuration, reference the related section for [Outage Storm Mode](#) in the Administration Guide.

The diagram below illustrates the primary flow for Outage Storm Mode processing. The steps include:

1. The **Dimension Scanner** batch (D1-ADS) monitors the **Meter Communication Tracking Dimension Scanner** business object. New Aggregator Measuring Components will be created for every applicable Service Type, Postal Code, and Head End in the system.
2. The **Aggregation Monitor** batch (D2-AGG) runs to execute the logic for the **Meter Communication Tracking Aggregator** Measuring Component. This logic will aggregate all meters for the defined Service Type, Postal Code, and Head End. Once the read percentage is found for that day then a measurement will be created for the Aggregator Measuring Component.
3. The **Widespread Outage** batch (D2-WSO) runs to determine if any of the "Meter Communication Tracking Aggregator" Measuring Components have dropped below the defined threshold on the MDM Master Configuration. If it has dropped enough, then an **Estimation Suppression** Activity is created for each of the affected Service Points and the "Meter Communication Tracking Aggregator" Measuring Component is set to an "Active Outage" indicator.
4. If the **Smart Meter Monitor** batch (D1-SMMTR) runs to generate estimates while an Estimation Suppression Activity is active for a Service Point, then the Service Point will either be skipped for estimation or will have zero consumption filled for all data with a condition code of "No Read - Outage Fill".
5. There are a number of methods available to resume normal operation and close out the Estimation Suppression Activity. These include the following:
 - a. The read percentage reaches a "normal level" again as defined in the MDM Master Configuration. This will be detected by the **Widespread Outage** batch (D2-WSO).
 - b. When non-estimated data is received from a device, this will close out an open Estimation Suppression Activity.
 - c. If the **Standard Event Name** Extendable Lookup is configured with the End Estimation Suppression algorithm (D2-EN-ESTSUP), then any Power Up event this is configured for will close out an open Estimation Suppression Activity.
 - d. Estimation Suppression Activities can also be closed manually by a user by navigating to the Activity, using the "Edit" button", and add an End Date.
6. The **Estimation Suppression Monitor** batch (D2-ESTSU) runs for all Estimation Suppression Activities to determine if the related "Meter Communication Tracking Aggregator" Measuring Component is no longer in a state of "Active Outage". If the widespread outage has ended, then the Estimation Suppression activity will be set with an end date.
7. The next time the **Smart Meter Monitor** batch (D1-SMMTR) runs it will generate estimated data as normally configured.

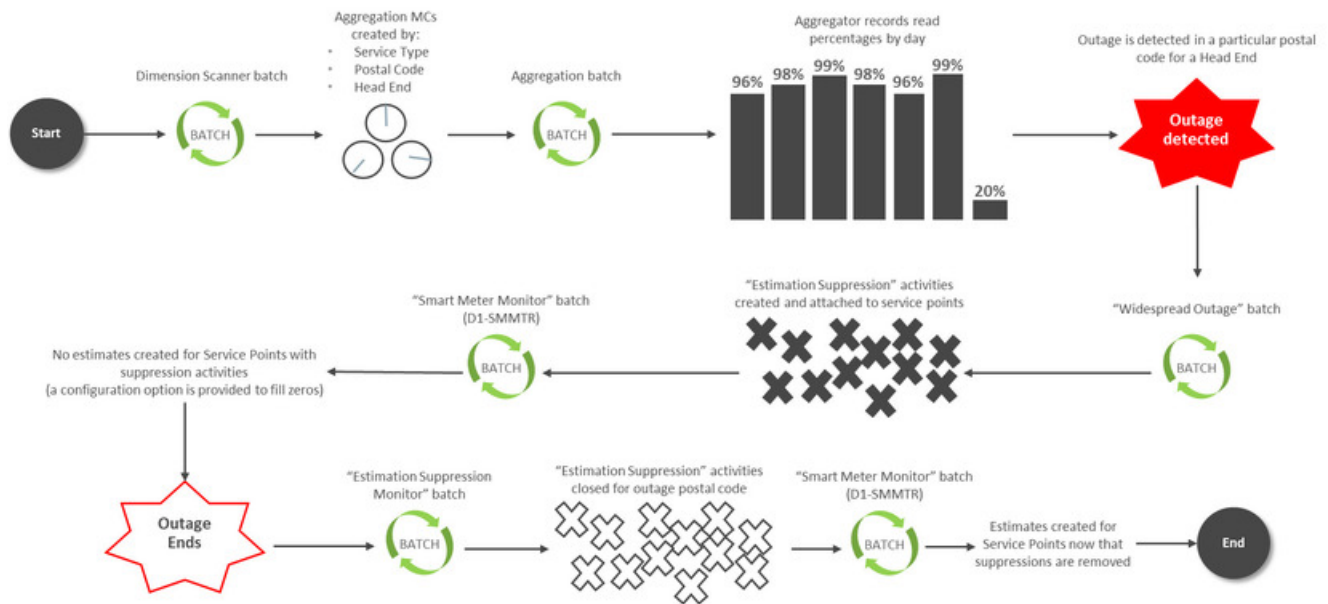

In order to determine if an area is experiencing a widespread outage, the median read percentage of prior days is used as the basis for comparison. The median was chosen instead of the average to help reduce the impact of outlier values. This is illustrated in the example below.

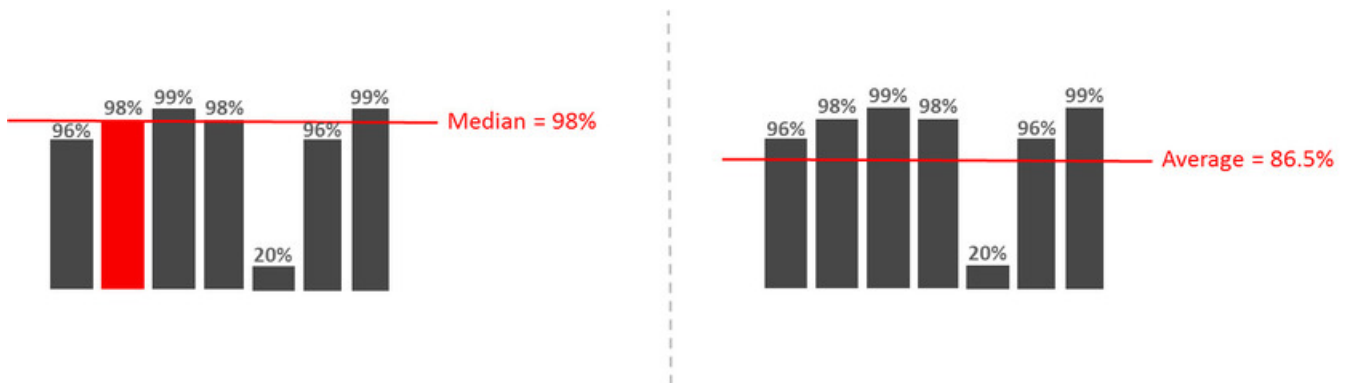

Reviewing Widespread Outages

Anytime a **Meter Communication Tracking Aggregator** Measuring Component is marked with an indicator of "Active Outage", a To Do will be generated for user review. The base To Do Type for this is "Widespread Outage" (D2-WSOTD). This To Do is meant to serve as a warning to users that one of the areas in the service territory is experiencing a widespread outage.

If there is a desire to continue processing as normal and not have estimation suppressed, then you can override the Meter Communication Tracking Aggregator by hitting the "Force Complete Outage" button while reviewing the To Do. This will mark the Widespread Outage Indicator as "User Override" and will allow estimation to continue normally.

Dashboards

About Dashboards

Dashboards provide a broad view of numerous metrics used with . The data presented on each dashboard is tailored to provide operational as well as analytical information for management. On some graphs, drill down options are provided to retrieve more detailed information about the metrics provided.

For information on configuration, reference the related section for [Defining Dashboard Options](#) in the .

Using the Customer Operational Dashboard

This portal is used to display the Customer Operational Dashboard.

You can access the portal from the **Main > Dashboards > Customer Operational Dashboard**. Once you've selected this menu option, you're immediately brought to the initial tab of the dashboard.

The **Billing** tab displays the following zones:

- **Billing Trend:** displays bill completion counts and billed amounts by date.
- **Bill Print Trend:** displays bill print counts by date.
- **Open Bill Issues Trend:** displays open bill issue counts by date.

The **Payment** tab displays the following zones:

- **Payment Trend - All Sources:** displays payment counts and payment amounts from all sources.
- **Payment Trend - Upload:** displays upload payment counts and payment amounts.

The **To Do** tab displays the following zones:

- **To Do Completion By User:** displays To Do completion counts by user.
- **To Do Work Time By User:** displays average To Do work time by user.

The **Batch Performance** tab shows a series of zones related to any defined Performance Targets for batches. More information on Performance Targets can be found in the Framework guide.

Refer to [About Dashboards](#) for additional functional information. For information on configuration, refer to the related section for [Configuring the Customer Operational Dashboard](#) in the .

Refer to each zone's embedded help for more information.

Using the MDM Operational Dashboard

This portal is used to display the MDM Operational Dashboard.

You can access the portal from the **Main > Dashboards > MDM Operational Dashboard**. Once you've selected this menu option, you're immediately brought to the initial tab of the dashboard.

The **Operations** tab displays the following zones:

- **IMD Loading Trend:** displays the count of initial measurement data that's loaded each day by Head End system.
- **Device Event Loading Trend:** displays the count of device event data that's loaded each day by Head End system.
- **Incomplete IMDs by Status:** displays a set of counts for initial measurement data by status.
- **Incomplete IMDs Trend:** displays a set of counts for initial measurement data for each day by status
- **VEE To Dos by Exception Type:** displays a set of counts for VEE Exceptions by Exception Type that also still have a To Do that's incomplete.

- **VEE To Dos Trend:** displays a set of counts for VEE Exceptions by Exception Type for each day that also still have a To Do that's incomplete.
- **Usage Transactions by Status:** displays a set of counts for usage transactions by status.
- **Usage Transactions Trend:** displays a set of counts for usage transactions for each day by status.
- **Usage Transaction To Dos by Exception:** displays a set of counts for Usage Transaction Exceptions by Exception Type that also still have a To Do that's incomplete.
- **Usage Transaction To Dos Trend:** displays a set of counts for Usage Transaction Exceptions by Exception Type for each day that also still have a To Do that's incomplete.

The **Batch Performance** tab shows a series of zones related to any defined Performance Targets for batches. More information on Performance Targets can be found in the Framework guide.

Refer to [About Dashboards](#) for additional functional information. For information on configuration, refer to the related section for [Configuring the MDM Operational Dashboard](#) in the *Oracle Utilities Meter Solution Administrative User Guide*.

Using the Service Order Operational Dashboard

This portal is used to display the Service Order Operational Dashboard.

You can access the portal from the **Main > Dashboards > Service Order Operational Dashboard**. Once you've selected this menu option, you're immediately brought to the initial tab of the dashboard.

The following zones may appear as part of the portal's **Main** tab page:

- **In-Flight Activities By Type:** shows the distribution of in-flight Activities (in progress or in error) by Activity Type.
- **In-Flight Activity Trend:** shows the number of activities that are in-flight on a given day.
- **In-Flight Activities with Issues:** presents a bar chart that indicates the number of activities with issues.
- **In-Flight Activity Status Distribution:** presents a pie chart that displays the distribution of statuses of in-flight activities.
- **Efficiency Trend for In-Flight Activities:** presents a stacked bar chart that displays the distribution of in-flight activity processing efficiency relative to configurable tolerance.
- **Service Order To Do Summary:** this zone uses horizontal bars to highlight the relative number of open To Dos for a set of To Do Types related to Service Order Management.

Refer to [About Dashboards](#) for additional functional information. For information on configuration, refer to the related section for [Configuring the Service Order Operational Dashboard](#) in the Administrative User's Guide.

Using the Service Order Trends Dashboard

This portal is used to display the Service Order Operational Dashboard.

You can access the portal from the **Main > Dashboards > Service Order Trends Dashboard**. Once you've selected this menu option, you're immediately brought to the initial tab of the dashboard.

The following zones may appear as part of the portal's **Main** tab page:

- **Orchestration Issues Trend:** contains a stacked bar chart showing issues by category and Activity Type.
- **Issue Distribution Over Time:** contains a pie chart showing the distribution of activity issues over a range of days.
- **Activity Success Trend:** shows successful activities over a range of days.
- **Activity Creation Trend:** shows activities created over a range of days.
- **Activity Completion Efficiency Over Time:** shows the efficiency of activity completion over a range of days.

Refer to [About Dashboards](#) for additional functional information. For information on configuration, refer to the related section for [Configuring the Service Order Trends Dashboard](#) in the Administration Guide.

Totals and Trends

Processing Statistics

About Processing Statistics

Upload statistics (or upload stats) are statistics related to the uploading of initial measurement data and device events sent from a head-end system.

Upload statistics are defined as activities in Oracle Utilities Smart Grid Gateway.

There are three types of upload statistics activities:

Payload Statistics: Contains statistics related to a specific payload (file) containing one or more initial measurements or device events. Payload Statistics activities contain:

- Basic information about the payload (head-end system, file name, and status)
- Middleware statistics including specifics about the file, the total number of initial measurements or device events processed, the number of initial measurement or device events errors, and total processing time
- Initial measurement statistics including the number of initial measurements processed
- Device event statistics including the number of device events processed

Payload Error Notification: Contains details concerning processing errors encountered in an individual payload (file) containing one or more initial measurements or device events. Payload Error Notification activities are related to Payload Statistics activities.

Payload Summary: Contains processing summary statistics for an individual payload (file) containing one or more initial measurements or device events. Payload Summary activities are related to Payload Statistics activities, and are used to update related payload statistics upon the completion of payload processing.

Upload statistics activities are created during processing of payload files as follows:

- When processing begins for a payload, a Payload Statistics activity is created to record the process.
- If an error occurs during processing, a Payload Error Notification activity is created.
- When payload processing is complete, a Payload Summary activity is created, which in turn, updates the Payload Statistics activity with details concerning the processing of the payload, including (the start and end time of the processing, the total processing time, the number of initial measurements or device events processed, and the number of initial measurement or device event errors (if any)).

About Head-End System Processing Statistics

Head-end system processing statistics are summarized processing statistics for payloads received from a given head-end system.

As Oracle Utilities Smart Grid Gateway processes payloads containing initial measurements or device events, statistics for each payload are captured in Payload Statistics activities. Over time, payload statistics for each head-end system are summarized to allow administrators to view statistics summary for the head-end system.

Head-end system processing statistics are stored as aggregated measurements for aggregator measuring components. A separate aggregator measuring component must be set up for each head-end system for which processing statistics will be aggregated.

Consumption Statistics

Please refer to the [About Aggregation](#) section for information on consumption statistics.

Time Zone Support

Daylight Savings Time Support

This section describes how the Oracle Utilities Service and Measurement Data Foundation and its related products support Daylight Saving Time (DST).

All date/times in the system are displayed adjusted for daylight savings time (when in effect). However, not all date/times in the system are stored in daylight savings time:

- Stored in Standard (not adjusted for DST): data that is highly sensitive to DST shifts are stored in standard time without any shifts, this means they have a consistent 24 hour day each day all year and avoid issues that arise from a skipped hour when transitioning to DST and a duplicate hour when transitioning out of DST. For example: initial measurement data, final measurements, device events, TOU map data.
- These date/times are adjusted for daylight savings time prior to being displayed to a user.
- Stored in Legal (adjusted for DST): data that is not as sensitive to DST time shifts are stored in legal time. For example, device configurations, service points, installation events, usage subscriptions, usage transactions.

Adjusting Date/times Upon Receipt

The two largest sources of imported data to the system can be sent in a mixture of date/time formats some in legal time some in standard time:

- Initial Measurement Data
- Device Events

Since both sets of data are sent by head end systems and each head end system handles date/times differently, potentially even differing by device, the interface must be extremely flexible in how it handles date/times. In order to ensure data is accurately stored and processed the system must know how a given meter sends date/time information. This is defined on the device through the Incoming Data Shift Flag:

- Always in Standard Time: No special handling is required.
- Always in Legal Time: All date/times for the initial measurement data or device event will be converted from legal time into standard time.
- In circumstances where a date/time is received in legal time and it falls on the duplicate hour that occurs when DST ends special logic will be executed to identify whether that hour is the first (still in DST) or second (no longer in DST) of the duplicate hours. If for some reason it cannot be identified which hour it is the transaction will go into error.

Daylight Savings Time Interval Conversion Examples

The following examples show how data received legal time will be shifted into standard time for an interval meter that is read on an hourly basis.

Daylight Savings not in Effect

Date/Time Received in Legal	Date/Time Stored in Standard
01/14/2010 12:00AM	01/14/2010 12:00AM
01/14/2010 1:00AM	01/14/2010 1:00AM
01/14/2010 2:00AM	01/14/2010 2:00AM
01/14/2010 3:00AM	01/14/2010 3:00AM
01/14/2010 4:00AM	01/14/2010 4:00AM
01/14/2010 5:00AM	01/14/2010 5:00AM

Daylight Savings Starts (Spring Forward) - No 2AM interval

Date/Time Received in Legal	Date/Time Stored in Standard
03/14/2010 12:00AM	03/14/2010 12:00AM
03/14/2010 1:00AM	03/14/2010 1:00AM
03/14/2010 3:00AM	03/14/2010 2:00AM
03/14/2010 4:00AM	03/14/2010 3:00AM
03/14/2010 5:00AM	03/14/2010 4:00AM
03/14/2010 6:00AM	03/14/2010 5:00AM

Daylight Savings in Effect

Date/Time Received in Legal	Date/Time Stored in Standard
06/14/2010 12:00AM	06/13/2010 11:00PM
06/14/2010 1:00AM	06/14/2010 12:00AM
06/14/2010 2:00AM	06/14/2010 1:00AM
06/14/2010 3:00AM	06/14/2010 2:00AM
06/14/2010 4:00AM	06/14/2010 3:00AM
06/14/2010 5:00AM	06/14/2010 4:00AM

Daylight Savings Ends (Fallback) - Duplicate 1AM

Date/Time Received in Legal	Date/Time Stored in Standard
11/7/2010 12:00AM	11/6/2010 11:00PM
11/7/2010 1:00AM	11/7/2010 12:00AM
11/7/2010 1:00AM	11/7/2010 100AM
11/7/2010 2:00AM	11/7/2010 2:00AM
11/7/2010 3:00AM	11/7/2010 3:00AM
11/7/2010 4:00AM	11/7/2010 4:00AM

Daylight Savings Impact on Periodic Estimation

In periodic estimation both the interval and scalar versions can be impacted by daylight savings time:

- Interval periodic estimation using the "Predictable Cut-off" method.
- All scalar periodic estimation

Refer to [About Periodic Estimation](#) for more information about the impact of Daylight Savings Time on periodic estimation.

Multiple Time Zone Support

Some utilities have operations in more than a single time zone. When operating in multiple time zones, Oracle Utilities Meter Data Management and Smart Grid Gateway provide the following high level functionality:

- The ability to receive data in any time zone and convert it to the common time zone used by Oracle Utilities Meter Data Management (as defined by the base time zone)
- The ability to display functional date/times in the time zone of a given device, service point, usage subscription
- The ability to define what time zone a measuring component, device configuration, service point, or usage subscription resides in
- The ability to aggregate data across time zones into a single time zone or without respect to a time zone (see Aggregations on page E-17 for more information).
- The ability to export data to an external system with the appropriate time zone information to enable the external system to consume data from different service points in different time zones

By default, the system assumes only a single time zone is supported. To enable support for multiple time zones it requires that adding the appropriate entry to the general system configuration feature configuration.

Refer to [Configuring Feature Configurations](#) for additional on the feature configuration options available.

Date/Time Storage and Display

All date/times in the system are stored in the base time zone. Date/times are stored in either standard time or legal time and this determination is made based on the type of data (e.g. measurements are in standard but installation event date/times are in legal).

All date/times are displayed in legal time. Those date/times that are key functional date/times related to a device, service point, or usage subscription will be displayed in the legal time of the time zone the device resides in.

Refer to the [Glossary of Terms](#) for a more detailed definition of Standard and Legal time.

Time Zone Hierarchy and Maintenance

A time zone can be defined at many points within the device to usage subscription hierarchy. This enables the time zone to be accurately portrayed based on the installation status of that device (e.g. not installed, installed but not billed, billed). At each stage of the hierarchy the time zones must match.

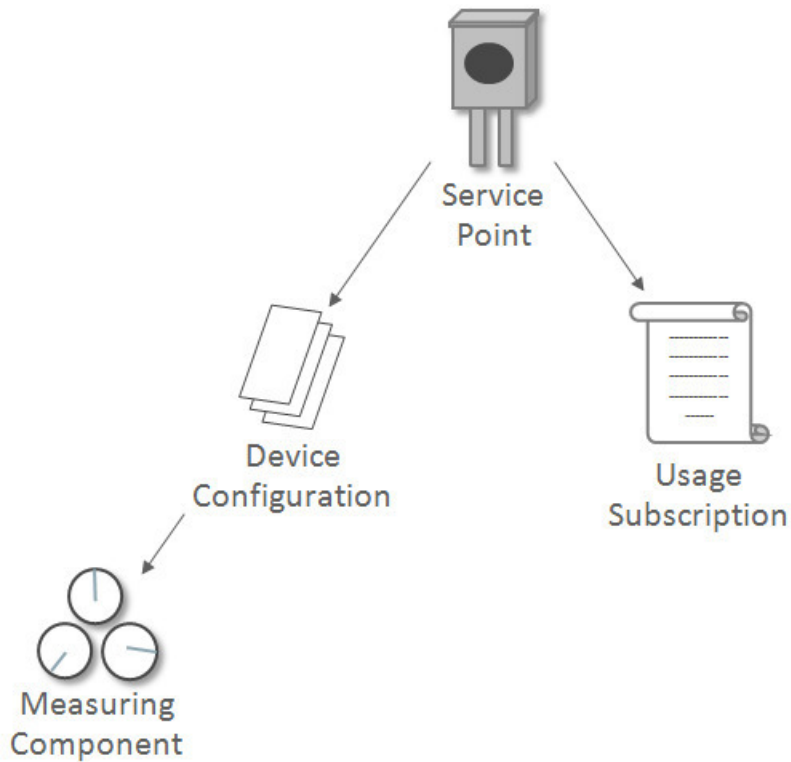

Once the hierarchy has been established no one portion of that hierarchy can be changed to a time zone that differs from the other levels of the hierarchy. In order to change the time zone for an established device to usage subscription hierarchy the change must be done to the service point. Once the service point time zone has been changed the system will cascade that change to all other levels of the hierarchy.

If a device has been installed at a service point in order for it to be moved to a different service point in a different time zone. It will require that a new device configuration be created for time zone of the new service point since a device configuration cannot be associated to two different service points each with a different time zone from the device configuration.

Note: If the time zone for a device that has existing measurements has been changed there will be no automatic adjustments made to the underlying measurement data. If the measurement data must be changed it will require manual intervention.

Note: Although measuring component has time zone it is not populated on physical devices that are installed at service points. This time zone is used for standalone measuring components.

Impacts on Aggregations

In aggregation there are two use cases for how data should be aggregated for service points that exist in differing time zones:

- **Absolute Time:** If a time zone is provided on the measuring component or measuring component type, then the aggregation horizon date/times will be used across service points of differing time zones. For example the 4/1/2010 12AM interval in US/Pacific would be combined with the 4/1/2010 3AM interval in US/Eastern. Since all date/times are stored in the base time zone there is no need to do time zone conversions.
- **Local Time:** If no time zone is specified, consumption is aggregated by converting the aggregation horizon to the appropriate time zone for each service point. For example the 4/1/2010 12AM interval in US/Pacific would be combined with the 4/1/2010 12AM interval in US/Eastern.

Aggregation Measuring Components in general do not have any time zone related dependencies with other master configuration objects. However, when an aggregator is listed as a direct channel measuring component on a usage subscription it share the same time zone as the Usage Subscription.

Impacts on TOU Map Generation

The date and times defined on a [Time of Use Mapping Templates](#) (TOU) do not have a time zone associated to them and will be interpreted based on the time zone of the TOU map type of the specific TOU Map being processed. This allows for a single definition of a TOU schedule that can be applied across many different time zones.

During the generation of the TOU map data for a given TOU map template the date/times will be converted from the time zone of the TOU map to the time zone defined in the base time zone defined on the [installation options - framework](#). For example, if 1/1/2010 5:00PM was considered to be "On Peak" and the system time zone was UTC -08:00 and the TOU map time zone was UTC -05:00 then the TOU map data entry would be written as 1/1/2010 2:00PM.

Impacts on Factors

Factor effective dates do not have a time zone associated to them and are assumed to be in the local time zone of the data being validated. For example a factor effective 4/1/2010 12:00AM would be considered to be effective 4/1/2010 12:00AM UTC -08:00 and 4/1/2010 12:00AM UTC -05:00 based on the time zones of the respective meters. This allows a single factor to apply to many time zones and behave uniformly.

Impacts on Holidays

Holiday effective dates do not have a time zone associated to them and are assumed to be in the local time zone of the data being validated. For example a holiday on 12/25/2010 would be considered to be effective beginning 12/25/2010 12:00AM UTC -08:00 and 12/25/2010 12:00AM UTC -05:00 based on the time zones of the respective meters.

Impacts on Periodic Estimation

Refer to [About Periodic Estimation](#) for more information about the impact of Daylight Savings Time on periodic estimation.

Impacts on Initial Measurement Creation Online

When creating initial measurements online from the 360 Degree View portals, initial measurements are created as appropriate for measuring components with time zones other than the base time zone.

For example, if you copy measurements from a measuring component in one time zone to a measuring component in a different time zone, the measurements are being moved in absolute time (i.e. the 3:00 PM in UTC -08:00 would be changed 6:00PM in UTC -05:00).

Impacts on Items

The consumption for "badged" and "unbadged" items is driven by configuration on the device type service quantity and the multi-item section of the service point:

- **Device Type Service Quantity:** the effective date of the service quantity does not have a time zone and is assumed to be in the local time zone of the service point it is associated to (whether through a install event for "badged" items or by being directly configured on the service point). For example an effective date time of 1/1/2010 5:00PM would be considered to be effective beginning 1/1/2010 5:00PM UTC -08:00 and 1/1/2010 5:00PM UTC -05:00 based on the time zones of the respective meters
- **Service Point Multi-Item:** the start date time and end date time of the multi-item list are stored in legal time of the base time zone and displayed in the legal time of the service point's time zone.

Service Issue Monitors

About Service Issue Monitors

Service Issue Monitors are service tasks that analyze service points to determine if service is needed. If service is determined to be needed, the Service Issue Monitor creates a Service Investigative Order.

Device events, VEE exceptions, failed smart meter commands, and other events can trigger the creation of a service issue monitor (the type of service issue monitor created is based on the Service Issue Monitor Type specified on the device event type, exception type, or activity type). Once created, service issue monitors analyze the service point where the device associated with the device event, VEE exception, or failed command, based on evaluation criteria specified on the service issue monitor's type. If the criteria are met (in other words, if a specified number of command failures, device events, or VEE exceptions are found for the service point), the service issue monitor creates a service investigative order.

Service Issue Monitor Creation

This section provides an overview of the process that takes place when service issue monitors are created.

NOTE: The process outlined below has been simplified for illustrative purposes, and does not reference every step performed in this process.

1. One (or more) of the following takes place:
 - A device event or reader remark is received, whose type specifies a Service Issues Monitor Type
 - A VEE exception whose type specifies a Service Issues Monitor Type is generated during VEE processing
 - A usage transaction exception generated during usage calculation
 - A smart meter command fails whose type specifies a Service Issues Monitor Type
 - A business flag is received whose type specifies a Service Issue Monitor Type
2. The object received in item (1) creates a service issue monitor based on the referenced Service Issue Monitor Type
3. The service issue monitors analyzes the service point based on the Discard Rules and Evaluation Criteria defined on the service issue monitor's type to determine if a service investigative order should be created or if the service issue monitor should be discarded.

The "Discard Rules" on the service issue monitor's type are evaluated to determine if the new service issue monitor should be discarded (new service issue monitors are always discarded when created if an existing service investigative order created by an service issue monitor of the same type exists for the service point.)

If the service issue monitor type was configured to require approval, the service issue monitor generates a To Do to notify the appropriate individuals that approval is necessary.

If the service issue monitor is approved or if no approval was necessary the service investigative order will be continue.

4. The service issue monitor then executes the evaluation criteria defined on the service issue monitor's type. If those criteria are met the Service Investigative Order activity is created. If the criteria are not met the service issue monitor is discarded.
5. If the service issue monitor has completion criteria defined the service issue monitor will wait for the service investigative order to complete. Once complete the the service issue monitor will execute the completion criteria to evaluate if the service investigative order achieved the desired results.

If either there were no completion criteria or they were satisfied the service issue monitor will complete.

If the completion criteria were not satisfied the service issue monitor enter an inconclusive investigation state from which manual intervention will be required.

About Service Investigative Orders

Service investigative orders are activities created by a service issue monitor when a specified set of events have occurred at a service point. The type of activity created by the service issue monitor is defined on the service issue monitor's type.

Service issue monitors are often configured to create field activities that are in turn sent to an external field work system.

Oracle Utilities Rate Cloud Service

Overview

Oracle Utilities Rate Cloud Service provides access to the rate calculation functionality of Oracle Utilities Customer Cloud Service. This includes the ability to configure and test rate calculations via the user interface, as well as the ability to trigger the rate calculation process from an external system.

This section describes the functionality provided with Oracle Utilities Rate Cloud Service.

Note: Oracle Utilities Rate Cloud Service supports rate calculation for traditional scalar or volume-based billing quantities only. It does not include capabilities for generating billing determinants from interval data input.

Setting Up Rates with Oracle Utilities Rate Cloud Service

Oracle Utilities Rate Cloud Service provides access to pages, portals, and zones used to create and maintain rates and rate configuration data, including:

- Bill Factors
- Bill Factor Values
- Calculation Groups
- Calculation Line Category Types
- Calculation Rules
- Rate Schedules

Refer to the [Rates](#) chapter of the *Business User Guide* for detailed information about setting up the above types of configuration data. Note: Some fields and options used with the above types of configuration data are not applicable when using Oracle Utilities Rate Cloud Service when compared to using Oracle Utilities Customer Cloud Service.

Using Rate Check with Oracle Utilities Rate Cloud Service

In addition to rate configuration functionality, Oracle Utilities Rate Cloud Service includes access to the Rate Check feature, which allows users to test their rates.

When using Rate Check, service quantities and characteristic types/values must be provided by the user and entered via the user interface. Oracle Utilities Rate Cloud Service does not support the use of the Rate Check feature based on service agreements, bill segments, or service points.

Refer to the [Rate Check](#) section in the **Rates** chapter of the *Business User Guide* for more information about using the Rate Check feature.

Data Access Restrictions

Using Data Access Restrictions

The focus for multi-jurisdiction support in Oracle Utilities Meter Data Management is on restricting access to the user interface. This occurs through defining different Access Groups by operating company which then marks the Service Point with the access capabilities. The Service Point has a field named **Access Group** which allows you to define specific access to the Service Point.

If Access Group is set on the Service Point, then the user interface search screens within Oracle Utilities Meter Data Management will only allow users that are assigned to the proper Access Role to be able to access that Service Point.

For additional information see [Defining Access Groups](#).

Defaulting Access Groups on Service Points

If there is a desire to set a default Access Group by jurisdiction, then this can be accomplished on configuration for [Markets](#). When defining a Market there is an option to add a **Default Access Group**. This value will be used to mark any newly created Service Point with the same Access Group value defined on the related Market.

Example Scenarios

Below are some examples of how Data Access Restrictions can be implemented:

Example 1: Split Access by Market - an example utility "ABC Energy" that has 3 operating companies.

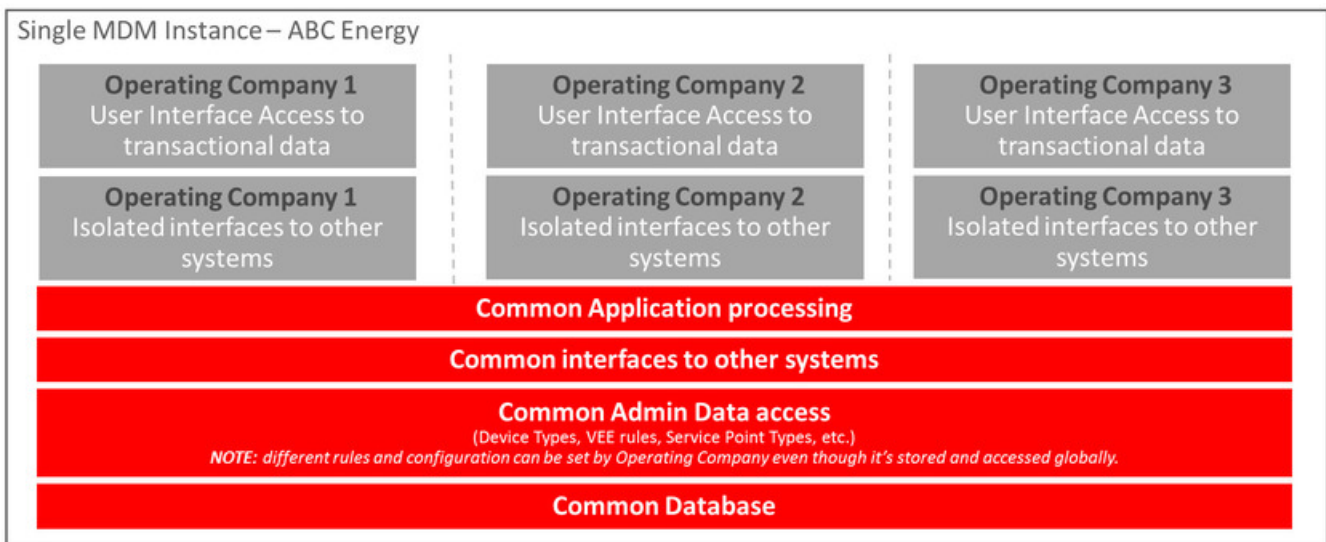

Example 2: Isolating Important Customers - an example utility "XYZ Energy" that has 2 operating companies but would also like to isolate access to Large commercial customers for one of the companies.

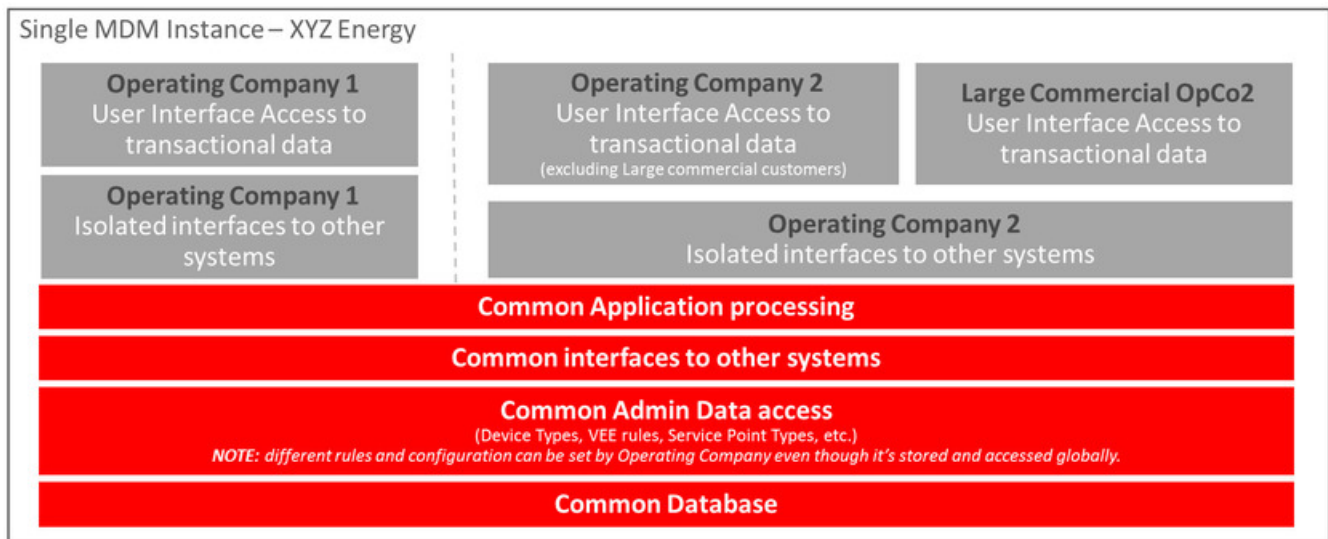

To Do Processing

There are numerous events that trigger the creation of email-like messages describing work that requires human attention. For example, if a bill segment has an error, a message is created to highlight such. We refer to each message as a **To Do Entry**. In this section, we describe how to view, manage and work To Do entries.

FASTPATH: We recommend familiarizing yourself with the topics described in [The Big Picture of To Do Lists](#) to fully appreciate how To Do entries are managed by the system.

The Big Picture of To Do Processing

The topics in this section provide background information on To Do processing functionality.

To Do Role

Each To Do entry is assigned a specific To Do Role. The role defines the users who may work on the entry. The permissible roles that may be assigned to a To Do entry are defined on the entry's To Do type. One or more users within a role may be designated as a supervisor, who is allowed to assign To Do entries to other people. Supervisors are determined through application security access.

Refer to [To Do Entries Reference A Role](#) to learn more about role assignment.

After an entry is created, its role may be changed to any role defined as valid for the entry's To Do type. Manual changes of a To Do entry's role are recorded on the [To Do entry log](#).

To Do Priority

A To Do entry is associated with a priority level representing its processing order compared to other entries. Refer to [The Priority Of A To Do Entry](#) for more information on how an entry's priority is initially assigned and how it may be automatically updated by the system.

A user may manually override a To Do entry's priority at any time. Once overridden, automatic recalculation of the priority is no longer performed so as not to override the value explicitly set by the user. Manual overrides of a To Do entry's priority are recorded on the [To Do entry log](#).

Work Distribution

To Do entries may be manually assigned to users either by their supervisors or picked up by the users themselves.

Manual assignments of To Do entries are possible in various pages in the system:

- The [To Do Management](#) portal provides many filters and viewing options to review To Do entries for a give To Do Type. Users may use this page to assign work to themselves and supervisors may use this to assign work to others.
- Supervisors may use the [supervisor function](#) pages to review and assign To Dos to users.
- A user may use the [To Do list](#) pages to review and assign To Dos to themselves or forward any of their To Dos to someone else.
- All of the above assignment functions may also be performed using the [To Do Search](#) page.

The system can also be configured to dynamically assign the highest priority work to users on demand whenever they are available for fixing errors.

NOTE: Assignment on demand is in a plug-in. You can customize the next assignment plug-in on the [installation options](#) to follow your organization's work distribution rules. For example, when a user asks for the next assignment, business rules may be used to only consider To Do entries the user has the proper [skills](#) to resolve, prioritizing them based age, impacted dollar amount, etc.

One of the main benefits of the assignment on demand approach is that work is allocated real-time based on most current information such as skills, priority, user availability, etc. This also means that work remains unassigned until a user is actually going to work on it making it available to any qualified user.

Assignment "on demand" is possible from the [Current To Do](#) zone on the Dashboard portal. Refer to this zone to learn about all the functions it provides.

A User's Current To Do

Users have the option of drilling down on an entry from various list queries in the system. Refer to [Working On A To Do Entry](#) for more information on drilling into an entry.

Drilling down on an entry from the following To Do list queries also sets the entry as the user's **Current** To Do entry:

- [To Do Management](#) (using the Work button)
- [To Do List](#) (using the entry's message description link)
- [To Do Search](#) (using the entry's message description link)

Additionally, users may have the option to click on the **Assign me a To Do** button on the Current To Do dashboard zone to request their next task. The returned To Do entry automatically becomes the user's **Current** To Do.

Regardless of how a To Do entry became current its information is displayed on the Current To Do zone.

FASTPATH: Refer to [Current To Do](#) zone to learn about all the functions it provides to efficiently resolve the current To Do and other entries that may potentially be [related](#) to it.

Refer to [How to Work on a To Do Entry](#) for information about working through a list of To Do entries.

Related To Do Entries

A user working on a To Do may want to know of other To Dos that may be related to the same problem. If they can be worked by the same user they may get resolved faster. It seems almost impossible to programmatically determine whether two To Dos really stem from the same problem. The user should therefore be presented with a list of potentially related To Dos from which he/she can select the truly relevant ones.

A To Do entry is considered potentially related to a given To Do if they reference a common entity via a characteristic. For example, if a given To Do references a certain account then any To Do referencing that same account is considered related to it.

NOTE: The common entity is any characteristic value linked to the To Do entry where the characteristic type is a **Foreign Key** and the main table of the foreign key is classified as a **Master** or **Transaction** table.

The To Do Search page supports a **Related To Do filter** that lists all related To Dos for a given entry. Various pages showing To Do information often provide an indication as to how many non-complete entries may be related to a given To Do entry. Clicking on the indication's hyperlink transfers the user to the To Do Search query pre-populating it to list the related entries for the specific To Do entry.

FASTPATH: Refer to the [To Do Search](#) page for more information on all the functions it supports.

Complete A To Do

After you finish working on an entry, you can mark it as **Complete**. At this point, you may want to review potentially [related](#) To Do entries and complete those that have been addressed by resolving the problem associated with the current entry.

If you cannot resolve the problem, you can forward the To Do to another user, thus assigning the To Do to another user.

FASTPATH: Refer to [How To Complete To Dos](#) for more information.

NOTE: It is possible for the system to automatically mark an entry as **Complete**. Refer to [The Lifecycle Of A To Do Entry](#) for more information.

Managing To Do Entries

This section describes the various pages available to view and work on To Do entries.

To Do Management

The To Do Management portal provides a multi-query zone that includes a search for To Do entries using To Do Type and other To Do information. Users may search for entries using multiple criteria and perform common actions, such as assignment and completion, on selected entries.

It is intended to be used by both supervisors and non-supervisor To Do users. Supervisors are identified by their security access to the portal.

Use **Menu > To Do > To Do Management** to navigate to the portal.

To Do Information Search

This zone allows you to search for non-closed To Do entries using various attributes of the entries, and to perform actions on selected ones.

NOTE: Results are restricted by role. For supervisors, this search returns To Do entries that meet the search criteria and are in a role of which the supervisor is a member. For non supervisors, the search returns open To Do entries that meet the search criteria and are in a role of which the user is a member or entries currently assigned to the user. Refer to [To Do Entries Reference A Role](#) for more information about roles.

The following sections describe the features of this zone.

Search Filters

The following table describes each of the different filters in the To Do Information query zone.

Search Filter	Description
To Do Type	The zone requires the user to enter a To Do Type filter. Only To Do Types where the user is a member of at least one valid role for the type will be available for selection.
To Do Entry Status	Use this filter to restrict the search to To Do entries with a status of Open or Being Worked On . Note that the underlying query excludes completed To Do entries.
Days Old	Use these filters to restrict the search to To Do entries whose age falls within a given range in days. For example, entering values of 2 - 5 will restrict the search to entries that are greater than or equal to two days old and less than or equal to five days old.
Assign To User	Use this filter to restrict the search to To Do entries assigned to a particular user. This filter only appears if the current user has To Do supervisor access.
Priority	Use this filter to restrict the search to To Do entries with a specific priority.
Key Value	Use this filter to restrict the search to To Do entries with a sort key value containing the entered value.
Message	Use this filter to restrict the search to To Do entries with a specific message. This filter appears after the To Do Type filter has been populated and shows a list of the message texts from all non closed To Do entries of the selected To Do Type.
Characteristic	Use these filters to restrict the search to To Do entries with a specific Characteristic Type and value. Up to five characteristic type and value pairs may be entered. The list of characteristic types will be restricted to the characteristic types defined for the To Do Type, if applicable, or all valid characteristic types for the To Do Entry entity.

The system shows the total number of To Do entries displayed and the total number that satisfy your search criteria immediately below the set of results.

NOTE: For performance reasons, the search zone is configured to restrict the number of rows retrieved by the query. The 'Total Records' number will indicate whether there are more To Do entries that meet the criteria than can be displayed.

Search Results

The zone will display all To Do entries that meet the search criteria, up to the limit defined as a parameter to the zone. The following columns are displayed initially:

- The Action column includes the button Work. Click this button to drill into the page on which the entry's respective object is displayed. If the To Do type has been configured to associate a script with this To Do entry's message number, then instead of being taken to the respective page, the associated script is launched. Refer to [Working On A To Do Entry](#) for more information.

NOTE: Current To Do. Drilling into an entry from this page sets it to be the user's current To Do. Refer to [A User's Current To Do](#) for more information.

CAUTION: Automatic Assignment! When you click the Work button for an open entry, the system changes the status of the entry to **Being Worked On** and assigns it to you.

NOTE: Work List. This column has a Work List icon. Clicking this icon populates the [Work List](#) dashboard zone with the results. Clicking on entries in the Work List zone performs all the logic described here when clicking the Work button for one entry. It will drill into the related object or launch a script, if configured. It will make this To Do the 'current' To Do and will assign it to you if it is **Open**.

- Entries are sorted by their **Priority**. Highest in priority are listed first.
- **Days Old** is the number of days since the To Do entry was created by the system. Entries are sorted from youngest to oldest within priority.
- **Status** is the current status of the To Do entry.
- **Assign To User** is the user currently assigned to the To Do entry.
- **Message** is the message associated with the To Do entry.
- **Related** displays a count of entries that are potentially related to the current entry based on having the same foreign key characteristic values. Click the hyperlink to navigate to the [To Do Search](#) page with the current entry as the Related To Do Filter value.
- **Note** displays a Comment icon  if there are either comments or a log entry of type **Forwarded**, **Sent Back** or **User Details** on the To Do Entry. Click the icon to open a pop-up window which displays the To Do entry information, message, comments and logs.
- **Characteristics** displays the characteristic types and values for the entry as a concatenated string.
- **Related Entity** displays the information for the object related to this entry. The information string allows you to navigate to the page on which the entry's respective object is displayed.
- **To Do ID** is the system generated key of the entry. Click the hyperlink to navigate to the [To Do Entry](#) page to view or maintain the current entry.

Click the **Column Configuration** icon  in the zone header to show the [Column Configuration Area](#) in which additional columns can be added to the results. The additional columns include the following:

- **Create Date/Time** contains the date and time the To Do entry was created by the system.
- **Key 1 to Key 5** contain the first five sort key values for the entry.
- **To Do Role** displays the description of the role for the To Do entry.

Actions

The zone provides the ability to perform certain actions on one or more selected To Do Entries.

Click the check box in the results list heading to select all entries displayed in the grid or click the box in a row to select a specific entry. The following actions are available:

- Use the **Update** button to open a pop-up window in which you can update the priority and/or add a **User Details** log entry to the selected To Do entries.
- Use the **Assign** button to assign a user to the selected To Do entries. Supervisors will be presented with a pop-up window in which they can choose the assignee from a list of users who are members of at least one role for the To Do Type. For users without supervisor access, the current user is assumed to be the assignee and the window is not displayed. Note that the system does not allow a non supervisor to assign themselves a To Do that is being worked on by another user.
- Use the **Unassign** button to reopen the selected To Do entries and remove the assignee. Note that the system does not allow supervisors or non supervisors to reopen a To Do that is being worked on by another user.
- Use the **Complete** button to complete the selected To Do entries. Both supervisors and non supervisors may complete any To Do entry, including those assigned to other users.

To Do Supervisor Functions

This section describes several To Do transactions that aid supervisors in the monitoring and assignment of To Do entries.

Supervisor To Do Summary

This Supervisor To Do Summary page summarizes To Do entries by To Do Type. Only entries that are **Open** (i.e., not assigned to a specific user) or **Being Worked On** are summarized.

NOTE: Only To Do entries that are assigned to a role to which you belong are summarized on this page. Refer to [To Do Entries Reference A Role](#) for more information.

Use **Menu > To Do > Supervisor To Do Summary** to open this page.

Description of Page

This page summarizes all To Do entries that are **Open** or **Being Worked On**.

- **To Do Type** contains the description of the To Do type.
- **Priority** provides a total count of To Do entries of a given type by priority. For each distinct priority the description includes the priority value followed by the corresponding number of entries. If all entries are of the same priority no additional count is displayed.
- **Total** contains the total of **Open** and **Being Worked On** entries. The hyperlink navigates to the [Supervisor To Do Assignment](#) transaction, setting it to display all **Open** and **Being Worked On** entries for the given To Do Type.
- **Open** contains the number of To Do Entries whose status is **Open**. The hyperlink navigates to the [Supervisor To Do Assignment](#) transaction, setting it to display all **Open** entries for the given To Do Type.
- **Being Worked On** contains the number of To Do entries whose status is **Being Worked On**. The hyperlink navigates to the [Supervisor To Do Assignment](#) transaction, setting it to display all **Being Worked On** entries for the given To Do Type.

The "age bars" that appear to the right of the totals highlight the age of the To Do entries. The colors red, yellow and green are used to highlight the relative number of old, middle-aged and new To Do entries. The age associated with each of these colors is [user-configurable](#).

Supervisor User Summary

The Supervisor User Summary page summarizes To Do entries by the user who is assigned to work on the entries. Only entries that are **Being Worked On** are summarized.

NOTE: Only To Do entries that are assigned to a role to which you belong are summarized on this page. Refer to [To Do Entries Reference A Role](#) for more information.

Use **Menu > To Do > Supervisor User Summary** to open this page.

Description of Page

This page contains a grid that displays all assigned To Do entries by User ID and To Do type. It indicates how many To Do entries of the displayed Type are assigned to the user (Assigned this Type) and how many To Do entries in total are assigned to the user (Assigned Total).

Clicking the hyperlinks transfer you to the [Supervisor To Do Assignment](#) transaction. On this transaction, you can assign / reassign To Do entries to a specific user. The difference is that clicking the To Do Type hyperlink causes only **Open** entries to be displayed on the Assignment transaction. Clicking the count in the Assigned this Type column causes **Being Worked On** entries assigned to the displayed user to be shown.

Supervisor To Do Assignment

This page lists To Do entries of a given type and allows a supervisor to assign / reassign them to a designated user.

NOTE: Refer to the [To Do Management](#) portal for a page that provides many more filters to narrow down the results. In addition, it provides more data in the results and allows the user to adjust the priority of To Do entries.

Use **Menu > To Do > Supervisor To Do Assignment** to open this page.

Description of Page

This page contains **Open** or **Being Worked On** To Do entries of a given type. These entries can be assigned to a specified user one-by-one or several at a time. The following points describe this functionality:

- You can select a different **To Do Type** by typing in a value or pressing the search button in the upper right corner. An **Info** description of the To Do type appears on the left.
- You can change the list of entries displayed according to their status. Select the **Filter by** status to be All (blank), **Open**, or **Being Worked On**.
- For **Being Worked On** entries, you may also **Filter by User** to limit the search to a specific user assigned to the To Do entries.
- If you want to re-sort the entries by a different value, click the search button adjacent to **Extra Information**. Each row's respective sort value is displayed in the **Extra Information** column.

NOTE: Extra Information. Each To Do list's default **Extra Information** is defined on the list's [To Do Type](#). Also note that each To Do list's available **Extra Information** differs.

- Click the **Select All** button to select all entries displayed in the grid. Click the **Clear All** to remove the selections in the grid.
- Use the checkbox if you want to assign specific entries.
- Entries are further sorted by their **Priority**. Highest in priority are listed first.

- **Create Date/Time** contains the date and time the To Do entry was created by the system. Click the Create Date/Time hyperlink to navigate to the To Do page where additional information is visible and where additional actions are possible.
- Click the number of **Related** entries hyperlink to navigate to the [To Do Search](#) query to list potentially related entries to the current entry.
- **Worked By** shows the user currently assigned to the To Do entry.
- **To Do Entry Status** is the current status of the To Do entry.
- **Message** contains a description of the To Do entry. Use the message description hyperlink to drill into the page on which the entry's respective object is displayed. If the To Do type has been configured to associate a script with this To Do entry's message number, then instead of being taken to the respective page, the associated script is launched. Refer to [Working On A To Do Entry](#) for more information.
- You can assign entries to a user:
 - Enter a user ID or search for a user using the **Assign To User** field. You can only select a user that is associated with a role that is associated with this **To Do Type**. Note that the current number of assignments is displayed adjacent.
 - Select one or more entries to assign to this user and click the **Assign** button. The entries' status becomes **Being Worked On**.

To Do List Functions

This section describes To Do pages that aid users in the assignment and working of entries in To Do lists.

To Do Summary

This page summarizes To Do entries that meet the following qualifications:

- The entry is **Open** and you belong to the entry's To Do role. Refer to [To Do Entries Reference A Role](#) for more information about roles.
- The entry is **Being Worked On** and you are the user to which it is assigned.

Use **Menu > To Do > To Do Summary** to open this page.

Keyboard Shortcut	Alternate Shortcut
Alt+X	Alt+Shift+X

NOTE: Refer to [Shortcut Key Summary](#) for information about the alternate shortcut.

FASTPATH: Refer to [The Big Picture of To Do Lists](#) for an overview of To Do functionality.

Description of Page

This page is dedicated to a grid that summarizes the To Do entries on which you can work. The following information is displayed:

- **To Do Type** contains the description of the To Do type.
- **Priority** provides a total count of To Do entries of a given type by priority. For each distinct priority the description includes the priority value followed by the corresponding number of entries. If all entries are of the same priority no additional count is displayed.
- **Total** contains the total of **Open** and **Assigned to You** entries. The hyperlink navigates to the [To Do List](#) transaction, setting it to display all **Open** and **Being Worked On** entries assigned to you for the given To Do Type.

- **Open** contains the number of To Do Entries whose status is **Open**. The hyperlink navigates to the [To Do List](#) transaction, setting it to display all **Open** entries for the given To Do Type.
- **Assigned to You** contains the number of To Do entries that are assigned to you whose status is **Being Worked On**. The hyperlink navigates to the [Supervisor To Do Assignment](#) transaction, setting it to display all **Being Worked On** entries for the given To Do Type.

The "age bars" that appear to the right of the totals highlight the age of the To Do entries. The colors red, yellow and green are used to highlight the relative number of old, middle-aged and new To Do entries. The age associated with each of these colors is [user-configurable](#).

To Do List

This page lists To Do entries of a given type that are either **Open** (e.g., not assigned to a specific user) or are assigned to you.

NOTE: Refer to the [To Do Management](#) portal for a page that provides many more filters to narrow down the results. In addition, it provides more data in the results and allows the user to adjust the priority of To Do entries.

NOTE: Restricted by role. Only those entries assigned to a role to which you belong may be seen on this page. Refer to [To Do Entries Reference A Role](#) for more information.

FASTPATH: We recommend familiarizing yourself with the topics described in [The Big Picture of To Do Lists](#) to fully appreciate how To Do entries are managed by the system.

Use **Menu > To Do > To Do List** to open this page.

Description of Page

This page contains a grid that summarizes the To Do entries of a given type on which you can work.

The **Info** section contains a concatenation of the **To Do Type's** description and the user's name.

The area beneath **Info** provides you with options that control which To Do entries appear and the order in which they are displayed. The following points describe the various options:



- Use **Sort By** to define how you want the To Do entries sorted. The following options are available:
 - **Assigned Date - On or After.** This option sorts the To Do entries in chronological order (based on the date the entry was assigned to you) starting from the input **Date**. If you choose this option, the system assumes you want to start from the earliest To Do entry. If you want to start from a date other than the earliest To Do entry, enter the desired **Date** and click the adjacent search button.
 - **Assigned Date - On or Before.** This option sorts the To Do entries in reverse chronological order (based on the date the entry was assigned to you) starting from the input **Date**. If you choose this option, the system assumes you want to start from the today's date. If you want to start from a date other than today's date, enter the desired **Date** and click the adjacent search button.
 - **Create Date - On or After.** This option sorts the To Do entries in chronological order (based on the date the entry was created) starting from the input **Date**. If you choose this option, the system assumes you want to start from the earliest To Do entry. If you want to start from a date other than the earliest To Do entry, enter the desired **Date** and click the adjacent search button.
 - **Create Date - On or Before.** This option sorts the To Do entries in reverse chronological order (based on the date the entry was created) starting from the input **Date**. If you choose this option, the system assumes you want to start from the today's date. If you want to start from a date other than today's date, enter the desired **Date** and click the adjacent search button.
- **Extra Information.** This option sorts the To Do entries by the value of the **Extra Info**.

- Use **Extra Info** to choose data related to the To Do Entry that should be used to sort the To Do entries. This information is displayed in each entry's **Extra Information** column.

NOTE: Extra Info. Each To Do type's available **Extra Info** is defined on the [To Do Type Sort Keys](#). Also note that each To Do type's available **Extra Info** differs based on the configuration of the To Do Type.

- Use **Filter by** to restrict the To Do entries based on their status. The following options are available:
 - **All.** This option shows all entries that are **Open** or **Being Worked On**.
 - **Being Worked On.** This option shows all entries that are **Being Worked On** (and assigned to you).
 - **Open.** This option shows all entries that are **Open**.

The grid that follows contains the To Do entries that match your criteria. The following information appears:

- Click the **Select All** button to select all entries displayed in the grid. Click the **Clear All** button to remove the selections in the grid.
- Use the checkbox if you want to mark specific entries as **Completed** or **Being Worked On** using the **Complete** or **Assign** buttons at the bottom.
- A Comment icon  appears if there are comments on the To Do item and a Log Entry icon  appears if there is a log entry of type **Forwarded**, **Sent Back** or **User Details** on the To Do item. This column appears if at least one To Do has either comments or a special log entry.
- Entries are further sorted by their **Priority**. Highest in priority are listed first.
- **Create Date/Time** contains the date and time the To Do entry was created by the system.
- Click the Create Date/Time hyperlink or either of the special icons to navigate to the [To Do entry](#) page.
- Click the number of **Related** entries hyperlink to navigate to the [To Do Search](#) query to list potentially related entries to the current entry.
- **Assigned Date/Time** contains the date and time the To Do entry was assigned to a user. This field is only populated on entries that are **Being Worked On**. If a user assigned the To Do entry, the user ID and name of the user who assigned the To Do entry are displayed beneath the Date/Time.
- **Message** contains a description of the To Do entry. Use the message description hyperlink to drill into the page on which the entry's respective object is displayed. If the To Do type has been configured to associate a script with this To Do entry's message number, then instead of being taken to the respective page, the associated script is launched. Refer to [Working On A To Do Entry](#) for more information.

NOTE: Current To Do. Drilling into an entry from this page sets it to be the user's current To Do. Refer to [A User's Current To Do](#) for more information on how to efficiently scroll through additional entries in your current work list.

CAUTION: Automatic Assignment! When you drill into an entry using the message description hyperlink from this page, the system changes the status of the entry to **Being Worked On** and assigns it to you.

- **To Do Entry Status** is the current status of the To Do entry.
- **Extra Information** contains the data for the entry that corresponds to the Extra Info chosen in the sort options above.
- **To Do ID** contains the unique identifier of the To Do entry.
- If you want to mark one or more entries as **Being Worked On**, check the desired entries and then click the **Assign** button.
- If you want to mark one or more entries as **Completed**, check the desired entries and then click the **Complete** button. Completed entries do not appear on the To Do list (but they are retained on the database for audit purposes).

To Do Entry

The topics in this section describe the pages on which a To Do entry and its associated To Do log are maintained.

To Do Entry - Add Dialog

The To Do Entry transaction features a dialog that can add new To Dos (if the system is configured with [manual To Do types](#)). This dialog appears if you open the **Menu > To Do > To Do Entry > Add** (it also appears if you click the clear button when on the To Do Entry page).

Description of Page

The **To Do Type** is the type of To Do entry that you want to create. Only To Do types that are set up for manual usage appear in the list.

The default **To Do Type Priority** is displayed adjacent. Use **Override Priority** to override the default [priority](#) assigned by the system.

Type a **Subject** for your To Do entry. Depending on how the To Do type is set up, the subject may appear as the message in the To Do entry and To Do lists.

Enter a **Comment** to provide a longer description of and more details about the To Do entry.

Send To indicates whether the new To Do will be assigned to a **Role** (the default) or **User**.

The **Role** indicates the role to which this To Do entry will be assigned. Only users of the specified role will be able to view and work on the To Do entry. The role is defaulted from the To Do type. If you want to assign the To Do to a different role, change the specified role. You can only assign the To Do entry to one of the roles specified on the To Do type.

User appears if **Send To** is set to **User**. Use this option if you want to assign the To Do to a specific user. The user must be a member of the selected role.

If the [To Do type](#) defines valid characteristic types, the **Characteristics** collection is visible. If any of the characteristic types are flagged as Default on the To Do type, the characteristic type with its default value (if applicable) are displayed. If applicable use the characteristics to define other information related to this new To Do entry. In Oracle Utilities Customer Care and Billing, for example, you can link the account and premise that you are attempting to start service for.

Click **OK** to add the To Do Entry.

To Do Entry - Main

You use this page to perform various actions or modify details about a To Do entry. Use **Menu > To Do > To Do Entry > Search** to open this page.

NOTE: Restricted by role. Any user may change Comments for any To Do Entry. In addition, any user may add User Log details. However, for all other changes, you may only change To Do entries that are assigned to you or ones that are **Open** and assigned to a role to which you belong. Refer to [To Do Entries Reference A Role](#) for more information about roles.

Description of Page

To Do contains a concatenation of important information about the To Do entry. **To Do ID** is the system-assigned unique identifier of the entry. These values only appear after the case is added to the database.

NOTE: Formatting may be performed by a plug-in. Refer to [To Do Info May Be Formatted By An Algorithm](#) for more information.

To Do Type displays the entry's To Do Type and its description. Refer to [To Do Entries Reference A To Do Type](#) for more information about To Do types.

Role displays the role of the users who may be assigned to the entry along with a description of the role. Refer to [To Do Entries Reference A Role](#) for more information about roles.

Message is a display-only field that describes why the entry exists. If the To Do entry is in the status of **Open** or **Being Worked On**, the message description allows you to drill into the page on which the entry's respective object is displayed. If the To Do type has been configured to associate a script with this To Do entry's message number, then instead of being taken to the respective page, the associated script is launched. Refer to [Working On A To Do Entry](#) for more information.

Status indicates if the entry is **Open**, **Being Worked On**, or **Complete**. Refer to [The Lifecycle Of A To Do Entry](#) for more information status.

Use **Priority** to manually override the To Do entry's current [priority](#). Any manual change to the priority is recorded on the [To Do entry log](#).

Assigned To displays the user who is working the entry.

Sent By displays the user who assigned this To Do to the current user.

Created By only appears if a background process that uses To Do entries to report object-specific errors created the To Do entry. The field displays the background process description and batch run number in which the entry was created. Refer to [To Dos Created for Object-Specific Error Conditions](#) for more information.

Extract Info only appears if the To Do is being sent out of the system. Extract Info describes the status of the extract (for example whether it has been processed or not). Refer to [To Do Entries May Be Routed Out Of The System](#) for more information.

Use **Comments** to describe anything interesting or unusual about the To Do entry. The **Comments** field is disabled if the To Do entry is complete.

If the To Do entry has non-complete [related entries](#) a summary description appears below the comments line. The description states the total number of related entries, how many are still **Open**, how many are assigned to you and how many assigned to others. Use this hyperlink to navigate to the [To Do Search](#) query to list these entries.

The **Actions** buttons allow you to **Complete** the To Do, **Forward** the To Do to another user or Role, or **Send Back** a To Do that has been forwarded to you by another user. All buttons are disabled once a To Do is complete. Refer to [To Do Entry Actions](#) and the [How To](#) section for more information on using these actions.

The **Characteristics** collection is visible for **manual** To Do entries or for **automatic** To Do entries that have characteristics. **Characteristic Type** indicates the type of characteristic. Specify a valid **Characteristic Value** for the characteristic type.

NOTE: Only characteristic types defined as permissible on a To Do entry may be linked to a To Do. Refer to [Setting Up Characteristic Types & Their Values](#) for more information about characteristic types. In addition, for **manual** To Do types, the characteristic type must also be defined as valid for the To Do entry's [To Do type](#).

The **Log** grid displays log entries (in reverse chronological order) that audit the progress of a To Do entry. You cannot modify or delete log entries that have been created by the system. You can manually add a log entry of type **User Details** and you may remove a log entry before it is saved. Once a **User Details** log entry is saved, you cannot modify or delete it.

The Log grid displays the following information:

Log Date/Time displays the date and time when the log entry was created.

Log Type indicates the To Do entry event for which the log entry was created. For example, when the To Do entry is created, the Log Type indicates **Created**. For more information refer to the [Log Entry Events](#) table below.

The **Details** column contains user-specified or system-generated information about the log entry. This field is blank for some types of log entries.

Log User displays the user who caused the log entry to be created.

Assigned To displays the user to whom the To Do entry was assigned (if any).

To Do Entry - Keys/Values

The **Keys / Values** page contains detailed information about the sort keys and drill keys associated with a To Do entry. This information may not be modified. It is shown to assist support personnel.

Use **Menu > To Do > To Do Entry > Search** to search for the desired To Do entry, then navigate to the **Keys/Values** page.

Description of Page

The **Sort Keys** grid contains an entry's sort keys and values. This information is display-only.

FASTPATH: Refer to [To Do Type - Sort Keys](#) for more information.

The **Drill Keys** grid contains an entry's drill keys and values. This information is display-only.

FASTPATH: Refer to [To Do Type - Drill Keys](#) for more information.

To Do Entry Actions

You can perform the following actions on a To Do Entry.

Complete

Clicking **Complete** causes the To Do entry's status to be **Completed**. When you complete a To Do, a [log entry](#) is created that indicates when the To Do was completed and by whom. This button is enabled for To Do entries with a status of **Open** or **Being Worked On**.

FASTPATH: Refer to [The Lifecycle Of A To Do Entry](#) for more information.

Forward

Clicking **Forward** causes the Forward To Do Entry dialog to appear, allowing you to forward the To Do to another user or role. This button is enabled for **Open** To Do entries assigned to a role to which you belong or **Being Worked On** To Do entries assigned to you.

Send To indicates whether the To Do will be forwarded to a **Role** or **User** (the default).

User appears if **Send To** is set to **User**. The **User** indicates the user to which this To Do entry will be forwarded. The user must be a member of one of the roles specified for the To Do type.

Role is enabled if **Send To** is set to **Role** or if set to **User** and a User is specified. It indicates the role to which this To Do entry will be forwarded. Only users of the specified role will be able to view and work on the To Do entry. The role is defaulted from the To Do type. You can only forward the To Do entry to one of the roles specified on the To Do type. If forwarding to a user the role must also be valid for the specified user.

The **Details** field provides an explanation of why a user is forwarding the To Do. This information appears in the To Do log.

Click **OK** to forward the To Do entry.

Send Back

Clicking **Send Back** causes the Send Back To Do Entry dialog to appear, allowing you to send back the To Do to the user who forwarded it to you. This button is enabled if the To Do entry's status is **Being Worked On** and it was forwarded to you by another user.

User is a display only field that indicates the user who assigned you the To Do.

Role may be used to also change the entry's To Do Role. The role must be a permissible role specified on the To Do type that is also valid for the user this entry is sent back to. By default, if the sent to user is not a member of the entry's current role, the system automatically defaults the role to the first permissible role that is also valid for the user.

The **Details** field provides an explanation of a why the user is sending back the To Do or any other desired information. This information appears in the To Do log.

Click **OK** to send the To Do back to the assigning user.

Log Entry Events

The following table contains the events that cause a log entry to be created by the system.

Event	Log Type	To Do Entry Status	Content of Details	Content of Assigned To (on To Do entry and To Do Log)	Log User ID	Contents of Sent By (on To Do entry)
A To Do is created (by the system or by a user)	Created	Open			ID of user who created the To Do	
A To Do is created (by the system or by a user) in Being Worked On status	Created	Being Worked On		User ID of user who was assigned this To Do	ID of user who created the To Do	Creating user's ID
A To Do is completed (by the system or by a user)	Completed	Complete			ID of user who completed the To Do	
A user takes an open To Do	Assigned	Being Worked On	Selected by user	Assigned To User ID	Assigned To User ID	ID of user who assigned the To Do
A supervisor assigns a To Do to a user (also happens if they reassign)	Assigned	Being Worked On	Assigned to user	Assigned To User ID	ID of user who assigned the To Do	ID of user who assigned the To Do
A user forwards an entry to a user	Forwarded	Being Worked On	<i>Log details entered by user</i>	Forwarded To User ID	ID of user who forwarded the To Do	ID of user who forwarded the To Do
A user forwards an entry to a role	Forwarded	Open	Forwarded to role <i>Role Description (Role ID) + Log details entered by user</i>		ID of user who forwarded the To Do	ID of user who forwarded the To Do
A user sends back a To Do	Sent back	Being Worked On	<i>Log details entered by user</i>	Sent Back To User ID	ID of user who sent back the To Do	ID of user who sent back the To Do
A user adds a log entry	User Details	Status remains the same	<i>Log details entered by user</i>		ID of user who added the entry	

Event	Log Type	To Do Entry Status	Content of Details	Content of Assigned To (on To Do entry and To Do Log)	Log User ID	Contents of Sent By (on To Do entry)
A user manually overrides priority	Override Priority	Status remains the same	Priority changed from <i>old value</i> to <i>new value</i>	Assigned To User ID	ID of user who made the change	
Priority is updated by a calculate priority algorithm	Calculated Priority	Status remains the same	Priority changed from <i>old value</i> to <i>new value</i>		ID of user that added or updated the To Do or the user associated with the Recalculate Priority batch job.	

To Do Search

This page allows you to search for To Do entries using various search criteria, and perform various actions on selected ones. This page includes completed To Do entries in its search results, when applicable with respect to the filter criteria.

NOTE: Refer to the [To Do Management](#) portal for a page that provides many more filters to narrow down the results. In addition, it provides more data in the results and allows the user to adjust the priority of To Do entries.

NOTE: No restriction by role. This page returns all To Do entries that meet the search criteria, regardless of the To Do entry's role. Using the search, a user may drill into the details of a To Do entry even if the To Do is not assigned to the user. Refer to [To Do Entries Reference A Role](#) for more information about roles.

To Do Search - Main

Use **Menu > To Do > To Do Search** to open this page.

The top half of the page is where you enter the criteria used to search for To Do entries.

NOTE: Refer to the [To Do Management](#) portal for a page that provides many additional filters to narrow down the results. In addition, it provides more data in the results and allows the user to adjust the priority of To Do entries.

CAUTION: Try to be as specific as possible when entering search criteria. Why? Because entering open-ended search criteria may have a severe impact on response times.

The following table describes each of the different search filters.

Search Filter	Description
Related To Do	If you're searching for potentially related entries for a given To Do entry, choose Specific To Do for the Related To Do Filter . Enter the To Do ID . A filter value of Not Applicable defaults.
To Do Type	If you're searching for a To Do entry and you know the value of a To Do Type linked to the To Do entry, choose Specific To Do Type for the To Do Type Filter . Enter the To Do Type . A filter value of All defaults.
Char Type	If you're searching for a To Do entry and you know the value of a characteristic linked to the To Do entry, choose Specific Char Type for the Char Type Filter . Enter the Characteristic Type and Characteristic Value . A filter value of Not Applicable defaults.

Search Filter	Description
	Only characteristic types that include a characteristic entity of To Do Entry and that have been marked to allow searching by characteristic value are available.
User	Use this search method if you know the Created By User , Assigned To User or Completed By User for the To Do entry. Enter the appropriate User Id . A filter value of Not Applicable defaults.
Date Range	Use this field if you're searching for a To Do entry and know the Date Created or Date Completed . A filter value of Date Created defaults. The Start Date/Time defaults to the current date, 12:00AM and the End Date/Time defaults to the current date, 11:59PM. If you enter a Date Range Filter of All , the system ignores this search method.
Status	Use this search method to restrict the search to To Do entries with a specific status value. You may search for To Do entries in the status of Open , Being Worked On or Completed . You may also perform a combination search for To Do entries that have a status value of either Open or Being Worked On . A filter value of All defaults.



NOTE: The system allows any combination of values. The system does not try to validate your search combinations, even if they do not make sense. For example, if you enter a **User Filter** value of **Completed By User** and a **Status Filter** value of **Open**, you will not get an error. In this case, the system will find no records that match your criteria (because To Do entries that are Open do not have a Completed By User).

The system shows the total number of To Do entries that satisfy your search results immediately below the grid.

The first group of To Do entries is displayed in the grid at the bottom of the page.

- Click the **Select All** button to select all entries displayed in the grid. Click the **Clear All** to remove the selections in the grid.
- Use the checkbox if you want to assign, reopen or complete specific entries. Only **Open** or **Being Worked On** entries may be selected.

FASTPATH: Refer to [To Do Search Actions](#) and the [How To](#) section for more information on using these actions.

- A Comment icon  appears if there are comments on the To Do item and a Log Entry icon  appears if there is a log entry of type **Forwarded**, **Sent Back** or **User Details** on the To Do item. This column appears if at least one To Do item has either comments or a special log entry. Use either icon to navigate to the To Do entry page.
- Entries are sorted by their **Priority**. Highest in priority are listed first.
- **Create Date/Time** contains the date and time the To Do entry was created by the system. Use the hyperlink to navigate to the To Do entry page.
- Click the number of **Related** entries hyperlink to redisplay this page listing potentially related entries to the current entry.
- **Last Assigned Date/Time** contains the date and time the To Do entry was most recently assigned to a user, if applicable, along with the Assigned To user.
- **Message** contains a description of the To Do entry. If the To Do entry is in the status of **Open** or **Being Worked On**, the message description allows you to drill into the page on which the entry's respective object is displayed. If the To Do type has been configured to associate a script with this To Do entry's message number, then instead of being taken to the respective page, the associated script is launched. Refer to [Working On A To Do Entry](#) for more information.

NOTE: Current To Do. Drilling into the page by clicking the Message hyperlink does not automatically assign **Open** To Do entries to the user (as the To Do List page does when clicking on the Message). But it does treat this as

the user's current to do, enabling the functionality in the Current To Do dashboard zone. Refer to [A User's Current To Do](#) for more information.

- **Status** contains the current status of the To Do entry.
- **Completion Date/Time** contains the date and time the To Do entry was completed and the user who completed the entry, if applicable.
- **To Do Type** contains a description of the To Do type for the To Do entry.

To Do Search Actions

You can perform the following actions on selected To Do Entries.

Assign Selected Entries

Use the **Assign** button to assign or reassign the selected entries to a user. Enter a user ID or search for a user using the **Assign To User** field. By default this field is populated with the current user's ID. Note that the user's current number of assignments is displayed adjacent.

Upon successful processing, the selected entries are assigned to the specified user and the status of **Open** entries becomes **Being Worked On**. Additionally, a corresponding [log entry](#) is added to each To Do.

NOTE: Only users with **Supervisor Assignment** access rights may reassign entries that are not currently assigned to them.

Reopen Selected Entries

Use the **Reopen** button to unassign the selected entries from their users forwarding them back to their role.

Upon successful processing, the selected entries become **Open** and a corresponding [log entry](#) is added to each To Do.

Complete Selected Entries

Use the **Complete** button to complete the selected entries.

Upon successful processing, the selected entries become **Completed** and a corresponding [log entry](#) is added to each To Do.

FASTPATH: Refer to [The Lifecycle Of A To Do Entry](#) for more information.

How To

The following sections describe how to perform common tasks for To Dos.

How To Assign a To Do to a User

There are several ways to assign a To Do entry to a user:

- Use the [To Do Management](#) portal to search for and assign To Dos to yourself or, for supervisors, to other users. This portal provides many filters for narrowing down the list of results. In addition, it displays a rich amount of detail for the resulting To Do entries, helping users to make decisions.
- A supervisor can use the [Supervisor Functions](#) pages to review, assign and reassign To Dos to users.

- The [Supervisor To Do Summary](#) page summarizes by type the total, **Open** (unassigned) and **Being Worked On** (assigned) entries for roles to which you belong.
- The **Total**, **Open** or **Being Worked On** column hyperlinks transfers you to the [Supervisor To Do Assignment](#) page where you can assign / reassign one or more of the corresponding entries to a specific user.
- Use the [To Do List Functions](#) pages to review and assign To Dos to yourself.
 - The [To Do Summary](#) page summarizes by type the total, **Open** (unassigned) and **Being Worked On** (assigned to you) entries for roles to which you belong.
 - The **Open** column hyperlink transfers you to the [To Do List](#) page where you can assign one or more of the **Open** entries to yourself.
- You may also use the [To Do Search](#) page to find certain To Do entries based on various criteria and assign selected entries to a user.
- Forwarding an entry to a user using the [To Do Entry](#) page is yet another way of assigning an entry to a user.
- The [Current To Do](#) zone next assignment functionality can be configured to dynamically assign an **Open** To Do to the requesting user based on your organization's work assignment rules. Refer to this zone for more information.

How To Work on To Do Entries

Depending on your organization's [work distribution](#) practice, there are several ways to work on To Do entries.

When work is manually assigned, a typical approach may be to review the entries in a list and work them one entry at a time.

- You can use the [To Do Management](#) page to review and work on To Do entries by To Do type.
- You can use the [To Do List](#) page to review and work on To Do entries by type.
- You may also use the [To Do Search](#) page to find certain To Do entries based on various criteria and work on selected entries. For example, you may want to review and work on entries related to a given To Do.

All three pages provide functionality for making a selected To Do entry [the user's current To Do entry](#). This entry's key information is displayed on the [Current To Do](#) dashboard zone.

FASTPATH: Refer to [Working On A To Do Entry](#) for more information.

When work is assigned "on demand", click the **Assign me a To Do** button on the [Current To Do](#) dashboard zone to request your next task. The returned To Do entry automatically becomes your current To Do. The entry's key information is displayed on the zone.

FASTPATH: Refer to [Current To Do](#) zone to learn about all the functions it provides to efficiently resolve the current To Do and potentially other To Do entries that may be [related](#) to it.

To Do Work List

The system offers two ways to enable a list of To Do entries that a user may want to work through. In both methods, selecting another To Do to work on will cause that new To Do entry to become the Current To Do.

- When using the [To Do Management](#) portal, click the Work List icon in the Action column to populate the [Work List](#) zone in the dashboard with the results of the search. Users may click entries in this zone to work through the list of To Do entries.
- When using the [To Do List](#) or [To Do Search](#) pages, after drilling in on one of the To Do entry's message links, the other To Do entries that were in that results list on that page become your current work list and the **Previous** button and **Next** button are enabled in the [Current To Do](#) zone to work through that list.

If a To Do entry becomes current using the Current To Do zone's next assignment functionality, that entry is not associated with any work list to scroll through.

Complete a To Do

Once the current To Do's problem is resolved, mark the entry as **Complete**.

FASTPATH: Refer to [How To Complete To Dos](#) for more information.

How To Add a New To Do

If your system is configured with [manual To Do types](#), you can add a To Do entry online. Online To Do entries may be used like electronic help tickets in the system. In Oracle Utilities Customer Care and Billing, for example, if you are having a problem starting service, you can create a To Do that describes the problem. The To Do can be assigned to a help resolution group that could either resolve the problem or send the To Do back to you with information describing how to resolve the problem.

FASTPATH: Refer to [To Do Entry - Add Dialog](#) for more information.

How To Complete To Dos

When you complete a To Do, a log entry is added that indicates when the To Do was completed and by whom.

There are multiple ways in which you can complete a To Do.

- The [To Do Management](#) page provides many filters in addition to To Do Type. One or more entries may be completed in this page.
- The [To Do List](#) page allows you to complete one or more selected entries of a specific To Do Type.
- The [To Do Search](#) page allows you to search for To Do entries using various search criteria and complete selected ones.
- Use the [To Do Entry](#) page to complete a single To Do Entry.
- You may also use the [Current To Do](#) zone to complete the current entry you are working on and/or all [related](#) entries assigned to you.

NOTE: There are also situations where To Do entry is completed automatically by the system. Refer to [The Lifecycle of a To Do Entry](#) for more information.

How To Forward a To Do

If you have been assigned a To Do that you are unable to resolve, you can forward it to another user or role for help or additional instructions. When a To Do is forwarded, a log entry indicates who forwarded the To Do, to whom it was forwarded, and the specified reason.

- Use the **Forward** button on the [To Do Entry](#) page to forward a To Do entry to a role or a user.
- You may also use the **Unassign** button on the [To Do Management](#) portal or the **Reopen** button on the [To Do Search](#) page to forward selected entries back to their current role.

How To Send Back a To Do

If you have been forwarded a To Do by another user, you may send back the To Do with instructions to the forwarding user. When a To Do is sent back, a log entry is created that indicates when the To Do was sent back and by whom.

Use the **Send Back** button on the [To Do Entry](#) page to send back a To Do entry.

How To Add a Log Entry to a To Do

You can use the **Comments** section of a [To Do entry](#) to add a comment to the To Do as long as the To Do is **Open** or **Being Worked On**. However, the Comments field is disabled if the To Do entry is complete.

Alternatively, you can add a **User Details** log entry to a To Do at any time (even after it's completed). Refer to [To Do Entry](#) page for more information.

The [To Do Management](#) portal allows users to add a **User Details** log entry to one or more selected entries.

Reports

About Reports

Reports include operational reports related to device events, validation exceptions, and other operational data. Reports can also be based on devices, measuring components, Service Points, service providers, and other data.

Oracle Utilities Meter Data Management reports are implemented using Oracle Business Intelligence Publisher (BI Publisher), and are administered via Oracle Business Intelligence Publisher and the Report functionality of the Oracle Utilities Application Framework.

Refer to the [Oracle Business Intelligence Publisher documentation](#) for more information about installing Oracle Business Intelligence Publisher and [creating and defining reports](#). For additional details on how reports are defined and administered see [Reporting and Monitoring Tools](#) in the Oracle Utilities Application Framework *Administrative User Guide*.

Running Oracle Utilities Meter Data Management Reports

This portal is used to submit a new instance of a Report.

Refer to [About Reports](#) for additional functional information.

You can access the portal from the **Main > Tools > Report Submission**.

First, the appropriate Report code must be selected. The Reports provided out-of-the-box are:

- **Device Events Report:** this report generates a pie graph depicting the percentage of Device Events for each Device Event Type for the specific search criteria.
- **Device VEE Exceptions Report:** this report generates a pie graph depicting the percentage of VEE Exception for Exception Type and Market for the specific search criteria.

Next, enter the parameter values for the report as appropriate and submit the report.