

---

# PeopleTools 8.58: Application Designer Developer's Guide

---

**May 2020**

This software and related documentation are provided under a license agreement containing restrictions on use and disclosure and are protected by intellectual property laws. Except as expressly permitted in your license agreement or allowed by law, you may not use, copy, reproduce, translate, broadcast, modify, license, transmit, distribute, exhibit, perform, publish, or display any part, in any form, or by any means. Reverse engineering, disassembly, or decompilation of this software, unless required by law for interoperability, is prohibited.

The information contained herein is subject to change without notice and is not warranted to be error-free. If you find any errors, please report them to us in writing.

If this is software or related documentation that is delivered to the U.S. Government or anyone licensing it on behalf of the U.S. Government, then the following notice is applicable:

U.S. GOVERNMENT END USERS: Oracle programs (including any operating system, integrated software, any programs embedded, installed or activated on delivered hardware, and modifications of such programs) and Oracle computer documentation or other Oracle data delivered to or accessed by U.S. Government end users are "commercial computer software" or "commercial computer software documentation" pursuant to the applicable Federal Acquisition Regulation and agency-specific supplemental regulations. As such, the use, reproduction, duplication, release, display, disclosure, modification, preparation of derivative works, and/or adaptation of i) Oracle programs (including any operating system, integrated software, any programs embedded, installed or activated on delivered hardware, and modifications of such programs), ii) Oracle computer documentation and/or iii) other Oracle data, is subject to the rights and limitations specified in the license contained in the applicable contract. The terms governing the U.S. Government's use of Oracle cloud services are defined by the applicable contract for such services. No other rights are granted to the U.S. Government.

This software or hardware is developed for general use in a variety of information management applications. It is not developed or intended for use in any inherently dangerous applications, including applications that may create a risk of personal injury. If you use this software or hardware in dangerous applications, then you shall be responsible to take all appropriate fail-safe, backup, redundancy, and other measures to ensure its safe use. Oracle Corporation and its affiliates disclaim any liability for any damages caused by use of this software or hardware in dangerous applications.

Oracle and Java are registered trademarks of Oracle and/or its affiliates. Other names may be trademarks of their respective owners.

Intel and Intel Inside are trademarks or registered trademarks of Intel Corporation. All SPARC trademarks are used under license and are trademarks or registered trademarks of SPARC International, Inc. AMD, Epyc, and the AMD logo are trademarks or registered trademarks of Advanced Micro Devices. UNIX is a registered trademark of The Open Group.

This software or hardware and documentation may provide access to or information about content, products, and services from third parties. Oracle Corporation and its affiliates are not responsible for and expressly disclaim all warranties of any kind with respect to third-party content, products, and services unless otherwise set forth in an applicable agreement between you and Oracle. Oracle Corporation and its affiliates will not be responsible for any loss, costs, or damages incurred due to your access to or use of third-party content, products, or services, except as set forth in an applicable agreement between you and Oracle.

The business names used in this documentation are fictitious, and are not intended to identify any real companies currently or previously in existence.

#### Documentation Accessibility

For information about Oracle's commitment to accessibility, visit the Oracle Accessibility Program website at <http://www.oracle.com/pls/topic/lookup?ctx=acc&id=docacc>.

#### Access to Oracle Support

Oracle customers that have purchased support have access to electronic support through My Oracle Support. For information, visit <http://www.oracle.com/pls/topic/lookup?ctx=acc&id=info> or visit <http://www.oracle.com/pls/topic/lookup?ctx=acc&id=trs> if you are hearing impaired.

# Contents

<b>Preface: Preface.....</b>	<b>xvii</b>
Understanding the PeopleSoft Online Help and PeopleBooks.....	xvii
Hosted PeopleSoft Online Help.....	xvii
Locally Installed Help.....	xvii
Downloadable PeopleBook PDF Files.....	xvii
Common Help Documentation.....	xvii
Field and Control Definitions.....	xviii
Typographical Conventions.....	xviii
ISO Country and Currency Codes.....	xviii
Region and Industry Identifiers.....	xix
Translations and Embedded Help.....	xix
Using and Managing the PeopleSoft Online Help.....	xx
Understanding PeopleSoft Application Designer.....	xx
PeopleTools Related Links.....	xx
Contact Us.....	xxi
Follow Us.....	xxi
<b>Chapter 1: Getting Started with PeopleSoft Application Designer.....</b>	<b>23</b>
PeopleSoft Application Designer Overview.....	23
PeopleSoft Application Designer Implementation.....	23
Installation-Level Steps.....	23
Main Application Development Steps.....	24
<b>Chapter 2: Using PeopleSoft Application Designer.....</b>	<b>27</b>
Understanding PeopleSoft Application Designer.....	27
Using PeopleSoft Application Designer.....	27
Understanding the Eight Steps of Application Development.....	27
Starting PeopleSoft Application Designer.....	29
Using the PeopleSoft Application Designer User Interface.....	31
Setting PeopleTools Options.....	39
Working with Keyboard Shortcuts.....	42
Using the PeopleCode and Other Programming Language Editors.....	43
Accessing and Using the PeopleCode Editor.....	43
Using Additional Programming Language Editors.....	46
Working with Definitions.....	48
Understanding Definitions.....	48
Opening Definitions.....	50
Viewing Definitions.....	52
Viewing and Editing Definition Properties.....	52
Creating Definitions.....	54
Saving Definitions.....	54
Closing Definitions.....	55
Renaming Definitions.....	55
Deleting Definitions.....	56
Finding Definition References.....	57
Using the Multiple Document Interface.....	64
Using Drag-and-Drop Mouse Techniques.....	65
Using Dynamic Toolbars and Menus.....	66

Using Pop-up Menus.....	66
Configuring the Application Designer User Interface.....	67
Working with Generated Files.....	69
Using Miscellaneous Definitions.....	69
Using the PeopleSoft Application Designer Spell Check Feature.....	71
Understanding the Spell Check Feature.....	71
Enabling the Spell Check Feature.....	75
Configuring Browser Options.....	75
Building and Maintaining Data.....	77
Building and Maintaining Data.....	77
Creating SQL Tables.....	77
Using PeopleSoft Application Designer Command Line Parameters.....	77
<b>Chapter 3: Working With Projects.....</b>	<b>79</b>
Understanding Projects.....	79
Viewing Projects.....	79
Accessing Project Definitions.....	79
Using the Upgrade View.....	80
Creating and Saving Projects.....	81
Creating New Projects.....	81
Saving Projects.....	82
Setting Project Properties.....	82
Inserting Definitions Into Projects.....	83
Inserting Individual Definitions into a Project.....	84
Inserting a Group of Definitions into a Project.....	84
Removing Definitions From Projects.....	85
Merging Projects.....	86
Using Change Projects.....	87
Setting Project Options.....	87
Validating Projects.....	89
Setting System IDs.....	90
<b>Chapter 4: Creating Field Definitions.....</b>	<b>93</b>
Understanding Field Definitions.....	93
Creating New Field Definitions.....	93
Prerequisite.....	94
Creating a New Field Definition.....	94
Specifying Attributes for a New Field Definition.....	95
Specifying Character Field Attributes.....	96
Specifying Long Character Field Attributes.....	99
Specifying Number Field Attributes.....	100
Specifying Date Field Attributes.....	101
Specifying Time Field Attributes.....	102
Specifying Datetime Field Attributes.....	102
Specifying Image Field Attributes.....	102
Specifying ImageReference Field Attributes.....	103
Working With Additional Oracle Data Type Mappings.....	103
Working With Additional Microsoft SQL Server 2005 Data Type Mappings.....	104
Using Multiple Labels.....	105
Understanding Multiple Labels.....	105
Adding a New Label.....	106
Deleting a Label.....	107
Selecting Record Field Labels.....	107

Opening an Existing Field Definition.....	108
Viewing Field Properties.....	109
Changing Field Definitions.....	110
Understanding the Effects of Changing Field Definitions.....	110
Changing Field Types.....	110
Renaming Field Definitions.....	111
Deleting Field Definitions.....	112
Printing Field Definitions.....	113
Setting Custom Field Formats.....	113
Understanding Custom Field Formats.....	113
Understanding Format Notation.....	113
Changing Format Families.....	117
Editing Formats.....	118
Using Family Options.....	120
Testing Formats.....	121
Using the Translate Table.....	122
Understanding the Translate Table.....	123
Adding Values to the Translate Table.....	124
Changing Translate Values.....	125
Deleting Translate Values.....	126
Saving the Translate Table.....	126
<b>Chapter 5: Planning Records, Control Tables, and Tablesets.....</b>	<b>127</b>
Understanding the Planning Process.....	127
Table-Based Systems.....	127
Normalized Relational Databases.....	128
Record Definition Planning.....	130
Effective Dates.....	130
Control Tables.....	132
Tablesets.....	133
Sharing Tables.....	136
Understanding Table Sharing.....	137
Adding the SETID Field to Record Definitions.....	139
Defining Set Control Fields.....	139
Modifying Set Control Fields.....	140
Creating SetIDs.....	141
Defining Record Groups.....	141
Defining Tableset Controls.....	141
Sharing Trees.....	142
<b>Chapter 6: Creating Record Definitions.....</b>	<b>145</b>
Understanding Record Definitions.....	145
Understanding Record Types.....	146
Working with Global Temporary Tables.....	148
Working with Materialized Views.....	149
Viewing Record Definitions.....	150
Common Elements Used in This Section.....	151
Viewing Basic Field Definitions.....	151
Viewing Key-Related Characteristics and Default Values.....	151
Viewing Editing Options.....	152
Viewing PeopleCode Program Types.....	153
Reordering Fields.....	153
Sizing and Sorting Columns.....	154

Saving Record Definitions.....	154
Naming Record Definitions.....	154
Creating New Record Definitions.....	155
Opening Existing Record Definitions.....	156
Manipulating Fields in Record Definitions.....	156
Understanding Fields in Record Definitions.....	156
Inserting Fields Into Records.....	156
Inserting Subrecords into Records.....	157
Setting Record Properties.....	158
Setting General Properties.....	158
Setting Use Properties.....	159
Creating User-Defined Audit Record Definitions.....	162
Setting Record Field Properties.....	163
Understanding Record Field Properties.....	163
Understanding Record Key Considerations.....	164
Setting Record Field Use Properties.....	166
Configuring Search Results Grid Columns in Persistent Searches.....	174
Adding From and Through Logic to a Search Page.....	174
Setting Record Field Edit Properties.....	176
Moving Fields in the Same Record.....	179
Moving Fields to Another Record Definition.....	180
Deleting Fields From a Record Definition.....	181
Renaming Record Definitions.....	181
Deleting Record Definitions.....	182
Printing Record Definitions.....	182
Creating SQL View and Dynamic View Select Statements.....	185
<b>Chapter 7: Administering Data.....</b>	<b>187</b>
Understanding Data Administration and the Build Process.....	187
Running the Build Process.....	188
Understanding the Build Menu.....	188
Selecting the Build Scope.....	191
Selecting Build Options and Running the Build Process.....	191
Creating Tables.....	193
Understanding the Create Table Process.....	193
Creating a Table.....	194
Specifying Create Options.....	195
Specifying Logging Options.....	197
Specifying Script Options.....	201
Confirming a Table Build.....	205
Creating Indexes.....	206
Understanding Indexes.....	206
Configuring Indexes.....	208
Adding a Custom Index.....	209
Editing the DDL.....	210
Altering Tables.....	211
Understanding the Alter Process.....	211
Determining Tables To Be Altered After a Field Change.....	216
Altering a Table.....	216
Specifying Alter Options.....	217
Confirming Your Table Alter.....	220
Creating Triggers.....	221

Creating Views.....	221
Understanding Online Views.....	221
Creating Views.....	222
Using Joins in Views.....	222
Using Cross-Platform Meta-SQL for Dynamic Views.....	223
Administering DDL.....	223
Using the Record DDL.....	223
Setting the Tablespace.....	224
Using Physical Data Storage.....	225
Managing Partition DDL.....	226
<b>Chapter 8: Using Page Controls.....</b>	<b>229</b>
Understanding Page Controls.....	229
Aesthetic Controls.....	229
Data Entry Controls.....	230
Function and Data Processing Controls.....	232
Using Charts.....	233
Using Frames.....	234
Using Group Boxes.....	235
Inserting and Moving a Group Box.....	235
Setting Group Box Properties.....	235
Using Horizontal Rules.....	239
Drawing a Horizontal Rule.....	239
Setting Horizontal Rule Properties.....	239
Using Images.....	240
Understanding Static Images.....	240
Adjusting Static Image Size and Shape.....	240
Setting Static Image Properties.....	241
Setting Image Properties.....	242
Using Static Text.....	243
Using Check Boxes.....	244
Setting Check Box Properties.....	244
Using Drop-Down List Boxes.....	245
Setting Drop-Down List Box Record Properties.....	245
Setting Drop-Down List Box Label and Use Properties.....	246
Using Radio Buttons.....	246
Understanding Radio Buttons.....	246
Setting Radio Button Record Properties.....	246
Setting Radio Button Label Properties.....	247
Setting Radio Button Use Properties.....	247
Using Edit Boxes and Long Edit Boxes.....	247
Long Edit Box Character Limit Counter.....	248
Mouse Over Pop-up Edit Boxes.....	250
Display-Only Edit Boxes.....	250
Rich Text-Capable Long Edit Boxes.....	251
Display in Modal Window.....	251
Protecting Sensitive Field Data Online.....	251
Using Pop-up Pages.....	253
Understanding Pop-up Pages.....	253
Defining Pop-up Pages.....	256
Associating Pop-up Pages with Fields.....	257
Enabling Message Catalog Pop-up Pages.....	257

Understanding Pop-up Pages in Screen Reader Mode.....	262
Using Subpages.....	262
Understanding Subpages.....	262
Defining Subpages.....	263
Inserting Subpages Into Pages.....	263
Specifying Informational Subpage Labels.....	264
Using Secondary Pages.....	264
Understanding Secondary Pages.....	265
Understanding Modal Secondary Pages.....	265
Defining Secondary Pages.....	267
Inserting Secondary Page Controls.....	269
Associating Secondary Pages With Primary Pages.....	270
Using HTML Areas.....	270
Understanding HTML Area Controls.....	271
Inserting HTML Areas.....	273
Populating HTML Areas.....	273
Changing HTML Area Labels.....	275
Including Fields Within HTML Areas in the Page Tab Order.....	277
Using Push Buttons and Links.....	278
Understanding Push Buttons and Links.....	278
Inserting Push Buttons or Links.....	279
Specifying Type Properties for Push Buttons or Links.....	279
Specifying Label Properties for Push Buttons or Links.....	285
Specifying Use Properties for Push Buttons or Links.....	289
Programmatically Change Hover Text for Push Buttons or Links.....	293
<b>Chapter 9: Using Scroll Areas, Scroll Bars, and Grids.....</b>	<b>295</b>
Understanding Scroll Areas, Scroll Bars, and Grids.....	295
Using Scroll Areas and Scroll Bars.....	295
Understanding Scroll Areas and Scroll Bars.....	295
Setting Scroll Area General Attributes.....	297
Setting Scroll Area Label Properties.....	299
Setting Scroll Area Use Properties.....	306
Setting Scroll Bar Label Properties.....	307
Setting Scroll Bar Use Properties.....	307
Controlling Scrollable Data.....	309
Converting Scroll Bars to Grids.....	310
Using Grids.....	310
Understanding Grids.....	311
Understanding Grid Properties.....	311
Understanding Grid Personalization.....	312
Inserting and Resizing Grid Controls.....	313
Inserting and Manipulating Grid Columns.....	313
Setting Column Properties.....	315
Creating Tabbed Grids.....	317
Freezing Grid Columns.....	319
Using Multiple Grids on a Page.....	320
Enabling and Disabling Grid Personalization.....	320
Setting Grid General Properties.....	321
Setting Grid Label Properties.....	324
Setting Grid Use Properties.....	333
Configuring Embedded Help for Scroll Areas, Grids, and Group Boxes.....	342



Entering Embedded Help Messages in the Message Catalog.....	342
Associating Help Messages with Scroll Areas, Grids, and Group Boxes.....	345
<b>Chapter 10: Creating Page Definitions.....</b>	<b>347</b>
Understanding Page Design and Development.....	347
Level-Based Controls.....	347
Keys for Accessing Pages.....	351
Multiple Occurrences of Data.....	352
Prompt Fields.....	353
Derived and Work Fields.....	355
Sensitive Data.....	355
Hidden Pages.....	355
Upgrade Considerations.....	355
End-User Page Personalization.....	356
Using Page Development Tools.....	356
Using Page Definition Menus.....	356
Using Page Definition Toolbars.....	357
Using the Page Layout Grid.....	360
Creating New Page Definitions.....	360
Cloning Page Definitions.....	361
Creating a Blank Page.....	361
Adding Page Controls.....	361
Dragging Field Definitions From a Record Onto a Page.....	362
Dragging Record Fields from the Project Workspace onto a Page.....	362
Dragging Record Definitions Onto a Page.....	362
Using the Page Control Toolbar.....	363
Using the Insert Menu.....	364
Manipulating Page Controls.....	364
Selecting Controls.....	364
Resizing Controls.....	365
Using the Page Control Inspector.....	365
Deleting Controls.....	366
Moving Controls on the Same Page.....	367
Copying and Moving Controls to Another Page.....	367
Positioning Page Control Labels.....	367
Setting Page Field Properties for Controls.....	370
Using the Property Window.....	370
Setting Record Properties.....	371
Setting Label Properties.....	378
Setting Use Properties.....	382
Setting General Properties.....	390
Setting Options Properties.....	392
Modifying the Rich Text Editor User Interface.....	395
Securing CKEditor.....	396
Creating Custom Configurations.....	396
Creating Custom Template Files.....	396
Creating Custom Style Files.....	397
Creating Custom Plug-In Files.....	398
Modifying the Default Image Storage Location.....	398
Creating Display Control and Related Fields.....	399
Using Display Control and Related Fields.....	399
Creating Related Edit Fields.....	400

Creating Invisible Control Fields.....	401
Ordering and Spacing Page Controls.....	402
Understanding the Page Definition Order Tab.....	402
Understanding Page Control Order and Spacing.....	403
Ordering Controls Visually.....	403
Ordering Controls Logically.....	403
Testing Page Control Order.....	404
Applying Control Order Rules.....	405
Changing Control Order Using the Order Tab.....	405
Finding a Field on a Page Definition.....	406
Using Default Order.....	406
Spacing Controls on Pages.....	407
Designing Inquiry Pages.....	407
Aligning Page Controls and Page Control Labels.....	407
Maximizing Performance.....	408
Accessing PeopleCode in Page Definitions.....	410
Previewing Pages in the Browser.....	411
Working With the View in Browser Feature.....	411
Previewing Fluid Pages.....	412
Previewing Classic Pages.....	417
Maintaining the List of Browsers.....	423
Generating HTML.....	424
Configuring Drop Zones.....	424
Understanding Drop Zones.....	424
Inserting Configurable Drop Zones.....	425
Creating Custom Subpages for Drop Zones.....	429
Configuring Drop Zones.....	431
Producing Pages.....	434
Understanding Page Production.....	434
Changing General Page Information.....	434
Changing Page Use Information.....	435
Setting Fluid Properties for Pages.....	438
Saving Pages.....	438
Renaming and Deleting Pages.....	439
Printing Page Definitions.....	439
Altering Page Setup.....	439
Reading a Page Definition Report.....	440
Working with Pages in Foreign Languages.....	442
Understanding Working with Pages in a Foreign Language.....	442
Performing a Save As Using Foreign Language Pages.....	442
Deleting Foreign Language Pages.....	443
Improving Online Performance.....	443
Understanding Processing Modes.....	443
Refreshing Pages.....	444
Triggering Server Processing.....	444
Working with Page Controls In Interactive Mode.....	445
Using PeopleCode in Deferred Mode.....	445
Using Page Controls in Deferred Mode.....	446
Using Error and Warning Messages.....	448
Processing on Autocomplete Fields.....	448
Enabling Automatic Save for a Page.....	449

<b>Chapter 11: Creating Component Definitions.....</b>	<b>451</b>
Understanding Component Definitions.....	451
What Component Definitions Manage.....	451
The Component Buffer.....	452
Defining Components.....	453
Understanding the Component Definition Window.....	453
Creating New Component Definitions.....	454
Opening Existing Component Definitions.....	455
Adding Pages to Components.....	455
Reordering Pages in a Component.....	456
Copying or Moving Pages to Another Component.....	457
Setting Page Attributes.....	457
Validating Components.....	459
Specifying Market-Specific Components.....	460
Locating Component Definition References In Menus.....	461
Setting Component Properties.....	461
Opening the Component Properties Dialog Box.....	461
Setting General Properties.....	461
Setting Use Properties.....	461
Setting Internet Properties.....	465
Setting Fluid Properties.....	471
Setting Style Properties.....	472
Reworking Components for Classic Plus Display.....	475
Using Search Records.....	476
Understanding Search Records.....	476
Understanding Search Records and Recent (Persistent) Search Results.....	478
Creating Search Records.....	482
Overriding Search Records.....	482
Accessing the Message Catalog.....	482
Enabling the Expert Entry Feature in the Security Component.....	483
Understanding the Expert Entry Feature.....	483
Enabling Expert Entry in Security.....	484
<b>Chapter 12: Creating Menu Definitions.....</b>	<b>487</b>
Understanding Menus.....	487
Defining Custom Component Menus.....	487
Creating Custom Component Menus.....	487
Setting Menu Item Properties.....	488
Setting General Properties.....	489
(Optional) Setting Use Properties.....	490
Working With Menu Definitions.....	490
Adding Components to a Menu.....	490
Renaming Menu Definitions.....	490
Copying Menu Definitions.....	491
Deleting Menu Items.....	491
Printing Menu Definitions.....	492
Setting Up Menu Security.....	492
Importing Menu Groups Into Portals.....	492
Defining Pop-up Menus.....	492
Understanding Pop-up Menus.....	493
Creating Pop-up Menus.....	494
Defining Transfer Menu Items.....	495

<b>Chapter 13: Using the Registration Wizard.....</b>	<b>499</b>
Understanding the Registration Wizard.....	499
Common Elements Used in This Topic.....	499
Component Registration.....	499
Registering Components and iScripts.....	500
Registering Components in Multiple Portals.....	506
<b>Chapter 14: Creating Style Sheet Definitions.....</b>	<b>507</b>
Understanding Style Sheets and Style Classes.....	507
Overview of Style Sheets and Style Classes.....	507
Style Sheet Types.....	508
Style Classes.....	511
Creating Standard and Sub Style Sheets.....	512
Creating Standard Style Sheets or Sub Style Sheets.....	513
Renaming Standard Style Sheets or Sub Style Sheets.....	513
Deleting Standard Style Sheets or Sub Style Sheets.....	514
Inserting Sub Style Sheets into Style Sheets.....	514
Inserting Style Classes into Style Sheets.....	514
Inserting Override Style Classes into Style Sheets.....	515
Setting Style Class Attributes.....	515
Understanding Class Attributes.....	516
Understanding Generic and Installed Fonts.....	516
Accessing Class Attributes.....	517
Specifying Fonts.....	517
Setting Font Attributes for a Specific Language.....	519
Specifying Spacing and Alignment.....	519
Specifying Background Attributes.....	522
Referencing a Background Image URL.....	524
Specifying Border Attributes.....	524
Specifying Margins.....	526
Specifying Miscellaneous Attributes.....	528
Working With Free Form Sub Style Sheets.....	532
Creating Free Form Sub Style Sheets.....	532
Inserting Free Form Sub Style Sheets into Standard Style Sheets.....	533
Converting Style Sheets to Free Form Sub Style Sheets.....	533
Renaming Free Form Sub Style Sheets.....	533
Deleting Free Form Sub Style Sheets.....	534
Including Meta-Variables and Comments in Free Form Sub Style Sheets.....	534
Changing Font and Color Settings in Free Form Sub Style Sheets.....	535
Working with the Default Style Sheet.....	536
Working with PSSTYLEDEF.....	537
Working with PSSTYLEDEF_SWAN.....	538
Working with PSSTYLEDEF_TANGERINE.....	539
Changing the Default Style Sheet.....	540
Configuring Other Default Style Sheets.....	540
Overriding Default Page Style Properties.....	540
Overriding the Default Page Style Sheet.....	541
Overriding the Default Page Background Style.....	541
Overriding the Default Page Field Styles.....	542
Modifying Page Tabs.....	543
Understanding Tabs.....	543
Creating Tab Images.....	544

Customizing Page Tab Style Sheets.....	545
Modifying Push Buttons in SWAN Style Sheets.....	546
Understanding Push Button in the SWAN Style Sheet.....	546
Creating SWAN Style Sheet Push Button Images.....	546
Customizing SWAN Push Buttons in HTML Areas.....	546
Style Sheets Definitions List.....	547
<b>Chapter 15: Creating Image Definitions.....</b>	<b>583</b>
Understanding Image Definitions.....	583
Understanding the Image Catalog.....	584
Creating Image Definitions.....	585
Creating Image Definitions.....	585
Setting Image Properties.....	586
Importing and Creating Alternate Image Types.....	586
Opening Image Definitions.....	587
Updating Image Definitions.....	587
Updating Image Definitions.....	588
Changing an Image Display Size.....	588
Specifying an Image Storage Format.....	588
Converting Images to JPGs.....	589
Consolidating Images.....	590
<b>Chapter 16: Creating HTML Definitions.....</b>	<b>593</b>
Understanding HTML Definitions.....	593
Creating HTML Definitions.....	594
Opening HTML Definitions.....	594
Referencing HTML Definitions Dynamically.....	594
Working with JavaScript in HTML Definitions.....	595
Understanding PeopleTools Minified JavaScript.....	595
Disabling JavaScript Minification for a PIA Domain.....	596
Disabling JavaScript Minification for the Current User.....	596
<b>Chapter 17: Constructing File Layouts and Performing Data Interchanges.....</b>	<b>597</b>
Understanding File Layouts.....	597
File Layouts.....	597
Field Formats in a Flat File.....	598
FIXED Format Files.....	599
CSV Format Files.....	599
XML Format Files.....	601
Constructing File Layouts.....	603
Creating New File Layout Definitions.....	603
Adding File Records and File Fields.....	604
Reordering File Layout Nodes.....	606
Naming File Layouts, Records, and Fields.....	607
Applying Field Formats.....	607
Specifying File Layout, Record, and Field Properties.....	608
Specifying File Layout Properties.....	609
Specifying File Record Properties.....	612
Specifying File Field Properties.....	615
Performing Data Interchanges.....	619
Understanding the Import Process.....	619
Previewing Input Data.....	621
Generating and Running the Import Program.....	623
Exporting Data.....	623

Producing Sample File Layouts.....	623
Creating File Layout Definitions.....	624
Adjusting File Layout Properties.....	625
Inserting Segments and Fields.....	626
<b>Chapter 18: Using Change Control.....</b>	<b>629</b>
Understanding Change Control Features.....	629
Change Control Locking.....	629
Change Control History.....	631
Change Control Stamping.....	632
Understanding Implementation Considerations.....	633
Understanding Change Control Information Reporting.....	634
PeopleTools Definition Types.....	635
PeopleCode Definition Types.....	637
Change Control Supported Definition Types.....	638
Setting Up Change Control.....	639
Understanding Change Control Security.....	639
Appointing a Change Control Administrator.....	640
Enabling or Disabling Change Control.....	640
Using Projects.....	641
Understanding Projects.....	641
Using Multiple Databases for Development.....	641
Using Distributed Development Environments.....	642
Using Change Control.....	642
Locking and Unlocking Definitions.....	642
Viewing Locked Definitions.....	644
Inserting Comments.....	644
Deleting Page Definitions.....	646
Viewing Change Control History.....	646
<b>Appendix A: Understanding Functional Indexes.....</b>	<b>649</b>
Functional Indexes for Microsoft SQL Server.....	649
<b>Appendix B: Referencing Selections for Command Line Parameters.....</b>	<b>651</b>
Database Type Selections.....	651
Definition Type Selections.....	651
Language Selections.....	656
Available Release Numbers.....	658
<b>Appendix C: Using Default Style Classes.....</b>	<b>659</b>
Default Style Classes.....	659
<b>Appendix D: Modifying Classic Style Sheet Tabs.....</b>	<b>673</b>
Understanding Classic Tab Definitions.....	673
Modifying Classic Style Sheet Tabs.....	674
Creating Tab Images.....	674
<b>Appendix E: Using Images in PeopleSoft Applications.....</b>	<b>679</b>
Understanding Image-Related Elements.....	679
Using PeopleTools Image Definitions.....	680
Generating a List of Images in the Image Catalog.....	684
Viewing All Images in the Image Catalog.....	684
<b>Appendix F: Performing Bulk Operations.....</b>	<b>687</b>
Understanding Bulk Operations.....	687
Performing Bulk Insertions.....	687
Common Elements Used in This Section.....	688
Inserting Fields into Records.....	688

Inserting Record Fields onto Pages.....	688
Inserting Fields into Records and onto Pages.....	689
Performing Bulk Modifications.....	689
Modifying Record Fields.....	689
Modifying Page Fields.....	690
Reordering or Resizing Grid Fields.....	690
Changing Page Field Attributes.....	691
Performing Bulk Deletions.....	691
<b>Appendix G: Running PeopleTools Cross-Reference Reports.....</b>	<b>693</b>
Understanding Cross-Reference Reports.....	693
Running SQR Reports.....	694
<b>Appendix H: Creating Custom Plug-In Files for the Rich Text Editor.....</b>	<b>697</b>
Creating Custom Buttons.....	697
Using Images with Plug-Ins.....	697
Adding Multilingual Support.....	698
Adding Plug-Ins to the Configuration File.....	698
Specifying the Plug-In File ID Value.....	699
<b>Appendix I: Configuring Rich Text-Enabled Fields to Store Accented Western European</b>	
<b>Characters.....</b>	<b>701</b>
Enabling Field-Level Support For Accented Characters.....	701
Enabling System-Wide Support For Accented Characters.....	702
Sample config_psft.js File.....	703
<b>Appendix J: Configuring Embedded Help to Display UPK Content.....</b>	<b>705</b>
Modifying the UPK Player Package Link.....	705
Adding UPK-Based URLs to the Application.....	706
Embedding UPK-Based URLs in Messages.....	706
Adding Embedded Help to Page Controls.....	707





# Preface

---

## Understanding the PeopleSoft Online Help and PeopleBooks

The PeopleSoft Online Help is a website that enables you to view all help content for PeopleSoft applications and PeopleTools. The help provides standard navigation and full-text searching, as well as context-sensitive online help for PeopleSoft users.

### Hosted PeopleSoft Online Help

You can access the hosted PeopleSoft Online Help on the [Oracle Help Center](#). The hosted PeopleSoft Online Help is updated on a regular schedule, ensuring that you have access to the most current documentation. This reduces the need to view separate documentation posts for application maintenance on My Oracle Support. The hosted PeopleSoft Online Help is available in English only.

To configure the context-sensitive help for your PeopleSoft applications to use the Oracle Help Center, see [Configuring Context-Sensitive Help Using the Hosted Online Help Website](#).

### Locally Installed Help

If you're setting up an on-premise PeopleSoft environment, and your organization has firewall restrictions that prevent you from using the hosted PeopleSoft Online Help, you can install the online help locally. See [Configuring Context-Sensitive Help Using a Locally Installed Online Help Website](#).

### Downloadable PeopleBook PDF Files

You can access downloadable PDF versions of the help content in the traditional PeopleBook format on the [Oracle Help Center](#). The content in the PeopleBook PDFs is the same as the content in the PeopleSoft Online Help, but it has a different structure and it does not include the interactive navigation features that are available in the online help.

### Common Help Documentation

Common help documentation contains information that applies to multiple applications. The two main types of common help are:

- Application Fundamentals
- Using PeopleSoft Applications

Most product families provide a set of application fundamentals help topics that discuss essential information about the setup and design of your system. This information applies to many or all applications in the PeopleSoft product family. Whether you are implementing a single application, some combination of applications within the product family, or the entire product family, you should be familiar with the contents of the appropriate application fundamentals help. They provide the starting points for fundamental implementation tasks.

In addition, the *PeopleTools: Applications User's Guide* introduces you to the various elements of the PeopleSoft Pure Internet Architecture. It also explains how to use the navigational hierarchy, components, and pages to perform basic functions as you navigate through the system. While your application or implementation may differ, the topics in this user's guide provide general information about using PeopleSoft applications.

## Field and Control Definitions

PeopleSoft documentation includes definitions for most fields and controls that appear on application pages. These definitions describe how to use a field or control, where populated values come from, the effects of selecting certain values, and so on. If a field or control is not defined, then it either requires no additional explanation or is documented in a common elements section earlier in the documentation. For example, the Date field rarely requires additional explanation and may not be defined in the documentation for some pages.

## Typographical Conventions

The following table describes the typographical conventions that are used in the online help.

<b>Typographical Convention</b>	<b>Description</b>
Key+Key	Indicates a key combination action. For example, a plus sign (+) between keys means that you must hold down the first key while you press the second key. For Alt+W, hold down the Alt key while you press the W key.
. . . (ellipses)	Indicate that the preceding item or series can be repeated any number of times in PeopleCode syntax.
{ } (curly braces)	Indicate a choice between two options in PeopleCode syntax. Options are separated by a pipe ( ).
[ ] (square brackets)	Indicate optional items in PeopleCode syntax.
& (ampersand)	When placed before a parameter in PeopleCode syntax, an ampersand indicates that the parameter is an already instantiated object.  Ampersands also precede all PeopleCode variables.
=>	This continuation character has been inserted at the end of a line of code that has been wrapped at the page margin. The code should be viewed or entered as a single, continuous line of code without the continuation character.

## ISO Country and Currency Codes

PeopleSoft Online Help topics use International Organization for Standardization (ISO) country and currency codes to identify country-specific information and monetary amounts.

ISO country codes may appear as country identifiers, and ISO currency codes may appear as currency identifiers in your PeopleSoft documentation. Reference to an ISO country code in your documentation

does not imply that your application includes every ISO country code. The following example is a country-specific heading: "(FRA) Hiring an Employee."

The PeopleSoft Currency Code table (CURRENCY\_CD\_TBL) contains sample currency code data. The Currency Code table is based on ISO Standard 4217, "Codes for the representation of currencies," and also relies on ISO country codes in the Country table (COUNTRY\_TBL). The navigation to the pages where you maintain currency code and country information depends on which PeopleSoft applications you are using. To access the pages for maintaining the Currency Code and Country tables, consult the online help for your applications for more information.

## Region and Industry Identifiers

Information that applies only to a specific region or industry is preceded by a standard identifier in parentheses. This identifier typically appears at the beginning of a section heading, but it may also appear at the beginning of a note or other text.

Example of a region-specific heading: "(Latin America) Setting Up Depreciation"

### Region Identifiers

Regions are identified by the region name. The following region identifiers may appear in the PeopleSoft Online Help:

- Asia Pacific
- Europe
- Latin America
- North America

### Industry Identifiers

Industries are identified by the industry name or by an abbreviation for that industry. The following industry identifiers may appear in the PeopleSoft Online Help:

- USF (U.S. Federal)
- E&G (Education and Government)

## Translations and Embedded Help

PeopleSoft 9.2 software applications include translated embedded help. With the 9.2 release, PeopleSoft aligns with the other Oracle applications by focusing our translation efforts on embedded help. We are not planning to translate our traditional online help and PeopleBooks documentation. Instead we offer very direct translated help at crucial spots within our application through our embedded help widgets. Additionally, we have a one-to-one mapping of application and help translations, meaning that the software and embedded help translation footprint is identical—something we were never able to accomplish in the past.

## Using and Managing the PeopleSoft Online Help

Select About This Help in the left navigation panel on any page in the PeopleSoft Online Help to see information on the following topics:

- [Using the PeopleSoft Online Help](#)
  - [Managing Hosted online help](#)
  - [Managing locally installed PeopleSoft Online Help](#)
- 

## Understanding PeopleSoft Application Designer

Every PeopleSoft Pure Internet Architecture application contains a collection of related definitions that work together for a specific purpose. Developing and adapting PeopleSoft applications is a step-by-step process in which you define and build the definitions, establish relationships among the definitions, implement security, run your PeopleSoft application in an internet browser, and test every aspect thoroughly. You use one interactive tool, PeopleSoft Application Designer, for the majority of these activities. PeopleSoft Application Designer is an integrated development environment that enables you to work with the numerous definitions of a business application in a single work area.

---

**Note:** Your user interface might appear differently than what you see in this product documentation. The look and feel of PeopleSoft Application Designer varies based on the release of your Microsoft® Windows operating system.

---

---

## PeopleTools Related Links

[PeopleTools 8.58 Home Page](#)

[PeopleTools Elasticsearch Home Page](#)

["PeopleTools Product/Feature PeopleBook Index" \(PeopleTools 8.58: Getting Started with PeopleTools\)](#)

[PeopleSoft Hosted Online Help](#)

[PeopleSoft Information Portal](#)

[PeopleSoft Spotlight Series](#)

[PeopleSoft Training and Certification | Oracle University](#)

[My Oracle Support](#)

[Oracle Help Center](#)

---

## Contact Us

Send your suggestions to [psoft-infodev\\_us@oracle.com](mailto:psoft-infodev_us@oracle.com). Please include the applications update image or PeopleTools release that you're using.

---

## Follow Us



[Facebook.](#)



[YouTube](#)



[Twitter@PeopleSoft\\_Info.](#)



[PeopleSoft Blogs](#)



[LinkedIn](#)



## Chapter 1

# Getting Started with PeopleSoft Application Designer

---

## PeopleSoft Application Designer Overview

PeopleSoft Application Designer is the core development tool used to build and modify PeopleSoft applications. PeopleSoft Application Designer enables you to build a variety of definitions, including:

- Fields
  - Records (Tables)
  - Pages
  - Components
  - Menus
  - PeopleCode
  - SQL
- 

## PeopleSoft Application Designer Implementation

This section discusses:

- Installation-level steps.
- Main application development steps.

### Installation-Level Steps

This table lists the steps you must complete before you can begin using PeopleSoft Application Designer:

<b>Step</b>	<b>Explanation</b>	<b>Reference</b>
Set up security.	For developing and customizing PeopleSoft applications, you need access to the definitions involved, such as fields, records, pages, and so on. Your administrator can provide access by adjusting your definition security settings. Your administrator also might need to grant general PeopleTools permissions for maintaining and upgrading data. These permissions include Build and Data Administration, Change Control, and Upgrade.	See "Setting PeopleTools Permissions" (PeopleTools 8.58: Security Administration).
Set up workstations.	PeopleSoft Application Designer is a Microsoft Windows-based program. To run PeopleSoft Application Designer, you must have a supported version of Windows with ample CPU and memory resources. Also, you must use PeopleSoft Configuration Manager to configure your workstation with connectivity to the appropriate database and to set all required environment variables.	See "Configuring Developer Workstations" (PeopleTools 8.58: System and Server Administration).

## Main Application Development Steps

This table presents the main steps for creating a PeopleSoft application:

<b>Step</b>	<b>Reference</b>
1. Design application.	Review your in-house development cycle and documentation.
2. Create fields.	See <a href="#">Creating New Field Definitions</a> .
3. Create record definitions.	See <a href="#">Understanding the Planning Process</a> . See <a href="#">Creating New Record Definitions</a> .
4. Build SQL tables.	See <a href="#">Understanding Data Administration and the Build Process</a> .
5. Create pages.	See <a href="#">Improving Online Performance</a> . See <a href="#">Understanding Page Controls</a> . See <a href="#">Understanding Scroll Areas, Scroll Bars, and Grids</a> . See <a href="#">Understanding Page Design and Development</a> .
6. Create components.	See <a href="#">Understanding Component Definitions</a> .
7. Register components.	See <a href="#">Understanding the Registration Wizard</a> .
8. Test the application.	Review your in-house testing procedures and documentation.



## **Other Sources of Information**

This section provides information you should consider before you begin to use PeopleSoft Application Designer. In the planning phase of your implementation, take advantage of all Oracle sources of information, including the installation guides and troubleshooting information. A complete list of these resources appears in the preface in *About These PeopleBooks*, with information about where to find the most current version of each.

## **Related Links**

[Getting Started with PeopleTools](#)



## Chapter 2

# Using PeopleSoft Application Designer

---

## Understanding PeopleSoft Application Designer

Every PeopleSoft Pure Internet Architecture application contains a collection of related definitions that work together for a specific purpose. Developing and adapting PeopleSoft applications is a step-by-step process in which you define and build the definitions, establish relationships among the definitions, implement security, run your PeopleSoft application in an internet browser, and test every aspect thoroughly. You use one interactive tool, PeopleSoft Application Designer, for the majority of these activities. PeopleSoft Application Designer is an integrated development environment that enables you to work with the numerous definitions of a business application in a single work area.

---

**Note:** Your user interface might appear differently than what you see in this product documentation. The look and feel of PeopleSoft Application Designer varies based on the release of your Microsoft® Windows operating system.

---

## Using PeopleSoft Application Designer

This section provides an overview of the eight steps of application development and discusses how to work with the Application Designer interface.

## Understanding the Eight Steps of Application Development

Application development is a systematic process. Between the design and implementation of the application, you define and build application definitions, establish relationships, implement security, and test every aspect thoroughly. When developing in the PeopleSoft environment, it is helpful to look at the development phase as an eight step process:

1. Design the application.
2. Create field definitions.
3. Create record definitions.
4. Build application data tables.
5. Create page definitions.
6. Define components.
7. Register components.
8. Test the application.

## **Step One - Designing the Application**

Create a development plan. The first phase of development in any environment is always planning. Designers might spend 80 percent of their time designing a sound plan before they work on the first step. In PeopleSoft applications, you will need to fully understand the other seven steps of development to design a good plan. When you finish the development plan, you should have a business requirements document that specifies the tables required and the relationships among them, a list of required definitions (fields, records, and so on) complete with detailed specifications and naming conventions, mock-ups of page layouts, and a navigational hierarchy that will give users access to the pages you create.

## **Step Two - Creating Field Definitions**

Field definitions in PeopleSoft are slightly different from other environments. Designers define fields apart from any tables they may belong to and ensure that they can be reused in any number of separate database tables. The field definition is the basis for all the steps that follow.

## **Step Three - Creating Record Definitions**

PeopleTools-based applications are table-based systems. When creating a record definition, you are actually defining two layers of information: the record level and the field level. At the record level, you define the structure of the database table, and the ultimate purpose of the record definition, and how the system will use the definition. At the field level, you define the characteristics of the fields and any online processing that you want to occur behind the scenes when a user enters data.

## **Step Four - Building Application Data Tables**

After you define a record definition, you must create or build the underlying SQL tables that house the application data that users will enter online in the production environment. This build process is the centerpiece of the data administration features in PeopleSoft Application Designer. The build process takes all of the properties of a record definition and creates a database table from them. Unless you complete this step, no table will exist in the database to accept the application data.

## **Step Five - Creating Page Definitions**

Pages are the user interface for the application. Pages present data to the users and enable them to enter data into the application data table created in the previous step. In this step, you add page controls to a page, associate the page controls with record fields, and configure appearance of the page. The system displays the page to users in a browser window as HTML.

## **Step Six - Defining Components**

Component definitions represent complete business transactions in PeopleSoft applications and are central to navigation and security access. A component holds one or more pages that the user navigates between using tabs or links. In this step, you define the search record and search attributes, the processing mode, and the toolbar buttons that appear at the bottom of each page in the component.

## **Step Seven - Registering Components**

The Registration Wizard makes registering a component easy. In this step, you attach the component to a menu, assign security access for users, and place navigational links in the registry. After you register a component, the user interface is complete and you can view the application in the browser.

## Step Eight - Testing the Application

The final step of application development is to thoroughly test the application before delivering the finished product to users. You must test all aspects of the application by opening a transaction in your browser and entering test data into the application. As issues arise, you can cycle back through each of the previous steps to resolve the issues.

## Starting PeopleSoft Application Designer

Open PeopleSoft Application Designer from the Start menu. Alternatively, if you have set up a shortcut on your desktop, you can open the application from there. At the PeopleSoft Signon dialog box, enter the Database Name or Application Server Name (depending on your connection type), User ID, and Password. PeopleTools opens automatically to PeopleSoft Application Designer.

---

**Note:** Specific PeopleSoft utilities require you to set an environment variable, `PS_SERVER_CFG`, to run properly. However, PeopleSoft Application Designer is not compatible if `PS_SERVER_CFG` is set. Before you start PeopleSoft Application Designer, you must ensure that `PS_SERVER_CFG` is not set. A convenient way to do this is to use a DOS batch file to unset `PS_SERVER_CFG`, launch PeopleSoft Application Designer, and then—after PeopleSoft Application Designer exits—reset `PS_SERVER_CFG` to its previous value.

---

In addition to launching PeopleSoft Application Designer from the Start menu, you can also do so using the command line syntax and the available parameters listed there.

PeopleSoft Application Designer offers a variety of command line parameters that you can use to control the database to which it connects. By using these parameters, you can automatically navigate to the part of the system that you need.

Use the values from the following tables to specify specific parameters.

### Syntax

The following command line syntax applies to all actions identified in this topic:

```
PSIDE [-parameter value [-parameter value . . .]]
```

Use this command line syntax to start PeopleSoft Data Mover:

```
PSDMT [-parameter value [-parameter value . . .]]
```

You can include as many or as few parameters as you need.

Each parameter starts with a hyphen (-) or a forward slash (/). The value for each parameter follows the hyphen or slash, separated by zero or more spaces. In general, the value does not need to have quotation marks around it, even if it has internal spaces, because the system treats all text following the parameter as part of the value up to the next parameter or the end of the command line.

---

**Note:** You must enclose a value in quotation marks only when it includes a hyphen or forward slash or to include leading or trailing spaces. If the value itself includes a quotation mark character, then precede the double quotation mark with a backslash (\).

---

### Available Parameters

The available parameters for `pside.exe` fall into two general categories:

- Parameters that provide login information.
- Parameters that set general options.

If the command line includes login parameters, it uses them only if no PeopleSoft applications are currently running. If a PeopleSoft application is already running, then the system starts a new instance by using the same login information as the active instance.

This table lists all of the available parameters:

<b>Parameter</b>	<b>Value</b>	<b>Description</b>
-CT	Database type	Enter the type of database to which you are connecting. Valid values are ORACLE, MICROSOFT, and DB2ODBC (note the spelling of MICROSOFT).
-CS	Server name	Enter the name of the database server for the database to which you are connecting. This setting is required for some database types.
-CD	Database name	Enter the name of the database to which you are connecting as you would enter it into the PeopleSoft Signon dialog box.
-CO	User ID	Enter the PeopleSoft user ID used for sign in.
-CP	Password	Enter the password for the specified user ID.  Passwords entered on the command line can be clear text or encrypted.
-CI	Connect ID	Enter the ID that is used to connect to the database server.
-CW	Password	Enter the password for the specified connect ID.  Passwords entered on the command line can be clear text or encrypted.
-SS	NO	Use to suppress the appearance of the PeopleSoft splash screen. Any other value will cause the splash screen to appear.

<b>Parameter</b>	<b>Value</b>	<b>Description</b>
-SN	NO	Use to suppress the sound that plays when you sign in to the PeopleSoft system. Any other value will allow the sound to play.
-QUIET	(none)	Use to run in quiet mode so that no message boxes appear.
-HIDE	(none)	Use to hide the PeopleSoft Application Designer interface.

For more information on using the Application Designer command line parameters, see "Understanding PeopleSoft Application Designer Command Line Parameters" (PeopleTools 8.58: Lifecycle Management Guide).

### Example

This command line statement starts PeopleSoft Application Designer and signs the user in to the DEP7TST database:

```
PSIDE -CT MICROSOFT -CS SEPNTDB05 -CD DEP7TST -CO VP1 -CP password
```

This command line statement starts PeopleSoft Application Designer using an encrypted password.

```
pside.exe -CT ORACLE -CO PTDMO -CP encrypted_password -CD QAHR7TST
```

In this case, *encrypted\_password* should be substituted with the actual encrypted password value.

For more information on encryption, see "Using the PSCipher Utility" (PeopleTools 8.58: Security Administration).

## Using the PeopleSoft Application Designer User Interface

This table describes the six main elements that comprise the PeopleSoft Application Designer user interface:

<b>Element</b>	<b>Description</b>
Title bar	Displays the name of the database, the active project (optional), and the active definition (optional) in the following format:  <code>Application Designer - DB_NAME - PROJECT→ _NAME - DEFN_NAME (Type)</code>
Menu	Provides access to PeopleSoft Application Designer items and features.
Toolbar	Displays buttons that are useful in editing the active definition.

<b>Element</b>	<b>Description</b>
Project workspace	Provides a graphical representation of the components that are contained in a project. The project workspace has two folder tabs: <ul style="list-style-type: none"> <li>• Development View.</li> <li>• Upgrade View.</li> </ul>
Definition workspace	Displays individual definitions that you open.
Output window	Contains the output text from PeopleSoft Application Designer operations, such as Build (SQL Create and Alter), Find Definition References, Upgrade, Results, Validate, and PeopleCode Log.

**Note:** You should maximize the PeopleSoft Application Designer window to make optimal use of the different workspaces.

## Application Designer Menus

This topic reviews the general PeopleSoft Application Designer menus. Specific menus appear for each definition when it is open and active. Those menus are discussed in the topic about each definition.

**Note:** The menu items that appear on each menu often depend on the type of definition that is open in the definition workspace. Those menu items are described in the corresponding topics.

In addition to the standard Microsoft Windows File menu items, several PeopleTools-specific items appear in the File menu. This table lists the PeopleTools-related File menu items:

<b>File Menu Items</b>	<b>Usage</b>
Save Project	Save the project.
Save Project As	Save the active project definition. This menu item enables you to change the name of the project when you save it.
Print Project	Print an Upgrade Project report for all the elements in the open project.
Merge Projects	Create a new project from selected definitions of two existing projects.
Project Properties	Edit properties for the open project.
Definition Properties	Provide general comments and change attributes for the active definition. You can change attributes for Use, Type, and Internet properties, depending on the definition type.
View Report	View a report of the definition in an open window in the workspace.



<b>File Menu Items</b>	<b>Usage</b>
Report from File, Print Preview	View a print preview of a selected report file that is saved to a disk.
Report from File, Print	Print a selected report file from a disk.
Report from File, View Report	View a report from a selected report file that is saved to a disk.
List of last opened definitions	View and open one of the last few definitions you opened. You can configure the maximum number of definitions that appear in the list.  See <a href="#">Setting PeopleTools Options</a> .

In addition to the standard Microsoft Windows-based menu items, such as Cut and Paste, two PeopleTools-specific menu items appear in the Edit menu. This table describes their use:

<b>Edit Menu Items</b>	<b>Usage</b>
Find Definition References	Search for all related definitions and references (fields, records, pages, PeopleCode, application packages, and so on) to the current open definition. The results appear on the Find Definition References tab of the Display window.  See <a href="#">Finding Definition References</a> .
Find In	Search through all PeopleCode, SQL programs, HTML definitions, and Free form sub style sheets for a text string that you describe in a dialog box. You can also specify which type of PeopleCode and SQL programs to search.  See "Using the Find In Feature" (PeopleTools 8.58: PeopleCode Developer's Guide).

This table describes the use of View menu items:

<b>View Menu Items</b>	<b>Usage</b>
View Definition	View a definition that is referenced in the active definition. For example, if you highlight a record field in a record definition, then selecting this option opens the selected field definition.
View PeopleCode	View PeopleCode characteristics of the active definition.

<b>View Menu Items</b>	<b>Usage</b>
Filtering	Select a filter option for your view of upgrade: <ul style="list-style-type: none"> <li>• No Filtering.</li> <li>• Selected for Upgrade Action.</li> <li>• Not Selected for Upgrade Action.</li> <li>• Custom Filtering.</li> </ul>
Toolbar	Show or hide the toolbar.
Status Bar	Show or hide the status bar.
Project Workspace	Show or hide the project workspace.
Output Window	Show or hide the output window.
Property Window	Show or hide the property window.

This table describes the use of Insert menu items:

<b>Insert Menu Items</b>	<b>Usage</b>
Current Definition into Project	Insert the active definition into the project.
Definitions into Project	Display a dialog box to insert definitions into the project.

This table describes the use of Build menu items:

<b>Build Menu Items</b>	<b>Usage</b>
Current Definition	Display a dialog box to build or alter the record definition that is currently active in the definition workspace.
Project	Display a dialog box to build (SQL Create and SQL Alter) all project records.
Settings	Display a dialog box in which you set parameters that apply to build operations.

This table describes the use of Debug menu items:

<b>Debug Menu Items</b>	<b>Usage</b>
PeopleCode Debugger Mode	<p>Start the PeopleCode Debugger, which invokes a debugging session and causes a full Debug menu to appear. When in Debugger mode, a Local Variables pop-up window appears in the definition workspace.</p> <p>See "Understanding the PeopleCode Debugger" (PeopleTools 8.58: PeopleCode Developer's Guide).</p>

This table describes the use of Tools menu items:

<b>Tools Menu Items</b>	<b>Usage</b>
Validate Project	Validate attributes of the active project.
Validate Database for WSRP	<p>Validates all of the appropriate definitions within a database for WSRP compliance.</p> <p>See "Validating WSRP Compliance" (PeopleTools 8.58: Portal Technology).</p>
Compile All PeopleCode	<p>Validate all of the PeopleCode in the current database. Displays the Compile All PeopleCode dialog box where you can choose to compile and save all PeopleCode and all Directive PeopleCode.</p> <p>See "Compiling All PeopleCode Programs at Once" (PeopleTools 8.58: PeopleCode Developer's Guide) and "Compiling and Saving Directive PeopleCode" (PeopleTools 8.58: Lifecycle Management Guide).</p>
Compile Project PeopleCode	Validate the PeopleCode in the current project.
Diff / Merge Project PeopleCode	Compare and merge two PeopleCode definitions during an upgrade.
Diff / Merge External Text	Compare and merge two versions of an external text file (such as a Data Mover script or a SQL script) during an upgrade.
Compare and Report	Compare two projects and report on the differences.
Copy Project	Copy the current project to a database or a file, or export a project from a file to your database.
Data Administration	Open dialog boxes that describe space allocation in the database.
Change Control	Open dialog boxes to view history or set system-wide change control options as the administrator.

<b>Tools Menu Items</b>	<b>Usage</b>
Upgrade	Upgrade an application project.
Translate	Translate base and operator language databases.
Miscellaneous Definitions	<p>Set custom field formats, toolbars, colors, styles, access profiles, and file type codes.</p> <hr/> <p><b>Important!</b> Styles are a deprecated feature. You must maintain styles by using style sheet definitions.</p> <hr/> <p>See <a href="#">Understanding Style Sheets and Style Classes</a>.</p>
Bulk Operations	Insert, modify, or delete certain definition types across your entire database in one operation.
Options	Select commands specifying insertion commands, definition language preference, validating options, PeopleCode fonts, definition owner ID, and more.

This table describes the use of Window menu items:

<b>Window Menu Items</b>	<b>Usage</b>
Cascade	Cascade all of the definitions that are not minimized in the definition workspace into overlapping layers of definitions with the definition names visible.
Tile	Reorganize and resize all of the definitions that are not minimized in the definition workspace so that they are all visible and do not overlap.
Arrange Icons	Group all of the minimized definitions in the definition workspace.
Close All	Close all of the definitions in the definition workspace.

This table describes the use of Help menu items:

<b>Help Menu Items</b>	<b>Usage</b>
Current Window	Provide context-sensitive help that is related to the active window by opening the appropriate documentation in the appropriate location.
PeopleBooks Library	Go to the PeopleSoft Online Library (the online documentation for PeopleTools and your licensed PeopleSoft applications).

<b>Help Menu Items</b>	<b>Usage</b>
About PeopleTools	Display the PeopleTools release level, application release, user ID, database name, database type, and application server name.

## PeopleSoft Application Designer Toolbars

In addition to the standard Microsoft Windows toolbar button items, such as Cut, Paste, and Save, several items are PeopleTools-specific. The command name appears in parentheses following its description.



Open the Definition Properties dialog box (File > Definition Properties).



Open the Build dialog box (Build > Current Definition).



Toggle the display of the project workspace (View > Project Workspace).

## Project Workspace

View projects and their associated definitions in the project workspace. A project organizes a collection of definitions in logical groups for easier development, adaptation, maintenance, and upgrade.

### Image: Project workspace shown with a project open

This example illustrates the fields and controls on the Project workspace shown with a project open. You can find definitions for the fields and controls later on this page.

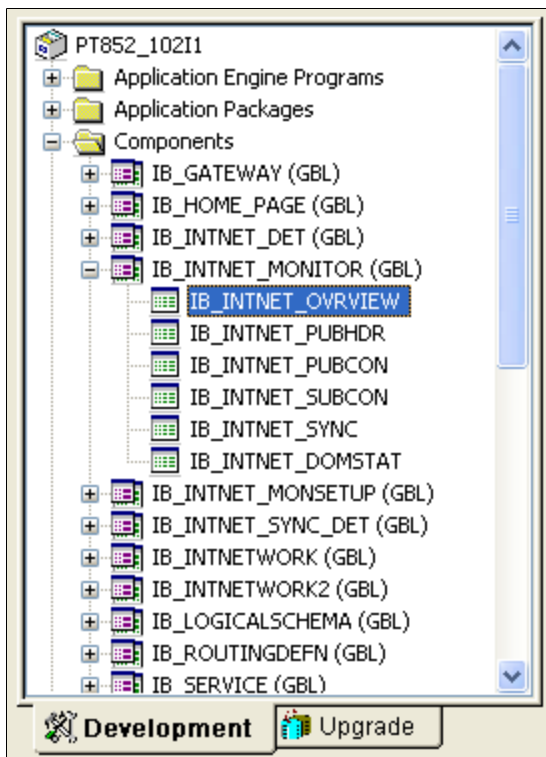

Work with a development project or an upgrade project by selecting either the Development tab or the Upgrade tab at the bottom of the project workspace.

The text on the Development and Upgrade tabs might not appear if your monitor is not large enough to display it.

## Definition Workspace

Use the definition workspace to create and modify definitions. You can maximize, minimize, cascade, or tile them in the workspace.

## Output Window

The output window displays status messages of various PeopleSoft Application Designer operations. The output is organized into different categories by using tabs at the bottom of the window.

The text that appears in the output window is context-sensitive, which enables you to select it and perform related operations. For example, if you have a field definition open, select **Edit > Find Definition References** to list the definitions that reference the active field definition. The list appears in the output window. Double-click any of the related definitions listed to open them.

The output window has several tabs that relate to numerous functions that you can perform with PeopleSoft Application Designer. This table describes the use of the tabs:

<b>Tab</b>	<b>Usage</b>
Build	Create tables, indexes, views, triggers, and alter tables. If you select the <i>Log to Output Window</i> option in the Build settings, then errors, warnings, and informational messages appear here. You can control the level of detail that appears.
Find Definition References	View definitions that other references use or reference. Double-click a definition to open it.
Upgrade	View upgrade actions that are initiated from PeopleSoft Application Designer.
Results	View messages related to project operations, like opening a project or inserting definitions into a project.
Validate	Validate projects and components, and view the results.
Find In	View the Find In dialog box output. Double-click a definition to open it. You can limit the Find In search to a specific project rather than the entire database.
PeopleCode Log	View errors that you receive when you are in the debugger stepping through code.

## Setting PeopleTools Options

You can set preferences for various features in the Options dialog box. Select **Tools > Options** to access the Options dialog box. Seven tabs appear on the dialog box and each tab features configurable options for different areas of PeopleSoft Application Designer. Most of these options are described in further detail in other, more relevant areas of the product documentation. The following topics provides a general description of each tab and a link to further details about the options:

### **Project**

Set various project options.

See [Setting Project Options](#).

### **Validate**

Set project validation options, enable the PeopleSoft Application Designer spell check feature, and enable WSRP validation.

See [Validating Projects](#).

See [Enabling the Spell Check Feature](#).

### **Editors**

Set Word Wrap options for the various editors in PeopleSoft Application Designer.

See "Understanding the PeopleCode Debugger" (PeopleTools 8.58: PeopleCode Developer's Guide).

See "Understanding the SQL Editor Window" (PeopleTools 8.58: PeopleCode Developer's Guide).

## General

### Image: Options dialog box: General tab

This example illustrates the fields and controls on the Options dialog box: General tab. You can find definitions for the fields and controls later on this page.

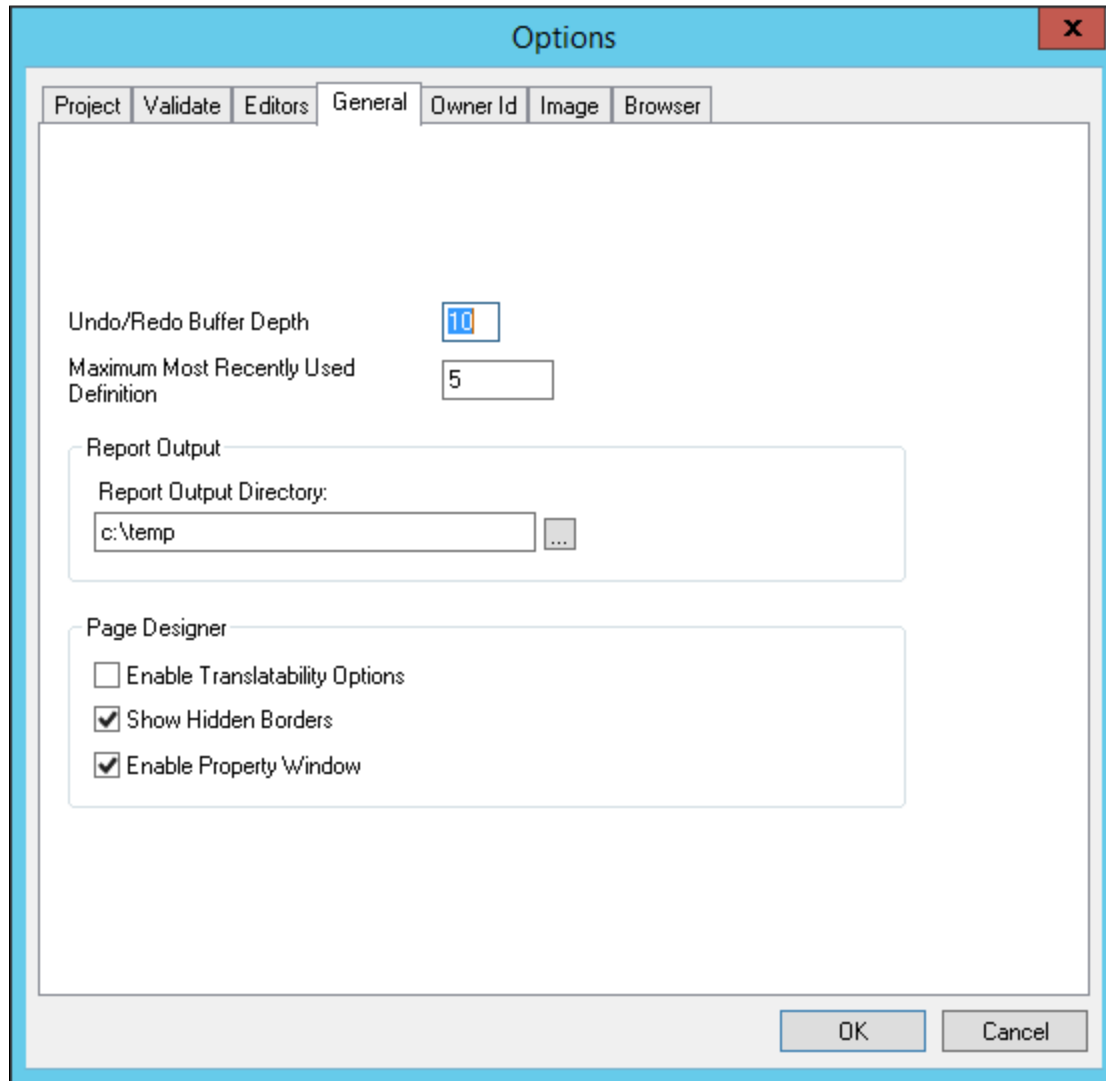

#### Undo/Redo Buffer Depth

Enter the number of most recently performed actions for PeopleSoft Application Designer to store in memory. The default value is *10*, which mean that you can undo up to 10 immediately previous actions, such as adding or deleting page fields from a page.

#### Maximum Most Recently Used Definition

Enter the number of recently opened definitions to appear in a list at the bottom of the File menu in PeopleSoft Application Designer. The default value is *5*.

#### Report Output Directory

Enter the output destination of the reports that you run in PeopleSoft Application Designer. Reports include upgrade, build, and definition reference reports.



## Enable Translatability Options

Select to enable the following translatability options:

- When you save a page, PeopleSoft Application Designer warns you if a page control label violates the recommended translation buffer.
- When you add or modify translate values, a warning appears if the Short Name field value exceeds the recommended length of six characters.
- When you add or modify field labels, a warning appears if the Short Name field value exceeds the recommended length of ten characters.
- When you work with page definitions, PeopleSoft Application Designer disables the Static Text tool so that you cannot insert new static labels on pages.

---

**Note:** Translation warnings only appear when your base language value in Configuration Manager is *English*.

---

## Show Hidden Borders

Select to enable the borders of hidden group boxes and frames to appear as dashed lines indicating the boundary of all hidden group box and frame page control types.

## Enable Property Window

Select to enable the property window for page controls. See [Using the Property Window](#) for more information.

---

**Note:** You must close and restart Application Designer for this setting to take effect.

---

## Owner Id

Set the default owner ID for new definitions you create. Alternatively, leave the option blank, which is the default, to allow users to select the owner ID they want. The Owner ID helps identify which applications team last made a change to a definition.

## Image

Set the preferred storage format for newly created image definitions.

See [Specifying an Image Storage Format](#).

## Browser

Enter the base uniform resource indicator (URI) to be used by the browser to locate the application and the node name.

See [Configuring Browser Options](#).

## Related Links

[Manipulating Page Controls](#)

## Working with Keyboard Shortcuts

For convenience and efficiency, you can use these keyboard shortcuts in Application Designer for selected tasks. The action (or menu equivalent) depends on the currently selected definition.

<b>Keyboard Shortcut</b>	<b>Action (Menu Equivalent)</b>
Ctrl+N	File > New...
Ctrl+O	File > Open...
Ctrl+S	File > Save
Alt+Enter	File > Definition Properties
Ctrl+P	File > Print
Ctrl+Z	Edit > Undo
Ctrl+Y	Edit > Redo
Ctrl+X	Edit > Cut
Ctrl+C	Edit > Copy
Ctrl+V	Edit > Paste
Ctrl+Delete	Edit > Delete
Ctrl+R	Edit > Find Definition References Edit > Find Definition References...
Ctrl+Shift+F	Edit > Find In...
Ctrl+Enter	Edit > Page Field Properties Edit > Record Field Properties
Ctrl+D	View > View Definition
Ctrl+E	View > View PeopleCode View > View Page PeopleCode
Shift+E	View > View Record PeopleCode
Alt+O	View > Project Workspace
Alt+1	View > Output Window
Alt+2	View > Property Window
F7	Insert > Current Definition into Project
Ctrl+F7	Insert > Definitions into Project...

<b>Keyboard Shortcut</b>	<b>Action (Menu Equivalent)</b>
Ctrl+Shift+R	Find Definition References - Field...
Ctrl+Alt+R	Find Definition References - Record Field

When you are working with results in the output window, such as after a Find Definition References or Find In request, you can use your keyboard to navigate the results.

<b>Output Window Keyboard Shortcuts</b>	<b>Description</b>
Up/Down Arrow	Navigate up and down output window results.
Enter	Opens the definition associated with that output window result.

When you are working with page definitions, you can use the tab key to move from control to control, and when within a grid, use the left and right arrow keys to navigate between columns in the grid.

When working with projects, you can use the up and down arrows to navigate the list of definitions in the project workspace, and you can use Ctrl+D to open the currently selected definition. You can select multiple definitions using the Ctrl key and open them simultaneously.

---

## Using the PeopleCode and Other Programming Language Editors

This section provides an overview of PeopleCode and discusses how to use the various programming language editors.

---

**Note:** When using the programming language editors, keep these items in mind. Highlighting the syntax of strings in the HTML Editor and the PeopleCode Editor is done only for single-line strings, not for multi-line strings. Word wrap can cause strings to be displayed in various colors if the strings span across multiple lines. String color-coding, when used with an escape sequence, may be displayed incorrectly in Application Designer but perform properly at runtime.

---

### Accessing and Using the PeopleCode Editor

PeopleCode is the structured programming language built into PeopleTools that extends the functionality of the PeopleTools environment, enabling you to add business logic to critical application definitions. All PeopleCode programs are associated with and considered a part of the parent definition. When you create, view, or modify a definition, you may simultaneously create, view, or modify its PeopleCode.

You can associate PeopleCode programs with many items, such as record fields, pages, components, Application Engine programs, and so on. You can access any PeopleCode program from its related definition. When you have a definition open in Application Designer, you can access the PeopleCode written for that definition by:

- Clicking the View PeopleCode button in the toolbar.

- Right-clicking on the definition and selecting View PeopleCode from the popup menu.



For definitions where PeopleCode can be inserted, the View PeopleCode button appears in the dynamic Application Designer toolbar. Click this button to launch the PeopleCode Editor and view the PeopleCode associated with the current definition.

The View PeopleCode button appears for these definition types:

- Records
- Pages
- Components
- Menus
- Component interfaces
- Messages
- Application Engine programs

---

**Note:** Depending on the definition type, the label of the button and the number of buttons that appear might be different.

For example, with pages, you see two buttons: View Page PeopleCode and View Record PeopleCode.

---

### Image: Example of accessing PeopleCode from the popup menu

This example illustrates accessing PeopleCode from the current definition open in the Application Designer workspace. By selecting View PeopleCode from the popup menu, the system launches the PeopleCode Editor displaying the PeopleCode for the selected record field.

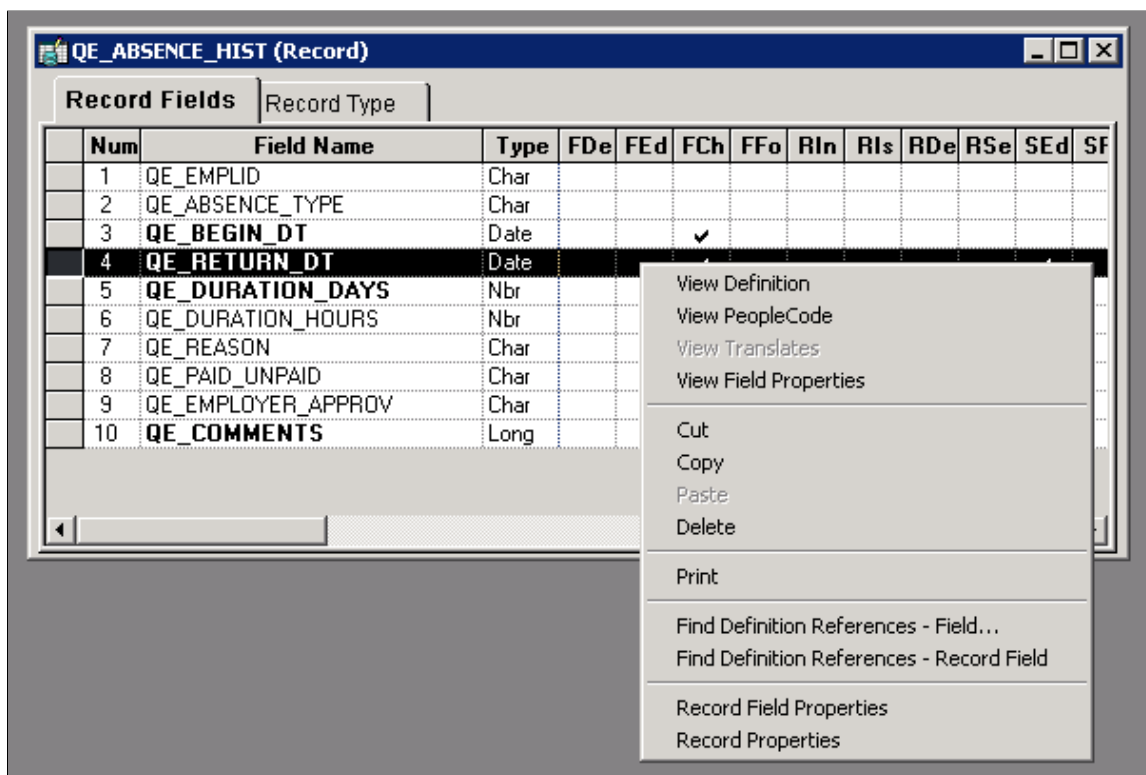

To view Record Field PeopleCode there is an additional option:

1. Open a record definition in PeopleSoft Application Designer.
2. Click the View PeopleCode toolbar button to view the PeopleCode display for the record.
3. Locate the field containing PeopleCode in the record definition for which you want to access the PeopleCode.
4. Double-click the cell (the check mark) under the column heading for the type of PeopleCode that you want to view.

The PeopleCode editor is a text editor that enables you to construct, modify, and review PeopleCode programs and associate them to PeopleSoft definitions and events. The PeopleCode editor enables you to edit and navigate all PeopleCode programs that belong to the same parent definition.

The user interface of the PeopleCode editor consists of two drop-down list boxes and an area where you enter text. The drop-down list box that is on the left side of the editor displays the current field and other available fields, records, and components. Any field with PeopleCode attached appears in bold. The drop-down list box that is on the right side of the editor displays the current PeopleCode event and other events that are appropriate for that definition. Events already containing PeopleCode for that definition appear in bold.

Beneath the drop-down list boxes is where you enter your text. In this area, you can add, delete, and change text and you can use the find and replace function. The PeopleCode editor validates the syntax of

your code and the editor automatically formats the code according to PeopleSoft standards when you save the definition.

### Image: Example of working in the PeopleCode editor

This example illustrates the fields and controls on the Example of working in the PeopleCode editor. You can find definitions for the fields and controls later on this page.

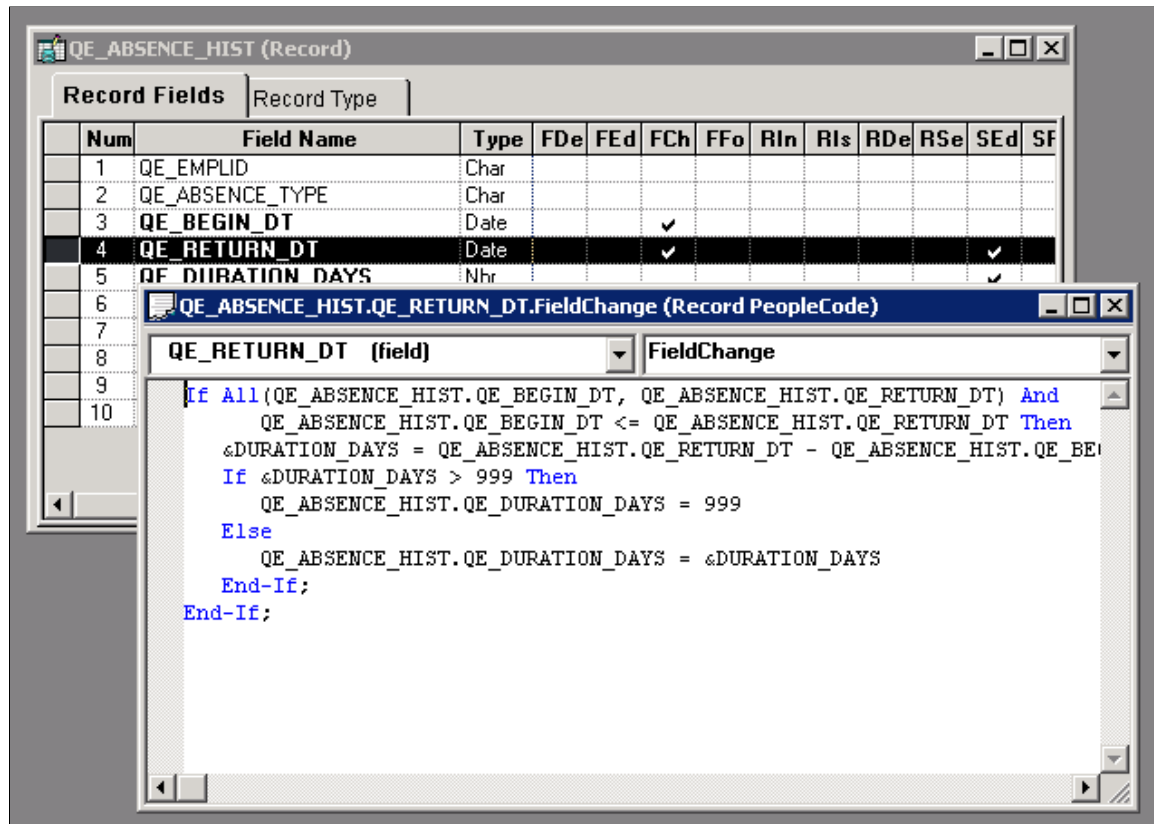

**Note:** You can embed strings in the PeopleCode editor that generate HTML, JavaScript, CSS, and XML markup. However, it is not considered a best practice.

**Note:** Multiple programmers may save changes to different PeopleCode programs associated with the same definition. However, the system displays an error if multiple programmers attempt to save the *same* PeopleCode program associated with the *same* definition and PeopleCode event.

**Note:** With the PeopleCode Editor active, you can select View, Line Numbers to display line numbers to the left of each line in the program, beginning with 001.

### Related Links

"Understanding PeopleCode Programs and Events" (PeopleTools 8.58: PeopleCode Developer's Guide)

## Using Additional Programming Language Editors

This section discusses these programming editors:

- SQL editor

- Application packages editor
- HTML editor
- Free form style sheet editor

## SQL Editor

The SQL editor is a text editor that enables you to construct, modify, and review a SQL statement and save it as a reusable SQL definition. Using the SQL editor, you can add, delete, and change text and you can use the find and replace function. The SQL editor formats the text, but the editor does not validate the SQL syntax.

You can access the SQL editor from these definitions:

- Record definitions that are based on SQL and dynamic views.
- PeopleSoft Application Engine actions.
- PeopleCode editor.

## Application Packages Editor

From an Application Package you can access the PeopleCode programs that are associated with the classes of the package. The Application Packages editor and the PeopleCode editor interfaces are similar. You can add, delete, and change text; you can use the find and replace function; and you can validate the syntax. When you save your application package, the code is automatically formatted, just as it is in the PeopleCode editor.

## HTML Editor

The HTML editor interface offers some of the same functionality as the other editors. In the HTML editor you can add, delete, and change text; and you can use the find and replace function. While the editor does format certain elements of your code, such as variables, methods, and strings, the editor does *not* validate the syntax. Because the HTML editor is free form, you can enter any type of text in it because there is no validation of any kind. However because the HTML editor output is used in web pages, typically, you enter only the following markup languages: HTML, JavaScript, CSS, and XML

## Free Form Style Sheet Editor

The free form style sheet editor interface enables you to create text-based sub style sheets that enable you to take advantage of Cascading Style Sheets - Level 2 (CSS2), AJAX, and DHTML. In the free form style sheet editor you can add, delete, and change text; and you can use the find and replace function. The editor does *not* format the text or validate the syntax.

## Related Links

"Using the PeopleCode Editor" (PeopleTools 8.58: PeopleCode Developer's Guide)

"Using the SQL Editor" (PeopleTools 8.58: PeopleCode Developer's Guide)

"Understanding Application Packages" (PeopleTools 8.58: PeopleCode Developer's Guide)

## Working with Definitions

This section provides an overview of definitions and discusses how to:

- Open definitions.
- View definitions.
- View and edit definition properties.
- Create definitions.
- Save definitions.
- Close definitions.
- Rename definitions.
- Delete definitions.
- Find definitions.
- Use the Multiple Document interface.
- Use drag-and-drop mouse techniques.
- Use dynamic toolbars and menus.
- Use pop-up menus.
- Configure the Application Designer user interface.
- Work with generated files.

---

**Note:** Certain dialog boxes only allow the selection of *All Projects* in the Project field.

---

## Understanding Definitions

You can create or modify many types of definitions in PeopleSoft Application Designer. This table lists development definitions:

<b>Definition</b>	<b>Description</b>
Activity	Workflow map showing the individual steps, events, and routings that comprise a complete activity in a business process.
Analytic Model	The representation of a methodology used exclusively with the PeopleSoft Analytic Calculation Engine.
Application Engine	Program comprising SQL statements and PeopleCode programs that runs in batch mode as an alternative to using COBOL or SQR programs.



<b>Definition</b>	<b>Description</b>
Application Package	Packages for creating Application Classes, which you can use to extend the functionality of existing PeopleTools classes (Rowset, Array, and so on) or to create your own classes.
Approval Rule Set	Workflow maps that provide a visual representation of approval rules. Virtual Approver reads approval rule sets to determine who must approve transactions.
Business Interlink	Gateway between PeopleSoft applications and the services of an external system.
Business Process	Workflow maps that provide a visual overview of the activities involved in a procedure.
Component	Representation of a logical business transaction or a set of logically related pages that are processed together.
Component Interface	Way of externalizing access to a component so that it can be used by a third party or an application message.
Field	Individual pieces of data, such as an employee ID, that a user can enter and the system can store in the database, in a column on a table, or in a view.
File Layout	Definition (or mapping) of a file to be processed. It identifies where data fields are located in a file.
HTML	Definition that represents static HTML that can be included on a page definition.
Image	Definition that stores and displays graphics or other images, such as icons, that appear throughout the application. <hr/> <b>Note:</b> Image definitions and image fields are not the same. <hr/>
Menu	Definition that organizes the components that you build and the pages contained in the components.
Message	Based on a multilevel structure, similar to components, a way of defining the data to insert into an application message at runtime.
Message Channel	Corresponding to groups of message definitions, these help order messages properly, enhance scalability, and provide a simple way to define processing characteristics of many similar messages as a single group.
Page	User-defined collection of controls created for entering, viewing, and editing data online. The system validates user input, writes it to the database, and retrieves and displays it upon request.
Project	User-defined collection of related definitions created for developing, adapting, or upgrading a PeopleSoft application.

<b>Definition</b>	<b>Description</b>
Problem Type	In optimization, a way to tie the optimization application records, the optimization transactions, and the optimization plug-in together as one entity.
Record	Tables that store all of the data that resides in PeopleSoft applications part of a relational database system. Tables are the same as records, and each record definition describes the properties of an underlying SQL table.
SQL	Entire SQL programs or fragments of SQL statements available for reuse.
Style Sheet	Collection of styles that PeopleSoft Pure Internet Architecture application pages can use.

## Opening Definitions

Use the definition workspace to access or create definitions.

To open a definition:

1. Select File > Open or click the corresponding toolbar button.

The Open Definition dialog box appears.

**Image: Open Definition dialog box**

This example illustrates the fields and controls on the Open Definition dialog box.

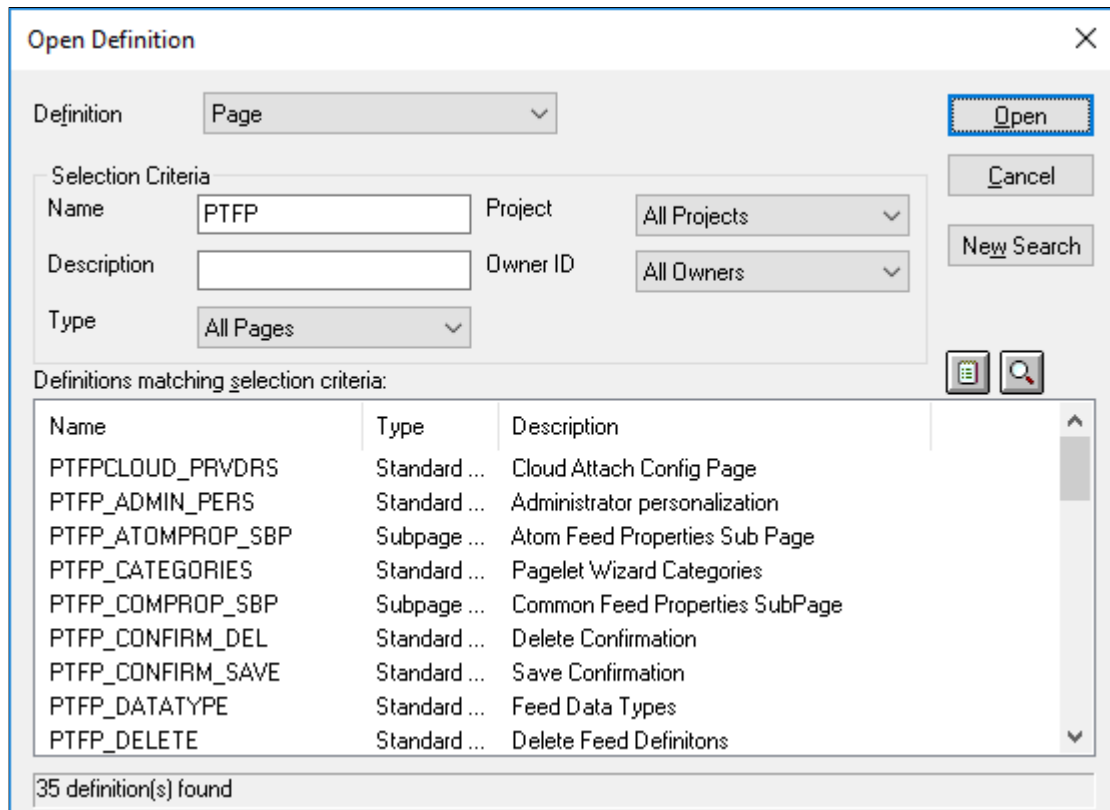

2. Select the type of definition that you want to open from the Definition drop-down list box.
3. Provide selection criteria.

Enter a definition name or description (or the beginning characters of either). Other selection criteria options might be available, depending on the definition type.

4. Click Open, or press ENTER, to display definitions matching the selection criteria that you entered.

To clear the current selection criteria and start over, click New Search. To change how the system displays the search list, perform one of these actions:

- Click the List button to see only the names of the definitions.
- Click the Details button to see the names and descriptions of the definitions. This is the default.

5. Select a definition to open.
6. Double-click the definition that you want to open in the definition workspace, or highlight the definition and click Open.

You can also use the shift-click selection technique to select more than one definition to open in a single action, or you can right-click to view a pop-up menu, where you can open, print, rename, or delete the selected definition.

---

**Note:** The print menu is disabled when you right-click any of the following definitions: activity, approval rule set, business process, component interface, component, and project.

---

**Note:** When the definition is open and able to be modified, "Ready" appears in the lower left-hand corner of the workspace.

---

## Viewing Definitions

In the project workspace, you can view a definition that is referenced by the active definition.

To view a definition, select View > View Definition. You can also right-click the definition you want to view and select View Definition from the pop-up menu.

## Viewing and Editing Definition Properties

Properties are associated with each definition type. To view or edit definition properties, select File > Definition Properties. You can also click the toolbar button, press Alt+Enter, or right-click the definition and select Properties from the pop-up menu.

The Definition Properties dialog box almost always includes a General tab that provides a place to display and enter descriptions and comments about the definition. An optional Owner ID drop-down list box designates the owner of an individual definition. This ID helps identify which application team last made a change to a definition. Set the default owner ID for new definitions in the Options dialog box on the Owner ID tab.

### Image: Example of a Property sheet

This example illustrates the fields and controls on the Example of a Property sheet. You can find definitions for the fields and controls later on this page.

**Record Properties**

General Use

AMM\_DERIVED

Description: App Msg Monitor work record

Record Definition:  
This derived record is used by the Application Message Monitor.

Owner ID: PeopleTools

Last Updated  
Date/Time: 01/06/2011 9:26:53AM  
By User: PPLSOFT

OK Cancel

With PeopleSoft Application Designer, every definition that you can open (menus, pages, components, records, fields, and so on) has an associated property sheet. Definition properties that are specific to the definition type are grouped together in these definition property sheets. For example:

- Record type and record use properties are found in the Definition Properties sheet for records.
- Translate values are found in the Definition Properties sheet for fields.
- Menu groups and menu labels are found in the Definition Properties sheet for menus.

- Search record, actions, and internet settings are found in the Definition Properties sheet for components.

## Creating Definitions

When building or adapting an application, try to use existing definitions as much as possible; when that is not possible, create new definitions.

To create a new definition:

1. Select File > New or click the corresponding toolbar button.
2. Select the definition type.

The new definition appears in the definition workspace.

## Saving Definitions

To retain your changes, you must save the definition. You must name new definitions before you can save them.

To save a definition:

1. Click the Save button on the toolbar or select either File > Save or File > Save As to save a definition.

The Save and Save As commands save a single definition. Use the File, Save All command or the Save All toolbar button to save all open definitions at once.

2. If you are saving a page or component, specify the language or market.

For a page definition, the Language drop-down list box appears; for a component, the Market drop-down list box appears.

## Definition Naming Conventions

When naming definitions, use the following guidelines:

- Use only uppercase alphabetic characters (A–Z), numeric characters (0–9), or underscore (\_). Other special characters, such as the em dash (—), dollar sign, number sign, question mark, and so on, are not permitted.
- Names must begin with an alphabetic character.
- Embedded spaces are not permitted.

Instead, use an underscore.

- Avoid using accented characters.

Names containing these characters may not sort consistently, depending on workstation or locale settings, which results in problems during an upgrade.

- System definitions such as records, fields, styles, and so on generally have a name and a label or description. Generally, you should use US-ASCII characters only for the definition name. Labels or descriptions, which appear to the user, can contain non-ASCII characters.

---

**Note:** Existing Business Process and Business Process Map definitions may already contain mixed case characters. Nonetheless, newly created definition names must be all uppercase.

---

## Closing Definitions

To close a definition, either select File > Close or click the Close Window icon on the title bar of the window of the active definition. You can also select Window > Close All to close all open definitions.

## Renaming Definitions

You can rename existing definitions in a database at any time.

### Image: Rename Definition dialog box

This example illustrates the fields and controls on the Rename Definition dialog box.

**Rename Definition**

Definition: Record

Selection Criteria:

Name: ACCESS Project: All Projects

Description:

Type: Table

Buttons: Rename, Cancel, New Search

Definitions matching selection criteria:

Name	Type	Description
ACCESS_GRP_LANG	Table	Related Language Table
ACCESS_GRP_TBL	Table	Tree Access Groups

2 definition(s) found

To rename a definition in the database:

1. Select File > Rename.

The Rename Definition dialog box looks like the Open Definition dialog box, and you select definitions in the same way.

2. Specify the definition type and any selection criteria that are useful in locating the definition that you want to rename.

The Rename Definition dialog box does not have a Select button. So, after entering either a partial name or description of the definition, press Enter to retrieve a list of definitions matching your selection criteria.

3. Select the definition that you want to rename.
4. Click the Rename button in the dialog box and double-click the selected definition, or right-click to select Rename from the pop-up menu.

The selected definition name in the Rename Definition dialog box is in edit mode.

5. Change the selected definition name and press Enter.

When you press Enter, PeopleSoft Application Designer prompts you first, to close any open definitions before you can save the new name, and then to confirm the rename before you can save a change.

6. Click OK to complete the renaming of the selected definition.

## Deleting Definitions

Deleting a definition is different from removing a definition from a project. When you remove a definition from a project, the reference to the definition is removed from the project, but the definition still exists in the database and, thus, may be part of another project. Deleting a definition, however, permanently removes the definition from the database. Any projects or other definitions that contain the deleted definition are affected.

Before deleting a definition you should find all references to that definition by running the Find Definition References process. For example, a field definition that you want to delete may be referenced by both record and page definitions.

---

**Note:** If you delete a component definition, you must delete all component interfaces that are based on that definition.

---

---

**Note:** A component definition must contain at least one page. If you attempt to delete a page definition that is the only page definition within a component, the system does not allow the delete to occur and displays an error message. If the page definition is the only page within a component, the error message appears during a File, Delete action or during an upgrade copy to database (with a Delete action).

---



**Image: Delete Definition dialog box**

This example illustrates the fields and controls on the Delete Definition dialog box.

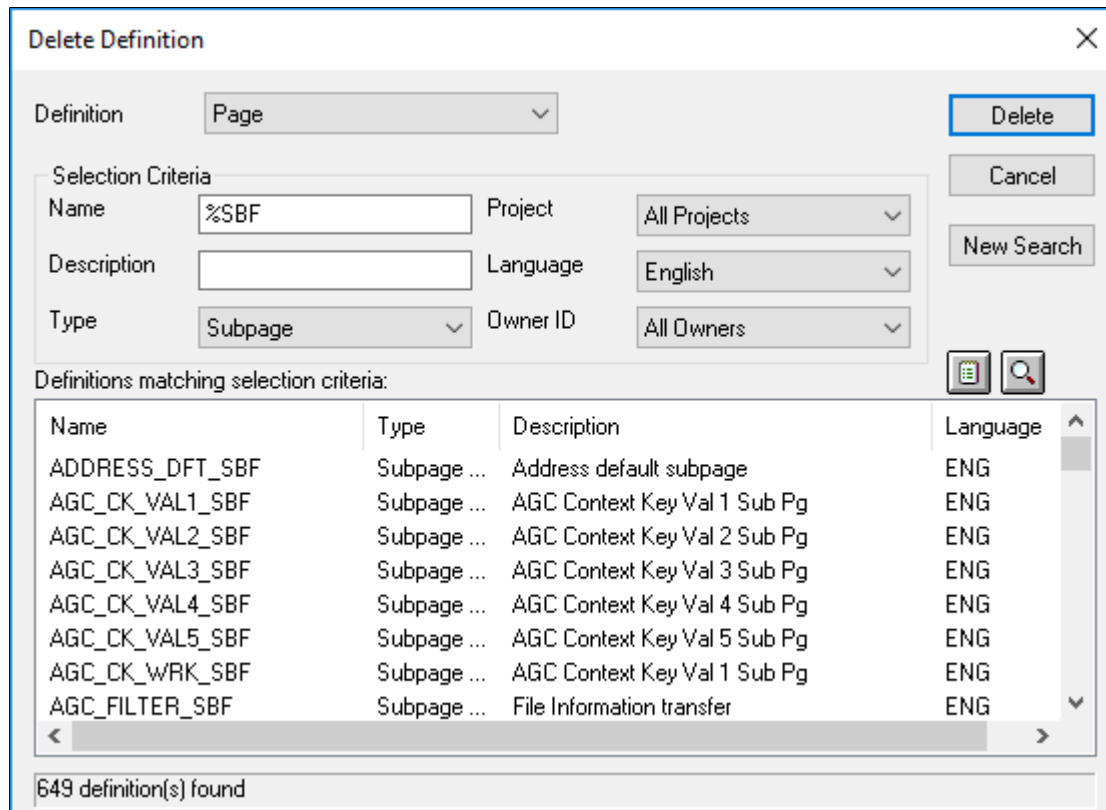

To delete a definition from the database:

1. Select File > Delete.

The Delete Definition dialog box looks like the Open Definition dialog box, and you select definitions in exactly the same way.

2. Specify the definition type and any selection criteria that are useful in locating the definition that you want to delete.

After entering either a partial name or description of the definition, press Enter to retrieve a list of definitions matching your selection criteria.

3. Select the definition that you want to delete.

To select multiple definitions, hold down either Shift or Ctrl while clicking the appropriate definitions.

4. Click the Delete button and confirm that you want to delete the selected definition.

## Finding Definition References

Before making significant changes, such as deleting a definition or modifying a definition, you must see what other parts of the application might be affected by the change. The Find Definition References feature enables you to assess the impact of a potential change to a definition, by performing a comprehensive search of the database pinpointing all definitions in which the definition in focus is located.

**Note:** Although a project keeps track of your definitions, the definitions are not actually embedded in the project.

**Note:** The distinction between *related* definitions and *referenced* definitions is significant. A related definition is one that *is used by* the current definition. A referenced definition is one that *uses* the current definition. For example, in the case of a record definition, fields in the record are related definitions. The records that use the fields are its definition references.

## Using the Find Definition References Feature

### Image: Finding definition references

This example illustrates how to find definition references.

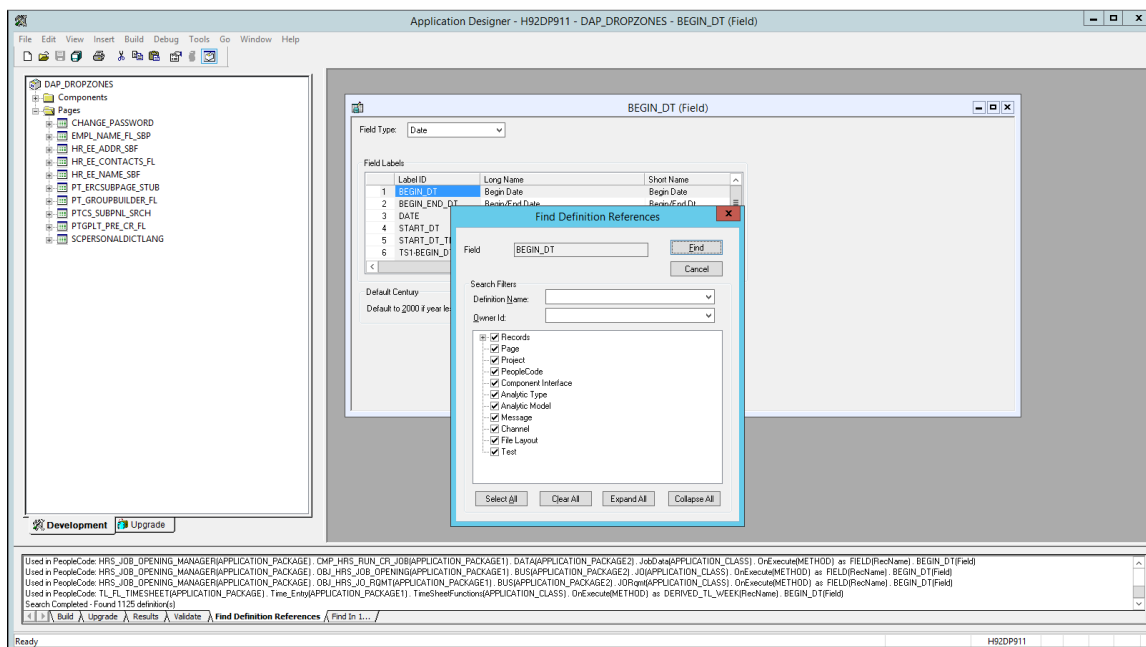

To find definition references:

1. Open the definition in the definition workspace.
2. Select Edit > Find Definition References > or right-click the definition and select Find Definition References from the pop-up menu.

After you select this item, a search of the database takes place, and the results appear on the Find Definition References tab of the output window.

3. For Records, fields, record fields, and field labels, select any filtering options from the Find Definitions References dialog box.

See the following sections for information on filtering search results for these definition types.

4. Select any definition that appears in the output window by double-clicking it.

The selected definition opens in the definition workspace.

5. After you find a definition, select the definition reference and right-click to view the pop-up menu.

---

**Note:** Double-clicking an entry in the Find Definition References output window opens the appropriate mode of PeopleSoft Application Designer. If you double-click a related record that was found, the record opens and the field for which you were looking is highlighted.

---

## Common Controls for Find Definition References Filtering

When you select Find Definition References for a record, field, record field, or field label, the Find Definition References dialog box appears, providing additional options for filtering and refining the definitions in which you want to search for references. The following sections describe the options and usage.

<b>Definition Name</b>	To filter search results by a definition name, enter the definition name or partial definition name.
<b>Owner ID</b>	To filter search results by a specific owner ID, select the owner ID from the drop-down list.
<b>Select All</b>	Select all definition types in the definition filter tree.
<b>Clear All</b>	Clear all definition type selections in the definition filter tree.
<b>Expand All</b>	Expand all applicable definition type nodes in the definition filter tree.
<b>Collapse All</b>	Collapse all applicable definition type nodes in the definition filter tree.

## Using the Find Definition References Feature for Fields

### Image: Find Definition References for Fields

This example illustrates the Find Definition References dialog for fields displaying the options to select for narrowing the scope of the search.

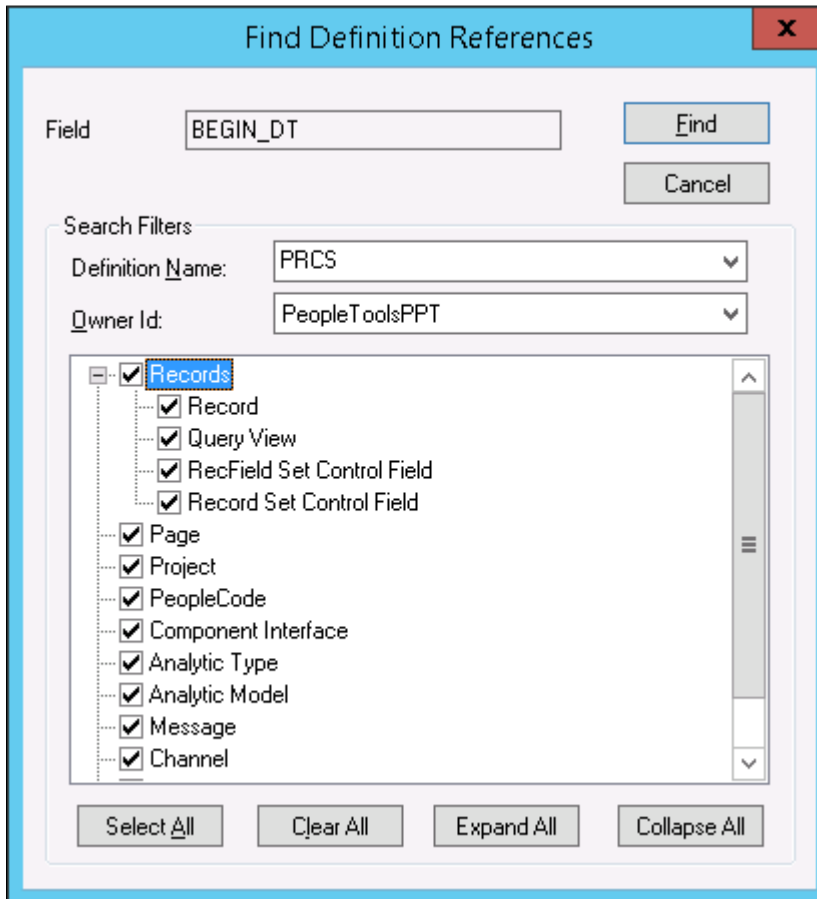

When you select Find Definition References for a field definition, the Find Definition References dialog box displays a set of options for filtering the definition types searched. For example, if you select to search only in *Records* (all types listed) and *Page* only references in record and page definition types will appear in the output window, enabling you to find the applicable references quicker.

For fields, you can select to search for references in these definition types:

- Records
  - Record
  - Query View
  - RecField Set Control Field
  - Record Set Control Field
- Page
- Project

- PeopleCode
- Component Interface
- Analytic Type
- Analytic Model
- Message
- Channel
- File Layout
- Test

## Using the Find Definition References Feature for Records

### Image: Find Definition References for Records

This example illustrates the Find Definition References dialog for records displaying the options to select for narrowing the scope of the search.

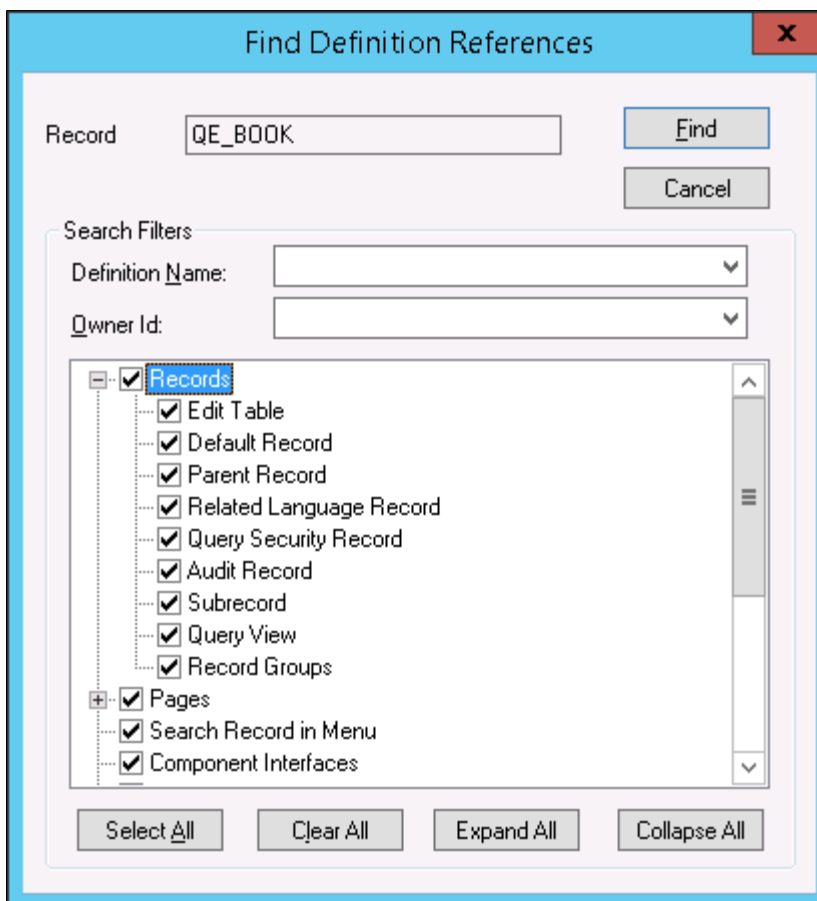

When you select Find Definition References for a record definition, the Find Definition References dialog box displays a set of options for filtering the definition types searched. For example, if you select to search only in *Records* (all types listed) and *Pages* (all types listed) only references in record and page definition types will appear in the output window, enabling you to find the applicable references quicker.

For records, you can select to search for references in these definition types:

- Records
  - Edit Table
  - Default Record
  - Parent Record
  - Related Language Record
  - Query Security Record
  - Audit Record
  - Sub record
  - Query View
  - Record Groups
- Pages
  - Panel
  - Tree Control Panel
  - Search Record in Panel Group
  - Add Search Record in Panel Group
  - Tree
- Search Record in Menu
- Component Interfaces
- Project
- Virtual Approver
- Application Engine
  - State records
  - Temp records
- Problem Type Definition
- Business Process Designer
- PeopleCode
- Messaging

- File Layouts
- Analytic Model
- Test Framework

## Using the Find Definition References Feature for Record Fields

### Image: Find Definition References for Record Fields

This example illustrates the Find Definition References dialog for record fields displaying the options to select for narrowing the scope of the search.

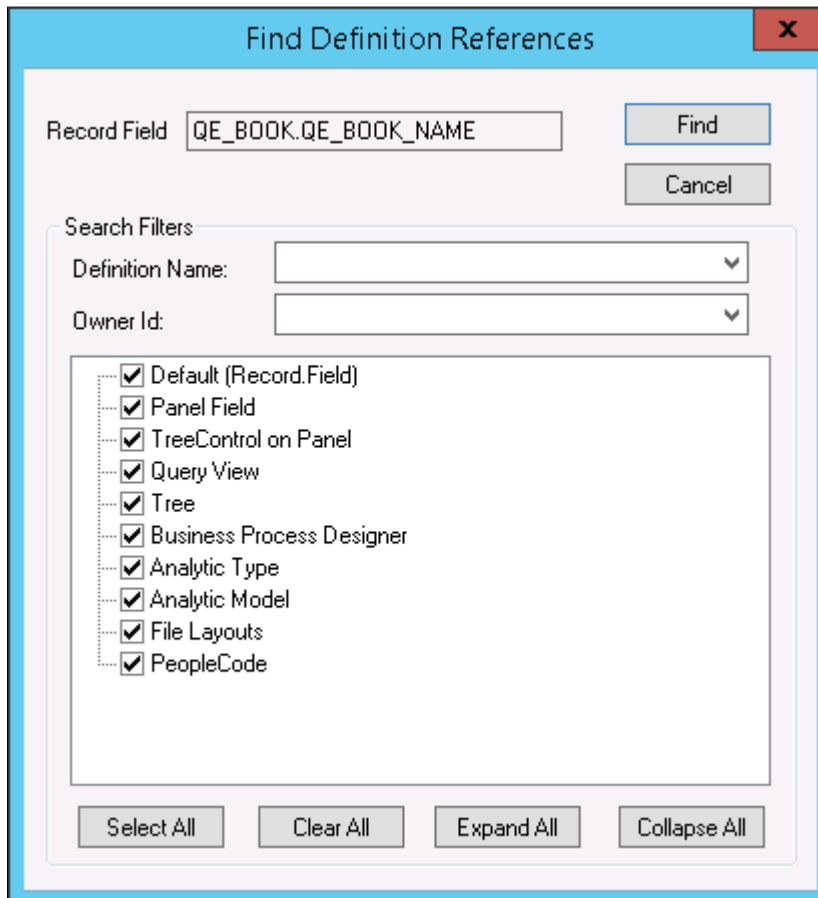

For record fields, you can filter your search by:

- Record Field (default)
- Panel Field (page field)
- Tree Control on Panel (page)
- Query View
- Tree
- Business Process Designer
- Analytic Type

- Analytic Model
- File Layouts
- PeopleCode

## Using the Find Definition References Feature for Field Labels

### Image: Find Definition References Feature for Field Labels

This example illustrates the Find Definition References dialog for field labels displaying the options to select for narrowing the scope of the search.

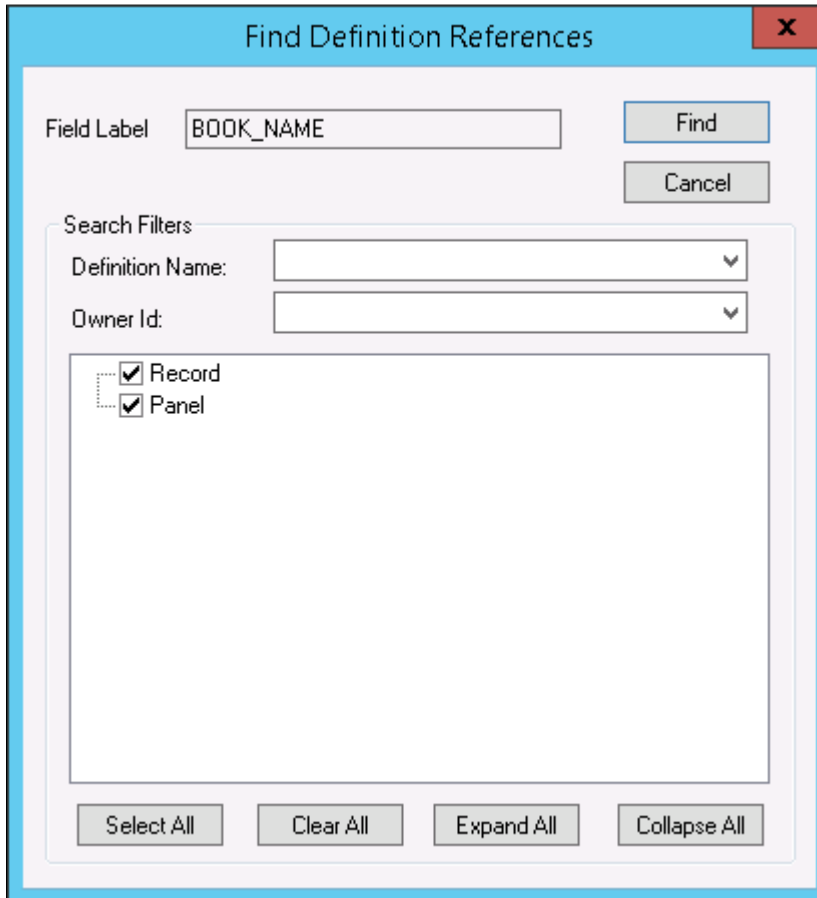

For field labels, you can filter your search by:

- Record
- Panel (page definitions)

### Related Links

"Using the Find In Feature" (PeopleTools 8.58: PeopleCode Developer's Guide)

## Using the Multiple Document Interface

PeopleSoft Application Designer makes use of multiple document interface (MDI). Consequently, each window in the definition workspace of PeopleSoft Application Designer represents a view of a definition,



and you can have multiple windows open at the same time. These definition windows must stay inside the borders of the definition workspace, but you can maximize, minimize, cascade, or tile them in that space.

You can have different types of definition windows open at the same time, such as menu, field, record, and page windows. As a result, you can work with different definitions simultaneously, which simplifies the process of designing a group of related definitions.

## Active Windows

Although you can have multiple windows open at the same time, only one window can be active at any moment. Make a window active by selecting it in the definition workspace. The active window always appears on top with the title bar in *active window title* color.

In addition to clicking a window to make it active, you can also use the Window menu shown in the following example. This menu displays the windows that are currently open by displaying a check mark next to the active one. Change the window that is currently active by selecting it from the menu.

### Image: Example of the Window menu

This example illustrates the fields and controls on the Example of the Window menu. You can find definitions for the fields and controls later on this page.

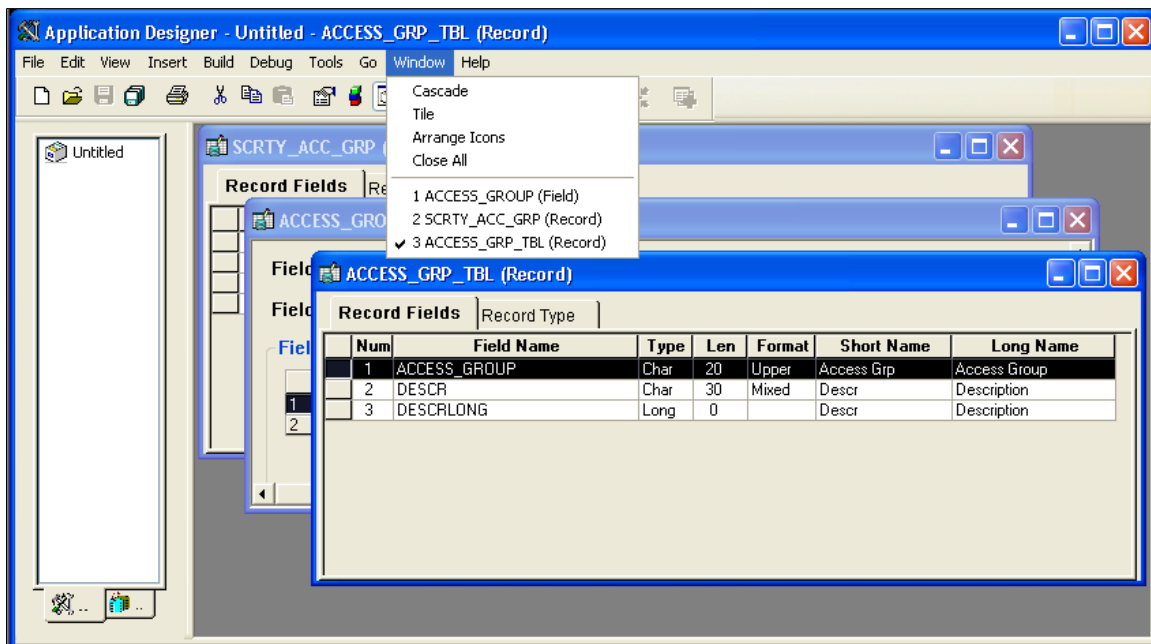

Other commands from the Window menu include Cascade, Tile, Arrange Icons, and Close All windows.

## Using Drag-and-Drop Mouse Techniques

PeopleSoft Application Designer makes ample use of drag-and-drop mouse techniques. For example, you can drag a field from a record definition and drop it onto a page definition. You can then drag the page onto a component and drag the component onto a menu. Using the drag-and-drop technique is faster and simpler than using menu commands to manipulate definitions.

To drag and drop a definition:

1. Open the definition in either the project workspace or the definition workspace from which you want to drag.

For example, to drag a field from an existing record definition to a new page definition, first open the record containing the field. You can open it in the definition workspace or expand the record in the project workspace so that the fields appear. With the appropriate field displayed, you can drag and drop it into another definition.

2. Open the definition to which you want to drag.
3. Drag the definition from one definition to the other.

## Using Dynamic Toolbars and Menus

The PeopleSoft Application Designer toolbar and menus change based on the type of definition that is active. For example, when a page definition is active, the toolbar displays buttons that represent the definitions that you can add to a page. This technique is also known as *morphing*.

The change is so subtle that you can easily miss it. The change is easy to miss because the menu bar names are consistent among definition types. However, if you look at the menu items and toolbars closely, you see a distinct difference. For example, if a page window is active, then the menus and toolbars change to include actions and options applicable to a page definition, as in the Show Grid option on the View menu and the introduction of the Layout menu. In addition, page-specific toolbars appear.

In the same respect, if a record window is active, the menus and toolbars morph to include actions and options applicable to a record definition. For example, different options (such as View, Field Display, and so on) are available in the View menu. Different toolbar buttons for record definition actions also appear.

## Using Pop-up Menus

Pop-up menus are context-sensitive menus that appear at the current location of the mouse pointer whenever you click the alternate mouse button (typically, the right mouse button). They provide efficient access to numerous PeopleSoft Application Designer commands. Because pop-up menus appear at the current location of the pointer, they eliminate the need to move the pointer up to the menu bar or to a toolbar. A pop-up menu contains only the commands that apply to the selected definition or the current context. This example shows the component definition pop-up menu:

### Image: Example of the Component definition pop-up menu

This example illustrates the fields and controls on the Example of the Component definition pop-up menu. You can find definitions for the fields and controls later on this page.

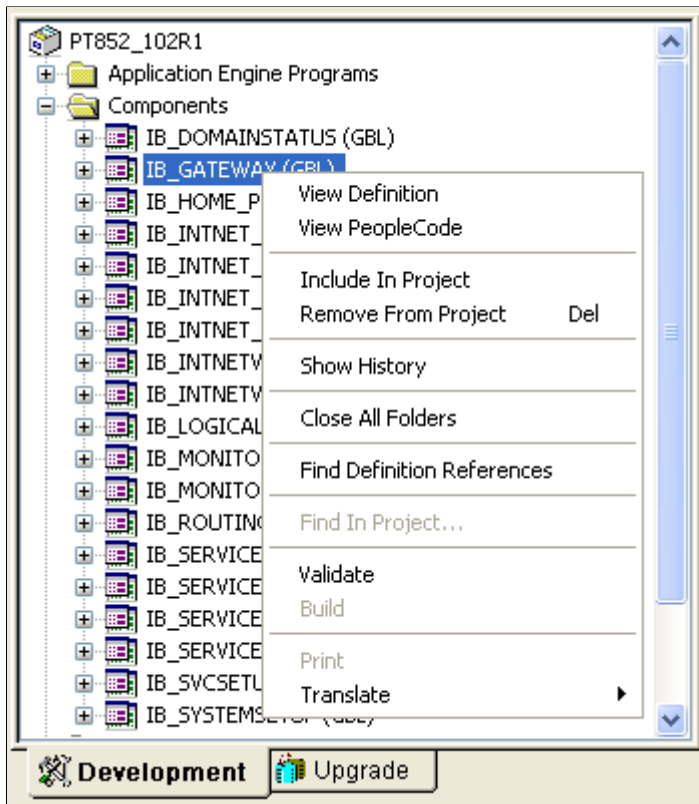

## Configuring the Application Designer User Interface

PeopleSoft Application Designer is highly configurable, enabling you to tailor the tool to your needs or preferences.

### Splitter Bars

A splitter bar is a thin vertical or horizontal bar that separates windows inside a parent window. Using the splitter bar enables you to resize two windows at the same time. Splitter bars are used between the project workspace, definition workspace, and output window. This example shows splitter bars:

### Image: Example of Splitter bars used to resize a workspace

This example illustrates the fields and controls on the Example of Splitter bars used to resize a workspace. You can find definitions for the fields and controls later on this page.

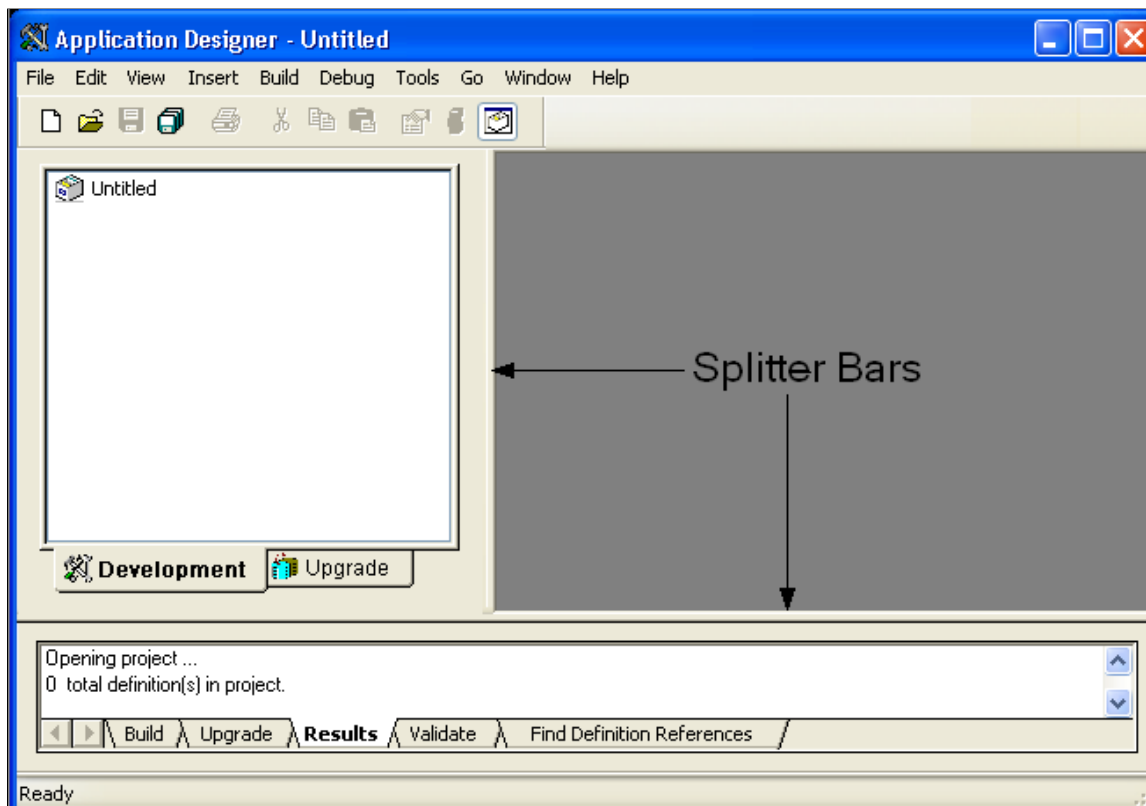

Drag the splitter bar to change the size of the project workspace, definition workspace, or output window.

### Dockable Windows and Toolbars

You can freely move PeopleSoft Application Designer windows and toolbars to either anchor (dock) to parts of the main application window or float freely anywhere that you want them to appear. When you dock a toolbar or window, you anchor it to the top, sides, or bottom of the main window.

To move or dock a PeopleSoft Application Designer window or toolbar, drag the window title bar or the appropriate toolbar to a new location. If you move the window or toolbar near the top, bottom, or sides of the main window, the window or toolbar snaps into place, meaning that it is docked. However, if you press and hold Ctrl and then drag the window or toolbar, you can prevent it from automatically docking when it is near the edge of the window.

---

**Note:** Use caution when running the PeopleCode Debugger with undocked windows.

---

### View Menu

The View menu enables you to display or hide different PeopleSoft Application Designer elements, such as the project workspace, output window, and toolbar.

## Working with Generated Files

When working with PeopleSoft Application Designer, you often generate scripts, logs, reports, and so on. When specifying the full path for a file reference in PeopleSoft Application Designer, you are limited to 100 characters. This limit applies to all file references, which include build scripts, build logs, compare reports, and so on. For example, a reference to a build log, such as `c:\temp\...\psbuild.log`, cannot exceed 100 characters.

---

## Using Miscellaneous Definitions

Several definition types differ from the standard definitions described in previous sections. These definitions control your work environment or affect other definitions that you create. These miscellaneous definitions are found under the Tools menu and include:

- Field Formats
- System Colors
- Styles
- Access Profiles
- File Type Codes

### Field Formats

PeopleTools provides formatting at both the field and page levels. Field format specifications affect internal values that are stored in the database, and page format specifications affect the visual presentation of values. Several formatting options are available for U.S. Social Security Numbers, Canadian Social Insurance Numbers, postal codes, telephone numbers, and various currencies, dates, and times.

Custom field formats extend these formatting provisions to support the same types of data in other countries. They also support other types of formatted information, such as bank codes, credit card numbers, part numbers, and serial numbers.

Custom field formats enable you to create your own format definitions using format notation and apply them to fields. These formats are organized into format families, which can include one or more unique formats.

See [Changing Format Families](#).

### System Colors

You can establish definitions for colors that you use in your applications. You define colors by associating a color name either with an existing color in the PeopleSoft Internet Architecture or with a custom color that you define. Since taste in color is subjective, PeopleTools allows individual operators to customize their color settings. Users can use the default color definitions you establish in PeopleSoft Application Designer, or they can override them with their own color definitions.

**Image: Setting default system colors**

This example illustrates the fields and controls on the Setting default system colors. You can find definitions for the fields and controls later on this page.

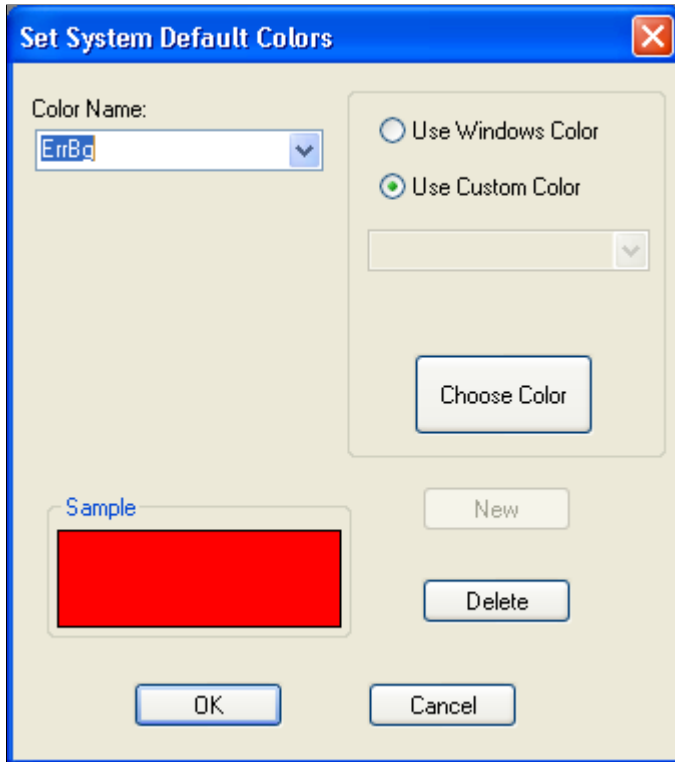

To modify default system colors:

1. Select Tools > Miscellaneous Definitions > System Colors.
2. Select the Color Name you want to modify.
3. To change the color, click the Choose Color button.
4. Choose from the available colors or click Define Custom Colors to create your own color.
5. Click OK.

The new color appears in the Sample area of the Set System Default Colors dialog box.

To create new system colors:

1. Type a new name in the Color Name field and click the New button.
2. Select the Use Custom Color radio button to select a custom color.
3. Click the Choose Color button.
4. Choose from the available colors or click the Define Custom Colors button.
5. Click OK in both dialog boxes to accept the new color.

## Styles

This feature is deprecated. You set styles using style sheet definitions.

See [Understanding Style Sheets and Style Classes](#).

## Access Profiles

Access profiles are the security profiles the system uses to connect to the PeopleSoft database. The product documentation for PeopleTools security provides detailed information about access profiles.

See "Setting Up Access Profiles" (PeopleTools 8.58: Security Administration).

## File Type Codes

You may need to set up file type codes when creating change projects. You create change projects to work with the PeopleSoft Application Designer Change Packager tool to package system customizations in preparation for an upgrade. The file type code stores generic information that is applicable to a group of files within the same target directory.

See "Understanding Change Packages" (PeopleTools 8.58: Change Assistant and Update Manager).

---

# Using the PeopleSoft Application Designer Spell Check Feature

This section provides an overview of the PeopleSoft Application Designer spell check feature and discusses how to:

- Enable the spell check feature.
- Configure browser options.

## Understanding the Spell Check Feature

The PeopleSoft Application Designer spell check feature checks the spelling for user-facing labels and text in projects and legacy data. Use this feature before building your application. The spell check feature verifies spelling for these items:

- Message Catalog entries.
- Page definitions (label text).
- Translate (XLAT) tables.
- Component definitions (tab and menu labels).
- Portal registry (labels and attribute labels).
- Record field labels.

## Spell Check Results

The system logs spell check results on the Spell Check tab in the PeopleSoft Application Designer output window. The text *Begin Spell Check* always appears as the first line on the tab. The first line for each spell

check category indicates the total number of entries that were checked for the project. The last line in the output window indicates the total misspelled words encountered during the check.

For each spell check category the results may read differently. This table describes how to read the spell check results for each category:

<b>Output by Error Type</b>	<b>Description</b>
<p>Message Catalog:</p> <p>Message Set www Nbr xxx (yyy) - zzz</p> <p>For example: Message Set 1 Nbr 1 (Message Text) - Distributed Object Mgr: Xelp Xme=Xangage=abc rtz</p>	<p>Where:</p> <p>www = Message set number.</p> <p>xxx = Message number within the message set.</p> <p>yyy = :</p> <ul style="list-style-type: none"> <li>• Message text, indicating that zzz is the complete message text.</li> <li>• Explain text, indicating that zzz is the complete explain text.</li> <li>• Misspelling, indicating that zzz is a misspelled word in either message text or explain text.</li> </ul>
<p>XLAT:</p> <p>[vvv.www.xxx] (yyy) - zzz</p>	<p>Where:</p> <p>vvv = Database field name.</p> <p>www = Field value.</p> <p>xxx = Effective date.</p> <p>yyy =:</p> <ul style="list-style-type: none"> <li>• Long name, indicating that zzz is the complete text for the long name.</li> <li>• Short name, indicating that zzz is the complete text for the short name</li> <li>• Misspelling, indicating that zzz is a misspelled word in either a long or short name.</li> </ul>



<b>Output by Error Type</b>	<b>Description</b>
<p>Component:</p> <p>[vvv.www] Item Name xxx (yyy) - zzz</p>	<p>Where:</p> <p>vvv = Component name.</p> <p>www = Market code.</p> <p>xxx = Item name for the component.</p> <p>yyy =:</p> <ul style="list-style-type: none"> <li>• Item label, indicating that zzz is the complete text for the item label of the component.</li> <li>• Folder tab label, indicating that zzz is the complete text for the folder tab label of the component.</li> <li>• Misspelling, indicating that zzz is a misspelled word in either the item label or the folder tab label.</li> </ul>
<p>Portal Registry:</p> <p>[ttt.uuu.vvv] www xxx (yyy) - zzz</p>	<p>Where:</p> <p>ttt = Portal name.</p> <p>uuu = C for content reference, F for folder.</p> <p>vvv = Portal object name.</p> <p>www =:</p> <ul style="list-style-type: none"> <li>• Empty.</li> <li>• Attribute.</li> <li>• System attribute.</li> </ul> <p>xxx =:</p> <ul style="list-style-type: none"> <li>• Empty if www is empty.</li> <li>• Attribute name if www is attribute.</li> <li>• System attribute name if www is system attribute.</li> </ul> <p>yyy =:</p> <ul style="list-style-type: none"> <li>• Label name, indicating that zzz is the complete text for the label name.</li> <li>• Display name, indicating that zzz is the complete text for the display name of an attribute.</li> <li>• Misspelling, indicating that zzz is a misspelled word in either the label name or the display name.</li> </ul>

<b>Output by Error Type</b>	<b>Description</b>
Field Label: [www.xxx] (yyy) - zzz	Where: www = Field name. xxx = Field label name. yyy = <ul style="list-style-type: none"> <li>• Long name, indicating that zzz is the complete text for the long name.</li> <li>• Short name, indicating that zzz is the complete text for the short name</li> <li>• Misspelling, indicating that zzz is a misspelled word in either a long or short name.</li> </ul>
Page: [www] Field ID xxx (yyy) - zzz	Where: www = Page name. xxx = Field ID within the page. yyy = <ul style="list-style-type: none"> <li>• Label text, indicating that zzz is the complete text for the label text of the field.</li> <li>• Scroll area, indicating that zzz is the complete text for label text within a scroll area.</li> <li>• Misspelling, indicating that zzz is a misspelled word in the label text.</li> </ul>

You can launch an identified definition directly from the output window by double-clicking the error line. PeopleSoft Application Designer launches the appropriate content to correct the misspelling, as described in this table:

<b>Error Type</b>	<b>Launches</b>
Message Catalog	NA
XLAT	Field definition.
Component	Component definition.
Portal registry	Browser to display the Content or Folder Administration page.
Field label	Field definition.
Page	Page definition.

## Enabling the Spell Check Feature

The spell check feature is turned off by default. You enable the spell check feature in the Options dialog box on the Validate tab. Enabling the spell check option ensures that spell check is run on the designated project when you validate the project.

To enable spell check in PeopleSoft Application Designer:

1. Select Tools > Options from the PeopleSoft Application Designer menu.
2. Select the Validate tab.
3. Select the Validate Spelling check box.
4. (Optional) Select the Log to file check box if you want the spell check results to be saved to a file on your system.
5. Enter a file name in the File name field or click the browse button to search for a specific file.

Otherwise, the system applies the default file name of *spellcheck.log* and saves the results to the temp directory. This field is required when the Log to file option is selected.

## Configuring Browser Options

The Browser tab on the Options dialog box enables you to specify values that are required to compose a URL for the browser to locate a portal page. The spell check feature uses the information recorded in this dialog box to launch portal pages from the Spell Check tab in the output window when you double-click a portal registry misspelling.

### Image: Options dialog box: Browser tab

This example illustrates the fields and controls on the Options dialog box: Browser tab. You can find definitions for the fields and controls later on this page.

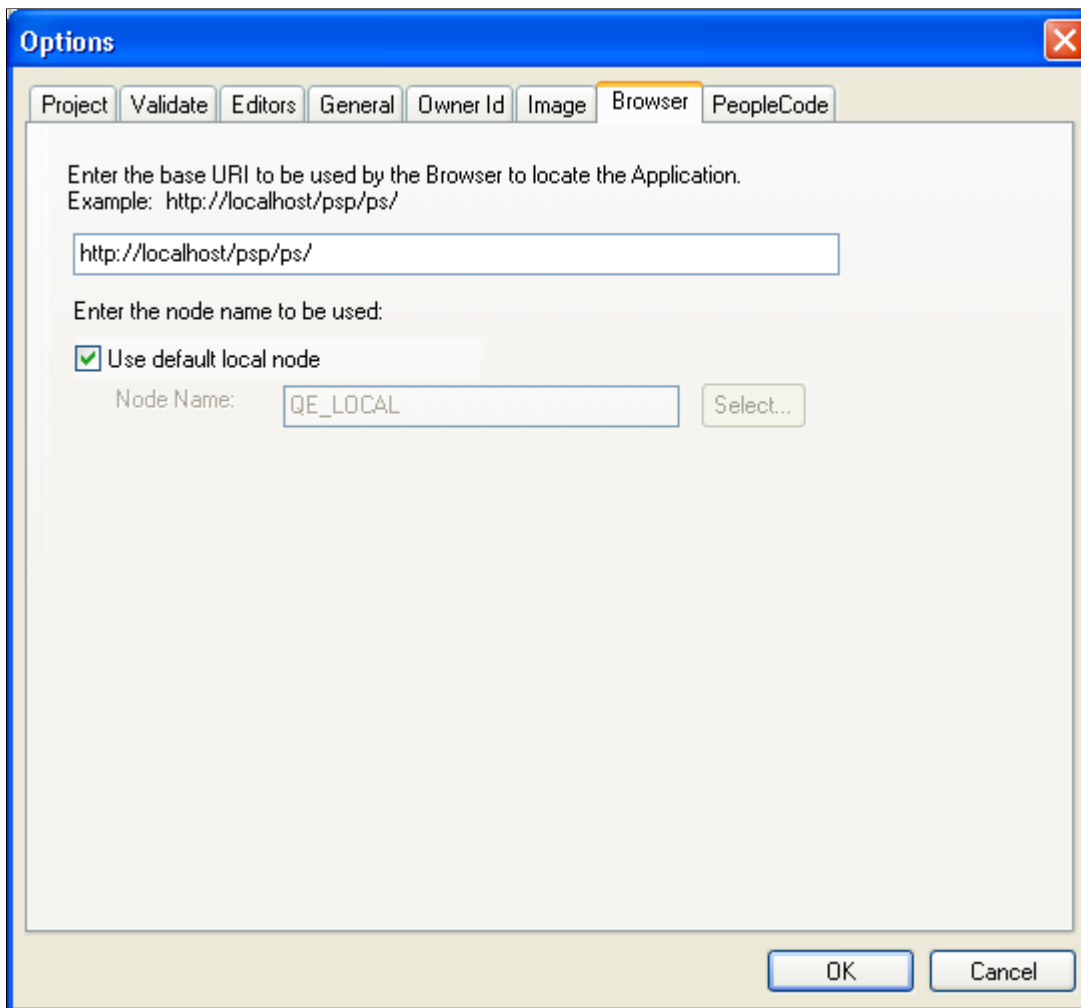

To configure browser options:

1. Select Tools > Options and click the Browser tab.

2. Enter the base URI or use the default setting.

This value is the URI of the node that hosts the portal.

3. Set the node name to be used with the base URI.

The Use default local node check box is selected by default. Deselecting this check box enables the Select button, which allows you to set the node name in the Select Node dialog box.

The Select Node dialog box displays the list of available nodes by project. You can search for the appropriate node by clicking the Select button.

---

## Building and Maintaining Data

This section discusses how to:

- Build and maintain data.
- Create SQL tables.

## Building and Maintaining Data

You must keep underlying database definitions synchronized with PeopleSoft definitions. Therefore, from PeopleSoft Application Designer, you must:

- Submit SQL Alter and Create commands for all types of database definitions.
- Manage the database index.
- Manage the table space.
- Manage the DDL model for tables, indexes, and table spaces.

## Creating SQL Tables

To access data, you must create a SQL table and then store data in the fields and records. The process of running the SQL to synchronize the database with records, indexes, and DDL is called the Build process.

The Build feature processes definitions at these levels:

- Current record.
- Selected records in the project workspace.
- All records in the project.

### Related Links

[Understanding Data Administration and the Build Process](#)

---

## Using PeopleSoft Application Designer Command Line Parameters

PeopleSoft Application Designer offers a variety of command line parameters that you can use to control the database to which it connects. By using these parameters, you can automatically navigate to the part of the system that you need.

Use the values from the following tables to specify certain parameters.

### Syntax

The following command line syntax applies to all actions identified in this topic:

PSIDE [-parameter value [-parameter value . . .]]

You can include as many or as few parameters as you need.

Each parameter starts with a hyphen (-) or a forward slash (/). The value for each parameter follows the hyphen or slash, separated by zero or more spaces. In general, the value does not need to have quotation marks around it, even if it has internal spaces: the system treats all text following the parameter as part of the value, up to the next parameter or the end of the command line.

---

**Note:** You must enclose a value in quotation marks only when it includes a hyphen or forward slash, or to include leading or trailing spaces. If the value itself includes a quotation mark character, precede the double quote with a backslash (\).

---

**Important!** Application Designer command line parameters are used extensively during upgrade and update procedures run through Change Assistant and PeopleSoft Update Manager. As such, the use of these options is documented primarily in the *PeopleTools: Lifecycle Management Guide*.

---

### Related Links

"Using the PeopleSoft Data Mover Command-Line Interface" (PeopleTools 8.58: Lifecycle Management Guide)

"Understanding PeopleSoft Application Designer Command Line Parameters" (PeopleTools 8.58: Lifecycle Management Guide)

## Chapter 3

# Working With Projects

---

## Understanding Projects

While not one of the eight steps of application development, using projects is an efficient way to organize your definitions as you develop and configure your application. A project keeps track of all definition types as a simple list of definition names; the definitions are *not* stored in the project. Development definitions exist outside of the project in your PeopleSoft database.

You are not required to use projects in PeopleSoft Application Designer; and you can create and edit individual definitions without associating them with a project. However, using projects can help you:

- Organize related definitions.
- Understand relationships among definitions.
- Coordinate the work of several developers.
- Streamline upgrade tasks.
- Search for fields or records.
- Access related definitions easily.

---

## Viewing Projects

On the left-hand side of your screen, the project workspace displays one project at a time and all of its definitions, making them easily accessible for opening and editing. The project workspace includes two views representing the collection of definitions in the project: Development and Upgrade. Switch between the views by selecting the folder tabs at the bottom of the project workspace.

This section discusses how to:

- Access project definitions.
- Use the upgrade view.

## Accessing Project Definitions

In the Development view, the project folder contains a folder for each definition type included in the project. To open folders and view related definitions, click the expand (+) button. Access project definitions by double-clicking the definition. This example shows the Development view in the project workspace:

### Image: Example of the Development view in the project workspace

This example illustrates the fields and controls on the Example of the Development view in the project workspace. You can find definitions for the fields and controls later on this page.

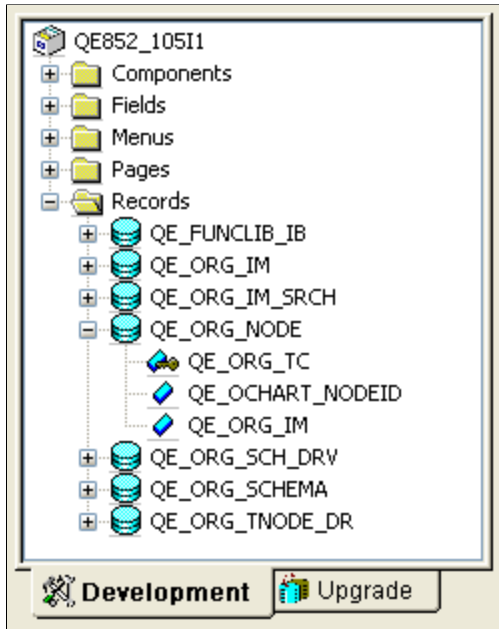

The definitions are organized by definition type and appear in a project tree. The project tree enables you to see all definitions associated with the project and their connection by showing the definitions in an hierarchical format. By expanding definitions that have nested levels, such as records, you can see the field definitions included in that record.

## Using the Upgrade View

The Upgrade view helps to streamline the migration of definitions—such as records, pages, or PeopleCode—from one PeopleSoft database to another. It displays all of the definitions available for upgrade and the attributes related to the upgrade process. When you double-click a definition type in the Upgrade view, an upgrade definition window appears in the definition workspace, displaying the definitions of that type that are available for upgrade and the associated upgrade options. This example shows the Upgrade view in the project workspace:



### Image: Example of the Upgrade view in the project workspace

This example illustrates the fields and controls on the Example of the Upgrade view in the project workspace. You can find definitions for the fields and controls later on this page.

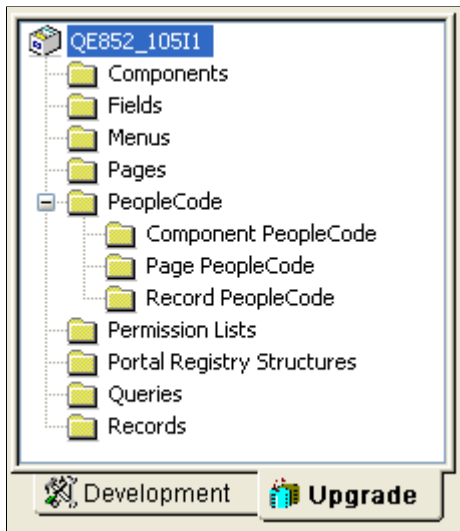

The Upgrade view is important when you move changes into production and when you upgrade to new PeopleSoft releases. Definitions in development projects and upgrade projects are interchangeable, meaning that users can use the Upgrade view to copy or compare components that were developed in PeopleSoft Application Designer.

### Related Links

"Understanding a PeopleSoft Upgrade" (PeopleTools 8.58: Lifecycle Management Guide)

## Creating and Saving Projects

This section discusses how to:

- Create new projects.
- Save projects.

**Note:** Changes that you make to a definition in a project are also reflected outside the project. Before you change a definition in a project, be aware of how it might affect other definitions outside the project. For example, when you rename or delete a field, you do so globally. Although you can enter a project name as selection criteria in certain PeopleSoft Application Designer dialog boxes (such as Open, Rename, and Delete), this is just to narrow the list of definitions returned in the selection list.

## Creating New Projects

When you start PeopleSoft Application Designer, an empty project titled *Untitled* always appears, whether you use the project or not. Unlike other definitions, only one project can be open at a time. Although you are encouraged to develop in projects, you can hide the project workspace window and ignore the project entirely.

To create a new project:

1. Select File > New.
2. Highlight Project as the new definition type to create and click OK.

---

**Note:** Another way to create a new project is to open an existing project, select File > Save Project As and then enter a new name for the project. The system copies all of the existing definitions in the project.

---

See [Saving Definitions](#).

To open an existing project, follow the same procedure as you would for any other definition type.

See [Opening Definitions](#).

## Saving Projects

When you save an entire project, you use a different command than what you use to save other types of definitions.

To save a project, select File > Save Project. You can also select File > Save Project As to save the project with a new name. Selecting File > Save Project As is a good way to make a copy of a project because the original project still exists under the original name.

The Save toolbar button saves whichever definition is active in the definition workspace, but you cannot use it to save an entire project.

---

## Setting Project Properties

Use the Project Properties dialog box to enter information about a project. Access Project Properties from the File menu.

### Image: Project Properties dialog box

This example illustrates the fields and controls on the Project Properties dialog box. You can find definitions for the fields and controls later on this page.

On the General tab, enter a description of the project and any additional comments you might want others to be aware of when using the project. Select the Change Project check box only if you are creating a change project to be used with the Change Packager. Selecting this option enables the Update IDs and the Pre-Requisites tabs, which also are used only with the Change Packager.

See "Understanding Change Packages" (PeopleTools 8.58: Change Assistant and Update Manager).

Select the appropriate Owner ID for the project. The Owner ID allows for a way to identify which definitions are owned by which PeopleSoft applications, such as PeopleSoft General Ledger, Accounts Receivables, and so on. The values in the drop-down list box are translate table values associated with the OBJECTOWNERID field.

---

## Inserting Definitions Into Projects

You can add definitions to a project by selecting Definitions into Project from the Insert menu.

This section discusses how to:

- Insert individual definitions into a project.

- Insert a group of definitions into a project.

**Image: Insert into Project dialog box**

This example illustrates the fields and controls on the Insert into Project dialog box. You can find definitions for the fields and controls later on this page.

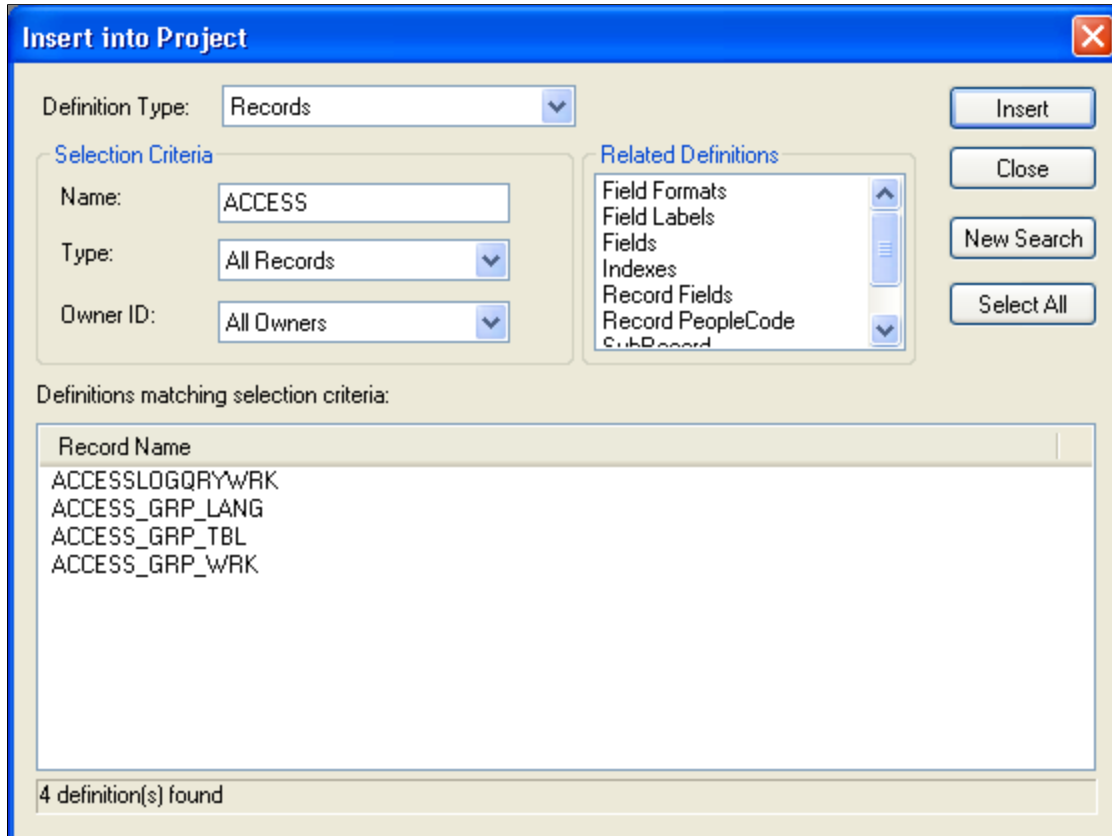

## Inserting Individual Definitions into a Project

To insert individual definitions into a project:

1. Open the definition that you want to insert into the project.

Make sure that the definition is the active definition in the definition workspace.

2. Select Insert > Current Definition into Project.

The system adds the definition to whichever project is currently open.

## Inserting a Group of Definitions into a Project

To insert a group of definitions into a project:

1. Select Insert > Definitions into Project.

The Insert into Project dialog box appears.

2. Select the type of definition to insert from the Definition drop-down list box.

To see all available definitions of one type, including upgrade-only definition types, click the Insert button or press Enter.

3. (Optional) Enter the selection criteria.

<b>Name</b>	Enter the definition name or a partial field name and press ENTER.
<b>Type</b>	Narrow your search by selecting a specific definition type, such as View for a record definition.
<b>Owner ID</b>	Narrow your search further by selecting an application with which the definition is used.

4. Select the definitions to insert.

To select multiple definitions, hold down either the Shift key or the Ctrl key while clicking the appropriate definitions.

5. (Optional) Specify which related definitions to insert.

To insert related definitions, specify them in the list of related definitions. To select multiple related definitions, hold down either the Shift key or the Ctrl key while clicking the appropriate definitions.

---

**Note:** After you insert definitions into a project, the upgrade-only definitions appear in the Upgrade view of the project workspace, not the Development view.

---

The status bar at the bottom of the Insert into Project dialog box indicates that definitions were inserted. Additionally, the Results tab on the output window displays the number of definitions inserted each time you perform an insert.

---

## Removing Definitions From Projects

Removing a definition from a project is different than deleting it from the database. When you remove a definition from a project, the reference to the definition is removed from the project, but the definition still exists in the database and thus may be part of another project.

To remove definitions from projects:

1. In the project workspace, select the definition that you want to remove from the project.

To select multiple items, highlight one or more nodes by using the Ctrl key while clicking the definitions to remove.

2. Press the Delete key or right-click to select Remove from Project from the pop-up menu.

This action does not delete the definition; it only removes it from the project.

## Merging Projects

You can merge two or more projects by inserting all of the definitions from one project into another.

### Image: Merge Projects dialog box

This example illustrates the fields and controls on the Merge Projects dialog box. You can find definitions for the fields and controls later on this page.

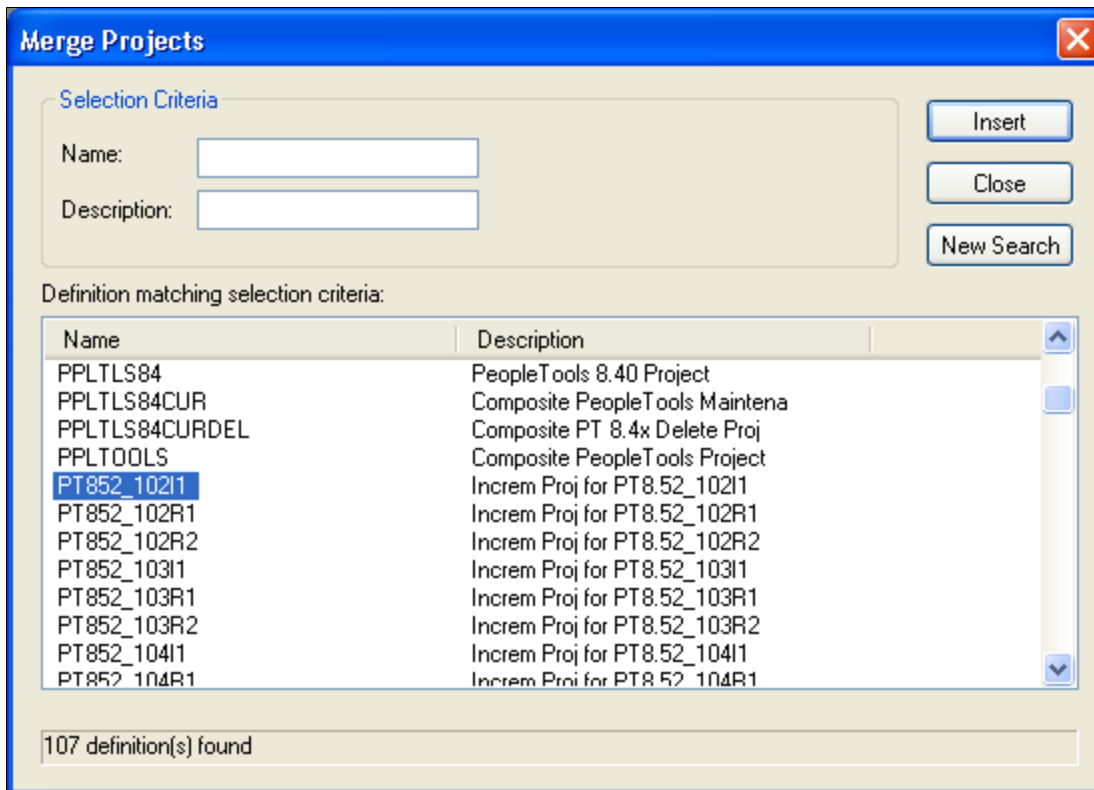

To merge projects:

1. Open the project in which you want to insert another project.
2. Select File > Merge Projects.

The Merge Projects dialog box appears.

3. Enter selection criteria.
  - a. Enter a project name or description (or the beginning characters of either).
  - b. Click Insert or press the Enter key to display projects that match the selection criteria you entered.
4. Select a project to insert into your currently open project.

Double-click the project that you want to insert or highlight the project and click Insert. To select multiple projects, use the Shift and Ctrl keys.

5. Click Insert.

The system inserts all of the selected definitions into the project in one action. After each insert, note the information in the status bar and on the Results tab in the output window.

---

## Using Change Projects

Use change projects with the Change Packager feature to group definitions that are affected by PeopleSoft application updates. Combined with the PeopleSoft Change Assistant, the Change Packager feature significantly reduces the complexity and time required to apply PeopleSoft application updates.

When you create a change project, you must set the appropriate update IDs and prerequisites.

See "Creating a Change Project" (PeopleTools 8.58: Change Assistant and Update Manager).

---

## Setting Project Options

Set processing options for all project operations in the Project Options dialog box:

### Image: Project options dialog box

This example illustrates the fields and controls on the Project options dialog box. You can find definitions for the fields and controls later on this page.

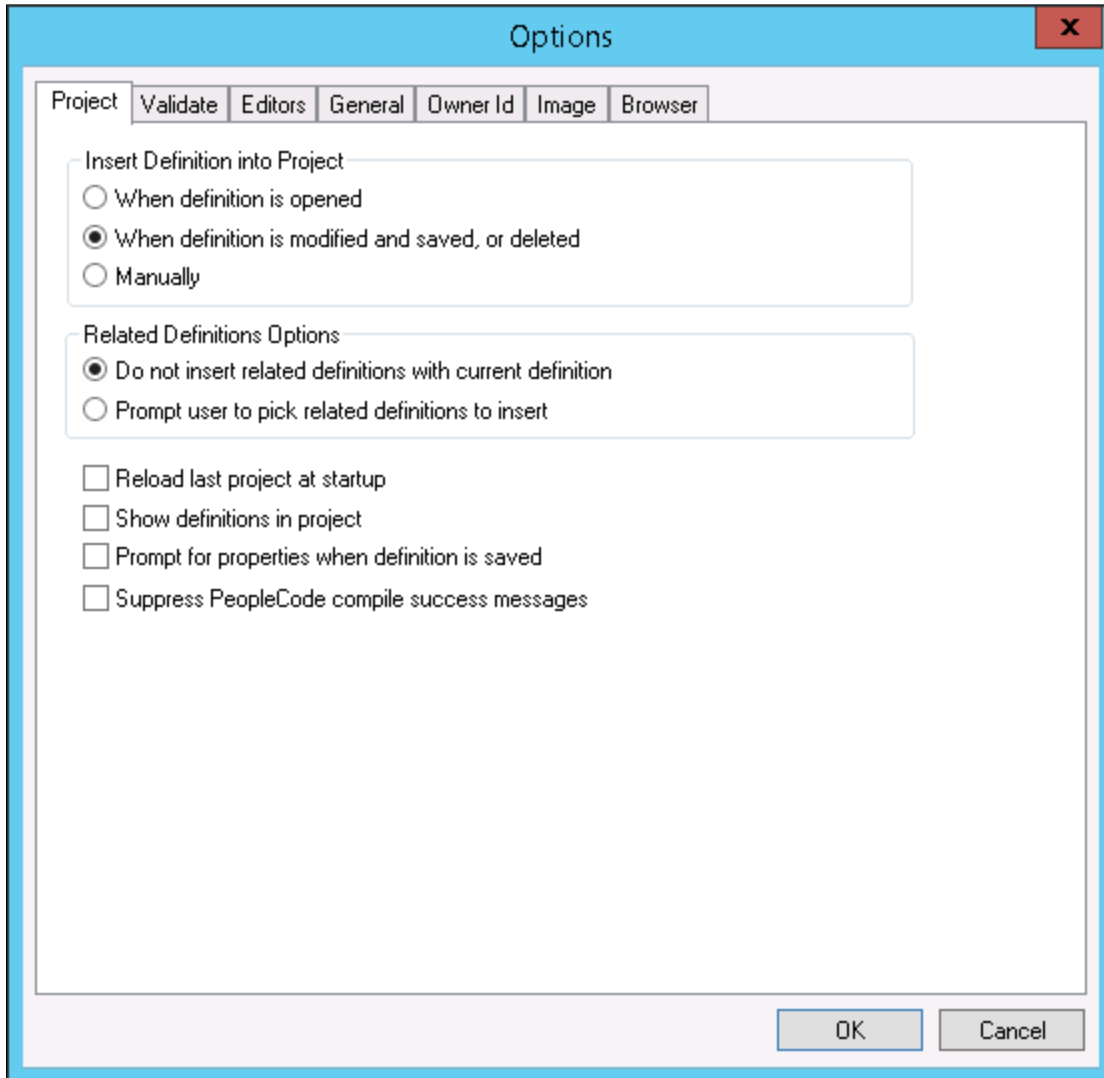

To set project options:

1. Select Tools > Options.

The Options dialog box appears.

2. Select the Project tab in the Options dialog box.

Define when and how definitions are added to the project and how the project appears in the project workspace.

#### **When definition is opened**

Automatically inserts any definition that you open into the current project.

#### **When definition is modified and saved, or deleted**

Automatically inserts any definition that you save or delete into the current project.



<b>Manually</b>	Does not automatically insert any definition into the current project. This value is the default option. Use the Insert menu bar to insert a definition into the project.
<b>Do not insert related definitions with current definition</b>	Does not prompt you to include related definitions. Inserts only the specified definition, not related definitions.
<b>Prompt user to pick related definitions to insert</b>	After you select Insert > Current Definition into Project a dialog box appears, prompting you to pick which related definitions to insert.
<b>Reload last project at startup</b>	When starting PeopleSoft Application Designer, the project that was last opened in the previous session opens automatically.
<b>Show definitions in project</b>	Displays a black mark next to icons for definitions that are explicitly in a project (Development view) to indicate that they are in the project. Attribute definitions, which are not explicitly part of the project, are not marked.
<b>Prompt for properties when definition is saved</b>	Prompts you with a definition properties dialog box before you can save the definition.
<b>Suppress PeopleCode compile success messages</b>	<p>Suppress the messages for successful PeopleCode program compiles and compile warnings displayed on the Validate tab if you are importing a project and have selected the option: Compile PeopleCode after import.</p> <p>Only errors will be displayed if selected.</p> <p>See "Copying Projects" (PeopleTools 8.58: Lifecycle Management Guide).</p>

---

## Validating Projects

Using the Validate Project option ensures the integrity of a project, checking that the definitions in a project are valid and present. While it is good practice to perform validation on a regular basis, it is especially important to do before and after migrating a project to other databases during development, upgrades, or updates. Results of the validation check appear in the Validate tab in the output window.

To validate a project:

1. Close all active component definitions in the definition workspace.

Otherwise, the validation occurs in the component, rather than the project.

2. Select Tools > Options.
3. Select the Validate tab in the Options dialog box.
4. Select Validate project integrity.

5. Click OK.
6. Select Tools > Validate Project.
7. Review the results in the Validate tab in the output window.

### Image: Validate Project Log File

This example illustrates the results displayed in the log file generated by the validate project option.

```

2048239022_RPT_IT.log - Notepad
File Edit Format View Help
Validate Project Integrity
03/28/14 06:55:29
Project Name - IT
PeopleTools Release 8.54

Begin validate Project Integrity
Delete Invalid Definitions - No
Invalid Records: ASSET_ACQ_SKU

Invalid Pages: UT_IT_HRDWR_CACHE
Invalid Pages: UT_IT_PRGS_STG
Invalid Components: IT_FIN_STAT_RUN.GBL
Invalid Components: IT_SEARCH_TEST_01.GBL
Invalid Components: IT_SEARCH_TEST_02.GBL
Invalid Components: IT_SFTWR_PEND_OLD.GBL
Invalid Components: IT_SFTWR_RENEW_OLD.GBL
Invalid Components: UT_IT_DISCO.GBL
Invalid Components: UT_IT_PRGS_STG.GBL
Invalid Record PeopleCode: IT_ASSET_LOG.BUSINESS_UNIT.SearchInit: FAM
Invalid Record PeopleCode: IT_ASSET_LOG.BUSINESS_UNIT.SearchSave: FAM
Invalid Record PeopleCode: IT_FIN_STAT_RUN.ASOFDATE.SaveEdit:
Invalid Record PeopleCode: IT_FIN_STAT_RUN.OPRID.FieldDefault:
Invalid Record PeopleCode: IT_FIN_STAT_RUN.OPRID.RowInit:
Invalid Record PeopleCode: TEST_ASSET_GRP.RUN_PB.FieldChange:
Invalid Record PeopleCode: UT_PAGES_WK0.GUID.FieldFormula:
Invalid SQL: AM_LEASE_LIB300000 Step01 S.1
Invalid SQL: AM_LEASE_LIB300000 Step03 D.1
Invalid SQL: AM_LEASE_LIBLEASE Step02 D.1
Invalid SQL: ASSET_ACQ_SKU.2
Invalid SQL: IT_AGING_LIB800000 Step01 S.1
Invalid SQL: IT_DEPT_BU.2

```

---

**Note:** For PeopleCode, if the associated definition has an owner ID specified, the system displays the owner ID at the end of the entry, as in *:FAM*.

---

**Note:** The Validate WSRP compliance option applies to projects that contain PeopleSoft content intended for WSRP production.

---

See "Validating WSRP Compliance" (PeopleTools 8.58: Portal Technology).

---

## Setting System IDs

System ID functionality simplifies system ID maintenance for developers, used mainly for deprecated mobile application technology.

You can set the system ID for an overall project or for the current record definition in the project workspace.

To set system IDs for a project:

1. Open the project.
2. Select Build > Set System IDs for Project

The Build Progress dialog box appears, displaying the progress of the command for the number of objects affected by this command.

### **Related Links**

"Setting Data Field Length Checking" (PeopleTools 8.58: Global Technology)



## Chapter 4

# Creating Field Definitions

---

## Understanding Field Definitions

Fields are the basic building blocks in your PeopleSoft system; in database terms, they represent columns in a table or view. Field definitions are stand-alone development definitions, defined in PeopleSoft Application Designer, and can be shared across multiple record definitions. Changes to field properties affect all records that include that field.

Each field definition includes attributes, such as data type, field name, long name, short name, field length, and various formatting values.

### Fields in Record Definitions

By grouping fields that share a common theme, you build a record definition. For example, a department table (record definition) might include a department ID field, department name field, location field, and so on.

For each field definition that you add to a record definition, you define additional characteristics, called record field properties, that are specific to the way the field is used in that particular record. Record field properties are *not* shared with other records in which the field is used.

---

## Creating New Field Definitions

This section lists prerequisites and discusses how to:

- Create a new field definition.
- Specify attributes for a new field definition.
- Specify Character field attributes.
- Specify Long Character field attributes.
- Specify Number field attributes.
- Specify Date field attributes.
- Specify Time field attributes.
- Specify Datetime field attributes.
- Specify Image field attributes.
- Specify ImageReference field attributes.

- Work with additional Oracle data type mappings.
- Work with additional Microsoft SQL Server 2005 data type mappings

## Prerequisite

You should be familiar with the general terminology and functions of PeopleSoft Application Designer.

## Creating a New Field Definition

To create a new field definition:

1. Click the New button on the PeopleSoft Application Designer toolbar.

The New dialog box appears.

2. Select Field.
3. Click OK.

A new character field opens in the definition workspace area.

4. Select one of the following field types from the Field Type drop-down list box.

---

**Note:** Make sure you name your fields according to accepted naming conventions.

---

See [Saving Definitions](#).

<b><i>Character (Char)</i></b>	Alphanumeric field of fixed length.
<b><i>Long Character (Long)</i></b>	Alphanumeric field of variable length used for textual entries, such as comments or descriptions.
<b><i>Number (Nbr)</i></b>	Positive numeric field of fixed length for which decimals are allowed.
<b><i>Signed Number (Sign)</i></b>	Positive or negative numeric field of fixed length for which decimals are allowed.
<b><i>Date (Date)</i></b>	Date field of constant length. The system edits dates and prohibits incorrect ones, such as day 42 or month 20. Date fields always store a four-digit year.
<b><i>Time (Time)</i></b>	Time field of a constant length. Built-in edits prohibit impossible times, such as hour 26, minute 70, or second 94.
<b><i>Datetime (DtTm)</i></b>	Date and time field of constant length. Built-in edits prohibit impossible dates and times, as defined in the individual date and time fields. Datetime fields always store a four-digit year.
<b><i>Image (Img)</i></b>	Image field to store images in a user-defined format, such as JPG or GIF.

***ImageReference (Iref)***

Field in which to change an image dynamically at runtime using PeopleCode.

***Attachment (Att)***

Field that maps to a BLOB database type to hold the contents of a file attachment. However, you should use the existing field, FILE\_DATA, if you need a BLOB column. For attachments, use the subrecord ATTACH\_DETAIL, which contains FILE\_DATA.

After you select a field type, a field definition window appears in the definition workspace. Use the field definition window to specify attributes to complete your new field definition.

## Specifying Attributes for a New Field Definition

Access the field definition window for a new field definition.

All field types share the following property settings.

---

**Note:** Multiple views of this dialog box are available, depending on which field type you select. Fields that are common to all views are documented first.

---

**Label ID**

Enter a unique identifier for the field that is less than 18 characters, without spaces, and in uppercase. Make this the default label by selecting the Def check box in the last column; otherwise, the first label is the default. You can set only one field label as the default.

---

**Note:** You can specify multiple labels for one field and change them at runtime using PeopleCode. Label IDs must contain alphanumeric characters only and cannot consist entirely of spaces.

---

See [Using Multiple Labels](#).

**Long Name**

Enter up to 30 characters. The name that you enter here appears as the RFT Long option for a page field. This label is also used for the tool tip, or hover text, for links at runtime if it is different from the assigned display value of the link.

---

**Note:** Do not use the \ (backslash) character in the long name of cubes and members. Unexpected behavior might occur.

---

**Short Name**

Enter up to 15 characters as an alternate name to use on pages and reports if you have insufficient space to display the long name. If you leave this field blank, the system automatically copies the first 15 characters of the long name into this field. The name that you enter here appears as the RFT Short option for a page field.

---

**Note:** If you name the field the same as the default label ID, you can identify it more easily when using PeopleCode.

---

---

**Note:** Do not use the \ (backslash) character in the short name of cubes and members. Unexpected behavior might occur.

---

**Def (default)**

When you enter the first label ID, the system automatically selects the Def check box. The system uses this default field if you have multiple labels. You can have only one default field.

**Not Used**

This check box is always read-only in the field definition properties dialog box. You can change its value using PeopleCode, causing the field to be:

- Skipped as part of the unique index.
- Exposed to PeopleCode for read and write operations.
- Ignored in Query.
- Ignored in PS/nVision.
- Unavailable to users in search pages or list boxes if it is a search key or list box item.

See "SetDBFieldNotUsed" (PeopleTools 8.58: PeopleCode Language Reference).

**Chart Field**

This field is read-only in the field definition properties dialog box. It is used for character fields and by financial applications to specify a usage pattern. You can change the value using PeopleCode.

**Encrypt**

Select this option to encrypt the field using Oracle Transparent Data Encryption (TDE).

---

**Note:** The Encrypt option is disabled for field types that do not support encryption, for database platforms other than Oracle, as well as for Oracle database versions that do not support TDE.

---

See "Encrypting Fields" (PeopleTools 8.58: Data Management).

## Specifying Character Field Attributes

Use character fields for names, codes, and any fields with letter values. Also use them for numbers for which you want to contain formatting attributes and the data itself. Examples of such fields are those in which you enter telephone numbers and zip or postal codes. You cannot use character fields for calculations. You can enter decimal numbers in character fields, but you cannot use them mathematically until you convert them back to numeric fields.

You can specify character field attributes at design time, and you can access most of them at runtime with PeopleCode.

**Field Length**

Enter a whole number between 1 and 254 for the length of the field.



## Format Type

Select one of the following values:

- *Uppercase*: Converts the field value to uppercase and signifies that no other formatting options apply to this field. Use this option for code values, such as department ID, for which it does not matter whether the user enters the value in uppercase or lowercase. *Uppercase* is the default format.
- *Mixedcase*: Stores uppercase and lowercase characters as entered. Use this option for fields that contain textual data, such as a department or company division name. For example, *Accounting - Receivables* is more readable than *ACCOUNTING - RECEIVABLES*.
- *Numbers Only*: Forces entries to be numeric, which is useful for enforcing numeric values without redefining the field as a number field. This option automatically populates fields with leading zeros. For example, if the user enters *1* in a three-digit field, the system changes this value to *001*.
- *SSN*: Formats the entry in U.S. Social Security Number format (999-99-9999). Define the field length as 9, even though the display length is 11. The system automatically adds dashes when formatting the field for display, but the number is stored in the database without the dashes.
- *SIN*: Formats the entry in Canadian Social Insurance Number format (999-999-999) and performs the standard check-digit verification for SIN. Define the field length as 9, even though the display length is 11. The system automatically adds dashes when formatting the field for display, but the number is stored in the database without the dashes.
- *Raw Binary*: Allows character fields containing embedded null values, such as encrypted values.
- *Name*: Indicates that the field entry uses the PeopleSoft standard name convention:

```
[Lastname] [Suffix],[Prefix] [Firstname] [Middle name/Initial]
```

The entry can contain alphanumeric characters, spaces, periods, hyphens, and apostrophes. Uppercase and lowercase characters are preserved as entered, that is, mixed case formatting is used automatically.

---

**Important!** While a space is a valid character, it is not allowed immediately after the comma separating the last name from the first name.

---

Valid entries might include:

- O'Brien, Michael
- Jones IV, James
- Phillips MD, Deanna Lynn
- Reynolds Jr., Dr. John Q
- Phipps-Scott, Ms. Adrienne
- Knauff, Günter

---

**Note:** For names that include Chinese, Japanese, or Korean (CJK) ideographic characters, different standard name conventions apply. See "Using CJK Ideographic Characters in Name Character Fields" (PeopleTools 8.58: Global Technology).

---

- *Postal Code North America:* Formats the entry to U.S. zip code format or Canadian postal code format. Canadian postal codes are edited to ensure that alphabetical and numeric characters are entered in the correct positions.

The following entry formats apply. Stored formats appear in parentheses following the entry format:

- 99999 (99999)
  - 99999-9999 (99999-9999)
  - 999999999 (99999-9999)
  - A9A9A9 (A9A 9A9)
  - A9A 9A9 (A9A 9A9)
- *Postal Code International:* Allows the entry of international postal codes. You must enter at least 7 digits. If you enter 9 digits, the system assumes that the value is a U.S. zip code; if the entry is in A9A9A9 format, the system assumes that the value is a Canadian postal code. The system formats the value accordingly. For all other entries, no formatting is applied.
  - *Phone Num North America (phone number North America):* Formats the entry in North American telephone number format.

The following entry formats apply. Stored formats appear in parentheses following the entry format:

- 9999999 (999-9999)
- 999-9999 (999-9999)

- 9999999999 (999/999-9999)
- 999/999-9999 (999/999-9999)
- *Phone Number International*: Allows the entry of international telephone numbers. If you enter 7 or 10 digits (and no other characters), the system assumes that the value is a North American phone number and formats it accordingly. For all other entries, no formatting is applied.
- *Custom*: If you select this value, the Family Name and Display Name fields become available for entry. These selections enable you to apply additional formatting attributes that affect how the field appears on a page.

## Specifying Long Character Field Attributes

Depending on your database environment, the maximum length of a long character field ranges from several thousand characters to 32,767 characters (64,000 bytes). Using a long character field instead of a regular character field enables more information to be added, and the user can insert a tab at runtime by pressing Ctrl+Tab.

The maximum Large Object (LOB) size allowed by PeopleTools is 50 MB.

---

**Note:** For Db2 for z/OS, the maximum Large Object (LOB) size is approximately 32700 KB, depending on the page size (as determined by the Buffer Pool) and the internal Db2 lengths of the rest of the columns in the row.

---

### Maximum Length

To control the length of a long character field, enter the maximum number of bytes that you want the system to write to this field. If you do not specify a maximum length, or specify 0 (zero), you can enter an unlimited number of characters, depending on the capacity of your database system.

When working with fields, be aware that your chosen database system limits the amount of data contained in a field. For Oracle the field size is truncated to 1333 characters. Consider this limitation when choosing to use fields of a Long Character data type.

*For Oracle:* If the maximum length of a long field is less than 4001 bytes, the field can be stored more efficiently as a VARCHAR2(4000). To support the PeopleSoft Unicode implementation on the Oracle platform, we defined long columns with a specified length of 1330 or less as VARCHAR2 columns. If the length specified was greater than 1330, then the column was generated as a long VARCHAR or long raw, depending on the setting of the Raw Binary check box. This setting allows for the maximum possible usage of a tripled VARCHAR2 character length for Unicode-defined databases.

*For Db2 for z/OS:* Character fields defined with a length specification greater than 254 are automatically defined as LONG VARCHAR in EBCDIC databases and LONG VARGRAPHIC in Unicode databases.

---

**Note:** For all supported database platforms, it is more efficient to define a reasonable length for long character fields than to simply use 0. Specifying 0 forces PeopleTools to define LOBs automatically for those databases for which LOBs are supported. Due to potential performance implications, LOBs should not be used indiscriminately.

---

**Raw Binary**

Select to store data that is not converted when moving data between different systems. Raw binary is intended for binary data and byte strings. For example, raw binary can store graphics, sound, documents, and arrays of binary data.

## Specifying Number Field Attributes

When you create a new field, two field types are available for numbers:

- Number fields
- Signed number fields

Both field types are fixed in field length and allow the entry of positive numbers. Only signed numbers, however, allow the entry of negative numbers. Otherwise, both number field types are the same.

Unlike character fields, a number field can contain decimals but does not contain special formatting, such as the formatting for telephone numbers. Use number fields for calculations. If you use number fields for codes, you sacrifice flexibility to change your coding structure to alphanumeric in the future.

**Image: Number Field type**

This example illustrates the fields and controls on the Number Field type. You can find definitions for the fields and controls later on this page.

Field Type:	Number	<input type="checkbox"/> Signed	
Integer Positions:	3	Decimal Positions: 0	
<b>Field Labels</b>			
Label ID	Long Name	Short Name	Def
1			<input type="checkbox"/>

**Integer Positions**

Specify the number of integer positions to the left of the decimal. If the number contains only decimal positions, leave this field blank.

**Decimal Positions**

Specify the number of decimal positions to the right of the decimal. If a number contains only integer positions, leave this

field blank. In calculations, the system rounds up the result to the number of decimal positions defined here.

---

**Note:** Number fields cannot exceed 31 positions. Therefore, the sum of integer and decimal positions cannot exceed 31. The field length notation differs between PeopleSoft Application Designer and SQL. If you specify a field length of 8 integer positions and 3 decimal positions in PeopleSoft Application Designer, SQL processes that as a length notation of 11.3.

---

SQL describes field length in terms of *precision* and *scale*. Precision is the total number of integer and decimal positions. Scale is the number of decimal positions. Thus, 11.3 means 8 integer positions and 3 decimal positions; 11.0 means 11 integer positions and 0 decimal positions.

When you enter 0 in the Decimal Positions field and enter 5 or 10 in the Integer Positions field, the RawBinary format option appears. The RawBinary format converts a number field value to a full-length 16- or 32-bit integer. See the example in the table that follows.

### Signed

Select this check box for a field that is used for arithmetic calculations that might contain a negative value.

This table shows how the integer position affects the RawBinary storage format:

<i>Integer Position</i>	<i>Maximum Value</i>	<i>Number Stored As</i>
5	65535	16-bit integer
10	4294967295	32-bit integer

## Specifying Date Field Attributes

Date fields contain calendar dates. A date field has a field length of 10 and is maintained by the system. The default format of a date field is defined by the database and can be overridden by your browser settings.

### Default to 2000 if year less than or equal to

Specify the last two digits of a year, which is typically what users enter in a date field. If you enter 50, the default century becomes 2000 when someone enters 0 through 50 as the year in a date field. If someone enters a number between 51 and 99 in a date field, the default century becomes 1900. The default value is 50.

---

**Note:** When working with date and time fields on pages and search pages, carefully consider search criteria. Assume the date, time, and time zone fields are separate with the condition that the time is time zone-controlled by the time zone field and the time is associated with the date field. In this case, you need to provide date, time and time zone on the search page if any one of those search criteria is required.

---

## Specifying Time Field Attributes

Time fields are fixed-length fields (15 positions, format of HH:MI:SS.999999) that contain the time of day. The maximum time precision varies, depending on your database.

### Time Formatting

Specify the formatting for this field. HH represents hours, MI represents minutes, SS represents seconds, and 999999 represents microseconds.

---

**Note:** You can use %CLIENTDATE as the default constant for the Time field. %CLIENTDATE adjusts the date as appropriate to the time zone of the browser.

---

### Related Links

"%ClientDate" (PeopleTools 8.58: PeopleCode Language Reference)

"%Date" (PeopleTools 8.58: PeopleCode Language Reference)

## Specifying Datetime Field Attributes

The Datetime field is a fixed-length field (26 positions, format of YYYY-MM-DD-HH-MI-SS.999999) that holds dates and times. The maximum date and time precision depends on your database.

---

**Note:** You can use %CLIENTDATE as the default constant for the Datetime field. %CLIENTDATE adjusts the date as appropriate to the time zone of the browser.

---

### Related Links

"%ClientDate" (PeopleTools 8.58: PeopleCode Language Reference)

"%Date" (PeopleTools 8.58: PeopleCode Language Reference)

## Specifying Image Field Attributes

Use Image fields to store application data that takes the form of images. Image fields are functionally no different from any other type of field. Just as end-users employ character fields to store names and addresses, they can employ image fields to keep track of all types of digital pictures. This field enables you to store pictures of assets, company logos (in SQL tables), or scanned images of employees (as part of their personal data rows).

### Maximum Length

Specify the maximum number of bytes available to store an image. If you do not specify a maximum length, the maximum length is determined by your database platform. If a user attempts to cut and paste an image that is larger than the maximum length or database capacity, an error message appears.

The following databases apply these maximums:

- Oracle (2 gigabytes).
- Db2 for z/OS: Approximately 32700 kilobytes, depending on the page size, (as determined by the Buffer Pool) and the internal Db2 lengths of the rest of the columns in the row.

- Microsoft SQL Server (2 gigabytes).

### Image Format

Select an image format. The format specified on the field definition restricts valid images to that type only.

Image fields support BMP, CUT, DIB, GIF, EPS, JPG, PCT, PCX, PNG, RLE, TGA, and SVG formats. At runtime using the PeopleCode "InsertImage" (PeopleTools 8.58: PeopleCode Language Reference) function, users can upload BMP, DIB, JPG, PNG, and SVG images to the database.

---

**Note:** For the record that contains an image field, the record must have at least one key if the image field is to be displayed on a page. This is requirement so that unique image file names can be generated.

---

**Note:** When using images of the SVG format, be sure that the XML declaration of the SVG image is of an expected format. For example:

```
<?xml version="1.0" encoding="utf-8"?>
```

or,

```
<?xml version="1.0" standalone="no"?>
```

If the XML declaration is not formatted correctly, this can result in errors, such as errors when creating the definition, not being able to view height and width in Application Designer, not being able to view the image at runtime, and so on.

---

## Specifying ImageReference Field Attributes

Use the ImageReference field to store static images that you can change at runtime using PeopleCode. By associating image definitions with an ImageReference field on a page, you can display images dynamically. For example, to have different images appear on an employee profile depending on the status of the employee's current review, use the ImageReference field to reference the current review field and display the appropriate image.

## Working With Additional Oracle Data Type Mappings

If your site has upgraded to a PeopleSoft 9.x application and performed the appropriate conversion process during the application upgrade, different data type mappings exist between PeopleSoft field types and the underlying Oracle system.

See The upgrade documentation and release notes for your release for information about the conversion process.

The following table describes how the PeopleSoft field types map to the underlying Oracle data types:

<b>PeopleSoft Field Type</b>	<b>Pre-Conversion Oracle Data Type Mapping</b>	<b>Post-Conversion Oracle Data Type Mapping</b>
Character	ANSI: VARCHAR2( <i>n</i> ) Unicode: VARCHAR2( <i>n</i> *3)	ANSI: VARCHAR2( <i>n</i> ) Unicode: VARCHAR2( <i>n</i> )  <b>Note:</b> For Unicode the VARCHAR2 column is interpreted as the number of Unicode characters due to init. ora parameter NLS_LENGTH_SEMANTICS being set to "CHAR".
Long Character	If $1 \leq n \leq 2000$ ANSI: VARCHAR2  Unicode: VARCHAR2( <i>n</i> *3) CHECK (Length <field name> ≤ <i>n</i> )  If $n = 0$ or $n > 2000$ ANSI: LONG VARCHAR  Unicode :LONG VARCHAR	ANSI: VARCHAR2( <i>n</i> ) when $1 \leq n \leq 4000$  CLOB when $n = 0$ , or $n > 1333$  Unicode: VARCHAR2 ( <i>n</i> ) when $1 \leq n \leq 1333$  CLOB when $n = 0$ , or $n > 1333$  <b>Note:</b> For Unicode the VARCHAR2 column is interpreted as the number of Unicode characters due to init. ora parameter NLS_LENGTH_SEMANTICS being set to "CHAR".
Long Character with Raw Binary attribute	ANSI: LONG RAW Unicode: LONG RAW	ANSI: BLOB Unicode: BLOB
Image	ANSI: LONG RAW Unicode: LONG RAW	ANSI: BLOB Unicode: BLOB
Attachment	ANSI: LONG RAW Unicode: LONG RAW	ANSI: BLOB Unicode: BLOB
Date	DATE	DATE
Datetime	DATE	TIMESTAMP
Time	DATE	TIMESTAMP

## Working With Additional Microsoft SQL Server 2005 Data Type Mappings

If your site has upgraded to a PeopleSoft 9.x application and performed the appropriate conversion process during the application upgrade, different data type mappings exist between PeopleSoft field types and the underlying Microsoft SQL Server 2005 system.

See The upgrade documentation and release notes for your release for information about the conversion process.



The following table describes how the PeopleSoft field types map to the underlying Microsoft SQL Server data types:

<b><i>PeopleSoft Field Type</i></b>	<b><i>Pre-Conversion Microsoft SQL Server Data Type Mapping</i></b>	<b><i>Post-Conversion Microsoft SQL Server Data Type Mapping</i></b>
Character	ANSI: CHAR Unicode: NCHAR	ANSI: VARCHAR( <i>n</i> ) Unicode: NVARCHAR( <i>n</i> )
Long Character	ANSI: TEXT Unicode: NTEXT	ANSI: VARCHAR(MAX) Unicode: NVARCHAR(MAX)
Long Character with Raw Binary Image Attachment	IMAGE (ANSI and Unicode)	VARBINARY(MAX) (ANSI and Unicode)

---

## Using Multiple Labels

This section provides an overview of multiple labels and discusses how to:

- Add a new label.
- Delete a label.
- Select record field labels.

## Understanding Multiple Labels

You can define multiple label pairs for any field. By adding multiple labels to a field definition, you can expand its usability and create a more intuitive user experience at the same time.

For example, here you see the Date field with multiple labels.

**Image: A date field showing multiple field labels**

This example illustrates the fields and controls on the A date field showing multiple field labels. You can find definitions for the fields and controls later on this page.

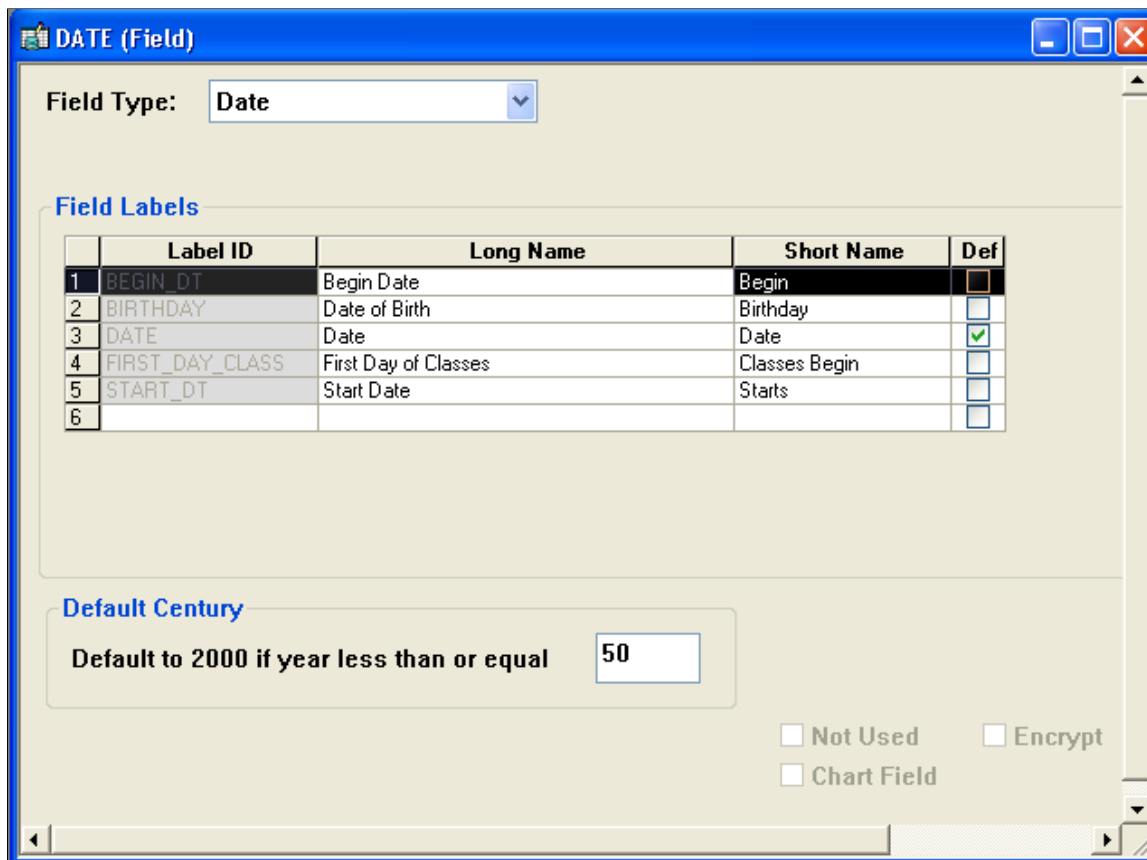

You could use this field in a student registration application and select the First Day of Classes label. You could also use this field in an application that tracks employee personal information, but select the Date of Birth label. In each case, you use the same field definition but you vary the label to reflect what the user sees and should understand about its context.

The underlying data structure for the field does not change when you change its label. At the database level, the column name in the table is DATE. You are merely manipulating the label to accommodate the context in which you use the field.

The system displays multiple labels in alphabetical order and sorted by label ID. You can sort the labels in a field by double-clicking the column header. The sorting is not saved, but it is helpful for quickly viewing the labels.

**Adding a New Label**

Open the field definition in the definition workspace.

To add a new label, enter the label ID, long name, and short name in the last row. Each label can have related language labels. After defining the multiple labels, you can select appropriate labels when designing a record or page. You also can specify different labels in PeopleCode. To add a line feed for Long Name and Short Name, enter \n (backslash and the letter n). For example, *work \n month* adds a line feed between the words *work* and *month*.

When you create multiple labels, the first label ID is the default label . You can change the default label by selecting the Def check box for a different row. Only one label can be the default.

---

**Note:** Each label ID must be unique so that each field definition label can be identified separately, and it must be entered using uppercase letters with no spaces.

---

## Deleting a Label

Open the field definition in the definition workspace.

To delete a label, right-click a field label row and select Delete Label from the pop-up menu. You cannot delete labels that are currently in use. To determine where the label is used, select the label and select Find Definition Reference from the pop-up menu. The results appear in the Find Definition Reference output window.

## Selecting Record Field Labels

Access the Record Field Properties dialog box.

**Image: Record Field Properties dialog box**

This example illustrates the fields and controls on the Record Field Properties dialog box. You can find definitions for the fields and controls later on this page.

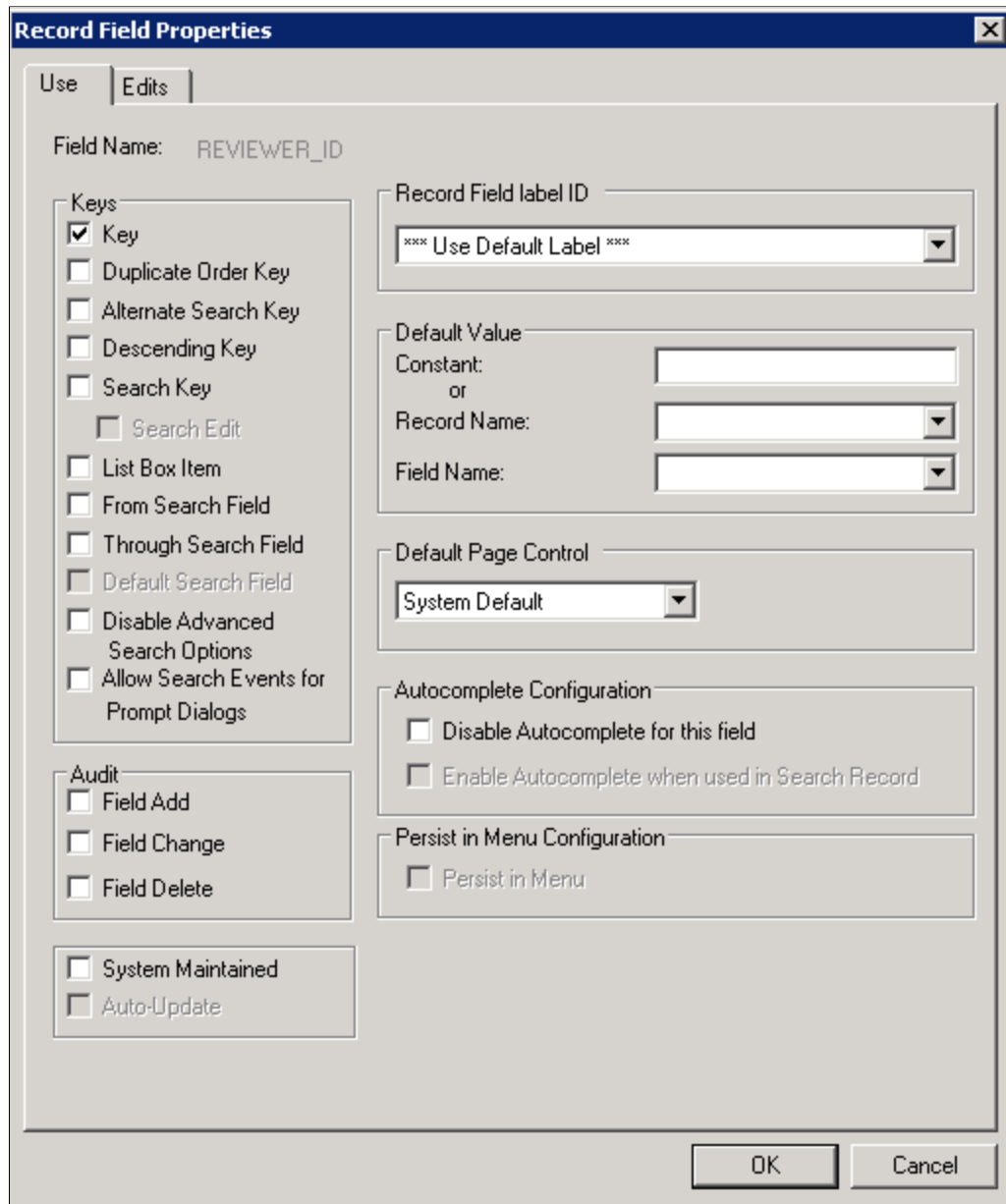

For the record definition, the Record Field label ID drop-down list box is available on the Use tab of the Record Field Properties dialog box. The drop-down list box displays the label ID, short name, and long name that you set in the field definition. The default selection is *\*\*\* Use Default Label \*\*\**. The record field label changes automatically whenever you change the default label in the field definition.

---

## Opening an Existing Field Definition

You can open a field definition in several ways:

- Select File > Open from the menu.

From this dialog box, you can view all available fields in the database. You can open all fields of a certain type or from a specific project, or you can open a specific field or set of fields.

- Clone an existing definition.

To create a field definition with attributes similar to an existing one:

1. Open an existing field definition.
2. Select File > Save As.
3. Enter a new name and click the OK button.

- Open a field from the project workspace.

Double-click a field from the project workspace to open a field definition window in the definition workspace.

- Open a field from the record.

Open an existing record definition. When the record definition window opens, you can:

1. Select a field.
2. Right-click the field.
3. Select View Definition from the pop-up menu.

---

## Viewing Field Properties

You can view field properties in several ways:

- While in the field definition workspace, click the Properties button.
- Select File > Definition Properties.
- While in a record definition:
  1. Select the field.
  2. Right-click the field name.
  3. Select View Field Properties from the pop-up menu.

The General tab in the Field Properties dialog box provides a place for you to enter comments documenting the purpose of the field definition. The Owner ID drop-down list box enables you to select a valid owner, as in application project or role. The Last Updated group box contains information—date, time, and user ID—about the last time that the field definition was modified.

The Translate Values tab is available only for character fields.

## Related Links

[Using the Translate Table](#)

---

# Changing Field Definitions

This section provides an overview of the effects of changing field definitions and discusses how to:

- Change field types.
- Rename field definitions.
- Delete field definitions.
- Print field definitions.

## Understanding the Effects of Changing Field Definitions

When you develop new record definitions or modify existing ones, you might need to change characteristics or attributes for a field. If you change attributes in a field definition, the change affects every occurrence of the field in every record definition. So, before you change basic attributes in a field definition, consider how it affects all of the record definitions in which the field occurs. If the change is not appropriate for every occurrence of the field, consider defining a new field instead.

If a change is still needed, you should determine the extent of the change by finding out how many records are affected. Do this by using the Find Definition References tool. Open the field definition and select Edit > Find Definition References or right-click and select the option from the pop-up menu. If you are in a record definition window, another method is to select the field, right-click the field name, and select Find Definition References - Field from the pop-up menu.

The Find Definition References tab in the Output window displays a list of all projects, record definitions, page definitions, messages, channels, file layouts, and PeopleCode programs in which the field is used. Double-click a line of output to open the corresponding definition in the definition workspace.

---

**Note:** Changing the name or length of a field definition requires that you modify the underlying SQL table. Do this either by running the build process and specifying Create Tables or Alter Tables, or by carrying out an action issued by your system administrator. For example, if you change the length of a field definition and 30 record definitions contain the same field name, then you must create or alter 30 records.

---

## Changing Field Types

Change a field type by opening a field and selecting another field type from the drop-down list box. However, this feature is intended as a design-time change—that is, before your tables are created in the database. While you can convert some field types, the results vary depending on your database platform.

---

**Note:** If you change a field from one type to another, you must rebuild all records containing that field by running the Alter process. Use Find Definition References to find all instances of the changed field.

---

See [Altering Tables](#).

## Renaming Field Definitions

You can use either the Rename Definition dialog box or the Open Definition dialog box to rename a field definition.

### Using the Rename Definition Dialog Box

To rename a field definition from the Rename Definition dialog box:

1. Select File > Rename to open the Rename Definition dialog box.
2. Select Field as the definition type.
3. Enter the name of the field.

If you are not sure of the name or the correct spelling, use the search criteria fields to locate the field to rename. The list displays field names that match your search criteria.

4. To rename a field in the list, select the field and click Rename or double-click the field.

The field name becomes available for entry, and you can enter a new name.

5. When you finish typing the new name, press enter or click the Rename button.

The Rename Field dialog box appears. Select the records in which you want the field to be renamed. The De-select All button toggles to Select All.

6. Click OK.

### Using the Open Definition Dialog Box

To rename a field definition from the Open Definition dialog box:

1. Select File > Open to access the Open Definition dialog box.

This dialog box enables you to set up search criteria for locating field names.

2. Select Field as the definition type.

If you have additional information, use the Name field. You can further narrow your search criteria by selecting a field type or the name of the project that contains the field to delete.

3. Click the Open button or press enter when you have completed your search criteria.

4. You can rename a field in the Open Definition dialog box by selecting the field, right-clicking the field name, and selecting *Rename*.

You can also select the field name and click it a second time. The field name becomes available for entry and you can enter a new name.

5. When you finish typing the new name, press enter or click the Rename button.

### Results of Renaming Field Definitions

When you rename a field, the system automatically changes all occurrences of it, including data in tables with columns named FIELDNAME where the data matches the field being renamed.

The only references that are *not* renamed are the text portions of SQL functions, such as SQLExec and ScrollSelect. If you already used SQL Create to create the underlying tables for the record definitions that contain the field that you renamed, you must recreate or alter those tables. If the tables contain data that you want to preserve, use the SQL Alter function to rename the database table fields.

## Deleting Field Definitions

You can use either the Delete Definition dialog box or the Open Definition dialog box to delete a field definition.

### Using the Delete Definition Dialog Box

To delete field definitions by using the Delete Definition dialog box:

1. Select File > Delete to open the Delete Definition dialog box.  
Set up search criteria for locating field names.
2. Select *Field* as the definition type.
3. If you have additional information, use the Name field.
4. Select a field type or the name of the project that contains the field that you want to delete.  
This selection further narrows your search criteria.
5. When your search results appear in the output window, delete the field definition by selecting the field and clicking the Delete button or double-clicking the field name.

---

**Note:** You cannot delete a field that is currently used in any records. Before you delete a field definition, you must first remove it from records in which it appears.

---

### Using the Open Definition Dialog Box

To delete field definitions by using the Open Definition dialog box:

1. Select File > Open to access the Open Definition dialog box.  
This dialog box enables you to set up search criteria for locating field names.
2. Select *Field* as the definition type.
3. If you have additional information, enter it in the Name field.
4. You can further narrow your search criteria by selecting a field type or the name of the project that contains the field that you want to delete.
5. When you have completed your search criteria, click Open or press enter.
6. Right-click the field that you want to delete from the list of field names displayed.
7. Select Delete from the pop-up menu.



## Printing Field Definitions

If you plan to make changes to your field definitions, you should view your field definition before you proceed. You can view it on your screen or print it to a one-page report that combines information from several resources. This method can also serve as a paper audit trail to document your database.

To print a field definition, select File > Print from the field definition window (or click the Print button in the toolbar) to open the Print dialog box, where you specify printing options. You can also print field definitions from the Open Definition dialog box. On the list resulting from your search, right-click the name of the field definition that you want to print, and select Print from the pop-up menu to view your printing options.

---

## Setting Custom Field Formats

This section provides overviews of custom field formats and format notation and discusses how to:

- Change format families.
- Edit formats.
- Use family options.
- Test formats.

## Understanding Custom Field Formats

PeopleTools has formatting provisions at both the field and page levels. The field format specifications affect internal values that are stored in the database, and the page formats affect the visual presentation of values.

Several formatting options are available for U.S. Social Security Numbers, Canadian Social Insurance Numbers, postal codes, telephone numbers, and various currencies, dates, and times. Custom field formats extend these formatting provisions to support the same types of data in other countries. They also support other types of formatted information, such as bank codes, credit card numbers, part numbers, or serial numbers.

## Understanding Format Notation

Stored and display formats are defined by strings that contain *lexical*, *literal*, and *meta* characters:

- Lexical characters delimit character expressions and designate interpretation rules.
- Literal characters represent only themselves.
- Meta characters represent a class of characters.

Use the format symbols in the following tables to create the format notation for your own custom field formats:

<b>Meta Symbol</b>	<b>Description</b>
#	<p>Digit placeholder.</p> <p>If the number has more digits to the right of the decimal point than there are # symbols to the right in the format, the system truncates the number to as many decimal places as there are # symbols to the right.</p> <p>If the number has more digits to the left of the decimal point than there are # symbols to the left in the format, the system displays the extra digits.</p> <p>If the number has fewer digits to the right of the decimal point than there are # symbols to the right of the decimal point in the format, the system adds spaces.</p> <p>If the number has fewer digits to the left of the decimal point than # symbols to the left of the decimal point in the format, the system also adds spaces.</p> <p>Example format: ###.##</p> <p>Input: 1234.567 - Matches? Yes - Output: 1234.56</p>
0 (zero)	<p>Digit placeholder.</p> <p>Follows the same rules as for #, except that if the number has fewer digits than there are 0s in the format, the system displays the extra 0s.</p> <p>Example format: 000.00</p> <p>Input: 1.2345 - Matches? Yes - Output: 001.23</p>
(period)	<p>Decimal point.</p> <p>This symbol determines how many digits (0 or #) appear to the right and left of the decimal point.</p> <p>If the format contains only # symbols to the left of this symbol, numbers less than one appear with a decimal point.</p> <p>This symbol has meaning only in conjunction with the # and 0 symbols.</p> <p>Example format: ###.##</p> <p>Input: .12345 - Matches? Yes - Output: .12</p>
9	<p>Required numeric placeholder.</p> <p>If the number does not have the same number of digits as there are 9s, the system displays an error message.</p> <p>Example format: 999</p> <p>Input: 123 - Matches? Yes - Output: 123</p> <p>Input: 12 - Matches? No</p>

<b>Meta Symbol</b>	<b>Description</b>
A	Matches any alphabetic character: <i>A–Z</i> or <i>a–z</i> . Example format: <i>AA</i> Input: <i>Sd</i> - Matches? Yes - Output: <i>Sd</i> Input: <i>4A</i> - Matches? No
Z	Matches any alphabetic or numeric value: <i>A–Z</i> , <i>a–z</i> , or <i>0–9</i> . Example format: <i>ZZ</i> Input: <i>3g</i> - Matches? Yes - Output: <i>3g</i> Input: <i>A3C</i> - Matches? No
@	Matches any character. Example format: <i>@@@</i> Input: <i>1q?</i> - Matches? Yes - Output: <i>1q?</i>

<b>Lexical Symbol</b>	<b>Description</b>
*	Matches zero or more occurrences of this character expression. Example format: <i>a*b</i> Input: <i>b</i> - Matches? Yes - Output: <i>b</i> Input: <i>ab</i> - Matches? Yes - Output: <i>ab</i> Input: <i>aab</i> - Matches? Yes - Output: <i>aab</i>
+	Matches occurrences of this character expression. Example format: <i>a+b</i> Input: <i>b</i> - Matches? No Input: <i>ab</i> - Matches? Yes - Output: <i>ab</i> Input: <i>aab</i> - Matches? Yes - Output: <i>aab</i>
[ ]	Denotes a character expression that matches the input character if the input character is the same as any character in the list enclosed by square brackets.  If the expression matches, the input character appears. The system interprets all characters enclosed in square brackets as literal characters. Example format: <i>[ab]c</i> Input: <i>ac</i> - Matches? Yes - Output: <i>ac</i> Input: <i>bc</i> - Matches? Yes - Output: <i>bc</i>

<b>Lexical Symbol</b>	<b>Description</b>
{ }	<p>Denotes a character expression that matches the input character if the input character matches any character in the list enclosed by curly braces.</p> <p>If the expression matches, the first character in the list (not the input character) is copied to output. All characters enclosed in curly braces are interpreted as literal characters.</p> <p>Example format: {ab}c</p> <p>Input: <i>ac</i> - Matches? Yes - Output: <i>ac</i></p> <p>Input: <i>bc</i> - Matches? Yes - Output: <i>ac</i></p>
?	<p>This expression is optional. It is copied to output only if it appeared in input.</p> <p>Example format: a?b</p> <p>Input: <i>ab</i> - Matches? Yes - Output: <i>ab</i></p> <p>Input: <i>b</i> - Matches? Yes - Output: <i>b</i></p>
!	<p>This expression is optional. It is copied to output regardless of whether or not it is matched.</p> <p>Example format: a!b</p> <p>Input: <i>ab</i> - Matches? Yes - Output: <i>ab</i></p> <p>Input: <i>b</i> - Matches? Yes - Output: <i>ab</i></p>
~	<p>This expression is optional. It is copied to output regardless of whether or not it is matched.</p> <p>Example format: a~b</p> <p>Input: <i>ab</i> - Matches? Yes - Output: <i>b</i></p> <p>Input: <i>b</i> - Matches? Yes - Output: <i>b</i></p>
\	<p>Example format: a\b</p> <p>Input: <i>ab</i> - Matches? No</p> <p>Input: <i>a?b</i> - Matches? Yes - Output: <i>a?b</i></p>
()	<p>Groups expressions.</p> <p>Example format: (abc)!99</p> <p>Input: <i>abc12</i> - Matches? Yes - Output: <i>abc12</i></p> <p>Input: <i>12</i> - Matches? Yes - Output: <i>abc12</i></p>

## Changing Format Families

Custom field formats enable you to create your own format definitions using format notation and apply them to fields. These formats are organized into format families, which can include one or more unique formats.

### Image: Format Families dialog box

This example illustrates the fields and controls on the Format Families dialog box. You can find definitions for the fields and controls later on this page.

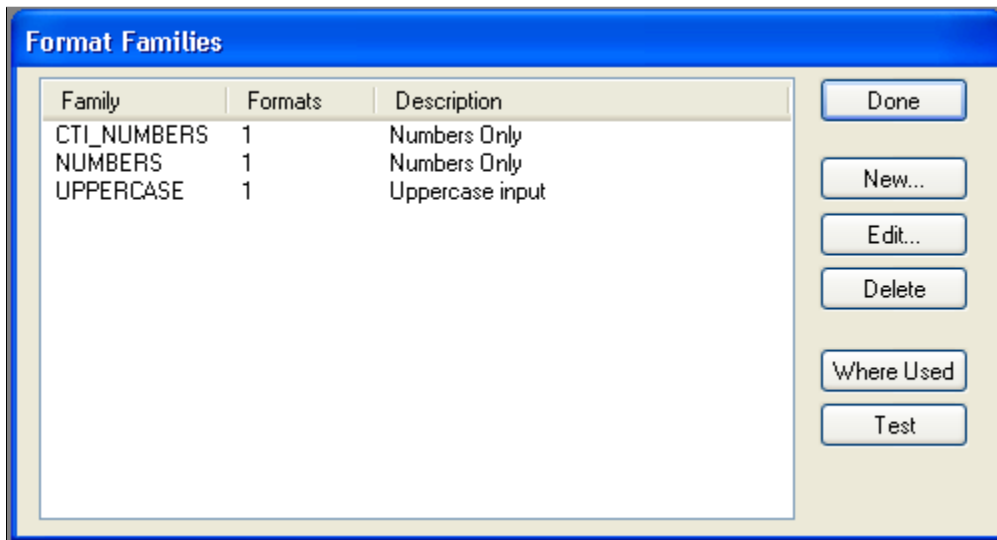

To change format families:

1. Select Tools > Miscellaneous Definitions > Field Formats to access the Format Families dialog box.

The Format Families dialog box lists the defined format families and enables you to edit, delete, or create new families. You can also determine where each family is used in your applications and perform tests.

2. To define a new format family, click the New button.

The New Family dialog box appears.

3. Enter a name for your new format family, and click OK.

The Formats dialog box appears.

4. In the Stored group box, enter a name and format.

This information defines how the format family is to be stored in the database and printed in reports.

5. Enter the format notation that you want to use for storing the data in the Format field.

Because a stored format cannot exist alone, a display format is always required. If you are adding to a family that has existing stored formats, a display name and format pair is optional. PeopleSoft Application Designer automatically places all of the current display formats in the new stored format. The display format default is the stored format that you can redefine later.

6. In the Display group box, enter a name for the format.

This information defines how the format family appears online.

7. Enter the format notation that you want to use for displaying the data in the Format field.
8. Click the Add button to add the new format family, and then click OK when you are finished.

### Max Display Length

Max Display Length (maximum display length) enables you to override the default length that PeopleSoft Application Designer uses to determine the length of the edit field in custom format. This setting is useful when the displayed data is longer than the defined field length. For example, you might store data as *999* (field length in the database is 3 characters), but the display format of the data is *9-9-9* (5 characters).

PeopleSoft Application Designer uses the field length of 3, by default, for the edit field, which is not long enough to hold the five characters of the reformatted data. By entering 5 in the Max Display Len (maximum display length) field, the page uses five characters for the edit field without requiring that the field length in the database be five characters long.

## Editing Formats

The Edit Formats dialog box presents a tree where you define the stored and display formats for a family and all options and attributes. This dialog box enables you to:

- Add, update, and delete stored and display formats.
- Enter a description for the family.
- Specify options, such as uppercase and smart punctuation, for the family.

Click OK to save changes.

**Image: Formats dialog box**

This example illustrates the fields and controls on the Formats dialog box. You can find definitions for the fields and controls later on this page.

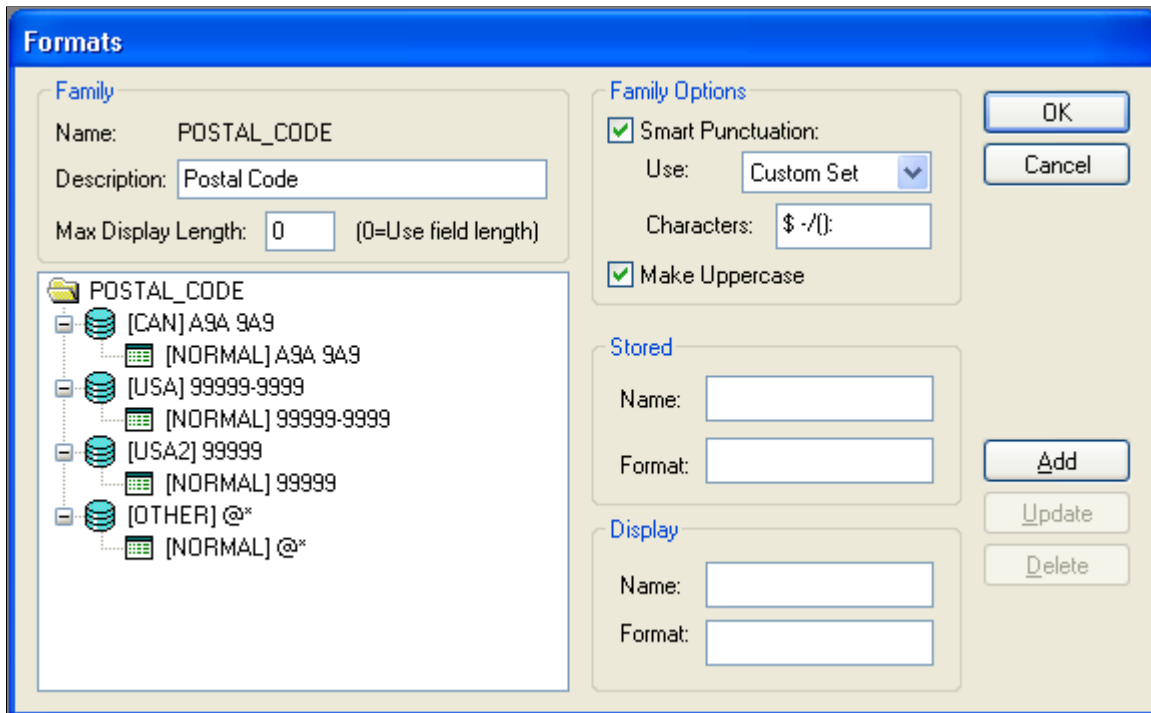

This section discusses how to:

- Add a new stored format.
- Add a new display format to a stored format.
- Update a display format.
- Delete stored formats.

**Adding a New Stored Format**

To add a new stored format:

1. Open the format family to which you want to add a format.
2. Select the format family name.
3. Enter the stored and display names and format notation.
4. Click Add.

The new format appears in the tree below the existing formats.

**Adding a New Display Format to a Stored Format**

To add a new display format to a stored format:

1. In the tree, select the stored format name to which you want to add a display format.

2. In the Display group box, enter a new name and format notation.
3. Click the Add button to add the display format.

The new display format appears in the tree, attached to the stored format to which it belongs.

## Updating a Display Format

To update a display format:

1. Select the display format in the tree view.

---

**Note:** Clicking the Update button applies only to display formats.

---

2. Select a display format and enter the enabled fields.
3. Click Update to update the display.

## Deleting Stored Formats

To delete a stored format:

1. Select the display format.
2. Click the Delete button.

PeopleSoft Application Designer displays a warning message indicating that deleting a display format might strand stored data. Select Yes to continue with the deletion.

---

**Note:** Stored formats cannot be deleted directly. Therefore, all display formats for a specific stored format must be deleted first to ensure that data is not stranded in the database under an invalid format. When the last display format is deleted for a stored format, the stored format is automatically deleted.

---

## Using Family Options

Family options include:

- Smart punctuation
- Make uppercase

### Smart Punctuation

Smart punctuation automatically adds or removes punctuation characters to the data that users enter. For instance, if you enter a phone number, *8005551212* and press the tab key to exit the entry field, the system reformats the value as *800-555-1212*.

The system uses the punctuation characters specified in the punctuation list to strip out unwanted input and to modify the pattern specified before applying the pattern to the data.

---

**Note:** Smart punctuation and the standard set of characters are enabled by default.

---



You can modify the standard set of characters by selecting *Custom* in the options drop-down list box and typing another set of punctuation characters to use. Smart punctuation processes the characters defined in the standard set or custom set as follows:

- The input has all characters in the punctuation set stripped out—similar to ignoring white spaces.
- The pattern has all characters in the punctuation set expanded if they are not found in the input.

To do this, enclose each punctuation character in the punctuation set with "[ *punc\_char* ]!".

- The formatter runs on the modified data to apply the modified pattern.

---

**Warning!** Use meta characters and lexical characters in the punctuation sets with caution. Step 2 of the transformation process modifies the format pattern so that PeopleSoft Application Designer might sometimes convert special characters to literals (when they are inside the left or right brace).

---

For example:

- Input: *(800)555-1212*.
- Display pattern: *999-999-9999*.
- Punctuation set: *()-*.
- Stored pattern: *999999999*.
- The "(", ")", and "-" are stripped out of the input because they appear in the punctuation set.

Now the input looks as follows: *8005551212*.

The display pattern is modified to *999[-/]!999[-/]!9999* because "-" is in the punctuation set. The transformed data (*8005551212*) is matched against the display pattern of *999[-/]!999[-/]!9999*. The match is successful, so the raw data is transformed into *800-555-1212*.

Now, the input data has successfully matched the expected display format. The next step is to transform this data into what we want stored. In this case, the stored format has no dashes, as in *999999999*.

The transformed data (*800-555-1212*) is stripped of the smart punctuation characters (*8005551212*), and the pattern of the stored format is *999999999*. A match is made so that the system stores *8005551212* in the database.

Finally, the stored data is reformatted back to the display using *8005551212* and the display pattern. Output to the display is reformatted to *800-555-1212*.

## Make Uppercase

Custom format fields support mixed case. With uppercase activated, PeopleSoft Application Designer transforms the data into uppercase when you press the tab key to exit the field.

## Testing Formats

The Test Format dialog box enables you to test a specific format or unformatted path for a family without having to build a page:

**Image: Test Format dialog box**

This example illustrates the fields and controls on the Test Format dialog box. You can find definitions for the fields and controls later on this page.

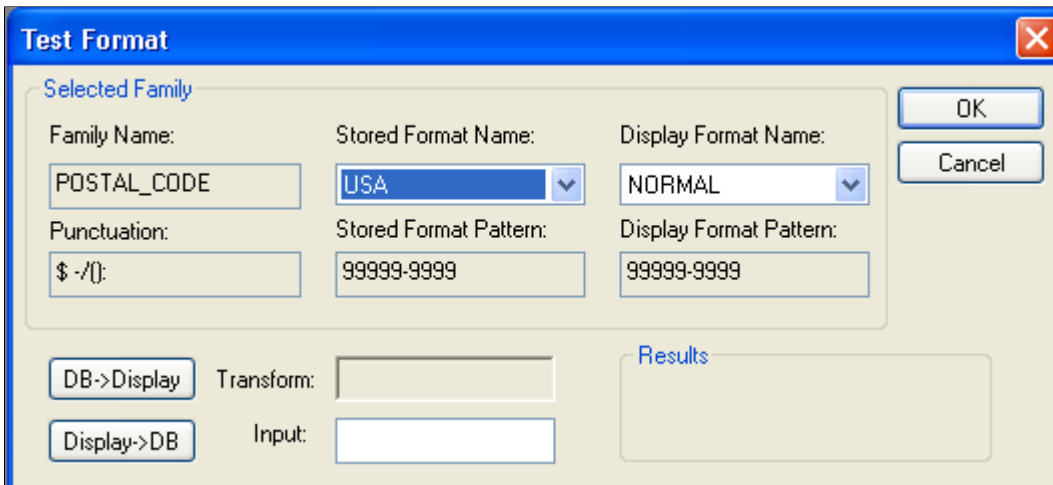

**Stored Format Name and Display Format Name**

Select a stored and display format pair to test.

**DB->Display**

Click this button to process the input field like data from the database. The system applies the stored format pattern to the input, and then applies the display format pattern to the result. The output appears in the Transform field, which is the same output displayed for a field using this format.

**Display->DB**

Click this button to process the input field like user input from a page. The system applies the display format pattern to the input, and then applies the stored format pattern to the result. The transformed output appears in the Transform field. This output reflects what is stored in the database if the operation is successful. On an actual page, when the user presses the tab key to exit the field, the system calls the DB->Display function to reformat the user input for the display.

---

## Using the Translate Table

This section provides an overview of the Translate table and discusses how to:

- Add values to the Translate table.
- Change translate values.
- Delete translate values.
- Save the Translate table.

## Understanding the Translate Table

The Translate table is a prompt table, similar to an all-purpose data dictionary, that stores values for fields that do not need individual prompt tables. As a general rule, store field values in the Translate table if the field meets the following criteria:

- Field type is *Character*.
- Field length is 1 to 4 characters.
- Field values consist of a relatively small, static set of values that are not maintained by the user.
- No other fields relate to this field.

---

**Note:** If the only values for a field are *Y* (yes) and *N* (no), you do not need to enter them in the Translate table. The Translate table comes with a field for *Y* and *N* named PSYESNO. When you select Yes/No Table Edit, the system automatically points to the PSYESNO field in the Translate table.

---

### Example of When to Use the Translate Table

Consider the relative attributes of a department ID field and a gender field in a company database. In the following table, Department ID is not a good case for using the Translate table because it requires its own prompt table. However, the Gender field *is* a good case for using the Translate table:

<b>Characteristic</b>	<b>Department ID</b>	<b>Gender</b>
Field type	Character.	Character.
Field length	Longer than 3 characters.	1 character.
Field values	Could be many values, 20 or more.	Two possible values.
Other related fields	Related to other fields, like department manager.	Not related to other fields.
Requires maintenance	Yes, users might have to add departments.	No, gender is a static value.

### Translate Table Attributes

The system maintains the structure of the Translate table and you supply the data. This table contains the following fields:

<b>Field Name</b>	<b>Description</b>
FIELDNAME	Field name, such as ABSENCE_TYPE.
LANGUAGE_CD	Language code.
FIELDVALUE	Value for the field.

<b>Field Name</b>	<b>Description</b>
EFFDT	Effective date.
VERSION	Internal version number (system-maintained).
EFF_STATUS	Status: active or inactive.
XLATLONGNAME	Thirty-character description; used as a label on pages and reports.
XLATSHORTNAME	Ten-character description; used as a label on pages and reports.
LASTUPDDTTM	Datetime field showing the last time that a field was updated.
LASTUPDOPRID	User ID of the user who most recently updated the field.

If you must define more information about a field than the preceding attributes, create a separate prompt table for the field instead of adding it to the Translate table.

When the user presses the prompt button to prompt for valid values in a field on a page, the system displays a list of the translate values for a field.

Each value in the Translate table has an effective date, and the date must be earlier than the effective dates of any rows that reference the value. The translate values delivered by PeopleSoft all have an effective date of January 1, 1900. Choosing a different value for translate values that you add enables you to quickly differentiate delivered values from your values.

---

**Note:** Null values are not supported as effective dates.

---

## Adding Values to the Translate Table

Access the Add Translate Table Value dialog box.

To add translate values to the Translate table:

1. From a field definition window, select File > Definition Properties.

You can also right-click and select *Field Properties*, or press Alt+Enter.

2. From a record field definition window, right-click the field and select View Translates from the pop-up menu.
3. Select the Translate Values tab.

The Translate Values dialog box displays existing values for the field and enables you to add, change, or delete values. In the Last Updated box, you see information—date, time, and user ID—about the last update for the selected translate value.

4. Click Add to define a new value.
5. Enter the field value, effective date, long name, and short name that your users enter on the page.

<b>Field Value</b>	Enter the translate value for the field. The system automatically sorts values in ascending order as you enter them. If you enter three translate values with field values <i>A</i> , <i>T</i> , and <i>C</i> , they appear in the Translate Values dialog box as <i>A</i> , <i>C</i> , <i>T</i> .
<b>Effective Date</b>	Enter the date on which you want this value to take effect. The default value is today's date. If you want the effective date to predate all rows on your database, enter <i>01011900</i> (January 1, 1900). <hr/> <b>Note:</b> The Add button only allows you to add a new, distinct translate value. To add a different effective date for the same translate value, select the translate value and use the Change button. As long as the effective date is changed, the system saves the modified entry. <hr/>
<b>Inactive</b>	When a value for a field becomes obsolete, you should select the Inactive check box rather than deleting the value. Deactivating a value enables fields in the database that still contain the value to use the correct long and short names. If you delete an obsolete code from the Translate table and you still have records in the database that contain that value, then you must change all of those values to active values.
<b>Long Name</b>	Enter up to 30 characters.
<b>Short Name</b>	Enter up to 10 characters. If you leave this field blank, the system automatically copies the first 10 characters of the long name into this field. Use mixed case to improve readability. <hr/> <b>Note:</b> The recommended character length of translate short name values is six. You can configure PeopleSoft Application Designer to alert you if the recommended length is exceeded. <hr/>
	See <a href="#">Setting PeopleTools Options</a> .

## Changing Translate Values

Sometimes the meaning of a translate value changes, but you still need to retain both values in the Translate table. For example, suppose that your PROFICIENCY field has a value of *E* (extremely high). You have been in production for five years when upper management decides to change the meaning of the value to *Exceptional* as of January 1, 1998.

You can accommodate this type of change by creating a second active entry for the same translate value. The first value is valid in the time range between the effective dates of January 1, 1990, and December 31, 1997. The second entry is valid from January 1, 1998, onward. You do not want to delete the existing

entry because the database might contain rows that predate January 1, 1997, and contain this value. You might also maintain the existing definition for historical reporting.

To change an existing translate value, select the value and click Change or double-click the value. The system displays the Change Translate Table dialog box, in which you can make the necessary changes.

## Deleting Translate Values

Use caution when deleting a translate value, unless you are removing an invalid value that was entered by mistake. To deactivate a value because it is no longer used or its meaning has changed, either change the long and short names, or change the status to *Inactive*. To delete the value, select it and click the Delete button. The system removes the row.

## Saving the Translate Table

After you have made all of your changes to the Translate table, you must save the *entire field definition*. The system has no save option specifically for translate values. Click OK from the Field Properties dialog box, and then save the field definition by clicking the Save button or selecting File > Save.

To save the Translate table, you must be authorized to modify field definitions. A special Translates Only security access level is available for fields; it allows authorized users to update translate values but not other field attributes.

## Chapter 5

# Planning Records, Control Tables, and Tablesets

---

## Understanding the Planning Process

This topic discusses:

- Table-based systems.
- Normalized relational databases.
- Record definition planning.
- Effective dates.
- Control tables.
- Tablesets.

## Table-Based Systems

Planning is the first step in the application development process. As a system designer, you must consider how to store, retrieve, manipulate, and process data that is stored in the tables in your application database.

PeopleTools-based applications are table-based systems. A database for a PeopleTools application contains three major sets of tables:

- System Catalog tables store physical attributes of tables and views, which your database management system uses to optimize performance.
- PeopleTools tables contain information that you define using PeopleTools.
- Application Data tables house the actual data that your users enter and access through PeopleSoft application pages.

This diagram shows PeopleSoft database tables and sample names:

### Image: Tables in a PeopleSoft database

The following image explains about the different tables in a PeopleSoft database

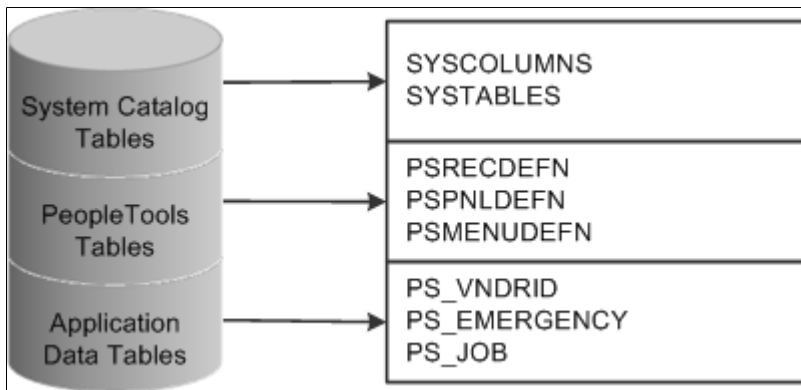

Like a spreadsheet, each of these tables contains columns and rows. Columns define the structure of how the data is stored. Rows represent the actual data that is stored in the database.

Every time that you create a new definition using PeopleTools, the system inserts rows of data into various PeopleTools tables. The entries in these tables determine the online processing of the system and what happens during imports. PeopleSoft maintains the structure of these tables. You maintain data in the PeopleTools tables related to definitions that you create or adapt using PeopleTools. You can view the PeopleTools tables in the PPLTOOLS project using the PeopleSoft Application Designer.

To create the application data tables that store the rows of data that your *users* manipulate:

1. Create a record definition.

In doing so you determine the structure of the table, the characteristics of the fields, and any online processing that you want to occur behind the scenes when a user enters data.

2. Apply the SQL Create option to build the SQL table in which your application data will reside based on a subset of parameters in your record definition.

During this process, the system automatically gives the application data table the same name as your record definition, prefaced with *PS\_*.

## Normalized Relational Databases

To better understand the structure of your PeopleSoft system, you should be familiar with the concept of a normalized relational database. A *normalized* table adheres to standards that are designed to improve the productivity of the database user. Normalization makes the database more flexible, allowing data to be combined in many different ways.

The standards for a normalized database are called *forms*, such as *first normal form*, *second normal form*, and so on.

### First Normal Form

The first normal form requires that a table contain no repeating groups of non-key fields. In other words, when you set up a record definition, if you encounter a field that could have multiple occurrences, put that field in a separate record that is subordinate to the primary record definition (a child record). This setup allows unlimited occurrences of a repeating field rather than a specified number. Each row of



data is uniquely identified by a primary key, which can be a single field or a group of fields that, when concatenated together, form a unique key.

For example, look at the record definition structure of the tables that we use to schedule exam times for different locations in our training database. Here are the necessary fields, in order of importance:

- LOCATION
- EXAM\_DT
- EXAM\_TIME

You know that you have multiple exam dates and times per location. You could set up record definitions to accommodate this data as follows:

<i>Record Definition</i>	<i>Fields</i>	<i>Key?</i>
LOCATION	LOCATION	Yes
EXAM	LOCATION	Yes
	EXAM_DT	Yes
EXAM_TIME	LOCATION	Yes
	EXAM_DT	Yes
	EXAM_TIME	Yes

Because multiple exam dates per location might exist, we added exam dates to the second record definition (child record) that is subordinate to the first (parent) record. Similarly, because one date could have multiple exam times, exam times are located in a third record definition that is subordinate to the second.

## Second Normal Form

The second normal form dictates that every non-key field in a table must be completely dependent on the primary key. If two fields make up the key to a table, every non-key field must be dependent on both keys together. For example, if a table has the Employee ID and the Department ID fields as keys, you would not put the Department Name field in the table because this field is dependent only on the Department ID field and not on the Employee ID field.

## Third Normal Form

The third normal form is a corollary to the second; it requires that a non-key field not be dependent on another non-key field. For example, if a table is keyed by the Employee ID field and Department ID is a non-key field in the table, you would not put the Department Name field in the record because this field is dependent on a non-key field (Department ID). You would find the Department Name field only in the table that is keyed by the Department ID field, not in any other table that contains Department ID.

With the third normal form, you store shared fields in tables of their own and reference them elsewhere. For example, you would not put the Department Name field in every record definition in which the Department ID field appears. Instead, you would create a prompt table of department IDs and department

names. Similarly, you would create a prompt table of job codes and job titles instead of putting a job title in every employee's record.

---

**Note:** When designing record definitions, you should adhere to the third normal form to increase flexibility and reduce data redundancy.

---

## Record Definition Planning

Before you begin to create record definitions, you should know how you plan to use the record definition, the fields that it will contain, special edits that you would like to see performed on the record definition, or specific fields in the definition.

You define two layers of information:

- Record level
- Field level

At the record level, determine the ultimate purpose of the record definition and how it will be used in the system. Is it destined to define an underlying SQL table to hold data? Are you building a view to join or retrieve information from other tables? Do you need a temporary work record where you can store derived data?

You can audit record-level changes, as opposed to individual fields contained in the record definition, which is an efficient alternative if you plan to audit several fields. You can also establish a more sophisticated use of record definitions, such as sharing information in tablesets and multi-language controls, at the record level.

At the field level, plan the details of what types of fields to add. Should they be character fields or number fields? Should automatic formatting be used? What are the keys to the data stored in the database? Which fields should you audit? Do you want to specify prompt tables so that users can select from lists of valid values that are stored elsewhere in the database?

In most cases, if you are creating a record definition for a SQL table, you don't have to worry about record-level definitions for parameters and conditions. Unless you change how a record definition is used, the system automatically assumes that you are defining a record definition for an underlying SQL table.

## Effective Dates

Effective dates enable you to keep historical, current, and future information in tables. You can use the information to review the past and plan for the future. Three types of effective dates are available:

<b>Future</b>	Data rows that have effective dates that are after the system date, which is usually today's date.
<b>Current</b>	Data row with the most recent effective date that is closest to today's (system) date, but not a future date. Only one row is the current row.
<b>History</b>	Data rows that have effective dates before the current data row.

The EFFDT (Effective Date) field has special properties related to the processing of effective dates on rows and should be used only when needed.

Unlike regular date fields, which you can use anywhere in the system, use the EFFDT field only in record definitions for which you want to maintain data history—future, current, and past—to store rows of data in sequence. Using EFFDT fields only for this circumstance enables you to store multiple occurrences of data based on when it goes into effect.

For effective-dated rows, you can have multiple occurrences of future and history but only one current row of data.

EFFDT is almost always a key and almost never a list item. Activate the Descending Key attribute so that the row with the most recent effective date appears first on pages. You might enter %DATE (current system date) as the default constant for this field.

---

**Note:** Alternatively, you can use %CLIENTDATE as the default constant for the date field. %CLIENTDATE adjusts the date as appropriate to the time zone of the browser.

---

To enable you to track an accurate history of your effective-dated information, the system invokes special logic when you access a record definition that contains EFFDT. The action that you select dictates whether you can access the row type and what you can do with each type of row:

<b>Action Type</b>	<b>View</b>	<b>Change</b>	<b>Insert New Rows</b>
Update/Display	Current, Future	Future Only	Effective Date Greater Than the Current Row
Update/Display All	History, Current, Future	Future Only	Effective Date Greater Than the Current Row
Correction	History, Current, Future	All Existing Rows	Add New Rows with No Effective Date Restrictions

---

**Note:** For records that do not contain EFFDT, all actions (Update/Display, Update/Display All, and Correction) operate the same way: they retrieve all existing rows for the specified keys.

---

When you run a page with effective-dated records and you insert a row, the system copies the contents of the previous row into the new row to save you keying time. In a large effective-dated table, you do not want to reenter all of the data when only a single field changes. Also, anytime you insert an effective-dated row using PeopleCode, the system copies the contents of the previous row.

### **Effective Status**

In prompt tables, EFF\_STATUS (Effective Status) usually accompanies EFFDT. When used with EFFDT, it is part of the mechanism that enables the system to select the appropriate effective-dated rows.

You can also use EFF\_STATUS by itself as a simple status field, but do not change the translate values. They must be *A* (active) and *I* (inactive) for EFFDT to work properly. If you need a status field with different values, use or define a different field.

### **Effective Sequence**

The EFFSEQ (Effective Sequence) field serves different purposes, depending on whether it is paired with EFFDT. If EFFSEQ is not paired with EFFDT, then EFFSEQ has no special function and can be used as a simple sequencing field wherever you need one.

If EFFSEQ is paired with EFFDT, it enables you to enter more than one row with the same effective date. You assign a unique sequence number to each row that has the same effective date.

Do not make EFFSEQ a required field; a value of *unrequired* allows the first EFFSEQ to be zero. Select Display Zero in the page definition to have zeros appear on the page.

For example, suppose that you want to enter both a transfer and a pay rate change for an employee, and both actions are effective on the same day. Enter the transfer on the job data pages as usual, and leave the Effective Sequence Number field as 0 (zero). Then, insert a row to enter the change in pay rate.

This time, the effective date is identical to the previous row, but enter 1 in the Effective Sequence Number field.

### Related Links

"%ClientDate" (PeopleTools 8.58: PeopleCode Language Reference)

"%Date" (PeopleTools 8.58: PeopleCode Language Reference)

## Control Tables

Control tables store information that controls the processing of an application. This type of processing might be consistent throughout an organization (in which case the entire organization shares the same control information), or it might be used only by portions of the organization for more limited sharing of data.

### Sharing One Set of Common Values

The first type of sharing is to create one table that everyone shares; it stores common information that is valid for *all* users, such as a country table to store country codes or a department table to store department codes. Such control tables are ordinarily maintained centrally because the data is shared throughout the entire organization.

### Sharing Common Values in Overlapping Plans

What do you do if the codes that are stored in a table are valid only for *some* users? Consider benefit plans, for example. Typically, you store information for benefits plans in a plan table. However, not all plans are valid for all employees; their validity might depend on whether the employee is full-time or part-time, union or nonunion. Some plans might overlap; some might be appropriate for all employees and others only for some. In a relational database, you do not want to define the same plan value—and associated data—more than once.

In this case, you can easily resolve the problem by using two tables. The first is the plan table, which stores the relevant data for each plan. The second table defines which plans are valid for various benefit programs or groups of plans. For example, one benefit program might be valid for nonunion employees, and another benefit program might contain the plans as negotiated with a union.

This table shows how you might set up the two tables to reflect the benefits offered:

<b>Benefit Program Table</b>	<b>Benefit Plan Table</b>				
Key	Valid Values	Key	Description	Field	Field
Nonunion Program	Plan 1	Plan 1	Health	...	...
	Plan 2	Plan 2	Life	...	...
Union Program	Plan 2	Plan 3	Savings	...	...
	Plan 3	Plan 4	Health-Union	...	...
	Plan 4				

These tables are ordinarily centrally maintained because the data is shared by various groups in the organization.

## Tablesets

When *none* of the information stored in control tables is valid for all users, but the structure of these common tables is the same, you can set up a way to share multiple sets of values. For example, a multi-company organization must store completely different sets of accounting codes for its various operating entities, and the data for these accounting codes is maintained in a set of relevant control tables. The actual data values differ, but the structure of the control tables remains the same. PeopleTools enables you to share sets of values in a control table through *tablesets*.

To better understand Typesets, consider an organization that has two retail stores with common accounting codes, two pharmaceutical firms with another set of accounting codes, and two shipping firms with yet another set of codes.

### Image: Maintaining multiple account codes for multiple companies

The following image explains about maintaining multiple account codes for multiple companies

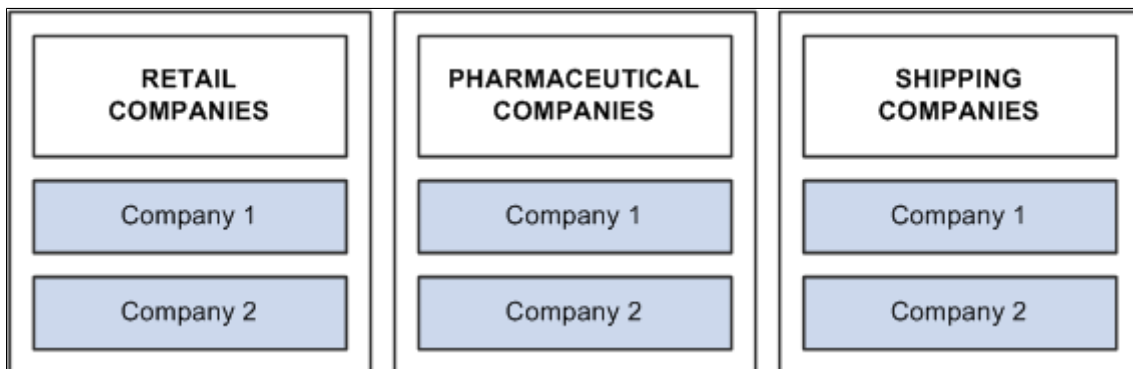

If each of these companies has completely different accounting codes, you can establish six different sets of account codes to be maintained by each company. If they all have exactly the same accounting codes, you can limit them to one set of values. However, the reality is usually somewhere in between. That is, there is one set of account codes for each type of business: retail, pharmaceutical, and shipping. Rather than having six different companies maintaining separate copies of this common data, you can reduce the number to three sets:

**Image: Sharing multiple account codes among companies**

The following image illustrates the concept of sharing multiple account codes among companies

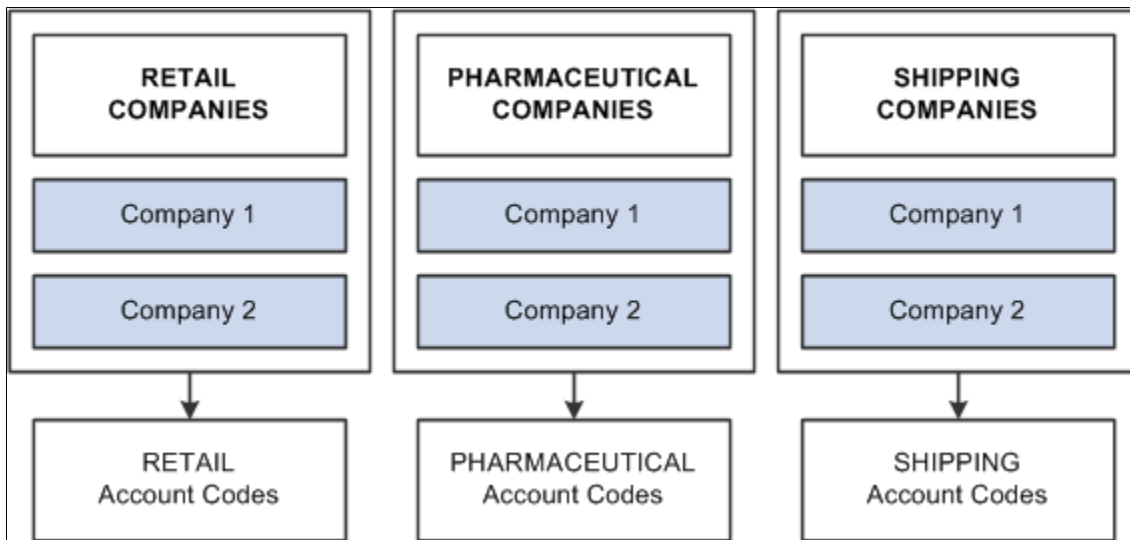

You can also handle exceptions. Suppose that Retail Company 2, a recently acquired company, has its own unique set of account codes. A separate set of values should be maintained for this company as an exception to the retail rule:

**Image: Sharing account codes among companies with exceptions**

The following image explains sharing account codes among companies with exceptions

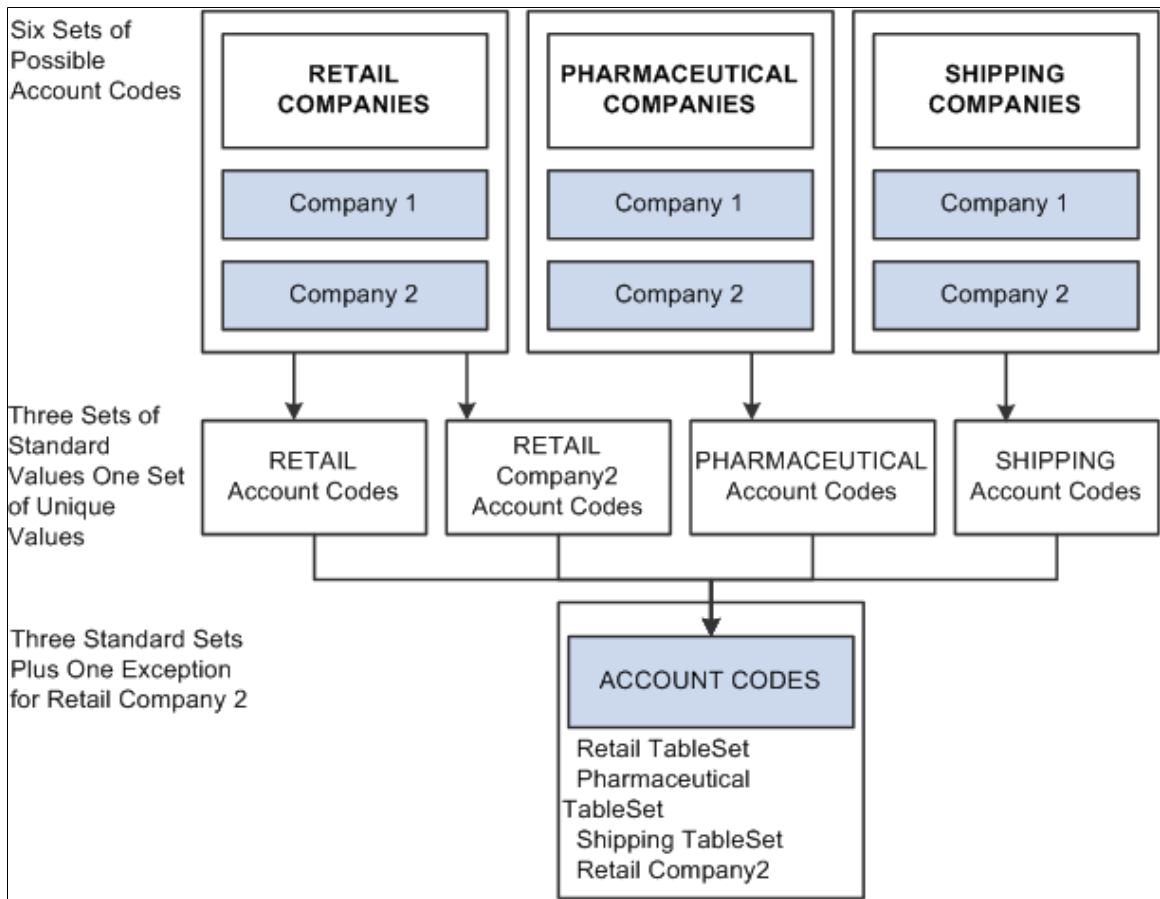

When you share tables in PeopleTools applications, you add the SETID field as an additional key or unique identifier to the table that you want to share. This key identifies the sets of information in the table that are shared by multiple companies or business units under your corporate umbrella. You then specify a *set control* field, which identifies which fields map between the original key and the tablesets. You can specify any field that logically identifies the tablesets. In this example, you might assign the Company field as the set control:

**Image: Linking set controls and tablesets**

The following diagram illustrates linking set controls and tablesets where in you can specify any field that logically identifies the tableset

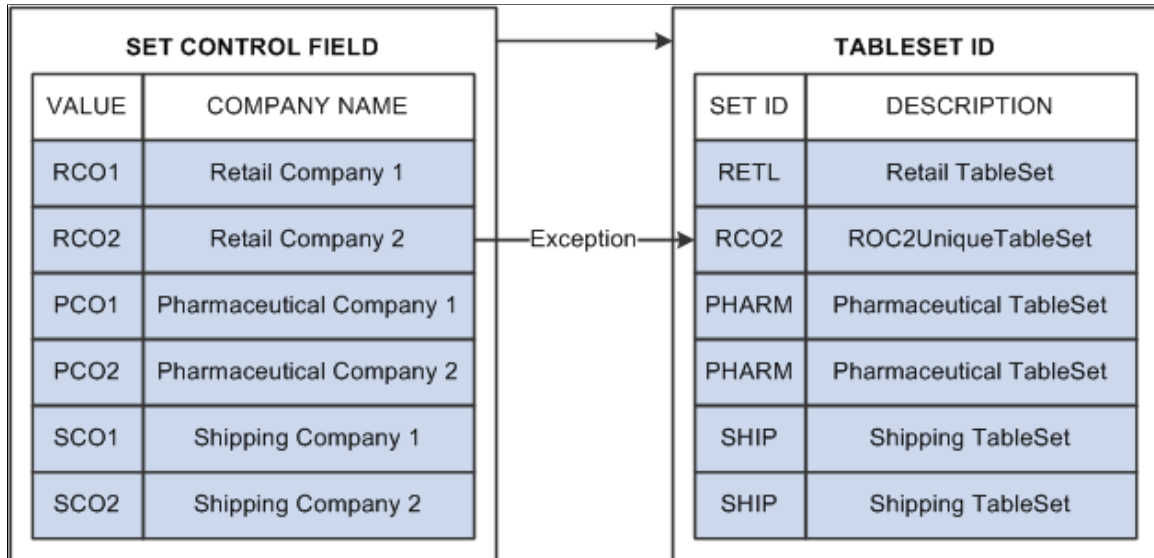

**Sharing Groups of Record Definitions**

While this example illustrates how you might share data values for a single table—Account Codes—you typically share data that is stored in many tables that are based on the same tablesets. To minimize the overhead of defining tablesets, you can define *record groups* that share table data in a similar manner. For example, rather than using the tablesets that you establish for accounting codes solely for the Accounting Code table, you can group all accounting related tables into one record group.

**Tablesets and PeopleSoft Applications**

Some PeopleSoft applications already take full advantage of tablesets and table sharing. Throughout the PeopleSoft Financials and HCM product lines, tablesets are used extensively, in most cases triggered by business unit.

---

**Sharing Tables**

This section provides an overview of table sharing and discusses how to:

- Add the SETID field to record definitions.
- Define set control fields as the fields controlling the assignment of tablesets.
- Modify set control fields.
- Create setIDs.
- Define record groups to identify the tables and subordinate (child) tables that are affected.
- Define tablesets controls.



- Share trees.

## Understanding Table Sharing

To share tables, you must modify the record definitions for both the table that you want to share and the one that contains the set control field. Using the online PeopleTools utilities for tablesets, you define the terms or controls for sharing.

For example, the PeopleTools database holds data for three companies: one U.S.-based parent company (PST) and two sister companies (CCB in the U.S. and VNB in Canada). In this organization, all of the U.S.-based companies share one set of accounting codes, and all of the Canadian-based VNB companies share another:

<b>U.S. Account Codes</b>	<b>Canadian Account Codes</b>	<b>Description</b>
123456789	123456789	Teller
987654321	987600000	Customer Service
CCB-4476-EXTSAL-USA	VNB-4476-EXTSAL-CDN	Extraordinary Salary Employees
CCB-4476-REGSAL-USA	VNB-4476-REGSAL-CDN	Regular Salary Employees

These two groups of companies must maintain parallel sets of accounting codes and, in some cases, use the same code, uniquely identified for U.S. or Canadian companies.

You must set up the Account Code table so that users who access that page or prompt for valid values see only the values for their respective companies, depending on whether they are located in the U.S. or Canada.

To do this:

1. Modify the Account Code table, which will be shared, and the Company table, the values of which (CCB, PST, VNB) control the tablesets that are used.
2. Create two Tubbiest IDs:
  - USA: For U.S. companies.
  - CAN: For Canadian companies.

**Image: Tablesets and set control fields**

The following diagram explains how two groups of companies can maintain parallel sets of accounting codes that contain unique tablesets and set control fields

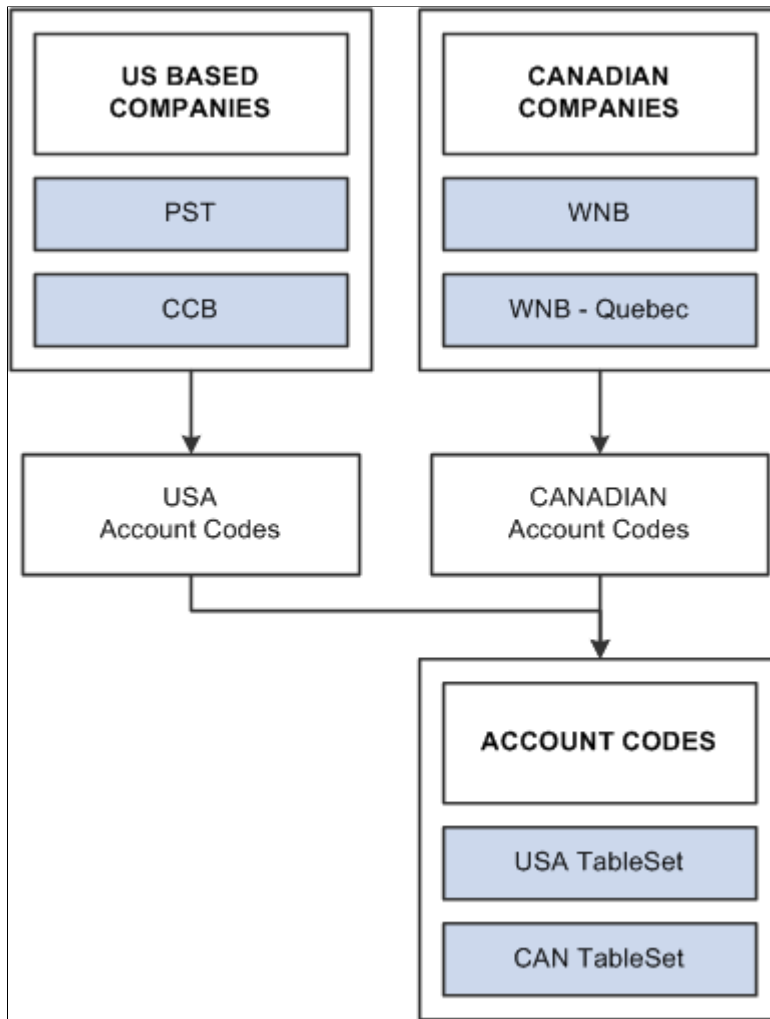

**Assigning Set Control Fields**

If you plan to use the Table Sharing feature to add an additional high-level key to identify common sets of values and handle exception values, you enter a set control field. The set control field determines which set of values appears, based on how you define table sharing.

Table sharing is usually applied in multi-company environments, in which you might want to share certain tables in some operating entities while allowing others to retain control over the contents of their own. Use the feature to maintain a single table in which you can store multiple sets of values to be used by different entities in your organization.

When you create a record definition that will be shared, you add the field SETID as a high-level key. The setID value is controlled by the key that you select in the Set Control Field drop-down list box in the Record Properties dialog box. These setIDs identify groups of tables to be shared and enable each business entity to identify whether it wants to use the corporate-wide table or maintain its own. Enter the name of the key as your set control field for each record definition that will be shared.

For example, if you have several companies in your organization, many of which share the same set of account codes, add a SETID field to the ACCOUNT table record definition. In this definition, enter *Company* as the set control field. The set control enables different companies to access the account values stored in the same Account table. As each company defines its set controls, it has the option to use the shared Account table or maintain control of its own.

## Adding the SETID Field to Record Definitions

Add the setID field to the record definition for table sharing purposes.

### Image: Adding setIDs to record definitions

This example illustrates the fields and controls on the Adding setIDs to record definitions. You can find definitions for the fields and controls later on this page.

Num	Field Name	Type	Len	Format	Short Name	Long Name
1	<b>SETID</b>	Char	5	Upper	SetID	SetID
2	TREE_NODE	Char	20	Upper	Node	Tree Node
3	EFFDT	Date	10		Eff Date	Effective Date
4	<b>SEQNUM</b>	Nbr	3		SeqNum	Sequence number
5	EFF_STATUS	Char	1	Upper	Status	Status as of Effective D
6	EMAILID	Char	70	Mixed	Email ID	Email ID
7	<b>DISTID</b>	Char	30	Mixed	ID	Distribution ID
8	<b>DISTIDTYPE</b>	Char	3	Upper	ID Type	Distribution ID Type

To add a setID:

1. Open the record definition for the table that you want to share.
2. Select New > Field > Character.
3. Enter the special field that PeopleTools provides for table sharing:

SETID is a 5-character field. Add it to the top of your record definition list, and define it as a required key, search and list item, with a prompt table edit against the PeopleTools SETID\_TBL.

## Defining Set Control Fields

After you add the setID field to your record, identify the set control field in Record Properties.

To define the set control field:

1. Select Edit > Definition Properties from the menu.
2. Select the Use tab.
3. Select the field that identifies the appropriate setID in the Set Control Field drop-down box.

See [Understanding Table Sharing](#).

4. Click OK to save your changes.

5. Use the SQL Alter process to alter your underlying SQL table.
6. When the system prompts you for a default setID, enter the most common setID for your company.

## Modifying Set Control Fields

If you are sharing tables or using a set control field that is not already defined as such in your PeopleSoft application, you must make some modifications to the record definition for the table in which you store values for your specified set control field. For example, all PST company codes are stored in the COMPANY\_TBL.

Here, you must add PeopleCode to the set control field so that each time you add a new value, the system populates the set controls in PeopleTools utilities, where you assign the appropriate tablesets.

### Image: Attaching PeopleCode to your set control field

This example illustrates the fields and controls on the Attaching PeopleCode to your set control field. You can find definitions for the fields and controls later on this page.

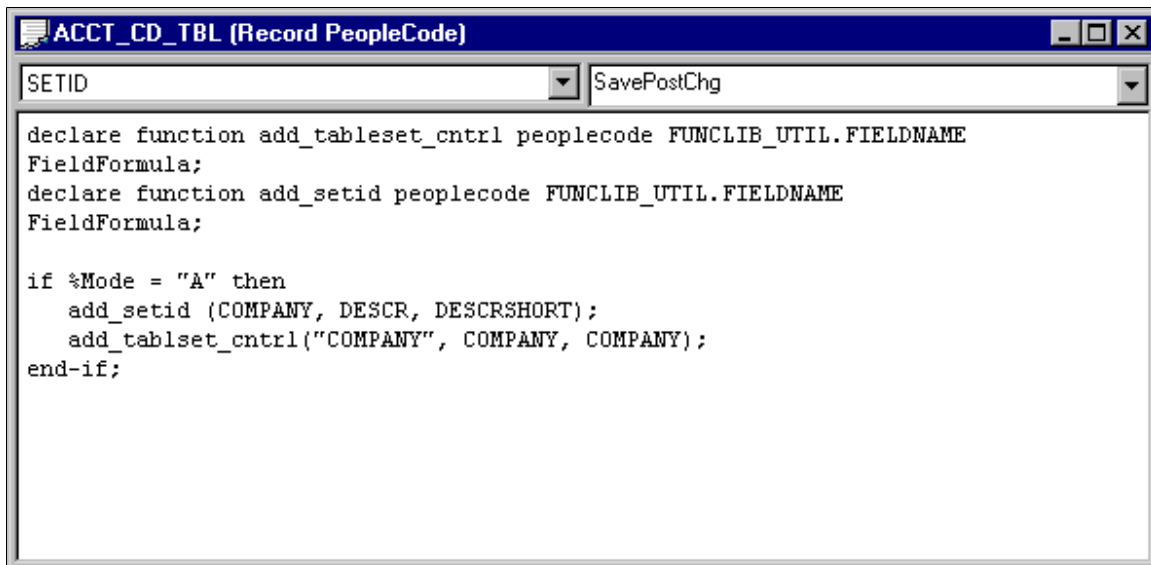

This program assigns a default setID with the same value as the Set Control Field value, for each new COMPANY row that you add to the COMPANY\_TBL. For example, when you add a row for CCB in the Company table, it creates a default setID of CCB. This way, each value that you add is assigned a unique tableset until you assign shared tablesets in the Utilities window.

You can easily clone and modify this program to change the ADD\_SETID and ADD\_TABLESET\_CNTRL statements to reflect your table sharing objectives. Alternatively, if you are working with existing tableset functionality, you can point to a model setID that is delivered with your PeopleSoft application.

## Related Links

[Altering Tables](#)

## Creating SetIDs

After you prepare for sharing your table, you define the setIDs that logically group information. When you define setIDs, you create groups that might naturally share more than one table. For example, although CCB and VNB are planning to share only the ACCT\_CD\_TBL now, the setIDs that you set up might define logical divisions in the organization that serve as the basis for sharing all accounting-related tables. Describe your sets to give them as broad an application as is practical in your organization.

If possible, use descriptions that denote the shared table and set control field. For example, for CCB and VNB, we added two tableset IDs, identifying them as related to accounting codes for companies:

<i>setID</i>	<i>Description</i>	<i>Short Description</i>
USA	Accounting Codes - USA Co.s	AcctCd USA
CAN	Accounting Codes - CAN Co.s	AcctCd CAN

You create setIDs on the TableSet ID page in PeopleTools > Utilities > Administration > TableSet IDs.

### Related Links

"TableSet IDs" (PeopleTools 8.58: System and Server Administration)

## Defining Record Groups

Record groups are a set of logically and functionally related control tables and views. They help enable tableset sharing, which eliminates redundant data entry and ensure that it is applied consistently across all related tables and views.

In the record group table, you group the record definitions for the tables that you want to share and any dependent record definitions. If you add a table to a PeopleSoft application, an appropriate record group might already be defined. However, if you add new business functions, you might need to add a new record group for the tables that you define. You access the record groups table in PeopleSoft Pure Internet Architecture on the Record Group page.

### Related Links

"Record Group" (PeopleTools 8.58: System and Server Administration)

## Defining Tableset Controls

As you add values for your set control, the system automatically populates the Tableset Controls 1 table with default values. You define tableset controls in PeopleTools > Utilities > Administration > TableSet Control using the browser. Here you can enter the set control value for which you want to assign a tableset.

For example, we use Company as our set control field, and PST, CCB, and VNB are values that we want to add to the Company table. The system automatically assumes that each new set control value maintains its own set of tables and does not enable table sharing. So, the default values are the same as the set control value. In this case, when we added the value CCB to the Company table, the system populated the tableset controls with a default setID of CCB.

Because CCB is a U.S.-based company that should share the same U.S. accounting codes, we must change the defaults to USA.

## Related Links

"TableSet Control" (PeopleTools 8.58: System and Server Administration)

## Sharing Trees

To share trees as well as tables and views, complete Tableset Controls 2 in the same way that you did Tableset Controls 1. For example, if PST and CCB want to share one department tree for organizational security and VNB another, you assign the appropriate setID for each value.

## Defining Tableset Controls for Trees

To define tableset controls for trees:

1. Select PeopleTools > Utilities > Administration > TableSet Control in PeopleSoft Pure Internet Architecture.
2. Enter the name of the set control value for which you want to assign a tableset on the search page.

For example, we use Company as our set control field, and PST, CCB, and VNB are values that we want to add to the Company table.

Because you already assigned a default setID in Tableset Controls 1, the system displays the default setID that you assigned to this field value. If you create another tableset for sharing trees, you can change this value.

3. Specify the tree name.

Click the prompt button next to the Tree Name field for a list of only the tree definitions with the same set control field (which has SavePostChange PeopleCode that recognizes it as a tableset control field).

This prompt list comes from a SQL view of tree definitions with those set control fields that have not already been associated with a tree group.

4. In each tree row, specify the appropriate setID.
5. Save your changes.

## Viewing All Record Definitions Associated With a Set Control

You can view all record definitions that are associated with a set control on the Record Group tab of the TableSet Controls page.

## Example of Set Controls

After you set up and define all of your set controls, you can see the results by looking at pages on which you reference codes that are stored in a shared table. For example, on Administer Workforce, Use, Job Data 1 and 2 pages, Account Code is an optional field that is edited against the ACCT\_CODE\_TBL. In this component, the system identifies the company based on the department to which an employee is assigned. For example, Simon Schumacher is in department *10100*, which is associated with the company *CCB*.

Select the Job Data 2 tab and enter *8001* or *Simon Schumacher* in the search record dialog box to retrieve a CCB row, for which the company is defined in the department table. Here, you can see that Simon works in department *00001*, which identifies him as a CCB employee. If you click the prompt button next to the Account Code field, the system displays only those rows in the Account Code Table that are associated with USA, the setID for CCB.

Alternatively, if you access the job row for Joan Avery, an employee of VNB, and click the prompt button for the same Job Data 2 Account Code field, the system retrieves only values that are associated with CAN, the setID for VNB.





## Chapter 6

# Creating Record Definitions

## Understanding Record Definitions

Fields that are grouped together as a unit are *record definitions*. A record definition represents what the underlying SQL database tables look like and how they process data. Two tabs exist in record definitions.

Use the Record Fields tab to access the fields that compose the record definition.

### Image: Record Fields tab

This example illustrates the fields and controls on the Record Fields tab. You can find definitions for the fields and controls later on this page.

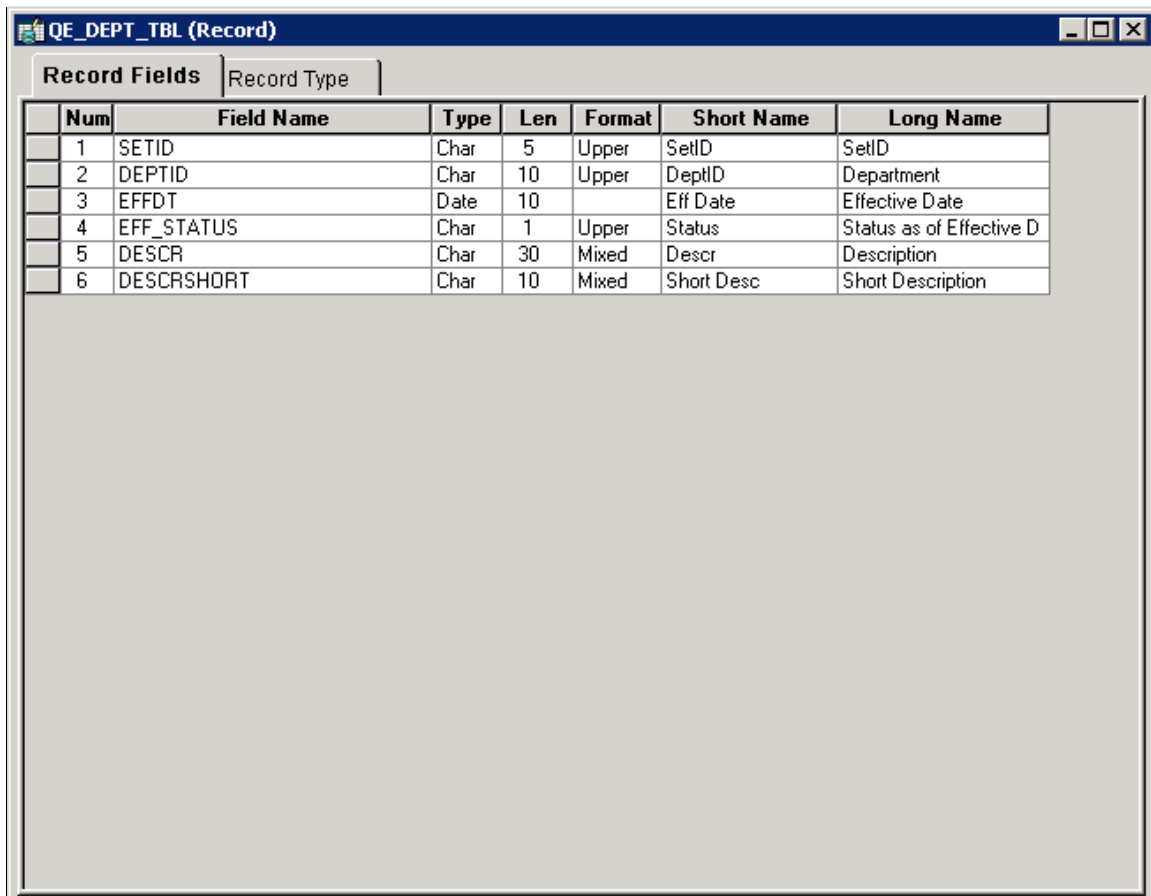

Num	Field Name	Type	Len	Format	Short Name	Long Name
1	SETID	Char	5	Upper	SetID	SetID
2	DEPTID	Char	10	Upper	DeptID	Department
3	EFFDT	Date	10		Eff Date	Effective Date
4	EFF_STATUS	Char	1	Upper	Status	Status as of Effective D
5	DESCR	Char	30	Mixed	Descr	Description
6	DESCRSHORT	Char	10	Mixed	Short Desc	Short Description

Use the Record Type tab to specify way that the record definition is to be used, for example a SQL table or view, or perhaps a temporary table.

### Image: Record Type tab

This example illustrates the fields and controls on the Record Type tab. You can find definitions for the fields and controls later on this page.

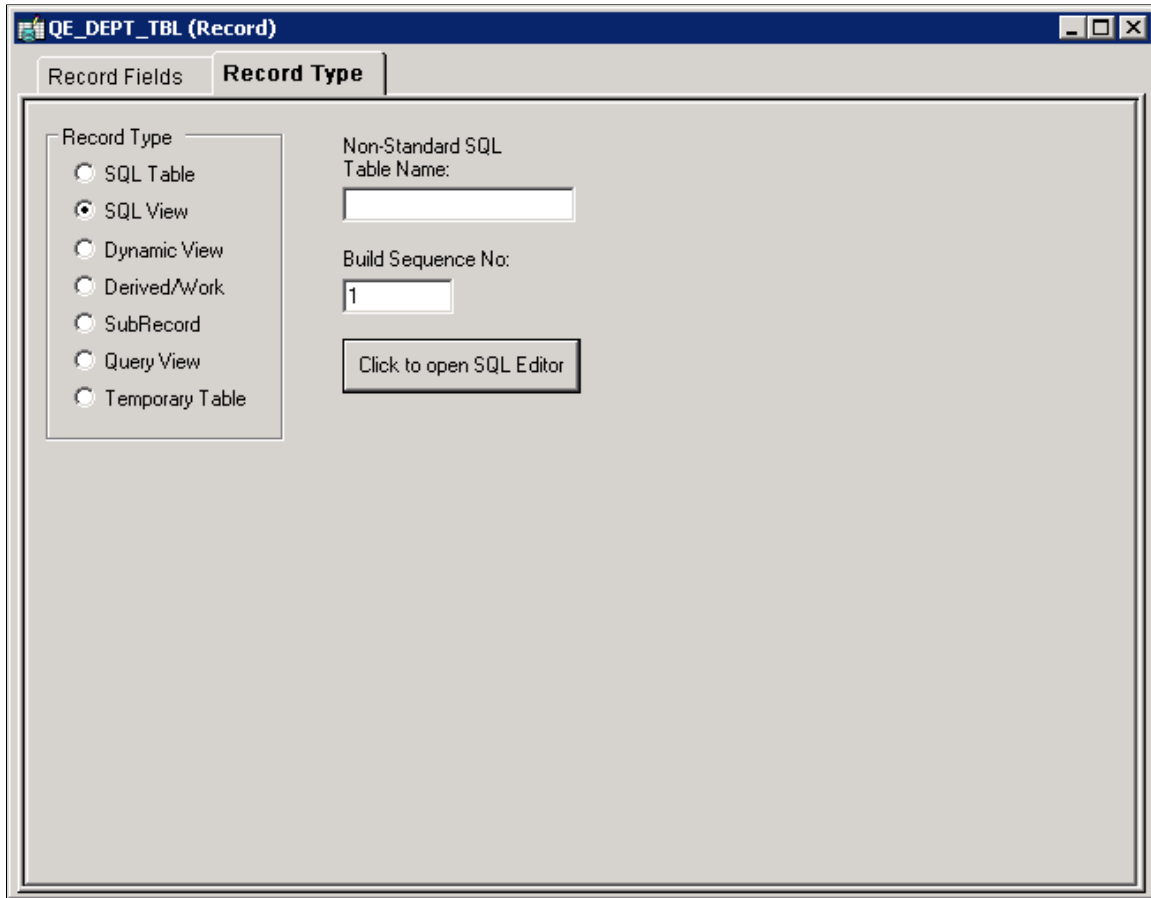

## Understanding Record Types

Select the Record Type tab to view the record definition types. Select from these types:

### SQL Table

Select to define a record definition that has a corresponding physical SQL table in the database. Create this table when you run the Build Operation from the Build menu. This value is the default setting.

### SQL View

Select to define a record definition that corresponds to a SQL view, which is not a physical SQL table in the database but fields from one or more SQL tables that are reorganized into a different sequence. SQL view provides an alternate view of information that is stored in tables.

To create the SQL view, click the Click to open SQL Editor button, enter a SQL Select statement, and then run the Build process.

See [Creating SQL View and Dynamic View Select Statements](#).

**Dynamic View**

Select to define a record definition that can be used like a view in pages and PeopleCode, but is not actually stored as a SQL view in the database. Instead, the system uses the view text as a base for the SQL Select that is performed at runtime. Dynamic views can provide superior performance in some situations, such as search records and in PeopleCode Selects, because they are optimized more efficiently than normal SQL views.

---

**Note:** Keys for dynamic views should not be effective date fields.

The dynamic view should contain only fields whose names exactly match the fields comprising the SQL query.

---

**Derived/Work**

Select to define the record definition as a temporary workspace to use during online page processing. A derived or work record is not stored in the database, so you do not build it.

**SubRecord**

Select to define the record definition as a subrecord: a group of fields that is commonly used in multiple record definitions and that you can add to other record definitions. This way, you can change a group of fields in one place, as opposed to changing each record definition in which the group of fields is used.

**Query View**

Select to define the record definition as a view that is constructed using the PeopleSoft Query tool. Before you can create the view, PeopleSoft Application Designer prompts you to save the definition.

**Temporary Table**

Select to define the record definition as a temporary table. You can specify temporary images of the table on the PeopleTools Options page. Use temporary tables for running PeopleSoft Application Engine batch processes. Temporary tables can store specific data to update without risking the main application table.

When creating a temporary table on an Oracle RDBMS, you have the option of creating a Global Temporary Table (GTT). Using GTTs can enhance Application Engine performance.

**Non Standard SQL Table Name**

Specify the SQL table name that you are defining to override the standard convention of prefixing PS\_ to the record name.

**Build Sequence No.**

This field is available when the record type is a SQL or Query view. Set the order in which the view is to be created. The default value is 1 when the record or view is initially created.

Views that must be created first can be set to 0, while views that you want created last can be set to any number from 1 to 99. The build sequence number is stored with the other details of the record or view in the database.

---

**Note:** The maximum valid entry for the sequence number is 99.

---

## Working with Global Temporary Tables

When building temporary tables on an Oracle database, you have the option of implementing Global Temporary Tables (GTT) for enhanced performance.

### Image: Record Type tab for Temporary Tables

This example shows the Record Type tab when creating a temporary table on the Oracle platform with the Global Temporary Table option displayed.

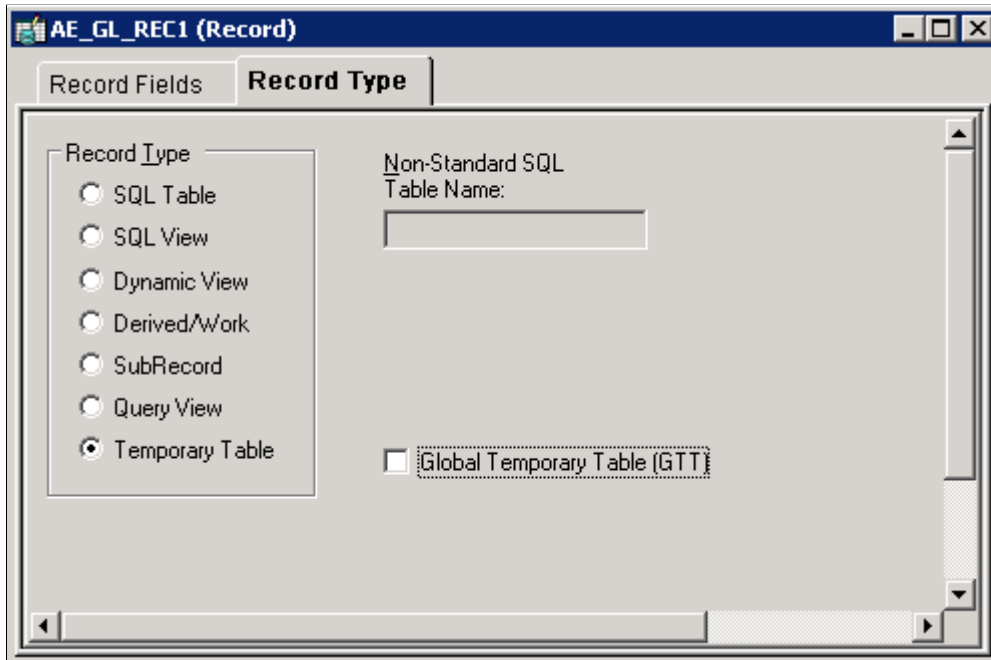

When building a GTT, using the Application Designer Build feature, the SQL generated to build the table appears similar to the following example:

```
CREATE GLOBAL TEMPORARY TABLE PS_QE_AETEST (PROCESS_INSTANCE
DECIMAL(10) NOT null,
QE_AE_INT_1 SMALLINT NOT null,
QE_AE_APPLID VARCHAR2(12) NOT null,
QE_AE_SECTION VARCHAR2(8) NOT null,
QE_AE_STEP VARCHAR2(8) NOT null,
JOB_INSTANCE DECIMAL(10) NOT null,
PROCESSINSTANCE INTEGER NOT null,
QE_RETURN_CD SMALLINT NOT null,
RUN_CNTL_ID VARCHAR2(30) NOT null,
AS_OF_DATE DATE NOT null,
QE_AE_SQLROWS INTEGER NOT null,
CURRENCY_CD VARCHAR2(3) NOT null,
ANNUAL_RT DECIMAL(18, 3) NOT null) ON COMMIT PRESERVE ROWS
TABLESPACE PTAPP
/
CREATE UNIQUE INDEX PS_QE_AETEST ON PS_QE_AETEST (PROCESS_INSTANCE)
/
```

---

**Note:** If you select the Global Temporary Table option, the temporary table name cannot exceed 11 characters.

---

**Note:** A Global Temporary Table must be assigned to the PSGTT $nn$  tablespace, where  $nn$  is the tablespace number (01, 02, and so on).

---

Global Temporary Tables are discussed in more detail in the product documentation for *PeopleTools: Data Management*. See "Improving Process Performance with Global Temporary Tables" (PeopleTools 8.58: Data Management). They are also discussed in the product documentation for *PeopleTools: Application Engine*. See "Understanding Global Temporary Tables" (PeopleTools 8.58: Application Engine).

## Working with Materialized Views

When building SQL views or query views on an Oracle database, you have the option of implementing a materialized view.

A materialized view acts as a database table that contains the results of a query. Once created, the data in a materialized view can be synchronized (automatically or manually) with its source information as needed with little or no programming effort.

A view has a logical existence, but a materialized view has a physical existence. All the characteristics and tasks that can be performed with a table can also be done with a materialized view. For example, a materialized view can be indexed, analyzed, and so on.

Materialized views are discussed in more detail in the product documentation for *PeopleTools: Data Management*. See "Using Materialized Views" (PeopleTools 8.58: Data Management).

### Image: Record Type tab for Materialized Views

This example shows the Record Type tab when creating a temporary table on the Oracle platform with the Global Temporary Table option displayed.

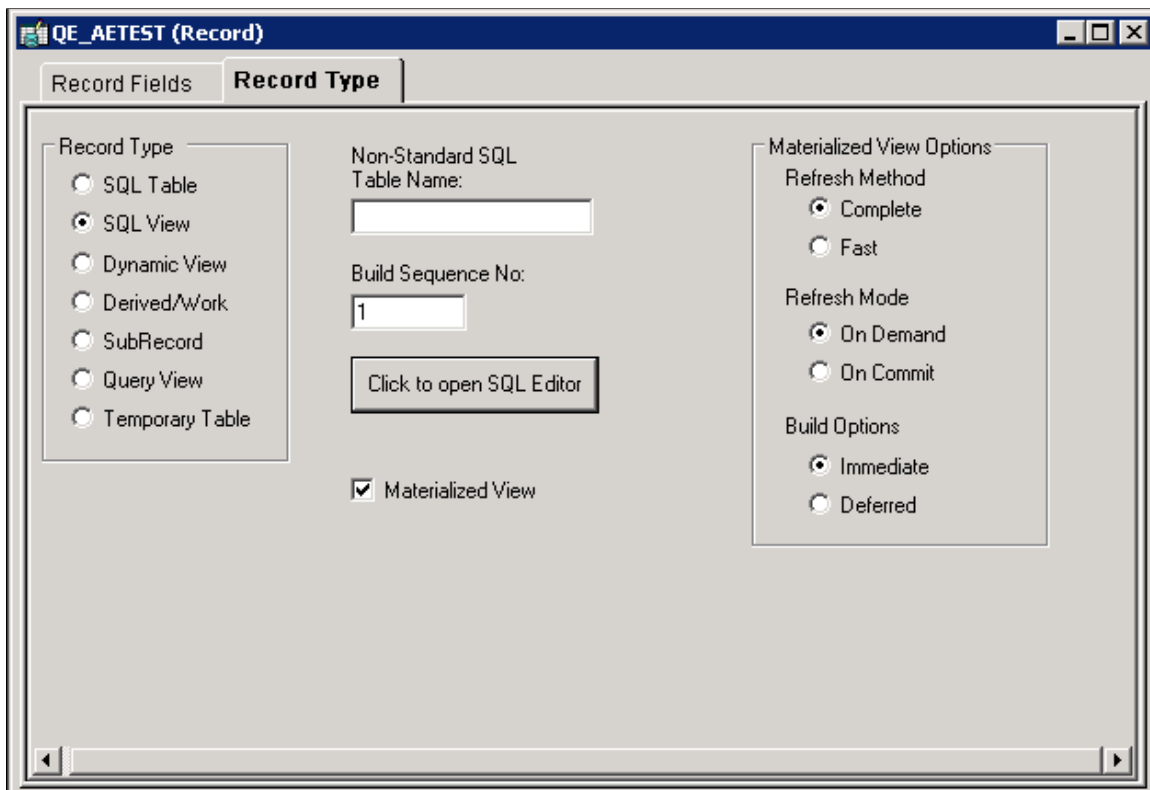

### Materialized View

Select to create a materialized view for Oracle database systems when SQL View or Query View is also selected. This option

is available only for Oracle systems. When selected, the Materialized View Options group box appears to the right.

## Materialized View Options

### Refresh Method

*Complete:* The materialized view table will be refreshed completely. (Default)

*Fast:* The materialized view table will be refreshed incrementally when running the Application Designer Build option.

### Refresh Mode

*On Demand:* Administrators refresh the view through Materialized View Maintenance page. (Default)

*On Commit:* During a commit, the Oracle system executes triggers and updates the materialized view log tables.

### Build Options

*Immediate:* The system creates the view and populates the view from the base tables. This may be time consuming depending upon the complexity of the view and data. (Default)

*Deferred:* The system creates the view but does not populate the view during the build process. An administrator must run a refresh from the Materialized View Maintenance page.

Materialized views are discussed in more detail in *PeopleTools: Data Management*. See "Using Materialized Views" (PeopleTools 8.58: Data Management).

Similar options exist for IBM Db2 for z/OS (Materialized Query Tables) and Microsoft SQL Server (Indexed Views).

## Related Links

"Working with Indexed Views" (PeopleTools 8.58: Data Management)

"Working with Materialized Query Tables" (PeopleTools 8.58: Data Management)

## Viewing Record Definitions

You can see four views of a record by selecting View from the main toolbar: Field Display, Use Display, Edits Display, and PeopleCode Display.

This section discusses how to:

- View basic field definitions.
- View key-related characteristics and default values.
- View editing options.
- View PeopleCode program types.
- Reorder fields.

- Size and sort columns.

## Common Elements Used in This Section

<b>Num</b> (number)	The number of the field in the order in which it is defined in the record.
<b>Field Name</b>	The name of the field in the SQL database.
<b>Type</b>	The data type of the field, such as character, number, or date.

## Viewing Basic Field Definitions

Field Display mode shows the basic field definition characteristics for fields in the record definition. Field definition characteristics are global: they affect all record definitions in which the field is used. To open the associated field definition, right-click it while in Field View and select View Definition.

<b>Len</b> (length) decimal precision setting for field definitions	Indicates the maximum length of the field, including decimal places.
<b>Format</b>	Notes special formatting for the field, such as mixed case, date, international phone number, or RawBinary.
<b>Short Name and Long Name</b>	Displays the short and long names of the field as users see them on pages.

## Viewing Key-Related Characteristics and Default Values

Use Display mode shows key-related characteristics and default values for fields that determine how fields are used in a record. The use characteristics might differ for fields that are used in more than one record definition. Double-click the field to access the Record Field Properties dialog box in which you define these parameters.

<b>Key</b>	Indicates whether the field is a key to the record definition. Key fields are included in an index that is automatically created during the table build process.  The word <i>Not</i> in this column indicates that this field cannot be used as a chart field. You can set this parameter only through PeopleCode using the SetDBFieldNotUsed function.  See "SetDBFieldNotUsed" (PeopleTools 8.58: PeopleCode Language Reference).
<b>Order</b> (order)	Indicates the order of key fields in the index. You can configure this order from the Index dialog box. It is reflected in this column.
<b>Dir</b> (direction)	Indicates the order in which the key field indexes are created in the database: ascending or descending.

<b>CurC</b> (currency control)	The currency format for this field is controlled by the currency code in another field.
<b>Srch</b> (search)	Indicates a search key, that is, a field for which one is prompted from a search record dialog box.
<b>List</b>	Indicates a list box item, that is, whether the values for the field appear in the search record list box.
<b>Sys</b> (system)	Indicates that the system generates and maintains the field.
<b>Audt</b> (audit)	Specifies whether additions, changes, or deletions to data in this field are written to the standard PeopleTools Audit Tables (PSAUDIT and PSAUDITEXT).
<b>InAutoComp</b>	Indicates that the field is used as an autocomplete field and appears in the autocomplete window.
<b>EnAutoComp for Srch Record</b>	Specifies whether autocomplete is enabled in a search record.
<b>Default</b>	Represents the default value that is used to initialize the field.

## Viewing Editing Options

Edits Display mode shows all editing options (edit as a validation rule) that are available for fields in a record. Edits on a field vary from one record definition to another. To define parameters, access the Record Field Properties dialog box by double-clicking the field.

<b>Req</b> (required)	Indicates whether the field is required. A user must enter a value before the record can be written to the database.
<b>Edit</b>	Specifies that the values for this field are validated against a table.  The translate table stores the codes and translate values:  <i>Y/N</i> (yes or no): Only two values, Y or N, are valid.  <i>Prompt</i> : Values reside in a designated prompt table.
<b>Prompt Table</b>	Indicates the prompt table for a field. When a user clicks the prompt button or presses the ALT+5 key combination on a page, the system retrieves the values that are stored in this table.
<b>Set Control Field</b>	If you plan to use the Table Sharing feature to add an additional high-level key to identify common sets of values and handle exception values, add the name of the key here. The set control field determines which set of values appears, based on how you define table sharing.
<b>Rs Dt</b> (reasonable date)	Specifies whether a reasonable date test is performed on a date field. All date fields are automatically edited to ensure that you can enter only valid values. The reasonable date test warns if the date is outside a 30-day range before and after the current date.



You can use this, among other tests, to guard against entering the wrong year in a date.

**Event**

Indicates whether any type of PeopleCode was added for this field. In addition, if PeopleCode was added, the field name will be boldface.

## Viewing PeopleCode Program Types

PeopleCode Display mode has a column for each PeopleCode program type. If a field contains a PeopleCode event, a check mark appears in the event type column. Double-click in a cell to launch the PeopleCode Editor. Note that fields containing PeopleCode are in bold in all display modes.

**Image: PeopleCode Display mode with PeopleCode Editor**

This example illustrates the fields and controls on the PeopleCode Display mode with PeopleCode Editor. You can find definitions for the fields and controls later on this page.

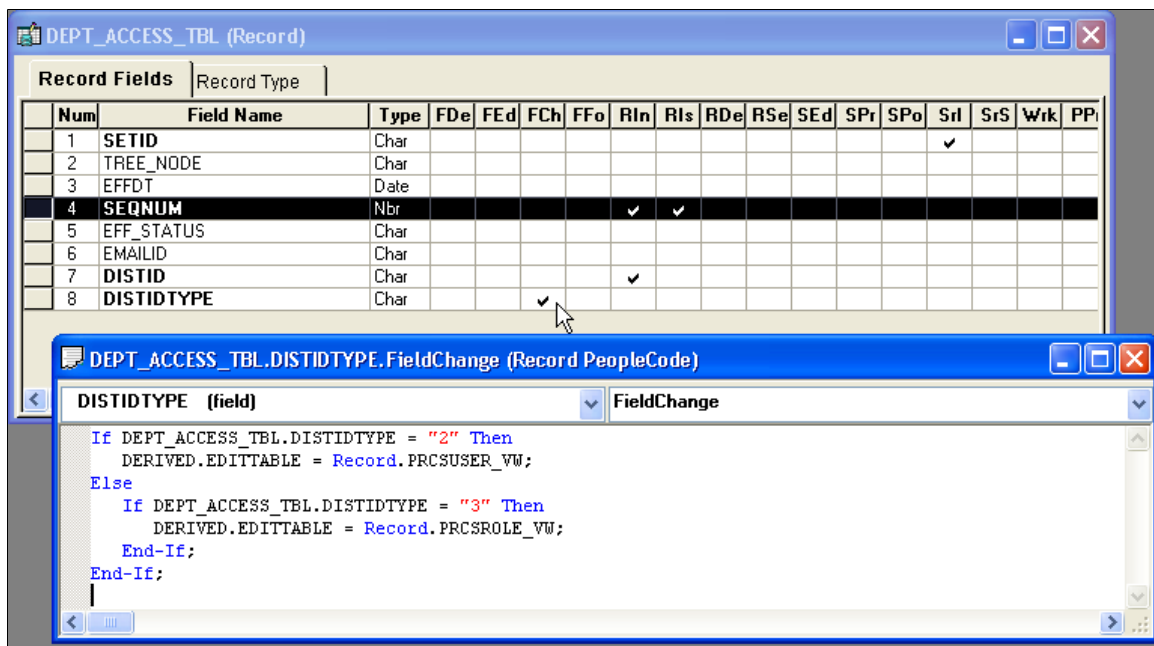

## Reordering Fields

You can reorder the appearance of fields in a record definition by double-clicking the attribute name. For example, if you double-click Field Name, the fields appear in alphabetical order; double-clicking Num returns the fields to their numeric order. This action does not change the order of the fields in the actual record. The numbers that the fields are originally assigned remain the same. This fact is important when it comes to key fields.

To actually reorder the fields in the records, you must cut and paste or select a field and move it.

## Sizing and Sorting Columns

You can change column lengths in any of the displays by dragging them to the appropriate size with your cursor. For example, you might make the short name column smaller so that the entire long name for each field appears. The default sizing of all columns returns after you close the record and reopen it.

You can also sort the rows in columns by double-clicking the column heading. For example, double-clicking the Num column heading returns the list of record fields to the default sort order.

---

## Saving Record Definitions

You should save your work every time you define a new record definition. As soon as you add or change one element in the new definition, save your work and name the record. You cannot save a record definition until you make at least one change to the record definition by changing record properties, adding or deleting at least one field, or changing the record field properties.

You cannot add PeopleCode to a field until you save the record definition.

To save a new record definition, select File > Save or File > Save As. If you have not named the definition, the system prompts you to enter a record name. The system also prompts you to set the tablespace using the Change Space dialog box.

See [Setting the Tablespace](#).

---

## Naming Record Definitions

Use these guidelines for record definition names:

- The name length can be up to 15 characters, with the exception of the Temporary Table type, which has a maximum length of 13 characters.
- The name must begin with a letter and can contain underscores to make it more readable.
- Avoid special characters, such as # or \$, which can cause problems in some database environments.

See [Saving Definitions](#).

### Record Naming Conventions

To help identify the purpose of different types of record definitions, you should adopt these naming conventions for record definition names and use these suffixes:

<b><u>TBL</u></b>	Identifies edit or prompt tables that contain data that is used for validation, as opposed to data that is maintained by the application. Prompt tables store commonly used values. They include, but are not limited to, control tables, which store company-wide values. For example, the location table (LOCATION_TBL) stores values for all operating locations
-------------------	---------------------------------------------------------------------------------------------------------------------------------------------------------------------------------------------------------------------------------------------------------------------------------------------------------------------------------------------------------------------

in which your company does business; the country table (COUNTRY\_TBL) stores values for all valid countries.

<b>_VW</b>	Identifies record definitions that are physically implemented by defining a SQL view.
<b>_DVW</b>	Identifies dynamic views.
<b>_WRK</b>	Identifies derived work records.
<b>_SBR</b>	Identifies subrecords.
<b>_QVW</b>	Identifies query views.
<b>_WL</b>	Identifies records as worklist record definitions.

In some cases, PeopleSoft also uses these prefixes to identify special types of record definitions:

<b>R_</b>	Identifies work record definitions for Structured Query Report reports. The remainder of the record name consists of the program or report ID.
<b>AUDIT_</b>	Identifies record definitions that store audit information for other record definitions in the database.
<b>WEBLIB_</b>	Identifies record definitions that store internet scripts. Internet scripts are generally located in FieldFormula PeopleCode events. You must grant access in the Security component for a WEBLIB record with an internet script before it can be run in a PeopleCode program.
<b>FUNCLIB_</b>	Identifies record definitions that contain written PeopleCode functions, as opposed to built-in functions. You can include these records in the component and call them as functions. These self-developed functions are generally located in FieldFormula events, and the records are usually derived.
<b>DERIVED_</b>	Identifies shared record definitions (across an application module or group) that have fields for PeopleCode events.

---

## Creating New Record Definitions

This section discusses how to create new record definitions.

To create a new record definition:

1. Select File > New.
2. Select Record.
3. Click OK.

The object workspace appears so that you can build a list of fields in a record definition.

4. Select the Record Type tab to define the type of record definition.

## Related Links

[Manipulating Fields in Record Definitions](#)

---

## Opening Existing Record Definitions

Open a record definition in the same way that you open other definitions in PeopleSoft Application Designer. In the open dialog box, you can narrow the search by selecting a record type or project. You can also open an existing record from the project tree view by double-clicking a record name.

---

## Manipulating Fields in Record Definitions

This section provides an overview of fields in record definitions and discusses how to:

- Insert fields into records.
- Insert subrecords into records.

## Understanding Fields in Record Definitions

You create record definitions by adding field definitions to a new record definition or by cloning and modifying an existing record definition. You can add fields in any order and reorder them at any time. Locate keys at the top of the record definition, in order of importance.

Each field has basic attributes that are shared across all records that contain the field. These field properties include data type, field name, long name, short name, field length (or integer and decimal positions), formatting, help context number, and translate values. If you change any of these attributes for a field, the change affects *every* occurrence of the field in every record definition. If the change is not appropriate for every occurrence of this field, consider defining a new field instead.

---

**Note:** Changing a field name or length requires modification of the underlying SQL table, either by running the SQL Build or SQL Alter menu items or by a system administrator action. For example, if you change a field length for one record definition and 30 other record definitions contain the same field name, then you must build or alter 31 records. If the records are all within one project, you can run the build process on the project instead.

---

## Inserting Fields Into Records

You can insert a field into a record in one of several ways:

- Using the project workspace tree.

To insert a field into a record definition directly from the project workspace by using the drag-and-drop method:

1. Locate a field using the PeopleSoft Application Designer project workspace tree.

2. Drag the field from the project workspace tree to the object workspace.

The field and its attributes are automatically added to the list of fields in the record definition.

- Using the Insert menu (Insert, Field).

Use the Insert, Field menu selection to search for fields with selection criteria, and then add them to the record using the Insert button. You can also double-click a selected field definition and select Insert the Field Definition. The system inserts the fields below the selected field in the record definition.

- Dragging fields from existing records.

To drag a field from one record definition to another:

1. Open a record that contains the fields that you need.
2. Select the field.
3. Drag the field to a new record.

## Inserting Subrecords into Records

Subrecords enable you to aggregate and configure a group of fields as a set, which you can then insert in multiple record definitions. All subrecord fields and configured properties propagate to the subsuming record definition.

You must define a subrecord before you can insert it into a record definition. You create and configure a subrecord as you do any record definition; however, you do not build subrecords because they are PeopleSoft structures, not standalone database structures. Select Insert > Subrecord... to search, select, and insert subrecords into a record.

### Viewing a Subrecord

Any open record in which a subrecord is inserted can have the subrecord expanded into the same record definition window by selecting View > Expand All Subrecords. After selecting this option, the parent record definition expands to show the fields in the subrecord. Subrecord fields are shaded.

When the subrecord is expanded, you cannot insert, cut, delete, paste, reorder, or sort fields. If you reordered the display of the fields, you cannot expand the subrecords.

The expanded subrecord fields are read-only, which means that you cannot change the properties of these fields. To access the properties, first open the subrecord. The shortcut to opening a subrecord is to click the expanded subrecord and select *View Definition*. This action opens a subrecord definition from which you can view the properties of the fields.

Collapse the subrecord by selecting View > Collapse All Subrecords.

## Nesting Subrecords

Nested subrecords are fully supported to any level. Expanding a record toggles the record field list to show all of the fields from all levels of nesting. Changes to subrecords are immediately reflected in expanded records.

## Editing PeopleCode in Subrecords

You can edit PeopleCode that is attached to a subrecord field by double-clicking the appropriate field as it appears in the expanded record. Any PeopleCode changes that you make apply to all records that contain that subrecord.

## Configuring Persist in Menu Properties

---

**Important!** Persistent search, the drop-down menu, and other forms of classic navigation are no longer supported. The default navigational interface for PeopleSoft applications in the current release is based on the fluid banner, which can be used for both classic and fluid applications.

---

All Persist in Menu properties that you explicitly define on record fields in subrecords propagate to all subsuming record definitions. When you configure custom persistent search fields, the Persist in Menu properties in both the subrecord and its subsuming records are counted toward the maximum number of persisted fields. Selecting the Persist in Menu property for record fields in a subrecord that is already being used by other record definitions displaces any lower order fields that, as a result of the subrecord reconfiguration, are beyond the five-field maximum.

See [Configuring Search Results Grid Columns in Persistent Searches](#).

---

## Setting Record Properties

After you create a record definition, you will want to apply attributes so that the record functions. Access the dialog box by selecting Record Properties, and then select either the General tab or the Use tab. This section discusses how to:

- Set general properties.
- Set use properties.
- Create user-defined audit record definitions.

## Setting General Properties

Access the Record Properties, General tab.

### Description

Enter a descriptive name for the record.

### Record Definition

Enter appropriate comments in this area, including details about the record type, use, parent and child relationships, or other information that is important to other application designers.

<b>Owner ID</b>	Displays a list of applications with which this record is used. This list is helpful to identify the applications with which the record is associated during application development.
<b>Last Updated</b>	Displays the date and time of the last modification that was made to the record and the name of the user who made the modification.

## Setting Use Properties

Access the Record Properties, Use tab.

These properties control the way the record definition is used in the system.

Specify the field with which the system maps between the original key and the tablesets in the Set Control Field drop-down list box.

See [Defining Set Control Fields](#).

## Record Relationship Settings

**Parent Record** If this is a subordinate or child record, specify the parent record.

**Related Language Record** Specify a related language record:

- The master record definition, which contains the appropriate key and non-key field definitions.
- A clone of the master record definition, to which you add an additional key for language code.

This is the related language record definition. This definition should contain only those non-key fields for which contents vary by language. Link the two record definitions by specifying the name of the related language record definition in this field on the master record definition.

At runtime, the system checks the user's language preference and retrieves the data value from the appropriate related language record definition.

**Query Security Record** Specify a query security record if you want secure access to a record using a security view.

**Advanced Query Security** Click to display Advanced Query Security Record Mapping dialog box, which you can use to specify multiple query security records. Using multiple query security records is described in more detail in the product documentation for *PeopleTools: Query*. See "Using Row-Level Security and Query Security Record Definitions" (PeopleTools 8.58: Query).

**Analytic Delete Record** Specify a delete record to use for optimization.

**Record Name** Specify the user-defined audit record.

## Audit Options

While you can audit individual fields at the field level, you might find it more efficient to have the system audit the entire row whenever a user adds, changes, or deletes information. For record-level audits, the system focuses on rows of data instead of specific fields. Consequently, a record-level audit writes a single row of audit data rather than writing multiple rows for each insert, change, or delete transaction at the field level.

<b>Add</b>	Inserts an audit table row whenever a new row is added to the table underlying the record definition.
<b>Change</b>	Inserts one or two audit table rows whenever a row is changed in the table underlying this record definition.
<b>Selective</b>	Inserts one or two audit table rows whenever a field that is also included in the record definition for the audit table is changed.
<b>Delete</b>	Inserts an audit table row whenever a row is deleted from the table underlying the record definition.

## Record-Level Auto-Update Options

These settings are used exclusively for mobile applications, enabling developers to display derived values on a mobile page. These settings are not available for subrecords.

---

**Important!** PeopleSoft Mobile Agent is a deprecated product. These features exist for backward compatibility only.

---

<b>System ID Field</b>	Set this field to assign a unique way to identify the record for mobile synchronization purposes. You must create a user-defined index for this field.
<b>Timestamp Field</b>	Set this field to automatically update the field with the date and time when there is a change to the record for mobile synchronization purposes.

## Record Information

Record Information contains options used during PeopleSoft upgrades.

<b>Tools Table</b>	Identifies SQL tables owned by PeopleSoft PeopleTools development, which is typically the same ownership as indicated by the PPLTOOLS project.
<b>Managed</b>	Identifies SQL tables owned by PeopleSoft PeopleTools development that contain information that is used by managed (cached) objects.



**Append ALL (Dynamic Views)**

Applies to dynamic views. If it is set, then at runtime the system appends the WHERE clause generated at runtime to all the SELECT statements in a dynamic view with a UNION.

Also, if it is set, at runtime the system generates FILL as the table alias in the WHERE clause condition. For example, FILL.<record field name> LIKE '%O%'. You need to specify which table corresponds to the FILL in the dynamic view definition.

For example, FROM table A FILL. You must specify the corresponding table because the same record field name may exist in two different records.

**Oracle In Memory**

These settings apply *only to the Oracle database*, beginning with Oracle 12c. Use these settings to implement Oracle In-memory Column Store (IM column store) technology with your PeopleSoft system.

For more information on the Oracle In Memory feature, see "Working With Oracle Database In-Memory" (PeopleTools 8.58: Data Management).

**All Fields**

Select if you want all fields in the record definition to be stored in the IM column store.

When selected, the system prepares all record fields to become part of the IM column store, except for those fields which are not supported for IM operations. That is, the In Memory check box will be enabled and selected for all record fields in the record definition where the record field is supported for IM column store processing.

IM column store technology does not support these data types:

- LONG VARCHAR
- LONG RAW
- Out-of-line columns (LOBs, VARRARYs, nested table columns)
- Extended data type columns

---

**Note:** If you select All Fields, and the table contains any fields with a data type that is not supported for IM processing, the system will change your selection to Selective Fields upon Save. Only the record fields that are supported for IM column store processing will have the In Memory check box selected automatically by the system in the record field properties.

---

**Note:** If All Fields is selected, and the record definition contains fields that are not supported for IM column store processing, those fields will be explicitly excluded from the build process DDL.

---

**Selective Fields**

Select if you want to choose individual fields to include in IM column store processing. Once selected, the In Memory check box becomes enabled on the Record Field Properties, Use tab for all record fields supported for IM column store processing.

For more information on the In Memory record field property, see [Setting Record Field Use Properties](#).

---

**Note:** After selecting any Oracle In Memory options, you must alter the table in order for the feature to take effect. See [Specifying Alter Options](#).

---

**Creating User-Defined Audit Record Definitions**

To audit at the record level, you must create a record definition and SQL table in which you store audit information. When you create a new audit record definition, name it with an *AUDIT\_* prefix. Some processes, such as the Employee ID Change and Employee ID Delete processes in the PeopleSoft Human Resources Management product line, change fields, such as EMPLID. These processes do not affect record definitions that begin with the *AUDIT\_* prefix, leaving your audit data secure.

The easiest way to create an audit table is to open the record definition that you want to audit and save it as a new record definition, prefaced with *AUDIT\_*. Audit record definitions cannot contain key fields. Therefore, if you clone a record definition to create an audit record definition, you must remove all key attributes.

You should also use the audit-specific fields that are already defined for the PeopleTools audit tables (PSAUDIT and PSAUDITEXT), which the PeopleSoft application uses to track field-level audits. Place these audit fields at the top of the audit record definition, as you would keys. If you are creating several user-defined audit record definitions, you might consider creating and using a subrecord definition with these audit fields instead of adding them individually to each audit record definition.

This table lists audit field names and their purpose:

<b>Audit Field Name</b>	<b>Purpose</b>
AUDIT_OPRID	Identifies the user who caused the system to trigger the audits, either by performing an add, change, or delete to an audited field.
AUDIT_STAMP	Identifies the date and time the audit was triggered.  <b>Note:</b> If there is a possibility that multiple audit rows would be generated within the same second or millisecond, then AUDIT_STAMP must be set as a duplicate key.

<b>Audit Field Name</b>	<b>Purpose</b>
AUDIT_ACTN	<p>Indicates the type of action that the system audited. Possible actions include:</p> <ul style="list-style-type: none"> <li>• A: Row inserted.</li> <li>• D: Row deleted.</li> <li>• C: Row changed (updated), but no key fields changed. The system writes existing values to the audit table.</li> <li>• K: Row changed (updated), and at least one key field changed. The system writes existing values to the audit table.</li> <li>• N: Row changed (updated), and at least one key field changed. The system writes new values to the audit table.</li> </ul>
AUDIT_RECNAME	Identifies the name of the record definition that was audited.

In most cases, you should include AUDIT\_OPRID, AUDIT\_STAMP, and AUDIT\_ACTN. The AUDIT\_STAMP must be given the attribute AUTOUPDATE. You might also add AUDIT\_RECNAME if you are creating an audit table to audit more than one record definition.

---

**Note:** Select the Auto-Update check box in the Record Field Properties dialog box; otherwise, the audit record does not receive a date and time stamp.

---

## Setting Record Field Properties

This section provides overviews of record field properties and record key considerations, and discusses how to manage record fields.

### Understanding Record Field Properties

When you add a field to a record definition, you must define attributes for how the field is used in that record. These attributes include key settings, default values, table edits, and PeopleCode programs.

The properties of record fields are not shared among records; they are specific to a single record definition and are stored with the record. Therefore, even though you might add the same field to multiple records, each record stores a unique set of record field properties, while the primary field definition remains the same.

When you access field properties from within a record definition, you set the record field properties, not field definition properties or record definition properties.

To edit record field properties from a record definition, select the record field, then select Edit > Record Field Properties from the PeopleSoft Application Designer menu. You can also double-click a record field to set the properties.

## Understanding Record Key Considerations

When creating key fields in your record definition, keep in mind several guidelines that are discussed in the following topics.

### Records With Multiple Keys

You can specify more than one field as a key to a record definition; that is, a record definition can have a compound key. This example shows a compound key structure:

**Image: Example of a compound key structure in the PO\_LINE record definition**

This example illustrates the fields and controls on the Example of a compound key structure in the PO\_LINE record definition. You can find definitions for the fields and controls later on this page.

Num	Field Name	Type	Key	Ordr	Dir	CurC	Srch	List	Sys	Audt	InAu	EnAuto	Default
1	BUSINESS_UNIT	Char	Key	1	Asc		Yes	Yes	No		No	No	
2	PO_ID	Char	Key	2	Desc		Yes	Yes	No		No	No	
3	LINE_NBR	Nbr	Key	3	Asc		Yes	Yes	No		No	No	
4	STATUS	Char					No	No	No		No	No	
5	INV_ITEM_ID	Char	Alt		Asc		No	Yes	No		No	No	
6	CATEGORY_ID	Char					No	No	No		No	No	
7	UNIT_OF_MEASURE	Char					No	No	No		No	No	

The keys to the PO\_LINE record definition are BUSINESS\_UNIT, PO\_ID, and LINE\_NBR. Therefore, each purchase order must be unique to a business unit, and each line item in a purchase order must have a unique number.

### Keys in Parent and Child Tables

In some cases, you have a field in a table for which you want to allow multiple occurrences, in which case you create a subordinate or child table. For example, for employee reviews, an employee can be reviewed for performance in multiple categories—organization skills, interpersonal skills, and so on. These categories and ratings are stored in a separate child table, EE\_REVIEW\_RT, which is directly related to REVIEW\_DT, the parent table that stores information about employee reviews.

The keys that you establish in a parent record definition determine which keys are required in child record definitions. The child must have the same keys as the parent, plus one or more keys that uniquely identify each row:

<i>Item</i>	<i>Parent Table</i>	<i>Child Table</i>
Record Definition	REVIEW_DT	EE_REVIEW_RT
Key Fields	EMPLID REVIEW_DT	EMPLID REVIEW_DT CATEGORY

Most record definitions have either one primary key, or multiple keys that comprise independent, or parent and child key combinations. Exceptions exist, however, such as record definitions without keys and duplicate order keys.

## Records Without Keys

Some record definitions, such as INSTALLATION, do not require keys because only one row of data exists in the table. Whereas a table normally has keys to help distinguish between multiple occurrences of data, when a table has only one row of data you do not need to distinguish one row from another. Another primary use for keys is to build database indexes to rows; because each table has only one row, the record does not need indexes. This example shows a record definition with no defined key structure:

**Image: INSTALLATION table: example of record definition with no defined key structure**

This example illustrates the fields and controls on the INSTALLATION table: example of record definition with no defined key structure. You can find definitions for the fields and controls later on this page.

Num	Field Name	Type	Key	Ord	Dir	Cur	Srch	List	Sys	Audt	InAu	EnAuto	Default
1	COMPANY	Char					No	No	No		No	No	
2	MIN_STD_HRS	Nbr					No	No	No		No	No	
3	MAX_STD_HRS	Nbr					No	No	No		No	No	
4	STD_HRS_DEFAULT	Nbr					No	No	No		No	No	'40'
5	TEMP_SSN_MASK	Char					No	No	No		No	No	'999'
6	COMMIT_AFTER	Nbr					No	No	No		No	No	'300'
7	POSITION_MGMT	Char					No	No	No		No	No	'N'
8	COUNTRY	Char					No	No	No		No	No	
9	COMP_FREQUENCY	Char					No	No	No		No	No	'M'
10	EMPLID_LAST_EMPL	Nbr					No	No	No		No	No	
11	EMPLID_LAST_APPL	Nbr					No	No	No		No	No	
12	NON_EMPLOYEE_LAST	Nbr					No	No	No		No	No	

## Records With Duplicate Order Keys

Occasionally, you might encounter situations in which a unique identifier for each row does not exist. *Duplicate order keys* are a way of ordering data in the table when duplicate values are allowed.

For example, in the EDUCATION table, PeopleSoft developers anticipated that an employee can receive two degrees of the same type on the same date. For example, though rare, Simon Schumaker could receive two honorary degrees in computer science on the same day. Because no unique identifier exists—the employee ID, date earned, and degree are all the same—the user must maintain the data differently. The key, instead of defining a unique row, defines a group of rows. In that group, you must determine the order in which you want to display the information.

In the EDUCATION record definition, three keys together determine how information is stored and retrieved. EMPLID identifies the group of rows; and the placement of the duplicate order keys, DT\_EARNED and DEGREE, instructs the system to order rows in the group first by date and then by degree:

<b>EMPLID</b>	<b>DT_EARNED</b>	<b>DEGREE</b>
8001	June 1, 1992	HON
	June 1, 1992	HON

The system concatenates or joins keys when it checks for uniqueness. In this case, the system accepts duplicate entries in the DEGREE and DT\_EARNED fields because they are part of a set that is identified by EMPLID.

---

**Note:** Records with duplicate order keys should not have related language tables associated to them. If the record requires a related language record, you must remove the order keys. Do not create a related language record with a duplicate order key.

---

**Note:** If you intend to perform data integrity validation on your record data when the system performs a save, don't use duplicate order keys on your record. With duplicate order keys, the system cannot ensure a unique row of data for validation.

---

**Note:** If you create a duplicate order key on a record, you see a warning message when you save the record. During runtime, there is more information written to the log file. Use the Set Trace Flags option Component Buffers Before Save, and search for more information in the log file.

---

## Ordering Keys

The position of keys relative to one another is critical in a record definition; always list them in order of importance. The primary key must be the first field in the record, followed by the next most important key, and so on.

Key fields are followed by duplicate order keys, in order of importance, and then by fields that are not keys. You can scatter alternate key fields anywhere among regular fields, in any order. They do not need to be grouped.

Key, Duplicate Order Key, and Alternate Search Key are mutually exclusive.

---

**Note:** The display of key fields in record definition views does not always match the order in the record. Always check the Num column to see the actual order.

Each alternate search key that you configure creates a database index when the SQL creates the table. While database indexes are important, they consume disk space and, when the system must support the alternate key, processing time. Therefore, do not add alternate search keys unless you really need them. For both records and subrecords, you can only add 10 alternate search keys.

---

## Setting Record Field Use Properties

As you add fields to a record definition, you must decide which fields uniquely identify each row; these become the record keys. The nature of the data that you are storing should naturally determine the keys for the information in the database.

The record field properties options that are available for field types might vary slightly; for example, some of the properties that you assign might be relevant only to a character field in a record and not to a date or time field. However, all of the options are described in this section. This example shows the available record field properties options:

**Image: Record Field Properties dialog box: Use tab**

This example illustrates the fields and controls on the Record Field Properties dialog box: Use tab. You can find definitions for the fields and controls later on this page.

**Record Field Properties**

Use **Edits**

Field Name: PSIMAGEVER

**Keys**

- Key
- Duplicate Order Key
- Alternate Search Key
- Descending Key
- Search Key
  - Search Edit
- List Box Item
- From Search Field
- Through Search Field
- Default Search Field
- Disable Advanced Search Options
- Allow Search Events for Prompt Dialogs

**Audit**

- Field Add
- Field Change
- Field Delete

System Maintained

Auto-Update

In Memory

Record Field label ID  
 \*\*\* Use Default Label \*\*\*

Default Value  
 Constant:   
 or  
 Record Name:   
 Field Name:

Currency Control Field

Default Page Control

Autocomplete Configuration  
 Enable Autocomplete when used in Search Record

Persist in Menu Configuration  
 Persist in Menu

OK Cancel

**Keys****Key**

Select to identify the field as the search criteria that uniquely identifies each row. You cannot have duplicate values for primary keys. For example, EMPLID is the only key to the PERSONAL\_DATA record definition. Therefore, EMPLID must be a unique value for each employee, and only one PERSONAL\_DATA row can exist per employee.

**Duplicate Order Key**

Select to indicate that duplicate values can occur. The order in which you place duplicate order keys in a field list determines the order in which the system retrieves duplicate keys.

**Alternate Search Key**

Select to make this field part of the search structure when accessing your application data. Duplicate values are allowed in an alternate search key field.

If you define a field as an alternate search key in a search record or prompt record, the system includes the field on the dynamically generated search page or prompt lookup dialog box that you use to enter search criteria.

**Descending Key**

---

**Note:** This option no longer produces an index with descending order.

---

Select to identify the field as descending if you want rows of data to be retrieved in reverse alphanumeric order (for example, 3, 2, 1). If you deselect this check box, the key is ascending, meaning that rows are stored and retrieved in alphanumeric order (for example, 1, 2, 3). This option applies only to a field that is specified as a key, duplicate order key, or alternate search key. PeopleSoft applications use descending order primarily for effective date fields; most character keys are ascending.

**Search Key**

Select to make the field available for entering search criteria on the basic and advanced search pages, the lookup prompt pages, and as a column that is stored in the menu structure for persistent searches. A search key is valid only for keys and should be used only in search and prompt records. If you select this check box, the system automatically selects the List Box Item check box.

---

**Important!** Persistent search, the drop-down menu, and other forms of classic navigation are no longer supported. The default navigational interface for PeopleSoft applications in the current release is based on the fluid banner, which can be used for both classic and fluid applications.

---

**Search Edit**

Enabled only if Search Key is selected. Select to enforce the required property and table edits on the search page. It also enforces these edits under circumstances in which the search page would be bypassed. When this option is enabled, the user no longer has the ability to perform partial searches on this field.

**List Box Item**

Select to include the field as a column in the search results grid on:

- Standard component search pages. The system includes *all* fields designated as list box items in the search results list.
- Prompt lookup pages. The system includes *all* fields designated as list box items in the search results list.



- Recent (persistent) search results pages. The system includes *no more than five* list box items in the search results list.

---

**Note:** This behavior is the default. To explicitly define which fields appear in the recent (persistent) search results, you must set other configuration options.

---



---

**Important!** Persistent search, the drop-down menu, and other forms of classic navigation are no longer supported. The default navigational interface for PeopleSoft applications in the current release is based on the fluid banner, which can be used for both classic and fluid applications.

---

See "Configuring Caching" (PeopleTools 8.58: Portal Technology).

See [Configuring Search Results Grid Columns in Persistent Searches](#).

If the field has values in the translate table and you designate it as a list box item, the list box automatically shows the translated value instead of the code.

If you select this check box, the system enables but does not select the Persist in Menu check box.

### **From Search Field and Through Search Field**

Select for fields that are used as search records. If you select From Search Field, the displayed list contains rows in which the field value is greater than or equal to a value that the user enters. If you select Through Search Field, the displayed list contains rows in which the field value is less than or equal to a value that the user enters.

If you do not want these fields to be in a search list box, clear the List Box Item check box, even if the field is an alternate search key.

### **Default Search Field**

Select to control which field name appears in the Search By drop-down list box on the basic search page.

### **Disable Advanced Search Options**

Select to prevent runtime search pages from displaying advanced search features for this field.

### **Allow Search Events for Prompt Dialogs**

Select to enable the SearchSave and SearchInit PeopleCode events on a prompt dialog for this field. The default value is *Cleared*.

---

**Note:** Limit your use of these events in this context. The amount and complexity of the PeopleCode affects the speed of data retrieval.

---

## Audit

Field-level auditing captures updates to selected fields and records the information in PeopleTools audit tables.

Audit options apply *only* to data that is manipulated on a normal PeopleSoft application page through component processing. These options do *not* apply to data that is added using means other than component processing, including *SQLExec*, *Record.Insert*, or *Record.Update* PeopleCode.

PSAUDIT and PSAUDITEXT are the standard PeopleTools audit tables for field-level audits. Both audit tables log identical information such as the user ID, time of change, and so on as well as the values of audited fields both before (OLD) and after (NEW) any changes.

Note these differences in the field properties of the two audit tables:

- In the PSAUDIT table, the field length of the OLDVALUE and NEWVALUE fields is 65 characters.
- In the PSAUDITEXT table, the field length of the PTOLDVALUE and PTNEWVALUE fields is 254 characters.

If you are auditing a field with a field length greater than 65 characters, you should query PSAUDITEXT to retrieve the field value.

---

**Note:** If a value is too long to fit in the audit table, the system writes an error to the appserv.log, and no row will be inserted into the audit table. This applies to the OLDVALUE and NEWVALUE fields in PSAUDIT and the KEY1-KEY15 fields in both PSAUDIT and PSAUDITEXT.

---

You can control when the fields are audited. For example, you can only record changes or deletions, depending on business requirements. To audit several fields in a record definition, consider specifying audits at the record definition level.

<b>Field Add</b>	Audits this field whenever a new row of data is added.
<b>Field Change</b>	Audits this field whenever the content changes.
<b>Field Delete</b>	Audits this field whenever a row of data is deleted.

## Miscellaneous

<b>System Maintained</b>	Select to indicate that the field value is system-generated. This option is for documentation purposes only and does not affect processing.
<b>Auto-Update</b>	Select to have the field updated with the server's current date and time whenever a user creates or updates a row. Any user entries—even if permitted on a page—are overwritten by the server time.

## In Memory

<b>In Memory</b>	Select to enable the Oracle In-Memory Column Store feature for this record field.
------------------	-----------------------------------------------------------------------------------

This check box is enabled only if the Oracle In-Memory option Selective Fields is selected for the record definition to which the record field belongs, *and* the field is supported for Oracle IM column store processing.

If the Oracle In Memory option All Fields is selected for the record definition to which the record field belongs, and all the fields for this record definition are supported for IM column store processing, the In Memory check box for the record fields will be selected automatically and greyed out (disabled).

---

**Note:** If a field is not supported for IM column store processing, the In Memory check box will be greyed out (disabled) and cleared automatically.

---

For more information on implementing the Oracle In-Memory Column Store feature, see [Setting Use Properties](#).

## Record Field Label ID

Specify which label, long name or short name, to use for the record. The default value is *\*\*\*Use Default Label\*\*\**. This setting enables you to change labels of record fields dynamically anytime that the default label on the field definition is changed.

For example, a field definition has three labels:

- Label1 (Long Name1, Short Name1), marked as default.
- Label2 (Long Name2, Short Name2).
- Label3 (Long Name3, Short Name3).

When the label ID in a record field is set to *Use Default Label*, initially the long name and short name are Long Name1 and Short Name1. If the default label is changed to Label3 in the field definition, then the long name and short name automatically become Long Name3 and Short Name3.

## Default Value

Select the most commonly used value as the default. You can always enter a different value if the default is inappropriate. The more defaults that you provide, the more data entry time you will save your users.

For a field, you can enter a default value as a system variable or as a combination of record and field names.

### Constant

Specify a default value.

This value is case-sensitive. If the record has translate values for this field, the values appear in a drop-down list.

You can specify a system variable only when you want to display the value of the current date or time. The accepted system variables to be used as constants are:

- %Date for Date, Time, Or Datetime fields. Returns a Date value.
- %Time for Time fields.
- %DateTime for Datetime fields.
- %ClientDate for Date, Time, Or Datetime fields. Returns a Date value.

**Record Name and Field Name**

Enter the record and field names of the default value.

**Default Page Control**

Specify the default appearance of a field as it appears on the page that corresponds with the record field that you are creating.

**Currency Control Field**

Enables the user to specify where to find the currency code that is used to display the currency symbol, decimal digits, and scale of a number field. To use this option, the multi-currency option must be set. You might also want to enable the current display when you define the field on the page.

**Autocomplete Configuration**

---

**Note:** Autocomplete is sometimes referred to as “type ahead.”

---

**Disable Autocomplete for this field**

Select to disable the autocomplete process for this field at runtime.

---

**Note:** If selected, the end user cannot personalize autocomplete settings for this field.

---

This setting enables you to control the autocomplete process for certain fields at design time. For example, in some cases, the autocomplete process for a field may be unnecessary or it may present undesired performance impacts.

**Enable Autocomplete when used in Search Record**

Select to make this field appear as a column in the autocomplete list when the containing record is used as a search record.

This field is enabled for character, number, and signed number fields if the following conditions are met:

- The Default Page Control field value is *Edit Box* or *System Default*.
- The field is a search key or an alternate search key.

**Persist in Menu Configuration**

---

**Important!** Persistent search, the drop-down menu, and other forms of classic navigation are no longer supported. The default navigational interface for PeopleSoft applications in the current release is based on the fluid banner, which can be used for both classic and fluid applications.

---

## Persist in Menu

Select to explicitly include the field as a column in the search results grid of a *persistent* search; select *only* if the field does not appear in the search results grid by default.

The Search Key and List Box Item properties determine which columns appear in the search results grid by default.

You must enable recent search results caching at the system level in the web profile for this property to take effect.

See [Setting Record Field Properties](#).

See "Configuring Caching" (PeopleTools 8.58: Portal Technology).

---

**Important!** If you select this check box for *any* record field in a search record, then the search results grid uses this property—not the list box item property—to determine *all* fields that appear in the grid. Consequently, you must select the Persist in Menu check box for each record field that you want to include in the search results grid.

---

See [Configuring Search Results Grid Columns in Persistent Searches](#).

## Time Zone and Related Date Fields

These fields are enabled only if the current field is a time or date and time field. They determine whether the field is displayed or entered in a specified time zone.

### Specified Time Zone

Times are always stored in a database base time zone, but when you place a time field on a page, you can display the time in the base time zone or another time zone.

If you deselect this check box, the time appears in the database base time zone. If you have users in multiple time zones, you can reduce confusion by showing the time zone along with the time.

If you select this check box, the system converts the time according to the time zone specified in Time Zone Control field. This control field must be a field in the current record. Set an appropriate default value for the time zone control field.

### Date Control Field

Select which related date field in the current record stores the calendar date to which this field should be adjusted.

Typically, you want to make a date field a descending key so that the row with the latest and most current time appears first. If you want the default value to be the current system date, enter the value `%date` (or `%time`) as the constant in the Default Values group box.

In general, each Time record field that is related to the Time Zone field should also be related to a Date field in that same record. Otherwise, the time data that appears or is saved may not properly reflect the appropriate state of daylight savings in that time zone. Furthermore, each Time record field should be associated with a *different* Date record field.

For applications where two Time record fields need to share a common Date record field (as in, records with a start time and an end time *always* occurring on the same date), you can relate each Time record field to the same Date record field. However, keep in mind that the Date record field will only consider itself associated with *one* Time record field—the related Time record field that has the earliest position in the record field ordering for that record.

### Related Links

"Using Autocomplete to Suggest Valid Values" (PeopleTools 8.58: Applications User's Guide)

"Setting Autocomplete Options" (PeopleTools 8.58: Applications User's Guide)

## Configuring Search Results Grid Columns in Persistent Searches

---

**Important!** Persistent search, the drop-down menu, and other forms of classic navigation are no longer supported. The default navigational interface for PeopleSoft applications in the current release is based on the fluid banner, which can be used for both classic and fluid applications.

---

The Persist in Menu property enables you to override the default fields that appear on the persistent search page and explicitly determine which fields the system includes in the search results grid. If you select the Persist in Menu property for *any* record field in the search record, then you must select the same property for *each* field, including search key fields, that you want to appear as columns in the search results grid.

---

**Note:** This property, when selected, controls the appearance of the persistent search results grid. Search key fields remain in the menu structure but are hidden from view.

---

To explicitly define the fields that appear in the results grid for a recent (persistent) search:

1. Open the search record.
2. Double-click the field you want to include in the results grid and select the List Box Item check box to enable the Persist in Menu check box.
3. Select the Persist in Menu check box for the field.
4. Click the OK button.
5. Double-click each additional field that you want to include and repeat Steps 2 and 3.
6. Save the record.

---

**Note:** When you save the record definition, PeopleSoft Application Designer alerts you if your custom configuration exceeds the maximum number of fields that can appear in the search results grid of a persistent search page. This alert is informational.

---

## Adding From and Through Logic to a Search Page

Refer to the following example when applying from and through logic to a search page:

**Image: Example of a search record**

This example illustrates the fields in the CNT\_CLAUSE\_TBL record, an example search record.

Num	Field Name	Type	Len	Format	Short Name	Long Name
1	CONTRACT_CLAUSE	Char	3	Upper	Clause	Contract Clause
2	EFFDT	Date	10		Eff Date	Effective Date
3	EFF_STATUS	Char	1	Upper	Status	Status as of Effective D
4	DESCR	Char	30	Mixed	Descr	Description
5	DESCRSHORT	Char	10	Mixed	Short Desc	Short Description
6	DESCR254	Char	254	Mixed	Long Descr	Long Description
7	COMMENTS	Long	0		Comment	Comment

To apply the from and through logic to a search page:

1. Determine which component you want to change.

You must modify the search record for a particular page, so you must first identify the appropriate component.

2. Determine on which field to use the from and through search logic.

Open the component in PeopleSoft Application Designer and examine the search record that is associated with the component. In the CNT\_CLAUSE\_TBL record, the search record is CNT\_CLAUSE\_TBL, and the field to which you want to apply the from and through search logic is CONTRACT\_CLAUSE.

3. Create a new view that contains the same fields as the original search record.

To use the from and through search logic, the search record *must be a view*. If the search record is already based on a view, you can modify the existing view instead of creating a new view.

4. Select the From Search Field property for the field.

In the new view, select the from search field and apply the following record field properties: Key, Search Key, and From Search Field (List Box Item is optional).

5. Create a new field with exactly the same attributes as the from field.

For example, if CONTRACT\_CLAUSE represents the field from which you want to search, then create a field called CONTRACT\_CLAUSE\_TO representing the field through which you want to search.

6. Insert the new field directly below the original field.

7. Select the Through Search Field property for the field.

Select the new through search field and apply the following record field properties: Key, Search Key, and Through Search Field only.

8. Update the SQL view text.

Update the SQL view Select statement in the new view to reflect the new column. That is, the view text should select the same field twice in a row (as shown in the example that follows this procedure) because the same field is used for the from logic and the through logic.

9. Save and build the new view.
10. Update the component properties.

You must update the search record so that the component uses the new view.

11. Test the new search page.

The search page should now include the new through field so that the user can specify a range of values for the field. Because you want to search on both fields, you must use an advanced search.

The results in the list box should reflect a range of values between the from and through fields that are specified. The results are inclusive: they include the minimum and maximum values that the user specified.

### Example of Updating the SQL View Select Statement

After you define a search field as a Through Search Field, you need to update the SQL view text, as shown in this example:

#### Image: Example of updating the SQL view Select statement

This example illustrates the fields and controls on the Example of updating the SQL view Select statement. You can find definitions for the fields and controls later on this page.

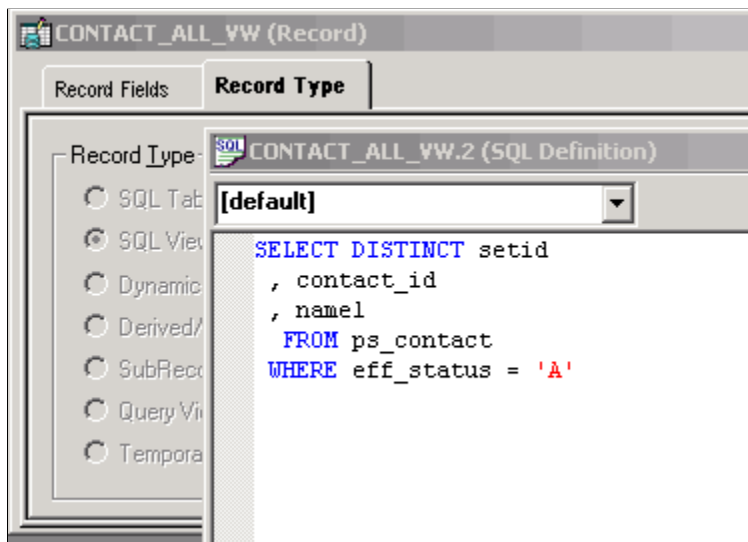

### Setting Record Field Edit Properties

The Edits tab enables you to specify whether the system is to perform special edits or validations on a record field. You also name the record definition for the prompt table that stores the valid values, as shown in this example:



### Image: Example of the Record Field Properties dialog box: Edits tab

This example illustrates the fields and controls on the Example of the Record Field Properties dialog box: Edits tab. You can find definitions for the fields and controls later on this page.

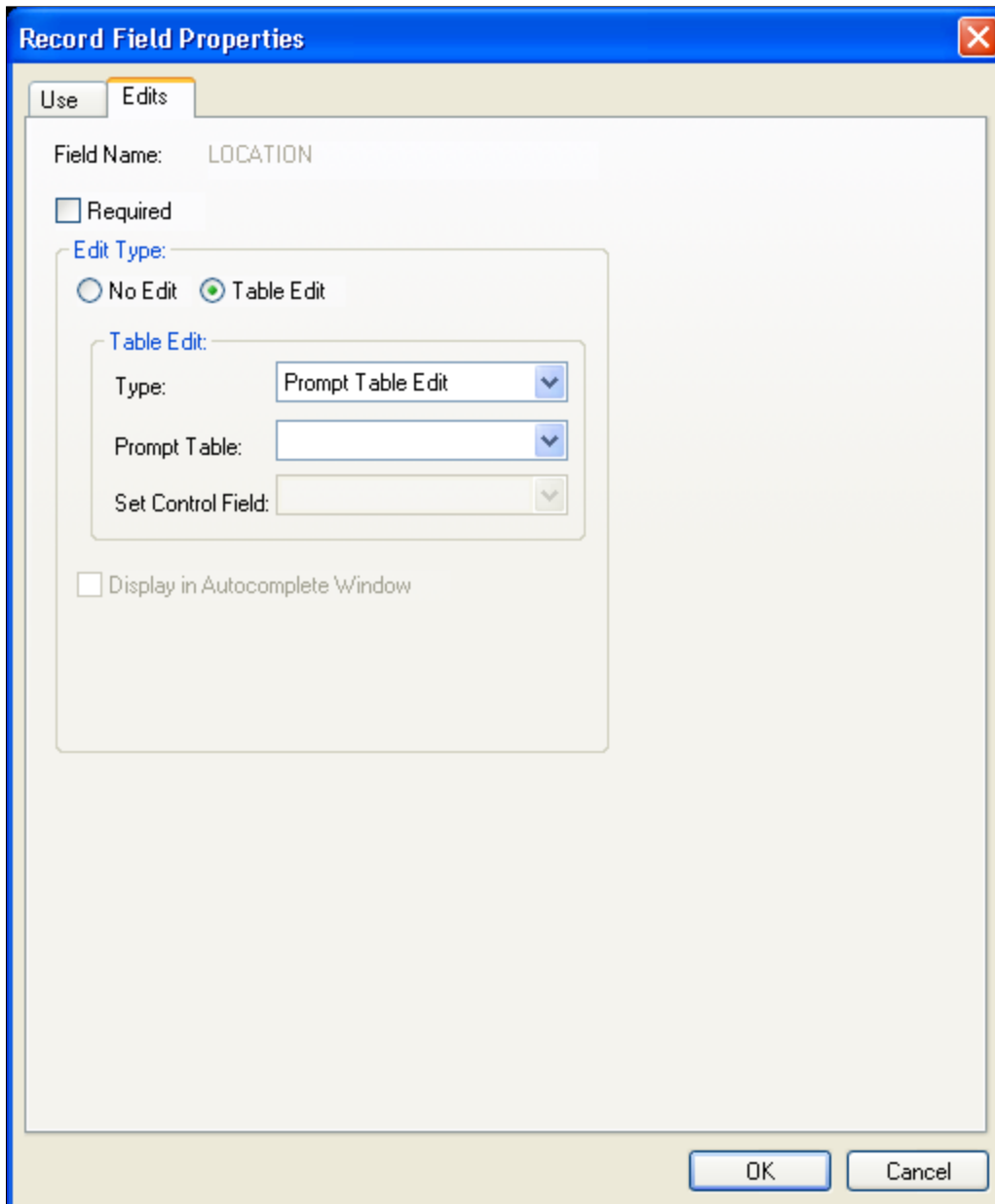

#### Required

Select if you do not want users to skip a field or leave it blank. Users are unable to save their work until they complete all of the required fields on a page.

---

**Note:** The system only checks required fields when the page field is changed or the record buffer is changed.

---

## Edit Type

### No Edit

Select if you do not want to edit the contents of this field against a table. This value is the default; it makes the options in the Table Edit group box unavailable.

### Table Edit

Select to edit the contents of the field against the values that are maintained in the specified table. When you select Table Edit, the Type field becomes available in the Table Edit group box.

### Display in Autocomplete Window

Select to make this field appear in the autocomplete list.

This property is enabled for date, Datetime, time, character, number, and signed number fields if the following conditions are met:

- The field is a list box item.
- The field is not a search item.

## Table Edit

### Type

Select from the drop-down list box:

*Prompt Table with No Edit:* Provides users with a list of suggested values but does not edit the contents of the field against the prompt table. Users can enter any value. Selecting this option makes the Prompt Table field available.

*Prompt Table Edit:* Edits the contents of the field against the values that are maintained in the specified prompt table. Selecting this option activates the Prompt Table field. When you enter a prompt table name and exit the field by pressing the tab key, the Set Control Field is activated.

*Translate Table Edit:* Edits the contents of the field against the translate table. The translate table stores values for fields that must be validated but do not need individual tables of their own. If you select this option, the Prompt Table and Set Control Field fields become unavailable.

*Yes/No Table Edit:* Makes the values for this field Y (yes) and N (no) only. If you select this option, Prompt Table and Set Control Field fields become unavailable.

For this 1/0 table edit, 1=True and 0=False.

---

**Note:** The list of available table edit types is dependent on the field type.

If you add a field (other than with the paste action) to a record and the field name is already defined in the database with previously defined translate values, then the system automatically selects Table Edit and selects *Translate Table Edit* as the table type. For both *Translate Table Edit* and *Yes/No Table Edit*, you should follow PeopleSoft design standards, select Required, and specify a default value for the field in the Record Field Properties dialog box.

---

### **Prompt Table**

Enter the name of the record definition that you want to use as the prompt table for this field.

If you want the prompt table to vary depending on the context of the field, indicate a field in the derived or work record (DERIVED) that contains the name of the prompt table at runtime. Then, in this field enter *%FieldName*.

The % is required, and indicates that you are referencing a derived or work record definition named DERIVED. *FieldName* is the name of the field in the DERIVED record definition.

### **Set Control Field**

Select a set control field that overrides the set control field of the record definition specified in the prompt table. If you do not specify a name in this field, the default is the set control field of the record definition specified in the prompt table.

### **Reasonable Date**

Select if you want the system to test the field value to determine whether it is within 30 days of the current date. If the date is out of range, a warning message appears when the user exits the field.

## **Moving Fields in the Same Record**

You can move fields in a record by dragging a field to another place in the open record definition. In addition, you can change the visible order of fields by clicking any of the grid headings. In this sample record definition, the DIM\_DATA\_SRC\_TYPE field is being moved to the location that is indicated by the red line:

### Image: Moving field to new position

This example illustrates the fields and controls on the Moving field to new position. You can find definitions for the fields and controls later on this page.

Num	Field Name	Type	Len	Format	Short Name	Long Name
1	DATA_SRC_NUM	Nbr	4		Input Nbr	Input Number
2	DIMENSION_ID	Char	30	Upper	Dimension	Dimension/Measure/Attr
3	SEQUENCE_NBR	Nbr	2		Sequence	Sequence Number
4	QRYNAME	Char	30	Upper	Query Name	Input Name
5	TREE_NODE	Char	20	Upper	Node	Tree Node
6	LEVELS_FROM_TOP	Nbr	3		Levels From Top	Levels From Top
7	DIM_DATA_SRC_TYPE	Char	1	Upper	Src Type	Dimension Data Source

To move a field in the same record definition:

1. Select the field that you want to move.

Press the Ctrl and Shift keys to select multiple fields at once.

2. Drag the selected field number to the new position in the record definition window.

A red line between rows indicates the new placement options as you drag the field. The Num column automatically renumbers the fields.

---

**Note:** The fields are reordered only in the visible display of the record definition, not in the actual table.

---

## Moving Fields to Another Record Definition

To move fields from one record definition to another, you can cut and paste the fields. You can also drag a field from the project workspace into a record definition in the object workspace or between open record definitions.

To move a field from one record definition to another:

1. Open the two records between which you want to move the field.
2. Select the field that you want to move.

Move multiple fields by using the Ctrl or Shift key.

3. Select Edit > Cut.

If this is the correct field to cut from the record, click Yes.

4. Select the new position for the field in the destination record.
5. Select Edit > Paste to paste the field into the new record definition.

---

**Note:** PeopleCode that is associated with fields is not carried over with cut and paste operations. The same is true for delete and undo with field deletions in records. Record field attributes, such as key, search key, and so on, *are* retained.

---

## Deleting Fields From a Record Definition

To delete a field from a record definition:

1. Select the field that you want to remove and press the Delete key.

This action deletes the field completely and does not copy it to the clipboard, unlike a cut operation, which does copy it to the clipboard.

2. When the system prompts you to confirm the deletion, click Yes.

If you already created the underlying table for the record definition from which you are deleting the field, recreate the table or use the SQL Alter function to alter the table.

---

**Important!** If you delete a field from a record definition, you must also delete it from any pages on which it appears. When you delete a field, the system does not automatically delete references to the field in PeopleCode, so you must do this manually. To determine where the field is referenced in PeopleCode, use the Find Object References feature.

You can also reference the following two reports: "Fields and Records" (XRFFLRC) shows which records contain the field; "Fields Referenced by PeopleCode Programs" (XRFFLPC) shows PeopleCode that refers to the field in the record.

---

Modify or remove PeopleCode when you find references to the deleted field.

## Renaming Record Definitions

To rename a record definition:

1. Select File > Rename.

The Rename Definition dialog box appears.

2. Select *Record* from Definition Type.
3. Click Rename.
4. Select the record and click Rename.

A rectangular box appears around the name.

5. Enter the new name and press the Enterkey.

### Results of Renaming Record Definitions

When you rename a record definition, the system automatically renames all references to it, including data in tables with columns named RECNAME where the data matches the record being renamed.

The only references that are *not* renamed are the text portion of SQL functions, such as SQLExec and Scroll Select, and the record names in the view text. To find the text portion of SQL functions in PeopleCode or record names in view text, select Edit > Find In to search for matching text.

If you already created the underlying tables for the record definition that you renamed, recreate that table. To preserve data in the tables, use the SQL Alter function to rename the database tables.

## Deleting Record Definitions

To delete a record definition:

1. Select File > Delete.
2. Select the record definition to delete.
3. Click Delete.

---

**Warning!** When you delete a record definition, the system automatically deletes any PeopleCode that is associated with the record.

---

4. Click Yes if you really want to delete the record definition.

---

**Note:** Notify your database administrator about which record definition you deleted so that the administrator can drop the underlying SQL table and its contents from the database.

---

## Printing Record Definitions

You can print your record definitions as references identifying all of the fields and their various attributes—any special use, edits, or PeopleCode that you applied.

To print a record definition, it must be open in the object workspace.

To print a record definition:

1. Select File > Print Setup to change any of the print record defaults.

The system retains your changes until you reset them again. The Print Setup dialog box appears.

2. Select printing options.

**Definition**

Print a picture of what the definition looks like.

**PeopleCode**

Select if you want the report to include a listing of any PeopleCode programs that are attached to each field, identifying the program type and listing all of the PeopleCode statements. Selected by default.

**Graphics**

Not used for record definition printing.

**Margins(mm)** [margins (millimeters)] Set the distance (in millimeters) from the edge of the page to the left, right, top, and bottom edges of the page image or report. The defaults are: 20 (top), 5 (bottom), 5 (left), and 0 (right).

<b>Header</b>	Print a header at the top of the report indicating the date and time at which you printed the report and the database name, record name, version number, and page number. Selected by default.
<b>Footer</b>	Print a footer at the bottom of the report indicating the date and time at which you printed the report and the database name, record name, version number, and page number. Deselected by default.
<b>Border</b>	Print a border or box around a record definition report. To print reports faster, clear this check box so that the printer can print the report in character mode, rather than in graphics mode. Deselected by default.
<b>Border Space(mm)</b>	Insert a set amount of space between a graphical boarder around the record definition report and the margins of the report. The default value is 3.

3. Click OK when you are done, to close the Print Setup dialog box and save your settings.
4. Select File > Print.

## Record Definition Report

The following table lists the columns in the record definition report and their contents:

<b>Column</b>	<b>Contents</b>
Field Name	The name of the field.
Type	The field type.
Length	The length of the field (not specified for long character fields).
Format	The field format.
Long Name	The 30-character name of the field.
Short Name	The 15-character name of the field.
Key	Identifies key attributes (characters defined by position).
Req (required)	<i>Yes</i> indicates that the field is required.
TblEdt (table edit)	<p><i>Prompt</i>: Field values are edited against a specified prompt table.</p> <p><i>Y/N</i>: The field uses the Yes/No Table.</p> <p><i>Xlat</i>: The field has values in the translate table. Values (if printed) are listed below the field.</p>

<b>Column</b>	<b>Contents</b>
AU (auto-update)	<i>Yes</i> indicates that the auto-update option is enabled.
Dt (date)	<i>Yes</i> indicates that the reasonable date option is enabled.
PC (PeopleCode)	<i>Yes</i> indicates that the field contains PeopleCode. PeopleCode text (if printed) appears below the field.
Aud (audit)	<i>Yes</i> : The field audit flag is enabled.  <i>A</i> : Audit add.  <i>C</i> : Audit change.  <i>D</i> : Audit delete.
Prompt Table	The name of the prompt table.
Default Value	Any default value or constant.

You might also see these additional reference lines below each field or at the end of the report:

<b>Reference</b>	<b>Description</b>
SQL View	Shows the SQL view Select statement for view-type record definitions. This appears at the top of the report.
System Maintained	Indicates that the System Maintained check box is selected. Because this option is for documentation purposes only, it doesn't warrant its own column heading.
DbField Help Context: <i>nnn</i>	Indicates that the field has been assigned a field help context number to link it to a help file that describes how the field is used wherever it appears in the database.
RecField Help Context: <i>nnn</i>	Indicates that the field has been assigned to a record field help context number to link it to a help file that describes how the field is used only as it appears in this record definition.
Audit Record	Identifies a user-defined audit record. Lists the audit record name and the type of audit.
Set Control Field	Identifies a set control field that is designated for the record definition.
Related Language Record	Identifies a related language record that is designated for the record definition.
Query Security Record	Identifies views that are used to restrict query access to data that is stored in the table.



<b>Reference</b>	<b>Description</b>
Parent Record Name	Identifies the hierarchical relationship of the record for query reporting.

Printing records with subrecords takes into account whether the record view is expanded or collapsed. If the record view is expanded, the subrecord fields are indented to the appropriate level of nesting.

## Creating SQL View and Dynamic View Select Statements

If you are creating a SQL view or dynamic view record definition, you must enter a SQL view Select statement to indicate which field values you want to join from which tables. The only difference between the standard view and dynamic view is that the dynamic view is not defined as a view to the database; it is stored on the client and run as a Select at runtime. Dynamic views avoid some constraints on views on some platforms.

<b>Non-Standard SQL Table Name</b>	Override the standard convention of prefixing each record name with <i>PS_</i> .
<b>Build Sequence No</b> (build sequence number)	Set the order in which the view is to be created. The default value is <i>1</i> when the record or view is initially created. Views that must be created first can be set to <i>0</i> , while views that you want created last can be set to any number from <i>1</i> to <i>99</i> . The build sequence number is stored with the other details of the record or view in the database.
<b>Click to open SQL Editor</b>	The view text is saved when the record is saved by selecting File > Save. The record must be saved first, before you open the SQL Editor.

As a general guideline, the SQL used for dynamic views should be as simple as possible because the runtime system appends *WHERE* clauses to the SQL definition to add key field lookup criteria and does not parse the dynamic view SQL definition to find correlation names. For example, we do not recommend the following format:

```
SELECT...FROM(SELECT * FROM...WHERE...)
```

Rather than having a *WHERE* clause in the subquery, one approach would be to create a static view that the dynamic view references. For example, that static view might be:

```
...
ABC_PRD_INS_VW as

SELECT B.SETID AS SETID
, A.BO_ID_CUST AS BO_ID_CUST
, A.INST_PROD_ID AS INST_PROD_ID
, B.PRODUCT_ID AS PRODUCT_ID
, B.DESCR AS DESCR
, A.SERIAL_ID AS SERIAL_ID
, A.INSTALLED_DATE AS INSTALLED_DATE
FROM PS_RF_INST_PROD A
, PS_PROD_ITEM B
, PS_RF_INST_PROD ST C
, PS_PROD_PGRP_LNK D
WHERE A.SETID = B.SETID
AND A.PRODUCT_ID = B.PRODUCT_ID
AND A.SETID = C.SETID
```

```
AND A.INST_PROD_ID = C.INST_PROD_ID
AND C.INST_PROD_STATUS <> 'UNI'
AND A.SETID = D.SETID
AND A.PRODUCT_ID = D.PRODUCT_ID
AND D.PRODUCT_GROUP = '00'
```

Which is referenced by the dynamic view:

```
SELECT SETID
,BO_ID CUST
,INST_PROD_ID
,PRODUCT_ID
,DESCR
,SERIAL_ID
,INSTALLED_DATE
FROM PS_ABC_PRD_INS_VW
WHERE SETID = :1
AND BO_ID CUST = :2
AND INST_PROD_ID = :3
```

---

**Note:** The order of the columns in the Select statement must be identical to the field order in the corresponding record definition. Also, only certain types of meta-SQL statements can be used in view text.

---

---

**Note:** Related language records should not use dynamic views but should be limited to physical views and records.

---

## Related Links

[Using Cross-Platform Meta-SQL for Dynamic Views](#)

# Administering Data

---

## Understanding Data Administration and the Build Process

Using PeopleSoft Application Designer, you create several kinds of definitions that represent database components. For instance, field definitions represent table columns, and record definitions represent tables and views. From these field and record definitions, you can create tables, views, and indexes. The important concept to remember is that the definitions are just the blueprints for the actual, physical database components with which they are associated. In the context of the entire application development cycle, use the Build process to create SQL tables, views, triggers, and indexes after you define new fields and create the record definitions. After you build the SQL tables, you begin creating page definitions.

After you create and define your field and record definitions, you must create or build the underlying SQL tables that house the application data that your users enter online in your production environment. The Build process is the centerpiece of the data administration features in PeopleSoft Application Designer. The Build process uses DDL to construct a physical database component that is based on the associated record and field definitions that you created. Using the Build feature, you can create:

- Tables.
- Indexes.
- Views.
- Triggers.

You can also use the Build feature to alter existing tables if you change the record definition after the table already exists. Altering a table is useful, because it enables you to make changes without losing the application data that is already housed in the table. In general, the results of the build operation are written to a script file that a database administrator can run later. On some database platforms, you can run the SQL online, if you prefer, so that your changes are immediately reflected in the physical database. However, if you run the SQL immediately, you cannot review it to make sure that the table that was built truly meets all of your requirements.

Before you begin using the data administration tools and running a build process, make sure you:

- Review what DDL means for PeopleSoft applications.
- Grant build authority.

### Reviewing DDL

DDL is the part of SQL that pertains to the creation of tables, indexes, views, triggers, and tablespaces. DDL is also the part of SQL that differs most between the various relational database platforms. Each database vendor provides different syntax and configuration options for creating and organizing tables and for optimizing performance. Because PeopleTools supports multiple database platforms, PeopleSoft

developers designed a flexible way of specifying DDL that enables you to take advantage of each vendor's features. The basic components of the PeopleSoft DDL support include the following:

- DDL model definition: A complete set of the supported DDL statements for each database platform.

Statements include Create Table, Create Tablespace, and Create Index. Each DDL model statement has substitution parameters that can be specified at the database level or overridden for individual records.

- Record DDL: Specify the DDL model substitution parameters for an individual record.
- Index DDL: Specify the DDL model substitution parameters for an index.
- Sizing sets: A way to maintain multiple versions of your DDL model statements for a database platform.

For example, you can use one sizing set during a development phase, when tables have only test data, and another during production, when tables have more data.

### Granting Build Authority

PeopleSoft Security enables you to specify which users can build scripts, run scripts (Execute SQL now), maintain DDL, and so on. Access Security from the PeopleTools link in the menu.

### Related Links

"Setting PeopleTools Permissions" (PeopleTools 8.58: Security Administration)

---

## Running the Build Process

This section provides an overview of the Build menu and discusses how to:

- Select the build scope.
- Select build options and run the Build process.

## Understanding the Build Menu

Access all of the commands and options that are associated with building tables, views, indexes, triggers, and altering tables from the Build menu. When you choose to build an item from the Build menu, the tasks for creating or running SQL scripts that define the underlying database components are included in the Build dialog box.

**Image: Build dialog box**

This example illustrates the fields and controls on the Build dialog box. You can find definitions for the fields and controls later on this page.

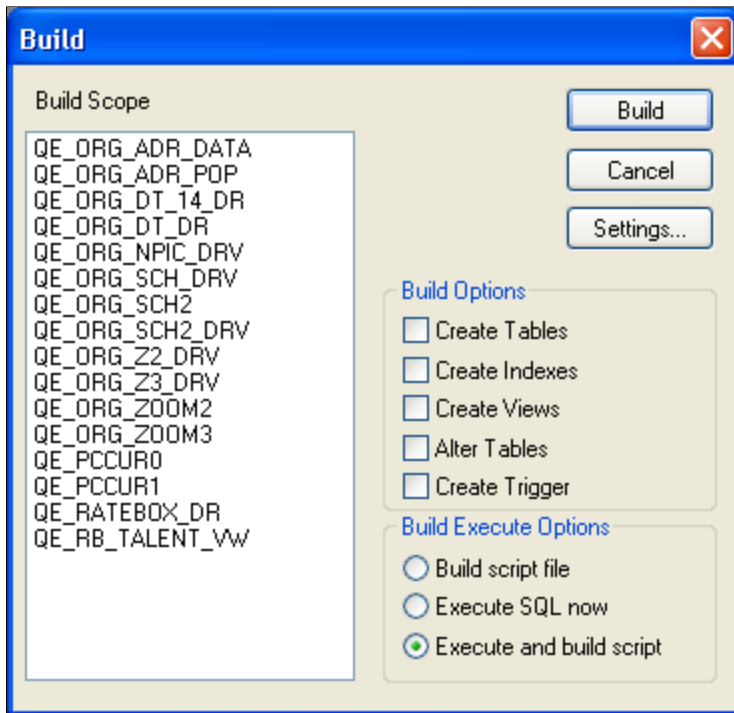

The settings for the Build process in the Build Settings dialog box enable you to configure various aspects of the process. Depending on which build option you are running, your settings vary. The Build Settings that you select are stored on your workstation so that they can be reused during future PeopleSoft Application Designer sessions. Access the Build settings by selecting Settings from the Build menu in PeopleSoft Application Designer or click the Settings button in the Build dialog box.

**Image: Build Settings dialog box**

This example illustrates the fields and controls on the Build Settings dialog box. You can find definitions for the fields and controls later on this page.

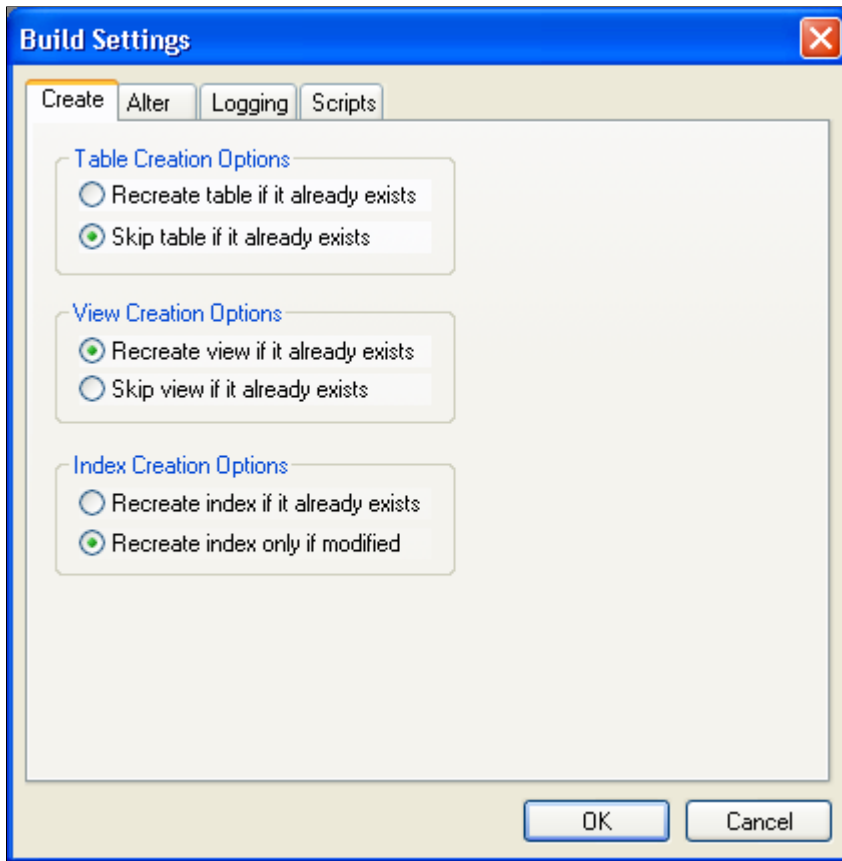

When you select the Create Tables, Create Indexes, or Create Views options in the Build dialog box, specify the appropriate options on the Create tab of the Build Settings dialog box. For example, you might need to specify whether an existing table, view, or index is skipped or dropped and then recreated.

If you modify your record definitions, the tables in your production database should reflect those changes to maintain your data integrity. When you alter a table, select the appropriate options, such as the options in the Drop Column Options area on the Alter tab of the Build Settings dialog box.

You can monitor the Build process by reviewing the log files that it automatically generates. Keep in mind that the log file is *entirely* separate from the script file. The amount of information that the log file contains is up to you. You can set up logging so that all statuses (both good and bad) appear in the log, or you can specify that only errors or warnings appear in the log. Control the settings for the Build log file (such as the logging level and the location for the output log file) on the Logging tab of the Build Settings dialog box.

If you build a script file, then the Build process generates a script file that contains all of the CREATE and ALTER SQL statements so that you can review them before running the SQL through another SQL command processor. If the generated script file meets your requirements, a database administrator (DBA) can run the script later. The Build process can produce multiple scripts during a single run—one for each build option—depending on the script settings that you specify at runtime. For example, you can specify that the Build process generate a separate script for your tables, views, indexes, triggers, and alters, or you can have all of the SQL for each action contained in one script. Use the Scripts tab of the Build Settings

dialog box to specify where the SQL script is written, whether you want multiple scripts generated for each definition type, and whether you want previous scripts overwritten.

## Selecting the Build Scope

The Build feature includes three different scopes that determine the size of your build project. Depending on what you actually want to build—one record or an entire project—you can determine the scope by selecting one of the scopes described in the following topics.

### Current Definition

Select Current Definition from the Build menu to build or alter the active record definition. *Active definition* means the definition that is currently active in the definition workspace.

### Project

Select Project from the Build menu to build or alter all of the records, indexes, triggers, and views in the current project—that is, all of the records that appear in the project workspace. You typically find numerous record definitions in the Build Scope list box.

To build all definitions in a database, create a new project and insert all of the appropriate records. For example, insert records of a particular type, such as views. If you create another record after the *all records* project is built, you must manually add the new record to the project.

You may also build a project using the command line and specific parameters. The prerequisites for using the command line to build a project are:

- The project exists with all objects.
- The build settings need to be set in the Windows registry.

---

**Note:** The Build Project process accesses every single record that is in the project, including work records, even if they are marked to be deleted.

---

### Select Definitions Into Project

In some situations, you might want to build a subset of the records in the project that is currently open. If you do not want to build an entire project or even the current project, you can build only the definitions that you select in the project workspace by pressing the Ctrl key and selecting multiple records in the project workspace. After you select the appropriate records, right-click and select Build from the pop-up menu. Only the definitions that are selected in the project workspace appear in the Build Scope list box.

---

**Note:** You must invoke the Build process from the pop-up menu; you cannot build selected definitions from an open project using the Build menu.

---

## Selecting Build Options and Running the Build Process

Access the Build dialog box.

### Build Scope

This list box displays all of the definitions that are included in the current Build process. The records that appear in this list box

cannot be selected or deselected. If you must narrow the scope of your build, do so before accessing the Build dialog box.

**Build**

Click this button to start the Build process. While the Build process is running, the Build Progress dialog box appears, showing the current record being processed, the record number being processed in the series, and the total number of records that comprise the build. To stop a running Build process, click the Cancel button. When the Build process completes, the Cancel button is unavailable, and the Close button is the only valid button.

**Settings**

Click this button to open the Build Settings dialog box, where you can view or change your options.

---

**Note:** After the Build process begins, no runtime prompts appear until the process is complete. All events are written to the Build log.

---

**Build Options**

The Build Options group box enables you to specify what action you want to occur: Create Tables, Create Indexes, Create Views, Alter Tables, or Create Trigger. If you select Create Tables or Alter Tables, Create Indexes is automatically selected by default. Also, if you select Alter Tables, Create Indexes and Create Trigger are automatically selected by default.

---

**Note:** You can select both Alter Tables and Create Tables to run concurrently if the Skip table if it already exists option is enabled on the Create tab in the Build Settings dialog box. Otherwise, the system cannot determine whether you want to alter or recreate a table that already exists.

---

**Build Execute Options****Build script file**

Select this option to review and update the SQL before running the script. This method is the safest.

**Execute SQL now**

Select this option if you do not want to invoke another program to run the SQL; the SQL runs as part of the Build process. The disadvantage of running the SQL immediately is that you have no opportunity to review the SQL before it is committed to the database.

**Execute and build script**

Select this option to review the SQL that the Build process just ran.

To run the SQL script file that the Build process generates, you must use a third-party SQL tool, such as Oracle SQL Developer or Microsoft ISQL/W. Most database vendors include a native command processor that you can run on the client or the server.

---

**Note:** The Execute SQL now option is unavailable if you use the Alter Tables Build option. However, you can use the Execute and build script option when using Alter Tables. Selecting this option builds a script with the entire altered SQL. This script may help if errors are encountered during the alter process. However, if an alter process has multiple tables and an error occurs, the errors are reported to a log file and the process continues to the next table.

---



---

## Creating Tables

This section provides an overview of the Create Table process and discusses how to:

- Create a table.
- Specify Create options.
- Specify Logging options.
- Specify Script options.
- Confirm a table build.

## Understanding the Create Table Process

The Build process generates the appropriate SQL Create statements to build tables based on both your record definition and your platform. It prefaces each new application SQL table with *PS\_* to identify it as an application that was built using PeopleTools. For example:

```
PS_ABSENCE_HIST
```

---

**Note:** PeopleTools does not preface table names with *PS\_* if you specified a custom name in the Non-Standard SQL Table Name edit box located on the Type tab of the Record Properties dialog box.

---

The Build process also creates the appropriate indexes. Because long-character fields operate more efficiently in some database environments when they are located at the end of a table, the Build process automatically positions long-character fields at the end of the table for each database environment.

The Create Table process creates a new application table based on parameters defined in the record definition. When a new table is created, the database management system updates the system catalog tables to reflect the attributes of the new table.

The Create Table process is illustrated by the following diagram:

### Image: Create Table process

The following diagram illustrates the process of Create Table that creates a new application table based on the parameters defined in the record definition

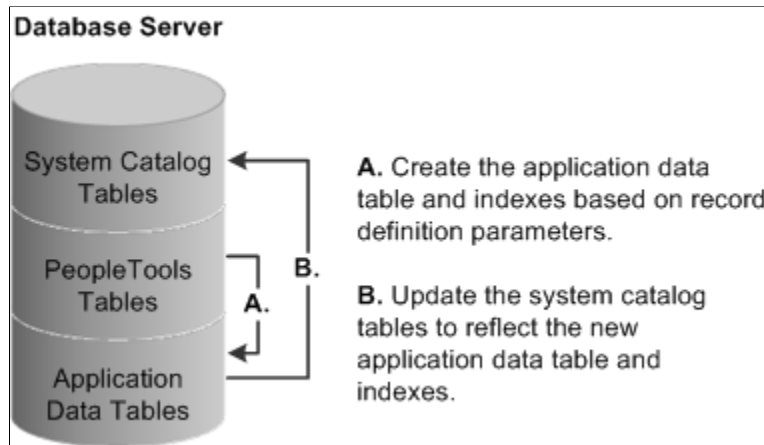

After you create an updated SQL build script and run it, the PeopleTools tables and the system catalog tables are synchronized; and the record definition and the application data table are synchronized. The following table lists the steps of the Create Table process and the associated record definition parameters:

<b>Create Table Process</b>	<b>Record Definition Parameter</b>	<b>Usage</b>
Drop the table if it already exists.	NA	NA
Create the application data table.	Record definition name. Field names. Field type. Field length.	Table name (add <i>PS_</i> prefix). Column names. Column type. Column length.
Create indexes.	Key fields. Alternate search key fields. Custom indexes.	Unique index: ( ) Alternate index: 10 (0–9) per table. Custom index: (A–V) per table.

The following procedure covers all of the high-level steps that you need to successfully complete for the Create Table build process. Steps that involve a variety of options include links to the area where those options appear in this product documentation.

---

**Note:** You can have a maximum of 500 columns per table.

---

## Creating a Table

To create a table:

1. Open the project for which you want to build SQL tables.
2. Select Build > Project.

3. From the Build menu, select the appropriate scope of your build.

See [Selecting the Build Scope](#).

The Build dialog box appears.

4. Select the Create Tables in the Build Options group box.

PeopleSoft Application Designer automatically activates the Create Indexes option. If you are rebuild or recreate tables, then the indexes that the system uses to extract information from those tables must also be updated. Definitions to be built appear in the Build Scope list box, which does not allow you to edit, remove, or add definitions.

5. Select one of the Build Execute options.

The default option builds an SQL script file containing the commands to run the selected build options.

6. Click the Settings button in the Build dialog box to set user-defined defaults.

The Create tab in the Build Settings dialog box appears.

7. Select the appropriate settings on the Create tab.

See [Specifying Create Options](#).

Recreating a table removes all data contained in the table as well as views or grants referencing that table.

8. Select the Logging tab.

9. Set the Logging Levels and associated options.

See [Specifying Logging Options](#).

10. Select the Scripts tab.

11. Specify the script file options.

If you selected Execute SQL Now as your build option in the Build dialog box, you can skip the Scripts tab because you will run the SQL online. Settings on the Scripts tab are relevant only if you are building a SQL script to run later.

See [Specifying Script Options](#).

12. Click OK to close the Build Settings dialog box.

13. In the Build dialog box, click the Build button to run your build option.

The length of a Build process depends on the number of definitions that require building. Watch the Build Progress dialog box to monitor the Build process. When the process completes, check any errors listed in the log file.

## Specifying Create Options

Access the Build Settings dialog box and select the Create tab.

### Image: Build Settings dialog box: Create tab

This example illustrates the fields and controls on the Build Settings dialog box: Create tab. You can find definitions for the fields and controls later on this page.

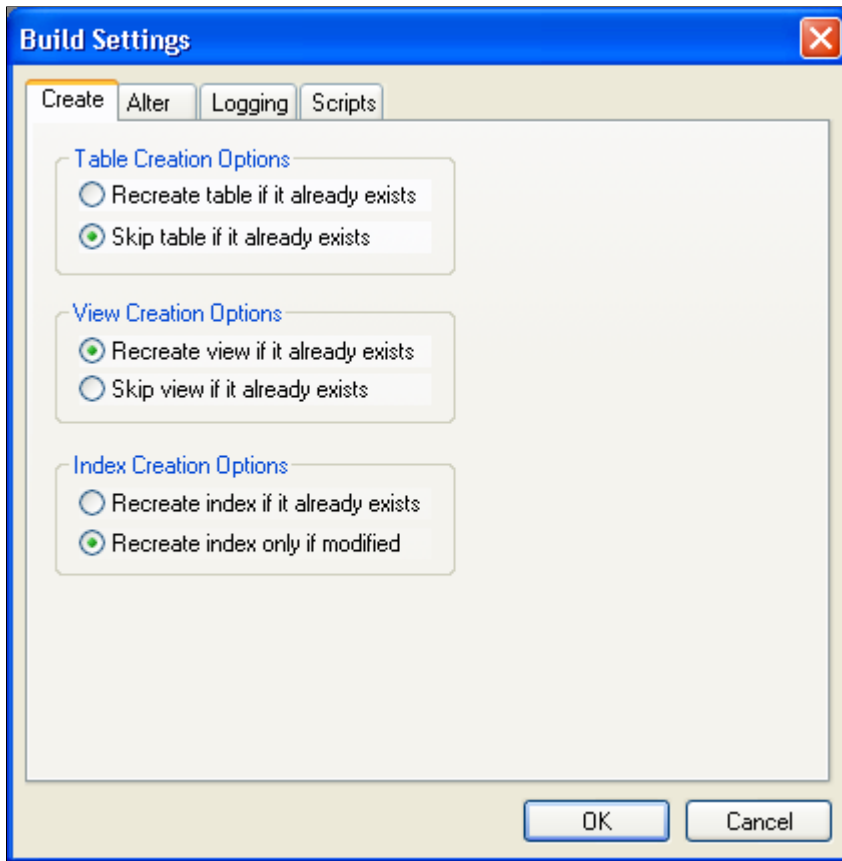

### Table Creation Options

These options determine when a table should and should not be created.

#### Recreate table if it already exists

Select to drop and recreate a table if it already exists. Select this option with extreme care because if data already resides in the table, it is also dropped. If you select this option, the Build process prompts you to confirm your intention before performing any destructive action. If you do not care about losing the data that resides in the table, then this option is faster than the Alter Tables option.

#### Skip table if it already exists

Select to create only newly defined tables. If you want to preserve the data that already resides in existing tables or if you are only interested in creating the tables that do not already exist, select this option.

### View Creation Options

Similar settings are available for creating views that you use for creating tables.

**Recreate view if it already exists**

Because views are only logical views of data, you can safely select this option; you do not run the risk of losing physical data. Using this option ensures that all views in the project are rebuilt, whether they need to be or not.

**Skip view if it already exists**

If you are concerned only with creating views that do not already exist in the database, select this option. This option is useful if you want to run Build Project on a large project and only a subset of the views in the project must be created. This option consumes less time than recreating all of the views in the project.

**Index Creation Options**

These options determine when an index should be recreated.

**Recreate index if it already exists**

Select to recreate the index for your tables, even if you already have one in place. This option recreates the index no matter what the situation.

**Recreate index only if modified**

Select to recreate the index only if the data in the indexes is being modified.

**Specifying Logging Options**

Access the Build Settings dialog box and select the Logging tab.

### Image: Build Settings dialog box: Logging tab

This example illustrates the fields and controls on the Build Settings dialog box: Logging tab. You can find definitions for the fields and controls later on this page.

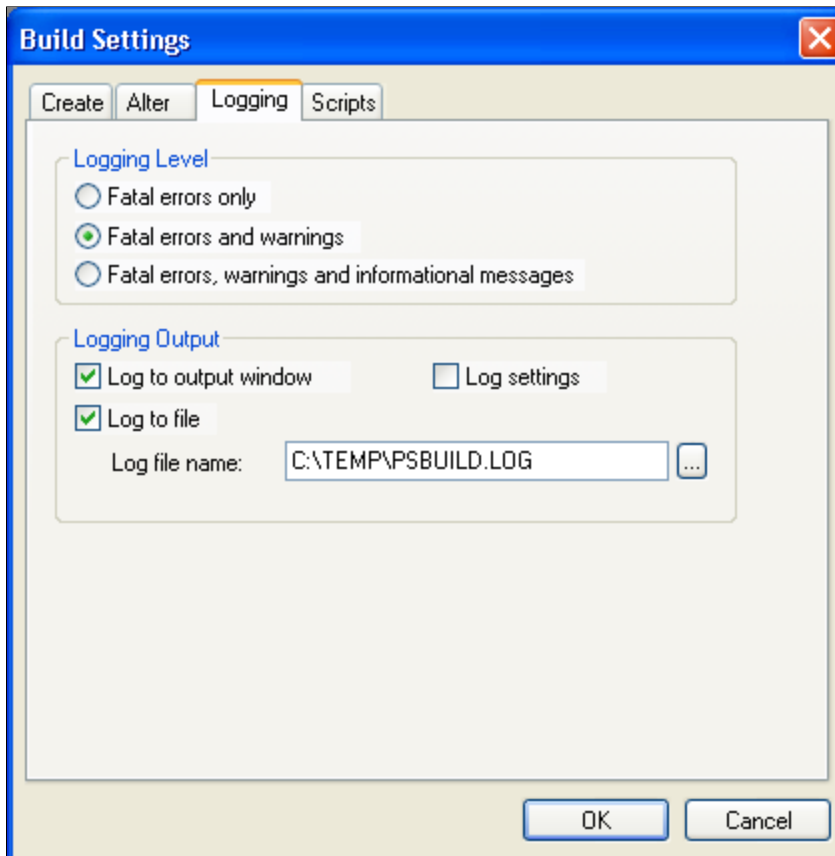

### Logging Level

Specify the level of detail of information that you want in your Build log output.

<b>Fatal errors only</b>	Select this option if you want to see only the operations that failed.
<b>Fatal errors and warnings</b>	Select this option to add warnings to the fatal errors.
<b>Fatal errors, warnings and informational messages</b>	Select this option to see all the definitions that processed successfully <i>and</i> all of the errors and warnings.

---

**Note:** These options are personal preferences and do not affect the actual build of your SQL tables, but they might help you track down potential failures. For example, if you are processing a large number of definitions, you will want to see only the operations that failed. Whereas, if you are processing a small number of definitions, you will want to see all of the successful operations, too.

---

### Logging Output

Specify where and in what form you want to view your log output.

**Log to output window**

Select to write the same information that appears in the log file to the PeopleSoft Application Designer output window. Always be aware of the level that you select. If you expect a lot of detail (high logging level plus many records to process), you may want to copy the logging information to a file and print it later.

**Log to file**

Select to write the log to a file. If you select this check box, you can specify a location and name for your log file in the Log file name edit box. To search for a name, click the Browse button. Select a .LOG type file from the Build File Selection dialog box. If you do not select this check box, the edit box is unavailable for entry.

**Log settings**

Select to write all of the runtime options to the log. If you select this check box, you do not need to rerun a test when you have a problem. If you must report a problem with the Build process or troubleshoot, you need to know the settings that were active.

---

**Note:** You should select the Log to file check box and the Log to output window check box with a minimum logging level of fatal errors and warnings. In case you run into a problem, you already have the information you need to research the problem. Otherwise, you must run the process again with a higher logging level.

---

**Example Log Results**

The following are samples of the type of information that you can expect to see in your log output that corresponds to the selections that you make on the Logging tab:

- Fatal errors:

```
SQL Build process began on 7/30/2003 at 8:46:46 PM for database
OM51U20
Error: BI_BILL_BY_F_VW - Unable to retrieve current DDL space name.
Alter processed failed. (76,47)
Error: BI_CHARGE_VW - Unable to retrieve current DDL space name.
Alter processed failed. (76,47)
Error: PS_BI_CYCLE_VW - alter failed due to an unknown column type
(UNDEFINED) found for field BILL_CYCLE_ID. (76,22)
Error: PS_BI_IVCLAYOUT_VW - alter failed due to an unknown column
type (UNDEFINED) found for field INVOICE_LAYOUT_ID. (76,22)
Error: CARINA - alter failed because SQL table does not exist. (76,7)
SQL Build process ended on 7/30/2003 at 8:54:34 PM.
2487 records processed, 11 errors, 0 warnings
SQL Build script for all processes written to file C:\TEMP\step38.SQL.
SQL Build log file written to C:\TEMP\step38.LOG
```

- Warnings:

```
SQL Build process began on 8/27/2003 at 4:00:32 PM for database DXD7L
Warning: ABSENCE_HIST2 - data would be truncated by altering
REASON. Record processed. (76,24)
```

- Fatal errors, warnings, and informational messages:

```
SQL Build process began on 8/27/2003 at 3:58:58 PM for database DXD7L
Warning: ABSENCE_HIST2 - data would be truncated by altering
REASON. Record processed. (76,24)
Error: ABSENCE_HIST2 - field PAID_UNPAID to be deleted has data
present. Record skipped. (76,23)
```

```

Informational: ACCOMPLISHMT_VW - view created and scripted
successfully. (76,18)
Informational: ACCT_AD2_INV_VW - view created and scripted
successfully. (76,18)
Informational: ACCT_ADJ_INV_VW - view created and scripted
successfully. (76,18)
Informational: ACCT_ISS_INV_VW - view created and scripted
successfully. (76,18)
Informational: ACCT_STK_INV_VW - view created and scripted
successfully. (76,18)
Informational: ACCT_TYPE_VW - view created and scripted
successfully. (76,18)
Informational: ACTION_SP_VW - view created and scripted
successfully. (76,18)
Informational: ACTION_XLAT_VW - view created and scripted
successfully. (76,18)
Informational: ADJUST_INV2_VW - view created and scripted
successfully. (76,18)
Informational: ADJUST_INV_VW - view created and scripted
successfully. (76,18)
11 records processed, 1 errors, 1 warnings
SQL Build script for all processes written to file
C:\TEMP\PSBUILD.SQL.
SQL executed online.
SQL Build log file written to C:\TEMP\PSBLD.log

```

- **Log settings:**

```

**** Begin Build Settings for this Run
Create Tables = No
Create Indexes = Yes
Create Views = No
Create Triggers = Yes
Alter Tables = Yes
Log to File = Yes
Log to Window = Yes
Write comments to script = No
Always overwrite files = Yes
Execute SQL Now = No
Write SQL to script file = Yes
Logging level = Log fatal errors, warnings and informational messages
Table creation option = Skip table if it exists
View creation option = Drop and recreate view if it exists
IndexCreationOption = Drop and recreate index always
Alter Adds = Yes
Alter Changes = Yes
Alter Renames = Yes
Alter Deletes = Yes
Alter even if no changes = No
Alter Table Option = Alter by Table Rename
Write script output to: Single file
Log filename = c:\temp\PSBUILD.LOG
Single script filename = c:\temp\PSBUILD.SQL
Alter drop column option = skip record if data present
Alter truncate column option = skip record if data would be truncated
Target database platform = MICROSOFT
Target sizing set = 0

```

## Working With the Output Window

You can navigate from error messages in the PeopleSoft Application Designer output window to the corresponding record definition by selecting the appropriate line in the Build log and double-clicking anywhere on that line. PeopleSoft Application Designer opens the corresponding record in the definition workspace.

Also, you can double-click any line in the output window that corresponds to a file, not just a record. PeopleSoft Application Designer opens that file with whatever application that you defined to open files



with a particular extension. For example, if you associated SQL files with your native SQL command utility, then your SQL utility opens and loads your PSBUILD.SQL script when you double-click the line that reads:

```
Single script file name = C:\Temp\PSBUILD.SQL
```

**Note:** PeopleSoft Application Designer uses the standard Microsoft Windows method for defining which programs are associated with particular file types. To modify the file associations, open My Computer, select Tools > Folder Options and then select the File Types tab.

## Specifying Script Options

Access the Build Settings dialog box and select the Scripts tab.

### Image: Build Settings dialog box: Scripts tab

This example illustrates the fields and controls on the Build Settings dialog box: Scripts tab. You can find definitions for the fields and controls later on this page.

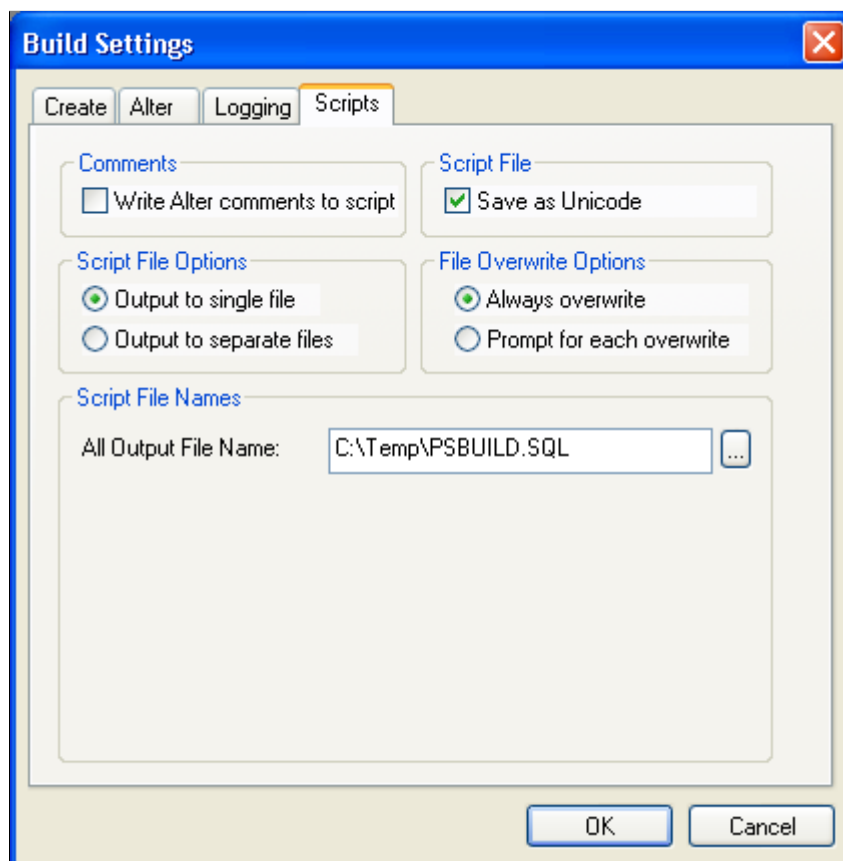

### Comments

The Write Alter comments to script check box enables you to either include or suppress alter comments. The following example displays the types of comments that you see in your PSALTER.SQL script if you enable this option:

```
-- Alters for record PS_AE_RUN_CONTROL ;
--         AE_THREAD - change ;
--         OPRID - change ;
```

```

-- Start the Transaction ;

-- Data Conversion ;

-- Drop Old Indexes ;

DROP INDEX SYSADM.PS_AE_RUN_CONTROL
/

-- Add Columns ;

ALTER TABLE PS_AE_RUN_CONTROL ADD Z_TMP_ALTER_1 DECIMAL(12,4)
/
ALTER TABLE PS_AE_RUN_CONTROL ADD Z_TMP_ALTER_2 CHAR(12)
/
UPDATE PS_AE_RUN_CONTROL SET
    Z_TMP_ALTER_1 = AE_THREAD,
    Z_TMP_ALTER_2 = OPRID
/

```

If you do not view the alter comments, the script containing the same commands as the previous script looks like this:

```

DROP INDEX SYSADM.PS_AE_RUN_CONTROL
/
ALTER TABLE PS_AE_RUN_CONTROL ADD Z_TMP_ALTER_1 DECIMAL(12,4)
/
ALTER TABLE PS_AE_RUN_CONTROL ADD Z_TMP_ALTER_2 CHAR(12)
/
UPDATE PS_AE_RUN_CONTROL SET
    Z_TMP_ALTER_1 = AE_THREAD,
    Z_TMP_ALTER_2 = OPRID
/

```

## Script File

The default for the Save as Unicode check box is based on the UNICODE/ANSI database. This check box is available when using Oracle, Microsoft SQL Server, and Db2 for z/OS databases.

The following table lists the default settings for the Save as Unicode check box:

<b>Database Type</b>	<b>Default for Save as Unicode Check Box</b>
Unicode	Selected
ANSI	Unavailable

The script file option, Save as Unicode, is stored in the registry with the other build settings. Therefore, the previous setting is always the default every time that the dialog box is opened.

The type of script file that is generated during the Build process is based on the Save as Unicode check box setting for the UNICODE/ANSI build and UNICODE/ANSI database. This table lists details:

<b>Database Platform</b>	<b>Unicode</b>	<b>ANSI</b>
SQL Server	UCS2	ANSI

<b>Database Platform</b>	<b>Unicode</b>	<b>ANSI</b>
Oracle	UTF8	ANSI
Db2 for z/OS	UTF8	ANSI

## Script File Options

If you want all of your CREATE TABLE statements to be written to one SQL script file and your CREATE INDEX statements to another, then select the Output to separate files option. If you prefer to have all of your statements, CREATE, ALTER, and so on, contained in a single file, then select the Output to single file option.

---

**Note:** Script files can be quite large. To reduce the size of files so that they are easier to manage, select the Output to separate files option. Also, the system never appends script files; it overwrites them or you can terminate the process if you elected to be prompted before a build script file is overwritten.

---

Depending on which output option you select, the options in the Script File Names group box change to suit one file or multiple files.

## File Overwrite Options

These options indicate whether you want to overwrite automatically or be prompted before script files are overwritten. Your personal preference determines which technique you employ.

### Always overwrite

Select to overwrite your previous build scripts.

### Prompt for each overwrite

Select to be alerted when a script is about to be overwritten.

To avoid the possibility of overwriting files altogether, you can use a naming convention that, in itself, prevents any overwrites. For example, you could specify a unique name for each build script, as shown:

- C:\TEMP\PSINDEX1.SQL
- C:\TEMP\PSINDEX2.SQL

## Script File Names

The options available to select in this group box depend on your selection in the Script File Options group box.

### Output to single file

When you select this option, an edit box appears in the Script File Names group box: All Output File Name. The default name for the generated script is PSBUILD.SQL.

---

**Note:** Script files can be quite large. To reduce the size of files so that they are easier to manage, select the Output to separate files option. Also, the system never appends script files; it overwrites them or you can terminate the process if you elected to be prompted before a build script file is overwritten.

---

### **Output to separate files**

If you select this option, the following edit boxes appear, one for each build option:

- **Create Table File Name:** The default name for this script is PSTABLE.SQL.
- **Create Index File Name:** The default name for this script is PSINDEX.SQL.
- **Create Trigger File Name:** The default name for this script is PTRIGGER.SQL.
- **Create View File Name:** The default name for this script is PSVIEW.SQL.
- **Alter Table File Name:** The default name for this script is PSALTER.SQL.

### Image: Output to separate files

This example illustrates the fields and controls on the Output to separate files. You can find definitions for the fields and controls later on this page.

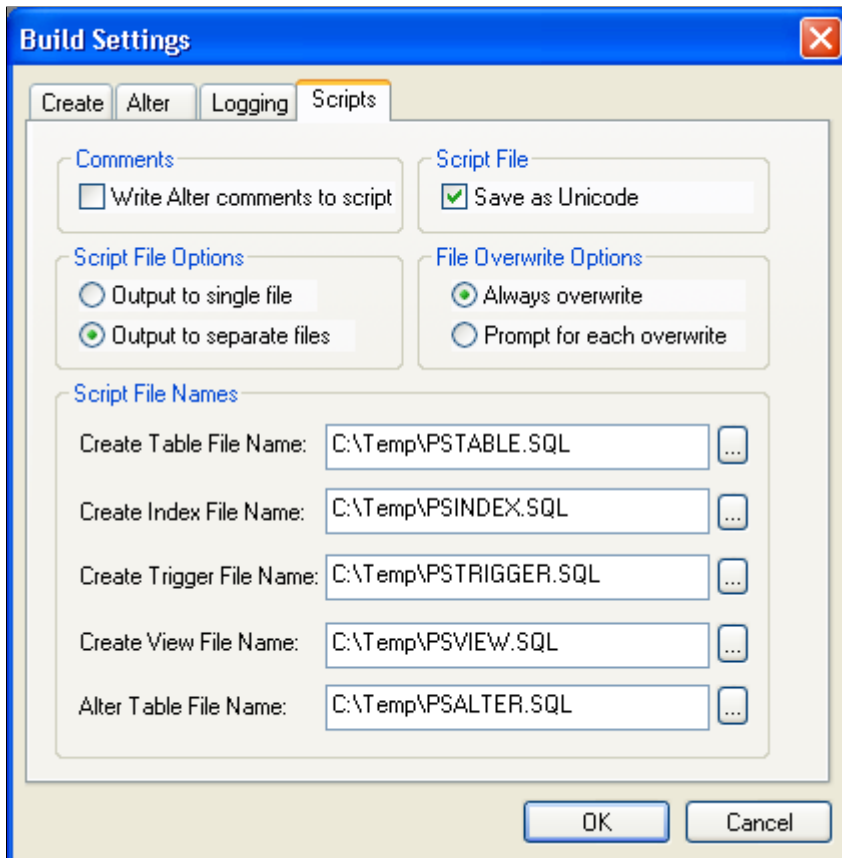

## Confirming a Table Build

If you are running SQL online, complete Steps 1 and 3; Step 2 is not required.

To confirm a table build:

1. Review the SQL script that was generated by the Build process.

Use your native SQL command processor to open the SQL script. The script is located where you specified on the Scripts tab of the Build Settings dialog box.

2. Run the script against your database.
3. Confirm that the tables now exist.

Use your query tool and SQL Select statements to confirm that the Create Table process created an application table that corresponds to your record definition and updated the system catalog tables. The SQL statement that you use to confirm depends on the table that you just created.

---

## Creating Indexes

This section provides an overview of indexes and discusses how to:

- Configure indexes.
- Add a custom index.
- Edit the DDL.

## Understanding Indexes

Indexes are an important part of your physical database because they affect the efficiency and speed with which your application can store and retrieve data. PeopleSoft application indexes are defined in two ways.

Some indexes are defined for you automatically, based on the key, search key, list box items, and alternate search keys that you specified in your record definition. The application processor uses these indexes for quick access when you use the online system.

However, sometimes you need to define additional indexes to improve the performance of demanding queries, reports, or batch programs. You define and modify these additional indexes using the data administration tools in PeopleSoft Application Designer.

---

**Note:** You can only create indexes for record definition types that are SQL or temporary tables. You would not create indexes on views, such as a SQL view, because views are never physically created. The Indexes option in the Tools, Data Administration menu is disabled when a view is open.

---

When you use SQL Create or SQL Alter for a table, the system automatically builds database indexes to the SQL table that are based on the keys and list items that you specify in the record definition. Your database uses indexes to find definitions in the database the same way that you use indexes to find specific information in a book. If an index entry exists for a specific field in a table, the database can search and quickly find what it needs to complete your request; otherwise, it must search the contents of the entire table.

Indexes enhance system performance by generating key lists that the application processor uses to extract the data that it uses to populate pages and search records. The system automatically creates:

- Standard indexes (key or duplicate order key indexes) if at least one field in the table is a key or duplicate order key.

The index contains all key and duplicate order key fields. The system automatically names this index with a prefix of *PS\_*.

- Alternate search key indexes for each alternate search key.

The system automatically names this index with a prefix of *PSn*, in which *n* is a number between 0 and 9.

- Custom indexes, which you can define using the Edit Index, Edit DDL, and Add Index dialog box in the PeopleSoft Application Designer administration tools.

The system automatically names this index with a prefix of *Psa*, in which *a* can be any letter between *A* and *V*. The system does not create custom indexes automatically.

For most database tables (those with unique keys), the key index defines unique keys for a table, but the system also uses it to access high-level keys and orders by all keys. Alternate search key indexes support the search record and field prompts. The purpose of these different indexes is to enable the system to respond to all system prompts through index-only SQL access, minimizing direct database table access.

---

**Note:** If you use Create Table or Alter, the Create Index option is automatically selected. With the Create Table or Alter options, you cannot deselect the Create Index option.

The alter process takes care of indexes regardless of the Alter Table Options you select on the Alter tab of the Build Settings dialog box. In the case of the Alter by Table Rename option, the indexes are dropped automatically when the temporary table is dropped. For the Alter in Place option, the index creation process goes through the Recreate index only if modified option on the Create tab.

When creating indexes with the Alter method, before altering the table, drop the statistics using "DROP STATISTICS" that were created explicitly in columns using "CREATE STATISTICS."

---

The following record definition modifications require you to create new indexes:

- Add, delete, or modify keys, duplicate order keys, alternate search keys, or descending keys in the Record Field Properties dialog box.
- Change the order of keys (ascending, as opposed to descending) in the Change Record Indexes dialog box.
- Change the Unique settings in the Edit Index dialog box.

## Platform Support for Indexes

Most database platforms support indexes with an unlimited number of keys. However, Microsoft SQL Server supports indexes that have a maximum of 16 keys only. PeopleSoft Application Designer supports indexes for these databases by creating functional indexes. If a record definition has more than 16 keys, the Build process automatically alters the table to support functional indexes. The system adds a warning message to the log file indicating this.

For Microsoft SQL Server, If an index has more than 16 keys, the key fields are concatenated to a functional key. This key field is then added to the table as the last column, called MSSCONCATCOL. A unique index is created for MSSXCONCATCOL as well as an additional index called PSW<record name>, which is used as a search index.

You can find sample code for functional indexes for each of these platforms in the "Understanding Functional Indexes" topic.

---

**Note:** Beginning with PeopleTools 8.54, descending indexes are no longer supported on the Oracle platform for performance reasons.

---

## Related Links

"Converting Descending Indexes" (PeopleTools 8.58: Data Management)

## Configuring Indexes

For performance tuning, you might want to change the order of your index keys. PeopleSoft Application Designer provides direct control over all of the indexes created by PeopleTools. You can inspect, add, or change all defined indexes or delete custom indexes for any record in the system through the Change Record Indexes dialog box.

Standard indexes are based on the key, duplicate order key, or alternate search key only. However, with the Change Record Indexes dialog box, you can modify those indexes and create additional indexes, which might be required if you do custom processing. Any of the indexes that you entered can be maintained for all database platforms or for a list of specific platforms. All indexes and keys created by PeopleTools are stored in PeopleSoft system tables.

### Image: Change Record Indexes dialog box

This example illustrates the fields and controls on the Change Record Indexes dialog box. You can find definitions for the fields and controls later on this page.

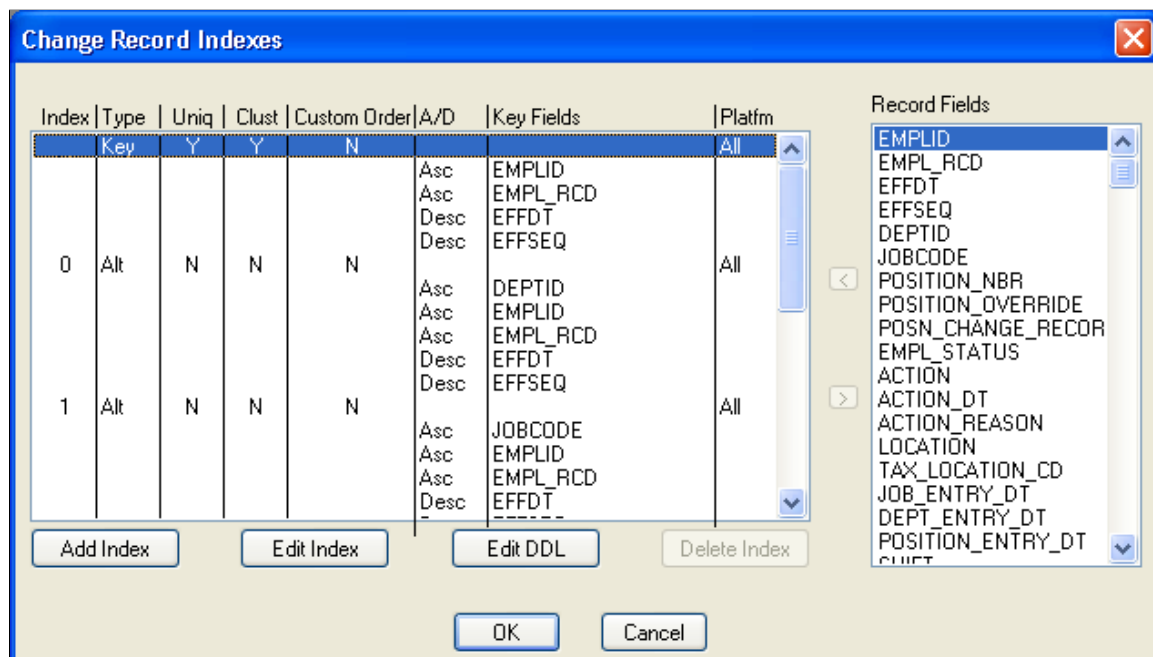

To edit the index key order:

1. Open the record definition for which you want to make the custom index.
2. Select Tools > Data Administration > Indexes to access the Change Record Indexes dialog box.

The Custom Order column indicates whether the index keys were configured. The default selection is *N*, indicating that no index keys were configured.

3. Double-click *N* or *Y* in the Custom Order column for the index that you want to alter, or click Edit Index.
4. Select the Custom Key Order check box.
5. Click OK.

The Custom Order entry changes from *N* to *Y*.



6. Drag and drop the field that you want to move into the appropriate order.

After configuring the key order, to reset the key order of the index to the original order as defined in the record definition, deselect the Custom Order entry (Y to N), and click OK. The order of the key fields reset to the original position in the Change Record Indexes dialog box.

7. Check the key order in the Use Display mode of your record definition.

The Num (number) column represents the original order of the keys in your record, and the Ord (order) column reflects the key order in the index.

8. Create the indexes:

- a. Select Build > Current Project.
- b. Select Create Indexes in the Build Options group box.

Make sure that you select the appropriate build settings.

9. Run the Build process to either generate a script or run the SQL online.

10. Confirm the construction of the new index with your native SQL command processor.

---

**Note:** Users might also configure indexes for parent records that contain one or more subrecords without key fields, such as the ADDRESS\_SBR subrecord . However, if the subrecords contain key fields, then index key order changes are restricted. The Custom Key Order option is deactivated and cannot be changed from *N* to *Y*. Change the index key order for the parent before inserting the subrecord.

---

## Adding a Custom Index

To add a custom index:

1. Open a record.
2. Select Tools > Data Administration > Indexes to access the Change Record Indexes dialog box.
3. Click Add Index.

The Add Index dialog box enables you to determine for which database platforms you want to define the index if you selected the Some option for Platform. The system selects the Custom Key Order check box to ensure that the underlying record definition is not adversely affected by the change to your index.

For all user-defined indexes, you must enter a description of the index in the Comments section. You should know the purpose of the index, the transactions and processes that use this index, and other relevant information. This information assists you when you want to remove unused indexes. An error message appears if you do not remove unused indexes.

---

**Note:** You cannot add more than 22 user indexes (A–V). The system disables the Add Index button if the record already contains 22 user indexes.

---

4. Indicate the database platforms for which you want to create an index.

5. Click the OK button to add a row to the Change Record Indexes dialog box and to enable the arrow buttons.
6. Move the field under the new index row:
  - a. In the Record Fields list box, select the field that you want indexed.
  - b. Click the arrow button or double-click the field.
  - c. Repeat this step for each field that you want to add.
7. Click OK.
8. Save the record definition.
9. Select Build > Current Project.
10. Select Create Indexes under Build Options.

Make sure that you select the appropriate build settings.
11. Run the Build process to either generate a script or run SQL online.
12. Run the generated SQL script if you opted to generate one.
13. Confirm the construction of the new index with your native SQL command processor.

## Editing the DDL

In the Change Record Indexes dialog box, you can view the DDL for the index and override DDL parameters that are defined in the DDL model for this index.

To edit the DDL:

1. In the Change Record Indexes dialog box, select the index that you want to edit.
2. Click the Edit DDL button to access the Maintain Index DDL dialog box.

The upper list box in this dialog box lists the platform and DDL parameter, and the lower list box shows the DDL templates for the various platforms. Your database might have fewer platforms enabled. The sizing set enables different collections of tables to have different model statements and parameters.

3. Select the platform and sizing set.
4. Click View DDL.

The dialog box that appears shows the index DDL for the platform and sizing set that you selected. Review this DDL statement.

5. Click the Close button when you are finished.
6. Select the parameter that you want to edit in the upper list box.

The default value is set in the DDL Model Defaults dialog box. You can change this setting by selecting Go > PeopleTools > Utilities > Use > DDL Model Defaults in PeopleSoft Application Designer, or by selecting PeopleTools > Utilities > Use > DDL Model Defaults in the browser.

7. Click the Edit Parm (edit parameter) button to access the Edit Override Parm Value (edit override parameter value) dialog box.
8. Enter the override value for the parameter that you selected.
9. Select OK for both open dialog boxes.

---

## Altering Tables

This topic provides an overview of the Alter process and discusses how to perform the Alter process.

### Understanding the Alter Process

The Alter process enables you to make changes to your record definitions at any time without losing the application data that is already housed in the table. To ensure that the Alter process produces the appropriate results, be aware of when to alter an existing table and what types of conversions PeopleSoft Application Designer supports. To preserve data that is stored in tables and also reflect a recent change in the table definition, use the alter tables function to make the appropriate changes.

The alter function simplifies the process of modifying database tables when new data fields are added or when existing data fields are modified. It effectively eliminates the need to write SQL statements to perform the same function.

The alter process was specifically designed to automate the task of writing alter scripts and to protect the integrity of your database. In essence, it protects your interests by ensuring that you always control data loss. The alter function performs tests that verify whether data will be lost during the conversion of each column to be altered. Data loss normally occurs when reducing the character width of a column, dropping a column that contains data, or converting a number field to a character field that is too small.

The generated statements for this method are sent to a SQL script file, the alter script. After the script has completed, you are responsible for reapplying any SQL table DDL that you applied outside of PeopleTools. Typically, this SQL table DDL consists of GRANT and REVOKE statements that control security.

---

**Note:** In Oracle databases, procedural language/SQL (PL/SQL) is required to use the PeopleSoft Application Designer Build process.

---

### Alter Settings

The Alter tab in the Build Settings dialog box handles the most common types of data conversions, including:

- Increasing the length of character fields.
- Changing a character (CHAR) field to a long character (LONG VARCHAR) field.
- Increasing the size of number or character fields.

- Reducing the decimal positions in number fields.

If any column of the table has data that will be lost when truncating, the system action is determined by the Change Column Length options.

- Changing integer-only number fields to character fields, where the character field is formatted with leading zeros.

If any column of the table has a number that does not fit in the new character field, the system action is determined by the Change Column Length options to prevent data from being lost.

- Adding columns to SQL tables.
- Dropping columns from SQL tables.
- Renaming columns in SQL tables.
- Renaming SQL tables.
- Moving tables to a new tablespace.

The following sections describe the types of alter conversions that you can expect to occur during the Build process.

### Data Conversions

When altering tables with existing field data, PeopleSoft Application Designer handles conversions as outlined in the following table. A *No* value indicates that conversion cannot take place. A number in the cell following a *Yes* value indicates that restrictions are involved with the conversion. Refer to the corresponding numbered note following the table for additional information:

<b>Previous Format</b>	<b>New Format</b>										
	<b>Char</b>	<b>Oracle - Long Char *</b>	<b>Long Char</b>	<b>Image</b>	<b>Long Char - Raw Binary</b>	<b>Number/ Signed Number **</b>			<b>Date</b>	<b>Time</b>	<b>Datetime</b>
						<b>SmallInt ***</b>	<b>Integer ****</b>	<b>Decimal *****</b>			
<i>Char</i>	Yes (1)	Yes (1)	Yes (9)	No	No	No	No	No	No	No	No
<i>Oracle - Long Char *</i>	Yes (1)	Yes (1)	Yes	No	No	No	No	No	No	No	No
<i>LongChar</i>	Yes (2) (9)	Yes (2)	Yes (8)	No	No	No	No	No	No	No	No
<i>Image</i>	No	No	No	Yes (8)	Yes (8)	No	No	No	No	No	No

<b>Previous Format</b>	<b>New Format</b>										
	<b>Char</b>	<b>Oracle - Long Char *</b>	<b>Long Char</b>	<b>Image</b>	<b>Long Char - Raw Binary</b>	<b>Number/ Signed Number **</b>			<b>Date</b>	<b>Time</b>	<b>Datetime</b>
						<b>SmallInt ***</b>	<b>Integer ****</b>	<b>Decimal *****</b>			
<i>Long Char - RawBinary</i>	No	No	No	Yes (8)	Yes (8)	No	No	No	No	No	No
<i>SmallInt ***</i>	Yes (5)	Yes (5)	No	No	No	No Action	Yes (4)	Yes (4)	No	No	No
<i>Integer ****</i>	Yes (5)	Yes (5)	No	No	No	Yes (4)	No Action	Yes (4)	No	No	No
<i>Decimal *****</i>	Yes (7)	Yes (7)	No	No	No	Yes (3)	Yes (3)	Yes (3)	No	No	No
<i>Date</i>	No	No	No	No	No	No	No	No	No Action	No	No
<i>Time</i>	No	No	No	No	No	No	No	No	No	No Action	No
<i>Datetime</i>	No	No	No	No	No	No	No	No	Yes (6)	Yes (6)	No Action

<b>Notes</b>	
*	with length < 2000
**	where n = length and d = decimal. See notes ***, ****, and *****
***	n < 4, d = 0; n = 5, d = 0 RawBinary
****	n > 4, d = 0; n = 10, d = 0 RawBinary
*****	n > 9, d > 0
1	If data fits or data truncation is allowed.
2	Not allowed in Oracle.
3	If data fits or data truncation is allowed (for decimal portion only).
4	If data fits. No data truncation can occur, even with the option to allow data truncation.

<b>Notes</b>	
5	If data fits.
6	If data truncation is allowed by selecting the Truncate data if field too short option on the Alter tab of the Build Settings dialog box.
7	If data fits, except if data has decimal values.
8	If image or long character change from Null to Not Null or Not Null to Null, otherwise, no action.
9	Allowed on all platforms.

## Alter Process Tips

As you create and run alter scripts, keep the following information in mind.

- Temporary tables during alter:

When you run the Alter process, the script might create a temporary table. Temporary tables are named PSY%tablename%, and they are created in the tablespace of the altered table, that is, the tablespace currently defined in the record definition.

- Alter process on tables containing LONGS on Oracle:

Oracle does not allow an INSERT or SELECT FROM command if a table contains a LONG VARCHAR or LONG RAW data type. Therefore, in Oracle databases, PeopleSoft Application Designer uses an Oracle PL/SQL script to perform alters on tables that contain any type of LONG data type.

- Alter process on Oracle on records with CHAR fields greater than 1333 bytes but less than 2000 bytes:

For Oracle, records with CHAR fields of length greater than 1333 characters and less than 2000 characters will appear in the alter SQL script as needing to be altered, even if the information has not changed. In Oracle Unicode databases, PeopleSoft applications triple the length of a field while creating a table with a VARCHAR2 column in the database to store all three bytes of the Unicode character. In Oracle databases, VARCHAR2 can store up to 4000 bytes, which means a restriction exists to store only 1333 characters (with three bytes each).

For example, if a LONG CHAR field is designed with a length of 1999 characters, then PeopleSoft applications interpret the field as a VARCHAR2 and create the column with a size of 1333 characters. The field length of that LONG CHAR field will be stored as 1999 in the PSRECFIELD table, but in the database it will be created with a size of 1333. So, each time a record with a LONG CHAR field of 1999 (or any value > 1333), the alter process detects the difference between the 1999 character length in PSRECFIELD and the 1333 character length in the database and generates the alter script. In addition, PeopleSoft applications also create a constraint on the VARCHAR2.

- View dependencies:

PeopleSoft Application Designer does not keep track of view dependencies. When the structure of a table changes, you should recreate all views. Many database environments track this information, so you might be able to determine view dependencies by issuing a query directly against the system

catalog. However, if you are not the DBA, you might not have the authority to run such a query successfully.

Also, renaming or dropping a table, view, or column might invalidate view text, dynamic view text, and possibly other stored queries.

This table describes what happens to views by database platform:

<b>Database Platform</b>	<b>What Happens to the Dependent Views When a Table Is Dropped?</b>	<b>Do the Inoperative Views Become Operative When the Table is Recreated?</b>	<b>Comments</b>
Microsoft SQL Server	Becomes inoperative.	Yes	The dependency reported by sp_depends is incorrect until you recreate the view.
Oracle	Becomes inoperative.	Yes, but only after the first use of the dependent view.	The VIEW object that became invalid remains invalid until its first use. The Oracle catalog table for objects marks the view as valid again.
Db2 for z/OS	Is dropped when the table is dropped.	NA	Views need to be recreated because the system drops them along with the table drop.

- Alter script:

After you invoke the Alter process, the system uses the default value that is defined in the record definition to populate the column in the altered table. The alter script that is generated contains detailed comments indicated by the (--) to assist you if you must modify the script manually.

- Preserve storage parameters on Oracle databases:

Alter by table rename preserves customized storage parameters for tables only (with some limitations) not for indexes, by taking DDL parameters from the system catalog.

## When to Alter Tables

The following record definition changes affect synchronization with the application table and require an alter process:

- Add or delete a field in the record.
- Modify the length of a field.
- Change the required status of a date, time, Datetime, or long field.
- Rename a field.
- Rename a record.

The Alter Table process is similar to the Create Table process except that it does not drop existing application data tables and the data that they contain.

---

**Note:** The Build process automatically alters records with more than 16 keys to support functional indexes. A warning message indicating this is included in the log file for Microsoft SQL Server.

---

## Working With Alters on Db2 for z/OS

You must be aware of a variety of considerations and maintenance tasks when performing alters on Db2 for z/OS. For example, you must consider:

- Tablespace versioning.
- Advisory Reorg Pending status.
- Rebuild Pending status.
- Avoiding SQL Code -4702.

These topics are discussed in detail in "Working with Alters on DB2 z/OS" (PeopleTools 8.58: Data Management).

## Determining Tables To Be Altered After a Field Change

To determine tables to be altered after a field change:

1. Create a new project.
2. Open the altered field.
3. Select Edit > Find Definition References.

The referenced definitions appear in the output window.

4. Select all of the rows that appear in the output window.
5. Right-click the selected rows and select Insert Into Project from the pop-up menu.

## Altering a Table

To alter a table:

1. Open the project for which you must perform an alter.
2. From the Build menu, select the appropriate scope of your build.

The Build dialog box appears.

3. Select the Alter Tables option in the Build Options group box.

Selecting the Alter Tables option automatically selects and disables the Create Indexes and Create Trigger (only if triggers are needed) option. In the Build Execute Options group box, only the Build script file option is enabled.

4. Click the Settings button in the Build dialog box to set user-defined defaults.



Select the appropriate alter, logging, and scripts settings.

---

**Note:** The alter process takes care of the indexes, regardless of the Alter Table Options you select on the Alter tab of the Build Settings dialog box. In the case of the Alter by Table Rename option, the indexes are dropped automatically when the temporary table is dropped. For the Alter in Place option, the index creation process goes through the Recreate index only if modified option on the Create tab.

---

- In the Build dialog box, click Build to run the Alter Tables process.

The length of a build process depends on the number of definitions that require building. Watch the Build Progress dialog box to monitor the Build process. When the process completes, check any errors listed in the log file.

## Specifying Alter Options

Access the Build Settings dialog box and select the Alter tab.

### Image: Build Settings dialog box: Alter tab

This example illustrates the fields and controls on the Build Settings dialog box: Alter tab. You can find definitions for the fields and controls later on this page.

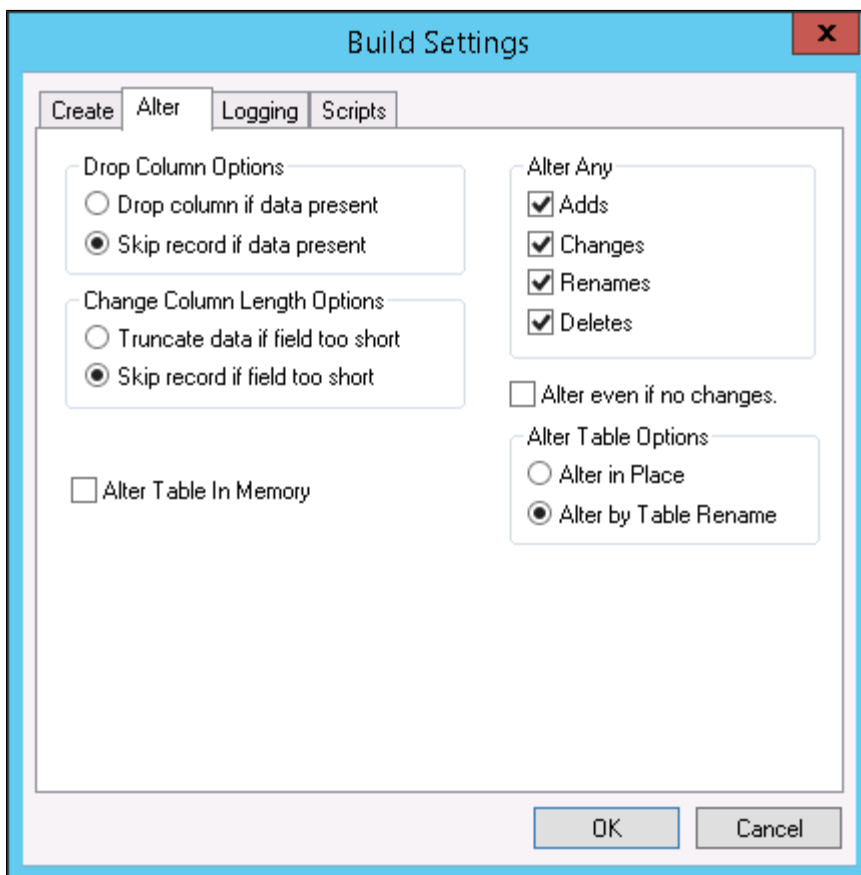

## Drop Column Options

These options are referenced whenever a field is deleted from a PeopleTools record definition in which data exists in the database for that column.

<b>Drop column if data present</b>	Select to drop the column and data, and write a warning to the build log.
<b>Skip record if data present</b>	Select to end the alter for that record and write an error message to the log. Processing continues with the next record.

---

**Note:** Whenever you select the Drop column if data present option, you run the risk of losing data, and you are prompted at runtime to confirm your selection of this option.

---

## Change Column Length Options

Use these options whenever the length of a character column is reduced in PeopleTools and an alter could result in data truncation.

<b>Truncate data if field too short</b>	Select to alter the record and write a warning message to the build log. Note that the system does not truncate data for numeric fields because of possible data loss.
<b>Skip record if field too short</b>	End the alter for that record and write an error message to the build log. Processing continues with the next record.

---

**Note:** Whenever you select the Truncate data if field too short option, you run the risk of losing data, and you are prompted at runtime to confirm your selection of this option. Also, numeric fields are not truncated to avoid any loss of data.

---

## Alter Table In Memory

If you have selected any of the Oracle In Memory options for your record or record fields, you need to select Alter Table In Memory for those options to take effect and alter the table.

See the Oracle In Memory option for records description here: [Setting Use Properties](#).

See the Oracle In Memory option for record fields description here: [Setting Record Field Use Properties](#).

The following example illustrates the build script generated for a table with All Fields selected on the record definition Oracle In Memory settings, and all record fields contained in that record definition are supported for IM column store processing.

```
ALTER TABLE PS_QE_JOBCODE_TBL INMEMORY MEMCOMPRESS FOR QUERY PRIORITY
  LOW
/
SELECT COUNT(*) FROM PS_QE_JOBCODE_TBL
/
```

The following example illustrates the build script generated for a table with All Fields selected on the record definition Oracle In Memory settings, and all record fields contained in that record definition *are not* supported for IM column store processing.

```
Alter in memory ALL qe book selective
```

```
ALTER TABLE PS_QE_BOOK INMEMORY MEMCOMPRESS FOR QUERY PRIORITY LOW NO
  INMEMORY (QE_BOOK_DESCR, QE_BOOK_COVER_IMG)
/
SELECT COUNT(*) FROM PS_QE_BOOK
```

Note that the system adds the `NO INMEMORY (QE_BOOK_DESCR, QE_BOOK_COVER_IMG)` statement automatically, including the fields that are not supported for IM column store processing. These fields are of type Long Character and Image, respectively.

The following example illustrates the build script generated for a table Selective Fields selected on the record definition Oracle In Memory settings, and all record fields contained in that record definition are not supported for IM column store processing. In this case, the `NO INMEMORY` statement will include automatically the record fields that are not supported for IM column store processing and the record fields not selected (manually) for IM column store processing.

```
ALTER TABLE PS_QE_BOOK INMEMORY MEMCOMPRESS FOR QUERY PRIORITY LOW NO
  INMEMORY (QE_ADDED_DT, QE_BOOK_DESCR, QE_BOOK_COVER_IMG, PSIMAGEVER)
/
SELECT COUNT(*) FROM PS_QE_BOOK
/
```

## Alter Any

PeopleTools assumes that you want to perform alters for any modifications made to tables, so, by default, all of the check boxes in the Alter Any group box are selected. The Alter Any group box enables you to customize alter processing for adds, changes, renames, and deletes. For example, you have the flexibility to add, change, and rename fields but not to delete any removed columns. When you complete any other custom external conversion processes, you can then enable the delete processing to drop columns that are no longer defined.

Normally, you select all of these options, but during upgrades or operations requiring data conversion steps you might select a subset of actions. For example:

- Perform alter with Adds and Changes selected.
- Perform data conversion routines to populate the new and changed columns (perhaps from columns that are ultimately to be dropped).
- Perform alter with Rename and Delete selected.

## Alter even if no changes

Select this check box to force an alter, even if no changes were made to the tables. This check box is deselected by default. If selected, the Alter by Table Rename option in the Alter Table Options group box is automatically selected and the Alter in Place option is disabled.

## Alter Table Options

When altering tables, the alter process takes care of the indexes, regardless of the Alter Table Options you select on the Alter tab of the Build Settings dialog box. In the case of Alter by Table Rename, the indexes are dropped automatically when the temporary table is dropped. For the Alter in Place option, the index creation process goes through the Recreated index only if modified option on the Create tab.

- Alter in Place

Selected by default. For database platforms in which Alter in Place is not supported, alter is automatically done by Alter by Table Rename (even if that option is not selected).

Database platforms vary in the capabilities for Alter in Place table operations. This table displays the limitations for each operation by platform:

<b>Database Platform</b>	<b>Add Column</b>	<b>Change Column (data type, size, precision, scale, and null/not null property change)</b>	<b>Rename Table</b>	<b>Delete Column</b>
Microsoft SQL Server	Yes *	Yes *	Yes *	Yes *
Oracle	Yes *	No	Yes	Yes *
Db2 for z/OS	Yes *	Yes *	Yes *	No

\* Certain restrictions might apply to this operation. Refer to the documentation for your specific database platform for more information.

- Alter by Table Rename

Select to create a temporary table (with changes made to the original table or its fields); the data from the original table is imported into the temporary table. The original table is then dropped and the temporary table is renamed to the original table.

---

**Note:** For Oracle databases only, Alter by Table Rename preserves customized storage parameters for tables (with some limitations), by taking DDL parameters from the system catalog.

---

If a table is renamed from the old name to a new name, the indexes that were created for the old table are moved to the new table, but the index names remain in the name of the old table. With Alter by Table Rename selected, the indexes of the old table are dropped before being renamed to the new table name, and the indexes are recreated after the table is renamed to the new name. This way, the index is created in the name of the new table.

See "Working with Alters on DB2 z/OS" (PeopleTools 8.58: Data Management).

## Confirming Your Table Alter

To confirm your table alter:

1. Review the SQL script that was generated by the Alter process.

Use your native SQL command processor to open the SQL script. The script is located where you specified on the Scripts tab of the Build Settings dialog box.

2. Run the script against your database.
3. Use your query tool and SQL Select statements to confirm that the Alter Tables process created an application table that corresponds to your record definition and updated the system catalog tables.

---

## Creating Triggers

A database trigger is a type of stored procedure that runs automatically when a user makes a specific data-modification statement (INSERT, UPDATE, or DELETE) on a specified table. Within PeopleTools, you create triggers for optimization servers. Do not create triggers for all records; create them only for records that have specific properties set.

### Related Links

"Creating and Building Optimization Records" (PeopleTools 8.58: Optimization Framework)

---

## Creating Views

This section provides an overview of online views and discusses how to:

- Create views.
- Use joins in views.
- Use cross-platform meta-SQL for dynamic views.

## Understanding Online Views

Views in PeopleSoft applications are comparable to views used in traditional relational database management system (RDBMS) technology. A view, in essence, is a virtual table. It is created from the results of a query run against one or more tables.

When you create views to use online, you must keep the views synchronized with the database. Like SQL tables, you must have a record definition for online views because the system checks the record definitions for online processing rules. You must build the view before you can use or reference it online.

If you use a view as the basis for a page, you select existing information to display on the page. Therefore, when you create the record definition for your view, you can clone an existing record definition, delete any fields that are not used in the view, and proceed to define the view. Query views are processed the same way as view text, which is defined as part of the record.

The order in which PeopleTools creates views is based on the build sequence number that you set on the Record Type tab while the record is open. The default build sequence number is 1. For the dependent views to be created first, the build sequence number should be 0. This way, all of the 0 views are created first, then the 1 views, and finally the views that are greater than 1. The maximum build sequence that can be set is 99. Although the views are sorted alphabetically in the project, they are created based on the build sequence number.

### Related Links

[Creating SQL View and Dynamic View Select Statements](#)

[Understanding Record Types](#)

## Creating Views

If you are already familiar with creating record definitions and writing SQL queries, creating online views is similar.

To create online views:

1. Clone a record definition:
  - a. Open an existing record definition.
  - b. Select File > Save As.
  - c. Specify the name of the view that you want to create.

2. Delete and add the appropriate fields.

All columns that are selected in your view should have a corresponding field in the record definition.

3. Set the record type to SQL View:
  - a. Select the Record Type tab for the record definition.
  - b. Select SQL View in the Record Type group box.

4. Click the Click to open SQL Editor button.

The order in which you list the columns in your SQL SELECT statement should match the order that you specified in the record definition. A SQL statement can be given for each platform.

See [Creating SQL View and Dynamic View Select Statements](#).

5. Save the record definition.
6. Select Build > Current Definition to create the view in the database.
7. Select the Create Views check box under Build Options.
8. Click Build.

## Using Joins in Views

If you plan to use a join regularly, you can save it as a SQL script or you can create a view—a single virtual table—using the join as the logical representation of the data. After you create a view, the users never need to know that the data they are viewing is stored in multiple tables. To users, the relative complexity of your view is transparent. For example:

```
SELECT A.EMPLID,
       A.NAME,
       B.CONTACT_NAME,
       B.RELATIONSHIP
FROM   PS_PERSONAL_DATA A,
       PS_EMERGENCY_CNTCT B
WHERE  A.EMPLID = B.EMPLID;
```

## Using Cross-Platform Meta-SQL for Dynamic Views

PeopleTools includes functionality to produce meta-SQL constructs for dynamic views, which means that dynamic SQL views that are created using PeopleSoft Application Designer can be used on any platform that is supported by PeopleSoft. The *PeopleTools: PeopleCode Developer's Guide* contains a full list of the meta-SQL that is supported in the PeopleSoft Internet Architecture.

### Related Links

"Meta-SQL Placement Considerations" (PeopleTools 8.58: PeopleCode Language Reference)

---

## Administering DDL

Select Data Administration from the Tools menu in PeopleSoft Application Designer to access critical dialog boxes that enable you to define the record location and structure and other guidelines for PeopleTools to extract information from your selected database.

This section discusses how to:

- Use the record DDL.
- Set the tablespace.
- Use physical data storage.
- Manage partition DDL.

## Using the Record DDL

Use the record DDL to define parameters and default values for the tables in your database. PeopleSoft applications provide templates for each database platform that PeopleTools supports. The templates contain the typical parameters for each database platform. The mechanics of editing and viewing record, index, and unique index DDL are the same as for space DDL.

Access the Maintain Record DDL dialog box from Tools > Data Administration > Record DDL. The Data Administration menu option is only enabled if a record definition is open.

**Image: Maintain Record DDL dialog box**

This example illustrates the fields and controls on the Maintain Record DDL dialog box. You can find definitions for the fields and controls later on this page.

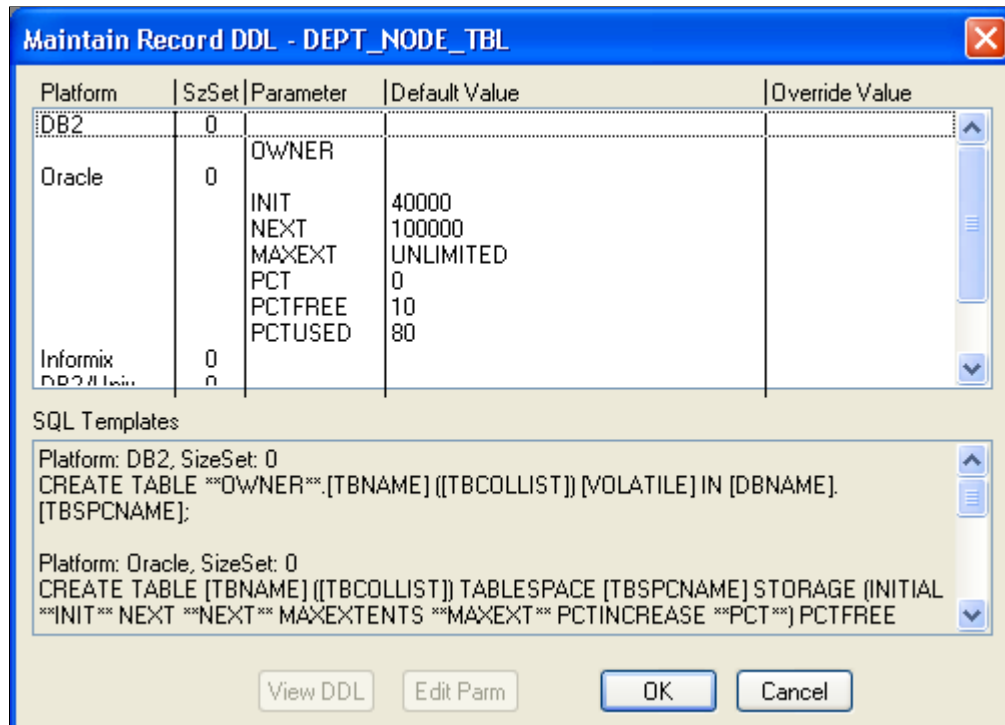
**View DDL**

Select a Platform row in the Maintain Record DDL dialog box to enable the View DDL button. This button opens the DDL Statements dialog box, which displays the CREATE TABLE DDL for the current record on each of the database platforms.

**Edit Parm** (edit parameter)

Select a Parameter row in the Maintain Record DDL dialog box to enable the Edit Parm button. This button opens the Edit Override Parm Value dialog box, where you can enter a new value to override the Default Value listed in the table. The new value is stored in the PSRECDDLPRM override table.

**Setting the Tablespace**

The Change Space dialog box is an editing tool with which you can select the space name and view the records attributed to the named space in the database.

Access this dialog box by selecting Tools > Data Administration > Set Tablespace. This dialog box also appears automatically when you attempt to save a new record definition. For each new record definition that is created in PeopleSoft Application Designer, you must allocate a tablespace name. For the Change Space dialog box to appear upon saving a new record definition, you must select the Platform Compatibility Mode check box under PeopleTools > Utilities > Administration > PeopleTools Options.



**Image: Change Space dialog box**

This example illustrates the fields and controls on the Change Space dialog box. You can find definitions for the fields and controls later on this page.

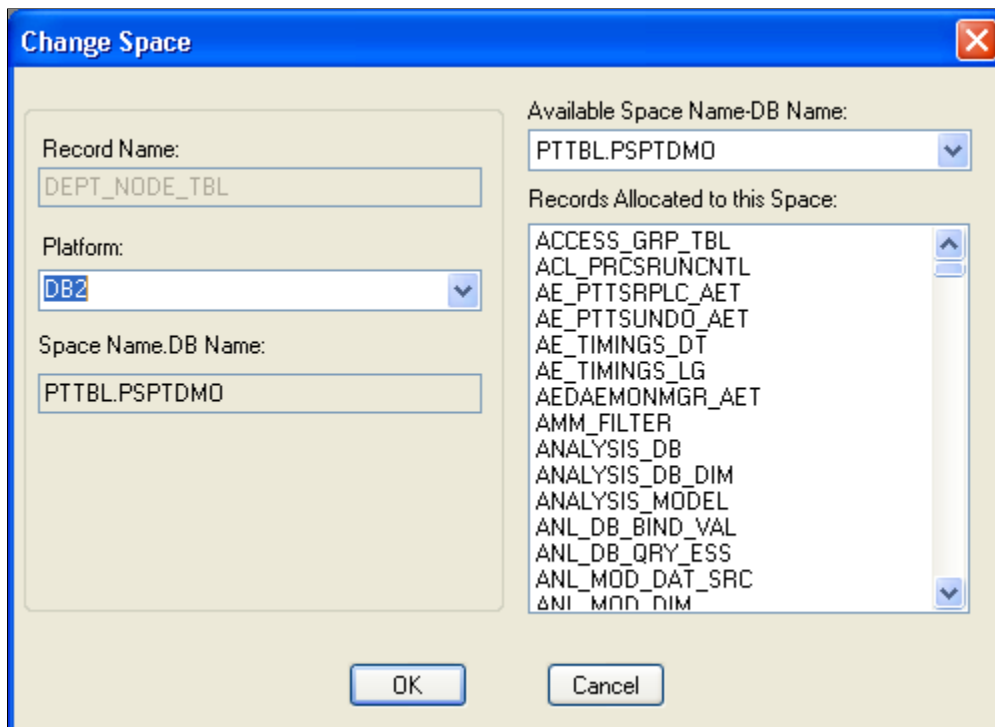

<b>Record Name</b>	Displays the name of the current record definition. This field is display-only.
<b>Platform</b>	Select from the available database platforms to which you can assign the designated space name.
<b>Space Name.DB Name</b> (tablespace name.database name)	Displays the available space name that is assigned to the current record. This field is display-only.
<b>Available Space Name-DB Name</b> (available tablespace name-database name)	Select the space name and database name to assign to the record.
<b>Records Allocated to this Space</b>	Displays all of the records that are already allocated to the space that you selected from the Available Space Name-DB Name drop-down list box. This field is display-only.

## Using Physical Data Storage

You have control over the physical storage of your data. You can view and edit the DDL for creating tables, indexes, and tablespaces in the browser.

Access the DDL Model Defaults page (PeopleTools > Utilities > Administration > DDL Model Defaults.)

**Image: DDL Model Defaults page**

This example illustrates the fields and controls on the DDL Model Defaults page. You can find definitions for the fields and controls later on this page.

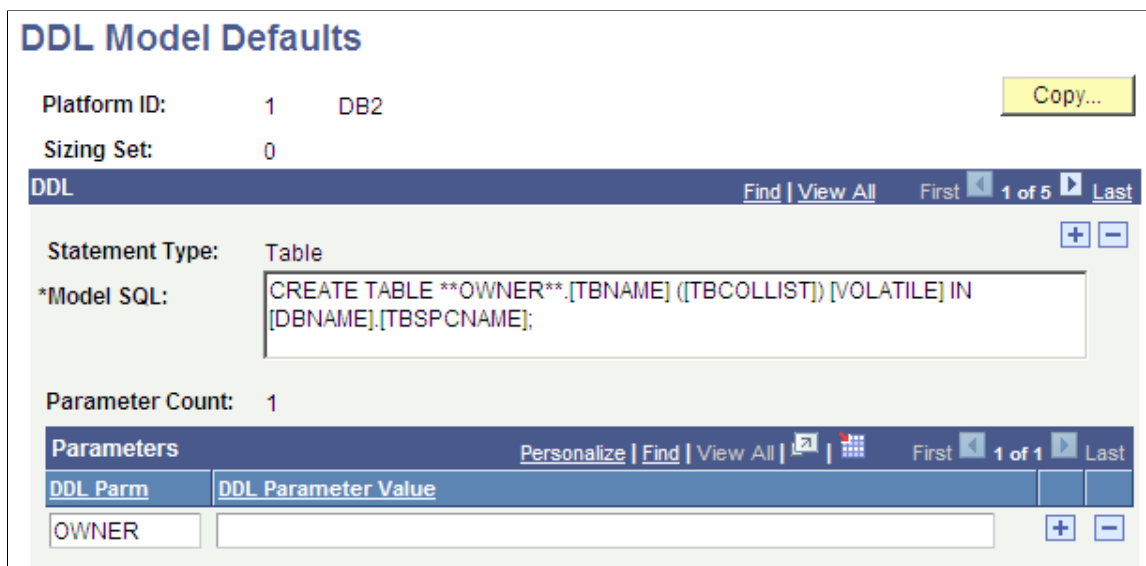

To view or edit the DDL parameters for creating tables, indexes, and tablespaces:

1. Open the component.
2. Press the Enter key to view platform names.
3. Select a platform name.

The DDL Model Defaults page appears.

The Model SQL edit box shows the DDL template for the specified platform and sizing set. The items in square brackets are special parameters that are populated when instances of SQL are generated. For example, the preceding example shows an index model statement for ALLBASE. In this example:

- [TBNAME] is the name of the table.
- [TBCOLLIST] is replaced by the columns that are specified in the index definition.

The model statements also contain parameter names enclosed in pairs of asterisks. A parameter name is replaced by a value when instances of the SQL are generated. The preceding example has one parameter, **\*\*FILESET\*\***. When DDL is generated using this model, the FILESET parameter is replaced by FILE unless it is overridden for the specific record or tablespace. The other text in the model statement is copied to the generated SQL.

**Related Links**

"Using Administration Utilities" (PeopleTools 8.58: System and Server Administration)

**Managing Partition DDL**

On Oracle databases, you can implement Oracle Partitioning.

Partitioning enables you to subdivide tables and indexes into smaller pieces, such that the database system can access and manage the partitioned objects at a finer level of granularity. This provides for more efficiency for administration with faster backups, for example, and for better transaction performance with queries being able to isolate the relevant data more quickly through partitions.

To manage partition DDL, in Application Designer select Tools > Data Administration > Partitioning.

### Image: Maintain Partitioning DDL dialog box

This example illustrates the use of the Maintain Partitioning DDL dialog box for managing partitioning DDL.

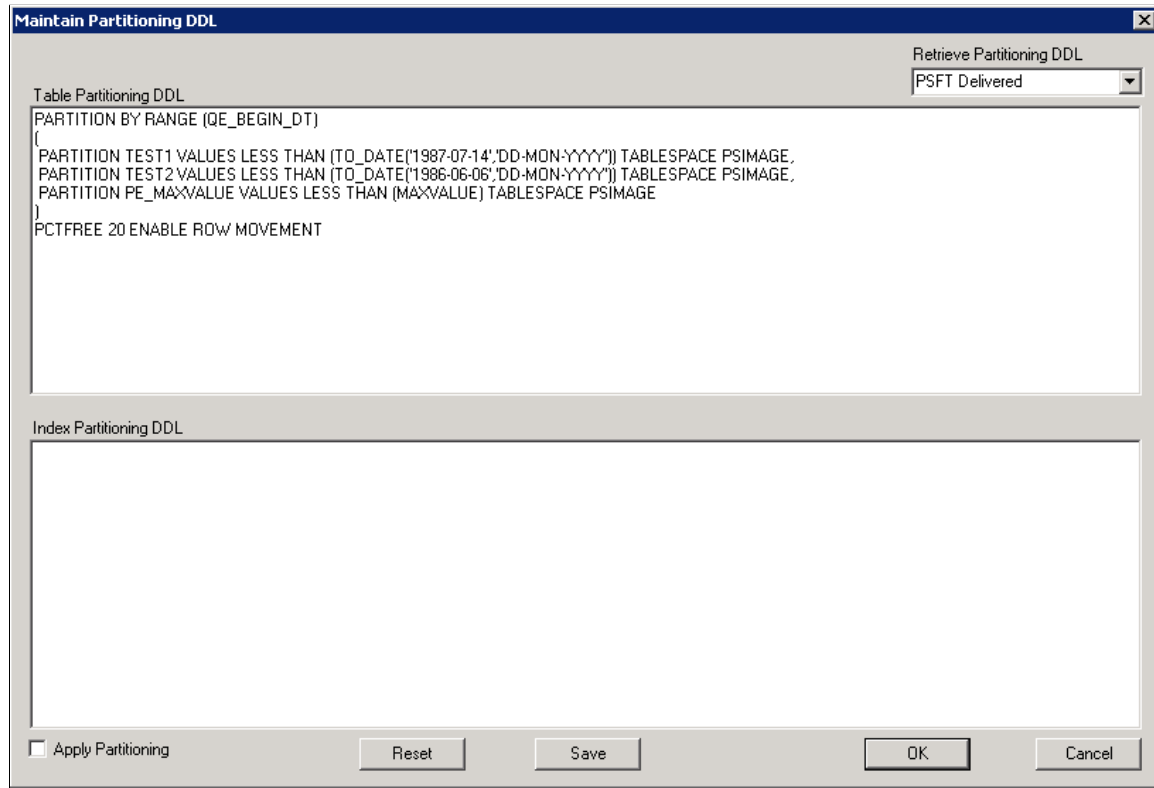

---

**Important!** PeopleTools performs no validation on SQL entered in the Table or Index partitioning DDL edit boxes. You must validate the syntax on your own.

---

Details for implementing this feature are covered in the product documentation for *PeopleTools: Data Management*.

### Related Links

"Maintaining Partition Definitions" (PeopleTools 8.58: Data Management)



# Using Page Controls

---

## Understanding Page Controls

You use three categories of controls for page design and development. You determine which types of controls you want to add to your page definition by considering how you want to organize information on a page, as well as how your users will enter data.

This section discusses:

- Aesthetic controls.
- Data entry controls.
- Function and data processing controls.

## Aesthetic Controls

Use aesthetic controls to help organize, display, or emphasize information on a page. Usually, aesthetic controls are not associated with a particular record field that is defined in a record definition and maintained in a database. With the exception of the image control, these controls never update data in the database. Aesthetic controls include:

<b>Chart</b>	Draws a frame that serves as a placeholder for a chart that you instantiate using the GetChart function in PeopleCode. Using the chart control, you draw a box in which the chart appears to the user at runtime. Associate the chart control with a record field in a record definition.
<b>Frame</b>	Draws a display-only box of variable size to visually group a set of controls on a page. You can draw a frame around almost any control. You can isolate controls, such as HTML areas, from other controls on a page and then hide the frame. Frames generate HTML tables for viewing in a browser.
<b>Group Box</b>	Draws a display-only box of variable size with a text label to visually group and identify related controls, such as radio buttons. Like a frame, you can resize a group box to any length or width. However, with a group box you can assign a visible label. Like frames, group boxes generate HTML tables for viewing in a browser.
<b>Horizontal Rule</b>	Draws a horizontal line to separate parts of a page. Use a horizontal rule control as a visual break between controls.
<b>Image</b>	Draws a frame that you can associate with a variable image from a record field in a database. The record field stores a

graphic, such as a scanned image of an employee or a picture of an asset, in the format that you defined in the record definition.

Because an image can change at runtime and is associated with a record and field definition, it is considered a data entry control and an aesthetic control.

The field that you associate with your image can be either a standard Image type field or an ImageReference type field, where images might be associated with it depending on user input. The ImageReference field type is a pointer to an image definition, which enables you to display images dynamically. An example of this is referencing a red, yellow, or green light image definition on a page, depending on the context when the page runs.

See [Specifying Image Field Attributes](#).

See [Specifying ImageReference Field Attributes](#).

### **Static Image**

Draws a frame that you can associate with an image definition.

It can help organize or identify information that appears on a page. A static image is different from an image because it does not change at runtime, and it is not associated with a record field but instead with a predefined image definition.

For example, you might select a static image, such as the yellow Clear button, from the image catalog and place it on top of a push button control so that the user knows to click that button to clear the contents of the page.

See [Understanding Image Definitions](#).

### **Static Text**

Adds a static text item, a display-only alphanumeric field with a maximum length of 60 characters, to describe a page, control, or group of controls.

You might use static text for a static note, an extension of a control label, and occasionally a control label itself. You should avoid using text items because they make it more difficult to translate pages to other languages. Instead, you should reference message catalog text to facilitate translation and other maintenance issues. Other methods of displaying text on a page are display-only edit boxes, field labels, and display-only long edit boxes.

The system disables the static text button when you

## **Data Entry Controls**

Use data entry controls to offer different ways to enter and maintain information. These types of controls are always associated with a record field that is defined in a record definition and maintained in a database.

---

**Note:** PeopleSoft Application Designer allows you add up to 405 fields on a page. When you reach this limit, typical system behavior includes being unable to select, move, or edit the page fields with an order number exceeding the 405-field limit. While this limit has no effect on the page at runtime, it has the potential to disrupt productivity during design time. If you find a page nearing the 405-field limit, you should use subpages to decrease the number of fields on a single page.

---

See [Using Subpages](#).

**Check Box**

Adds a small square box that operates as a toggle switch—on and off—for data controls that can have one of two values (yes or no, 1 or 0).

During data entry, when the page is saved, the enabled or disabled value (whichever represents the current state of the check box) is written to the database. If values are specified in the page definition, the fields are left blank in the database, but you can still select or deselect the check box on the page. You will not know that the database fields are blank until you run a query or report on the field.

**Drop-Down List Box**

Adds a drop-down list box from which you select a single value from a list of valid values. Use drop-down list boxes to enable data selection from a list of three or more possible choices. In its closed state, the control displays the current value for the control. The user opens the list to change the value.

Drop-down list boxes are a good design choice when presenting users with a small number of selections from which they must select one value. However, when designing for grids and scroll areas, prompts give you better performance.

**Edit Box**

Adds an edit box, which you use for data entry. You also use edit boxes for displaying fields and translatable text. Use an edit box for text data entry, for example, for a record field that is defined as character, number, signed number, or date.

**Long Edit Box**

Adds a long edit box, which is a variable-length, alphanumeric control used for entering long, textual items, such as comments. The length of the control is determined by its content rather than the physical size of the box on the page.

Use long edit boxes to display long, translatable text. Each long edit box has a built-in scroll bar that enables users to enter and display more data than can be shown at one time on a page. The scroll bar on the long edit box is used only to scroll through the text in the long edit box.

Unlike edit boxes, which are limited to the field size that is defined in your record definition, long edit boxes can contain a relatively unlimited number of characters, up to a theoretical maximum of 64KB. This space, however, is shared by a number of other programming elements, so the true size might be closer

to 15 to 25KB, depending on the location of the field in your application and the state of the application.

Typically, you use long edit boxes for comments or descriptions, or you configure the long edit box as a rich text editor.

See [Setting Options Properties](#).

### **Radio Button**

Adds a small, round button that represents one value for a control with multiple defined values. Add radio buttons in groups. A user can select only one radio button in a group at one time, like station buttons on a radio—hence the name. Use radio buttons to enable selection of one out of two possible choices. If you have three or more choices, use a drop-down list box.

### **Subpage**

Adds a predefined, presized group of controls, such as address controls, that are defined in a separate subpage definition.

During design time, you add only the subpage control to represent all of the controls in the subpage. You maintain those controls in only one place, the subpage definition. At runtime, you see all of the controls that are defined in the subpage on the page.

## **Function and Data Processing Controls**

Use function and data processing controls to provide a mechanism for running commands and to maintain levels of information on a page.

### **HTML Area**

Adds an area where you can write your own HTML. With other controls, the PeopleSoft system automatically generates the HTML code and then inserts the HTML code into the dynamically generated code at runtime.

See [Using HTML Areas](#).

### **Tree**

The dynamic tree control is a deprecated feature. Use PeopleCode with the HTML area to create a hierarchical tree.

### **Push Button/Hyperlink**

Adds a push button or link that represents an internal or external link, PeopleCode command, process through PeopleSoft Process Scheduler, prompt action, scroll action, secondary page, or toolbar action. You can specify whether the control appears as a traditional push button or as a link (highlighted, underlined text).

### **Secondary Page**

Adds an invisible control that associates a secondary page with the primary page. You then associate the secondary page with a command push button, link, or a pop-up menu. Secondary pages gather or display supplemental information that is related to the data in a primary page but less frequently referenced or updated. Secondary pages are displayed using the **DoModal** and **DoModalComponent** PeopleCode functions.



See [Using Secondary Pages](#).

See "DoModal" (PeopleTools 8.58: PeopleCode Language Reference).

### **Scroll Area**

Provides an easy way for you to group or repeat multiple fields of data in a defined area. Like a grid, users can easily navigate through the rows using links and buttons in a navigation bar, and they can add or delete rows using push buttons. These features are automatically placed in the navigation bar. The navigation bar also provides several other settings, such as a Find feature that enables the user to search all fields and rows for specific data and a View All option so that the user can see all rows of data at once.

You can place the fields in the scroll area randomly, one on top of the other, or side by side. Unlike a grid, you are not limited to the type of controls that you can place in a scroll area. You can even place a grid inside a scroll area.

### **Scroll Bar**

Like the scroll area, scroll bars contain push buttons and links for navigation, but not in the form of navigation bars. Developers must manually position all navigation items.

Like grids and scroll areas, the actual scroll control that you see in PeopleSoft Application Designer when working with scroll bars in page definitions does not appear at runtime. Instead, the scroll bar control has scroll action buttons to replace the visual rendering of the scroll bar as push buttons and links on the web.

### **Grid**

Adds a grid, which looks and behaves like a spreadsheet that is embedded in a page. It has column headings and cells and uses push buttons, links, and tabs to navigate through the data. It is similar to a scroll area on a page. Each row in the grid corresponds to a set of controls in a scroll occurrence.

Navigation links and push buttons replace the actual visual scroll bar, and add and delete push buttons enable a user to insert and delete rows. Use instead of a single-level scroll area or scroll bar to manage multi-row sets of data.

---

## **Using Charts**

Use the Chart Properties dialog box to:

- Associate a chart with a record definition and record field.
- Assign a page field name.
- Set label attributes.

- Set the chart as a page anchor.

On the Label tab, add an information-only name for your chart. This label does not appear at runtime, but it does appear on the control order list on the Order tab of the page definition and any page definition report that you print. Assigning a label is helpful if you have multiple charts on your page.

## Related Links

"GetChart" (PeopleTools 8.58: PeopleCode Language Reference)

---

## Using Frames

---

**Note:** Frames are not supported in fluid applications.

---

Use the frame control to visually group a set of controls on a page.

To change frame labels and display options:

1. Double-click a frame to open the Frame Properties dialog box.
2. On the Label tab, enter a brief text description of the function of the controls in the frame.

The default frame label is *Frame*. Any label that you attach to a frame is for information only—it does not appear on your page, but it does appear on the page definition printout and in the control order list. Use labels to differentiate among multiple frames on your page.

For example, if you are enclosing address controls, you might use the label *Address Frame*.

3. Select the style for the frame.

You can control the line color and thickness and the background color of a frame by specifying a style.

See [Understanding Style Sheets and Style Classes](#).

4. Select the Hide Border check box to hide the border of a frame.

Use this option to use the style to shade only the background of the framed area or to apply other styles. If you select Hide Border, it overrides the border options that are specified in a style.

You might also use a frame with a hidden border to facilitate HTML generation. When you insert a frame in a page section, the system generates that section as a table in HTML. This functionality is useful to ensure the correct layout. However, in some browsers, adding more HTML tables can degrade performance.

See [Improving Online Performance](#).

5. Select the Adjust Layout for Hidden Fields check box to enable automatic vertical adjustments to the frame size when hidden fields are present.

If visible fields are not present to the right or left of the hidden field in a frame, the frame collapses to surround the remaining fields.

6. If the field is associated with multi-currency processing, select the Multi-Currency Field option on the Use tab in the Frame Properties dialog box.

This selection causes the field to appear at runtime only if the Multi-Currency option on the PeopleTools Options page is selected.

---

## Using Group Boxes

Use group boxes to visually associate relevant page field controls and to create a page that is intuitive to the user.

In fluid applications, group boxes have additional uses. See "Working with Group Boxes" (PeopleTools 8.58: Fluid User Interface Developer's Guide) for more information.

## Inserting and Moving a Group Box

To insert and move a group box:

1. Select Insert > Group Box.
2. Position the mouse where you want the initial location of the group box and click.
3. Move the group box to the appropriate location by clicking and dragging.
4. Adjust the group box size and shape using the handles on the edge of the group box.
5. Remove cursor focus from the group box by clicking anywhere outside of the group box in your page workspace.

## Setting Group Box Properties

Use group boxes to visually associate relevant page field controls and to create a page that is intuitive to the user.

### Setting Group Box Record Properties

Although the group box Record Field properties are optional, associating the group box with a record definition and record field enables you to:

- Distinguish individual group boxes when multiple group boxes appear on the page definition Order tab.
- Use PeopleCode to programmatically control the properties of the group box.

Access the Group Box Properties dialog box. Select the Record tab.

#### **Record Name**

Select the record definition to which you would like to associate this group box.

**Field Name**

Select the field definition to which you would like to associate this group box. Only the fields in the previously selected record definition appear in this list.

**Setting the Group Box Label Properties**

Use group box label properties to reflect how the fields that appear inside the group box are related.

In some cases, the group box may surround a variety of disparate controls. In those situations, you might opt to enter a label manually rather than associating the group box with a record definition and field.

Access the Group Box Properties dialog box. Select the Label tab.

1. Select the label Type:

**Text**

Select to enter the group box label manually. Selecting this option enables the Text field and disables the Label ID field.

---

**Note:** You do not enter the text until the next step.

---

**RFT Short** (record field text short)

Select to access the Short Name record field label properties of the record field that you associate with this group box. Selecting this option disables the Text field and enables the Label ID field.

---

**Note:** You do not select the label until the next step.

---

**RFT Long** (record field text long)

Select to access the Long Name record field label properties of the record field that you associate with this group box. Selecting this option disables the Text field and enables the Label ID field.

**Message Catalog**

Select to use a value stored in the message catalog as the label for the group box. Selecting this enables the Message Set/Number field in the Label Text group box.

2. Select or enter the specific Label Text.

**Text**

Enter or view the text that is to appear as the label in the group box header.

If you select the RFT Short or RFT Long label type, the system automatically populates this field based on the Label ID that you choose and then disables it.

Group box labels are limited to 50 characters, regardless of whether the label is static text or retrieved from the field definition.

**Label ID**

Select the value that is to appear as the label in the group box header. The values that appear in this list depend on the label type option that you selected in the previous step and the label properties of the field definition. Changing the

Label ID value automatically changes the value in the Text field.

See [Understanding Multiple Labels](#).

**Context**

Enter a context for the label.

**Message Set/Number**

Enter the message set and message number of the message catalog entry to be used as the group box label value. Available only if the Type selection is *Message Catalog*.

**Label Style**

Select a value to determine the look and feel of the label.

---

**Note:** Not all style classes are appropriate for labels. Changing the default style can produce unexpected results.

---

See [Overriding the Default Page Field Styles](#).

3. Select an Embedded Help Pop-up option. (See [Configuring Embedded Help for Scroll Areas, Grids, and Group Boxes](#) for more information.)

**No Popup**

Select this option to disable embedded pop-up help.

This value is the default.

**Message Catalog Popup**

Select this option to enable the embedded pop-up help icon on the grid at runtime. Selecting this option enables the Message Set/Number edit boxes.

**Message Set/Number**

Enter the message set number and message number of the message catalog entry to appear when the user clicks the embedded help icon.

**Text**

Displays the message that appears when the user clicks the embedded help icon. This field is display-only.

4. Select an alignment option for the label.
5. Select the Display Options of the label.

**Body Style**

You can control the color, line thickness, and background of the body section of a group box by specifying a style.

See [Understanding Style Sheets and Style Classes](#).

**Adjust Layout for Hidden Fields**

Select to have the group box adjust its borders to accommodate any hidden fields.

---

**Note:** For the group box to adjust automatically, the hidden fields inside the group box must be surrounded by open space or have other hidden fields to the right or left.

---

**Hide Border**

Select to hide the outside border of the group box. This selection overrides the border options specified in a style.

**Suppress Accessible Label**

Select to hide any label applied for accessibility reasons.

**Setting Group Box Use Properties**

Access the Group Box Properties dialog box. Select the Use tab.

**Multi-Currency Field**

Select to associate this field with multi-currency processing. If the Multi-Currency option on the PeopleTools Options page is selected, the field displays at runtime only.

**Hide all Fields when Group Box Hidden**

Select to hide all visible and hidden fields when the group box is hidden. Hide a group box by associating it with a record and field and invoking the relevant PeopleCode field class property.

See "Visible" (PeopleTools 8.58: PeopleCode API Reference).

**Collapsible Data Area**

Select to collapse the group box into a small image that the user must click to expand. Collapsing the group box enables the Default Initial View to Expanded State check box and enables you to select label images for both the expanded and collapsed states, typically small triangles.

Each time that a user opens or closes a collapsible section, a transmission to the application server is required. Therefore, the initial state of whether the collapsible section is open or closed is important. You should carefully evaluate the performance and usability aspects of using collapsible sections versus designing a long page that displays all of the data using deferred processing mode instead.

**Example of Collapsible Group Boxes**

Spain is expanded while the group boxes for France, Italy, and USA are collapsed:

**Image: Example of collapsible group boxes**

This example illustrates the fields and controls on the Example of collapsible group boxes. You can find definitions for the fields and controls later on this page.

History			Customize	Find	View All	First	1 of 1	Last
Effective Date	Military Status	Social Security Affiliation Dt						
1								

▶ France

▶ Italy

▶ USA

---

## Using Horizontal Rules

This section discusses how to:

- Draw a horizontal rule.
- Set horizontal rule properties.

### Drawing a Horizontal Rule

To draw a horizontal rule:

1. Select Insert > Horizontal Rule.
2. Draw a horizontal line of the appropriate length on the page.

### Setting Horizontal Rule Properties

This section discusses how to apply informational labels to a horizontal rule and configure how the horizontal rule is used on a page.

#### Setting Horizontal Rule Label Properties

To set horizontal rule label properties:

1. Open the Horizontal Rule Properties dialog box.
2. On the Label tab, enter an information-only label to differentiate the line from other frames and lines on your field order list.
3. Select the style for the line.

You can control the color and line thickness of a horizontal rule by specifying a style.

See [Understanding Style Sheets and Style Classes](#).

#### Setting Horizontal Rule Use Properties

Access the Horizontal Rule Properties dialog box. Select the Use tab.

##### Multi-Currency Field

See [Setting Use Properties](#).

##### Set to Level

Manipulate the occurs level of your controls on the page while still preserving the physical tab order at runtime. If you adjust the sequence of fields on the Order tab of the page definition, the tab order for the user at runtime is adjusted to that new order, which may not be the desired tab order. In which case, you can insert a horizontal rule, and set the level to apply to any control beneath the horizontal rule. In doing so, you can maintain a consistent, logical tab order.

Use this setting to specify a scroll level organization that differs from the order of page fields on the Order tab. For example, you

might want to create a page that contains multiple collapsing group boxes with each containing level-based controls. By placing a horizontal rule between each of the collapsing sections and setting the level to *0*, you return the occurs level to *0* so that you can add additional levels without having to alter the order of controls on the Order tab.

Likewise, assume you insert a hyperlink within a level 1 scroll area, but below a level 2 scroll area that exists within the level 1 scroll area. However, you want the hyperlink to be considered part of level 1 for tabbing purposes. By placing the horizontal rule between the level 2 scroll and the hyperlink and adjusting the Set to Level value to *1*, you can associate the hyperlink with the other level 1 elements for tabbing purposes.

See [Level-Based Controls](#).

---

## Using Images

This topic describes using images within PeopleSoft application.

### Understanding Static Images

A static image is different from an image because it:

- Does not change at runtime.
- Is not associated with a record field.

Static images are associated with a predefined image definition. For example, you might select a static image, such as a yellow Clear button, from the image catalog and place it on top of a push button control so that the user knows to click that button to clear the contents of the page.

### Adjusting Static Image Size and Shape

You can adjust the size of a static image by dragging the handles on the edge of the image box , or you can adjust the size in the Static Image Properties dialog box on the Label tab by changing the width and height in pixels.



## Setting Static Image Properties

### Image: Static Image Properties dialog box

This example shows the options available on the Static Image Properties dialog box. Descriptions of the options follow.

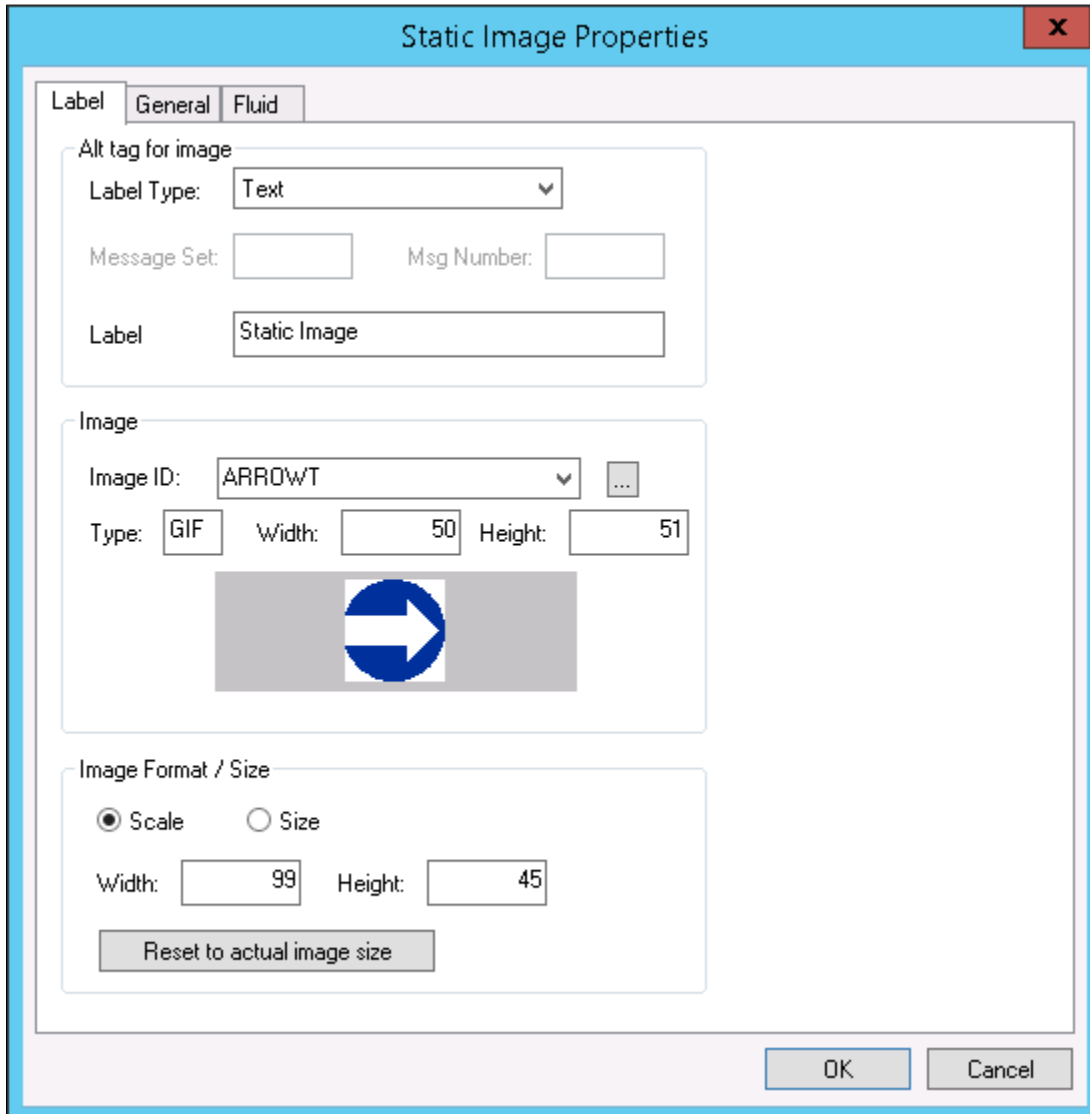

For more information on images, see [Understanding Image Definitions](#).

### Alt tag for image

#### Label Type

*None*: Select for no image label.

*Text*: Select to add an image label manually.

*Message Catalog*: Select if the label for the image is stored in the message catalog.

The label does not appear on your page at runtime. Use it to track your images in your scroll order list box and on page definition reports.

<b>Message Set</b>	If your label value is stored in the message catalog, specify the message set.
<b>Msg Number</b>	If your label value is stored in the message catalog, specify the message number.
<b>Label</b>	If you have selected a Label Type as <i>Text</i> , enter the image label.
<b>Image</b>	
<b>Image ID</b>	Select the image name from the drop-down list.
<b>Type</b>	Displays the image type, such as GIF, JPG, and so on.
<b>Width/Height</b>	Displays the dimensions of the graphic in pixels.
<b>Preview</b>	A preview of the image appears in the preview box below the controls in the Image group box.

---

**Note:** Not all image types can be previewed in Application Designer during design time. For example, these image types cannot be previewed: PNG, ICO, and SVG.

---

## Image Format / Size

<b>Scale</b>	Select to scale the image to the size of the frame that you set using the control selection handles or by the width and height that you enter. The scaling occurs when you view the page in a browser.
<b>Size</b>	Select to display the image as is, regardless of the control size on the page.
<b>Width/Height</b>	Use to specify custom dimensions for an image.
<b>Reset to actual image size</b>	If you have scaled or adjusted the image dimensions, click to reset the image to the actual size of the image.

---

**Note:** You can define your own static images, such as your company logo, by creating a new image definition. After you create the image definition, you can then add your logo to a page using a static image control.

---

## Setting Image Properties

To set image properties:

1. Open the Image Properties dialog box.

2. On the Record tab, select the record and field names with which this image field is associated.
3. Set the image format and size attributes.

<b>Scale</b>	Select to scale the image to the size of the frame that you set using the control selection handles or by the width and height that you enter. The scaling occurs when you view the page in a browser.
<b>Size</b>	Select to display the image as is, regardless of the control size on the page.

4. Specify the alignment of your image.
5. Select a style for the image.

### Setting Image Label Properties

Be sure to assign an informational label to your image. Assigning an informational label to your image is especially important if your application works with screen reader software.

To document an image control with an informational label:

1. Enter a text description in the Alt tag for image region.
2. Select one of the following settings from the Type drop-down list box:

<b>None</b>	Select if you do not want a label. The Text field becomes unavailable for entry.
<b>Text</b>	Select to enter a custom label. This value is the default setting.
<b>Message Catalog</b>	Select to use a preset message from the message catalog. The Message Set and Msg Number (message number) fields become available for entry.
<b>RFT Long</b> (record field table long) and <b>RFT Short</b> (record field table short)	Select to use a preset label from the record field set on the Record tab. The Label ID drop-down list box becomes available for entry.

### Setting Image Use Properties

The Use tab of the Image Properties dialog box is the same as for that of an edit box.

See [Setting Use Properties](#).

## Using Static Text

Access the Static Text Properties dialog box.

## Label Text

### Text

If you select Text, you can use either uppercase or lowercase characters. The text label is limited to 60 characters in length. You can also split your text item into multiple lines. To do this, position the cursor in the Text field where you want the split to occur and click the Insert Line Feed button. A thick vertical bar character appears in the Text field, and, when you close the dialog box, your text item is split into multiple lines.

### Message Catalog

If you select Message Catalog, enter the appropriate message set and number. As with a text label, you are limited to message catalog text of 60 characters.

## Style

You can control the color, font, size, and other characteristics of the text by specifying a style.

See [Understanding Style Sheets and Style Classes](#).

## Alignment

Set the horizontal alignment of your text control, as determined by the left-hand edge of the field. You can align controls to the left-of-center, centered, or to the right-of-center.

## Use Tab

If a text item is associated with multi-currency processing, select the Multi-Currency Field option. This selection causes the text item to appear at runtime only if the Multi-Currency option on the PeopleTools Options page is selected.

---

## Using Check Boxes

When you insert a check box on a page, it appears with a default label, *Dummy Name*, until you specify a record definition name and field name, or a text label.

## Setting Check Box Properties

Define the check box control by assigning the appropriate properties.

### Setting Check Box Record Properties

To link check boxes with associated record definitions:

1. Open the Check Box Properties dialog box.
2. On the Record tab, select the record and field names from the drop-down list boxes.
3. Enter the enabled and disabled values for the check box.

For example, if the enabled value of the check box is *Y* for yes and the check box is selected when the user saves the row, then the *Y* value is written to the database. If the disabled value of the check box is *N* for no and the check box is deselected when the user saves, then the *N* value is written to the database.

The enabled and disabled values that you enter validate against the Translate table. If the system does not find a value, it displays a warning message but allows the value to remain. You might find this functionality useful when you create prototype pages before defining record definitions.

## Setting Check Box Label and Use Properties

After you link the check box to a record definition and field, set the label properties. Otherwise, the default check box label is the field long name. Set how the check box will be used on the Use tab.

### Related Links

[Setting Page Field Properties for Controls](#)

[Setting Use Properties](#)

---

## Using Drop-Down List Boxes

This section discusses how to:

- Set drop-down list box record properties.
- Set drop-down list box label and use properties.

## Setting Drop-Down List Box Record Properties

To set drop-down list box record properties:

1. Open the Drop-Down List Box Properties dialog box.
2. On the Record tab, associate the drop-down list box with a record and field.
3. Select a style.

Set the font and color attributes of your drop-down list box data.

See [Understanding Style Sheets and Style Classes](#).

4. Select a displayed text option:
  - *Xlat Short*.
  - *Xlat Long*.
  - *Prompt Table Field*.
5. If you selected *Prompt Table Field*, enter the field name in the Prompt Table Field area.

6. Set the field size for the drop-down list box.

## Setting Drop-Down List Box Label and Use Properties

You can set the label and use properties for a drop-down list box.

### Related Links

[Setting Label Properties](#)

[Setting Use Properties](#)

---

## Using Radio Buttons

This section provides an overview of radio buttons and discusses how to:

- Set radio button record properties.
- Set radio button label properties.
- Set radio button use properties.

## Understanding Radio Buttons

When you insert a radio button on a page, it appears with the default label, *Dummy Name*, until you specify a record definition name, field, and value for the radio button. Like edit box labels, radio button labels display a dashed box to indicate the translation buffer.

For radio buttons to function as a single group, they must be associated with the same record field and they must be adjacent fields on the Order tab of the page definition. To save time, add all radio buttons in a set, one after the other. After you add the first radio button, the system remembers the record definition name and field name for all subsequent radio buttons; you must enter only the database value for each. Then, place a group box around all of your radio buttons to keep them together and labeled, as in this example:

### Image: Example of radio buttons

This example illustrates the fields and controls on the Example of radio buttons. You can find definitions for the fields and controls later on this page.

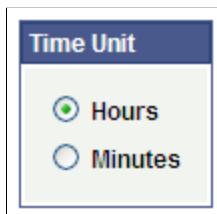

## Setting Radio Button Record Properties

To link a record with radio buttons:

1. Open the Radio Button Properties dialog box.
2. On the Record tab, select the record and field name.

The system retrieves the default label text if you enter the record or field.

3. Enter the database translate value for this radio button.

In the preceding radio button example, *N* is for *Normal*. If you select the drop-down list box for the value, you see the translate value and the long name that was assigned to the field. When the user selects this radio button, it indicates a *Normal* value.

## Setting Radio Button Label Properties

To set the label of a radio button:

1. Open the Radio Button Properties dialog box.
2. On the Label tab, select the type of label if it is other than the default of *XLAT Long*.
3. Select the radio button label location: to the left or right.

See [Setting Label Properties](#).

## Setting Radio Button Use Properties

You might want to change the way that a radio button is used on a page. For example, you might want the selected value of a radio button to control what appears in another control.

See [Setting Use Properties](#).

---

## Using Edit Boxes and Long Edit Boxes

This topic discusses information related to applying various options to edit boxes or long edit boxes.

When you insert edit boxes and long edit boxes on a page, they appear with the default label, *Dummy Name*, until you specify a record and field for them or until you specify a text type field label. The space between the edit box label and the control is more than required: PeopleSoft Application Designer provides 25 percent extra space for the edit box label for translation purposes.

You control source data, labels, and how the control is used in the respective edit box and long edit box properties dialog boxes in PeopleSoft Application Designer. The settings for these two controls are mostly the same.

### Related Links

[Setting Use Properties](#)

[Understanding Pop-up Pages](#)

"DisplayOnly" (PeopleTools 8.58: PeopleCode API Reference)

## Long Edit Box Character Limit Counter

Long edit boxes do not limit the number of characters that a user can enter in the browser, regardless of any limits defined in the underlying record field. As such, characters entered by the user that exceed the field length of the field definition may be truncated. For example, if you enter 012345678901234 into a long edit box associated with a field with a field length of 10, the input would be truncated and saved to the database as 0123456789.

To help users avoid this situation, you can select Enable Long Edit Counter on the Long Edit Box Properties, Use tab.



### Image: Enabling Long Edit Box Character Counter

The following example shows the Enable Long Edit Counter option on the Long Edit Box Properties dialog box.

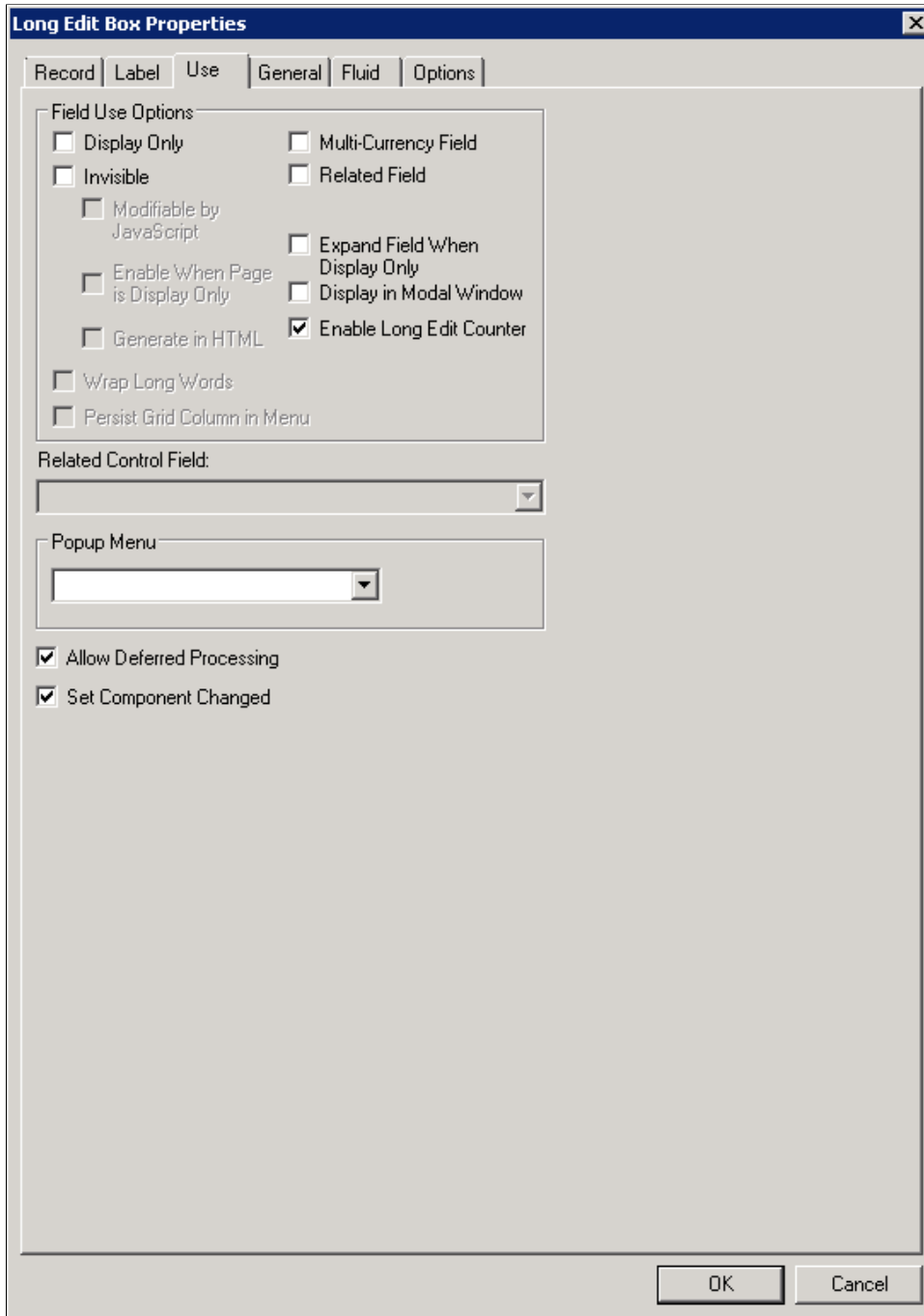

With this option on, a counter appears below the long edit box on the page, notifying the user how many characters can be entered before reaching the field limit (*N characters remaining*).

### Image: Long edit box character counter with space remaining

The following example shows the character limit counter alerting the user of the amount of characters that can still be accepted by the field.

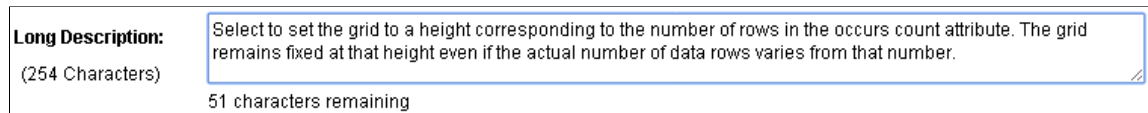

### Image: Long edit box character counter with limit exceeded

The following example shows the character limit counter alerting the user that the character limit has been exceeded, with the character value becoming negative (-).

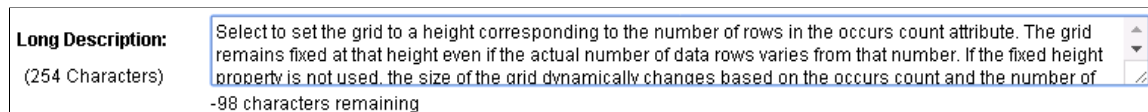

---

**Note:** The system treats carriage returns (ASCII=13) and line feeds (ASCII=10) the same as any other character. If there is no character limit on the field, the counter does not appear. For long edit boxes within grids, the counter becomes visible only after performing a long edit zoom. The character limit counter is not applicable for use with fields enabled for the rich text editor. If a field is enabled for rich text editor, the system does not display the character limit counter.

---

## Character Counter on Fluid Pages

Similar to classic pages, when the character counter is enabled on a fluid page, it is displayed beneath the bottom right corner of the long edit box. If you want the character counter to be displayed beneath the bottom left corner, apply the *psc\_counter-left* style in the Application-Specific Styles: Style Classes field on the Fluid tab. Oracle recommends that you do not use a *psc\_control-width\*pct* style to control the width of the long edit box itself because you will then need to develop and apply custom styling to get the character counter aligned with the long edit box.

## Mouse Over Pop-up Edit Boxes

You can associate mouse over pop-up pages with edit boxes. The pop-up page appears when you hover your mouse over any edit box that is pop-up enabled. You can identify edit boxes with mouse over pop-up pages associated with them because these edit boxes are both display-only and they appear with a dashed line beneath the control.

You can configure edit boxes to display pop-up pages at runtime by configuring properties on the Use tab at design time.

## Display-Only Edit Boxes

Some edit boxes should be display-only. You might want a page field to govern what appears in another control. In some cases, you might want the page control to be invisible because it is required by PeopleCode but is not accessible by a user.

If you designate the long edit box as display-only, select the Expand Field When Display Only check box to hide the scroll and automatically expand the size of the edit box as necessary to display large amounts of text in the field.

You can configure controls to be display-only at runtime by configuring properties on the Use tab at design time.

## Rich Text-Capable Long Edit Boxes

Some long edit boxes should display the values in rich text format (RTF), which is a format type that enables cross-platform document interchange. At runtime, any long edit box that is rich text enabled appears with rows of text formatting toolbars, which enable you to specify formatting information in the text such as font; font size; font characteristics, such as bold and italic; margins; and so on.

You enable long edit boxes to display rich text at runtime by configuring properties on the Options tab at design time.

---

**Note:** While display-only rich text editor fields are supported in fluid applications, editable rich text editor fields are not. If you enable the rich text editor for long edit boxes on fluid pages, then you must also select two check boxes on the Use tab of the Long Edit Box Properties dialog box: Display Only and Expand Field When Display Only.

---

## Display in Modal Window

Select this option to enable the end user to display a long edit box in a modal window.

When an end user clicks Display <Field Name> in Modal Window for a long edit box at runtime, the pop-up modal window displays a title matching the current component description. If the component description is empty, then the system displays a title matching the current menu item name. Make sure that one of these values is suitable for end user display.

## Protecting Sensitive Field Data Online

You may not want to expose some field data online, such as passwords, PIN numbers, identification numbers, and so on. For such fields, you can use the Password and Input Only display options to prevent end users from seeing the actual field value.

### Image: Display Options

This example illustrates the Password and Input Only edit box display options.

The image shows a dialog box titled "Display Options" with a list of checkboxes. The following options are checked:

- Password
- Show Prompt Button
- Input Only

The following options are unchecked:

- Display Zero
- Display Century
- Currency Symbol
- 1000 Separator
- Auto Fill
- Auto Decimal
- Display Time Zone
- Enable Spell Check

If neither Password or Input Only is selected, the system displays the field data online just as it appears in the database (as normal — in its clear case or encrypted form).

Select Password to mask the field value online with black dots or asterisks (depending on the operating system and/or browser), while having the actual field value available in the page HTML.

Input Only can be selected only if Password is also selected. The Input Only option displays masked characters in the field, but it also prevents the field value from appearing in the page HTML.

In both cases, the user can change the value of the field without ever seeing the value entered or the actual value stored in the database.

---

**Note:** With both options, the actual field value is stored in the panel buffer and can be accessed and utilized as part of normal processing, such as PeopleCode usage.

---

#### Image: Password Display Option Selected (Online)

This example illustrates the online formatting of the field value (black dots) with the Password option selected. The number of masked characters matches the number of characters in the actual field length.

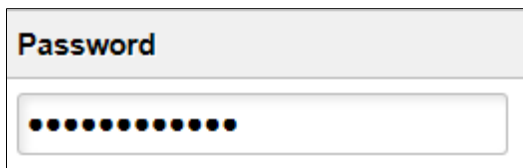

#### Image: Password Display Option Selected (HTML)

This example illustrates the Input Only option not selected. In this example only Password is selected so just the online page field is affected. Note the field value attribute populated in the HTML.

```
<input name="MCF_USER_IM_CFG_MCF_PASSWORD$0" tabindex="166"
class="PSEDITBOX" id="MCF_USER_IM_CFG_MCF_PASSWORD$0" style="width:
237px;" type="text" maxlength="254" value="5/SS3MFAFH4="></input>
```

With the Input Only option selected, the online appearance of the field matches the Password option selection. The HTML appears as follows:

```
<input name="MCF_USERIM_CFG_MCF_PASSWORD$0" tabindex="166"
class="PSEDITBOX" id="MCF_USERIM_CFG_MCF_PASSWORD$0" style="width:237px;"
type="text" maxlength="254" value="*****"></input>
```

Note the field value is masked also in the HTML.

<b>Display Option</b>	<b>Online</b>	<b>HTML</b>
Password: Not Selected	Displays field data as stored in the database. If the data is encrypted or hashed in the database, it displays that format.	The HTML input value attribute contains the same value as the online field.
Password: Selected	Displays field data as masked characters.	The HTML input value attribute contains field data as stored in the database. If the data is encrypted or hashed in the database, it displays that format.
Password: Selected Input Only: Selected	Displays field data as masked characters.	The HTML input value attribute contains a masked value.

---

## Using Pop-up Pages

---

**Note:** Pop-up pages are not supported in fluid applications.

---

This section provides an overview of pop-up pages and discusses how to:

- Define pop-up pages.
- Associate pop-up pages with fields.
- Enable Message Catalog pop-up pages.

### Understanding Pop-up Pages

Pop-up pages are a type of PeopleSoft page that displays information that supplements, expands, or enhances the transaction page data. Pop-up pages are ideal for displaying additional, more detailed information that is pertinent to a subset of users. For example, you can create a Purchase Order Header Details pop-up page that displays customer details such as contact information and payment data. You can then associate the details pop-up page with the Purchase Order Line Items page so that an account representative who is reviewing line items can quickly access customer contact data without having to leave the transaction. Similarly, you can create an Employee Details pop-up page to display an employee's ID, name, department, current job assignment, phone number, and email address. You then associate the Employee Details pop-up page to a specific field on an employee-related transaction page. At runtime, when you move your mouse over this field, the pop-up page appears and displays information that is contextually relevant to the employee data on the transaction page.

Pop-up pages look and behave differently from standard PeopleSoft transaction pages. For example:

- Pop-up pages are not standalone pages; they are linked to, dependent upon, and accessed from their primary transaction pages.
- Pop-up pages do not appear unless you hover your mouse over the page control with which you associated the pop-up page.
- Pop-up pages support only a subset of page controls.
- Pop-up pages cannot contain scroll areas or grids.
- Pop-up page fields are display-only.
- You should place pop-up page PeopleCode either in the page Activate event or on the RowInit event of work records associated with the pop-up page.
- If a value at level 0 on the pop-up page comes from one of the search key fields and if no non-search key value from that record appears at level 0 on the main page, then RowInit PeopleCode in that record does not run.

In addition, if a non-search key value from that record appears on the pop-up page only, then the system does not consider the field to be part of the main page. Because of this, no values for the non-search key fields are retrieved from the database. To populate non-search key fields on the pop-up page with data, you must place a non-search key value from that record on the main page. The field can be hidden on the main page, but it has to exist there.

## Designing Context-Sensitive Pop-up Pages

To create pop-up pages that retrieve data that maintains the key field context of the main page, you must ensure that these conditions are met:

- For each record definition that the pop-up page references, key field values must exist on the main page.

---

**Note:** If the key field value is not found, use the Set Trace Flags option Related Displays, and search for more information in the log file.

---

- The names of the main page fields in which these key values exist must be identical to the names of the key fields of the record definitions referenced on the pop-up page.

---

**Note:** While the field names must be identical, they do not have to be key fields in the record definition referenced by the main page.

---

- The fields in which the key values appear must appear in either the same scroll area as the field to which you associate the pop-up page or at a preceding level. The page field to which you link the pop-up page can be one of the fields that contains the key field values; frequently, it is the lowest order key.

Consider this scenario:

If *PRec* is the record that the pop-up page references and the key fields are *PRec.K1* and *PRec.K2*, then, the *K1* and *K2* fields must exist on the main page as *MRec.K1* and *MRec.K2*, where *MRec* is the record that the main page references.

If the field on the main page to which the pop-up page is attached is in *ScrollA*—a level one scroll area—then both *MRec.K1* and *MRec.K2* must either exist in *ScrollA* or at level zero.

---

**Note:** On the main page, it is not necessary that the *K1* and *K2* fields appear in the same record, *MRec* in the previous case. The fields could be *MRec.K1* and *NRec.K2*, where *NRec.K2* is some other field on the main page in the correct context.

---

## Context-Sensitive Pop-up Page Example

In this example, you see a User Details pop-up page. This page is associated with a view, which retrieves information so that the page displays the employee's name, photo, department, phone number, address, and web site URL.

### Image: User Details pop-up page

This example illustrates the fields and controls on the User Details pop-up page. You can find definitions for the fields and controls later on this page.



The fields on the pop-up page reference PS\_EMPL\_VW. The key field of PS\_EMPL\_VW is EMPLID, which *requires* that the EMPLID field exist on the main page.

The field to which the pop-up page is linked is at level 0, which *requires* that EMPLID be at level 0 also.

---

**Note:** EMPLID is a key field on the PS\_EMPL\_VW record that the pop-up page references. While EMPLID also happens to be a key field on the PS\_EMPL\_JOB record that the transaction page references, it is not a requirement.

---

### Identifying Valid Controls on Pop-up Pages

You may insert these controls only on a pop-up page:

- Frames
- Group boxes
- Horizontal rules
- Static text
- Static images
- Check boxes
- Drop-down list boxes
- Edit boxes
- Images

- Long edit boxes
- Push Button/Hyperlinks
- Radio buttons
- Charts

---

**Note:** Except for Push Button/Hyperlink page controls, these controls are automatically set as display-only at runtime even if you do not set the Display-Only property on the control.

---

## Using Push Buttons and Links on Pop-up Pages

You may use only these destination type values on a pop-up page:

- External link
- Instant messaging action
- Internal link
- PeopleCode command
- Process
- Secondary page

---

**Note:** Do not use other destination types for push button/hyperlink controls on pop-up pages because unexpected results will occur.

---

## Defining Pop-up Pages

Before you define your pop-up pages, you should determine which data is appropriate for pop-up information. Typically, this is data that supplements and enhances the data on the primary page or information that you might access from more than one main page.

---

**Note:** When designing pop-up pages, carefully consider how to make them more versatile and reusable.

---

To define pop-up pages:

1. Select File > New and select Page from the New Definition dialog box.
2. Insert the record fields on the pop-up page.
3. Right-click the page and select Page Properties to open the Page Properties dialog box.
4. Select the Use tab.
5. Select *Popup Page* from the drop-down list box in the Page Type group box.
6. Select the page size:

**Auto-Size**

Select to size the page automatically to fit the fields that are defined on it.



**Custom Size**

Select to size the pop-up page by dragging the edge or by entering the width and height in pixels.

7. (Optional) Select Adjust Layout for Hidden Fields.
8. Click OK and save your pop-up page.

If you selected Auto-Size, the system sizes the page automatically to fit the fields that are defined on it when you save.

## Associating Pop-up Pages with Fields

To associate pop-up pages with fields:

1. Select File > Open and select the main page.
2. Select Insert, Edit Box or Insert Push Button/Hyperlink..

---

**Note:** You can associate pop-up pages with display-only edit box and push button/hyperlink controls at level 0 or inside of scroll areas only. If you associate pop-up pages with controls that are in grids, you will receive an error.

---

3. Double-click the control.
4. Select the Use tab.
5. Select the Display Only check box.
6. In the Mouse Over Popup group box, select the Page Popup option.
7. Select the name of the pop-up page from the drop-down list box.

---

**Note:** Only pop-up pages appear in the drop-down list.

---

8. Click the OK button.

A dashed line should appear beneath the field to indicate its association with a pop-up page.

9. Save the page.

---

**Note:** If page controls are placed too close together on a page, the dashed line, which indicates an associated mouse over pop-up page, might not appear beneath the control.

---

## Enabling Message Catalog Pop-up Pages

You can enable Message Catalog pop-up pages to embed context sensitive help on any PeopleSoft page. This section discusses how to:

- Enable message catalog pop-up pages.
- Embed context-sensitive help in pop-up pages.

## Enabling Message Catalog Pop-up Pages

To enable message catalog pop-up pages:

1. Double-click the field that accesses the pop-up page.
2. Select the Use tab.
3. Select the Display-Only check box.

---

**Note:** You must select Display-Only.

---

4. Select the Message Catalog Popup option.
5. Enter the Message Set and Message Number of the message whose Message Text and Explain strings appear in the Message Catalog pop-up page.
6. Click the OK button.

---

**Note:** You can also set the Message Catalog entry for mouse over pop-up pages by using PeopleCode.

---

See "MouseOverMsgNum" (PeopleTools 8.58: PeopleCode API Reference), "MouseOverMsgSet" (PeopleTools 8.58: PeopleCode API Reference).

## Embedding Context-Sensitive Help in Pop-up Pages

You can add variables to a message to make a Message Catalog pop-up page context-sensitive to the PeopleSoft product documentation online help.

---

**Note:** You must correctly configure and implement PeopleSoft online help.

---

To add variables to messages to embed context-sensitive help:

1. Access the Message Catalog (PeopleTools, Utilities, Administration, Message Catalog to access the Message Catalog).
2. Select an existing message or create a new message.
3. Enter an explanation and place the variable in the Explanation field.

The table in the next section describes the variables and their usage.

---

**Note:** The text in the Message Text field appears as the pop-up page header. The text in the Explanation field appears in the pop-up page body.

---

4. Enable the pop-up page on the desired edit box control.

See [Defining Pop-up Pages](#).

## Embedded Help Variables

This table describes the variables that you can add to the embedded help content in the Message Catalog. Use these variables to generate links on the embedded help pop-up page that enable the user to access additional online help.

**Note:** Your PeopleSoft online help option must be configured for any Help link to function properly.

<b>Variable</b>	<b>URL</b>	<b>Label</b>
%PBCTXT ( )	This variable uses the current page name as the %CONTEXT_ID% to build the Help URL so that the embedded link takes the user to the Help content associated with the current page.	Because no message is referenced, the label of the help link appears as <i>PeopleBooks Help</i> .
%PBCTXT (sn, mn)  The argument sn is the Message Set Number. The argument mn is the Message Number.	This variable uses the current page name as the %CONTEXT_ID% to build the PeopleBooks Help URL so that the embedded link takes the user to the PeopleBooks content associated with the current page.	Because a message is referenced, the label of the help link appears as the value that is stored in the Message Text field for the referenced message.  If you reference an invalid message, the label appears as <i>PeopleBooks Help</i> .
%PBCTXT (CTXT_PG_NM)  The argument CTXT_PG_NM is a page definition name.	This variable uses the CTXT_PG_NM argument as the %CONTEXT_ID% to build the PeopleBooks Help URL so that the embedded link takes the user to the PeopleBooks content associated with the page referenced by the argument.	Because no message is referenced, the label of the help link appears as <i>PeopleBooks Help</i> .
%PBCTXT (CTXT_PG_NM, sn, mn) ⇒  The argument CTXT_PG_NM is a page definition name.  The argument sn is the Message Set Number. The argument mn is the Message Number.	This variable uses the CTXT_PG_NM argument as the %CONTEXT_ID% to build the PeopleBooks Help URL so that the embedded link takes the user to the PeopleBooks content associated with the page referenced by the argument.	Because a message is referenced, the label of the help link appears as the value that is stored in the Message Text field for the referenced message.  If you reference an invalid message, the label appears as <i>PeopleBooks Help</i> .
%PBURLTBL (URL_IDENTIFIER, s⇒n, mn)  The URL_IDENTIFIER is any URL_ID that is stored in the URL Maintenance component.  See "URL Maintenance" (PeopleTools 8.58: System and Server Administration).  The argument sn is the Message Set Number. The argument mn is the Message Number.	This variable uses the URL_IDENTIFIER argument to build the help URL so that the embedded link takes the user to the site associated with the URL_ID.	Because a message is referenced, the label of the help link appears as the value that is stored in the Message Text field for the referenced message.  If you reference an invalid message, the system uses the URL_IDENTIFIER argument as the label.
%PBLNK (http://www.site.com⇒, sn, mn)	This variable uses the hard-coded URL so that the embedded link takes the user to the specified site.	Because a message is referenced, the label of the help link appears as the value that is stored in the Message Text field for the referenced message.

<b>Variable</b>	<b>URL</b>	<b>Label</b>
The argument <code>sn</code> is the Set Number. The argument <code>mn</code> is the Message Number.		If you reference an invalid message, the system uses the URL as the label.

## Example

In this example, the `%PBCTXT` variable uses `QRY_ADMIN` as a `CONTEXT_ID` that references the Query Administration page in PeopleBooks:

### Image: Message Catalog page with context-sensitive variable embedded in text

This example illustrates the fields and controls on the Message Catalog page with context-sensitive variable embedded in text. You can find definitions for the fields and controls later on this page.

The screenshot shows the Message Catalog interface. At the top, the title "Message Catalog" is displayed. Below it, there are input fields for "Message Set Number" (value: 4), "Description" (value: Help Processor), and "Short Description" (value: HPR). A "Messages" section is visible, containing a table with columns for "Find", "View All", "First", "6 of 7", and "Last". The table shows a single message entry with the following details:

- Last Update Timestamp: 07/23/2010 1:45PM
- \*Message Number: 6
- \*Severity: Message
- \*Message Text: Compress Queries on Web Server
- Description: Select this check box to compress queries before sending them to the web server. For more information on this topic, click this link: `%PBCTXT(QRY_ADMIN,4,7)`

In the Description field, the `4, 7` parameters refer to Message Catalog entry (4,7), which contains the label to use for the generated link.

**Image: Message Catalog page showing Query Administration label in the Message Text field**

This example illustrates the fields and controls on the Message Catalog page showing Query Administration label in the Message Text field. You can find definitions for the fields and controls later on this page.

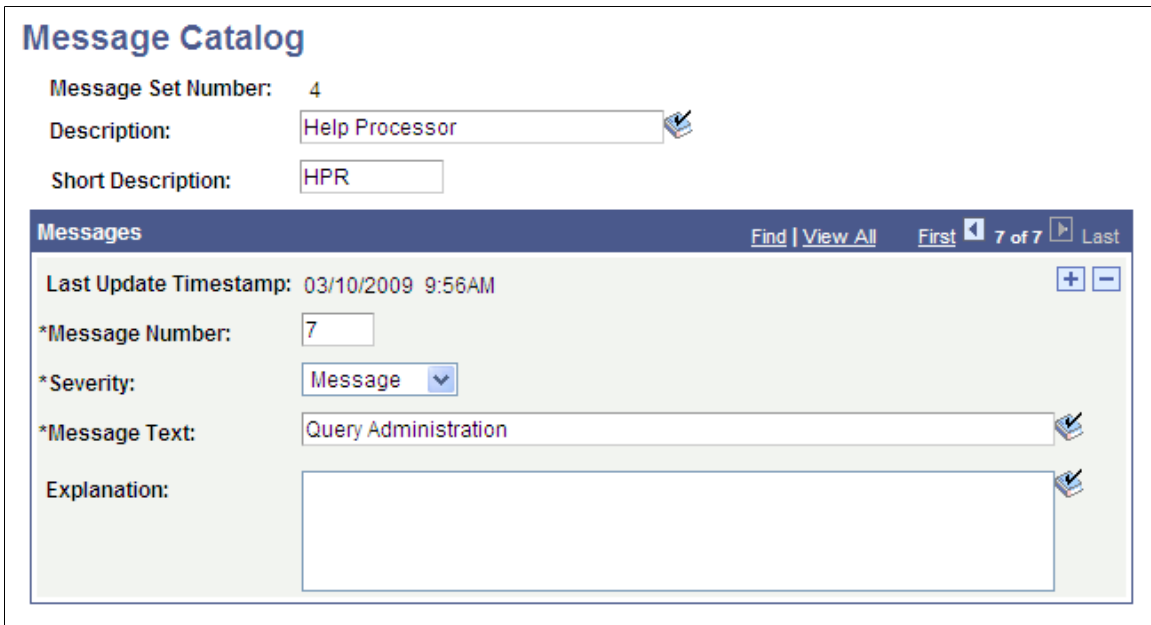

On the Web Profile Configuration page at runtime, mouse over the selected control to see the generated pop-up page:

**Image: Web Profile - General page showing the message catalog pop-up page**

This example illustrates the fields and controls on the Web Profile - General page showing the message catalog pop-up page. You can find definitions for the fields and controls later on this page.

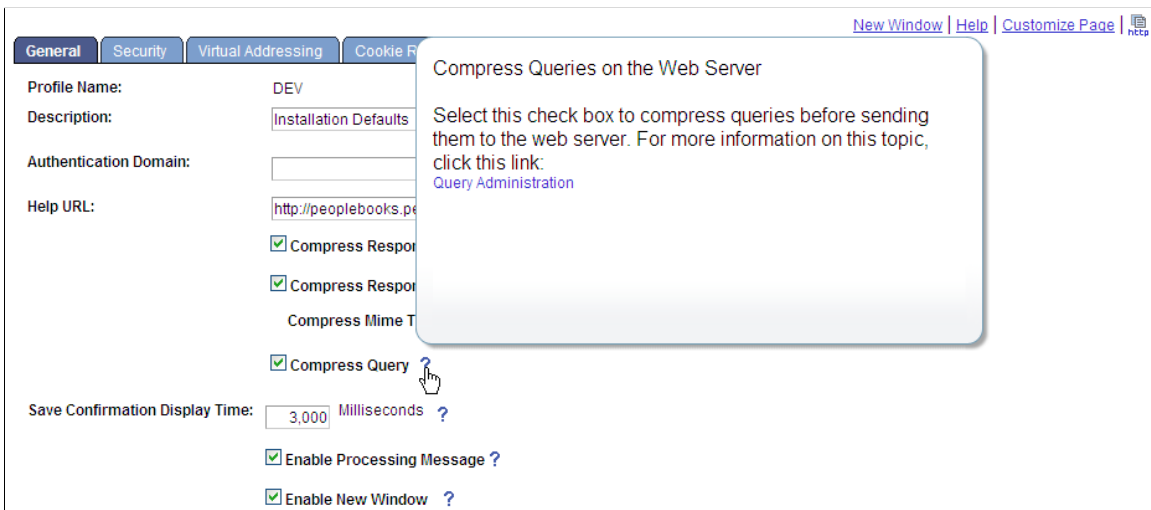

Notice that the pop-up text comes from Message Catalog entry (4,6) and the link label, *Query Administration*, defined by the %PBCTXT(QRY\_ADMIN, 4, 7) function comes from Message Catalog entry 4,7. Click the Query Administration link, and the system accesses the PeopleBooks entry for the QRY\_ADMIN CONTEXT\_ID using that Help URL entry to ascertain the PeopleBooks location on the web server.

---

**Note:** You define the location of your online PeopleBooks by entering a URL in the Help URL field that is located on the Web Profile - General page (PeopleTools, Web Profile, Web Profile Configuration).

---

See "Configuring General Portal Properties" (PeopleTools 8.58: Portal Technology).

## Related Links

[Configuring Embedded Help for Scroll Areas, Grids, and Group Boxes](#)

## Understanding Pop-up Pages in Screen Reader Mode

For a user in screen reader mode, for every mouse over control, the system displays an additional image that looks like an exclamation point ("!"). The accessibility user can click the image to display the mouse over popup page. The user can press the escape button (Esc) to close the mouse over popup page.

### Image: Screen Reader Mode Pop-up Icon

This example illustrates the icon that appears next to fields with associated pop-up pages.



---

## Using Subpages

This section provides an overview of subpages and discusses how to:

- Define subpages.
- Insert subpages into pages.
- Specify informational subpage labels.

## Understanding Subpages

Subpages are a powerful means of factoring out commonly used page functionality in your application. Rather than duplicating the same set of page fields on two or more pages, you can create a single subpage that contains those page fields and then add it to any page. Subpages provide an easy way to maintain the functionality that the page fields represent.

Subpages are even more effective when used with corresponding subrecords. To support the use of subrecords with subpages, the system uses a record name substitution mechanism for subpage-type page fields. Each subpage has a from record that is determined dynamically by the page definition in PeopleSoft Application Designer and by PeopleSoft Pure Internet Architecture. The from record is a record associated with one of the page fields on the subpage. Which page field depends on the page field ordering, the types of page fields on the subpage, and whether the associated record is a subrecord. The subpage itself must be fully expanded to make this determination. (Keep this fact in mind when working with subpages that contain other subpages.)

You specify the to record in the Subpage Record Name Substitution field in the Insert Subpage dialog box that appears after you insert the subpage into a page. (It also appears on the Subpage tab of the Subpage Properties dialog). At runtime, when a subpage-type page field is expanded, each page field that is

associated with the dynamically determined from record is instead associated with the to record that you specify. For example, you can populate a subpage with page fields that are associated with a subrecord so that the subrecord is determined to be the from record; then, when that subpage is used as a subpage-type page field, you can specify the to record as one of the records that contains that subrecord. You are able to associate a single set of page fields (through the subpage) with a variety of different records (each containing the subrecord).

## Defining Subpages

Creating a subpage is like creating a page definition except that you define it as a subpage rather than a standard page in the Page Properties dialog box.

To define a subpage:

1. Select File > New > Page.
2. Insert the record fields on the page.

See [Adding Page Controls](#).

3. Select File, Definition Properties to access the Page Properties dialog box.

Use this dialog box to define the type, size, and layout of the page.

4. Select *Subpage* in the Page Type drop-down list box.
5. Select the size of the page.

See [Changing Page Use Information](#).

6. Select Adjust Layout for Hidden Fields if necessary.
7. Select Allow Deferred Processing if appropriate.

See [Understanding Processing Modes](#).

## Inserting Subpages Into Pages

After you create a subpage definition, insert a subpage control on your primary page and associate it with the subpage definition.

To insert a subpage into a page:

1. Open the page into which you want to insert the subpage.
2. Select Insert > Subpage.

The Insert Subpage dialog box appears.

3. Select a subpage definition.

Specify the name of the subpage that you want to insert into the open page definition.

4. Select a record definition in the Subpage Record Name Substitution field.

The subpage writes its fields to a generic record. Specify the application-specific record name to which you want the information in the subpage written.

---

**Note:** All of the fields in a subpage must be associated with fields of a subrecord in the specified record definition.

---

5. Click the OK button.

The subpage appears on the page. Its size reflects the size of the page control group, and it is identified by the subpage definition name. During design time, the fields within the subpage are not visible. At runtime, pages containing subpages are dynamically expanded. Be sure to leave a few pixels of space between the left edge of the main page and the subpage page field to ensure sufficient padding at runtime.

When saving a page with multiple subpages, be aware that you may receive a warning message if duplicate fields are present.

### Inserting a Subpage Into a Grid

You insert a subpage into a grid as you would any other column.

See [Inserting and Manipulating Grid Columns](#).

## Specifying Informational Subpage Labels

Document the purpose of the subpage by changing its informational label. The default subpage label is *Subpage*. Any label that you attach to a subpage is for information only: it does not appear on the page, but it does appear on the page definition printout and in the control order list. Use labels to differentiate among multiple subpages on a page.

To specify informational subpage labels:

1. Open the Subpage Properties dialog box.

Note that the Subpage tab displays the information that you entered on the Insert Subpage dialog box.

2. On the Label tab, enter your informational text label.
3. Enter the page field name in the General tab.
4. (Optional) Select Enable as Page Anchor if you want the subpage to serve as a jump destination on the page.
5. Click OK.

---

## Using Secondary Pages

This section provides an overview of secondary pages and discusses how to:

- Define secondary pages.
- Insert secondary page controls.



- Associate secondary pages with primary pages.

## Understanding Secondary Pages

Secondary pages are pages that you access through another page, usually by clicking a link or push button. Secondary pages are ideal for entering and updating data that is supplemental to the data on the primary page or data that is common to and can be accessed from multiple primary pages. While a secondary page might sometimes appear as just another page to the user at runtime, secondary pages have certain characteristics that are not shared with standard pages. For example:

- Secondary pages are not standalone pages that you access through the menu structure. You can only access a secondary page from its primary page; the primary page and the secondary page are associated by push button or link page controls.
- Secondary pages include OK and Cancel or Return buttons (or equivalent alternatives) so that the user can accept or discard input, dismiss the secondary page, and return to the primary page.
- Secondary pages display no component buttons, such as Save, Return to Search, and so on.

## Understanding Modal Secondary Pages

Modal secondary pages do not appear in a browser window. Modal secondary pages appear in front of a browser window, capturing focus and disabling the primary page until you dismiss the secondary page.

You can move modal secondary pages by dragging the page title bar. Moving the page is useful when you want to view information on the primary page while working with the secondary page. The appearance of the cursor changes to indicate that you can move the page.

Use these guidelines to determine whether to specify secondary pages as modal. Specify a secondary page as modal when:

- The content of the secondary page is relevant to the context of the primary page.

For example, you need to be able to see both the secondary page and primary page simultaneously.

- The content of the secondary page is such that the user can complete the transaction quickly and easily.

By default, secondary pages appear as modal pages. You can change the default behavior at the definition level by deselecting the Disable Display in Modal Window When Not Launched by DoModal Peoplecode check box that appears on the Use tab on the Page Properties dialog box of the secondary page. You also control secondary page modality by using any of the **DoModal\*** PeopleCode functions.

---

**Important!** Do not select the Disable Display in Modal Window When Not Launched by DoModal Peoplecode check box for fluid secondary pages. Fluid secondary pages must always be displayed in a modal window.

---

### Example: Modal Secondary Page

In this example, the user clicks the Change password link to access the Change password secondary page in a modal window. The Change password page is displayed over the General Profile Information page, which is the primary page.

## Image: Change password modal secondary page

This example illustrates the Change password modal secondary page.

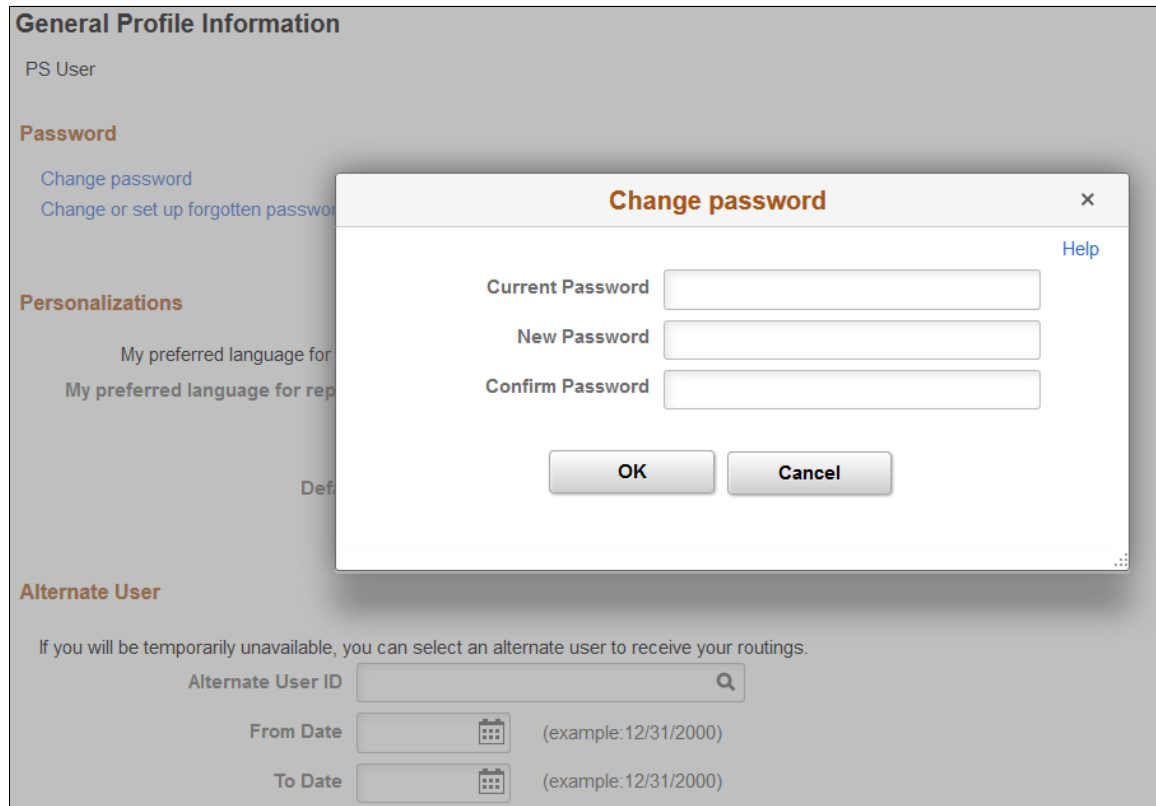

## Modeless Windows

In addition to modal secondary windows, you can create modeless secondary windows. A modeless window is different from a modal window launched by any of the DoModal\* functions in that its state is separate from that of the parent, launching component. When a modeless window is launched from a classic component using the TransferModeless function, the modeless window does not mask the parent window, which allows the user to update the modeless and parent window from the same browser session at the same time.

However, when a modeless window is launched from a fluid component using either the ViewContentURLModeless or ViewURLModeless functions, the parent window is masked and cannot be accessed until the modeless window is dismissed. In this respect and from the user's perspective, a modeless window launched from a fluid component operates similar to a modal window; but programmatically, its state is separate from that of the parent, launching component.

Similar to modal, secondary windows opened by any of the DoModal\* functions, the modeless window does not include the browser title bar, browser menus, and the browser tool bars, status bar, and tool icons associated with most browser windows.

---

**Note:** While the title bar of a modeless window includes an X (or cancel) button, it cannot include any custom buttons.

---

---

**Important!** Only one active child modeless window can be open at one time. Therefore, after opening a modeless child window from the parent, you cannot open a second modeless child window from that modeless window. However, you can open a modal window from that modeless window.

---

## Defining Secondary Pages

Access the Page Properties dialog box for the page definition. (With the page open > select File > Definition Properties.)

### Image: Page Properties dialog box: Secondary page type

This example illustrates the fields and controls on the Page Properties dialog box: Secondary page type. You can find definitions for the fields and controls later on this page.

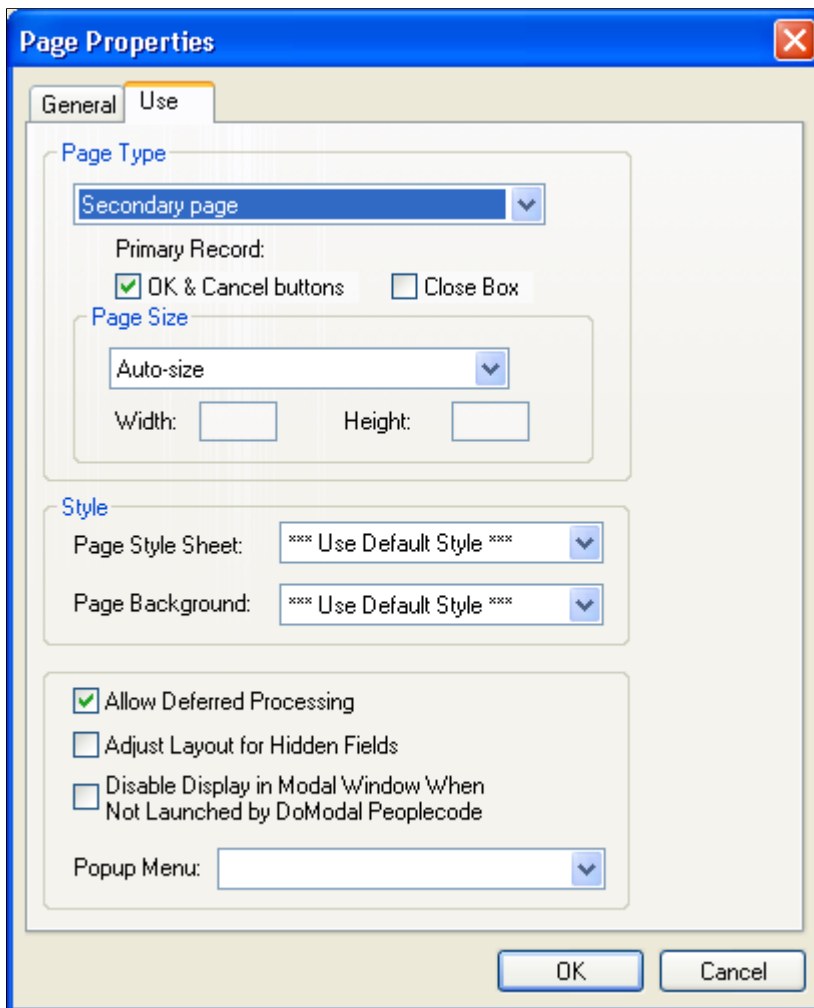

To define secondary pages:

1. Select File > New and select Page from the New Definition dialog box.
2. Right-click the page and select Page Properties to open the Page Properties dialog box.
3. Select the Use tab.
4. Select *Secondary Page* from the Page Type drop-down list box.

5. Deselect the OK & Cancel buttons and the Close Box check boxes if you plan to develop alternative buttons that dismiss the page. To use the standard buttons, accept the default values.

See [Using Push Buttons and Links](#).

6. Select the page size:

**Auto-Size**

Select to have PeopleSoft Application Designer size the page to accommodate the page controls that are defined therein. The right and bottom edges of the page move left and up, respectively, to eliminate any vacant space at the right side and bottom of the page. The top and left edges of the page are stationary, leaving any vacant space at the right side and bottom of the page.

**Custom Size**

Select to manually size the secondary page by dragging the edges or by entering the width and height in pixels.

7. Select the page style sheet to associate with the secondary page.

To override the application default style sheet, select a different style sheet from the drop-down list box. The style sheet that you select is available only for the controls on the secondary page.

8. Select the page background.

You can control the background of the page and any controls that do not have a style sheet associated with them by specifying a style in the page background.

9. (Optional) Deselect Allow Deferred Processing if you want processing to occur each time the user presses the Tab key to advance through the page controls.

10. (Optional) Select Adjust Layout for Hidden Fields if you want the page borders to adjust automatically to accommodate fields that are hidden.

---

**Note:** For the page to adjust automatically, the hidden fields must be surrounded by open space or have other hidden fields to the right or left.

---

11. (Optional) Select Disable Display in Modal Window When Not Launched by DoModal Peoplecode if you want the page to appear within the browser frame comparable to the standard application pages. If you select this option, you must use one of the **DoModal\*** PeopleCode functions if you want the secondary page to appear as a modal page. Leave this check box deselected if you want the secondary page definition itself (not PeopleCode) to control the appearance.

---

**Important!** Do not select the Disable Display in Modal Window When Not Launched by DoModal Peoplecode check box for fluid secondary pages. Fluid secondary pages must always be displayed in a modal window.

---



---

**Note:** This option is disabled when the page type is set to *Popup page*.

---

12. Click the OK button.

The page definition size automatically adjusts if you set the page size to *Auto-Size*.

13. Add other page controls as is appropriate for the relationship of the data on the secondary page to the primary page.

To ensure that no data values are lost in the secondary page if it is opened *from a grid on the primary page* using either the DoModalPopup or DoModal PeopleCode functions, you have two options:

- Make sure the first field referenced in the secondary page is from the context record of the row passed to the DoModal\* PeopleCode function.
- Add the secondary page control to your grid on the primary page.

However, if the secondary page is opened by specifying *Secondary Page* in the Destination field on the Type tab, data loss is not an issue because this methodology also requires that the secondary page control be added to the grid on the primary page.

### Related Links

"Creating Other Fluid Page Types" (PeopleTools 8.58: Fluid User Interface Developer's Guide)

## Inserting Secondary Page Controls

After you define a secondary page, you can place a secondary page control on your primary page and associate it with the secondary page you just created.

To insert a secondary page control, access the primary page:

1. Select Insert > Secondary Page.
2. Click the primary page where you want to display the secondary page control.

The secondary page control looks like a small push button with the secondary page icon on it. This control is invisible at runtime.

3. Double-click the control to access the Secondary Page Properties dialog box: Secondary Page tab.
4. Select the name of the secondary page to associate with the secondary page control on the active page.

Only secondary pages can be associated with secondary page controls. You cannot associate a standard page or subpage with the secondary page control.

5. Select the Label tab.

This label is for informational purposes only. It appears in the Order tab of the page definition and in the page description printout.

6. Position the secondary page control at the proper scroll level on the Order tab.

See [Specifying Type Properties for Push Buttons or Links](#).

7. Save the page definition.

---

**Note:** When you use secondary page controls on primary pages, you must also insert a push button control and write PeopleCode that invokes the secondary page.

---

## Related Links

[Associating Secondary Pages With Primary Pages](#)

## Associating Secondary Pages With Primary Pages

You can use two page controls to associate a secondary page with a primary page:

- Insert a push button or link page control on the primary page.

When you use this control type, you must set the Type properties to invoke the secondary page. At runtime, when the user clicks the push button or link, the secondary page appears. Use this control when:

- You need no procedural PeopleCode logic before the secondary page appears (PeopleCode can be used on the secondary page just like any other page).
- You want to control the formatting of the information (therefore, you want to use a page and not use the Prompt function).
- You use the secondary page multiple times.

See [Using Push Buttons and Links](#).

- Insert a secondary page control on the primary page.

This control looks like a command push button, but it is invisible at runtime. When you use a secondary page control, you must also insert and configure a push button on the primary page. After you set the push button Type properties to invoke Command PeopleCode, you then call any of the **DoModal\*** PeopleCode functions from the FieldChange event for the push button to display the secondary page.

See [Inserting Secondary Page Controls](#).

See [Using Push Buttons and Links](#).

See "Modal Windows and Secondary Pages" (PeopleTools 8.58: PeopleCode Language Reference).

---

## Using HTML Areas

This section provides an overview of HTML area controls and discusses how to:

- Insert HTML areas.
- Populate HTML areas.
- Change HTML area labels.
- Include HTML areas in the page tab order.

## Understanding HTML Area Controls

You can insert an HTML area control on any PeopleSoft page. You can insert it at any level on a page, and you can place it in a grid control. This control is rectangular and is easy to resize.

Populate the HTML area control in one of these ways:

- Statically, in the page field property sheet.
- Dynamically, by associating the control with a record field or HTML definition.

If the control is linked to a record field, the value of the record field appears in the HTML area. Use PeopleCode to associate the HTML area control with a predefined HTML definition.

When using HTML areas, consider:

- HTML areas are downloaded to Microsoft Excel as a non-breaking space (&nbsp;).
- HTML areas are not searched with the Find feature.

### Generating Trees in HTML Areas

You can use the GenerateTree PeopleCode function with HTML areas. This example shows the tree that is created by the GenerateTree PeopleCode function on the Select New Parent Folder page:

#### Image: Example of a tree in an HTML area

This example illustrates the fields and controls on the Example of a tree in an HTML area. You can find definitions for the fields and controls later on this page.

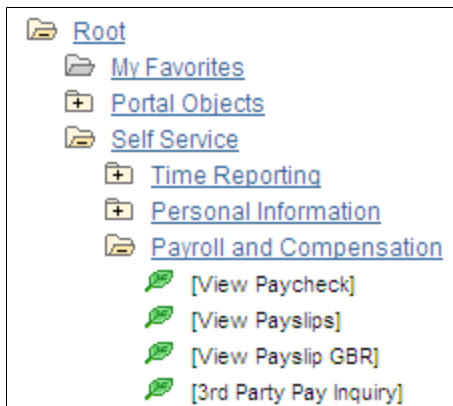

### Populating HTML Areas

You can populate an HTML area either statically, using the HTML Area Properties dialog box, or dynamically, by associating the control with a record field. Because the HTML that you write is included in the HTML that is dynamically generated by the system at runtime, consider the following:

- The HTML that you include can affect the page layout.

Complying with the design-time sizing of the HTML area is the best way to ensure that you do not affect the layout of the other page field controls. Adding an invisible frame around the HTML area control can help ensure that you do not affect other page fields.

- You can use only certain types of HTML tags. These tags are *not* supported by the HTML area control:
  - `<body>`
  - `<frame>`
  - `<frameset>`
  - `<form>`
  - `<head>`
  - `<html>`
  - `<meta>`
  - `<title>`

## Using JavaScript in HTML Areas

When using an HTML area field for adding JavaScript, make sure that JavaScript code is added only once per page. It should not be added in multiple places on a single page unnecessarily. This improves browser performance, especially for display on mobile devices.

## Using Rich Text Editor-Generated HTML in an HTML Area

When you use the rich text editor to generate HTML that appears in an HTML area page control, you must call the `ProcessRTEHTML` function to process the rich text editor-generated HTML before you assign it to the HTML area. The `ProcessRTEHTML` function wraps the HTML inside a `<div>` element, sets the style class to `PT_RTE_DISPLAYONLY`, and attaches the image processing JavaScript. Use the following code as an example:

```
Declare Function ProcessRTEHTML PeopleCode WEBLIB_PTRTE.ISCRIPT1 FieldFormula;

&HTMLAAREA.value = ProcessRTEHTML ("URL ID of the image target", "HTML Data To be P=
rocessed");
```

Your code might look like this:

```
&HTMLAAREA.value = ProcessRTEHTML (URL.PT_RTE_IMG_DB_LOC, "<p>example</p>");
```

The `&HTMLAAREA.value` should be similar to this:

```
<div id="RTEDiv188" class="PT_RTE_DISPLAYONLY">
  <p>example</p>
  <script type="text/javascript" language="JavaScript">
    PTRTE_CheckImages("", "PT_RTE_IMG_DB_LOC", "RTEDiv188");
  </script>
</div>
```

## Using HTML Areas in AJAX Mode

Note the following code restrictions in HTML areas when running the application in AJAX mode:

- Do not include XML tags, such as `CDATA`.
- Do not include empty or commented out `<script>` elements.



- Do not include `document.write` as part of the HTML in an HTML area.

## Using HTML Areas in Grids or Scroll Areas

If HTML area fields are used in a grid or in a scroll area, they can cause performance degradation if there are more than 50 rows in the grid or in the scroll area, or if there are many HTML area fields in the grid or in the scroll area. This is due to the behavior of partial page refresh. During a partial page refresh, the system cannot determine what has been changed within the fields of an HTML area, so all fields in an HTML area are refreshed, regardless, which can hamper performance.

## Related Links

"Using the GenerateTree Function" (PeopleTools 8.58: PeopleCode Developer's Guide)

## Inserting HTML Areas

To insert an HTML area on a page:

1. Select Insert > HTML Area.
2. Draw the HTML area on your page.
3. Move the HTML area control by dragging it with the mouse or by pressing the arrow keys.

## Populating HTML Areas

This section discusses how to:

- Populate an HTML area statically.
- Populate an HTML area dynamically.

**Image: HTML Area Properties dialog box - HTML tab**

This example illustrates the HTML tab of the HTML Area Properties dialog box. The Constant radio button has been selected, which determines that static HTML code can be entered in the edit box.

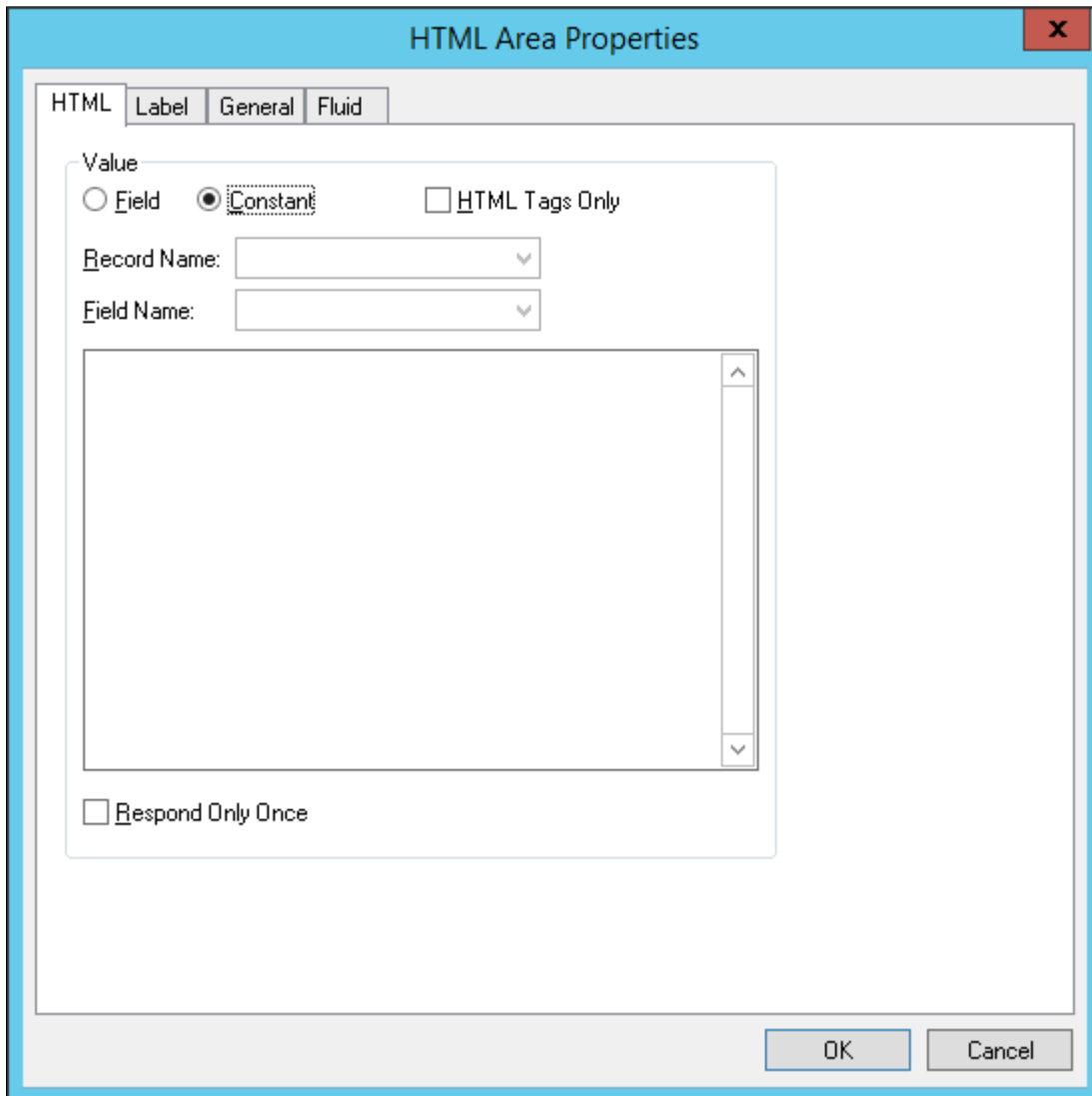
**Field**

Select the Field radio button to enable selection of a record field for populating the HTML area dynamically at run time.

**Constant**

Select the Constant radio button to enable entering static HTML code in the text entry area below.

**HTML Tags Only**

Select this check box to disable processing of the HTML code that will relocate special tags such as <meta> and <script> from the body of the code into the <head> section of the HTML document. Therefore, this check box should be selected only when the HTML code includes tags that are for the <body> section of the HTML document.

**Record Name**

When the Field radio button is selected, select the record name.

**Field Name**

When the Field radio button is selected, select the field name that contains the HTML code at runtime.

**Respond Once Only**

Select this check box to indicate that this HTML area is to be included in the AJAX response one time only, except when some other properties of the HTML area have been changed, such as its content, label, and so on. When this check box is unselected, the HTML area is always included in the AJAX response. This setting applies to HTML areas at any level (from level 0 to level 3).

---

**Note:** This setting can be overridden by the "ForceUpdateOnce" (PeopleTools 8.58: PeopleCode API Reference) property of the Field class.

---

**Populating an HTML Area Statically**

To populate an HTML area statically:

1. Access the HTML Area Properties dialog box.
2. On the HTML tab, select Constant as the value type.
3. In the text entry area, enter the HTML code that you want to appear in the HTML area.

**Populating an HTML Area Dynamically**

To populate an HTML area dynamically:

1. Access the HTML Area Properties dialog box.
2. On the HTML tab, select Field as the value type.
3. Specify the record and field to which you want to associate the HTML area control.

The value of the record field generates the HTML code that is included at runtime in the HTML area.

---

**Note:** When you associate an HTML area control with a field, make sure that the field is long enough to contain the data that you want to pass to it. For example, if you associate an HTML area control with a field that is only 10 characters long, only the first 10 characters of your text will appear. You should use long character fields for record fields that are associated with an HTML area control.

---

**Changing HTML Area Labels**

Assign a distinct label to your HTML area to distinguish it from other HTML area controls on the Order tab of the page definition.

---

**Note:** Unlike other page controls, the label for an HTML area is displayed on the Order tab only and is not displayed at runtime when the page is rendered in the browser.

---

**Image: HTML Area Properties dialog box - Label tab**

This example illustrates the Label tab of the HTML Area Properties dialog box.

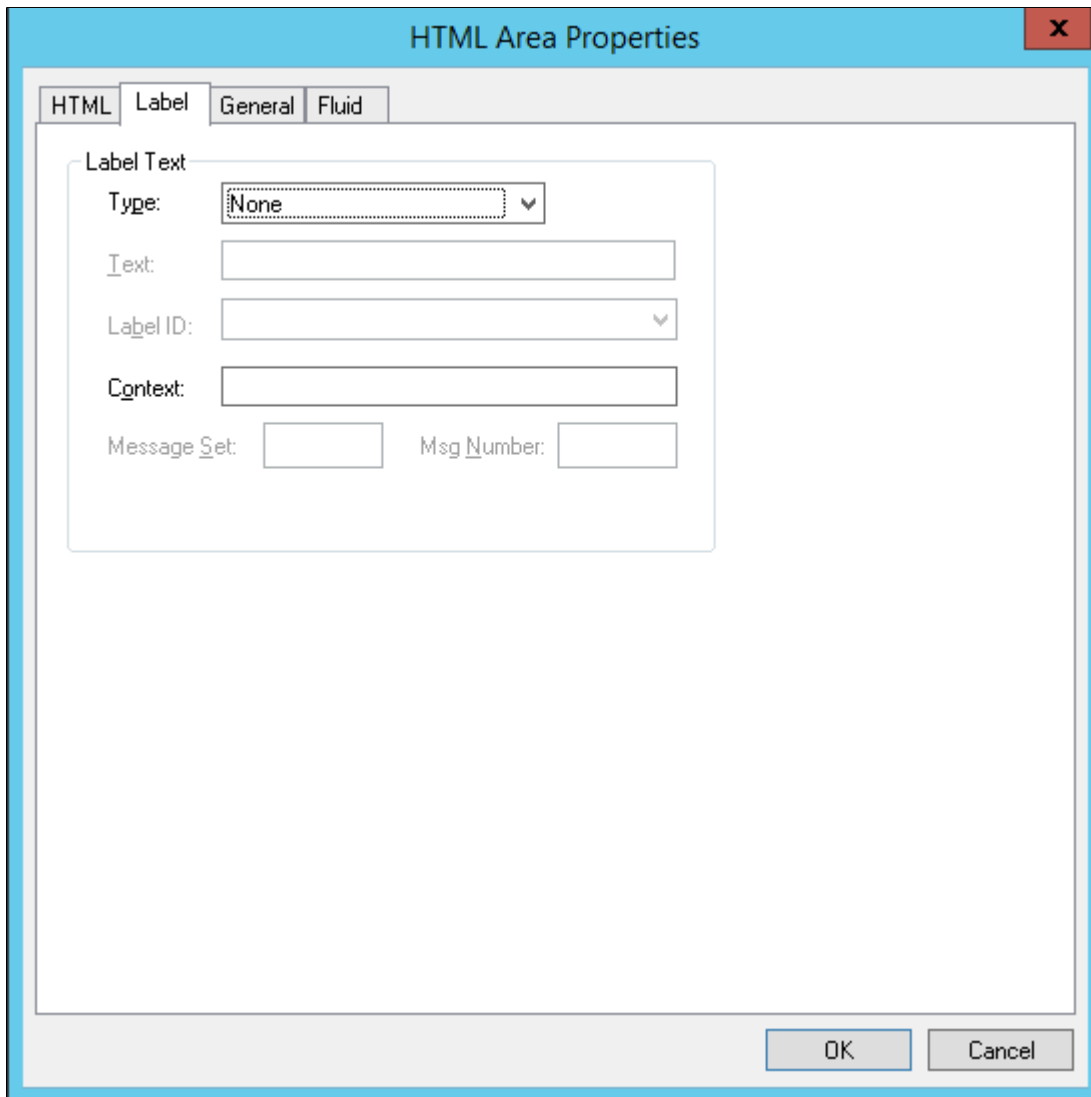
**Type**

Select the label type:

- *None* — Select to display no label on the Order tab.
- *Text* — Select to display text that you enter in the Text field. The default text is the long name for the field from the associated record definition.
- *Message Catalog* — Select to display a Message Catalog entry as the label.
- *RFT Long* — Select to display the RFT long name for the field from the associated record definition. This value is the default.
- *RFT Short* — Select to display the RFT short name for the field from the associated record definition.

<b>Text</b>	Enter the text to display on the Order tab.
<b>Label ID</b>	Select from the drop-down list box the label you want to use for the HTML area. The available choices are based on the Label ID column and the Long Name column for the selected field definition.  The default setting for this option is <i>Use Default Label</i> . This default is determined by the label you select as the default for the field definition.
<b>Context</b>	Displays text to assist the translation team determine the context of the field label to be translated. The context is determined by the field name and label ID combination. If no contextual information exists in the database, then no text appears in this field.
<b>Message Set/Msg Number</b>	Enter the message set number and message number to specify the label text.

To change an HTML area label:

1. Access the HTML Area Properties dialog box.
2. Select the Label tab.
3. Enter a brief text description of the HTML area.

This label does not display at runtime; however, it appears on the Order tab of the page definition.

## Including Fields Within HTML Areas in the Page Tab Order

When the PeopleSoft system generates HTML for a page, it creates a tab index, or order, including every control or widget on the page, based on the field order for that page in Application Designer. However, with HTML areas, the system skips any control defined within an HTML area, by default, when building the tab index. In some situations, this may be confusing to an end user, such as in the case when screen readers are used.

To include the controls in an HTML area within the page tabbing order, add the `%tabindex` meta-variable to the HTML. At runtime, for each field inside an HTML area that is defined with the `%tabindex` meta-variable, `%tabindex` will be replaced with the tab index of the HTML area itself.

In the following example, two fields have been defined with the `%tabindex` meta-HTML variable, while one has not:

```
<a href="http://www.w3schools.com" tabindex="%tabindex">Visit W3Schools.com!</a>
<a id="HELP" name="HELP" href="javascript:some_function1();" tabindex="%tabindex">H⇒
elp</a>
<a id="NEWWIN" name="NEWWIN" href="javascript:some_function2();" >New Window</a>
```

At runtime, if the tab index for the HTML area is 20, then this HTML fragment resolves to:

```
<a href="http://www.w3schools.com" tabindex="20">Visit W3Schools.com!</a>
<a id="HELP" name="HELP" href="javascript:some_function1();" tabindex="20">Help</a>
<a id="NEWWIN" name="NEWWIN" href="javascript:some_function2();" >New Window</a>
```

This meta-variable is documented in more detail in the PeopleCode documentation, see "%tabindex" (PeopleTools 8.58: PeopleCode Language Reference) for more information.

---

**Note:** The tab order of controls within an HTML area cannot be customized by end users.

---

---

## Using Push Buttons and Links

This section provides an overview of push buttons and links and discusses how to:

- Insert push buttons or links.
- Specify type properties for push buttons or links.
- Specify label properties for push buttons or links.
- Specify use properties for push button or link.
- Programmatically change hover text for push buttons or links.

## Understanding Push Buttons and Links

PeopleSoft Pure Internet Architecture supports these features for push button and link controls:

- Selecting link style.
- Selecting these types of push buttons and links:
  - External link.
  - Instant messaging action.
  - Internal link.
  - Page anchor.
  - PeopleCode command.
  - Process.
  - Prompt action.
  - Scroll action.
  - Secondary page.
  - Toolbar action.
- Selecting these image options:
  - On mouse over.
  - When disabled.

## Inserting Push Buttons or Links

After you add a push button or link control to your page, you can define the attributes by opening the Push Button/Hyperlink Properties dialog box.

To insert a push button or link:

1. Select Insert > Push Button/Hyperlink.
2. Click where you want the upper, left-hand corner of the control to begin.  
A push button of *small image* size appears.
3. Double-click the push button to access the Push Button/Hyperlink Properties dialog box.
4. On the Type tab, select whether the control appears as a push button, hyperlink, or action widget.
5. Select a destination type from the Destination drop-down list box.  
See [Specifying Type Properties for Push Buttons or Links](#).
6. Select the record and field names with which you want to associate the push button or link.
7. Select any of the remaining Type options based on your destination type.
8. On the Use tab, select the purpose of the control.  
See [Specifying Use Properties for Push Buttons or Links](#).
9. Save the page.

## Specifying Type Properties for Push Buttons or Links

Access the Push Button/Hyperlink Properties dialog box.

### Image: Push Button/Hyperlink Properties dialog box: Type tab

This example illustrates the fields and controls on the Push Button/Hyperlink Properties dialog box: Type tab. You can find definitions for the fields and controls later on this page.

## Type Tab

Each destination type that you select enables a different region on the Type tab, enabling you to further define your push button or link. Select one of these values from the Destination drop-down list box:

### Type

Select a type of push button or hyperlink. Options are:

- **Push Button:** Adds control in the shape of a button with borders that end users click.
- **Hyperlink:** Adds a control of underlined text with no border that users click.
- **Action Widget:** Adds a hyperlink that triggers JavaScript when clicked. When selected, the system defaults the Destination to *PeopleCode Command* and activates the Action Widget Settings group box.



---

**Important!** The combination of record and field names associated with the action widget must be 28 characters or less.

---

## External Link

Accesses a uniform resource locator (URL). You can select a value from the URL table or use the value of a record field to define the destination.

Selecting this option enables the External Link group box. You can choose to have the URL encoded or not by selecting the Encoded by Application check box.

Selecting this option applies an external link to your page in the form of a push button or link that accesses a new page, taking the user to the external web site that you designate. To return to the primary page, the user closes the new page. When setting the record and field name, consider these points:

- If you specify a dynamic external link, you must enter a record name and field name.

The system uses the value of the record and field specified as the value of the link.

- Whether the external link is static or dynamic, you can use the specified record and field names to control the page field in PeopleCode when you want, for example, to hide the link dynamically with PeopleCode.
- The tool tip, or mouse over text, that appears with the link at runtime comes from the RFT long label assigned to the record field.

However, the RFT long label appears only if it is different from the assigned display value of the link and it is not null.

If the link appears as an image button, the tool tip is derived from the label text if it exists. Otherwise, the system uses the RFT long label.

## Internal Link

Accesses a PeopleSoft page. Parameters include the menu path to the page and a check box to specify whether data from the current page should be used in the search dialog box.

Selecting this option enables the Internal Link group box.

Selecting this option adds an internal link in the form of a push button or link that you can use to access another component or page from within the system or another PeopleSoft database or node. You can even specify the type of action mode to open in for that page. To control the push button or link in PeopleCode, enter the record and names.

Like the external link, if you associate a record and field name with this link, the tool tip that appears at runtime draws from

the RFT long label for the record field. However, the RFT long label only appears if it is different from the assigned display value of the link.

### **Instant Messaging Action**

Select to add an instant messaging button to the page. Associate the button with a record field that contains entries in the form of <user>@network (such as John@Yahoo). For this purpose, we provide the MCFIMNETWORKS table. The MCFIMDOMAIN field is the source for the instant messaging network providers.

This table contains only three network providers: AOL, Yahoo, and SameTime Connect. You should never enter additional networks not already in this table.

See MultiChannel Framework.

### **Page Anchor**

Enables the user to jump to the anchor tag that you designate for a page field on the General tab of the properties dialog box for that field.

Selecting this option enables the user to jump from one destination (the link that you assign as the page anchor) to another (the field that you enable as the page anchor) in your page. When you select this option, the page fields that you previously set as page anchors on the General tab of the properties dialog box appear in the Related Control drop-down list box in the Actions group box. You can place as many page anchor buttons or links on the page as necessary.

### **PeopleCode Command**

Associates a record field, so when the user clicks the push button or link, the system runs any FieldChange PeopleCode that is associated with that field. Enter the record and field names. The field must have PeopleCode in the FieldChange event.

---

**Important!** The combination of record and field names associated with the action widget must be 28 characters or less.

---

### **Process**

Runs processes that you set up previously with PeopleSoft Process Scheduler. Associate process push buttons with a specific process definition; the process is run each time that a user clicks the button.

Selecting this value enables the Process group box, where you can specify the type and name of the process that you want to run.

See "Submitting Process Requests" (PeopleTools 8.58: Process Scheduler).

### **Prompt Action**

Displays a prompt dialog box for a specific control field. Adds a custom prompt button or link next to a field on the page in place of the standard prompt that is associated with that field. For example, you might want the prompt to read *Find an Airport Code*.

Selecting this value enables the Actions group box. In the Related Control drop-down list box, select the field that you want to associate with the prompt. The system sets the action type, *Prompt*, automatically. Set the text label properties for the link on the Label tab.

### Scroll Action

Represents certain actions that a user can perform on a grid, scroll area, and scroll bar, such as bottom, top, insert row, and so on.

Use to provide action buttons for the grid, scroll area, or scroll bar in areas outside of that control, such as at the bottom of the page or outside the borders of the control.

Selecting this value enables the Actions group box, where you can specify the action type and related control. The Action Type field enables you to select the action to be performed in the specific level. The level is specified in the Related Control field. Specify one of the following scroll actions: *Bottom*, *Next*, *Previous*, *Row Delete*, *Row Insert*, and *Top*.

For example, if you want a user to be able to move through a page at runtime, set the action type to *Next* or *Previous* and specify which scroll area you want those actions to control.

### Secondary Page

Access an existing secondary page. After you design a secondary page, you must associate it with a control on the primary page. The secondary page push button or link is the starting point for the user of that secondary page. Selecting this option enables the Secondary Page group box, where you can select the name of the secondary page that you want to associate with the push button or link.

### Toolbar Action

Represents the various toolbar actions available to the user. A user can perform several actions on a page, such as save, display the next page in a group, correction mode, and so on. These normally reside on the toolbar at the bottom of each PeopleSoft Pure Internet Architecture page. Use this type of push button or link for placing save, next in list, or other toolbar functions on the page.

Selecting this value enables the Actions group box, where you can specify the action type: *Add*, *Correction*, *Next in List*, *Next in Worklist*, *Next Page*, *Notify*, *Previous in List*, *Previous in Worklist*, *Previous Page*, *Refresh*, *Return to List*, *Save*, *Update/Display*, *Update/Display All*, or *View Worklist*.

---

**Note:** The following options appearing in the Action Type list for a Destination of *Toolbar Action* should not be selected. These options are reserved for internal use until a future release: *Back*, *Clear Prompt*, *Home*, *IN Prompt*, *Logout*, and *Nav Bar*.

---

## External Link Group Box

In this group box, select Dynamic or Static and enter the URL ID, if necessary. Select a value from the URL Maintenance table of a record field to define the destination. For example, a derived record field might be used to set the destination value dynamically at runtime. The value of the derived record field is placed in the <href> tag of the HTML.

See "URL Maintenance" (PeopleTools 8.58: System and Server Administration).

## Internal Link

### Portal

Select the portal to which you want the internal link to point. *Use Current* is the default. Valid values include all of the values in the PORTAL\_NAME column of the PSPRDMDEFN table.

### Node

Select the PeopleSoft database to which you want the internal link to point. *Local* stands for the node that is marked as the default only. If the content reference you need is registered with a non-default local node, make sure you choose the exact same value from this drop-down list box.

Valid values include all of the values in the MSGNODENAME column of the PSMMSGNODEDEFN table. If you select a node other than *Local*, the Use data from current page in search check box is deselected.

The node that you select should match the node for the destination component in the Registration Wizard or on the Content Ref Administration page. Select PeopleTools > Portal > Structure and Content. Click the Edit link to access the Content Ref Administration page.

### Menu

Select the menu name in which the destination page is contained.

### Component

Select the component in which the destination page is contained. These values depend on the menu that you select.

### Market

Select the market of the destination component.

See [Specifying Market-Specific Components](#).

### Page

Select the page that should be active. These values depend on the component that you select.

### Action

Select the action mode in which you want the page to begin.

### Use data from current page in search

Select if you want data from the current page to be used in the search dialog box. This option ensures that the new page inherits the proper keys from the context of the current page. The process is almost identical to the **Transfer( )** PeopleCode function, and it performs a similar function.

If this check box is selected, the system discards the existing key list; builds a new key list from the current component buffer

using the context of the field (when a choice exists between rows in a scroll area); and uses this key list to start the new component.

If this option is deselected, the system uses the existing key list in the normal manner.

### Action Widget Settings Group Box

The *default* usage for the action widget is to add a control to a page that when clicked displays a drop-down menu containing the related actions associated with that widget. However, this widget can also be used to trigger custom JavaScript.

#### Use Default JavaScript

Select to make the Custom JavaScript edit box read-only and populate the edit box with the with the default JavaScript, *RelatedActionJS*.

If you want to revert the field to the default, just select this check box and the system repopulates the field with the default value.

#### Custom JavaScript

When enabled, enter the name of the custom JavaScript to execute.

See "Understanding the PeopleSoft Related Content Framework" (PeopleTools 8.58: Portal Technology)

## Specifying Label Properties for Push Buttons or Links

This section discusses how to:

- Specify a text label.
- Specify an image label.

### Image: Push Button/Hyperlink Properties dialog box: Label tab

This example illustrates the fields and controls on the Push Button/Hyperlink Properties dialog box: Label tab. You can find definitions for the fields and controls later on this page.

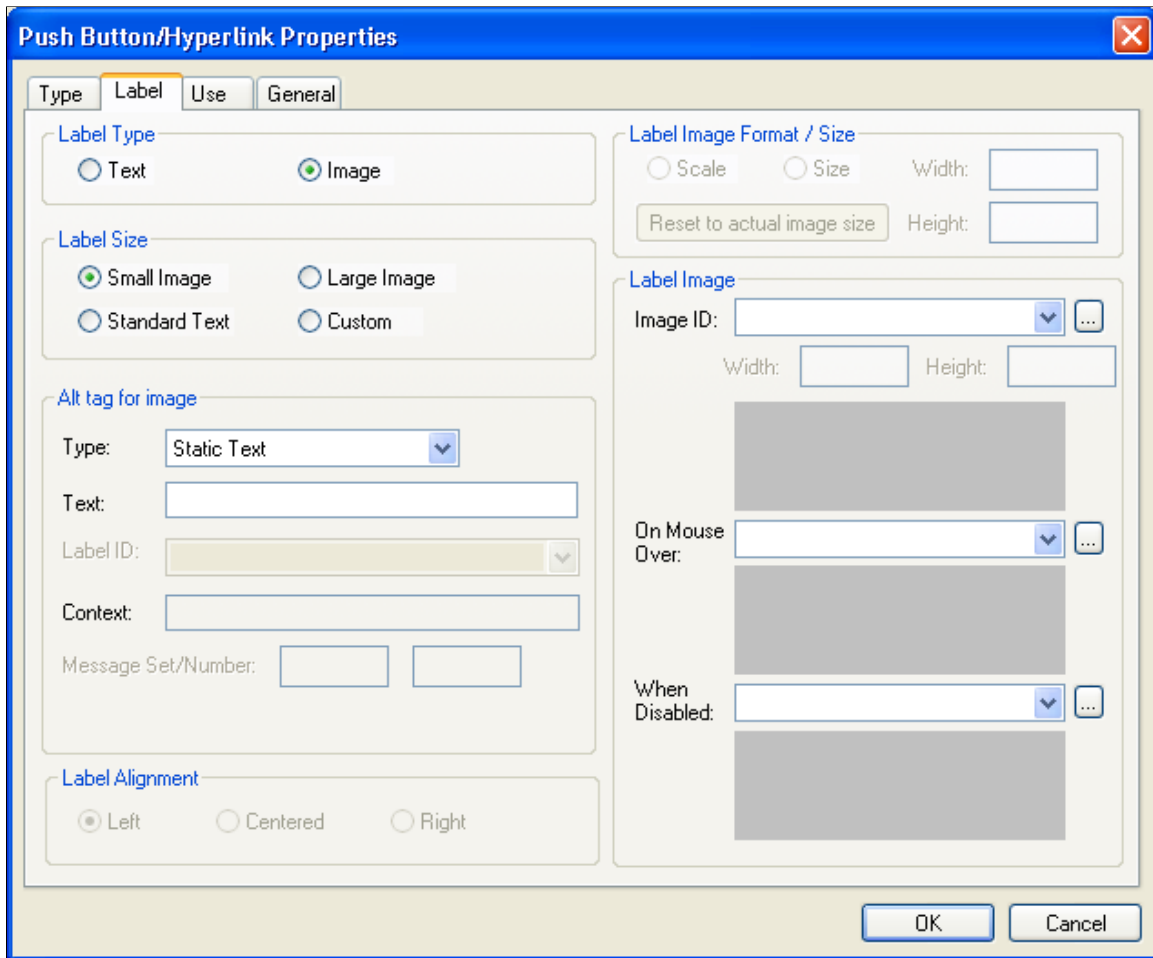

### Specifying a Text Label

To specify a text label for a push button or link:

---

**Important!** For an action widget, Text is the only valid label type selection. Even though Both is presented as an option, do not select Both; if you do, the action widget will not be displayed.

---

1. Access the Push Button/Hyperlink Properties dialog box.
2. Select the Label tab.
3. In the Type group box, select Text.
4. Select the size.

Standard push buttons can be one of three sizes, depending on what kind of text or image you want to display on the button face.

<b>Small Image</b>	Creates toolbar-sized buttons that handles small 16 × 16 pixel images.
<b>Large Image</b>	Handles 32 × 32 pixel images.
<b>Standard Text</b>	Matches the Microsoft standard dimensions for text push buttons.
<b>Custom</b>	Select if none of these sizes meets your needs. When you click OK, the push button displays selection handles that you can use to resize it.

5. Specify the type of label text.

Depending on the destination type that you selected, the values in the Type drop-down list box differ.

<b>Message Catalog</b>	Select to reference a message that exists in the message catalog. Enter the message set and number. Message catalog items are all translatable.
<b>RFT Short</b> (record field table short)	Select to label the push button with the short name for the field from a record definition. The RFT stores attributes for fields in a record definition. Use this option only if you specified a record definition and field name on the Type tab in the Push Button/Hyperlink Properties dialog box. The RFT short name appears on the push button when you click OK and return to the page. Select the label ID if you do not want to use the default label if more than one label has been set for the record field.
<b>RFT Long</b> (record field table long)	Select to label the push button with the long name for the field. Use this option only if you specified a record definition and field name on the Type tab in the Push Button/Hyperlink Properties dialog box. The RFT long name appears on the push button when you click OK and return to the page. Select a different label ID if you do not want the default label if more than one label has been set for the record field.  The system uses the RFT long label as the tool tip at runtime for links if it is different from the assigned display value of the link and it is not null. If more than one label is stored for the record field, you can select an alternate tool tip from the Label ID drop-down list box.
<b>Static Text</b>	Select to enter the text to appear on the label.
<b>URL Description</b>	Select if you selected <i>External Link</i> as the destination on the Type tab. Select the style from the drop-down list box.  See <a href="#">Understanding Style Sheets and Style Classes</a> .

6. Select the alignment.

This option is only available if you selected **Hyperlink** for the type on the **Type** tab. Push button text is automatically centered for controls that appear as push buttons. Push buttons with text and images are automatically center-aligned when used in grids.

## Specifying an Image Label

To specify an image label for your push button or link:

1. Access the Push Button/Hyperlink Properties dialog box.
2. Select the Label tab.
3. Select Image for the type.
4. Specify the size.

If you select Custom, the Image/Format Size group box becomes available.

<b>Scale</b>	Select to adjust the width and height as percentages.
<b>Size</b>	Select to set the image size by altering the width and height in pixels.
<b>Reset to actual image size</b>	Resizes the image according to its natural size. That is, the image size is not manipulated by custom width or height values.

5. Specify the image ID.

Select one of the predefined image definitions or click the Browse button to view push button images.

See [Understanding Image Definitions](#).

6. In the Alt tag for image group box, specify the hover text type.

<b>Message Catalog</b>	Select to reference a message that exists in the message catalog. Enter the message set and number. Message catalog items are all translatable.
<b>RFT Long</b> (record field table long)	Select to use the long name of the record field as the hover text. Use this option only if you specified a record definition and field name on the Type tab in the Push Button/Hyperlink Properties dialog box.  The system uses the RFT long label as the tool tip at runtime for links if it is different from the assigned display value of the link and it is not null. If more than one label is stored for the record field, you can select alternate hover text from the Label ID drop-down list box.
<b>RFT Short</b> (record field table short)	Select to use the short name of the field as the hover text. Use this option only if you specified a record definition and field name on the Type tab in the Push Button/Hyperlink Properties dialog box. If more than one label is stored for



the record field, you can select alternate hover text from the Label ID drop-down list box.

**Static Text**

Select to enter the text that will appear on the label.

7. (Optional) Select the image that will appear on a mouse over.

For example, you might want to highlight an image so that users can easily see which option they are selecting.

8. (Optional) Select an image that will appear when the button is disabled.

**Specifying Use Properties for Push Buttons or Links**

Access the Push Button/Hyperlink Properties dialog box and click the Use tab.

### Image: Push Button/Hyperlink Properties dialog box: Use tab

This example illustrates the fields and controls on the Push Button/Hyperlink Properties dialog box: Use tab. You can find definitions for the fields and controls later on this page.

**Push Button/Hyperlink Properties**

Type Label **Use** General Fluid

**Field Use Options**

- Enable When Page is Display Only
- Open in New window
- Replace Current Window
- Activate by Enter Key
- Set Component Changed
- Persist Grid Column in Menu
- Execute PC on Row/Group Click
- Execute SearchSave Event

**Grid Cell Alignment**

Left     Centered     Right

**Mouse Over Popup**

No Popup

Page Popup

Message Catalog Popup

Message Set/Number:

Text:

OK Cancel

### Field Use Options

This table describes the Field Use options:

**Enable When Page is Display Only** Select to make the push button or link available to users who have display-only access to this page.

Display-only access is set in the permission list properties.

**Open in New Window** Select to open the target content page in a new browser window. This option is enabled when the destination type is either *Internal Link* or *External Link*. This option and *Replace Current Window* are mutually exclusive.

**Replace Current Window**

Select to replace the existing content in the target area. This option is enabled when the destination type is either *Internal Link* or *External Link*. This option and Open in New window are mutually exclusive.

**Activate by Enter Key**

Select to activate the push button or link when the user presses the Enter key. You can have more than one push button or link with this feature set per page, as long as only one of these fields is enabled at runtime. Otherwise, only one push button or link with this attribute enabled is allowed per page. This feature is available for all control types except external links.

When using Activate by Enter Key in a scroll area or grid with an occurs count greater than one, the Enter key triggers the first row only.

Note that on a secondary page with the standard OK and Cancel buttons enabled, the Enter key activates the OK button rather than a custom button or link.

**Set Component Changed**

Enables the system to issue a save warning for the field if the user changes the value and attempts to exit the page before saving. This setting reinforces current save warning behavior. This option is set by default for edit boxes, long edit boxes, radio buttons, check boxes, and drop-down list boxes. Deselecting this option overrides the save warning that normally appears to users. The user will not see a save warning after changing the value of the field and attempting to exit the page.

An example of when this might be necessary is for a drop-down list box that includes links to another page. If the user selects a link from this field to transfer to another page but has not made any other changes to the page, then the system is not required to issue a save warning.

By deselecting the Set Component Changed flag, you ensure that no save warning message is issued for this field. This option works for fields associated with a derived work field or database record field.

For the push button/hyperlink control, the default setting is deselected instead of selected, unlike with other page controls.

**Persist Grid Column in Menu**

---

**Important!** Persistent search, the drop-down menu, and other forms of classic navigation are no longer supported. The default navigational interface for PeopleSoft applications in the current release is based on the fluid banner, which can be used for both classic and fluid applications.

---

Select to include the field as a list box item in the persistent search results grid. You must also select the Persist in Menu grid property for the grid that contains the field.

This property is disabled on check boxes and radio buttons.

You must enable recent search results caching at the system level in the web profile for this property to take effect.

---

**Note:** This property applies *only* to fields that appear in grids on pages that are used as custom, application-specific search pages.

---

### Execute PC on Row/Group Click

---

**Important!** Use this property in fluid applications only.

---

Select to identify this button or hyperlink as a trigger field for either the grid row or group box containing this page field.

When the user clicks or taps anywhere in the grid row or group box, the system executes any FieldEdit and FieldChange PeopleCode associated with this field.

### Execute SearchSave Event

---

**Important!** Use this property on custom fluid search pages or custom fluid prompt pages only.

---

Select to trigger the execution of SearchSave PeopleCode on a Search button appearing on a fluid search page or a fluid prompt page.

## Grid Cell Alignment

Push buttons with images or text are center-aligned automatically when in a grid. Otherwise, select *Left*, *Centered*, or *Right*.

---

**Note:** Grid cell alignment properties are only enabled when the control is contained within a grid and the control type is configured as a text hyperlink.

---

## Mouse Over Popup

Select the Display Only check box to enable the Mouse Over Popup options.

---

**Note:** The mouse over option is intended for hyperlinks and display-only edit box fields, not for Push Buttons.

---

Select from these mouse over pop-up options:

### No Popup

Select to have no pop-up page. This value is the default.

### Page Popup

Select to associate this control with a pop-up page that you select from the drop-down list box. Only pop-up pages appear in the Page Popup drop-down list box.

### Message Catalog Popup

Select to associate this control with a system-defined message pop-up page that displays a message from the Message Catalog. When you select this option, the Message Set/Number fields are enabled. You can also design and implement Message Catalog pop-up pages to be context sensitive.

See "Message Catalog" (PeopleTools 8.58: System and Server Administration).

**Message Set/Number**

Enter the message set and message number of the message. These fields are enabled when you select Message Catalog Popup.

**Text**

Displays the message text of the message set/number that you select. This field is display-only.

---

**Note:** Attempts to make a push button/hyperlink editable at runtime when it has a mouse over pop-up page associated with it, for example, using PeopleCode, will fail.

---

**Related Links**

[Understanding Pop-up Pages](#)

## Programmatically Change Hover Text for Push Buttons or Links

Hover text or mouse over text enables you to display additional or supplemental information about a button or link. Under certain circumstances, you might want to vary the hover text based on the context of application data on the page.

You can alter hover text by using the PeopleCode **HoverText** Field property. This property sets the hover text for any buttons or links associated with the field. The maximum length of hover text is 100 characters. You can use the Message Catalog to store hover text.

### Example: Changing Hover Text Programmatically

To set hover text for a push button or link at runtime, use PeopleCode to define the `HoverText` property for a field definition.

```
QE_ABSENCE_HIST.QE_ABSENCE_TYPE.HoverText = MsgGetText(95, 5037,
"Personalize Layout");
```

---

**Note:** The `HoverText` Field class property is available for the push button/hyperlink page control only.

---



# Using Scroll Areas, Scroll Bars, and Grids

---

## Understanding Scroll Areas, Scroll Bars, and Grids

A page must reflect the underlying table structures so that the system knows where to store data in the database. When you have more than one underlying record definition on a page, the role of scroll areas, scroll bars, and grids in page processing is important. Scroll controls and grids define parent and child record definition relationships on a page.

You assign an occurs level to each scroll control or grid on the page to indicate the relationship between the record definitions and the controls and to determine how the data is processed. The primary record on a page at level 0 has no scroll area or occurs level associated with it. If the page contains a record that is subordinate to the primary table, it has a scroll control with an occurs level of 1. A table that is subordinate to the level 2 record has a scroll area or grid with an occurs level of 2. PeopleTools does not support nesting beyond three levels.

PeopleSoft Application Designer automatically nests the scroll area after you set the occurs levels sequentially. Each field that you place on the page after each scroll area is automatically placed inside the scroll area preceding it until you place the next level-based control on the page.

---

## Using Scroll Areas and Scroll Bars

This section provides an overview of scroll areas and scroll bars and discusses how to:

- Set scroll area general attributes.
- Set scroll area label properties.
- Set scroll area use properties.
- Set scroll bar label properties.
- Set scroll bar use properties.
- Control scrollable data.
- Convert scroll bars to grids.

## Understanding Scroll Areas and Scroll Bars

Scroll areas, rather than scroll bars, are the preferred control for representing multiple rows of data from a table because they are easier to use during design time and offer a wider array of features. The final product at runtime appears more contained because the default setting places a border around the data.

The benefits of using scroll areas rather than scroll bars are:

- The navigation tools that you select for a scroll area are automatically positioned on the navigation bar or footer bar.

For scroll bars, you must place these buttons and links on the page manually.

- Scroll areas provide the option of showing or hiding a border around the data.
- Scroll areas provide the option of a View All button and a Find feature.
- Scroll areas enable you to determine the text or image that appears for the action items in the navigation bars.
- Scroll areas provide a row separator when you select multiple occurrences of data.

## Scrolls, Record Relationships, and Page Processing

A page must reflect the underlying table structures so that the system knows where to store data in the database. When you have more than one underlying record definition on a page, the role of scroll areas and scroll bars in page processing is important. Scroll controls define parent and child record definition relationships on a page.

You assign an occurs level to each scroll control on the page to indicate the relationship between the record definitions and the controls and to determine how the data is processed. The primary record on a page at level 0 has no scroll area or occurs level associated with it. If the page contains a record that is subordinate to the primary table, it has a scroll area with an occurs level of 1. A table that is subordinate to the level 2 record has a scroll area with an occurs level of 2. PeopleTools does not support nesting beyond three levels.

PeopleSoft Application Designer automatically nests the scroll area after you set the occurs levels sequentially. Each field that you place on the page after each scroll area is automatically placed inside the scroll area preceding it until you place the next level-based control on the page.

## Scroll Areas

A scroll area looks like a group box with various controls. The title bar in a scroll area, however, can also serve as a navigation bar. The navigation bar gives the user various options for viewing the data. The plus and minus buttons in the body of the scroll enable the user to add and delete rows of data.



### Image: Example of a scroll area

This example illustrates the fields and controls on the Example of a scroll area. You can find definitions for the fields and controls later on this page.

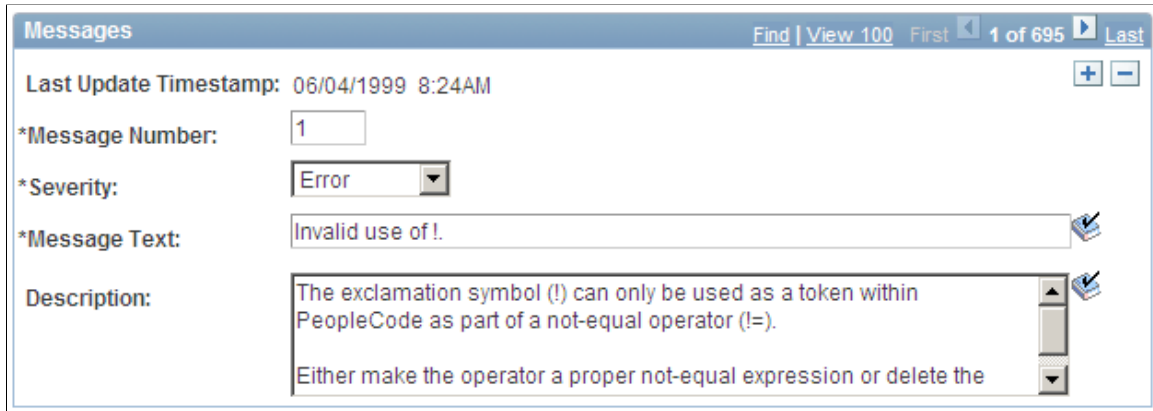

### Related Links

[Level-Based Controls](#)

## Setting Scroll Area General Attributes

Assign the general attributes of a scroll area. These settings are the same for a scroll area as they are for a grid control.

See [Setting Grid General Properties](#).

### Manipulating Fields After Setting the Occurs Count

If you set the occurs count to a number greater than 1, you must reposition the fields in the scroll area. If you change the occurs count after placing fields in the scroll area, they might appear one on top of the other, very close together. Unless you indicate otherwise (in the body area of the Label tab), row separator lines might appear to distinguish one row from the next.

In the following example, the occurs count was set to 5 after placing one field, Access Group, in the scroll area. You must reposition the fields and possibly the labels so that they are evenly spaced in the row separator lines.

### Image: Multiple occurs counts in a scroll area

This example illustrates the fields and controls on the Multiple occurs counts in a scroll area. You can find definitions for the fields and controls later on this page.

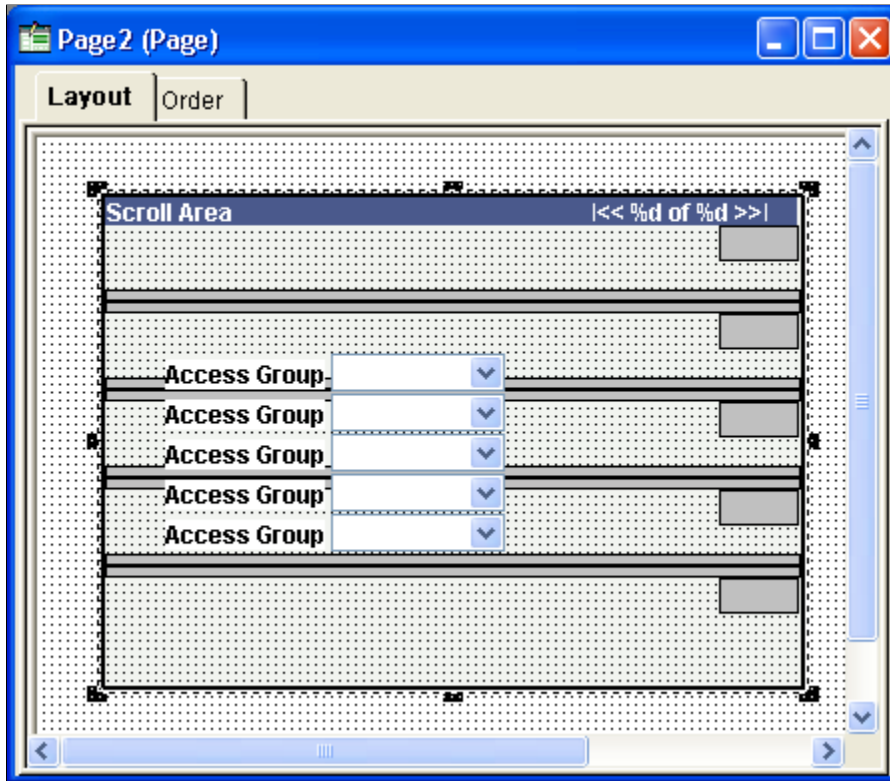

Before you do so, it is helpful to know a few rules about how you can move these fields in relationship to one another. For example, you do not need to move individual fields to their proper destination. For this example, we call the first field in the column of fields, or the original field that you placed in the scroll area, the head field. The fields following the head field are other occurrences.

- The head field controls the horizontal movement of all other occurrences that are below it.
- You cannot move the other occurrences horizontally.
- To evenly space the occurrences vertically, drag the last occurrence in the column to the appropriate position between the bottom edge of the scroll area and the last row separator.

All occurrences above it reposition themselves equidistant from the others.

- You cannot move the add and delete push buttons (represented by the gray boxes on the right side of the scroll area) horizontally on the page.

You can move them only vertically in the same manner as the fields.

After you move the lowest field, the scroll area should look similar to this:

### Image: Fields moved to accommodate multiple occurs counts

This example illustrates the fields and controls on the Fields moved to accommodate multiple occurs counts. You can find definitions for the fields and controls later on this page.

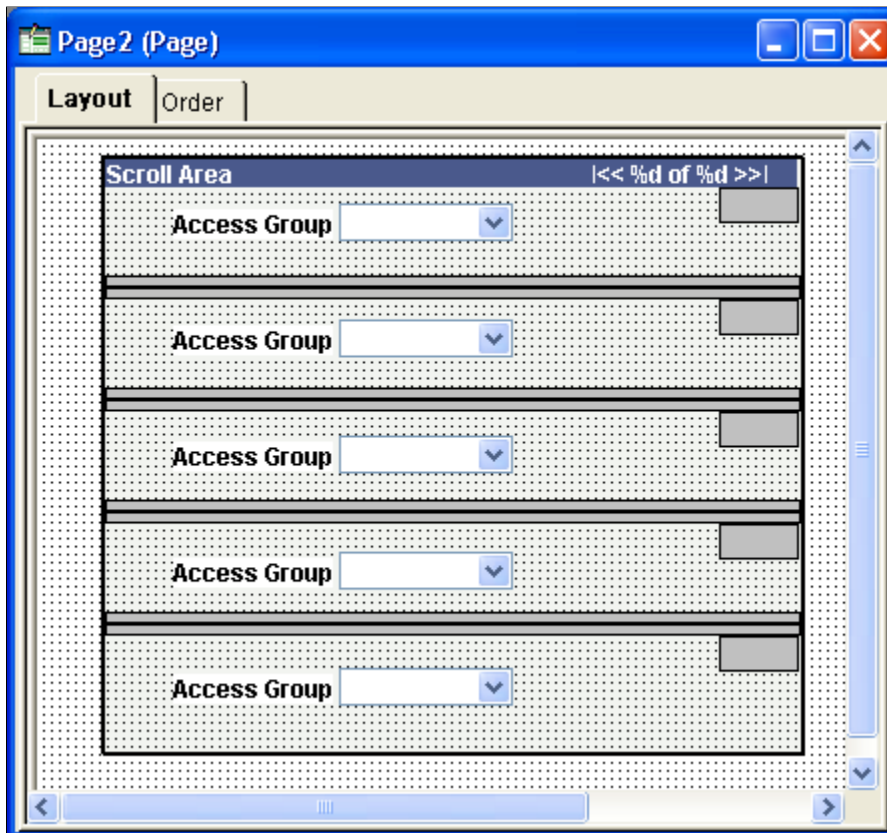

## Setting Scroll Area Label Properties

You can configure links or push buttons in three places on a scroll area to help users navigate through multiple rows of data in a scroll area. These options and the associated settings are the same as those for grids. This section references the setting definitions for grid controls that are described later in this topic.

### Header Area Properties

Use the header area properties to configure the title properties, navigation bar properties, and embedded help properties associated with the scroll area. These properties enable users to access controls for viewing the previous, next, top, or bottom row; to control the settings for the Find, Download, and View All features; and to access embedded help.

The Display Header check box is selected by default and enables access to Header Area properties. To disable the header, deselect the Display Header check box.

To configure title properties for the scroll area:

1. Select the Display Title check box.
2. Select the Left, Center, or Right title alignment option.
3. Click the Display Title Properties button to open the Title Properties dialog box.

4. Enter the Label Text that you want to appear in the scroll area title.

<b>Type</b>	Select the type of label text to appear in the navigation bar.  <i>Message Catalog:</i> Select this option to use a message in the Message Catalog as the grid title.  <i>Static:</i> Select this option to enter manual text as the grid title.
<b>Text</b>	Enter the text to appear as the title of the scroll area. This field is enabled when you select <i>Static</i> as the Label Text type.
<b>Message Set/Number</b>	Enter the message set number and message number of the message in the Message Catalog to appear as the title of the scroll area. This field is enabled when you select <i>Message Catalog</i> as the Label Text type.

To configure navigation bar properties for the scroll area:

1. Select the Display Navigation Bar check box.
2. Select the Left, Center, or Right navigation bar alignment option.
3. Click the Display Navigation Bar Properties button to open the Header Navigation Bar Properties dialog box.

The Header Navigation Bar Properties dialog box contains seven tabs, each pertaining to different settings on the navigation bar. Each tab has the same settings. All settings are set to display by default. Select the Invisible check box that appears in the upper right corner of each tab to hide the tab attribute from the user.

**Image: Header Navigation Bar Properties dialog box**

This example illustrates the fields and controls on the Header Navigation Bar Properties dialog box. You can find definitions for the fields and controls later on this page.

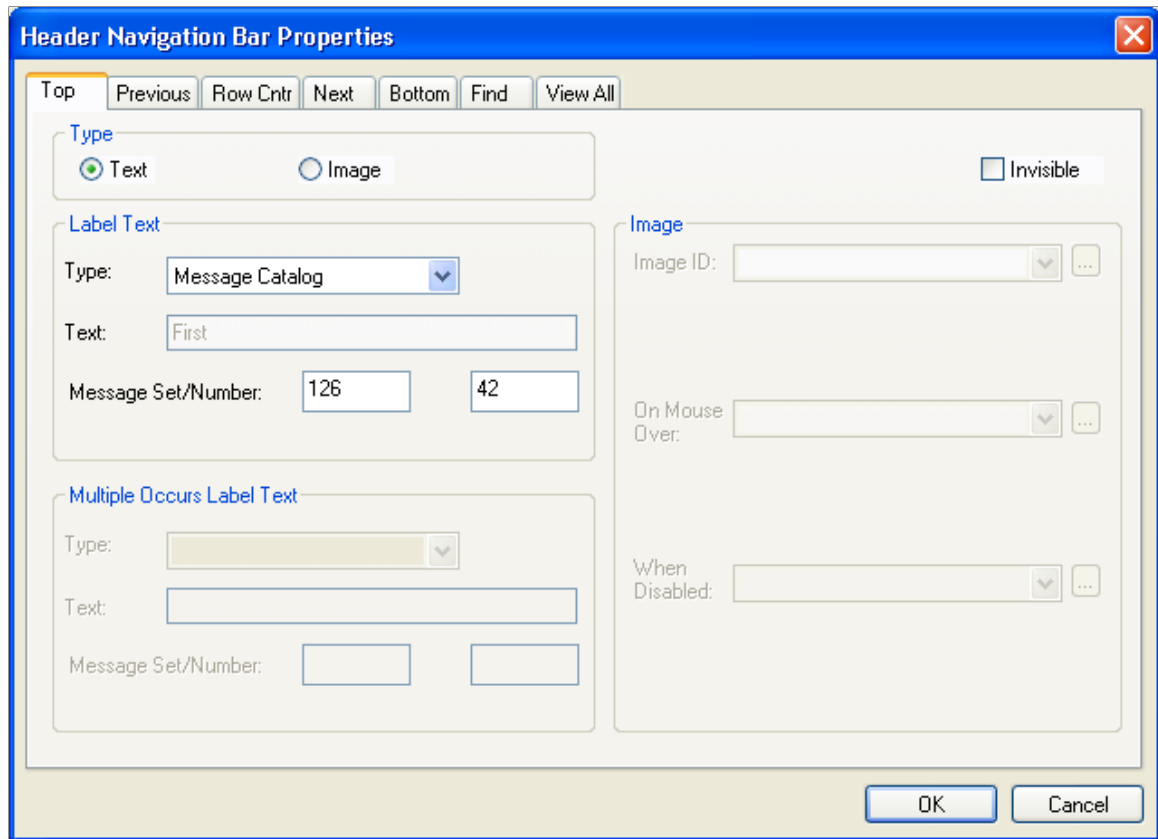

This table describes the tabs in the Header Navigation Bar Properties dialog box:

<b>Top</b>	Controls the attributes for how a user returns focus to the top of the grid or the first row of data in the grid. <i>Text</i> is the default setting using <i>First</i> from the Message Catalog. You can also enter static text.
<b>Previous</b>	Controls how a user can move to a previous row in the grid. <i>Image</i> is the default setting, and the Show Previous Row button is the default image.
<b>Row Cntr</b> (row counter)	Tracks the number of rows in the grid and in which row the cursor focuses. <i>Text</i> is the default setting, and, for example, <i>1-6 of 6</i> appears in the navigation bar if the grid has six rows.
	The Image Type is not enabled on this tab.

---

**Note:** The row count that appears is controlled by the occurs count that you set on the General tab in the Grid Properties dialog box (unless the user displays all). Using the previous example, if the occurs count is set to 5, then the row counter is *1–5 of 6*.

---

<b>Next</b>	Focuses on the next row in the grid. <i>Image</i> is the default setting, and the Show Next Row button appears to the right of the row counter.
<b>Bottom</b>	Controls the attributes for how a user moves focus to the last row of the grid. <i>Text</i> is the default setting using <i>Last</i> from the Message Catalog. You can also enter static text.
<b>Find</b>	Displays a link that enables the user to search any field in the grid or scroll area. You can select either text or an image to represent the Find feature. The Find feature searches for matches in edit boxes, display-only fields, disabled fields, dynamic links, and text in long edit boxes. It does not search column headings, field labels, text values in icons, static links, and hidden fields, nor does it search outside the grid.
	<hr/> <b>Note:</b> The system ignores fields in HTML areas when running a Find request. <hr/>
<b>View All</b>	Enables the user to view all rows of data at once. <i>Text</i> is the default setting using <i>View All</i> as the Message Catalog entry.

To configure embedded help pop-up properties for the scroll area, use these options:

<b>No Popup</b>	Select this option to disable embedded pop-up help.  This value is the default.
<b>Message Catalog Popup</b>	Select this option to enable the embedded pop-up help icon on the grid at runtime. Selecting this option enables the Message Set/Number edit boxes.
<b>Message Set/Number</b>	Enter the message set number and message number of the message catalog entry to appear when the user clicks the embedded help icon.
<b>Text</b>	Displays the message that appears when the user clicks the embedded help icon. This field is display-only.

See "Accessing Embedded Help" (PeopleTools 8.58: Applications User's Guide).

## View All Feature

The View All feature provides a threshold to enable the user to view the data in manageable pieces. If the database returns a number of rows for the grid or scroll area that is greater than the threshold, the View

All link displays "View <threshold value>." This feature also modifies the occurs count and the values for the number of non-displayed rows left to scroll through.

The Next and Previous buttons retrieve rows according to the size of the threshold. If the database returns a total number of rows for the grid or scroll area that is less than the View All threshold, then the View All link on the navigation bar remains and functions as is.

The following example uses the View All threshold, occurs count, and total rows in database values:

- View All threshold = 100
- Occurs count = 10
- Total rows in database = 160

The result is:

### Image: Viewing 10 rows

This example illustrates the fields and controls on the Viewing 10 rows. You can find definitions for the fields and controls later on this page.

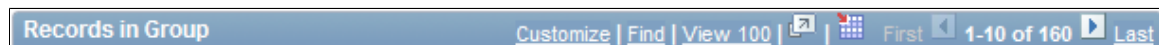

When the user selects View 100, the view value changes to reflect the original occurs count set for the grid. The value for the number of non-displayed rows changes to 100 to match the View All threshold, and the View 100 display changes to View 10:

### Image: Viewing 100 rows

This example illustrates the fields and controls on the Viewing 100 rows. You can find definitions for the fields and controls later on this page.

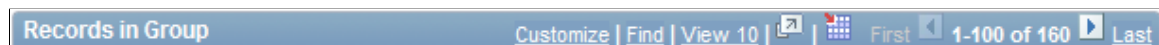

If the Occurs Count, which you define in the properties for grid and scroll areas, is set to a number greater than or equal to the view all threshold, then the threshold takes precedence. The View All display changes to View <threshold value> and the link is unavailable. If you select Unlimited Occurs Count, the grid or scroll area displays all rows in the buffer.

## Body Area Properties

Use the body area properties to configure the row action buttons and set display properties for the body of the scroll area.

This table describes the Body Area properties:

### Row Action Buttons

Select to display Insert and Delete buttons on each grid row at runtime. The action buttons can appear on the left or right side of the scroll area. Click the Properties button to open the Body Area Row Action Button Properties dialog box.

### Background Style

Select a background style to display for the scroll area as a whole. The style selected here applies to all areas of the scroll area that are not covered by other elements.

**Show Border**

Select to display a standard border around your scroll area. The default is selected.

**Show Row Separator**

Select to display vertical separator lines between rows when multiple rows are returned from the database. The default is selected.

**Adjust Layout for Hidden Fields**

Select to have the scroll area adjust its borders to accommodate any hidden fields.

---

**Note:** For the scroll area to adjust automatically, the hidden fields inside the scroll area must be surrounded by open space or have other hidden fields to the right or left.

---

Click the Row Action Buttons Properties button in the Body Area group box to open the Body Area Row Action Button Properties dialog box. It contains two tabs: Insert and Delete. The default settings for these tabs are to display the Insert and the Delete buttons. Alternatively, you can select static or message catalog text, or you can make these items invisible so that they do not appear.

**Image: Body Area Row Action Button Properties dialog box**

This example illustrates the fields and controls on the Body Area Row Action Button Properties dialog box. You can find definitions for the fields and controls later on this page.

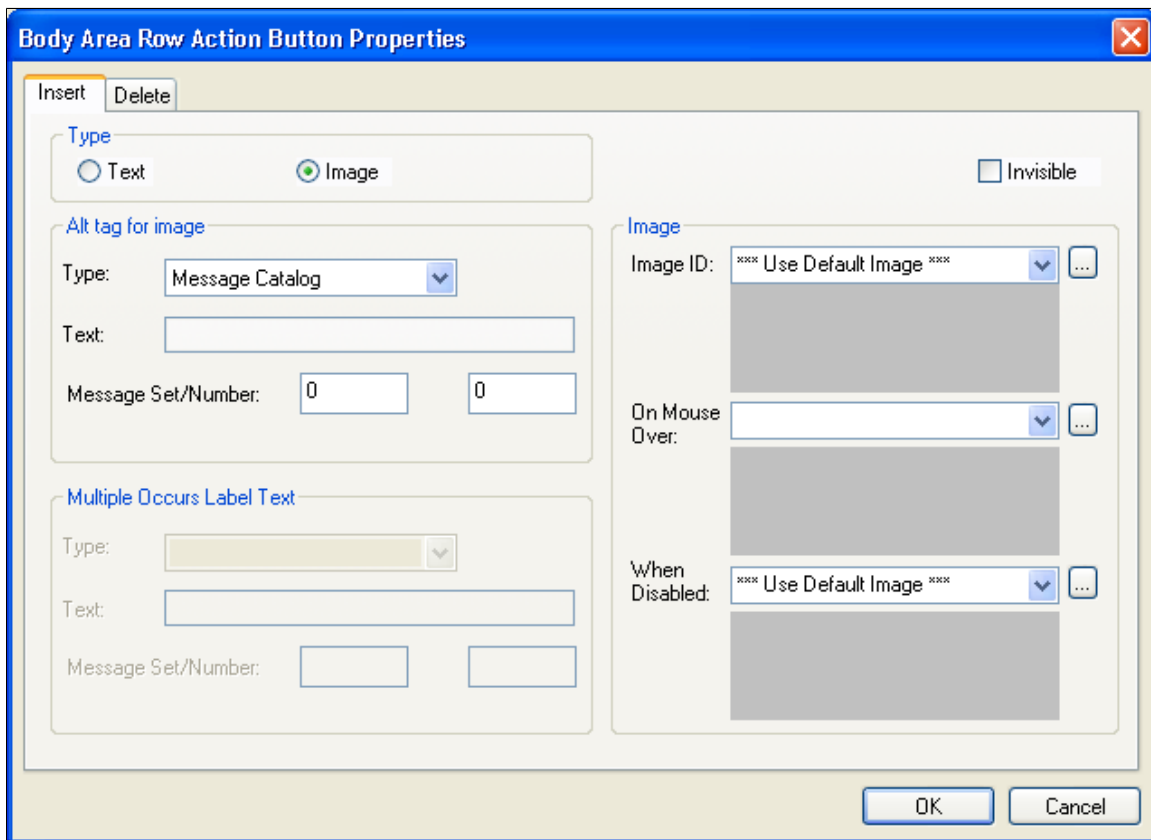
**Footer Area Properties**

In the footer of your scroll area, you can display row action buttons and a navigation bar. To enable either of these features, select the appropriate check box, Display Row Action Buttons or Display



Navigation Bar, and click the Properties button to configure the settings. Clicking the Properties button opens a separate dialog box: Footer Row Action Button Properties or Footer Navigation Bar Properties respectively.

The row action buttons are the same for the footer area as those described for the body area. The navigation bar property options are the same as those described for the header area. However, all other navigation bar settings for the footer are invisible by default.

## Summary Properties

Summary properties enable you to provide a brief description of the functionality and content of the scroll area. This property is pertinent for users who access the application by using screen readers. The default value for the Summary Text field is the same as the Title of the scroll area. You can also enter static text or use the Message Catalog to store the summary information.

Access the Summary Properties dialog box.

### Image: Summary Properties dialog box

This example illustrates the fields and controls on the Summary Properties dialog box. You can find definitions for the fields and controls later on this page.

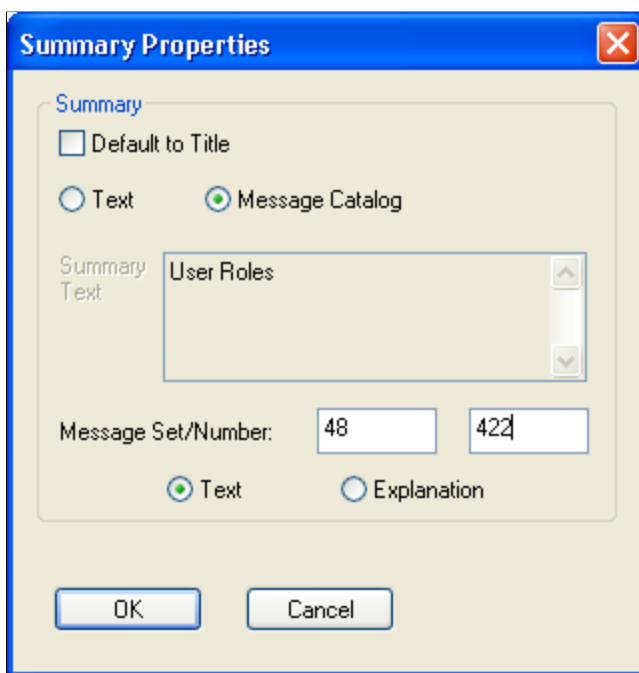

This table describes the summary properties of the grid:

#### Default to Title

Select this check box to have the summary property the same as the grid title. Clear this check box to activate the Text and Message Catalog options.

#### Text

Select this option to enter up to 254 characters in the Summary Text field. Selecting this option disables all Message Catalog option related fields.

## Message Catalog

Select this option to choose a message stored in the Message Catalog. Selecting this option disables all Text option related fields. Select one of these two options:

- *Text* - Select this option to use only the message text from the message catalog.
- *Explanation* - Select this option to use only the message explanation from the message catalog.

To change the Summary properties:

1. Click the Properties button located in the Summary group box.
2. Clear the Default to Title check box to activate the other Summary options.
3. Enter static text or enter a Message Set and Number to retrieve information from the message catalog.
4. Click the OK button.
5. Save the page.

## Related Links

[Setting Grid Label Properties](#)

## Setting Scroll Area Use Properties

You can select several options to determine how you use the scroll area. As with the label properties, the settings on the Use tab of the Scroll Area Properties dialog box are the same as those on the Use tab of the Grid Properties dialog box, except that the scroll area contains fewer attributes than a grid.

When working with the row counter when designing pages in PeopleSoft Application Designer, consider the following:

- If the header area navigation bar is set to invisible, the system displays no header area navigation bar row counter button. Likewise, if the footer area navigation bar is set to invisible, the system displays no footer area navigation bar row counter button. If the row counter button of the header area navigation bar is set to invisible, the system displays no header area navigation bar row counter button.
- If the row counter button of the footer area navigation bar is set to invisible, no footer area navigation bar row counter button is displayed. Otherwise, if not set to invisible, the row counter button will be displayed as "|<< your\_label >>|" where your\_label is the specified text.
- If the text of the label is an empty string or the label refers to the message catalog with a message set of 0 and a message number of 0, then "your label" appears as an empty string and the label will be rendered as "|<< >>|".

## Related Links

[Setting Grid Use Properties](#)

## Setting Scroll Bar Label Properties

---

**Note:** Scroll bars are not supported in fluid applications.

---

To help identify scroll bars on the page definition, document the purpose of each scroll bar with an informational field label.

To specify a scroll bar label:

1. Access the Scroll Bar Properties dialog box.
2. Select the Label tab.
3. Enter the text label in the Text field.

This label is for your information only—it doesn't appear on the page. This label is useful for reordering page controls in the order list if you include a meaningful identifier in the label, such as the primary record definition for the scroll bar. For example, you might want to label it *ABSENCE\_HIST\_SCROLL*.

## Setting Scroll Bar Use Properties

---

**Note:** Scroll bars are not supported in fluid applications.

---

You set the scroll action buttons on the Use tab of the Scroll Bar Properties dialog box:

## Image: Specifying scroll bar Use

This example illustrates the fields and controls on the Specifying scroll bar Use. You can find definitions for the fields and controls later on this page.

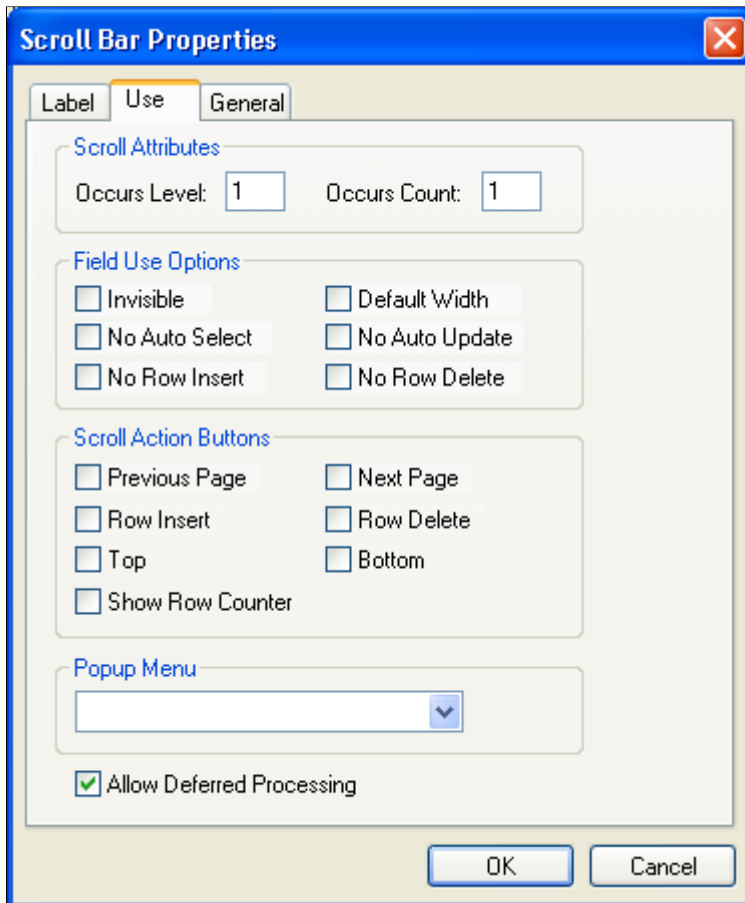

Access the Scroll Bar Properties dialog box. Select the Use tab.

## Scroll Attributes

### Occurs Level

Having an occurs level for the scroll bar enables you to designate the hierarchical parent and child relationship. Entering *1* specifies that the scroll bar is at the first level. Entering *2* specifies that a scroll is at the second level and is a child of, or nested in, the first level of data, and so on up to *3*. A scroll can be nested in another scroll or scroll area, but it cannot be nested in a grid.

See [Level-Based Controls](#).

### Occurs Count

Enter the number of rows to appear at one time in the grid at runtime.

See [Level-Based Controls](#).

---

**Note:** Always reorder your controls, if necessary, before you enter an occurs count.

---

## Field Use Options

<b>Invisible</b>	Select to make the scroll bar invisible.
<b>Default Width</b>	This does not apply because the scroll bar does not appear on the page at runtime.
<b>No Auto Select</b>	Select to prevent the system from retrieving data automatically from the database. Select to populate the scroll bar with data using the ScrollSelect PeopleCode functions.
<b>No Auto Update</b>	Select to prevent the system from updating data automatically based on the existing key list. Select when the scroll bar contains work field controls that should affect only a page and not the underlying database.
<b>No Row Insert</b>	Select to prevent the row insert function so that the user cannot insert new rows.
<b>No Row Delete</b>	Select to prevent the delete function so that the user cannot delete rows.

## Scroll Action Buttons

If you select a Scroll Action Button option, it appears on the page next to the scroll bar in PeopleSoft Application Designer. You must manually move it to the appropriate location on the page definition.

<b>Previous Page</b>	Select to display a link that enables the user to move to the previous row or set of rows in the scroll buffer.
<b>Row Insert</b>	Select to display a button that enables the user to add a row.
<b>Top</b>	Select to display a link that enables the user to go to the first row of the scroll.
<b>Show Row Counter</b>	Select to display a counter to show users what rows they are viewing and the total number of rows in the scroll bar, for example: <1 of 3>.
<b>Next Page</b>	Select to display a link that enables the user to move to the next row or set of rows in the scroll buffer.
<b>Row Delete</b>	Select to display a button that enables the user to delete a row.
<b>Bottom</b>	Select to display a link that enables the user to go to the last row of the scroll bar.

## Controlling Scrollable Data

You can control scrollable data using the PeopleCode Data Buffer Access Classes.

See "Understanding Data Buffer Access" (PeopleTools 8.58: PeopleCode Developer's Guide).

## Converting Scroll Bars to Grids

You can convert a single-level scroll bar to a grid control. PeopleSoft Application Designer provides a utility to automate this task. The Convert Scroll to Grid function:

- Designates the size and position of the grid as set to the area covered by the left-most label to the scroll bar.
- Issues warnings before deleting controls that are not supported by the grid.
- Converts radio buttons to drop-down list boxes.
- Sets label alignment of check boxes to center.

The conversion utility provides warnings for scroll bars that can't be converted to grids due to grid control limitations. The conversion utility validates to the following limitations:

- No more than one grid can exist on a page.
- The scroll bar to be converted must not have any nested scroll areas or bars under it.
- The grid control must be the last control on the page.
- Radio buttons are not supported in grids and must be replaced with drop-down list boxes.

To convert a scroll to a grid:

1. Select the scroll bar.
2. Right-click and select Convert Scroll To Grid from the pop-up menu.

This menu option is available only for scroll bars that can be converted. This utility searches for all page fields that are defined in the field order after the selected scroll bar control, up until the next scroll bar or scroll area control. It does the following for each field:

- Confirms that the scroll control type can be displayed in a grid control.
  - Creates a grid column of the appropriate type.
  - Populates the attributes.
3. Click OK to display the new grid.

If any of the page fields cannot be displayed in a grid or if other problems are found, the utility displays an error message explaining why the scroll bar cannot be converted to a grid.

---

## Using Grids

This section provides overviews of grids and discusses their properties and options.

---

**Note:** A specific type of grid called an analytic grid can be used exclusively for applications built for the PeopleSoft Analytic Calculation Engine.

---

## Related Links

"Understanding Analytic Grid Design" (PeopleTools 8.58: Analytic Calculation Engine)

## Understanding Grids

Scroll controls and grid controls function very similarly. Grids are more compact and display fields in a spreadsheet-like format. You insert page controls into a grid and associate the controls to record definitions, just as you do in a scroll control.

You can insert these page controls into a grid:

- Check boxes.
- Drop-down list boxes.
- Edit boxes.
- HTML areas.
- Images.
- Long edit boxes.
- Push buttons or links.
- Radio buttons.

---

**Note:** You must add a group of at least two radio buttons within a grid. Moreover, unlike check boxes, a solitary radio button cannot be added to a grid to be used as a row selector.

---

- Secondary pages.
- Subpages.
- Tab separators.

---

**Note:** When designing grids, use prompts in place of drop-down list boxes for better performance.

---

## Understanding Grid Properties

When you accept the default settings of grids, the grid appears with :

- A data navigation bar at the top of the table that enables the user to page through additional rows of data.
- Delete and Add buttons at the end of each row that enable the user to insert and delete rows in the grid.

The inserted row appears under the current row. These buttons appear automatically as determined by the grid properties (display-only, no row insert, and no row delete).

- An occurs count of *1*.

You can set the grid to be any size at design time and then set the occurs count to control the maximum number of rows to display at runtime.

There are three areas on a grid to which you can apply labels or image buttons to help the user navigate through the data in the grid. Set properties for these areas:

- Header
- Body
- Footer

## Understanding Grid Personalization

PeopleSoft Application Designer enables the user to personalize a grid at runtime. By default, grid personalization is enabled. To change the default settings for grid personalization, open the Grid Properties dialog box and click the Display Navigation Bar Properties button. Grid personalization settings appear on the Personalize tab in the Header Navigation Bar Properties dialog box.

**Note:** If you do not display the grid header bar, the Personalize link is not available to the user unless you enable it for the footer area.

### Image: Personalize Column and Sort Order page

This example illustrates the fields and controls on the Personalize Column and Sort Order page. You can find definitions for the fields and controls later on this page.

**Personalize Column and Sort Order**

To order columns or add fields to sort order, highlight column name, then press the appropriate button.  
Frozen columns display under every tab.

**Column Order**

- Permission List
- Description
- View Definition

Hidden  
 Frozen

**Sort Order**

- Permission List

Descending

OK Cancel Preview [Copy Settings](#)

Permission List	Description	View Definition
HCCPAM1	Absence Mngmnt Administrator	View Definition
HCCPAMSS01	Absence Self-Service	View Definition
HCCPSCAW1030	AWE Employee	View Definition
HCSPWEBLIB	Standard WebLib Permissions	View Definition

When the user clicks the Personalize link for a grid on a transaction page, the system opens the Personalize Column and Sort Order page, where custom parameters can be set for that grid. This page contains a sample grid that displays a few rows of real data from the buffer in display-only format. If there is no data in the buffer for that grid, only the column headings appear. Tabs in the grid are active so that the user can view all sample data.



From this personalization page, users can control the column and sort order, as well as copy other users' grid settings or choose to share their settings with other users once they save their changes.

The Column Order grid displays the columns in their current order, including tab separators. The list of fields is driven by the page definition but excludes columns that are hidden by PeopleCode. The user can hide columns and change their sort order. Users can also freeze grid columns. Columns that you freeze at design time automatically appear to the user as already frozen. However, the user has the option of overriding this setting.

The Sort Order grid enables the user to control the ascending and descending sort of each column, with the exception of tab separators, images, push buttons, links, and HTML areas. Users can sort hidden fields, however. The default setting is ascending for each column.

After making changes, the user can accept, preview, restore defaults, or cancel selections. If the user saves the new settings by selecting OK, the system stores the new settings as persistent values for that user based on a key structure. Therefore, each time the user accesses this grid, the system uses all personalization options that were set previously. The user can restore all default settings by selecting the Delete Settings link to remove all stored personalization settings from the database.

The user can override the persistent sort order directly on the transaction page by clicking the linked field label to affect the sort. Clicking the link repeatedly toggles between ascending and descending sort order for that column. This type of sorting directly in the transaction page is *not* persistent.

---

**Note:** You can continue to use the Sort method of the Rowset class, but the user can override the defined sort with this feature.

---

**Important!** Modifying a grid or a page definition that contains a grid removes all runtime user personalizations associated with the modified page and the grid. Therefore, if users personalize grid column and sorting options for a grid, make sure they are aware that after system administrators apply updates and upgrades, it is likely that users will need to reapply their personalization options.

---

## Inserting and Resizing Grid Controls

To insert a grid on a page:

1. Select Insert > Grid.
2. To adjust the grid width, drag the horizontal or vertical control handles.

The horizontal grid width should be roughly equivalent to the columns that you insert into the grid. Otherwise, your grid might appear wider than necessary at runtime.

## Inserting and Manipulating Grid Columns

This section discusses how to:

- Insert grid columns.
- Delete grid columns.
- Move grid columns on the Layout tab.
- Move grid columns on the Order tab.

- Resize grid columns.

## Inserting Grid Columns

To insert a grid column:

1. Use one of these methods to insert a column:
  - Select a page control from the Insert menu or the page control toolbar and click the grid.
  - Drag a page field from inside the current page or from another page.
  - Copy and paste a page field or record field.
  - Drag a definition (such as a record field, a page field, or an entire record definition) from the project workspace.

The new location of the definition or control is determined by the location of the upper left-hand corner of the drag rectangle, or by the mouse cursor if no drag rectangle appears. PeopleSoft Application Designer automatically places the first column on the left-hand side of the grid.

2. Click your mouse or release the field in the gray area of the grid.

Place new columns to the right of existing columns by clicking or releasing the control in the gray area of the grid where no columns are present. To place a column between two grid columns, release the new column in the first of the two columns.

When inserting subpages into your grid as a column, be aware that:

- You can insert subpages by dragging them from the project workspace or by cutting and pasting from the page to the grid.
- Only one column displays in the grid in PeopleSoft Application Designer representing all fields in the subpage.

At runtime, all fields display in the order they appear on the Order tab of the subpage.

- You cannot insert subpages that contain fields that are not allowed in grids such as static text or radio buttons.

The system generates an error indicating the invalid field type. Similarly, if at a later point an invalid field type is added to a subpage already in a grid, the system generates a runtime error when the user accesses the page containing the subpage.

- The subpage you insert can contain fields that are associated with subrecord record fields.

The same record name substitution mechanism that applies to subpages inserted onto a page applies to those inserted as grid columns. The system replaces the name of the subrecord as part of the expansion process and it is never seen at runtime.

See [Understanding Subpages](#).

---

**Note:** The rich text editor is not supported within grids. If you insert a long edit box and make it rich text-enabled, the system automatically sets the long edit box Use properties to Display Only. (Use tab > Field Use Options > Display Only.)

---

---

**Note:** Long edit boxes inserted into grids and set to display only always display the field content in expanded mode, regardless of how the Expand Field When Display Only option is set. (Use tab > Field Use Options > Expand Field When Display Only.)

---

## Deleting Grid Columns

To delete a grid column:

1. Select a column by right-clicking the column heading.

Be sure that you select only the column and not the grid as a whole; otherwise, you might delete the entire grid instead of just the column. The grid is selected when control boxes appear around the edges of the grid. The column is selected when it turns black.

2. Select Delete from the pop-up menu.

## Moving Grid Columns on the Layout Tab

To move grid columns on the Layout tab:

1. Select a column by clicking the column heading.
2. Drag the column to its new location.
3. Release the mouse button over the column that is to the left of the new location.

## Moving Grid Columns on the Order Tab

To move grid columns on the Order tab:

1. Select the column row by clicking the row number.

The grid and grid columns are clearly distinguished from other page fields on your page. The grid is identified by the Type column. All columns in the grid are directly below in a lighter green. Other page field rows are white.

2. Drag the row to the new position in the grid.

A red line indicates the new position of the column before you release it. You cannot move a column outside of the grid when working on the Order tab. Similarly, you cannot move an existing page field from elsewhere on the page into the grid. Both of these operations can be performed on the Layout tab.

## Resizing Grid Columns

You can resize grid columns in PeopleSoft Application Designer by dragging the right border of the column heading.

## Setting Column Properties

After you insert the page control or field into your grid, you can set the properties for that field as you would set properties for any other page control. Access the field properties by double-clicking the column heading.

Column headings and their alignment are derived from the label text that you select on the Label tab of the page field properties dialog box. The alignment of column contents is derived from the alignment settings on the Record tab of the page field properties dialog box. If alignment settings aren't available on the Record tab, then the system uses the Label alignment settings. For column headings, use the following guidelines for label alignment. Do not use colons in column labels.

<b>Field Type</b>	<b>Label Alignment</b>
Push button	Center Align
Link	Left Align
Character	Left Align
Numeric	Right Align
Check box	Center Align
Field data	Auto (automatic)

### Default Image Field Dimensions in Scrollable Grids

When working with scrollable layout grids that include image fields, consider these default behaviors:

- The default row height for 28pix.
- The header label width determines the default column width.
- Grid cell dimensions do not resize automatically to accommodate a stored image with dimensions that exceed the default dimension.

If you have images with dimensions that exceed the default dimensions of (28 x (*column width*)) then users are unable to see the entire image because the grid cell is smaller than the image. To prevent images from being cropped by the page control:

1. Determine and record the dimensions of the largest image in the field.
2. Access the Image properties dialog box of the image page field.
3. On the Record tab, enter the recorded values from step one in the Width and Height fields.
4. Click the OK button and save the page definition.

### Image: Image Properties dialog box with non-default size values

This example illustrates the fields and controls on the Image Properties dialog box with non-default size values. You can find definitions for the fields and controls later on this page.

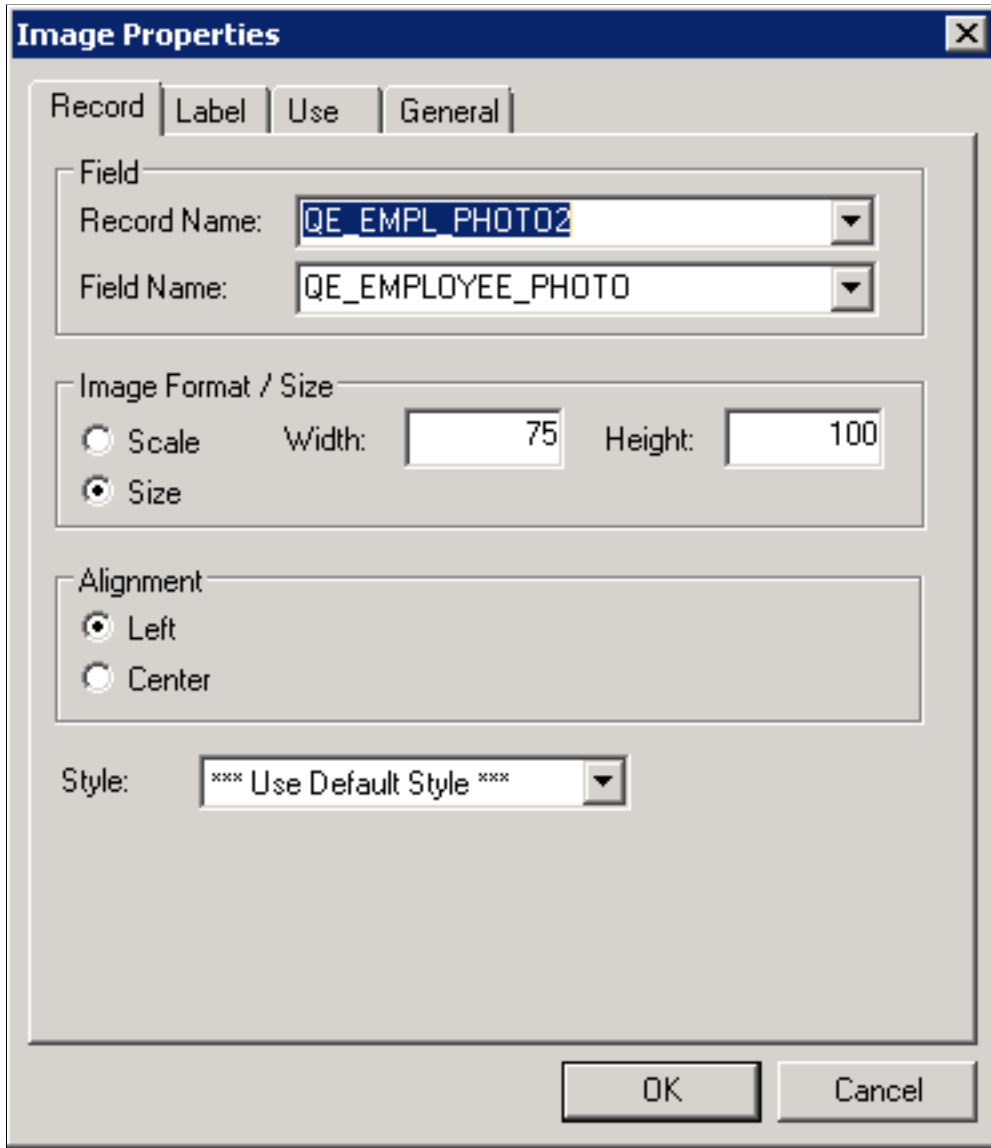

## Creating Tabbed Grids

Oracle recommends using a tabbed grid design if your grid contains many columns that extend past the right side of the page. Do this by adding tab separator controls to your grid.

**Image: Tabbed grid example**

This example illustrates a tabbed grid on the Define Personalizations page. The grid includes three tabs labeled Definition, Format, and Explanation.

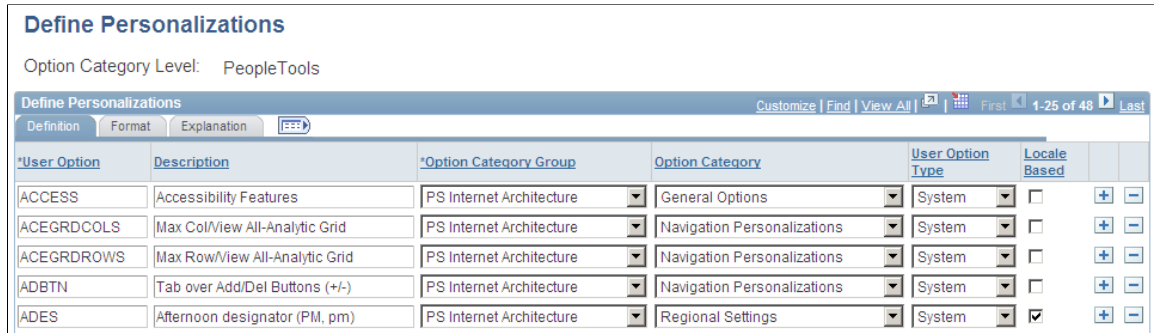

You can give users the option of expanding all of the columns to the right so that they are visible when using the browser’s horizontal scroll bar. This is particularly useful to power users who do a great deal of intensive data entry. The Enable View All Columns check box on the Use tab in the Grid Properties dialog box controls this feature and is selected by default. The Expand All button appears to the right of the grid tabs, as shown in the preceding screen shot. After the grid is expanded, the Show Tabs button appears to enable the user to collapse the grid so that the tabs appear again.

**Note:** Each time the user selects a new tab results in a trip to the web server to retrieve the next set of columns.

**Image: Order tab from the PSUSEROPTNDEFN page definition**

This example illustrates the page definition that corresponds to the preceding example. Within the grid control, note the three tab separators: Definition (tab order 6), Format (tab order 14), and Explanation (tab order 24).

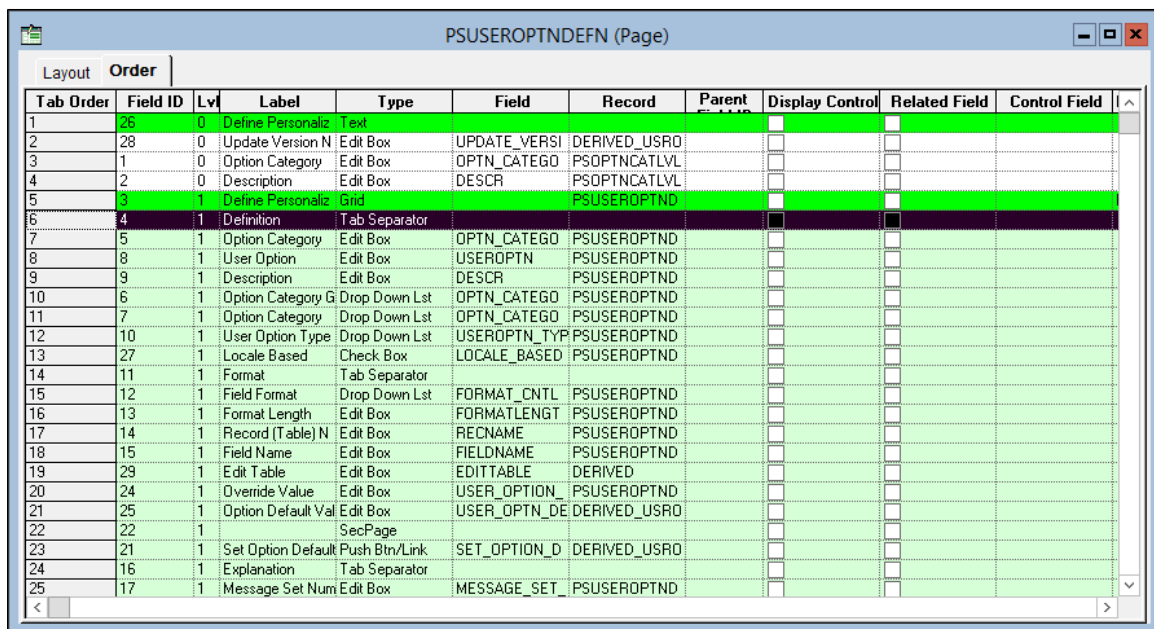

To create a tabbed grid:

1. Insert a grid control on the page.

2. (Optional) If you want to freeze one or more columns so that they are displayed on all grid tabs, insert those columns first. Select the Freeze Grid Column check box on the Use tab for each frozen column. See [Freezing Grid Columns](#) for more information.
3. Insert a tab separator control for the first grid tab.
4. Double-click the tab separator to access the Tab Separator Properties dialog box:

- a. Specify the label properties on the Label tab.

Select *None*, *Text*, or *Message Catalog*. If you select *Text*, enter the label text and select the label alignment. The label text that you select appears on the tab in the grid.

- b. On the General tab, determine whether you want to enable the tab separator as a page anchor.

If so, select the Enable as Page Anchor check box and enter a page field name.

- c. On the General tab, determine whether you want to specify row headers for screen readers. See “Columns and Row Headers” in [Setting Grid General Properties](#) for more information.

---

**Note:** To set row headers, you will need to complete step 5 to insert all of the columns for the tab.

---

5. Insert the set of columns to appear on the first tab.
6. For each tab, repeat steps 3–5 as necessary.

Alternatively, you can place all of the columns in your grid first and then insert tab separators before each set of columns.

---

**Note:** The grid tab must contain at least one visible, non-frozen column or the tab is not displayed.

---

## Freezing Grid Columns

---

**Note:** To avoid unexpected results, do not freeze columns in fluid flex grids with stacked columns.

---

You can freeze the first column or the first several columns in a tabbed grid so that these columns appear on all tabs. To freeze a column, it should appear in the grid before the first tab separator. Then, select the freeze option for each column that you want to appear on the following tab.

---

**Important!** When you freeze a grid column, the columns preceding it also become frozen regardless of whether they have been explicitly frozen.

---

Freezing grid columns impacts the horizontal scrolling ability of the grid at design time. If you freeze a grid column that is not visible inside the boundaries of the grid at design time, you are not able to view all columns in your grid. Lengthen the width of your grid to accommodate all columns.

Freeze a grid column by selecting the Freeze Grid Column check box on the Use tab of the properties dialog box for that column. Note that the effects of selecting this attribute are visible only at runtime, not design time.

## Using Multiple Grids on a Page

You can place as many grids on a page as you want, provided that they are at the same occurs level. They can be one above the other or they can be side-by-side, such as those in the following example. This is helpful when you must transfer data from one grid to another without switching between pages.

In the following example, the user can transfer data from the Source Competencies grid on the right to the Assigned Competencies grid on the left by using the double left arrow button. The push button is associated with a PeopleCode program, enabling it to transfer the data between the two grids.

### Image: Grids side-by-side on a page

This example illustrates the fields and controls on the Grids side-by-side on a page. You can find definitions for the fields and controls later on this page.

The screenshot shows a web application interface with a navigation bar at the top containing tabs for 'Competency Evaluation', 'Competency Assignment', 'Competency Rating', and 'Competency Verification'. Below the navigation bar, the user's name 'Smith, John' and employee ID 'FG7025' are displayed. The main content area is divided into two side-by-side grids. The left grid, titled 'Competency Assignment', shows a table of assigned competencies with columns for 'Description' and 'Category'. The right grid, titled 'Source Competencies', shows a table of source competencies with a 'Description' column and checkboxes for selection. A double left arrow button is positioned between the two grids, indicating a transfer function. The interface also includes various control buttons such as 'Populate from Job', 'Search by', 'Save', 'Return to Search', 'Next in List', 'Previous in List', 'Update/Display', 'Include History', and 'Correct History'.

Assigned Competencies	
Description	Category
Ability to listen & respond	Ability
Set & achieve goals	Ability
Debates issues unabrasively	Ability
Conceptual thinking	Ability
Abstract thinking	Ability

Source Competencies	
Description	
<input type="checkbox"/> Service Orientation	
<input type="checkbox"/> Relationship Building	
<input type="checkbox"/> Develop & implement solutions	

As you can with other level-based controls, you can nest a grid in a scroll area or scroll bar. However, you cannot nest a grid in another grid.

## Enabling and Disabling Grid Personalization

Grid personalizations are enabled by default. To disable grid personalization:

1. Open the Grid Properties dialog box.
2. Select the Label tab.
3. Click the Personalize button for the header navigation bar.

This opens the Header Navigation Bar Properties dialog box.

4. Select the Personalize tab.
5. Select the Invisible check box.
6. Click the OK button.



To enable grid personalization in the navigation footer:

1. Open the Grid Properties dialog box.
2. Select the Label tab.
3. Select the Display Navigation Bar check box in the Footer Area group box.
4. Click the Properties button for the footer navigation bar.

This opens the Footer Navigation Bar Properties dialog box.

5. Select the Personalize tab.
6. Clear the Invisible check box.
7. Click the OK button.

## Setting Grid General Properties

Access the Grid Properties dialog box. Select the General tab.

### Image: Grid Properties dialog box: General tab

This example illustrates the fields and controls on the Grid Properties dialog box: General tab. You can find definitions for the fields and controls later on this page.

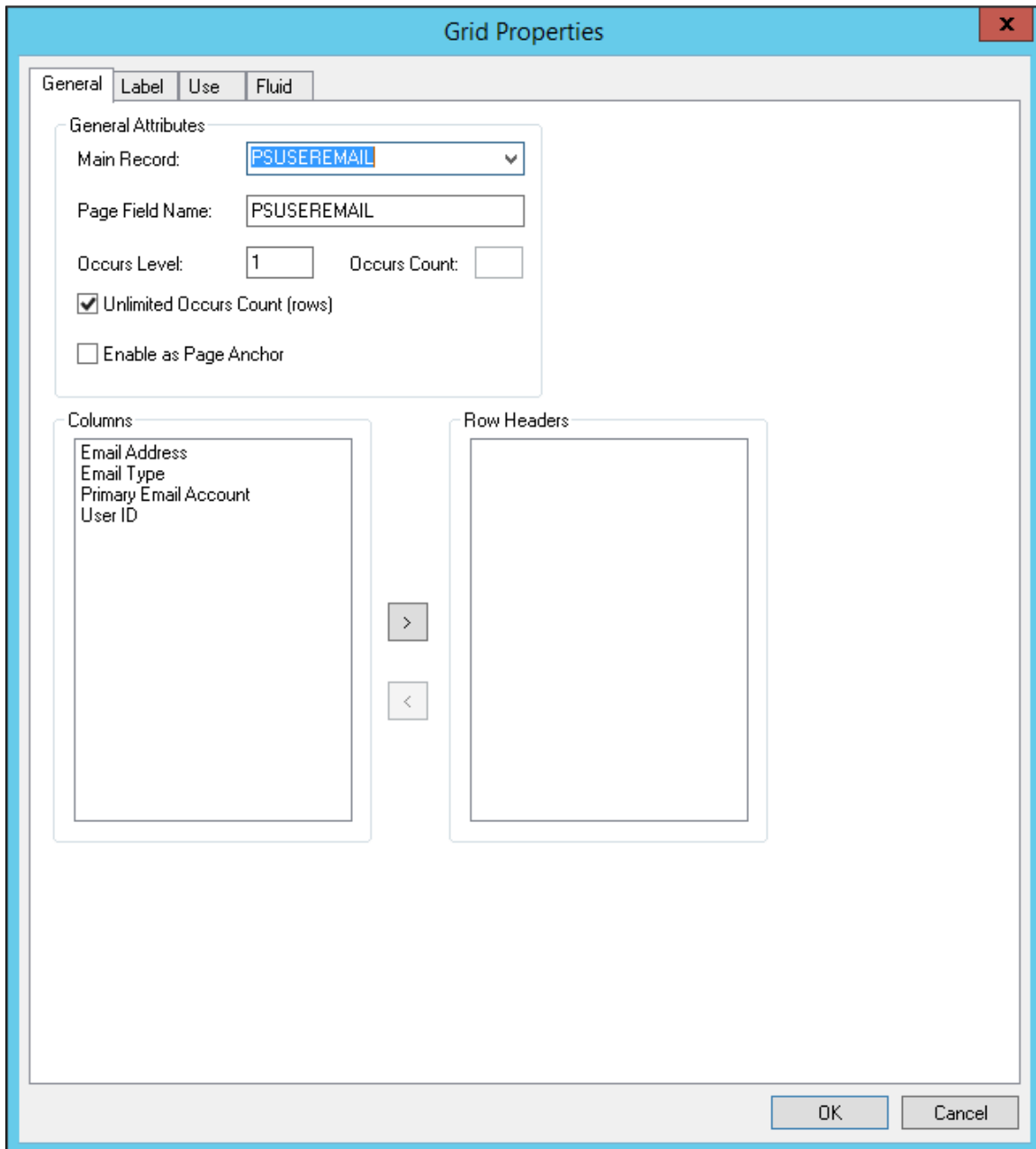

## General Attributes

### Main Record

Select the record that contains most of the fields that you want to use in the grid. Fields that you display in the grid that are not from the main record should be display-only or related fields, which you can set on the Use tab of the properties dialog box for that column.

### Page Field Name

Enter a name for the grid. The default is the main record for the grid, however, you can rename the grid as long as it is a

*unique* name for the page or component. This name is used by the PeopleCode GetGrid function to create a grid definition.

See "Understanding File Layout" (PeopleTools 8.58: PeopleCode API Reference), "GetGrid" (PeopleTools 8.58: PeopleCode Language Reference).

### **Occurs Level**

Enter a 1, 2, or 3 to represent at which level the grid resides on the page. Having an occurs level for the grid enables you to designate the hierarchical parent-child relationship. Entering 1 specifies that the grid is at the first level. Entering 2 specifies that a grid is at the second level and is a child of, or nested in, the first level of data, and so on up to 3. A grid can be nested in another level-based control, but it cannot be nested in another grid.

See [Level-Based Controls](#).

### **Occurs Count**

Enter the number of rows to display initially at runtime.

---

**Note:** When an occurs count is set to a number other than 1, the grid displays the specified number of rows. However, when it is set to 1, the grid displays as many rows as possible within the physical space allocated for the grid control at design time.

---

See [Multiple Occurrences of Data](#).

### **Unlimited Occurs Count**

Select instead of setting an occurs count if you want the system to display all rows of data in the buffer for this grid. Navigation links do not appear at runtime and the size of the grid depends on the number of rows in the buffer.

### **Enable as Page Anchor**

Select to apply an anchor tag to serve as a jump destination on the page.

## **Columns and Row Headers**

The Row Headers list box enables you to specify which column in the grid should be used for the row header when presenting a data table for screen readers. The default row header generated is the first display-only edit field. Therefore, by default, all of the columns in the grid appear in the Columns list box; the value in the Row Headers list box is blank (no column selected).

When selecting row header values for tabbed or non-tabbed grids, consider these points:

- For optimal results, it is recommended to use display-only or disabled fields as the row headers.
- PeopleTools does not perform any validation regarding whether a column can be made a row header, such as in the case of a radio button field. Implementation teams need to select appropriate values.
- With tabbed grids, when all tabs are expanded the system uses the row header from the first tab.

- If a row header is specified, PeopleTools generates the field label of the table cells as *column header* + *row header*. If no row header is specified, PeopleTools generates the field label as the *column header*.

Separate considerations apply to non-tabbed grids versus tabbed grids:

- *For non-tabbed grids:* The Row Header list box appears on the Grid Properties dialog box: General tab. You can select up to two columns as the row header. If you select a custom value, at run time, PeopleTools generates the row header using the column value (or values) you selected.
- *For tabbed grids:* The Row Header list box on the Tab Separator Properties dialog box: General tab. Just as with non-tabbed grids, the default row header generated is the first display-only edit field. You can select up to two columns as the row header for each tab separator with the column names to be selected from the group of columns under control of that tab separator. If you select a custom value, at run time, PeopleTools generates the row header using the column value (or values) you selected.

If you have any frozen grid columns set as a row header in a tabbed grid, the system applies that value to all tabs in the same grid, which will override previous values selected. Likewise, if a frozen grid column is deselected as a row header, the system applies those changes to all tabs in the same grid, requiring you to select a new row header value as needed.

For more information on tabbed grids, see [Creating Tabbed Grids](#).

## Related Links

"SetRowHeader" (PeopleTools 8.58: PeopleCode API Reference)

## Setting Grid Label Properties

Access the Grid Properties dialog box. Select the Label tab.

### Image: Grid Properties dialog box: Label tab

This example illustrates the fields and controls on the Grid Properties dialog box: Label tab. You can find definitions for the fields and controls later on this page.

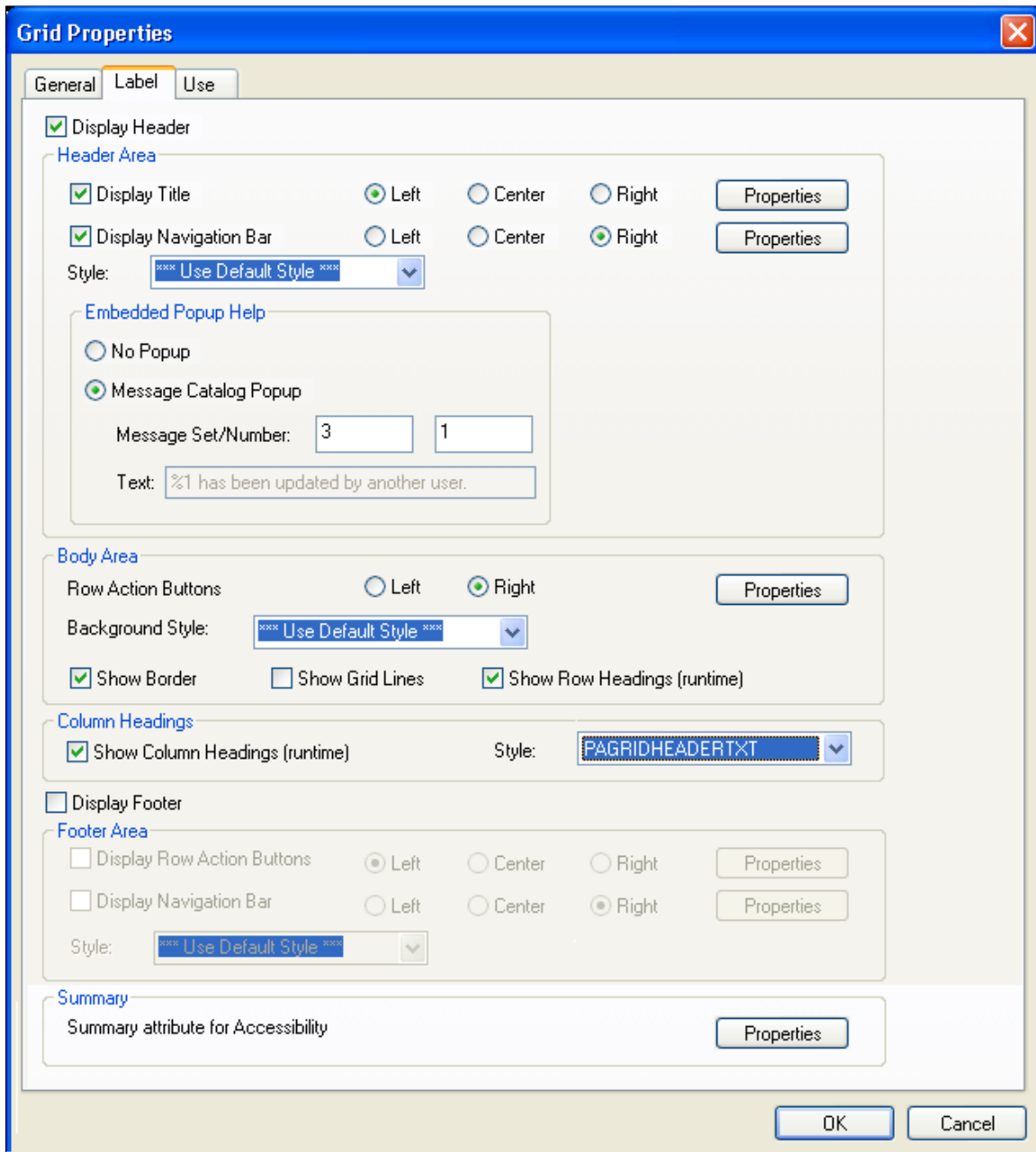

The Grid Properties, Label tab provides five main grid setting areas for you to configure:

- Header Area.
- Body Area.
- Column Headings.
- Footer Area.

- Summary.

Certain grid label properties such as label text and summary text can also be set through PeopleCode.

See "Grid Class Properties" (PeopleTools 8.58: PeopleCode API Reference).

## Header Area Properties

Use the header area properties to configure the title properties, the navigation bar properties, and embedded help properties associated with the grid. These properties enable users to access controls for viewing the previous, next, top, or bottom row; to control the settings for the Find, Personalize, Download, and View All features; and to access embedded help.

The Display Header check box is selected by default and enables access to Header Area properties. To disable the header, clear the Display Header check box.

To configure title properties for the grid:

1. Select the Display Title check box.
2. Select Left, Center, or Right title alignment option.
3. Click the Display Title Properties button to open the Title Properties dialog box.
4. Enter the label text that you want to appear in the grid title.

<b>Type</b>	Select the type of label text to appear in the navigation bar.  <i>Message Catalog</i> : Select this option to use a message in the Message Catalog as the grid title.  <i>Static</i> : Select this option to enter manual text as the grid title.
<b>Text</b>	Enter the text to appear as the title of the grid. This field is enabled when you select <i>Static</i> as the Label Text Type.
<b>Message Set/Number</b>	Enter the message set number and message number of the message in the Message Catalog to appear as the title of the grid. This field is enabled when you select <i>Message Catalog</i> as the Label Text Type.

To configure navigation bar properties for the grid:

1. Select the Display Navigation Bar check box.
2. Select Left, Center, or Right navigation bar alignment option.
3. Click the Display Navigation Bar Properties button to open the Header Navigation Bar Properties dialog box.

The Header Navigation Bar Properties dialog box contains seven tabs, each pertaining to different settings on the navigation bar. Each of these tabs has the same settings. All settings are set to display by default. Select the Invisible check box that appears in the upper right corner of each tab to hide the tab attribute from the user.

**Image: Header Navigation Bar Properties dialog box**

This example illustrates the fields and controls on the Header Navigation Bar Properties dialog box. You can find definitions for the fields and controls later on this page.

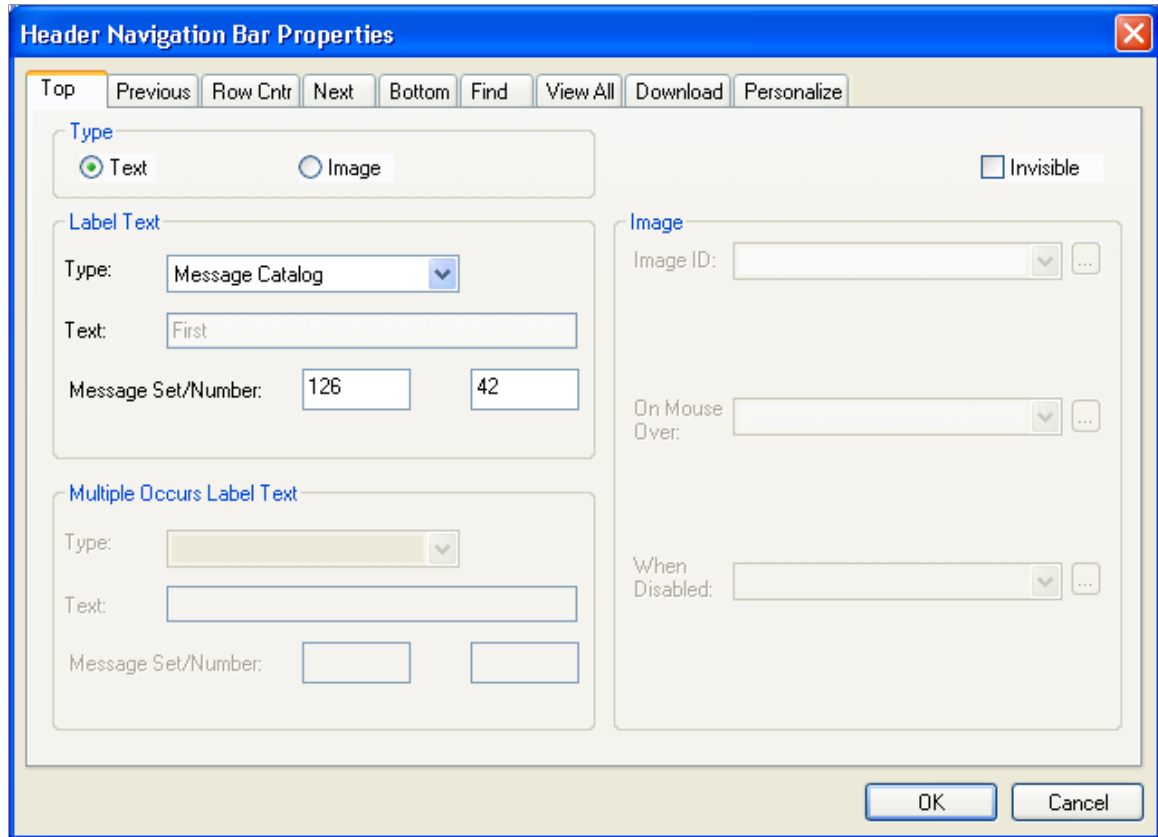

This table describes the tabs on the Header Navigation Bar Properties dialog box:

<b>Top</b>	Controls the attributes for how a user returns focus to the top of the grid or the first row of data in the grid. <i>Text</i> is the default setting, using <i>First</i> from the message catalog. You can also enter static text.
<b>Previous</b>	Controls how a user can move to a previous row in the grid. <i>Image</i> is the default setting, with the Show Previous Row button as the default image.
<b>Row Cntr</b> (row counter)	Tracks the number of rows in the grid and in which row the cursor holds focus. <i>Text</i> is the default setting with, for example, <i>1-6 of 6</i> appearing in the navigation bar if there are six rows in the grid.  The Image Type is not enabled on this tab.

---

**Note:** The row count that appears is controlled by the occurs count that you set on the General tab in the Grid Properties dialog box (unless the user displays all). Using the previous example, if the occurs count is set to 5, then the row counter is *1-5 of 6*.

---

**Next**

Brings focus to the next row in the grid. *Image* is the default setting with the Show Next Row button appearing to the right of the row counter.

**Bottom**

Controls the attributes for how a user moves focus to the last row of the grid. *Text* is the default setting, using *Last* from the message catalog. You can also enter static text.

**Find**

Displays a link that enables the user to search any field in the grid or scroll area. You can select either text or an image to represent the find feature. The Find feature searches for matches in edit boxes, display-only fields, disabled fields, dynamic links, and text in long edit boxes. It does not find column headings, field labels, text values in icons, static links, and hidden fields, nor does it search outside the grid.

---

**Note:** The system ignores fields in HTML areas when running a Find request.

---

**View All**

Enables the user to view all rows of data at once. *Text* is the default setting using *View All* as the message catalog entry.

**Download**

Available for grids only. Displays a download image button in the header or footer bar that enables users to download all active, non-hidden rows to a Microsoft Excel spreadsheet, regardless of how many rows are visible on the screen. The default for this setting in the header area is *Invisible*. For the footer area of a grid, the download button appears by default when you select the Display Navigation Bar check box in the Footer Area group box of the Label tab in the Grid Properties dialog box.

---

**Note:** When you download a column of links comprised of numeric values, the values are downloaded as numbers instead of as quoted strings unless doing so causes Excel to modify the format of the numbers.

---



---

**Note:** Microsoft Excel may display Unicode comma-delimited data differently because Microsoft Excel may be expecting a tab-delimited file. If display abnormalities occur, you have two options.

In Microsoft Excel, after highlighting the first column, you can select Data, Text to Columns and select the options required to set Microsoft Excel to expect a comma-delimited file.

Or, in PeopleSoft Application Designer change the file layout from comma-delimited to tab-delimited. Keep in mind that changing the file layout properties in PeopleSoft Application Designer could cause the data to change such that other applications may no longer recognize the data.

Also, changing the file layout properties may impact more than one application, if that file layout is shared.

---

### **Personalize**

Available for grids only. Displays a Personalize link in the header bar that enables the user to access all grid personalization options.

See [Enabling and Disabling Grid Personalization](#).

To configure embedded help pop-up properties for the grid, select from these options:

#### **No Popup**

Select this option to disable embedded pop-up help.

This is the default.

#### **Message Catalog Popup**

Select this option to enable the embedded pop-up help icon on the grid at runtime. Selecting this option enables the Message Set/Number edit boxes.

#### **Message Set/Number**

Enter the message set number and message number of the message catalog entry to appear when the user clicks the embedded help icon.

#### **Text**

Displays the message that appears when the user clicks the embedded help icon. This field is display-only.

### **View All Feature**

The View All feature provides a threshold to enable the user to view the data in manageable pieces. If the database returns a number of rows for the grid or scroll area that is greater than the threshold, the View All link displays "View <threshold value>." This feature also modifies the occurs count and the values for the number of non-displayed rows left to scroll through.

The Next and Previous buttons retrieve rows according to the size of the threshold. If the database returns a total number of rows for the grid or scroll area that is less than the View All threshold, then the View All link on the navigation bar remains and functions as is.

The following example uses the View All threshold, occurs count, and total rows in database values:

- View All threshold = 100
- Occurs count = 10
- Total rows in database = 160

These values result in the following for the user:

### Image: Viewing 10 rows

This example illustrates the fields and controls on the Viewing 10 rows. You can find definitions for the fields and controls later on this page.

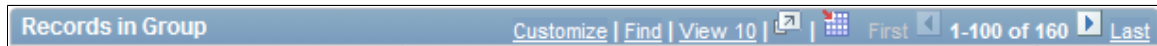

When the user selects View 100, the view value changes to reflect the original occurs count set for the grid. The value for the number of non-displayed rows changes to 100 to match the View All threshold, and the View 100 display changes to View 10:

### Image: Viewing 100 rows

This example illustrates the fields and controls on the Viewing 100 rows. You can find definitions for the fields and controls later on this page.

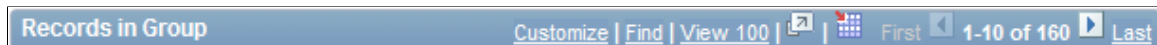

If the Occurs Count, which you define in the properties for grid and scroll areas, is set to a number greater than or equal to the view all threshold, the threshold takes precedence. The View All display changes to View <threshold value> and the link is unavailable. If you select Unlimited Occurs Count, the grid or scroll area displays all rows in the buffer.

## Body Area Properties

Use the body area properties to configure the row action buttons and set display properties for the body of the grid.

This table describes the Body Area properties:

### Row Action Buttons

Select to display Insert and Delete buttons on each grid row at runtime. The action buttons can appear on the left or right side of the grid. Click the Properties button to open the Body Area Row Action Button Properties dialog box.

### Background Style

Select a background style to display for the grid as a whole. The style selected here applies to all areas of the grid that are not covered by other elements.

### Show Border

Select to display a standard border around your grid. The default is selected.

### Show Grid Lines

Select to show grid lines on the grid. The default is to *not* display grid lines (this option is deselected).

This setting should remain deselected as grid lines are set through the style class.

---

**Note:** Show Grid Lines has no effect on fluid applications. Grid lines (if required) are applied through grid styles.

---

### Show Row Headings (runtime)

Select to number the rows at runtime. This option is selected by default.

---

**Note:** The row headings column appears at design time even if Show Row Headings (runtime) is not selected. This enables you to more easily select the grid if necessary.

---

Click the Row Action Buttons Properties button in the Body Area group box to open the Body Area Row Action Button Properties dialog box. It contains two tabs: Insert and Delete. The default settings for these tabs are to display the Insert and Delete buttons. Alternatively, you can select static or message catalog text, or you can make these items invisible so that they do not appear.

### Image: Body Area Row Action Button Properties dialog box

This example illustrates the fields and controls on the Body Area Row Action Button Properties dialog box. You can find definitions for the fields and controls later on this page.

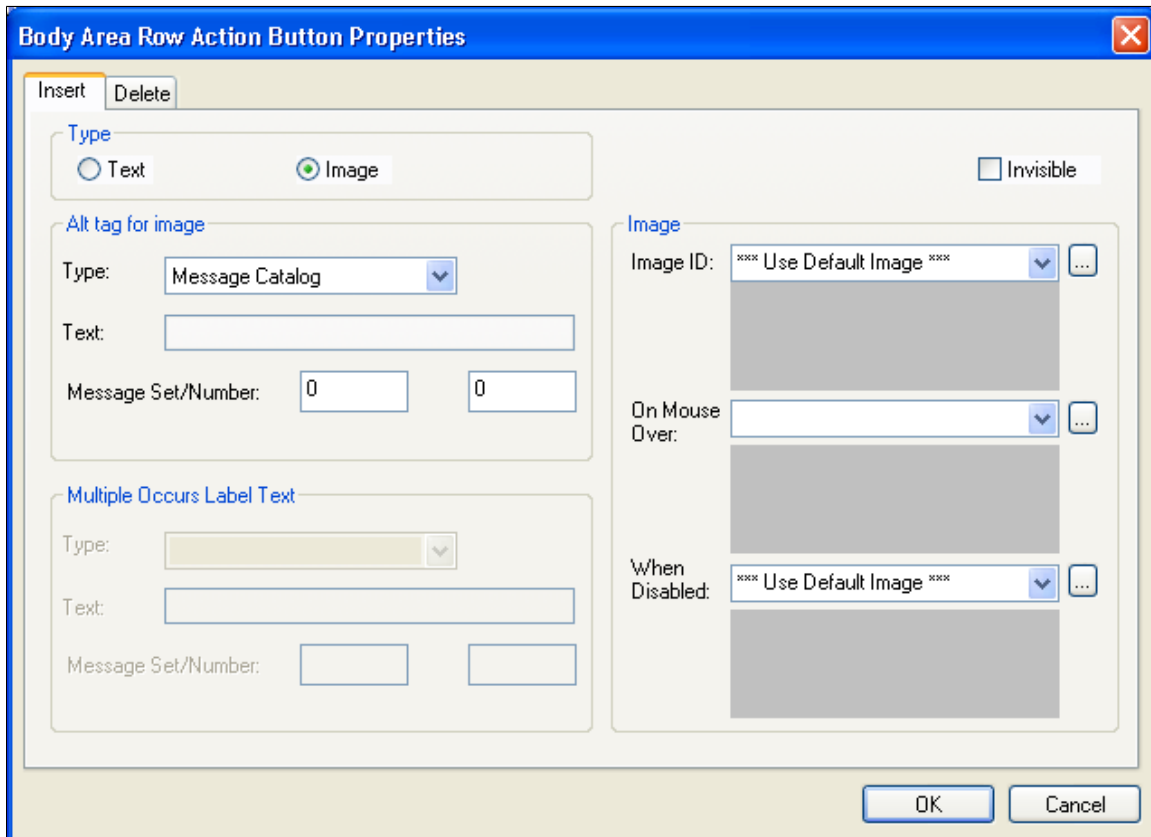

### Column Heading Properties

You can set the grid to display column headings, and you can select the style in which to display them. Select a predefined column heading style from the drop-down list box or use the default. Changing styles alters the foreground, background, and font in the column headings, making it different from the data rows. The default for Show Column Headings is selected.

## Footer Area Properties

In the footer of your grid, you can display row action buttons and a navigation bar. To enable either of these features, select the appropriate check box, Display Row Action Buttons or Display Navigation Bar, and click the Properties button to configure the settings. Clicking the Properties button opens a separate dialog box: Footer Row Action Button Properties or Footer Navigation Bar Properties, respectively.

The row action buttons are the same for the footer area as those described for the body area. The navigation bar property options are the same as those described for the header area. However, all other navigation bar settings for the footer are invisible by default.

## Summary Properties

Summary properties enable you to provide a brief description of the functionality and content of the grid. This property is pertinent for users who access the application by using screen readers. The default value for the Summary Text field is the same as the Title of the scroll area. You can also enter static text or use the Message Catalog to store the summary information.

Access the Summary Properties dialog box.

### Image: Summary Properties dialog box

This example illustrates the fields and controls on the Summary Properties dialog box. You can find definitions for the fields and controls later on this page.

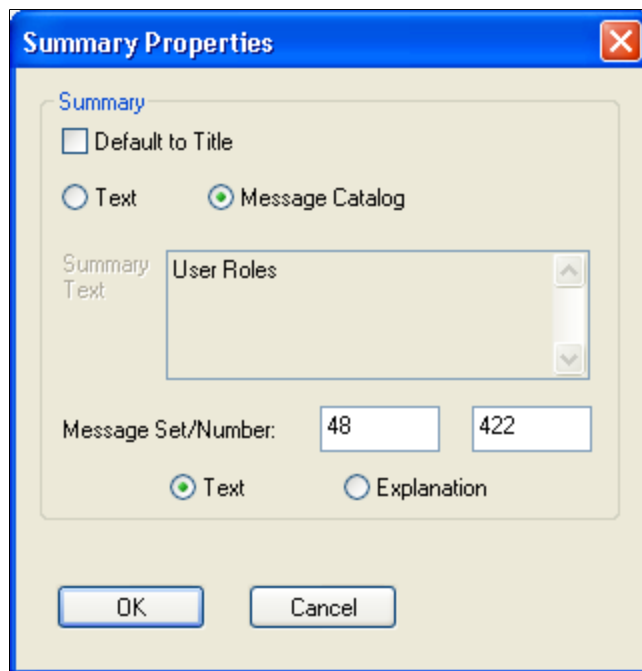

This table describes the summary properties of the grid:

### Default to Title

Select this check box to have the summary property the same as the grid title. Deselect this check box to activate the Text and Message Catalog options.

### Text

Select this option to enter up to 254 characters in the Summary Text field. Selecting this option disables all Message Catalog option related fields.

## Message Catalog

Select this option to choose a message stored in the Message Catalog. Selecting this option disables all Text option related fields. Select one of these two options:

- *Text*: Select this option to use only the message text from the Message Catalog.
- *Explanation*: Select this option to use only the message explanation from the Message Catalog.

To change the Summary properties:

1. Click the Properties button located in the Summary group box.
2. Clear the Default to Title check box to activate the other Summary options.
3. Enter static text or enter a Message Set and Number to retrieve information from the message catalog.
4. Click the OK button.
5. Save the page.

## Setting Grid Use Properties

On the Use tab in the Grid Properties dialog box, you control data entry, row style, and display options, as well as whether your grid has a pop-up menu in the navigation bar at runtime. Both the grid and scroll area share many of the same attributes. Refer to the preceding term tables for information about these shared settings.

**Image: Grid Properties dialog box: Use tab**

This example illustrates the fields and controls on the Grid Properties dialog box: Use tab. You can find definitions for the fields and controls later on this page.

**Data Options**

This table describes the data options properties:

**No Auto Select**

Suppresses the system from retrieving data from the database automatically. Select to populate the grid or scroll area with data using the ScrollSelect PeopleCode functions.

See "RowScrollSelectNew" (PeopleTools 8.58: PeopleCode Language Reference).

**No Auto Update**

Suppresses the system from automatically updating data based on the existing key list. Select when the grid or scroll contains work field controls that should affect only a page and not the underlying database.

**No Row Insert**

Suppresses the Add button in the body area so that the user cannot insert rows. If this option is selected, PeopleSoft Application Designer automatically selects and disables the Invisible check box on the Insert tab of the properties dialog box for the body area.

**No Row Delete**

Suppresses the Delete button in the body area so that the user cannot delete rows. If this option is selected, PeopleSoft Application Designer automatically selects and disables the Invisible check box on the Delete tab of the properties dialog box for the body area.

**Allow Deferred Processing**

Set by default, this option ensures that the grid or scroll area processes in deferred mode. This setting overrides any individual field-level settings in your level-based control.

**Allow Multi-Row Insert (Allow Multiple Row Insert)**

Enables the user to add multiple blank rows at once to a grid after a page is displayed. This feature is available only in Add and Update modes. When the user clicks the Add Multiple Blank Rows button, a JavaScript prompt appears so that the user can specify the number of rows to insert; the user can insert between 1 and 99 rows.

**Allow Column Sorting**

Enables the end user to perform temporary sorts in a grid at runtime by clicking the column headings. The default is selected to allow column sorting automatically.

**Persist in Menu**

Stores the most recent transaction search in browser memory or web server memory and makes the results accessible through the drop-down navigation menu structure. To specify which fields appear as columns in the search results grid, use the Persist Grid Column in Menu property.

---

**Note:** This property applies *only* to fields that appear in grids on pages that are used as custom, application-specific search pages.

---

See [Setting Record Field Use Properties](#).

---

**Note:** If multiple grids exist on a custom search page and you enable this property on more than one grid, the system stores the search for only the first grid as it appears in the page order on the Order tab.

---

You must enable recent search results caching at the system level in the web profile for this property to take effect.

See "Configuring Caching" (PeopleTools 8.58: Portal Technology).

## Multirow Insert Option

Each time that a user adds a row to a grid or scroll area requires a transmission to the application server. With the multirow insert option, this transmission occurs only once when the user wants to add multiple blank rows. Selecting this option can significantly enhance the user's experience when doing data entry and also meets the developer's goal of limiting page processing.

At design time in PeopleSoft Application Designer, this feature is disabled by default. If the No Row Insert check box is selected, then the Allow Multi-Row Insert check box is deselected and disabled. Where the multirow insert button appears, in the row or in the footer, depends on how you define the grid or scroll area properties on the Label tab.

You can set any occurs count for your grid. When the end user inserts  $n$  rows, the occurs count for the grid or scroll area is temporarily increased to  $n + 1$  (if necessary), showing one row of context plus the new rows. If you select an unlimited occurs count for the grid, this temporary adjustment is not necessary.

---

**Note:** This feature should not be enabled for grids and scroll areas with effective-dated rows.

---

When the user saves the page, normal save processing runs, including save-edits on all rows. New, unchanged rows are not saved. After save processing, new, unchanged (and unsaved) rows are deleted from the buffer. The only exception is when only one row exists and it is new and unchanged. This row remains in the buffer, even though it has not been saved, because a rowset must always contain one row.

For an end user, pressing the Alt+7 keys works the same with the multirow Add button as it does with the standard Add button.

## Row Selection Indicator

These options enable the user to select one or more rows in the grid and scroll area. At runtime, indicators appear to the left of row numbers for grids and in the upper left corner for scroll areas. A transmission to the server triggers the selection of the row or rows that the user designates. These selections can then be detected in PeopleCode via the selected property on the row class for each row of data.

### No Selection Indicator

This value is the default selection. Prevents the user from selecting rows on the transaction page.

### Single Row (radio button)

Enables the user to select a single row in a grid or scroll area. Inserts a radio button to the left of each row that the user can select.

### Multiple Row (check box)

Enables the user to select multiple rows in a grid or scroll area. Inserts a check box to the left of each row that the user can select. Users can select as many rows as needed.

### Set Component Changed

Enables the user to receive a save warning if a change is made to a row selection indicator in the grid. At runtime, the transaction page uses this option to set the PPR\_CHANGED flag. This option is deselected by default.



This property ensures that if *any* changes occur to the grid, the data is saved to the database.

If you disable this property, any row insert, row delete, or field change on the rowset using PeopleCode would not cause the system to treat the component data as changed.

---

**Note:** For the row selection options, PeopleCode can change the selected property, which affects which boxes are selected when the page is regenerated.

---

## Popup Menu

Select a preset pop-up menu from the drop-down list box. The pop-up menu button appears in the left-hand corner of the navigation header at runtime.

See [Creating Pop-up Menus](#).

## Row Styles

You can control the color, font, and other characteristics of a row, active tab, inactive tab, and navigation bar by specifying a style in the drop-down list box for each of the row style options.

## Grid Style

These options enable the advanced grid properties available with scrollable grid layout only.

See "Viewing Data in Scrollable Layout Grids" (PeopleTools 8.58: Applications User's Guide).

### Grid Layout

See the table below for descriptions of each grid layout option.

### Rows to show in scrollable layout

Enter  $n$  (number) to set the height of the scrollable grid to  $n$  visible rows.

This value represents the number of rows to show when Scrollable Grid Layout is selected and the Vertical Scrollbar check box is selected. If this number is greater than the Occurs Count set on the General tab, then no vertical scroll bar appears, regardless of whether the Vertical Scrollbar check box is selected. If this number is lower than the Occurs Count and the Vertical Scrollbar check box is selected, then a vertical scroll bar appears and this number of rows will appear in the scroll area.

The scroll bar will scroll over the entire Occurs Count number of rows. To see more rows in this case, use the row navigation controls on the grids navigation bar.

If this field is set to  $1$ , then the vertical scroll bar will not appear except in View All mode, in which case the scroll bar will display the number of rows listed in the Occurs Count setting.

The default value is  $15$ .

### Horizontal

Select to activate a horizontal grid scroll bar at the bottom of the scrollable grid.

---

**Note:** This option affects scrollable grid layout only.

---

## Vertical

Select to activate a vertical grid scroll bar at the right side of the grid.

---

**Note:** This option affects scrollable grid layout only.

---



---

**Note:** Some of the grid layout types are supported only for classic pages; these all begin with the word *Classic*. Others are intended only for fluid pages; these do not begin with the word *Classic*. If you add a classic grid layout type to a fluid page, in some situations the system displays a JavaScript error. For example, if on a fluid page, you select *Classic Grid Layout* for a grid, then at runtime you will see a JavaScript error when working with the grid, such as when adding new rows. To resolve the error, select *Flex Grid Layout* for the grid layout type for the fluid page.

---

<b>Grid Layout</b>	<b>Description</b>
Classic Grid Layout	Original grids are the standard grid layout in releases prior to PeopleTools 8.50. With original grids, you can see navigation headers and footers; insert, multi-row insert, and delete buttons; and grid separator tabs. If the Personalize link is enabled by the developer, you can search for data within the grid, sort grid data; and rearrange, freeze, and hide columns to personalize your grids.
Classic Scrollable Grid Layout	<p>Unlike original grids, scrollable grids take advantage of AJAX technology, which enables you to change the grid structure and content directly on the grid. You can make changes to scrollable grids directly from the transaction page without using the Personalize link. Additionally, scrollable grids can be configured to scroll data within the grid control so as to keep frozen columns or column headers from scrolling out of view. Scrollable grids enable you to navigate from cell to cell vertically and horizontally.</p> <hr/> <p><b>Important!</b> If you have a Classic Scrollable Grid Layout grid displaying over 300 rows and you encounter performance issues in the browser, Oracle recommends that you convert the grid to the Classic Grid Layout. This allows the page in the browser to scroll, but not the grid. This reduces the overhead of keeping the grid column headers fixed and they will scroll along with the rest of the page content.</p> <hr/> <p><b>Note:</b> For scrollable grids, PeopleTools does not support any other style class apart from the default style classes applied to scrollable grids by the system. The styles applied to scrollable grids should not be customized, and you should not apply custom styles.</p> <hr/> <p><b>Note:</b> With Scrollable Grid Layout selected for a grid, on mobile devices, such as tablets or smartphones, the system displays the grid on the mobile device as Original Grid Layout.</p> <hr/> <p><b>Note:</b> HTML area controls should not be inserted into grids set to Scrollable Grid Layout. The system cannot calculate an HTML area's width and height data, which is required for the grid columns to be aligned and to display the correct number of grid rows.</p> <hr/>

<b>Grid Layout</b>	<b>Description</b>
List Grid Layout (Unordered)	Used to contain a list grid for displaying lists of items. It represents a grid as an unordered list (using <code>&lt;ul&gt;</code> and <code>&lt;li&gt;</code> tags).  List Grid is not a table grid. Therefore the proper use can be to have a grid with only one visible grid column.
Data Grid Layout	Select so users will not see the grid displayed on the fluid page, as if the grid is hidden. The data in the grid is stored in two JavaScript variables, as in one for the grid header columns and one for grid row data. You need to write custom JavaScript to use the grid data stored in the two variables.
Div Grid Layout	Represents a grid as a structure of HTML <code>&lt;div&gt;</code> elements. This allows for the dynamic creation of structures on a page that are not restricted to the display of tables or lists. It creates a structure of containers that allows more dynamic displays of data, if needed.
Flex Grid Layout	A table-based grid recommended for displaying tabular data on a fluid page. This grid layout type is based on the Original Grid Layout, but enhanced to take advantage of the “flex” model on fluid pages.
Classic List Grid Layout (Unordered)	Creates a bulleted list in a one-column grid.  The system generates an unordered list with <code>&lt;ul&gt;</code> <code>&lt;/ul&gt;</code> HTML tags instead of <code>&lt;table&gt;</code> <code>&lt;/table&gt;</code> tags, indicating the content is an unordered list containing rows of list item tags ( <code>&lt;li&gt;</code> <code>&lt;/li&gt;</code> ) for the rows of data.
Classic List Grid Layout (Ordered)	Creates a numbered list in a one-column grid.  Similar to the unordered list, except that instead of unordered list tags ( <code>&lt;ul&gt;</code> <code>&lt;/ul&gt;</code> ) tags the system generates ordered list tags ( <code>&lt;ol&gt;</code> <code>&lt;/ol&gt;</code> ) to contain the list items.
Classic Presentation Grid Layout	The system generates the <code>&lt;table&gt;</code> tag with the role = “presentation” clause added to it. This indicates to a screen reader that the grid is for presentation and layout purposes, rather than data.  In some cases, you may want to use a table for layout purposes only (keeping elements aligned in a certain way, for example). By specifying this option, PeopleTools adds a WAI-ARIA tag to the table so a screen reader will ignore the table (not treat it as a data table).
List Grid Layout (Ordered)	Used to contain a list grid for displaying lists of items. It represents a grid as an ordered list (using <code>&lt;ol&gt;</code> and <code>&lt;li&gt;</code> tags).  List Grid is not a table grid. Therefore the proper use can be to have a grid with only one visible grid column.
Menu Grid Layout	Use as a container for a pop-up menu.  See "Creating Fluid Pop-up Menus" (PeopleTools 8.58: Fluid User Interface Developer’s Guide).

<b>Grid Layout</b>	<b>Description</b>
Tab Set Grid Layout	Use to as a container for a set of sectional tabs embedded on a page.  See "Creating Sectional Tabs on a Page" (PeopleTools 8.58: Fluid User Interface Developer's Guide).

For the Classic List Grid Layout types (ordered and unordered), the following restrictions apply:

- Only the first edit box or hyperlink column in the grid will be displayed. Any subsequent columns in this type of grid will be ignored as will any other type of column that comes first. For example, push buttons, drop-down lists, check boxes, and so on, will all be ignored and not displayed.
- The grid will be display only, regardless of how it is set in Application Designer.
- The Add Row and Delete Row controls will not be displayed on the rows.
- Odd/Even row highlighting will be disabled, regardless of how it is set in Application Designer.
- Header and Footer areas that would normally be available in other types of grids will not be displayed. These would normally contain elements like navigation controls, such as (First < 1 – 10 of 80 > Last), the Find and Personalize links, the Download to Excel and Zoom controls, and so on.
- Column headers will not be displayed.

For the Classic Presentation Grid Layout, these restrictions apply.

- Odd/Even row highlighting will be disabled, regardless of how it is set in Application Designer.
- Header and Footer areas that would normally be available in other types of grids will not be displayed. These would normally contain elements like navigation controls, such as (First < 1 – 10 of 80 > Last), the Find and Personalize links, the Download to Excel and Zoom controls, and so on.
- Column headers will not be displayed.

The grid layout type can also be specified in PeopleCode. See "Layout" (PeopleTools 8.58: PeopleCode API Reference) for more information.

## Display Options

### Invisible

Select to make the grid or scroll area and its associated fields and records invisible. Use this setting for work grids or scrolls for which you want the underlying processing to be transparent to users. Typically, you associate invisible work grids and scrolls with PeopleCode Scroll functions that enable you to further control application processing.

### Display Only

In some cases, you might design grids that enable users to view but not change information. Select this check box if you do not want the user to enter data into the fields in any of the rows.

### Odd/Even Row Style

Selected by default, this attribute displays the grid with contrasting colors by row. The Odd Row Style and Even Row

Style drop-down list box options appear instead of the single Row Style option in the Row Styles group box.

**Show Column When Cells Hidden**

Select if you want the columns to appear even if all of the cells in a column are hidden. Columns do not collapse.

**Fixed Height (number of rows)**

Select to set the grid to a height corresponding to the number of rows in the occurs count attribute. The grid remains fixed at that height even if the actual number of data rows varies from that number. If the fixed height property is not used, the size of the grid dynamically changes based on the occurs count and the number of data rows retrieved.

**Enable View All Columns**

Displays an expand all button to the right of a tabbed grid, enabling the user to view all columns of the grid by scrolling to the right using the horizontal scroll bar of the browser instead of selecting the grid tabs. The Show Grid Tab button appears when columns are expanded to enable the user to view the tabs again.

**Disable Display in Modal Window**

Select to disable the zoom capability of the grid.

**Disable Row Highlighting**

Select to disable grid row highlighting.

By default, when an end user hovers the mouse over a row or selects the row, the system highlights that row to indicate it is the row of current focus. However, highlighting can be distracting or unnecessary for some interfaces for varying reasons, such as the form factor of the device displaying the page.

**Collapsible Data Area**

Select to collapse the data area for your grid or scroll area into a header bar with a small image that the user must click to activate or expand it. Selecting this option enables the Default Initial View to Expanded State check box. You can then select the label image to represent the collapsed and expanded states.

**Image: Expanded scroll area**

This example illustrates the fields and controls on the Expanded scroll area. You can find definitions for the fields and controls later on this page.

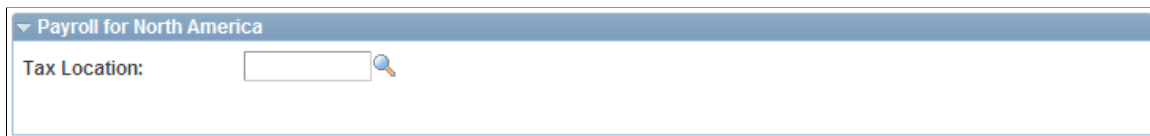

**Image: Collapsed scroll area**

This example illustrates the fields and controls on the Collapsed scroll area. You can find definitions for the fields and controls later on this page.



## Configuring Embedded Help for Scroll Areas, Grids, and Group Boxes

You can configure scroll areas, grids, and group boxes to display an embedded help pop-up message that you create and store in the Message Catalog.

This diagram illustrates the business process flow for creating, configuring, and accessing embedded help:

### Image: Business process flow for creating and accessing embedded help

The following diagram illustrates the business process flow for creating, configuring, and accessing embedded help

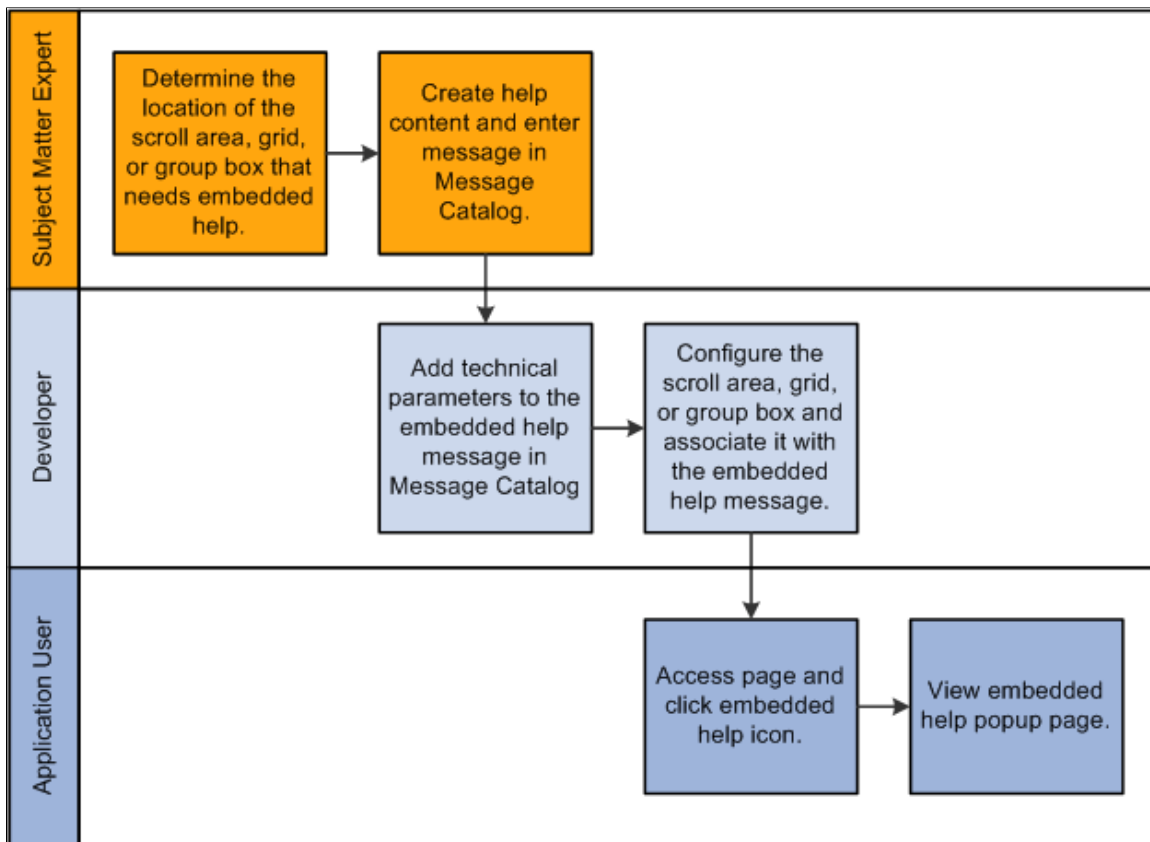

This section discusses how to:

- Enter embedded help messages in the Message Catalog.
- Associate help messages with scroll areas, grids, and group boxes.

**Note:** Use this information to configure embedded help for group boxes, also.

## Entering Embedded Help Messages in the Message Catalog

To configure embedded help, first you must create Message Catalog messages that you specifically design for use by scroll areas, grids, and group boxes. To enter embedded help messages in the Message Catalog:

1. Access the Message Catalog (PeopleTools, Utilities, Administration, Message Catalog).
2. Select an existing or create a new message.

---

**Note:** You should create new message sets to avoid extra upgrade maintenance tasks.

---

3. Enter the help content in the Explanation field. Include the necessary variables if you want to generate other help links that appear on the embedded help pop-up page. The table at the end of this section describes the variables and their usage.

---

**Note:** The help content should be contextual and specific to the page control to which it will be associated in the next section.

---

4. Save the message entry.

### Embedded Help Variables

This table describes the variables that you can add to the embedded help content in the Message Catalog. Use these variables to generate links on the embedded help pop-up page that enable the user to access additional online help.

**Note:** You must install the Online PeopleBooks Library for any PeopleBooks Online Help link to function properly.

<b>Variable</b>	<b>URL</b>	<b>Label</b>
<code>%PBCTXT ( )</code>	This variable uses the current page name as the <code>%CONTEXT_ID%</code> to build the PeopleBooks Help URL so the embedded link takes the user to the PeopleBooks content associated with the current page.	Because no message is referenced, the label of the help link appears as Help.
<code>%PBCTXT (sn, mn)</code> The argument <code>sn</code> is the Message Set Number. The argument <code>mn</code> is the Message Number.	This variable uses the current page name as the <code>%CONTEXT_ID%</code> to build the PeopleBooks Help URL so that the embedded link takes the user to the PeopleBooks content associated with the current page.	Because a message is referenced, the label of the help link appears as the value that is stored in the Message Text field for the referenced message.  If you reference an invalid message, the label appears as Help.
<code>%PBCTXT (CTXT_PG_NM)</code> The argument <code>CTXT_PG_NM</code> is a page definition name.	This variable uses the <code>CTXT_PG_NM</code> argument as the <code>%CONTEXT_ID%</code> to build the PeopleBooks Help URL so that the embedded link takes the user to the PeopleBooks content associated with the page referenced by the argument.	Because no message is referenced, the label of the help link appears as Help.
<code>%PBCTXT (CTXT_PG_NM, sn, mn)</code> The argument <code>CTXT_PG_NM</code> is a page definition name.  The argument <code>sn</code> is the Message Set Number. The argument <code>mn</code> is the Message Number.	This variable uses the <code>CTXT_PG_NM</code> argument as the <code>%CONTEXT_ID%</code> to build the PeopleBooks Help URL so that the embedded link takes the user to the PeopleBooks content associated with the page referenced by the argument.	Because a message is referenced, the label of the help link appears as the value that is stored in the Message Text field for the referenced message.  If you reference an invalid message, the label appears as Help.
<code>%PBURLTBL (&lt;URL_IDENTIFIER&gt;, sn, mn)</code> The argument <code>&lt;URL_IDENTIFIER&gt;</code> is any <code>URL_ID</code> that is stored in the URL Maintenance component.  See "URL Maintenance" (PeopleTools 8.58: System and Server Administration).	This variable uses the <code>&lt;URL_IDENTIFIER&gt;</code> argument to build help URL so that the embedded link takes the user to the site associated with the <code>URL_ID</code> .	Because a message is referenced, the label of the help link appears as the value that is stored in the Message Text field for the referenced message.  If you reference an invalid message, the system uses the <code>&lt;URL_IDENTIFIER&gt;</code> argument as the label.



<b>Variable</b>	<b>URL</b>	<b>Label</b>
The argument <code>sn</code> is the Message Set Number. The argument <code>mn</code> is the Message Number.		
<code>%PBLNK(http://www.site.com⇒,sn,mn)</code> The argument <code>sn</code> is the Set Number. The argument <code>mn</code> is the Message Number.	This variable uses the hard-coded URL so that the embedded link takes the user to the specified site.	Because a message is referenced, the label of the help link appears as the value that is stored in the Message Text field for the referenced message.  If you reference an invalid message, the system uses the URL as the label.

### Related Links

"Configuring General Portal Properties" (PeopleTools 8.58: Portal Technology)

"Message Catalog" (PeopleTools 8.58: System and Server Administration)

## Associating Help Messages with Scroll Areas, Grids, and Group Boxes

After entering a message, you associate the message to a page control. To associate help messages to scroll areas, grids, and group boxes:

1. Open a page definition.
2. Double-click the scroll area or grid to access the properties dialog box.
3. Access the Label tab.
4. In the Embedded Help Popup section, select the Message Catalog Popup option.
5. Enter the Message Set/Number values of the message that you want to appear in the embedded help pop-up page.

The message should appear in the Text field.

6. Verify that the message in the Text field is correct.
7. Click the OK button.
8. Save the page definition.
9. In the browser, access the page and test the embedded help.

---

**Note:** Use the preceding steps to associate Help messages to group boxes, too.

---

### Related Links

"Accessing Embedded Help" (PeopleTools 8.58: Applications User's Guide)



## Chapter 10

# Creating Page Definitions

---

## Understanding Page Design and Development

Pages are the graphical interface between your users and your application database. As a system designer, you configure or build pages that meet the data requirements of the application and that are easy to use and understand. Using PeopleSoft Application Designer, you can create, modify, and delete page definitions in your PeopleSoft system.

This section discusses:

- Level-based controls.
- Keys for accessing pages.
- Multiple occurrences of data.
- Prompt fields.
- Derived and work fields.
- Sensitive data.
- Hidden pages.
- Upgrade considerations.
- End-user page personalization.

## Level-Based Controls

You determine your page design based on the type of data that you plan to access and maintain. In some cases, a page references a single record definition; in others, you may want to reference multiple records. To accommodate a variety of page designs, PeopleSoft Application Designer uses *level-based controls*. The three level-based controls are:

- Grids
- Scroll areas
- Scroll bars

You specify the level of these controls by setting the *occurs levels* on the Record tab of the page field properties dialog box for the level-based control that you are configuring. Level-based controls have four levels:

- Level 0

This level directly corresponds to the high-level key information of the underlying record. Level 0 fields are usually physically located at the top of the page, set to be display-only, and display the data that the user entered on the initial search page.

- Levels 1–3

These levels correspond to lower level key information that is subordinate to the Level 0 key values. Level 1 is subordinate to Level 0; Level 2 is subordinate to and nested within Level 1; and Level 3 is subordinate to and nested within Level 2.

---

**Note:** You can nest level-based controls up to three levels.

---

The first occurs level on a page is Level 0. In general, this level is reserved for the primary key fields that are used to search for data. A page might not contain any level-based controls; in such a case, all fields are set to Level 0. This case is particularly true for secondary pages or subpages that contain few data entry fields, as shown in the following example. The third column, Lvl (Level), that appears in the grid on the Order tab indicates that all fields on the page are at Level 0:

**Image: Example of page definition Order tab**

This example illustrates the fields and controls on the Example of page definition Order tab. You can find definitions for the fields and controls later on this page.

Tab Order	Field ID	Lvl	Label	Type	Field	Record	Display Control
1	1	0		Subpage		NOSEARCH_VW	<input type="checkbox"/>
2	2	0	Activity Name	Group Box	ACTIVITYNAME	PSACTIVITYGUI	<input type="checkbox"/>
3	3	0	Step 1 Link	Push Btn/Link	STEP_1_URL	PSACTIVITYGUI	<input type="checkbox"/>
4	4	0	Image 1	Image	STEP_2_IMAGE	PSACTIVITYGUI	<input type="checkbox"/>
5	5	0	Image 1	Image	STEP_1_IMAGE	PSACTIVITYGUI	<input type="checkbox"/>
6	6	0	Step 2 Link	Push Btn/Link	STEP_2_URL	PSACTIVITYGUI	<input type="checkbox"/>
7	7	0	Image 1	Image	STEP_3_IMAGE	PSACTIVITYGUI	<input type="checkbox"/>
8	8	0	Step 3 Link	Push Btn/Link	STEP_3_URL	PSACTIVITYGUI	<input type="checkbox"/>
9	9	0	Image 1	Image	STEP_4_IMAGE	PSACTIVITYGUI	<input type="checkbox"/>
10	10	0	Step 4 Link	Push Btn/Link	STEP_4_URL	PSACTIVITYGUI	<input type="checkbox"/>

When you add a level-based control, a scroll area or a grid, to your page, the default occurs level for that control is set to 1 in the properties dialog box. If you place a field in or below that scroll area, it is also set to Level 1 on the Order tab, even if it is another level-based control. If necessary, you can use the Set to Level 0 feature of the horizontal rule control to restart the occurs level on a page.

---

**Note:** You can have any number of level-based controls at the same level.

---

**Nested Level-Based Controls**

Nesting controls involve two or more level-based controls on a page, such as two scroll areas, when the second scroll area has an occurs level of 2. You nest controls when the new data that you want to add is a repeating set of data for each entry in your first level-based control. In doing so, you create a hierarchical, or parent and child, relationship between the controls and the processing of the record definitions. The Level 2 control is the child of and is subordinate to the Level 1 control.

For example, on the Compensation page, the Level 2 grid is nested in the Level 1 scroll area. On the Amounts tab of the grid, each compensation action in the Level 1 scroll area has two rate codes:

**Image: Example of Compensation page with nested grid in scroll area**

This example illustrates the fields and controls on the Example of Compensation page with nested grid in scroll area. You can find definitions for the fields and controls later on this page.

The screenshot shows the 'Compensation' page with the following details:

- Effective Date:** 01/01/2000
- Effective Sequence:** 0
- HR Status:** Active
- Payroll Status:** Active
- Action:** Hire
- Reason:**
- Job Indicator:** Primary Job
- Current:** (toggle)
- Compensation Rate:** 1,776.67 AUD
- \*Frequency:** M Monthly
- Pay Components:**
  - Default Pay Components
  - Contract Change Prorate Option

The nested grid 'Pay Components' is shown with the following data:

*Rate Code	Seq	Comp Rate	Currency	Frequency	Points	Percent	Rate Code Group
1 KABS01	0	1,776.667000	AUD	M			
2 KABSTL	0	1,950.500000	AUD	M			

Buttons: Calculate Compensation

This example of the Additional Pay 1 page shows three levels of data, two of which are nesting scroll areas in the Earnings scroll area:

**Image: Example of Additional Pay 1 page with nested scroll areas**

This example illustrates the fields and controls on the Example of Additional Pay 1 page with nested scroll areas. You can find definitions for the fields and controls later on this page.

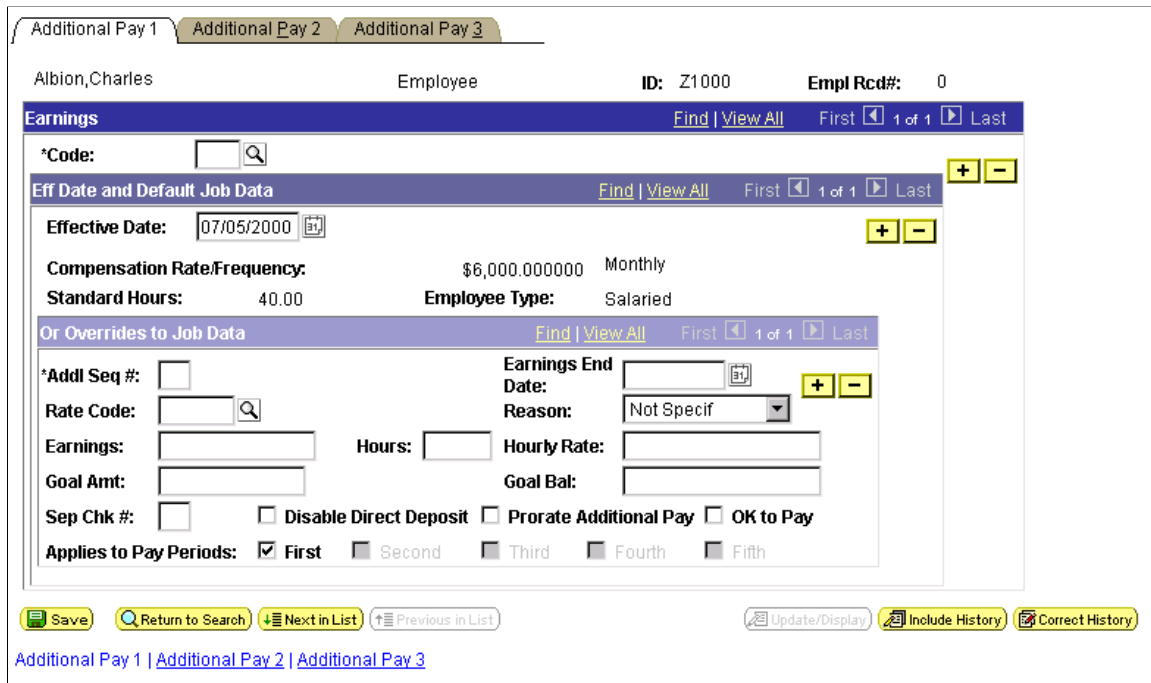

In this case, we want to maintain information about the compensation history for a single employee and, for each change or override in compensation status, enter details about that change. The first scroll area, Earnings, associates the earning code with the second, subordinate scroll area, Eff Date (effective date) and Default Job Data, which enables the user to enter the effective date for the status change. The third scroll area, Or Overrides to Job Data, which is subordinate to the second, enables the user to enter the overrides to the default job data that appears in the second scroll area.

For each of the three scroll areas, you can have several rows of data. While you do not see actual scroll bars on your page, the navigation buttons and links in the navigation bars for each scroll area enable you to navigate or scroll through the rows.

**Nested Grids in Scrolls**

As shown previously, you can nest a grid in a scroll or scroll area. The following example shows the Other Earnings grid at Level 3, which is nested in the Earnings scroll area at Level 2, which is nested in the Paysheet Details scroll area at Level 1. A nested grid serves the same function as a nested scroll area. It can offer a more compact way of viewing many fields of data, particularly if you use a tabbed grid.

---

**Note:** You can nest a grid in a scroll area, but you cannot nest a scroll area in a grid or a grid in another grid.

---

### Image: Example of Paysheet page with three levels of nesting

This example illustrates the fields and controls on the Example of Paysheet page with three levels of nesting.

The screenshot displays a 'Paysheet' page with three levels of nesting. The top level is the 'Paysheet' header, which includes tabs for 'One-Time Deductions', 'One-Time Garnishment', 'One-Time Taxes', and 'Page Balances'. Below this, the 'Paysheet Details' section shows company information (BN1), pay group (B2M), and pay period end date (12/31/1998). The second level of nesting is the 'Earnings' section, which contains various checkboxes (OK to Pay, Job Pay, etc.) and input fields for hours and rates. The third level is the 'Other Earnings' table, which has columns for Code, Seq Nbr, Rate Code, Hours, Rate, Amount, and Source.

### Levels and Runtime Processing

Levels play an important role in runtime processing. The component processor relies on the level at which you place a field on a page to determine how to process any PeopleCode attached to the field in the record definition.

### Effective Dates and Level-Based Controls

The EFFDT (effective date) field must be the *only* key field that is controlled by level-based controls that you create to help users maintain multiple occurrences of data that is keyed by effective date. Otherwise, the effective date processing for update actions does not function correctly.

### Related Links

"Understanding Data Buffer Access" (PeopleTools 8.58: PeopleCode Developer's Guide)

### Keys for Accessing Pages

No matter how much time you spend defining and refining your page, your work is useless unless the user can access it. You must add it to a component, and then you must add that component to a menu. When you add a page to a component, you determine what actions the user must perform to access the page and the keys that are required to retrieve rows of information.

The search record that you define for a component determines the key list; that is, search keys for which users are prompted when they select a page and an action. A search record can be either a view that concatenates information stored in several tables or the underlying table itself. Select the search record that contains all of the key items for the primary record underlying the page.

The keys for which the search dialog box prompts should populate the high-level (Level 0 in the page definition) key controls on a page. These key controls always appear before any level-based control on the page and are typically display-only. A search record might differ from a primary record definition, but it must contain all of the Level 0 keys that you placed on the page.

## Using Keys for Views

When you create a view that should use key values from a page, each key must be:

- Listed as an output column from the view (not just referenced in the WHERE clause of the view).
- Marked as a key field of the view.

For example, suppose that a page has PERSON.PERSONID as a Level 0 field. PERSONID is the key of the PERSON record. A grid on the page uses the PERSON\_ADDRESS\_VW view to display addresses for the current person. The SQL statement for the view cannot only mention PERSON.PERSONID in the WHERE clause; PERSONID must be both an output column of the view and a key field of the view.

## Related Links

[Understanding Record Definitions](#)

[Understanding Component Definitions](#)

## Multiple Occurrences of Data

On some pages, you may want a few of the field controls to display multiple rows or occurrences of data. To do this, you can add a level-based control: a scroll area, a grid, or a scroll bar. Users can then add, edit, delete, find, and scroll through multiple occurrences of data in a page control or group of controls using action buttons, links, or the browser scroll bar, depending on how you set the occurs count. Using a scroll area or a grid, rather than a scroll bar, is the preferred page design to show multiple occurrences of data.

For example, this Checklist Table page contains the Assignment Checklist Item grid with an occurs count of 5. The Checklist Item scroll area in which it is nested must have an occurs count of 1 since we can see only one row of data in the scroll area:



### Image: Example of Person Checklist page with a grid of occurs count 5 nested in a scroll area of occurs count 1

This example illustrates the fields and controls on the Example of Person Checklist page with a grid of occurs count 5 nested in a scroll area of occurs count 1. You can find definitions for the fields and controls later on this page.

**Person Checklist**

Susan Jones Person ID: 0002

**Checklist History** Find | View All First 1 of 1 Last

\*Checklist Date: 08/17/2011

\*Checklist: DEUTER Termination

Comment:

**Person Checklist Items** Customize | Find | First 1-5 of 10 Last

*Sequence	*Item Code	Description	*Status	Link ID
100	TER01	Cancel Security Access	Initiated	
200	TER02	Update Social Insurance Data	Initiated	<a href="#">Update Social Insurance Data</a>
600	TER06	Holiday status/ bonus	Initiated	
800	TER08	Process Job Change	Initiated	<a href="#">Job Change Request</a>
900	TER09	Verify Termination Date	Initiated	<a href="#">Verify Termination Date</a>

To see the next set of five rows in the Assignment Checklist Item grid, a user can click the right arrow button. To see all rows of data at once, in either the grid or scroll area, the user can select the View All link in the navigation bar.

In PeopleSoft Application Designer, you set the occurs count for a level-based control on the General tab in the properties dialog box. You can set the occurs count to any number. You also have the option of selecting Unlimited Occurs Count so that the user sees all rows of data. If the page has more options than can be viewed in the window at runtime, the browser displays a scroll bar enabling the user to scroll to the bottom of the page.

**Note:** When an occurs count is set to a number other than 1, the grid displays the specified number of rows. However, when it is set to 1, the grid displays as many rows as possible within the given space allocated for the grid control at design time.

## Prompt Fields

You can enable your users to look up the valid values that they can enter in a field. For this, PeopleSoft Application Designer provides prompts, or lookup buttons. Your PeopleSoft applications use the following three types of prompts:

- Drop-down list box

This type of prompt generates a list of values, which appears directly below the prompt field when the user clicks the down arrow that appears beside the field.

The drop-down list box is a predefined control that you place on your page. The Job Indicator field on the Work Location page is an example of drop-down list box.

- Calendar prompt

This type of prompt generates a small calendar, which appears next to the date field, when the user clicks the calendar button. Users can navigate the calendar to find and select a date. The Effective Date, Position Entry Date, and Department Entry Date fields on the Work Location page are examples of calendar prompts. The calendar prompt appears automatically as part of any edit box control that you associate with a date field as long as the Show Prompt Buttoncheck box display option on the Record tab is selected.

- Lookup button

A prompt or lookup button opens a lookup page in the user's browser populated with up to 300 available values for that field. The user can then either select the desired value or refine their search further. For extremely large tables, the system administrator has the option of excluding that table from auto prompting on the Lookup Exclusion Table via PeopleTools, Utilities, Administration.

In PeopleSoft Application Designer, you can only associate a lookup button with an edit box control. The look up button appears automatically as part of any edit box control as long as the Show Prompt Buttoncheck box display option on the Record tab is selected and the record field with which you associate the edit box lists values in either the Translate table or a prompt table.

**Image: Work Location page showing sample prompt fields**

This example illustrates the fields and controls on the Work Location page showing sample prompt fields. You can find definitions for the fields and controls later on this page.

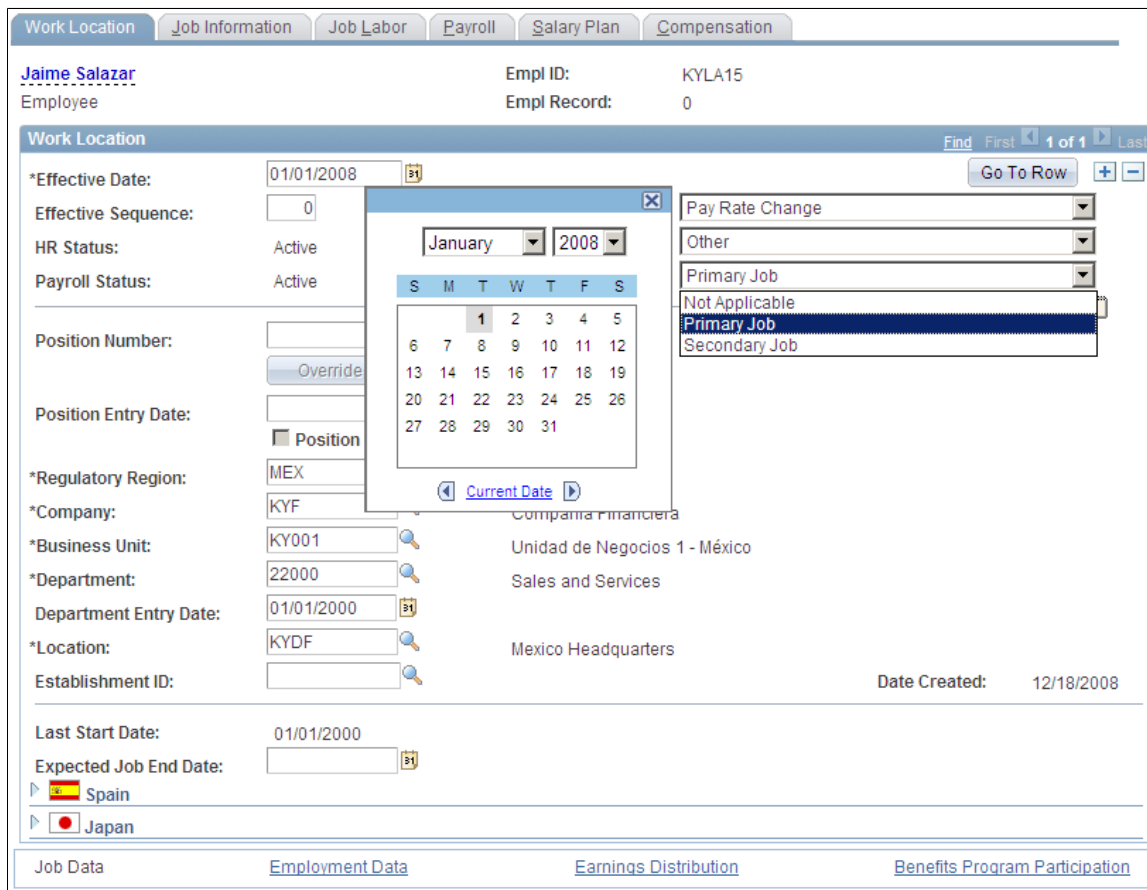

## Related Links

[Using Drop-Down List Boxes](#)

[Specifying Date Field Attributes](#)

[Using the Translate Table](#)

## Derived and Work Fields

You can use a field definition from a derived or work record to store a temporary value that PeopleCode uses to determine the values of other field controls on the page.

For example, for a budgeting transaction in PeopleSoft General Ledger, assume that you have an annual amount that you must spread to multiple accounting periods. You can create a page that includes both a field control from a derived record for the annual amount and an amount control for each accounting period. You then write PeopleCode to derive the amount per accounting period from the annual amount. When a user enters the annual amount in the derived field control, PeopleCode calculates the amount per accounting period and inserts it into each accounting period field control. The annual amount is not stored in the database, but the period amounts are.

## Sensitive Data

You can allocate sensitive data to a single page and limit access to that page to the users who need to update it. Alternatively, you can enter PeopleCode to hide certain fields on pages based on appropriate criteria. The page approach is simpler, however, and can be used in most situations. For secondary pages, this sort of security is more complex to manage.

## Related Links

"Hide" (PeopleTools 8.58: PeopleCode Language Reference)

## Hidden Pages

Hidden pages are work pages that are associated with derived or work records; they are often used in work groups. You can store all of your work field controls on hidden pages. Create these pages when you want PeopleCode calculations to be performed in the background so that the user does not see them. As a convention, the names of work pages that are delivered with your application names end with the suffix `_WRK`; you should follow the same naming convention. An example name is: `MC_TYPE_WRK`.

Hide a page by selecting the Hidden check box in the component grid as you set up the component definition.

## Related Links

[Setting Page Attributes](#)

## Upgrade Considerations

If you adapt a PeopleSoft application, you might affect your use of future PeopleSoft releases. The closer your PeopleSoft system is to the standard product, the easier your upgrades will be. Avoid superfluous or cosmetic changes to data structures in the standard product. Document all of your changes in the comment area on the General tab in the Page Properties dialog box.

## End-User Page Personalization

End users of PeopleSoft applications can personalize various settings on a page, including tab order, the display state of scroll areas and grids, and the state of collapsible sections. Users can also choose that the default page display for a component each time they open that component. In addition, users can choose to share their personalization settings with or copy settings from another user.

The page personalization option is set in the Component Properties dialog box, Internet tab. The Personalize Page Link check box is selected by default to enable the Personalize Page link in the pagebar at runtime for all pages.

### Related Links

[Setting Internet Properties](#)

"Personalizing Pages" (PeopleTools 8.58: Applications User's Guide)

[Understanding Scroll Areas, Scroll Bars, and Grids](#)

[Using Page Development Tools](#)

[Adding Page Controls](#)

[Manipulating Page Controls](#)

---

## Using Page Development Tools

This section discusses how to:

- Use page definition menus.
- Use page definition toolbars.
- Use the page layout grid.

## Using Page Definition Menus

As you build pages, use the tools and options in these menus:

- File Menu

In addition to the standard options for opening, deleting, and renaming pages, use this menu to access the definition (page) properties and project properties.

- Edit Menu

Access the page field properties from this menu. To find out what other definitions reference the active page, select Find Definition References. You can also search for a text string in types of PeopleCode or SQL objects.

- View Menu

- Select View Definition to view the underlying definition, such as the subpage or record, for the selected control.

You can view the PeopleCode for the page or the underlying record definition.

- The properties Edit Fill Display, Edit Fill All, and Edit Fill None refer to how controls appear only during design time. They do not affect the page during runtime.
  - Use the Show Page Control Inspector tool to view summary data of the selected page field.
  - Use Show Grid to display or hide a layout grid on the page that you are designing to help you place controls more accurately.
- **Insert Menu**  
Use this menu to insert different types of controls on your page. You can also insert the page on which you are working into a project.
  - **Tools Menu**  
This menu provides access to various utilities, such as data administration, change control, upgrade, and translate.
  - **Layout Menu**  
Use this menu to modify the number of pixels between points on the layout grid. Options on this menu also enable you to align page controls, align page control labels, view the processing order of the controls on the page, and test the tab order between fields on your page.
    - Use the Align functions to move selected page controls or page control labels to ensure consistency of vertical and horizontal placement among the selected elements. All selected elements align to the last element that you select in the set.
    - Use the Auto Size Page function to resize your page to the best height and width that accommodates your page controls.
    - Use the View in Browser function to see a very general image of the page in the selected browser without data. Note, however, that PeopleCode is not run on this page rendering, so the page may look significantly different to users if PeopleCode is used to hide or reveal page fields.
    - Use the Generate HTML function to create a text file containing the HTML for your page. The file is saved to the Temp directory of your local drive. Note that the HTML that is generated contains no data or context. It is, therefore, likely to differ from the HTML on a page at runtime.

## Using Page Definition Toolbars

The toolbars in PeopleSoft Application Designer change, depending on the active window. When a page window is active, you see the page definition toolbar and the page control toolbar.

### Page Definition Toolbar



Click the Properties button to open the Page Properties dialog box (Alt+Enter).



Click the Project Workspace button to display or hide the project workspace (View > Project Workspace or Alt+0).



Click the Select Group button to select several controls at once (Edit > Select Group menu item or Ctrl+P).



Click the Default Ordering button to reorder all of the fields on the page based on their relative locations on the page (Layout > Default Ordering).



Click the Test Page button to test the tab order of your page design (Layout > Test Mode or Ctrl+T).



Click the View Page in Browser button frequently throughout the design process (Layout > View in Browser).



Click the Toggle Inspector button to display or hide the floating Definition Inspector window (View > Show Page Control Inspector).



Click the Auto Size button to size a subpage or secondary page to fit around page controls.



Click the Toggle Grid button to display or hide the page grid (View > Show Grid or Ctrl+G).



Click the Left Label Position button to place the page control label for the currently selected field immediately to the left (Layout > Left Label Position or Ctrl+D).

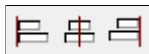

Click an Align (position) button to move the selected page controls so that the edges or center points of the selected page controls share a common axis (Layout > Align (position)).



See [Aligning Page Controls and Page Control Labels](#).



Click an Align Label (position) button to move the selected labels so that the edges or center points of the selected labels share a common axis (Layout > Align > Label (position)).



Click the Auto Size Fields button to resize the selected edit box and drop-down list box page controls so that they are all the same width as the last page control that you select. (Layout > Align > Auto Size Fields)



Click the Show Help button to view the page definition help.

### Page Control Toolbar

The page control toolbar contains a button for each type of page control that you insert. The buttons display images that look like the controls that they insert. You can move this toolbar on your workspace independently of the system toolbar or the other half of the page definition toolbar.



Frame.



Group box.



Horizontal rule.



Static text.



Static image.



Grid tab separator.



Check box.



Drop-down list box.



Edit box.



HTML area.



Image.



Long edit box.



Push button/hyperlink.



Radio button.



Tree.



Grid.



Scroll area.



Scroll bar.



Secondary page.



Subpage.



Chart.

## Using the Page Layout Grid

When you open a page definition, evenly spaced dots appear in the workspace. This is the page layout grid that you use to align controls. When you run applications, the grid does not appear on pages. It appears only as a design aid in the page definition. This example shows the Layout Grid dialog box:

### Image: Example of Layout Grid dialog box with default values

This example illustrates the fields and controls on the Example of Layout Grid dialog box with default values. You can find definitions for the fields and controls later on this page.

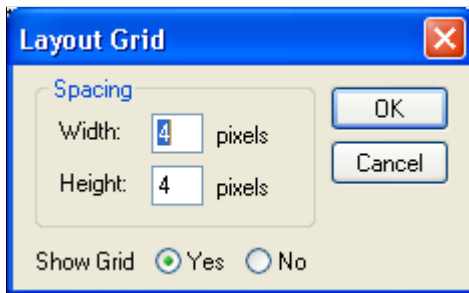

The default grid spacing is  $4 \times 4$ , which means that each row has one dot per 4 pixels and that the rows are 4 pixels apart on the vertical axis. Most pages in PeopleSoft applications are built using this grid. To change the spacing, open the Layout Grid dialog box by selecting Grid Settings from the Layout menu.

You can turn off the grid view of your page by clicking the Toggle Grid button in the page definition toolbar.

## Changing Page Layout Grid Settings

To change grid spacing:

1. Select Layout >Grid Settings.
2. Enter values for the width and the height, which is the spacing of the dots in pixels.

The smaller the value, the finer the grid. The finer the grid, the more difficult it is to align fields precisely without using the align functionality. Note that if either the width or height is set to one, then the grid will be slightly off.

Select a Show Grid option to activate or deactivate the page grid.

If you copy an existing page and save it by another name, you also copy the grid settings that were used to create the original page. For example, if the original page was built with a  $5 \times 5$  grid, then your new page also will have a  $5 \times 5$  grid, by default. You can change the grid settings anytime while working on a page. Doing so has no effect on the position of a field.

The snap-to-grid functionality is only available when the layout grid is showing.

---

## Creating New Page Definitions

To create a new page definition, either clone an existing page or begin with a blank page. Cloning is more efficient because you do not have to recreate controls that are common to all pages. You can also create a template that contains only the controls that you need.



This section discusses how to:

- Clone page definitions.
- Create a blank page.

---

**Note:** When saving new definitions, always make sure to adhere to accepted naming conventions.

---

See [Saving Definitions](#).

## Cloning Page Definitions

To clone a page definition:

1. Select File > Open.

The Open Definition dialog box appears.

2. Specify *Page* for the definition and locate the page that you want to clone.
3. When the system retrieves the page definition, select File > Save As.

If you save after you make modifications, you might accidentally overwrite the old page definition.

4. Enter a new page name.

To create a new page template, name the page so that it appears at the top of your page list.

5. Click OK.

---

**Note:** Record definition names are restricted to a maximum of 15 characters; page names can have up to 18 characters.

---

### Related Links

[Opening Definitions](#)

[Saving Definitions](#)

## Creating a Blank Page

To create a new page without copying an existing page, select File > New > Page.

When saving the page, make sure that you adhere to the accepted naming conventions.

See [Saving Definitions](#).

---

## Adding Page Controls

You can add page fields to a page in a number of ways. You can copy page fields from one page and paste them onto another, or you can drag-and-drop page fields from one page to another. In addition to these basic methods, this section discusses how to:

- Drag field definitions from a record onto a page.
- Drag record fields from the project workspace onto a page.
- Drag record definitions onto a page.
- Use the page control toolbar.
- Use the Insert menu.

---

**Important!** While PeopleSoft Application Designer does not limit the number of page controls you can add to a page, you might experience unexpected performance issues when you develop pages that contain very high numbers of page controls.

---

## Dragging Field Definitions From a Record Onto a Page

To drag field definitions from a record onto a page:

1. Open an existing record definition by selecting File > Open > Record.
2. Open a new page by selecting File > New > Page.
3. Drag field definitions from the record to the page.

The system selects the page definition control type based on the record field attributes. In the preceding page, the EMPLID (employee identification) field was defined as a prompt table edit in the record, so a Prompt button was added for EMPLID when it was dragged onto the page.

4. Double-click the new page field to set the properties.

When you drag field definitions, the properties from the record definition are used to set page field default properties. You can alter the properties using the Properties dialog box.

## Dragging Record Fields from the Project Workspace onto a Page

To drag record fields from the project workspace onto a page:

1. Open the project that you want to drag from an existing or new page.
2. Drag record fields from the project workspace to the page.
3. Double-click the new page field to set the properties.

---

**Note:** When you drag fields from the project workspace, you must use fields that are contained in records (that is, record fields), not standalone field definitions.

---

## Dragging Record Definitions Onto a Page

You can add an entire record definition to a page at once, which can save a great deal of time when generating pages. You can then arrange the fields as desired on the page.

---

**Note:** You can also drag an entire record definition into a grid control that you have placed on a page.

---

See [Inserting and Manipulating Grid Columns](#).

### Image: Dragging a record definition to a page

This example illustrates the fields and controls on the Dragging a record definition to a page. You can find definitions for the fields and controls later on this page.

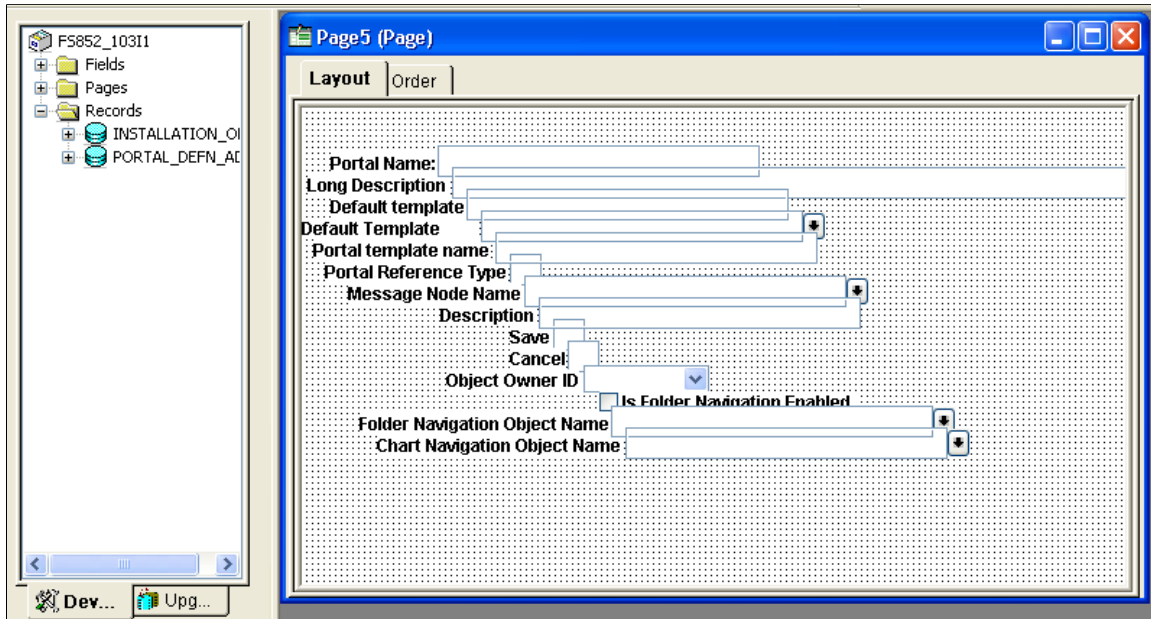

To drag record definitions onto a page:

1. Open the project that you want to drag from an existing or new page.
2. Drag the record definition onto the page.

PeopleSoft Application Designer positions the record fields on the page as page fields in a cascading manner. Fields are in the order that they appear in the record with the appropriate control value assigned to each one.

3. Reposition the fields as necessary on your page.
4. Double-click each new page field to set its properties.

## Using the Page Control Toolbar

You can insert page controls by using the page control toolbar. When you click one of the page control buttons, the cursor changes to a cross-shaped icon or hand, depending on which control type you select. You can then move the cursor to where you want to position the control and click once. If you select a control from the toolbar erroneously and want to cancel the selection, press the Esc key and then select the desired page control button.

If the control is a fixed size during insertion, the cursor changes to a cross-shaped icon. If the control type requires that you define the size of the control at the time of insertion, the cursor changes to the monogrammed hand icon. When a hand-shaped icon appears, press and hold the left mouse button as you drag the hand diagonally downward to where you want the lower, right-hand corner of the frame. Release the mouse button.

If the control is not correct the first time that you draw it, you can easily adjust it. The dotted box and black or blue handles surrounding the control indicate that it is selected. Use any of the four directional arrow keys on the keyboard to move the frame one page grid unit in the indicated direction. You can also use Shift+ the arrow key to resize the page control.

## Using the Insert Menu

Select the control that you want to add to your page from the Insert menu. Your cursor changes to a cross-shaped icon or a hand, depending on which control type you select. Move the cursor to where you want to position the control and click once.

---

## Manipulating Page Controls

After you place a control on a page, you have several choices for manipulating it.

This section discusses how to:

- Select controls.
- Resize controls.
- Use the Page Control Inspector.
- Delete controls.
- Move controls on the same page.
- Copy and move controls to another page.
- Position page control labels.

## Selecting Controls

Before you manipulate a control, you must select it. You can do this by clicking the control or by using the Edit menu. A check mark beside the option in the menu indicates which of these modes you are in:

### Select Field

Select one control on the page by clicking on it. To deselect a control, click once outside the dotted box. Deselected is the default mode.

### Select Group

Select a group of controls by drawing a box around the controls that you want to select. You can also activate this option by clicking and dragging over the target fields.

---

**Note:** You are in Select Group mode when the cursor changes to a pointing finger. If the cursor does not change when you select Edit > Select Group try first selecting an individual control on the page and then selecting Edit > Select Group again.

---

**Select All**

Select all of the controls on the active page. The result is the same as using the Select Group option to draw a box around the controls.

**Resizing Controls**

You can adjust the size or shape of any page control that displays selection handles when it is selected:

**Image: Resizing a control with selection handles**

This example illustrates the fields and controls on the Resizing a control with selection handles. You can find definitions for the fields and controls later on this page.

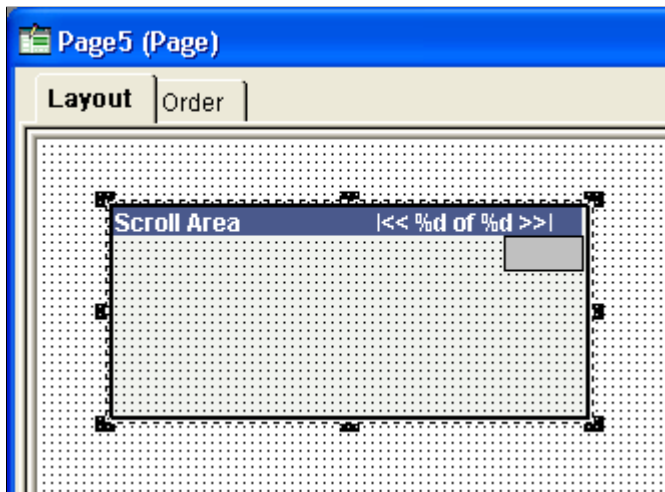

---

**Note:** Some browsers do not support the resizing of certain control types. In these cases, changing the size in PeopleSoft Application Designer has no effect upon the runtime size of the field.

---

See *Troubleshooting Browser Limitations* available on the My Oracle Support website.

To resize a control, use one of these methods:

- Select the control and drag a handle to adjust the height or width.

---

**Note:** For some control types, you can adjust only the width.

---

- Hold down the Shift key while pressing the Up Arrow, Down Arrow, Left Arrow, or Right Arrow key.

The frame size is adjusted one grid unit in the indicated direction.

---

**Note:** The position of the top, left corner of the frame does not change; resizing with the keyboard occurs by adjusting the position of the bottom, right corner.

---

**Using the Page Control Inspector**

The Page Control Inspector provides location, size, type, and data source information for the selected page control on the page. The first six values, Left, Width, Right, Top, Height, and Bottom, display the

exact bounding coordinates in pixels of the control on your page in PeopleSoft Application Designer. The remaining values help distinguish the selected control from others on the page.

Access the Page Control Inspector from the View menu or by clicking the Toggle Inspector button on the page definition toolbar. When you finish viewing the values for one control, click another control to view its values. You can check multiple controls on a page in quick succession.

### Image: Page Control Inspector

This example illustrates the fields and controls on the Page Control Inspector. You can find definitions for the fields and controls later on this page.

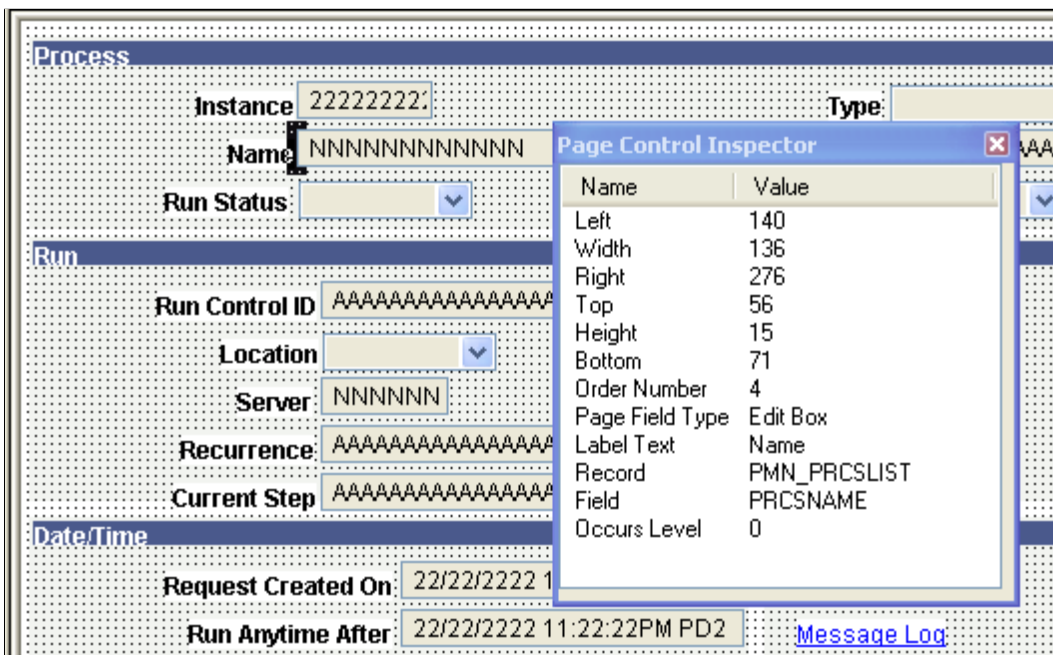

**Note:** The HTML that is generated for your page uses table layout, rather than pixel layout. You should preview how your page might look in the PeopleSoft Pure Internet Architecture as you design it. Spacing of fields at runtime may not appear exactly the same as during design time. While the Page Control Inspector displays values for a grid, no information is available for individual grid columns.

## Deleting Controls

If you remove a control from a page, look for other controls that are related to it, such as display controls or invisible controls used by PeopleCode. You may need to delete them as well or alter their attributes so that they can be standalone fields.

Check for PeopleCode that references this control on the page by opening the field definition and selecting View > Find Definition References. If any references exist, modify or delete them because the control no longer exists on the page.

To delete controls from a page:

1. Select the controls.

2. Select Edit > Clear.

## Moving Controls on the Same Page

To move controls to another position on the same page, use one of these methods:

- Select a control and drag it to the new position.
- Select a control and press the Up Arrow, Down Arrow, Left Arrow, or Right Arrow key.

The control moves one grid unit in the indicated direction.

- Select a group of controls and drag them to the new location.

## Moving Controls on Long Pages

Long pages are too big to be seen in their entirety in the definition workspace. Scroll bars appear on the right and bottom enabling you to move about the page. To move controls that appear in the visible area of the page to an area that is outside the visible area:

1. Select the set of controls by using Edit, Select Group.
2. Click and hold the set of controls.
3. Without releasing the mouse button, scroll the mouse wheel to move up or down the page.
4. Release the button to place the controls.
5. Save the page.

## Copying and Moving Controls to Another Page

To copy a single control to another page, drag the control from one page to the other. For a group of controls, you also can select the controls and use the copy and paste functionality.

To move a group of controls to another page, cut and paste the group onto the new page.

## Positioning Page Control Labels

PeopleSoft Application Designer enables you to change the relative position of most page controls and their labels. This section discusses how to:

- Move page control labels.
- Prevent translation buffer overlap.

### Moving Page Control Labels

To move page control labels, use one of these methods:

- Select multiple labels and either click one of the Align Label (*position*) buttons in the toolbar or select Layout > Align > Align Label (*position*).

PeopleSoft Application Designer aligns the selected labels based on the last label that you select. Alignment is based on the first letter, last letter, or middle letter of the labels; the translation buffer is ignored.

- Select the label and drag it to the new position on the page.
- Select the label and use a directional arrow key on the keyboard to move the label one grid unit in the indicated direction.
- Access the control properties dialog box, select the Label tab, and then select an option in the Position group box (the Location group box for radio button and check box controls). The Custom option is informational only; it does not move the label. All other options move the label to the selected position when you click the OK button.
- Click the Left label position button in the toolbar to move the label to the default left position of the page control.

---

**Note:** Select the control itself when you want to move both the control and its label and retain their relative positioning.

---

## Preventing Translation Buffer Overlap

Often, when you translate your own field labels, the label in the new language requires more space than the English label. When you create or modify pages, you need to accommodate this requirement by leaving additional space between the label and the field control. This space is called the translation buffer. If you do not account for the translation buffer during page design, labels and controls can overlap, which can interfere with readability after the translation.

PeopleSoft Application Designer automatically calculates the translation buffer size as 30 percent of the current label length + the length of 2 upper case 'Ns. The calculation uses the number of characters, but it ignores the individual character itself. The combined character length and translation buffer length is limited to 60 characters for static text labels, 30 characters for RFT\_LONG labels, and 15 for RFT\_SHORT labels.

Based on the calculation, a page control label appears with dashed lines that surround and extend beyond the label, visually indicating the appropriate translation buffer. PeopleSoft Application Designer appropriately moves and adjusts the translation buffer indicators whether you align your labels to the left, right, or center. For most page controls, the translation buffer indicators envelope only the label. However, the translation buffer indicators for push buttons and links enclose the entire control because these labels are embedded in the controls themselves. By default, PeopleSoft Application Designer resizes push buttons and links automatically to accommodate the combined length of the label and the translation buffer.

---

**Note:** Group box, grid, and scroll area controls do not display translation buffer indicators.

---

When you save a page, PeopleSoft Application Designer warns you if the page control label translation buffer overlaps a control. When you dismiss the warning dialog box, PeopleSoft Application Designer brings focus to the problematic page control. If more than one label is inappropriately positioned, the first one receives the focus. When your page contains no translation buffer overlaps, the page saves without warning.



**Note:** Translation buffer indicators appear even if you do not translate your labels. Translation buffer overlap, however, is inconsequential to English language pages.

### Example: Translation Buffer Indicators

In this example, you see the translation buffer indicators for seven page controls. The link and the push button demonstrate center label alignment. The Employee ID, Employment Status, and Flag for Review labels demonstrate left alignment. The Description and Option 1 labels demonstrate right alignment:

#### Image: Translation buffers indicators on several page control types showing different label alignment settings

This example illustrates the fields and controls on the Translation buffers indicators on several page control types showing different label alignment settings. You can find definitions for the fields and controls later on this page.

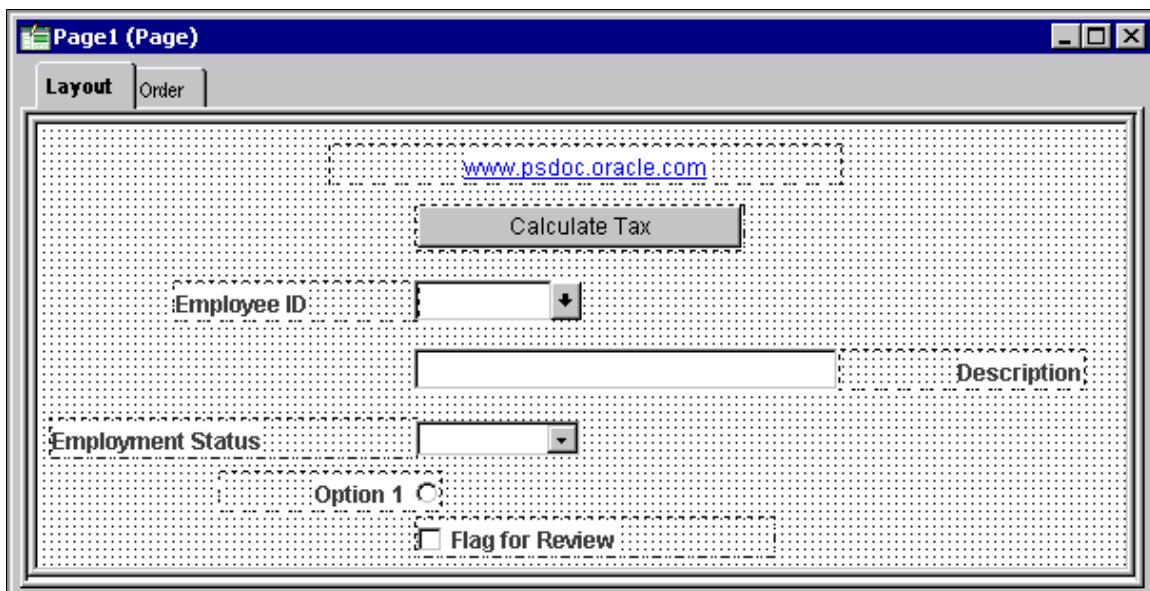

### Example: Translation Buffer Overlap

In this example, the Effective Date label maintains the translation buffer, but the Short Description label does not maintain the translation buffer and overlaps the associated edit box page control:

#### Image: Field labels demonstrating proper label positioning (Effective Date) and translation buffer overlap (Short Description)

This example illustrates the fields and controls on the Field labels demonstrating proper label positioning (Effective Date) and translation buffer overlap (Short Description). You can find definitions for the fields and controls later on this page.



## Setting Page Field Properties for Controls

For each page control that you add to a page you can control how it looks and functions in your application page by setting page field properties. In most cases, you access the property settings by double-clicking the control. Alternatively, you can highlight the control and select Page Field Properties from the Edit menu or the pop-up menu, which is activated by right-clicking the control.

This section discusses how to:

- Use the property window.
- Set record properties.
- Set label properties.
- Set use properties.
- Set general properties.
- Set option properties.

### Using the Property Window

Use the property window to view and update page field properties. The property window can be used in lieu of or in addition to using the page field properties dialog box.

#### Image: Property window for page field properties

In the following example, the property window displays the page field properties for the selected group box. In addition, the Type field has been selected illustrating that properties can be updated directly in the property window.

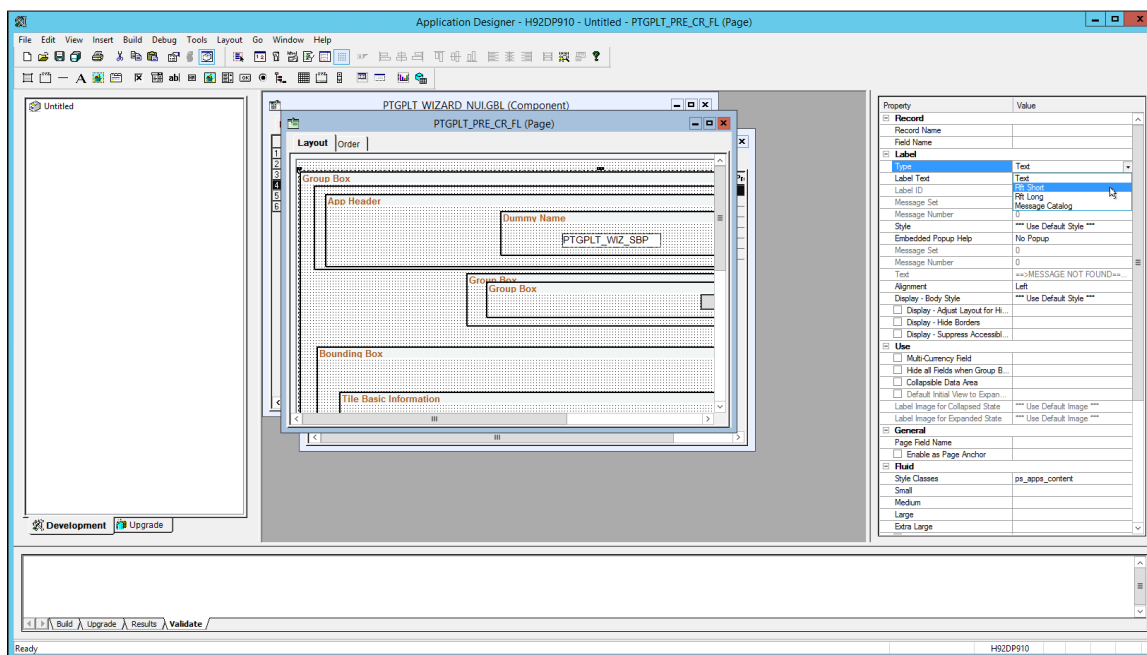

These operations affect the use and display of the property window:

- The property window is enabled by default.

To disable or re-enable the property window, select Tools > Options.... Then select the General tab. See [Setting PeopleTools Options](#).

- The property window is visible by default.

To hide or view the property window, select View > Property Window (Alt+2). Alternatively, to hide the property window when it's already visible, right-click anywhere on the property window, then select Hide from the pop-up menu.

- The property window is docked by default.

To make the property window undocked, right-click anywhere on the property window, then deselect Allow Docking from the pop-up menu. See “Dockable Windows and Toolbars” in [Configuring the Application Designer User Interface](#) for more information.

## Setting Record Properties

For most controls, you must set record properties to assign the control to a specific field in a record definition. No distinct correlation exists between the field types in a record definition and the controls in a page definition.

Use this table to select the appropriate page control type to associate with the corresponding field in your record definition:

<i>Record Definition Field Type</i>	<i>Page Definition Control Type</i>
Character	Edit box
Character (Yes or No Table Edit)	Check box Edit box
Character (Translate Table Edit)	Radio button Edit box Drop-down list box
Long Character	Long edit box, HTML area <hr/> <b>Note:</b> Do not associate Long Character fields to edit box controls; use a long edit box control. Associating a Long Character field to an edit box control can produce unexpected behavior on the page. <hr/>
Number	Edit box
Signed Number	Edit box
Date	Edit box
Time	Edit box

<b>Record Definition Field Type</b>	<b>Page Definition Control Type</b>
Datetime	Edit box
Subrecord	Not applicable <hr/> <b>Note:</b> A direct association to subrecords is not available. <hr/>
Image	Image

To set the record properties for a page control, access the page field properties for the control and select the Record tab:

**Image: Edit Box Properties dialog box: Record tab**

This example illustrates the fields and controls on the Edit Box Properties dialog box: Record tab. You can find definitions for the fields and controls later on this page.

The image shows the 'Edit Box Properties' dialog box with the 'Record' tab selected. The 'Record Name' dropdown is set to 'PERSON\_PRINAME' and the 'Field Name' dropdown is set to 'EMPLID'. The 'Style' dropdown is set to '\*\*\* Use Default Style \*\*\*'. The 'Fill Character' checkbox is unchecked. Under 'Size', 'Average' is selected. Under 'Alignment', 'Auto' is selected. The 'Family Name' and 'Display Name' fields are empty. The 'Display Options' section contains several checkboxes: 'Display Zero', 'Password', 'Show Prompt Button' (checked), 'Auto Fill', 'Display Time Zone', 'Input Only', 'Display Century', 'Currency Symbol', '1000 Separator', 'Auto Decimal', and 'Enable Spell Check'. The 'OK' and 'Cancel' buttons are at the bottom right.

**Note:** This section applies to both edit boxes and long edit boxes. Other controls may contain only a few, if any, of the properties listed in the following tables. Refer to the discussion of the specific control for more information.

**Record Name**

Select the record name of the record definition where the field is located. If you already added a field to your page and associated it with a record definition, the system uses the last record definition name that you entered.

**Field Name**

Select the field name. If the field is a related display field that contains a long name or short name from the Translate Table, use PSXLATDEFN as the record definition name. The field name is either a long name (30 characters) or a short name (10 characters).

**Style**

Set the font and color attributes of your control data. The default style class for an edit box is PSEDITBOX, which controls how the data portion of the edit box appears. Control the color, font, and other characteristics of an edit box by specifying a different style class.

---

**Note:** Certain browsers always display the background of an edit box as white.

---

See "Troubleshooting Browser Limitations" on Customer Connection.

**Size**

After you link a control with a record name and field, the system automatically calculates the page control size. The size is based on the length of the field that is defined in your record definition, the font metrics of the field style, and any formatting options (currency symbol, 1000 separators, and so on) that apply. Because many fonts have variable width characters (for example, a *W* character is wider than a *l* character) three size options are available.

---

**Note:** Some browsers do not support custom sizing for edit boxes, long edit boxes, drop-down list boxes, and push buttons.

---

See *Troubleshooting Browser Limitations* available on the My Oracle Support website.

**Average**

Select to provide sufficient space to display the field control length in average-width characters.

**Maximum**

Select to provide enough space to display the field control length in maximum-width characters.

**Custom**

Select to define a custom size for edit boxes that are not display-only. If you set a display-only edit box to *Custom*, it appears as its defined length. If your edit box is in a grid, this field wraps.

**Alignment**

Alignment indicates the runtime alignment of data within a page field. These settings have no affect on the relative alignment of page fields.

**Auto**

Select to left-justify the content of character fields and right-justify the content of number and signed number fields. This value is the default.

**Left**

Select to left-justify the content of a field.

---

**Note:** If the field is not display-only, the alignment is always left-justified. If the field is display-only, the system uses the alignment that you specify.

---

**Right**

Select to right-justify the content of the field. Do not use this option in the PeopleSoft Pure Internet Architecture for fields that are *not* display-only.

**Family Name**

Displays the current family name, which was set when the field was created, if it is applicable to your control.

**Display Name**

Select an option to override the display format that is associated with a field.

**Display Options****Display Zero**

Select if the content of the page control are numeric and you want to display a zero value instead of a blank field. Sometimes, seeing a zero helps users remember that a page control is not blank. For example, in a tax table you might show the lowest tax bracket as starting at zero instead of leaving it blank.

**Display Century**

Select for date fields to enable users to enter a date with a four-digit century, as in 1999. Dates are always stored with the four-digit century in the database, but only the last two digits appear unless you select Display Century. If this option is not selected, the century is automatically set to the century of your system date.

**Password**

Select to hide the value that is entered or displayed in a page control. When selected, characters in this control appear online as black dots.

The component processor stores the actual value, making it available for normal processing, such as PeopleCode.

Use this option for pages that capture sensitive information, such as personal identification numbers (PINs), passwords, and so on.

For more information on options for displaying sensitive field data, see [Protecting Sensitive Field Data Online](#).

**Currency Symbol**

Select to display a currency symbol in the field. This selection expands the display length of the field by the length of the currency symbol.

**Show Prompt Button**

Select to display a prompt button next to the edit box, which enables the user to look up valid values for that field.

**1000 Separator**

Select if the content of the page control is numeric and you want to insert thousand separators to make the numbers easier to read. The system automatically calculates the number of

thousand separators to insert and determines where they should be positioned. This selection expands the display length of the edit box by one character for each separator.

### **Auto Fill**

Select to have the system automatically populate the page control with the character specified in the Fill Character field. The direction in which it populates depends on the alignment that you select. If a field is left-aligned, then it populates from left to right. If a field is right-aligned, it populates from right to left.

For example, suppose that you define a six-character control as left-aligned, specify a fill character of *0*, and activate Auto Fill.

When you type *123* in the control online, the system displays *123000*. Similarly, if you changed the alignment to right, the system would display *000123*.

---

**Note:** Auto Fill can affect the actual value of the control, not just its visual representation.

---

### **Auto Decimal**

Select to insert a decimal point automatically if none is provided in the data that is entered into the control. Where the system inserts the decimal point depends on how you define the control.

For example, in a record definition if you define a numeric field with a length of *4.2* (allowing four characters to the left of the decimal and two to the right) and activate Auto Decimal, the system inserts a decimal at the second digit from the right. This option applies only to numeric field controls and affects the actual value of the field control, not just its visual representation.

### **Display Time Zone**

Select if you are setting the properties for a Time or a Datetime field and you want to display the related time zone. This setting helps users understand whether the time reflects the base time zone of the database or of some other time zone. This setting does not determine which time zone is actually used, only whether the time zone appears. The record field properties determine which time zone is used.

### **Input Only**

Select for edit boxes containing sensitive information that you want to protect by:

- Displaying only masked characters in the page field in the browser. (Black dots or asterisks, depending on the operating system and/or browser)
- Preventing the field value from being accessible in the page HTML.

The component processor stores the actual value, making it available for normal processing, such as PeopleCode.



Use this option for pages that capture sensitive information, such as personal identification numbers (PINs), passwords, and so on.

For more information on options for displaying sensitive field data, see [Protecting Sensitive Field Data Online](#).

## Enable Spell Check

For edit boxes and long edit boxes only, this option enables the user to check spelling on field content. This feature supports 17 languages using 36 dictionaries. Users have the option of selecting the appropriate dictionary to meet the language needs.

The behavior of this feature is as follows:

- **Design time behavior:** The default setting is deselected. When the Enable Spell Check check box is selected, the Show Prompt Button option is deselected and disabled; a field can either be spell checked or validated, but not both. Like the Look-Up button, the spell check button appears to the right of the field and is not visible on the page definition. Be sure to leave extra space to accommodate it when placing other fields on the page.
- **Runtime behavior:** The spell check button appears to the right of the edit box and at the upper right corner of a long edit box. Each click of the spell check button forces a transmission to the application server, opening the Spell Check page. The user then has the option to accept or reject the recommended spelling for the individual word or for all incidences of the term in the field. If no misspellings occur, a message box indicates so without leaving the current page. The Alt+5 hot key invokes spell check while cursor focus is on the spell check field.

The spell check feature uses the current session language when applying a foreign language dictionary, unless the user changes it by means of Personalizations. The system uses PSLANGUAGES to provide the SCLANG default for each supported session language.

## Fill Character

Enter a character to replace blank spaces in an edit box when the system displays the content of the field. For instance, if the length of a Net Pay field is 8.3 and you specify a fill character of \*, then a value of \$1,250 appears as:

```
*****$1,250.000
```

You can use any character as a fill character.

## Example: Auto Decimal

This table shows how the Auto Decimal option affects a numeric field control with a length of 4.2, depending on what you enter online:

<b><i>Entered</i></b>	<b><i>Displayed</i></b>
100	1.00
100.	100.00
1	0.01

## Setting Label Properties

The Label tab enables you to set the label that appears on a control. This label can be the long or short name that is specified in the record definition or in other text. Use this tab to verify the label ID that is used as the internal reference.

Access the page field properties for the control and select the Label tab.

**Image: Edit Box Properties dialog box: Label tab**

This example illustrates the fields and controls on the Edit Box Properties dialog box: Label tab. You can find definitions for the fields and controls later on this page.

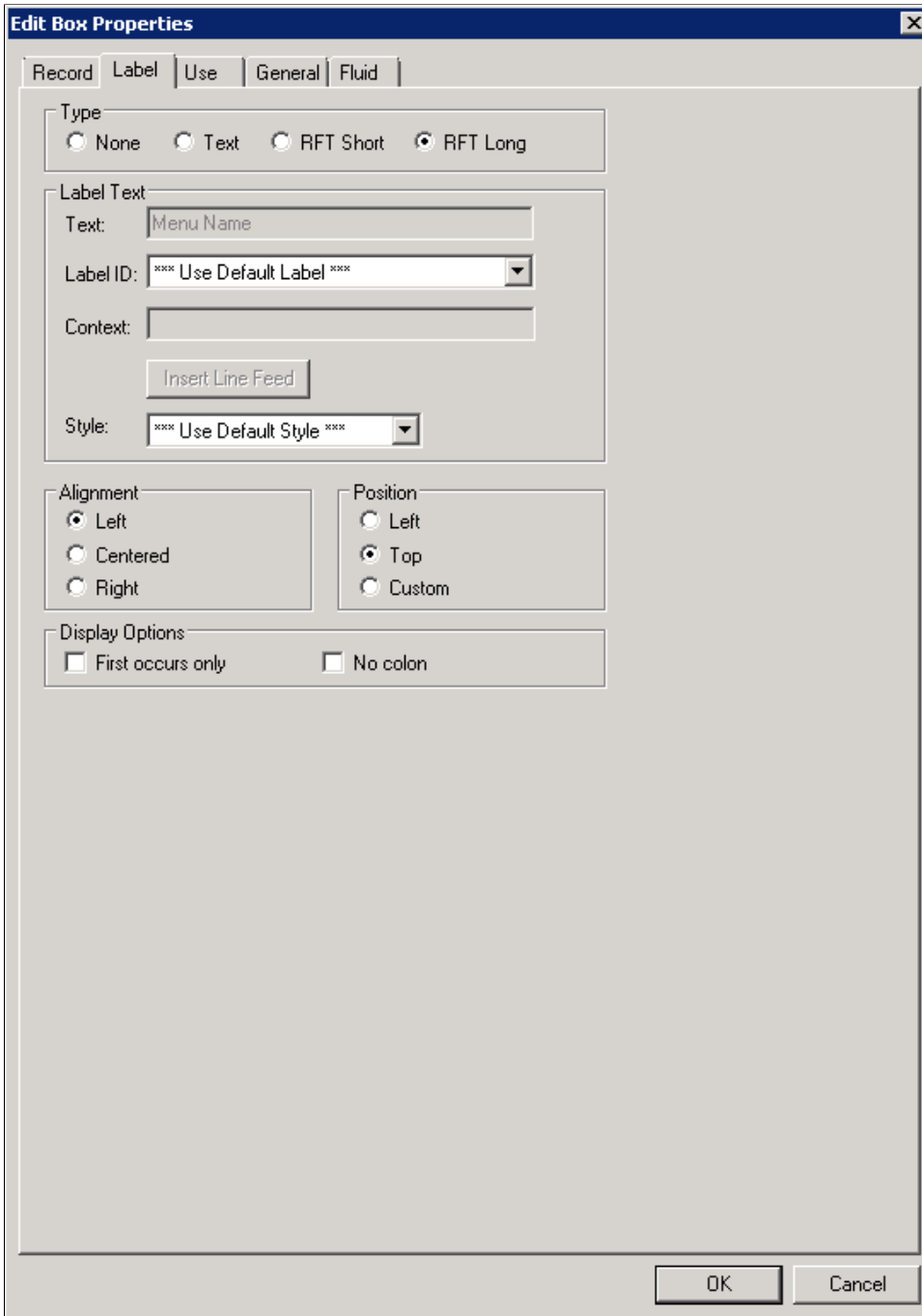

---

**Note:** This section applies to the following controls: edit boxes, long edit boxes, check boxes, drop-down list boxes, group boxes, radio buttons, and static text.

---

## Type

Select the type of label. If you want the label to remain blank, you must first set up a blank label in the field definition that you are using. The blank label then appears as an option in the Label ID drop-down list box.

### None

Select to display no control label on the page. Use this option for controls such as related displays.

### Text

Select to display text that you enter in the Text field. The default text is the long name for the field from the associated record definition.

For translation purposes, avoid using this option if possible.

### RFT Short (record field table short)

Select to display the RFT short name for the field from the associated record definition.

### RFT Long (record field table long)

Select to display the RFT long name for the field from the associated record definition. This value is the default.

## Label Text

### Text

Enter the text exactly as it should appear on the page. The default is *Dummy Name* until you assign a record and field to the control. This field is only enabled if you selected Text as the type. Otherwise, the system displays the label text assigned to the field for the Label ID you select.

### Label ID

Select from the drop-down list box the label you want to appear for the page field. The available choices are based on the Label ID column and the Long Name column for the selected field definition.

The default setting for this option is *Use Default Label*. This default is determined by the label you select as the default for the field definition.

### Context

Displays text to assist the translation team determine the context of the field label to be translated. The context is determined by the field name and label ID combination. If no contextual information exists in the database, then no text appears in this field.

This property appears on edit box, long edit box, drop-down list box, push button, image, chart, tree, group box, and check box page controls.

Application users define the contextual information on the Context Information page. See "Providing Context Information" (PeopleTools 8.58: Global Technology).

### Insert Line Feed

Click to split your control label into multiple lines at the position of the cursor in the Text field. A thick vertical bar

character appears in the Text field. When you close the properties dialog box, the label is split into multiple lines. This option is only active when you select *Text* for the type.

### Style

Select an option to control the color, font, and other characteristics of a label. If you do not select a label style that is different than the default, *Use Default Style*, then the system uses the label style specified on the style sheet on the PeopleTools Options page.

## Alignment

The label alignment in the page field properties controls the alignment for both page fields placed on a page and page fields as grid columns. For a grid column, the label becomes the column heading and is aligned within the column boundaries as specified by this attribute, either left, centered, or right.

**Left** Select to align the label to the left-of-center horizontally. This value is the default.

**Centered** Select to center the label horizontally.

**Right** Select to align the label to the right-of-center horizontally.

---

**Note:** By default, the system uses left label alignment. To make all new page field labels use right label alignment (design time), set the Right Align Field Labels check box on the PeopleTools Options page.

---



---

**Note:** Push buttons with images or text are automatically center aligned when in a grid. Push buttons with images or text are automatically left aligned when *not* in a grid.

---

## Position

These position options are available for edit boxes, long edit boxes, and drop-down list boxes only.

**Left** Positions label immediately adjacent to the left side of the field. Left is the default position of the label for fields newly added to the page. If you move the label on the page from the left position, PeopleSoft Application Designer changes the selection to Custom.

**Top** Positions label above the field. Selecting this option automatically moves the label to the top of the field. If you later move the label on the page from the top position, PeopleSoft Application Designer changes the selection to Custom.

**Custom** Indicates that the label was manually moved on the page. Labels can be adjusted using the keyboard arrows. Selecting this option does not automatically move the label on the page.

See [Positioning Page Control Labels](#).

To set labels to the left position for individual page fields:

1. Select the control that you want to affect.

2. Select Layout > Left Label Position.

The Left Label Position option is only enabled if the label is set to the custom position. The system moves the label for the selected control to the left position. The position indicator in the page field properties does not change from *Custom*. Note that you may need to readjust the positioning of other fields and labels to accommodate this change.

---

**Note:** If you move a page field label manually on the page, the label position in the page field properties dialog box automatically updates to *Custom*.

---

## Display Options

### First occurs only

Select to display the label only with the first occurrence of a child page field in a scroll area.

### No colon

Select this option if you do not want a colon to appear at the end of the label text. This option is selected by default for edit boxes and long edit boxes.

## Special Label Considerations

If you add a related display page control with a label type of *None*, enter an information-only label that identifies the related field but that is not identical to the label on the control field. A little documentation now can save you time in the future if you modify this page again. For example:

<b>Control Label</b>	<b>Related Field Label (Information-Only)</b>
Department	Department Description
Jobcode	Jobcode Description
Regular/Temporary	Regular/Temporary XLAT (XLAT is from the Translate Table)

When defining labels for columnar controls in a multi-occurrence scroll, you can apply several techniques. The first technique is to select First occurs only. This selection limits the appearance of the label to the first scroll occurrence on the control, allowing the label to be used as a column heading. The second technique is to select *No colon* to omit the colon from the label (column headings typically do not need a colon).

## Setting Use Properties

The Use tab defines how a field functions on a page. Use this tab to disable or hide fields; to define the display and related control fields and the processing of the control; and to define a field as a mouse over pop-up field.

Access the page field properties for the page control and select the Use tab.

### Image: Edit Box Properties dialog box: Use tab

This example illustrates the fields and controls on the Edit Box Properties dialog box: Use tab. You can find definitions for the fields and controls later on this page.

The screenshot shows the 'Edit Box Properties' dialog box with the 'Use' tab selected. The dialog is titled 'Edit Box Properties' and has a close button (X) in the top right corner. The 'Use' tab is active, showing various options for field behavior. The 'Field Use Options' section includes checkboxes for 'Display Only', 'Invisible', 'Show Label', 'Modifiable by JavaScript', 'Enable When Page is Display Only', 'Generate in HTML', 'Multi-Currency Field', 'Display Control Field', and 'Related Field'. There is also a 'Persist Grid Column in Menu' checkbox. Below this is a 'Related Control Field' dropdown menu. The 'Popup Menu' section has a dropdown menu. The 'Allow Deferred Processing' and 'Set Component Changed' checkboxes are checked. The 'Display-Only Appearance' section has radio buttons for 'Text Only' (selected) and 'Disabled Edit Control'. There are also checkboxes for 'Paragraph' and 'Wrap Long Words'. The 'Mouse Over Popup' section has radio buttons for 'No Popup', 'Page Popup' (selected), and 'Message Catalog Popup'. Below this are input fields for 'Message Set/Number' (0, 0) and a 'Text' field. The 'OK' and 'Cancel' buttons are at the bottom right.

**Note:** These controls contain the same or similar use properties: edit boxes, drop-down list boxes, check boxes, images, long edit boxes, push button/hyperlinks, and radio buttons.

### Field Use and Other Options

Note that long edit boxes have slightly different field use options.

**Display Only**

Select to prevent users from modifying the content of the control during application data entry. The system automatically selects Display Only when you select Related Field.

**Invisible**

Select to make the control physically present on a page but invisible to users. Typically, you add an invisible control because it is required for a PeopleCode program that is associated with the page. An invisible control can also be used as a display control field.

When you select the Invisible check box, the Show Label, Modifiable by JavaScript, and Enable When Page is Display Only fields are enabled.

**Show Label**

Select to make the control label visible while the control itself is invisible. This option is useful if you add an invisible display control field to a page to show its related description. Show Label is enabled only if Invisible is selected.

---

**Important!** The Show Label option is not supported for page controls on fluid pages.

---

**Modifiable by JavaScript**

This feature is security related and should *always* be deselected unless you are familiar with modifying an invisible field using JavaScript in an HTML area. If the Invisible check box is deselected, then Modifiable by JavaScript is deselected and unavailable for entry. If the Invisible check box is selected, then the Modifiable by JavaScript check box is deselected by default.

**Enable When Page is Display Only**

Select to enable hyperlink actions on read-only pages. This check box is active when the Invisible check box is selected. This check box is deselected by default.

---

**Note:** This property appears on Edit box, Long Edit box, and Image controls.

---

**Generate in HTML**

Select to generate an invisible field (hidden field) on the HTML page sent to the browser where it can be manipulated by JavaScript in the browser.

Only use this option if you are familiar with modifying an invisible field using JavaScript due to potential security concerns.

This check box is active only when the Invisible check box is selected. This check box is deselected by default.

If you want the application server to update the invisible field with data sent back from the browser, in addition to having the Generate in HTML check box selected, also make sure to select the Modifiable by JavaScript check box.



This option is available for edit boxes, long edit boxes, check boxes, radio buttons, and drop-down list boxes (only list boxes with a single value for selection).

**Expand Field when Page is Display Only**

Select to automatically resize a disabled (display-only) long edit box so that all text within the field is visible at runtime. The field automatically enlarges to accommodate text. This check box is deselected by default. When selected, this option enables the Wrap Long Words option.

**Multi-Currency Field**

Select to identify the control as associated with multi-currency processing. This selection causes the field to appear at runtime only if Multi-Currency is selected on the PeopleTools Options page.

**Display Control Field**

Select to indicate that the field controls another field at the same page level. The controlled field is a related field. For example, on many pages Department ID is the display control field and Department Name is the related field. The system uses Department ID to retrieve Department Name from the Department table to display on the page.

**Related Field**

Select to specify that the content of this control is controlled by another field on the same page level, one that you selected as a display control field. When you select this check box, the system automatically selects the Display Only option. It also makes the Related Control Field drop-down list box available for you to select the related control field.

When you select Related Field, Display Only is automatically selected. If the related field is located on a record definition with multiple keys, relate the display field to the lowest order key field that both record definitions have in common, with the exception of EFFDT and EFFSEQ, in the control record definition. The system searches for the higher order keys by matching field control names on the current level and all higher levels for the other keys.

If the related display field contains a long name or short name from the Translate Table, use PSXLATDEFN as the record definition name.

**Enable When Page is Display Only**

Select this check box to enable the user to select radio buttons and check boxes on runtime pages to perform certain tasks and processes despite the entire page being in display-only mode.

---

**Note:** This property appears on Check Box and Radio Button controls only.

---

**Paragraph**

The Paragraph property applies only to these page field controls:

- Static Text
- Edit Box

- Long Edit Box

If Paragraph is selected, PeopleTools generates a text field for the supported controls and inserts the page field content within a paragraph tag (<p>), rather than a span tag (<span>). Content within a paragraph tag is easier to access with screen reading devices.

The Paragraph property applies to classic and fluid applications. For classic pages, PeopleTools generates a paragraph tag if the Paragraph property is selected *or* the controls have one of the following styles applied:

- PAPAGEINSTRUCTIONS
- PAADDITIONALINSTRUCTIONS
- PAADDITIONALINSTRUCTDISABLED
- PAADDITIONALINSTRUCTACTIVE
- PAERRORETEXT
- PSTEXT

PeopleTools suppresses any label generation for the paragraph fields; field values are generated, but field labels are omitted.

PeopleTools ignores the Paragraph property in these conditions:

- Rich Text Editor is enabled.
- The field is not set as display only.
- The field is disabled using PeopleCode. When using PeopleCode, PeopleTools ignores the Paragraph property if the Disabled property is set instead of the DisplayOnly property.
- In the case of long edit boxes, the Paragraph tag can be selected in Application Designer only if the Expand Field When Display Only property is also selected.

## Wrap Long Words

Select to wrap long words that do not contain spaces, such as long URLs, in a page field at runtime for Microsoft Internet Explorer only. The word wraps to the length of the field set at design time. Other browsers automatically stretch the width of the page to accommodate the longer text. This option has no effect at runtime to applications running on browsers other than Microsoft Internet Explorer. This setting is deselected by default.

The Wrap Long Words option is available for edit boxes, long edit boxes, and drop-down list boxes only. You can apply it to standalone page fields and grid columns. For edit boxes and drop-down list boxes, this option is disabled if Disabled Edit

Control is selected. For long edit boxes, this option is available only if the Expand Field When Display Only option under Field Use Options is selected.

---

**Note:** The system does not restrict an edit box or drop-down list box that is configured as Display Only and Text Only to one line of height. The text is wrapped to the next line as necessary. Also, the Wrap Long Words property does not affect the word wrapping behavior of shorter words that can be accommodated by the page field size at runtime. This text automatically wraps at word boundaries in accordance with the page field size, regardless of whether this option is set.

---

### Persist Grid Column in Menu

---

**Important!** Persistent search, the drop-down menu, and other forms of classic navigation are no longer supported. The default navigational interface for PeopleSoft applications in the current release is based on the fluid banner, which can be used for both classic and fluid applications.

---

Select to include the field as a list box item in the persistent search results grid. You must also select the Persist in Menu grid property for the grid that contains the field.

---

**Note:** This property applies only to fields that appear in grids on pages that are used as custom, application-specific search pages.

---

This property is disabled on check boxes and radio buttons.

You must enable recent search results caching at the system level in the web profile for this property to take effect.

### Related Control Field

When you select Related Field, a list of all controls on the page that are marked as display control fields appears in this drop-down list box. Select the field to which this control is related.

You must define the use of the initial control field before it appears as an option in the Related Control Field drop-down list box. For example, after the Pay Group field is designated as a display control field, it appears in the Related Control Field drop-down list box for the control that you set as the related field.

---

**Note:** The number that appears before each entry in the Related Control Field drop-down list box is the page field order number associated with that entry.

---

### Set Component Changed

Enables the system to issue a save warning for the field if the user changes the value and attempts to exit the page before saving. This setting reinforces current save warning behavior. This option is set by default for edit boxes, long edit boxes, radio buttons, check boxes, and drop-down list boxes. Deselecting this option overrides the save warning that normally appears to users. The user will not see a save warning after

changing the value of the field and attempting to exit the page.

An example of when this might be necessary is for a drop-down list box that includes links to another page. If the user selects a link from this field to transfer to another page but has not made any other changes to the page, then the system should not issue a save warning.

By deselecting the Set Component Changed flag, you indicate that no save warning message is issued for this field. This option works for fields associated with a derived work field or database record field.

For the push button/hyperlink control, the default setting is deselected instead of selected, unlike most other page controls.

### Allow Deferred Processing

Deselect this option to allow this field to operate in interactive mode. Typically, set a field to interactive only if you want to perform a server trip for an action that can be deferred otherwise—for example, to execute FieldEdit or FieldChange PeopleCode, when data is entered in a field with a prompt table edit, or in a field with a related display.

The setting of this field is ignored if either the page or the component is set to run in interactive mode. See [Understanding Processing Modes](#) for more information.

---

**Note:** The default setting is selected.

---

### Display-Only Appearance Option

The Display-Only Appearance option attributes, Text Only option, and Disabled Edit Control option apply only to edit boxes and drop-down list boxes. These properties, in conjunction with other attributes you apply to the field, such as Display Only on the Use tab, or the Gray function or the Enabled property in PeopleCode to disable the field, and whether or not the field is in a grid control the base style that the system uses to render these controls at runtime.

The default base style for a normal edit box, meaning editable and enabled (as opposed to display-only or disabled), is PSEDITBOX. The default base style for drop-down list boxes is PSDROPDOWNLIST. The base style then changes depending on the attributes that you select and where you place your field, as shown by the default base style examples in the following table.

If you choose a custom base style for the field on the Record tab of the control properties, then the system uses the associated display-only and disabled variants of the style as appropriate to create the additional looks. For example, if you select *XYZ* base style and set the field as display-only, then the related *XYZ\_DISPONLY* style is used if it exists; otherwise, the base *XYZ* style is used.

<b>Display-Only Appearance Option</b>	<b>Normal Edit Field</b>	<b>Display-Only Edit Field</b>	<b>Disabled Edit Field</b>
Text Only	<i>Non-Grid:</i> PSEDITBOX <i>Grid:</i> PSEDITBOX	<i>Non-Grid:</i> PSEDITBOX_ DISPONLY <i>Grid:</i> PSEDITBOX_ DISPONLY	<i>Non-Grid:</i> PSDISABLED <i>Grid:</i> PSEDITBOX_ DISPONLY
Disabled Edit Control	<i>Non-Grid:</i> PSEDITBOX <i>Grid:</i> PSEDITBOX	<i>Non-Grid:</i> PSDISABLED <i>Grid:</i> PSDISABLED	<i>Non-Grid:</i> PSDISABLED <i>Grid:</i> PSDISABLED

Note that for Text Only disabled edit boxes using the default PSEDITBOX base style, the system applies PSDISABLED to non-grid fields and PSEDITBOX\_DISPONLY to fields in a grid. As a result, these fields render differently at runtime, as shown in the following example. If the field is outside of a grid, for example, selecting the Display Only field use option with the Text Only appearance option displays the field value as disabled text within a grayed border, whereas if the field is located in a grid with the same attributes, the field value renders as display only text without a border.

**Image: Example of Display-Only Appearance settings at runtime using the base PSEDITBOX style**

This example illustrates the fields and controls on the Example of Display-Only Appearance settings at runtime using the base PSEDITBOX style. You can find definitions for the fields and controls later on this page.

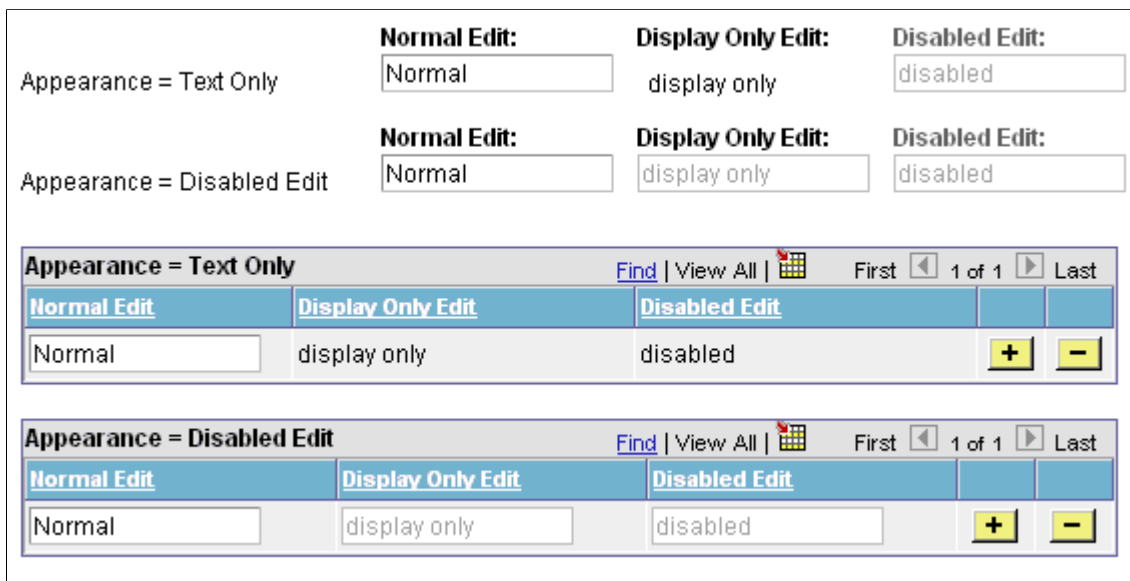

See [Default Style Classes](#).

**Note:** Depending on the style sheet that your application uses, the appearance of your pages and fields might deviate slightly from the appearance of the page and fields in the previous example.

### Mouse Over Popup Options

Select the Display Only check box to enable the Mouse Over Popup options. Select from these mouse over pop-up options:

<b>No Popup</b>	Select to have no pop-up page. This value is the default.
<b>Page Popup</b>	Select to associate the edit box with a pop-up page that you choose from the drop-down list box. Only pop-up pages appear in the Page Popup drop-down list box.
<b>Message Catalog Popup</b>	Select to associate this edit box with a pop-up page that displays a message from the message catalog. You can design and implement message catalog pop-up pages to be context sensitive.  See <a href="#">Enabling Message Catalog Pop-up Pages</a> .  See "Message Catalog" (PeopleTools 8.58: System and Server Administration).
<b>Message Set/Number</b>	Enter the message set number and the message number of the message whose text you want to appear in the pop-up window.
<b>Text</b>	This field displays the message of the message catalog entry that you enter in the message set/number fields.

---

**Note:** If you associate a mouse-over pop-up page to an edit box, then do not attempt to make the edit box editable at runtime, for example by using PeopleCode; the operation will fail.

---

## Setting General Properties

The General tab enables you to specify an optional internal page field name that is referenced by the page.

Access the page field properties for the control and select the General tab.

**Image: Edit Box Properties dialog box: General tab**

This example illustrates the fields and controls on the Edit Box Properties dialog box: General tab. You can find definitions for the fields and controls later on this page.

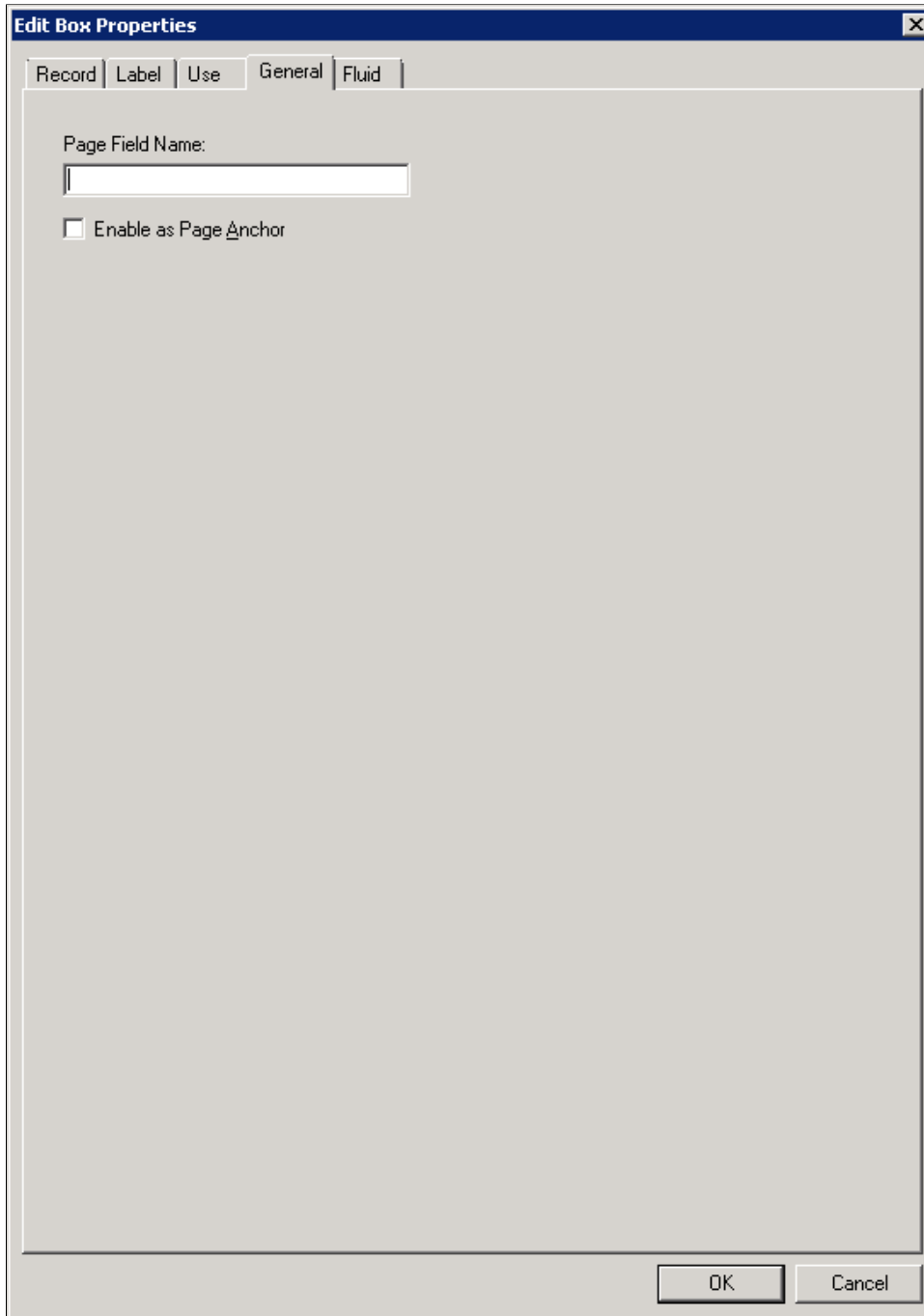

---

**Note:** For most controls, the General tab contains only the Page Field Name and Enable as Page Anchor settings. Grids and scroll areas have additional settings on the General tab that are described later. The Enable as Page Anchor check box is available for all controls that have a page field name.

---

**Page Field Name**

Enter a name for the page field that you are creating. This is a system-only setting. It does not appear as the label for the page

field. The page field name enables you to refer to a particular field on a page using PeopleCode.

This setting is optional unless you select the Enable as Page Anchor check box.

### **Enable as Page Anchor**

Select to apply an anchor tag to the current page field on the page. If you select this check box, you must add a page field name to identify this field when setting the related control for the link. This check box is deselected by default.

See [Specifying Type Properties for Push Buttons or Links](#).

## **Setting Options Properties**

The Options tab enables you to add rich text editing capabilities to the long edit box.

Access the page field properties for the long edit box page control and select the Options tab.

---

**Note:** This section applies to long edit boxes only.

---



### Image: Long Edit Box Properties dialog box: Options tab

This example illustrates the fields and controls on the Long Edit Box Properties dialog box: Options tab. You can find definitions for the fields and controls later on this page.

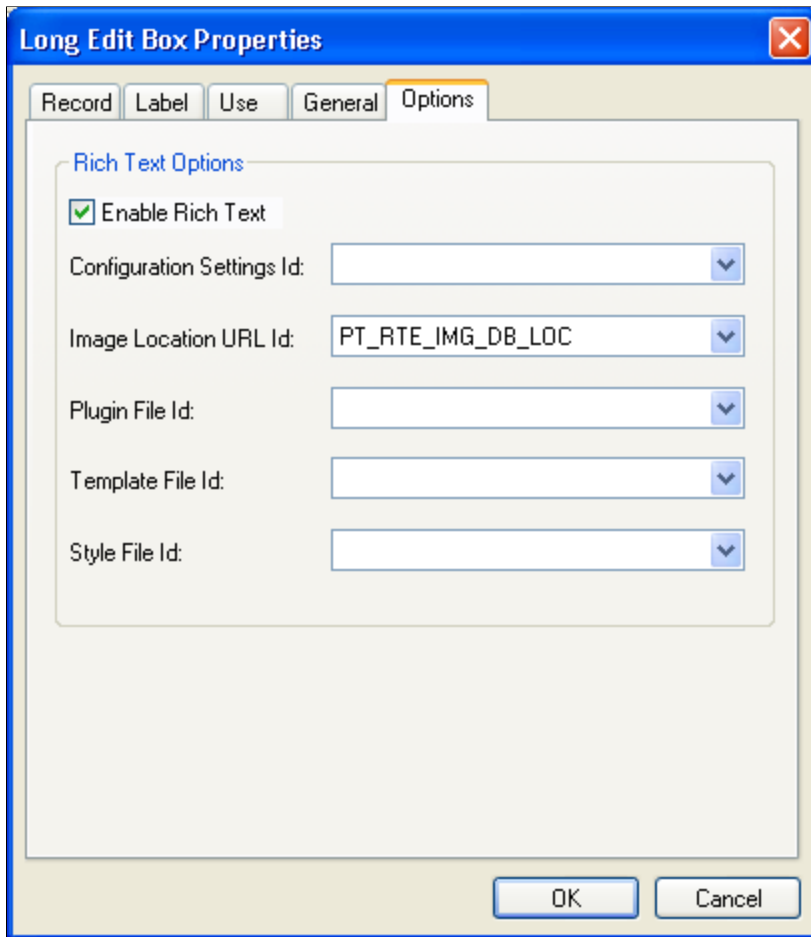

---

**Note:** At design time, standard long edit boxes and rich text-enabled long edit boxes look the same.

---

#### Enable Rich Text

Select to enable rich text editor functionality for the long edit box. Selecting this check box enables the remaining fields on this tab.

---

**Note:** When you select this option the Multi-Currency and Wrap Long Words properties on the Use tab are disabled; and the Allow Deferred Processing property on the Use tab is selected and disabled.

---

#### Configuration Settings Id

Select a value to use a custom configuration file that modifies the editor toolbar. By default, this field is blank and the system uses the default configuration file with the default toolbar settings.

HTML definitions that are prefixed with *PT\_RTE\_CFG* appear in this drop-down list box.

See [Creating Custom Configurations](#).

### Image Location URL Id

Select a value to indicate the storage location of any images inserted as part of the text in the long edit box. The default value for this field is the *PT\_RTE\_IMG\_DB\_LOC* URL.

URL IDs that are prefixed with *PT\_RTE\_IMG* appear in this drop-down list box. The URLs must be stored in the application by using the URL Maintenance page.

See "URL Maintenance" (PeopleTools 8.58: System and Server Administration).

---

**Note:** The URL format for file attachments stored in the database is record://RECORD\_NAME—for example, record://PTRTDB.

---

### Plugin File Id

Select a value to enable plug-ins for this instance of the rich text editor. By default, this field is blank.

HTML definitions that are prefixed with *PT\_RTE\_PLUGIN* appear in this drop-down list box.

### Template File Id

Select a value to enable an alternative template definition for this instance of the rich text editor. By default, this field is blank.

HTML definitions that are prefixed with *PT\_RTE\_TMPL* appear in this drop-down list box.

### Style File Id

Select a value to enable an alternative style sheet definition for this instance of the rich text editor. By default, this field is blank.

HTML definitions that are prefixed with *PT\_RTE\_STYLE* appear in this drop-down list box.

## Data Conversion Considerations

The rich text editor is an HTML editor that converts rich text to HTML, which the application stores in the database. When you access your data, the editor decodes the HTML at the time that it appears on the transaction page. Existing data is stored as plain text, which can cause unexpected warnings the first time the data is accessed after rich text support is enabled on a long edit box page field. Your test plan should include either updating the data to prevent the warnings or communicating with users to expect this warning.

To update the data, you must access the page; change the data in some way, such as adding a Space; and then save the component. The editor automatically encodes and updates the data.

---

## Modifying the Rich Text Editor User Interface

The rich text editor extends the capability of a long edit box so that, at runtime, it can display rich text as you see here:

### Image: Runtime long edit box showing rich text functionality

This example illustrates the fields and controls on the Runtime long edit box showing rich text functionality. You can find definitions for the fields and controls later on this page.

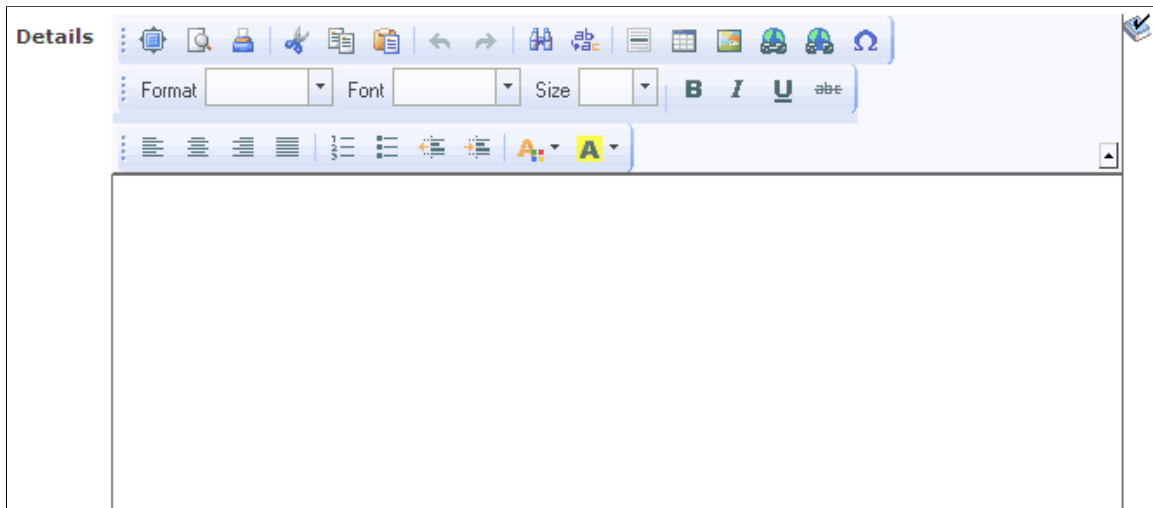

The rich text editor enables you to add rich formatting of text content, including common structural treatments such as lists; formatting treatments such as bold, underline, and italic text; drag-and-drop inclusion; paste-as-text; and sizing of images. The rich text editor toolbar is extensible through the use of HTML definitions that define your configuration, which enables you to design and implement an interface that is specific to the needs of your users.

This section discusses how to:

- Create custom configurations.
- Create custom templates.
- Create custom styles.
- Create custom plug-ins.
- Modify the default image storage location.

---

**Important!** Use caution when modifying the rich text editor interface; it is recommended that you never include or enable the Source button in the toolbar.

---

### Related Links

"Working With Rich Text Editor Fields" (PeopleTools 8.58: Applications User's Guide)

## Securing CKEditor

By default, CKEditor files can be accessed without authentication on the web server. Oracle recommends that after your PeopleSoft Internet Architecture installation, you make sure to secure any files or folders at the web server level as needed. To secure CKEditor files, security has to be setup at web server level. How you configure this security varies according to your web server product.

For information on implementing security on Oracle WebLogic see "Securing Servlets on WebLogic" (PeopleTools 8.58: System and Server Administration)

## Creating Custom Configurations

The default configuration filename is *config.js*. You can locate this file in the *PIA\_HOME\webserv\domainname\applications\peoplesoft\PORTAL.war\sitename\ckeditor* directory.

To create a custom configuration:

1. Copy the code in the config.js file.
2. Open Application Designer and create a new HTML definition.
3. Paste the code into the HTML definition.
4. Save the HTML definition. Prefix the definition name with *PT\_RTE\_CFG* for example, *PT\_RTE\_CFG\_MYCONFIG*.

---

**Note:** Only HTML definitions with the *PT\_RTE\_CFG* prefix appear in the Configuration Settings Id drop-down list box.

---

5. Modify the code in the HTML definition as necessary and save. The code might look like this example:

```
CKEDITOR.editorConfig = function( config )
{
    config.toolbar =
    [
        ['Templates', 'Styles', 'Cut', 'Copy', 'Paste', 'Bold', 'Italic', 'Underline', 'Strike',
        'e'],
    ];
};
```

In this example, the Cut, Copy, Paste, Bold, Italics, Underline, and Strike buttons and the newly created custom templates and the styles appear in the toolbar at runtime.

6. To use the new configuration, open the Long Edit Box Page Field Properties dialog box; select the Options tab; click the Configuration Settings Iddrop-down list box; and then select the HTML definition name from the list of values that appear.

See [Setting Page Field Properties for Controls](#).

## Creating Custom Template Files

The rich text editor delivers templates that help you format the text in predetermined ways. The default template file is *default.js*. You can locate this file in the *PS\_HOME\webserv\domainname\applications\peoplesoft\PORTAL.war\sitename\ckeditor\plugins\templates\templates* folder.

To create a custom template file:

1. In Application Designer, create an HTML definition and save it as `PT_RTE_TMPL_TEMPLATE`. The definition name should always be prefixed with `PT_RTE_TMPL,_` and the HTML must include 'pt\_rte\_template' as you see in this example:

```
CKEDITOR.addTemplates('pt_rte_template',{imagesPath:CKEDITOR.getUrl(CKEDITOR.p⇒
lugins.getPath('templates')+templates/images/),templates:[{title:'Image and ⇒
Title',image:'template1.gif',description:'One main image with a title and text⇒
, which surrounds the image.',html:'
<h3><img style="margin-right: 10px" height="100" alt="" width="100" align="lef⇒
t"/>Type the title here</h3>
<p>Type the text here</p>'}}]);
```

---

**Note:** The name 'pt\_rte\_template' is the fixed name, which has to be set for any custom template that you create. The template name should be exactly the same as mentioned above.

---

Save the HTML definition.

---

**Note:** It is recommended that if you create a custom template file, that you create a custom configuration file for it to reference.

---

2. To use the new configuration, open the Long Edit Box Page Field Properties dialog box; select the Options tab; click the Template File Iddrop-down list box; and then select the HTML definition name from the list of values that appear.

See [Setting Page Field Properties for Controls](#).

3. Click the OK button.
4. Save the page definition.

---

**Note:** When associated to a long edit box, all templates in an HTML definition are available to all users. To limit the available templates for specific rich text enabled long edit boxes, create a new template HTML definition to contain only the templates that you would like for the application user to see and associate that definition to the field.

---

## Creating Custom Style Files

The rich text editor delivers styles to assist you in entering data using specific styles that combine color, font and format. The default configuration file is `default.js` and is in the `PIA_HOME/webserv/.../styles` folder.

To create a custom style file

1. In Application Designer, create an HTML definition and save it as `PT_RTE_STYLE_MYSTYLE`.

The HTML Object name used for defining styles should always be prefixed by `PT_RTE_STYLE`.

This is sample code for an HTML style definition:

```
CKEDITOR.stylesSet.add( 'pt_rte_style', [{name:'Blue
Title',element:'h3',styles:{color:'Blue'}}]);
```

---

**Note:** In this style example, the name 'pt\_rte\_style' is the fixed name, which has to be set for any custom style that you create. The style name should be exactly the same as mentioned above.

---

2. To use the new configuration, open the Long Edit Box Page Field Properties dialog box; select the Options tab; click the Style File Iddrop-down list box; and then select the HTML definition name from the list of values that appear.

See [Setting Page Field Properties for Controls](#).

3. Click the OK button.
4. Save the page definition.

---

**Note:** When associated to a long edit box, all styles in an HTML definition are available to all users. To limit the available styles for specific rich text enabled long edit boxes, create a new style HTML definition to contain only the styles that you would like for the application user to see and associate that definition to the field.

---

## Creating Custom Plug-In Files

A plug-in enables you to create an application-specific toolbar button.

See the topic “Creating Custom Plug-In Files for the Rich Text Editor.”

## Modifying the Default Image Storage Location

By default, when you upload images the system stores them in the PTRTDB table. The default URL ID is PT\_RTE\_IMG\_DB\_LOC. To create a different storage location and URL ID, follow these steps:

1. Create a new record definition.
2. Insert the *FILE\_ATTDET\_SBR* subrecord.
3. Save and then build the record definition.
4. Clone these record definitions:
  - PTRTDB\_BMP
  - PTRTDB\_GIF
  - PTRTDB\_JPG
5. Save the record definitions, name them like this: <myrecord>\_BMP, <myrecord>\_GIF, and <myrecord>\_JPG.
6. For each record, open the SQL Editor and change the FROM statement in the SQL to this:
 

```
FROM PS_<your record name from step 3>
```
7. Save and build each view.

---

**Note:** FTP storage is not supported.

---

**Note:** It often will require end users to refresh a page or access it twice in order to display an image in a rich text editor field after the following events: browser cache has been cleared, web server cache has been cleared, the posting using the rich text editor field (such as a job posting) is new.

---

## Creating Display Control and Related Fields

This section discusses how to:

- Use display control and related fields.
- Create related edit fields.
- Create invisible control fields.

## Using Display Control and Related Fields

A related display field is for display purposes only—it always references a row that's not being updated from the current page. The display control and related display fields must both be at the same level. In the Work Location page, the Regulatory Region, Company, Business Unit, Department, and Location fields all show related display fields to their right. Search level fields, such as those shown above the Work Location group box, are display-only fields.

### Image: Work Location page

This example illustrates the fields and controls on the Work Location page. You can find definitions for the fields and controls later on this page.

The screenshot displays the 'Work Location' page for employee Caroline SABBARICH. The page is divided into several sections:

- Employee Information:** Caroline SABBARICH, Employee, Empl ID: GF100ME280, Empl Record: 0.
- Work Location Summary:**
  - \*Effective Date: 01/01/2000
  - Effective Sequence: 0
  - HR Status: Active
  - Payroll Status: Active
  - \*Action: Hire
  - Reason: (empty)
  - \*Job Indicator: Primary Job
- Position Information:**
  - Position Number: (empty)
  - Position Entry Date: (empty)
  - Position Management Record: (checkbox checked)
- Related Fields:**
  - \*Regulatory Region: FRA (France)
  - Company: GF2 (Societe Francaise production)
  - \*Business Unit: GF001 (French Business Unit QA)
  - \*Department: GFDEV02 (Department Developopt QA02PP)
  - Department Entry Date: 01/01/2000
  - \*Location: GFFPARIS04 (PARIS 04)

Because of the nature of control fields and related fields, PeopleSoft recommends that you:

- Place them side-by-side on a page to indicate their relationship.
- Provide adequate space between the fields.
- Do not overlap them; otherwise, they appear skewed when viewed through the browser.
- Change the label type for the related field to *None* so that it doesn't appear on the page.
- Enter a text description to document the purpose of the field.

---

**Note:** The display control and related fields must be in the correct order on the order page. The display control field must be positioned before the associated related field; otherwise, a warning dialog box appears when you save the page. Also, fetching the related field after the control field is entered requires a transmission to the server at runtime.

---

**Note:** If you copy fields that have display control/related field associations configured from one page to another, the mappings between the related field and the control field will be lost. After copying these fields, you need to reset the control field/related field associations on the target page.

---

## Creating Related Edit Fields

Related edit fields are slightly different from related display fields. Related edits enable users to enter descriptive values instead of code values and enable prompting on those descriptive values. Changing the value in the control field updates the related edit field, and changing the value in the related edit field updates the value in the control field. If appropriate, the control field can be display-only or even invisible to hide code values from the user.

At runtime, when a user edits a related edit field, it is treated as if the user changed the control field directly. Edits, including any assigned PeopleCode, are run on the control field. PeopleCode is not run for the related edit field.

The following partial screen shot is an example of a related edit field with a control field that is available for entry. When entering company information, the data-entry clerk may not have all company codes memorized, but instead knows just the name of the company. By entering the more descriptive company name in the Description field, (the related edit field) the company code (display control field) is automatically populated in the Company field.

If the user enters *Payroll* in the Description field and exits that field, the system searches for a match to this value and populates the field if only one is found. The field reads *Payroll Services Technology*. If more than one match is found, the field turns red, and an error message appears indicating that the user must use the lookup page to view all related values. Alternatively, the user could enter more detailed information in the field before clicking the prompt to further narrow the search.

### Image: Related edit field

The following partial screen shot is an example of a related edit field with a control field that is available for an entry

At design time, you set up a related edit field in the same way that you create a related display field, except that you clear the Display Only check box in the Field Use Options group box so that the field is



active at runtime. The control field's prompt table is used. You do not need to define a prompt table for the related edit field, just the control field. The related edit field must be a key or an alternate key in the prompt table. PeopleSoft recommends that the related values in your prompt table be unique so that there is a one-to-one mapping to the control values. This prevents the user from receiving a warning and having to access the prompt page to select the proper value.

In some instances, you may not want the control field to be apparent to the user. PeopleSoft Global Payroll, for example, relies heavily on PINs. While PINs are key values, and therefore very important for tracking and storing information in the database, you may not want to distract the user with such a number. However, you still want this data to be entered into the database with the transaction. Related edit fields are particularly helpful in these situations. You can associate the PIN field with a descriptive field and have only the descriptive, related edit field appear on your page. To do so, hide the control field using PeopleCode.

---

**Note:** If the hidden control field that you select is a required field, PeopleSoft Pure Internet Architecture changes the related edit field into a required field as well. At runtime, an asterisk appears next to the field label, marking the field as required. If the user does not enter information in the related edit field, the system displays an error message.

---

## Related Links

"Hide" (PeopleTools 8.58: PeopleCode Language Reference)

## Creating Invisible Control Fields

Your page design may require an invisible control field. For example, if users are interested only in the contents of the related display field, then make the control field invisible. Unlike visible control fields, you *can* overlap an invisible control field and its related display field.

---

**Note:** If you specify a field as invisible in PeopleSoft Application Designer, you cannot make it visible using the Visible property in PeopleCode.

---

To add an invisible control field with a visible label:

1. Access the properties dialog box for the invisible control for which you want the label to appear.
2. Select the Use tab.
3. Set the appropriate field use options:
  - a. Select Display Only, Invisible, and Show Label to make the field invisible and its label visible.

---

**Important!** The Show Label option is not supported for page controls on fluid pages.

---

- b. Select Display Control Field.
4. Select OK.
  5. Add an edit box to your page.

Place this edit box directly to the right of the display control field that you just set.
  6. Access the properties dialog box for the new edit box.

7. Select the Use tab.
8. Select Related Field.
9. Select the appropriate control field from the Related Control Field drop-down list box.
10. Select OK.

---

## Ordering and Spacing Page Controls

This section provides an overview of page control order and spacing and discusses how to:

- Order controls visually.
- Order controls logically.
- Test page control order.
- Apply control order rules.
- Change control order using the order list.
- Find a field on a page definition.
- Use default order.
- Space controls on pages.

## Understanding the Page Definition Order Tab

Page definitions include an `Order` tab. Here, the system populates a grid with the names and properties of the page controls associated with the page definition. Properties, which appear as grid column headings, include:

- Tab Order
- Field ID
- Level
- Label
- (Control) Type
- Field
- Record
- Display Control
- Related Field
- Control Field
- Page Field Name

- Allowed Deferred Processing
- Popup Help

You can use the Order tab as a diagnostic tool, which can save time in addressing issues your page might have with page field processing order and page field tab order among other visual and logical page-processing properties. All values on the Order tab are display-only. Some property values, such as record and field names appear as text; other values, such as Popup Help appear as check boxes in which case, a check indicates that the property is applicable to the page control.

## Understanding Page Control Order and Spacing

The order of the page controls that are on your new page is important to both how your users interact with the page and how the component processor interprets the underlying record and field relationships.

Two types of page control order are important on pages:

- The order in which you visually arrange controls on the page.
- The logical processing order—governed by levels—that the system requires to correctly process the page data.

As you add controls to a page, the system automatically builds a processing control order list that can be viewed on the Order tab of the page definition. Usually, you don't want to preserve this order for processing, so you can reorder your controls on the Order tab to indicate how the system should process your page.

## Ordering Controls Visually

Organize fields from top left to bottom right in a page. Include most important information at top. Use group boxes to group related fields and indicate the hierarchy of information on a page. Guidelines for grouping information include:

- Keys

Group all key fields at the top of a page (such as business unit, employee ID, and setID).

- Level 1–3

Controls at these levels must be enclosed by a scroll area or grid. At design time, these levels can be stacked. At runtime, they appear nested.

## Ordering Controls Logically

Tab ordering through a page at runtime is strictly defined by page field ordering. When you add a control to a page, PeopleSoft Application Designer automatically inserts it in the order list based on where you position it on the page. You can manipulate the ordering of fields on your page by moving them up or down on the Order tab in the page definition. In doing so, you also change the tab order that users follow as they move through fields on the page.

In general, field tab order should flow from top left to bottom right on a page. The flow should reflect the way that the eye naturally scans information. On a page with multiple scroll levels, the tab order should follow the scroll level order, from Level 0 to Level 1, and so on.

**Image: Example tab order on a page without columns**

On a page where the fields are not arranged in columns, the tab order should go from left to right on each line from top to bottom as depicted in this figure:

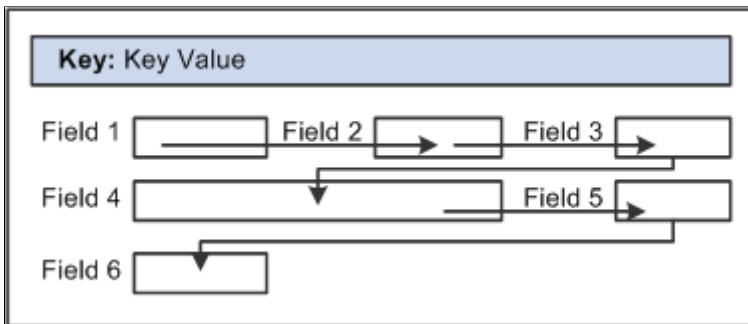

**Image: Example tab order on a page with columns**

On a page with columns, the tab order should go from the top to the bottom of the first column, then from the top to the bottom of the second column, and so on.

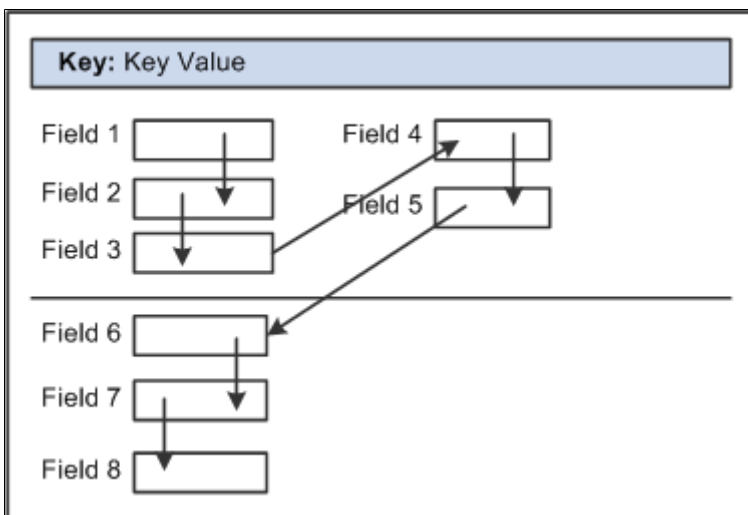

Fields that share the same label should follow consecutively in the tab order from left to right.

**Testing Page Control Order**

After you have placed all of the controls on your page, you should test the tab order. You can do this using either the test mode or by viewing the page in the browser. Using the View Page in Browser mode is more useful because you can also check the placement of controls and subfields that are on your page. In these testing modes, you can enter data into edit boxes and select radio buttons and check boxes. However, you cannot save data that you enter, and push buttons and links do not function.

---

**Note:** The tab order that you establish at design-time may not apply for all browsers.

---

See *Troubleshooting Browser Limitations* available on the My Oracle Support website.

To test tab flow using View Page in Browser mode:

1. Open the page in PeopleSoft Application Designer that you want to test.

2. Select Layout > View in Browser.
3. Select the appropriate browser from the drop-down list box.
4. Press the Tab key to move from one field to the next.

Press Shift+Tab to move to the previous field.

## Applying Control Order Rules

If you're working with a complex page or you're new to order lists, you might print out a page definition and work on the hard copy. The sequence number of each control is reflected in the Num column on the page report. You can easily mark where you need to move a control to make your page function properly, or you can look at the Lvl column on the Order tab of the page definition.

Use these rules to order your controls:

### Radio Buttons

For radio buttons to function in a single group, they must be associated with the same record field and be listed together on the Order tab of the page definition. The only control that you can place between related radio buttons is the static text control to extend radio button labels. Put the text immediately after the radio button to which it relates.

### Level-Based Controls

List level-based controls (scroll areas, grids, and scroll bars) immediately before the first control that they govern, followed by the controls that are directly governed by that control. Level-based controls directly govern all controls that are listed below them on the order list until they encounter another level-based control that is at the same or lower level (higher occurs level number).

### Display Controls

Place display controls before related displays that they govern. The related display controls don't have to follow the display controls immediately, but they must be inside the same scroll area or scroll. However, if you have more than one related display control, placing each immediately following its display control makes the order page easier to read and understand.

## Changing Control Order Using the Order Tab

The Order tab of the page definition displays attributes about each of the page controls and their processing order. The Field ID column represents the order in which the control was added to the page. If you modify the order of page fields on the page, note that the numbers assigned to each field remain constant. Thus the IDs might not always appear in sequential order. When a database compare is performed, the Field ID appears on the Compare report to assist you in identifying specific page fields.

Reorder page fields on the Order tab by dragging them in the same view. Changing the order list doesn't change the physical location of controls on the page. It changes only the logical order or tab order in which controls are processed. When you have added and arranged all of your controls, you may want to print your page definition to see how you might need to reorder your controls.

The Order tab also governs processing rules for scrolls and record or field relationships. Consider which controls are associated with which scroll area or scroll bar and which secondary relationships are important to page processing.

To change the order list:

1. Open the page.
2. Select the Order tab on the open page.

The Order view appears. Use this view to change the logical processing order of fields on your page.

3. To move a control to another position in the control order list, select the control that you want to move.

Press the Shift key to select multiple controls.

4. Drag the selected control to the new position on the Order view.

The system moves the control to the new location in the list. The ID value remains static. The visual display of the page still looks the same—changing the order list doesn't move the control on the page, only the logical processing order of the control.

---

**Important!** When viewing your page in “Test Mode,” page fields cannot be accessed, moved, or modified from the Order tab if the page definition contains a sub page. Exit “Test Mode” to rearrange page fields in the order list.

---

## Finding a Field on a Page Definition

Use the Order view to locate a field on a page definition. Using this method of locating fields is useful when you are working with detailed page definitions that contain many fields.

To find a field on a page:

1. Access the Order tab of your page definition.
2. Select the field that you want to locate on the page.
3. Select the Layout tab.

The field that you selected on the Order tab is selected in the Layout view.

## Using Default Order

You can reorder the field list on the Order tab so that the logical control order reflects the physical control order as shown on the Layout tab. Do so by selecting Layout > Default Page Field Ordering. You can use this tool in either the Layout or Order view for your page definition. The system creates the default order by reading the page as though it was on a pixel-by-pixel grid, from top to bottom and left to right.

---

**Note:** Use the default ordering option sparingly on existing pages. It may offset any previous order that was created. However, on new pages, you may find default ordering a useful starting point for your control order list.

---

## Spacing Controls on Pages

Provide adequate space between controls on a page so that fields and their labels don't touch or overlap other controls or labels in PeopleSoft Application Designer. If they do, then when your page appears in the browser, the label is offset automatically and the overlapped control might shrink.

### Overlapping Fields

You can layer or overlap fields only if the one that you are overlapping is set to *Invisible* on the Use tab of the properties dialog box for that control. When you move through the data entry controls on a page, the component processor recognizes only visible, non-hidden fields as available for entry.

You can layer multiple invisible fields. However, you must set up your stacks of edit boxes so that all but one field in the stack are invisible or hidden at RowInit time.

## Designing Inquiry Pages

You can design pages for inquiry purposes only. Inquiry pages are usually based on search records that extract specific information from different tables to display different views of your database, such as a summary of expenses by department.

To create an effective inquiry page:

- Make all of the fields display-only.
- Build in sufficient display control and related field relationships to show relevant descriptions.
- When using level-based controls, disable the row action buttons so that the user cannot add or delete rows.

### Image: Workforce Job Summary inquiry page

This example illustrates the fields and controls on the Workforce Job Summary inquiry page. You can find definitions for the fields and controls later on this page.

Workforce Job Summary										
<a href="#">Caroline SABBARICH</a>			EMP		Empl ID: GF100ME280					
Job Information										
General   Job Information   Work Location   Salary Plan   Compensation   [F3]										
Org Relation	Empl Record	Effective Date	Seq	Job Code	Empl Type	Empl Status	Full/Part Time	Reg/Temp	Standard Hours	Work Period
EMP		01/01/2000	0	GFJ007	Not Appl.	Active	Full-Time	Regular	35.00	Weekly

## Aligning Page Controls and Page Control Labels

When you are in page design mode, the Align and Align Label buttons on the page definition toolbar enable you to align your page controls and their labels relative to each other, both horizontally and vertically.

PeopleSoft Application Designer uses relative alignment; the *last* item that you select is the guide, or anchor. All selected page controls or page control labels align relative to the anchor. The anchor does not move when you select an alignment option.

You can align page controls and their labels together by using the Align buttons. Both the control and its label move when you use this option. You can also align labels by themselves without moving the associated controls by using the Align Label buttons. The Align and Align Label buttons are enabled when you select two or more page controls or page control labels.

In addition to using the Align buttons, from the menu you can also select Layout, Align and then the control or label alignment position.

---

**Note:** Align the page controls *before* you align their labels.

---

## Aligning Page Controls

To align page controls:

1. Select the controls that you want to align by pressing Ctrl and then clicking each page control.

---

**Note:** You can also select multiple page fields by clicking and dragging the cursor around the controls. However, for relative alignment purposes, the Ctrl + click is the preferred method of selection, because it enables you to explicitly set the anchor control.

---

2. Click the appropriate Align button in the toolbar: Align Left, Center, Right, Top, Middle, or Bottom.

When the page controls move, their labels move with them maintaining relative positioning to the associated controls.

You can manually move page controls after relative alignment, though previous alignment is not preserved.

## Aligning Page Control Labels

To align page control labels:

1. Select the labels that you want to align by pressing Ctrl and then clicking each label *or* control.
2. Click the appropriate relative alignment button in the toolbar: Align Label Left, Center, or Right.

When the labels move, their controls remain stationary.

You can manually move labels after relative alignment, though previous alignment is not preserved.

## Related Links

[Selecting Controls](#)

---

# Maximizing Performance

Page definitions permit controlled access to application data. The system can validate the data, write it to the database, and then retrieve and display it upon request. Behind the scenes, the component processor—



the PeopleTools runtime processor—builds SQL statements that are based on the actions that you perform on pages. The component processor:

- Manages the flow of data processing as users enter information on pages.
- Issues INSERT, DELETE, and UPDATE statements to maintain data in the database and SELECT statements to retrieve data.

As you design your pages, some features can adversely affect page performance. There's always a trade-off between eliminating a useful feature and speeding up page processing. Guidelines for improving page performance include:

- Be judicious about references to record definitions other than the primary record definition under each scroll area.

References to other record definitions can include:

- Related display controls.
  - PeopleCode references (such as edits and defaults) to other records.
  - Defaults to fields on other record definitions.
  - Field controls on derived or work records.
- Put the field control on the appropriate derived or work record, rather than on a regular data record definition to derive its value.

For example, FTE (full-time equivalent) on the JOB record definition would be moved to the DERIVED\_HR derived or work record because its value is derived by the system.

- Use as few record definitions as possible in a component.

When you open a page in a component, the system loads all record buffers from the entire component into buffers.

- Do not remove table edits to improve performance, even though an edit against another table causes a short pause.

Eliminating them may compromise data integrity.

- Frames, scroll areas, scroll bars, grids, and group boxes all create HTML tables, which, in some browsers, might slightly degrade the performance of your system.

Be judicious about the number of these types of controls that you use on a page.

- Apply deferred processing when possible to fields, pages, and components.

## Related Links

### Improving Online Performance

"Understanding the Component Processor" (PeopleTools 8.58: PeopleCode Developer's Guide)

## Accessing PeopleCode in Page Definitions

Page fields are associated with a specific record field. You can access the PeopleCode for that record field from the page field in the page definition. You might add PeopleCode to a field to achieve a variety of tasks, ranging from real-time editing of fields to altering the appearance of fields on a page. You can also associate PeopleCode with a component, component record, and component record field.

### Image: Editing PeopleCode

This example illustrates the fields and controls on the Editing PeopleCode. You can find definitions for the fields and controls later on this page.

```

CURR_QUOTE_TBL.RATE_TRIANGULATE.FieldChange (Record PeopleCode)
RATE_TRIANGULATE (field) FieldChange
Declare Function SetQuoteDescription PeopleCode CURR_QUOTE_TBL.RATE_DIRECT FieldChange;
If %Panel = Panel.CURR_QUOTE_PNL Then
    SetQuoteDescription();
End-If;
If CURR_QUOTE_TBL.RATE_TRIANGULATE = "Y" Then
    UnGray(CURR_QUOTE_TBL.REF_CUR);
Else
    SetDefault(CURR_QUOTE_TBL.REF_CUR);
    CURR_QUOTE_TBL.XRATE_OVERRIDE = "N";
    Gray(CURR_QUOTE_TBL.REF_CUR);
End-If;
If CURR_QUOTE_TBL.RATE_TRIANGULATE = "Y" And
    All(CURR_QUOTE_TBL.REF_CUR) Then
    CURR_QUOTE_WRK.FROM_TO_LABEL = CURR_QUOTE_TBL.FROM_CUR | " --> " |
    CURR_QUOTE_TBL.TO_CUR;
    CURR_QUOTE_WRK.FROM_REF_LABEL = CURR_QUOTE_TBL.FROM_CUR | " --> " |
    CURR_QUOTE_TBL.REF_CUR;
    CURR_QUOTE_WRK.REF_TO_LABEL = CURR_QUOTE_TBL.REF_CUR | " --> " |
    CURR_QUOTE_TBL.TO_CUR;
    UnGray(CURR_QUOTE_TBL.XRATE_OVERRIDE);
    UnGray(CURR_QUOTE_TBL.PRIMARY_VISUAL);
    If CURR_QUOTE_TBL.XRATE_OVERRIDE = "Y" Then
        UnGray(CURR_QUOTE_TBL.XRATE_RECALC);
    Else
        Gray(CURR_QUOTE_TBL.XRATE_RECALC);
    End-If;
Else

```

To edit or add record field PeopleCode through a page definition:

1. Select File > Open to open the page definition through which you want to access PeopleCode.
2. Select the field on the page for which you want to view the associated PeopleCode.
3. Select View > View Record PeopleCode.

The PeopleCode editor appears, providing access to all of the PeopleCode for the record that owns that field.

4. Select the PeopleCode event type from the drop-down list box in the PeopleCode editor.

You can also select other fields in the primary record from that drop-down list box.

5. Select File > Save to save your changes.

## Related Links

"Understanding PeopleCode Programs and Events" (PeopleTools 8.58: PeopleCode Developer's Guide)

---

## Previewing Pages in the Browser

This section discusses how to:

- Work with the View in Browser feature.
- Maintain the list of browsers.
- Preview fluid pages.
- Preview classic pages.
- Generate HTML.

## Working With the View in Browser Feature

During the page design process, you might want to periodically preview how your page looks in the browser. How your page appears in Application Designer at design time may look different when viewed online. This is particularly true for fluid pages, which do not follow the pixel perfect WYSIWYG paradigm of classic pages. With fluid pages, CSS determines how the page and how the page elements are displayed to the user. The physical placement of the page elements often has no bearing on how the fluid page will appear at run time. Therefore, you must either preview fluid pages from Application Designer or view them in a runtime browser session.

After you open either a fluid or classic page definition in Application Designer, you can select Layout > View in Browser, and then select a browser from the list of configured browsers to preview the page.

## Limitations

The View in Browser feature provides an approximate idea of how your page will look. For the complete view of the page at run time, including any component settings, assign your page to a component and register the component to the portal registry structure using the Registration Wizard. Then, you can access the component and page in a browser online.

Note the following limitations on previewing pages from Application Designer:

- Only page definitions as a standalone definition can be previewed. Therefore, none of the component properties or settings are available as part of a page preview.
- No PeopleCode or JavaScript is run during page preview.

For example, flex grid column headings will not be aligned properly because this relies on JavaScript. In addition, scrolling enabled in Application Designer will not function since this also relies on JavaScript.

- The content of an HTML area that is populated dynamically via the value of a record field (that is, via PeopleCode) is not displayed. However, the content of an HTML area that is populated statically via a constant value is displayed.
- Application data such as high-level keys, related display data, and grid or scroll data is not displayed.
- Most page controls are inoperable.
- In addition, for fluid pages, the following limitations apply:
  - You can preview the following page types only: Standard, Subpage, and Secondary. For other fluid page types, the View in Browser menu item displays this message: (Not available for this page type).
  - Any styles applied via PeopleCode or JavaScript will not be in effect.
  - Pages are previewed in extra large form factor only; styles and overrides specific to this form factor will be applied. However, form factor overrides for any other form factor will be ignored.
  - An empty fluid banner is displayed at the top of the page for standard page types only. Since the component definition includes all the settings that determine what is displayed in the fluid banner, none of this information is available in the page definition during page preview.
  - Secondary page types are not displayed in a modal window; the content is previewed in a full screen.
- In addition, for classic pages, the portal wrapper (the portal header and footer defined in PeopleTools branding) is not displayed.

## Previewing Fluid Pages

The following examples demonstrate the rendering of a fluid page preview using the PeopleTools-delivered Change Password (CHANGE\_PASSWORD) page.

**Image: CHANGE\_PASSWORD page definition**

The following example shows the CHANGE\_PASSWORD page definition in Application Designer:

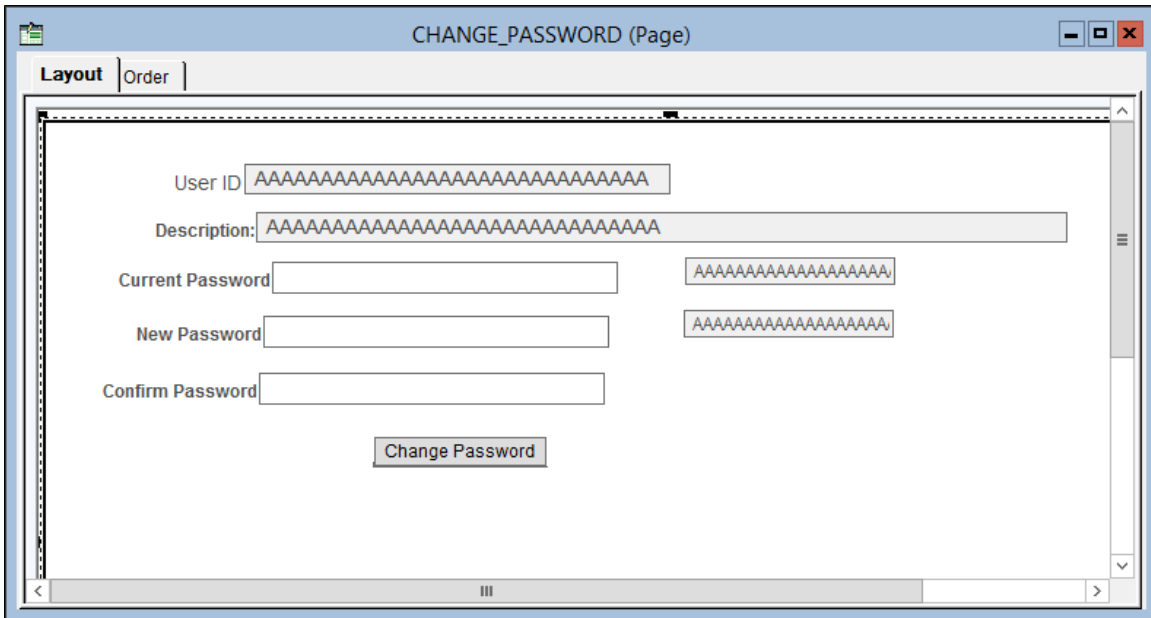

**Image: Change Password page: Preview rendering**

The following example shows the Change Password page when rendered using the page preview feature in Application Designer:

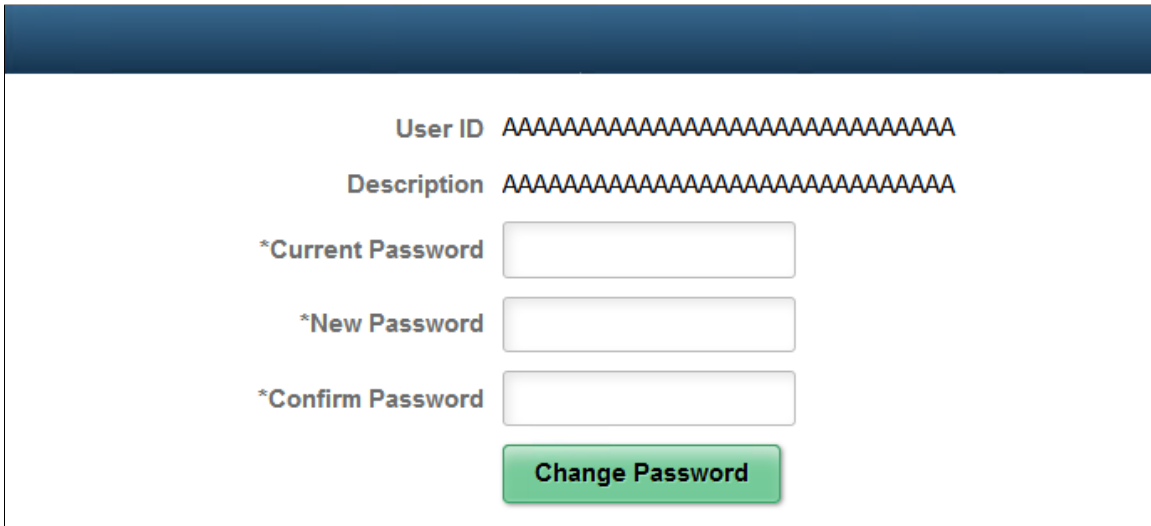

## Image: Change Password page: Runtime rendering

The following example shows the Change Password page when rendered at run time:

Note that the following styles and settings are honored when previewing fluid pages:

- Styles and settings on the Fluid tab of the Page Properties dialog box. Form factor overrides for the extra large form factor are honored; overrides for all other form factors are ignored.
- Styles and settings on the Fluid tab of any page field properties dialog box. Form factor overrides for the extra large form factor are honored; overrides for all other form factors are ignored.
- In addition, any browser-specific styles are applied.

Because page-specific style sheets are added via PeopleCode, these style sheets are not automatically included during page preview like they would be in the a runtime rendering. Therefore, use the Apply Additional Style Sheets menu item to apply page-specific style sheets in page preview. See "Applying Additional Style Sheets" in this topic for more information.

## Viewing Related Content Drop Zones

You might also want to preview the location of the group boxes configured as related content drop zones in relation to other page controls when previewing a fluid page.

---

**Note:** However, because embedded related content and dynamic subpages are configured outside of Application Designer and rely on data that is only available at runtime, the content within these drop zones cannot be displayed as part of fluid page preview.

---

To view drop zone group boxes during fluid page preview:

1. Select Layout, View in Browser, View Related Content Drop Zones.

Once this option has been selected, a check mark will appear next to View Related Content Drop Zones in the menu indicating that drop zone group boxes will be displayed during fluid page preview. This setting remains in effect only for the duration of the Application Designer session or until it has been deselected.

- 2. Select Layout, View in Browser and select a browser to preview a fluid page displaying drop zone group boxes.

**Image: MYQUICKCONTACTS page with drop zone group boxes**

The following is an example only, which shows three drop zone group boxes on the MYQUICKCONTACTS page definition in Application Designer:

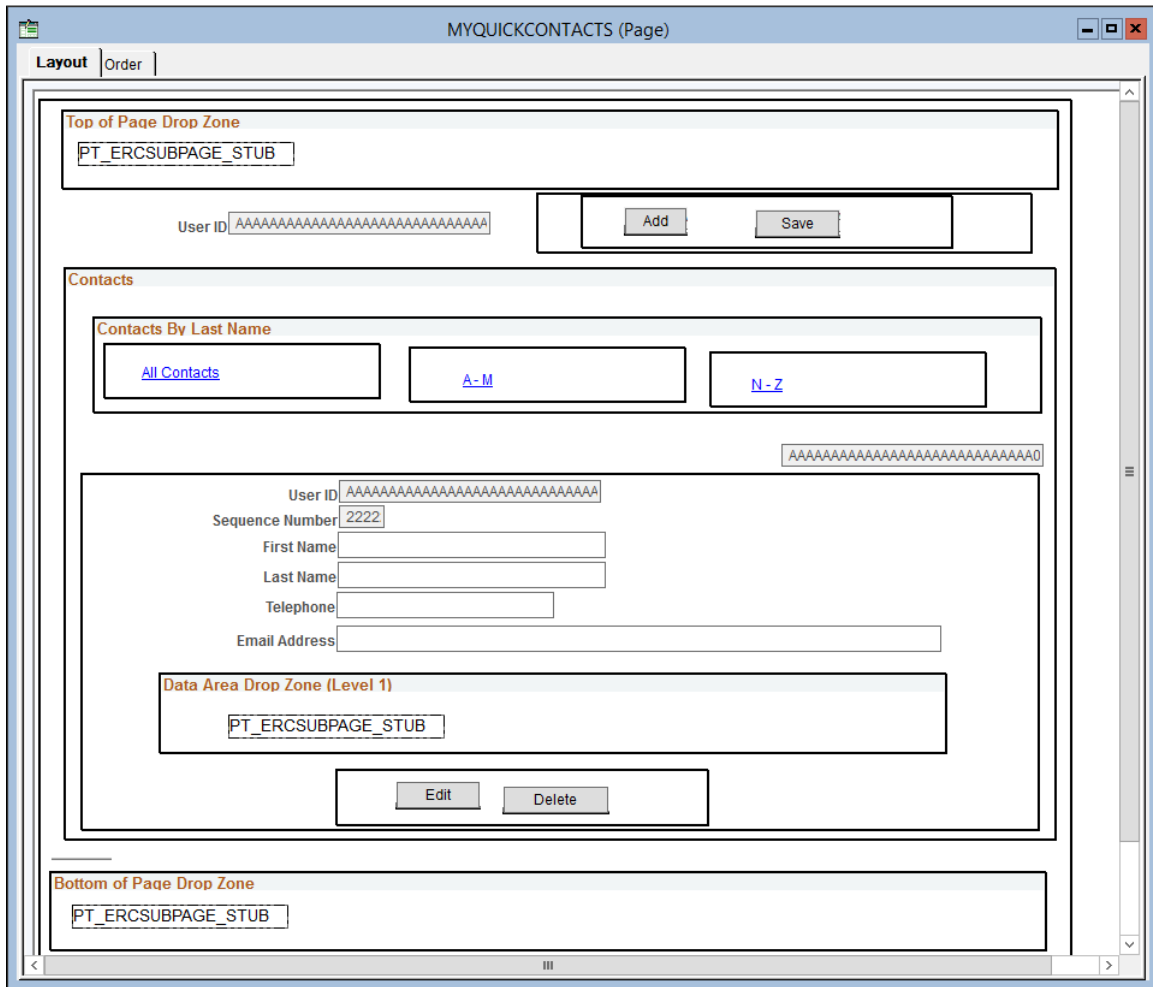

**Image: MYQUICKCONTACTS page: Preview rendering with related content drop zones**

The following example shows related content drop zones on the MYQUICKCONTACTS page when rendered using the page preview feature in Application Designer:

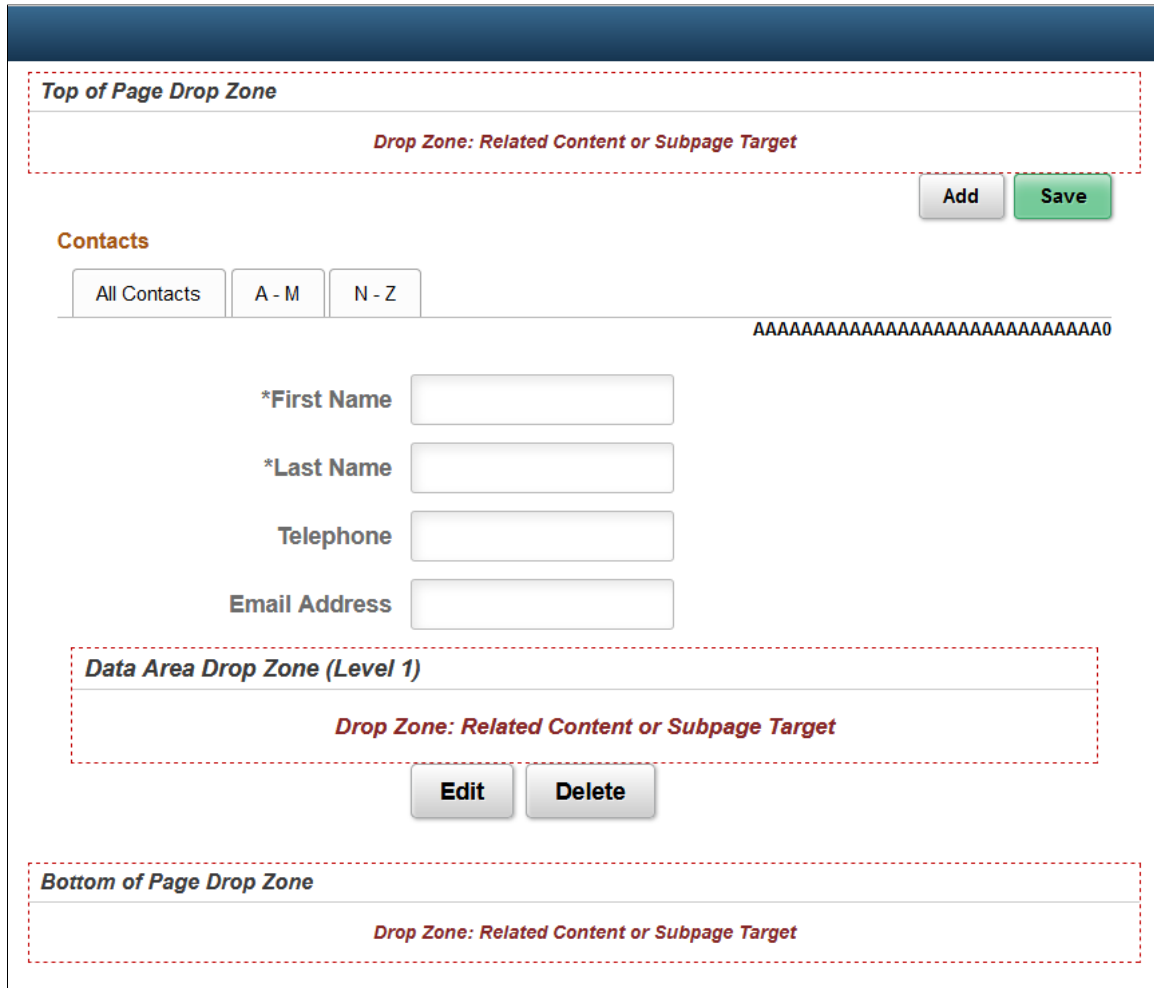

**Note:** Page preview includes the labels for the related content drop zones for configuration purposes only. These labels are available to the administrators who are configuring embedded related content or dynamic subpages. At run time, these labels are not displayed. In addition, if no label is defined on the group box, the label displayed in fluid page preview will differ from what is shown in the example here and what is available to administrators who are configuring embedded related content or dynamic subpages.

**Applying Additional Style Sheets**

While page preview does apply the standard system style sheet, since custom style sheets are applied via PeopleCode, they are not available during page preview.

Therefore, to apply custom free form style sheets, you need to create a text file on the local file system that lists the custom style sheets, one per line. Specify the Application Designer definition name for each custom free form style sheet. You can also include comments in this file preceded by the # symbol only. The following example illustrates the contents of a text file that identifies two custom free form style sheets:

```
# Custom style sheets for fluid page preview:
MY_STYLESHEET_1
```



STYLESHEET\_25

To apply custom free form style sheets during fluid page preview:

1. Create a text file listing the style sheets on the local file system.
2. In Application Designer, select Layout, View in Browser, Apply Additional Style Sheets.
3. In the Apply Additional Style Sheets dialog box, browse to and select the text file.
4. Select the Apply Style Sheets check box.
5. Click OK.

Once the Apply Style Sheets check box has been selected, a check mark will appear next to Apply Additional Style Sheets in the menu indicating that custom style sheets will be applied to *each* fluid page that is previewed. This setting even remains in effect between Application Designer sessions. To preview fluid pages without applying custom style sheets, deselect the Apply Style Sheets check box.

6. Select Layout, View in Browser and select a browser to preview a fluid page with the specified style sheets applied.

### Related Links

"Working with Embedded Related Content" (PeopleTools 8.58: Fluid User Interface Developer's Guide)

"Applying Styles" (PeopleTools 8.58: Fluid User Interface Developer's Guide)

## Previewing Classic Pages

The following examples demonstrate the rendering of a classic page preview using the PeopleTools-delivered My System Profile (USER\_SELF\_SERVICE) page.

**Image: USER\_SELF\_SERVICE page definition**

The following example shows the USER\_SELF\_SERVICE page definition in Application Designer.

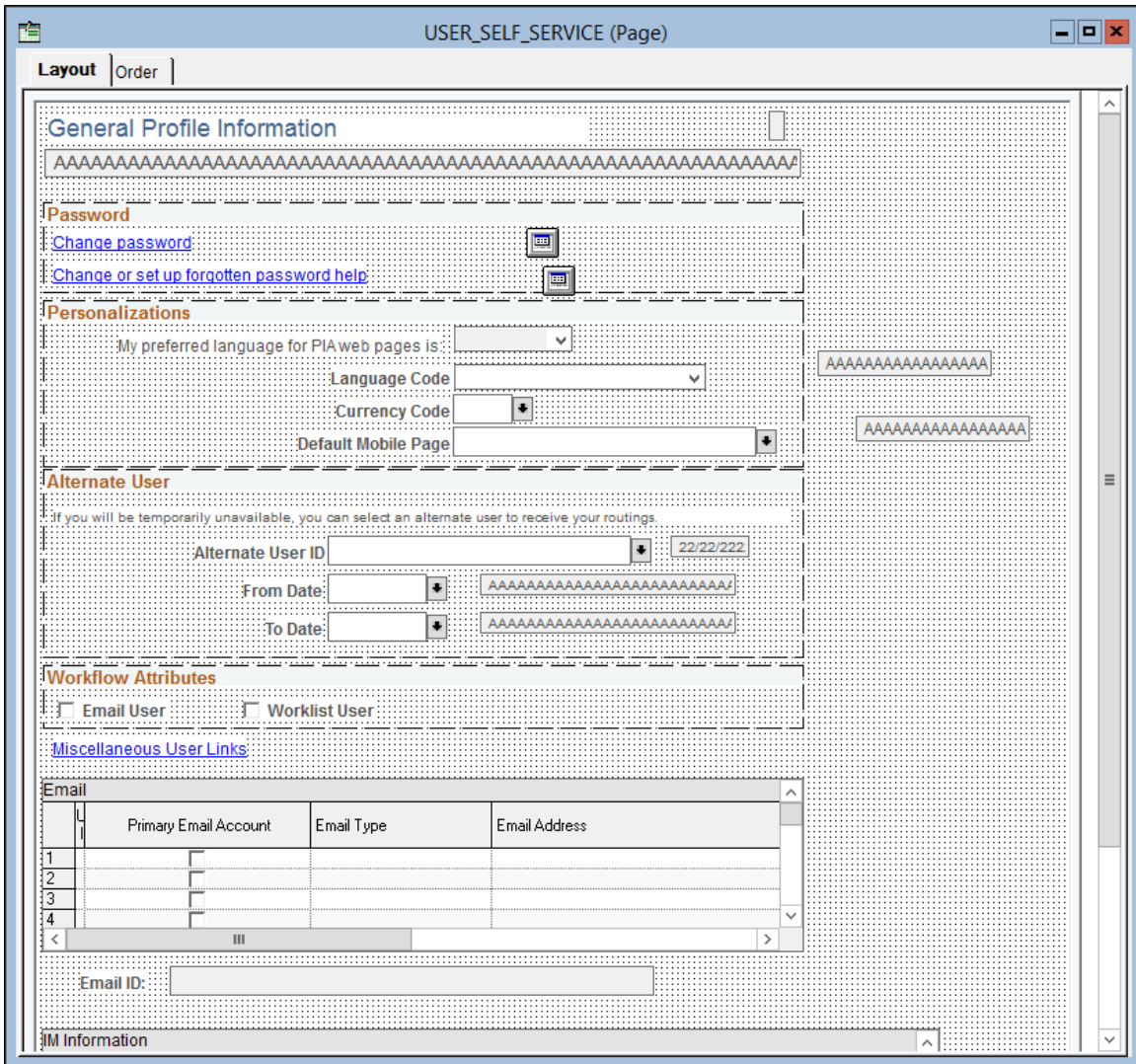



### Image: My System Profile page: run-time rendering

The following example shows the My System Profile page as rendered at run time:

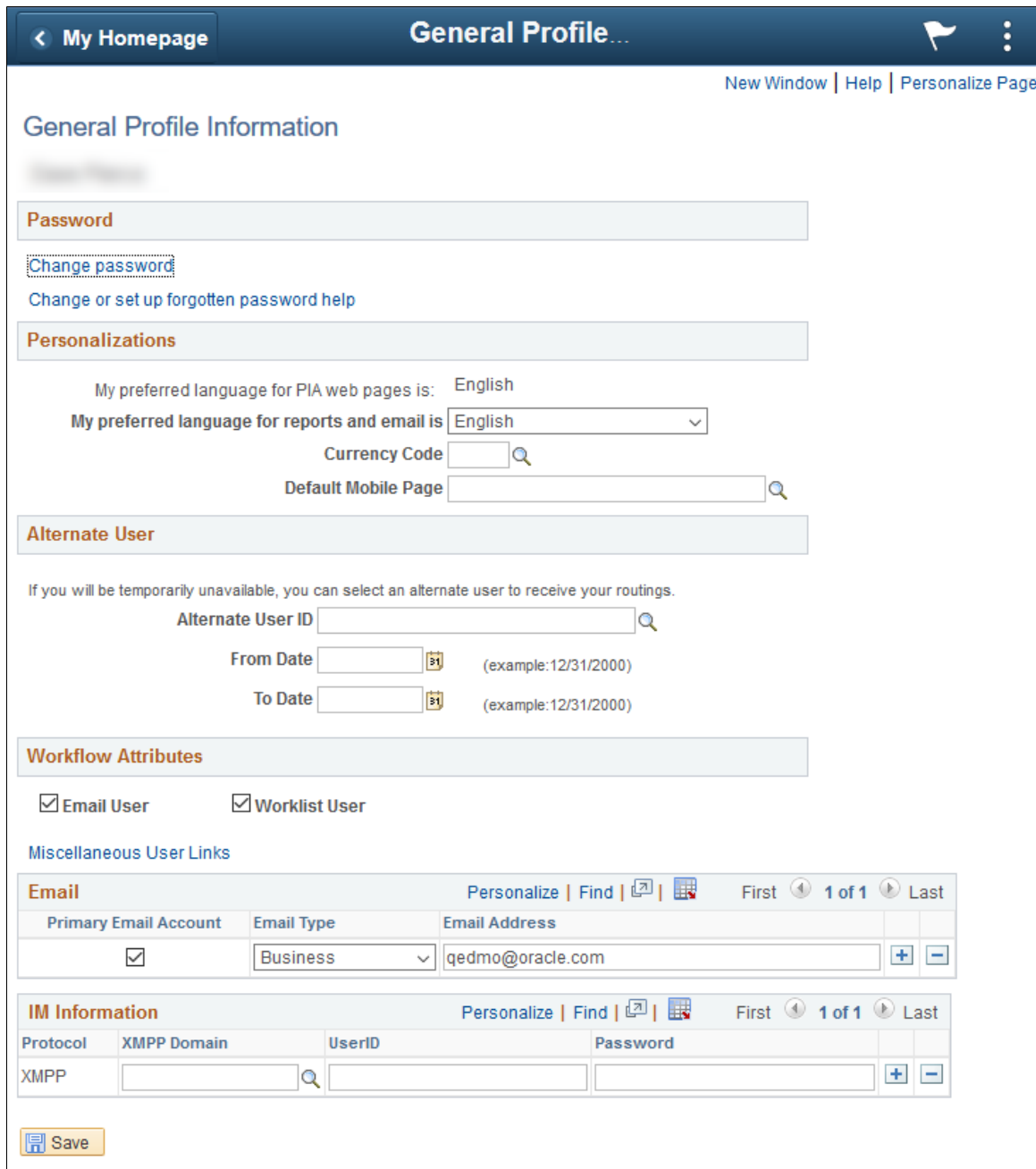

### Previewing a Page as Classic Plus

When working with classic pages, you can preview a page as classic plus regardless of component settings and regardless whether any reworking has been completed to make the page more suitable for classic plus. In fact, you can use this feature to assess what rework might be required. For guidance on what may need to be reworked, see [Reworking Components for Classic Plus Display](#).

To preview a classic page as classic plus:

1. Select Layout, View in Browser, View as Classic Plus.

Once this option has been selected, a check mark will appear next to View as Classic Plus in the menu indicating that classic plus styling will be applied to *each* classic page during page preview. This setting remains in effect only for the duration of the Application Designer session or until it has been deselected.

2. Select Layout, View in Browser and select a browser to preview a classic page as classic plus.

The following examples demonstrate the classic plus rendering of the PeopleTools-delivered My System Profile page.



## Image: My System Profile page: Runtime rendering as classic plus

The following example shows the My System Profile page when rendered as classic plus at run time:

[My Homepage](#) **General Profile...** [New Window](#) | [Help](#) | [Personalize Page](#)

### General Profile Information

**Password**

[Change password](#)  
[Change or set up forgotten password help](#)

**Personalizations**

My preferred language for PIA web pages is: English

My preferred language for reports and email is:

Currency Code:

Default Mobile Page:

**Alternate User**

If you will be temporarily unavailable, you can select an alternate user to receive your routings.

Alternate User ID:

From Date:  (example:12/31/2000)

To Date:  (example:12/31/2000)

**Workflow Attributes**

Email User     Worklist User

[Miscellaneous User Links](#)

**Email**

## Maintaining the List of Browsers

Application Designer will automatically detect your default system browser. You can add additional browsers to the list of browsers to use for previewing. After you set up a new browser, you can select in which browser you want to view your pages.

To maintain the list of browsers:

1. Open a page definition in Application Designer.
2. Select Layout > View in Browser > Edit Browser List.

The Browsers dialog box is displayed.

3. Click the Add button to add a browser to the list.

The Browser Definition dialog box is displayed.

4. Click the Browse button to locate the browser to add.

You must select the correct path and browser application for the new browser to function properly.

5. Click the Find Name/Type/Version button to automatically enter the name, type, and version of the browser.

The name and version that you enter appears in the Layout, View in Browser menu.

---

**Note:** If the browser is updated in the future, this version information will be out of sync with the actual browser version. However, the preview function will still work unless the location or name of the executable has changed.

---

## Generating HTML

You can view the HTML that is created for classic or fluid pages page by using the Generate HTML menu item. This feature writes the HTML code to a file in a subfolder of the folder defined by the TMP environment variable—for example, in %TMP%\2\pshtml. This feature is mainly used for debugging purposes and typically is not needed when you're designing and developing pages.

---

## Configuring Drop Zones

This topic provides an overview of drop zones and discusses how to:

- Insert configurable drop zones.

---

**Note:** Typically, as an Oracle customer, you should skip this step. PeopleSoft application teams have already added and delivered one or more configurable drop zones on selected pages.

---

- Create custom subpages for dynamic injection into drop zones.
- Configure drop zones.

## Understanding Drop Zones

Configurable drop zones allow you to add fields to delivered pages without customizing the delivered component or page definition. Your fields are displayed and processed along with fields from the main page definition and any nested subpages or secondary pages.

At design time, a placeholder subpage stub (PT\_ERCSUBPAGE\_STUB) is inserted into a special group box on the page definition, creating what is referred to as a “drop zone.” Drop zones can be added to a



main page, to subpages at any nesting level, and to secondary pages. Typically, PeopleSoft application teams (PeopleSoft HCM, PeopleSoft FSCM, and so on) have identified which delivered pages can be extended by customers and have already added one or more configurable drop zones on these pages, subpages, and secondary pages. Then, you create custom subpage definitions and associate your subpages to one or more drop zones. Finally, at runtime during the component build process, the configured subpage dynamically replaces the subpage stub. The records and fields defined on your subpage are loaded into the component buffer along with the records and fields from the main page definition.

The complete procedure for inserting and configuring drop zones includes three tasks described within this topic:

1. (Optional) Inserting configurable drop zones.

---

**Important!** This task is described for informational purposes only. Drop zones are delivered by PeopleSoft application teams. Therefore, this step is typically not performed by you. While you could add drop zones to your own custom application pages, there really is no reason to do so. Moreover, if you were to add drop zones to pages delivered by Oracle, those changes would be considered customizations.

---

To understand the process used by PeopleSoft application development teams, see [Inserting Configurable Drop Zones](#).

2. Creating subpages for these drop zones.

See [Creating Custom Subpages for Drop Zones](#).

3. Configuring a selected drop zone by associating a custom subpage to it.

See [Configuring Drop Zones](#).

## Inserting Configurable Drop Zones

---

**Important!** This task is described for informational purposes only. Drop zones are delivered by PeopleSoft application teams. Therefore, this step is typically not performed by you. While you could add drop zones to your own custom application pages, there really is no reason to do so. Moreover, if you were to add drop zones to pages delivered by Oracle, those changes would be considered customizations.

---

### Guidelines for Creating Configurable Drop Zones

---

**Note:** The following guidelines are valid for conventional components only. For “derived components”—that is, components with a derived record structure—you must carefully evaluate the derived record and key structure and database fetch, save, and commit mechanisms since these will not necessarily rely on the built-in processing of the PeopleTools component processor. Depending on the component’s architecture, adding a drop zone may or may not work and must be tested thoroughly.

---

Adhere to the following guidelines when inserting configurable drop zones:

- Insert the group box type that is appropriate to the page type (fluid pages versus classic pages).
- Insert the PT\_ERCSUBPAGE\_STUB subpage stub into the group box . (This subpage stub is identified on the PeopleTools Options page.)

- Do not insert any other page controls within the group box.
- If you add a drop zone on a secondary page, then you must also insert a secondary page control on the main page or subpage that launches the secondary page.
- If you add a drop zone on a subpage or a secondary page rather than on the main page, then you must ensure that each drop zone that will be displayed along with the main page at runtime can be uniquely identified. The PeopleSoft system uses the combination of `occurs_lvl.RECORD_NAME.FIELD_NAME.Field_ID` to identify each group box as a page record field. By associating each group box to a unique record field, you will ensure that each can be uniquely identified.

**Image: Unique page field identifier**

The information that uniquely identifies page field can be found on the page definitions Order tab. In the following example, Top of Page Drop Zone is uniquely identified as `0.MYQKCONT_WRK.MQC_DZ_1.2`.

Tab Order	Field ID	Lvl	Label	Type	Field	Record	Parent Field	Display Control	Related Field	Cor
1	1	0		Group Box			MYQUICKC	<input type="checkbox"/>	<input type="checkbox"/>	
2	2	0	Top of Page Drop Zone	Group Box	MQC_DZ_1	MYQKCONT_WRK	MYQUICKC	<input type="checkbox"/>	<input type="checkbox"/>	
3	5	0		Subpage			MYQUICKC	<input type="checkbox"/>	<input type="checkbox"/>	
4	9	0	User ID	Edit Box	OPRID	MYQKCONTACT_VW	MYQUICKC	<input type="checkbox"/>	<input type="checkbox"/>	
5	18	0		Group Box			MYQUICKC	<input type="checkbox"/>	<input type="checkbox"/>	

**Important!** Because the PeopleSoft system uses the combination of `occurs_lvl.RECORD_NAME.FIELD_NAME.Field_ID` to identify each drop zone, you cannot make any updates that would change any of the elements of this unique identifier such as moving the drop zone to a different occurs level, changing the associated record field, or deleting the drop zone. Any such change will orphan and break existing configurations based on that drop zone. If you need to make any such updates, delete any existing configurations first so that they are not orphaned. Make the required changes. Then, re-establish the configuration.

**Inserting a Group Box as a Drop Zone**

To insert a group box as a drop zone:

1. Insert the group box on your page in the general position you would like to display the content from the custom subpage.

**Note:** On classic pages, similar to inserting other page controls, ensure that there is a minimum of a 5 pixel vertical gap between the drop zone group box and other page controls.

2. Double-click the group box to open the Group Box Properties dialog box.
3. Then, configure the group box depending on the page type:
  - a. For fluid pages, on the Fluid tab, set the Group Box Type to *Related Content*.
  - b. For classic pages, on the Use tab, select these check boxes: *Drop Zone Group Box* and *Hide all Fields when Group Box Hidden*.

4. (Optional) Apply styling, if needed, to this group box that will only be rendered if a subpage is configured for this drop zone.
5. Select the Label tab and enter a descriptive label to identify this group box as a drop zone. Enter a label that describes the position, purpose, or both for this drop zone. The label is not rendered at runtime, but it will help at design and configuration time by:
  - Differentiating this drop zone from any others on this page as well as any associated subpages or secondary pages.
  - Providing a label on the drop zone during page preview in Application Designer.
  - Providing a label for the drop zone during the drop zone configuration task, which displays all available drop zones from the component.
6. Associate a record field to this drop zone to ensure that it has a unique page field identifier.
7. Insert the PeopleTools-defined PT\_ERCSUBPAGE\_STUB subpage stub into the related content group box:
  - On fluid pages, the upper left corner of the subpage must be located within the group box. On classic pages, the entire subpage must be located inside the boundaries of the group box.

**Image: PT\_ERCSUBPAGE\_STUB subpage**

In this example, the PT\_ERCSUBPAGE\_STUB subpage is located within the drop zone group box in a manner that satisfies both fluid and classic requirements on placement.



- The subpage must be listed immediately after the group box on the Order tab for the page definition.

**Image: Page definition: Order tab**

In this example, the PT\_ERCSUBPAGE\_STUB subpage immediately follows the Data Area Drop Zone (Level 1) group box on the Order tab.

Tab Order	Field ID	Lv	Label	Type	Field	Record	Parent Fi	Display Control	Related Field	Cor
1	1	0		Group Box			MYQUICKC			
2	2	0	Top of Page Drop Zone	Group Box	MQC_DZ_1	MYQKCONT_WRK	MYQUICKC			
3	5	0		Subpage			MYQUICKC			
4	9	0	User ID	Edit Box	OPRID	MYQKCONTACT_VW	MYQUICKC			
5	18	0		Group Box			MYQUICKC			
6	19	0		Group Box			MYQUICKC			
7	20	0	Add	Push Btn/Link	ADD_PB	MYQKCONT_WRK	MYQUICKC			
8	21	0	Save	Push Btn/Link	SAVE_PB	MYQKCONT_WRK	MYQUICKC			
9	7	0	Contacts	Group Box			MYQUICKC			
10	27	0	Contacts By Last Name	Group Box	MQC_TABSET	MYQKCONT_WRK	MYQUICKC			
11	28	0		Group Box	MQC_TAB1	MYQKCONT_WRK	MYQUICKC			
12	29	0	All Contacts	Push Btn/Link	MQC_TABLINK_ALL	MYQKCONT_WRK	MYQUICKC			
13	30	0		Group Box	MQC_TAB2	MYQKCONT_WRK	MYQUICKC			
14	32	0	A - M	Push Btn/Link	MQC_TABLINK_AM	MYQKCONT_WRK	MYQUICKC			
15	31	0		Group Box	MQC_TAB3	MYQKCONT_WRK	MYQUICKC			
16	33	0	N - Z	Push Btn/Link	MQC_TABLINK_NZ	MYQKCONT_WRK	MYQUICKC			
17	26	0	Total	Edit Box	MQC_TOTAL	MYQKCONT_WRK	MYQUICKC			
18	8	1		Scroll Area			MYQUICKC			
19	10	1	User ID	Edit Box	OPRID	MYQKCONTACTSTBL	MYQUICKC			
20	11	1	Sequence Number	Edit Box	SEQNBR	MYQKCONTACTSTBL	MYQUICKC			
21	12	1	First Name	Edit Box	FIRST_NAME	MYQKCONTACTSTBL	MYQUICKC			
22	13	1	Last Name	Edit Box	LAST_NAME	MYQKCONTACTSTBL	MYQUICKC			
23	14	1	Telephone	Edit Box	PHONE	MYQKCONTACTSTBL	MYQUICKC			
24	15	1	Email Address	Edit Box	EMAIL_ADDR	MYQKCONTACTSTBL	MYQUICKC			
25	16	1	Data Area Drop Zone (Level 1)	Group Box	MQC_DZ_2	MYQKCONT_WRK	MYQUICKC			
26	17	1		Subpage			MYQUICKC			
27	23	1		Group Box			MYQUICKC			
28	24	1	Edit	Push Btn/Link	EDIT_BTN	MYQKCONTR_WRK	MYQUICKC			
29	25	1	Delete	Push Btn/Link	DELETE_BTN	MYQKCONTR_WRK	MYQUICKC			
30	4	0		Horizntl Rule			MYQUICKC			
31	3	0	Bottom of Page Drop Zone	Group Box	MQC_DZ_3	MYQKCONT_WRK	MYQUICKC			
32	6	0		Subpage			MYQUICKC			

**Important!** If you insert multiple drop zones on the same page, always inspect and fix the order of group boxes and subpages on the Order tab.

- For classic pages only, open the Page Properties dialog box. On the Use tab, select the *Adjust Layout for Hidden Fields* check box.
- Save your changes.
- (Optional) Use the page preview in Application Designer to preview the page with drop zones.

**Special Considerations for Drop Zones on Fluid Pages**

Note that adding a related content group box on a fluid page creates a “drop zone.” These fluid drop zones can be configured for two purposes:

- Embedded related content only.

**Note:** The absence of the PT\_ERCSUBPAGE\_STUB subpage means that such a group box can be configured for embedded related content only.

Embedded related content was introduced in PeopleTools 8.55. While the procedure for creating and configuring embedded related content has not changed, the group box itself is now also referred to as a drop zone. See "Working with Embedded Related Content" (PeopleTools 8.58: Fluid User Interface Developer’s Guide).

- Dynamically injected custom subpages or embedded related content.

A related content group box created for dynamically injected custom subpages could be configured for embedded related content instead. However, both uses cannot coexist simultaneously. If a drop zone already configured with embedded related content is reconfigured with a custom subpage, then the embedded related content configuration is overridden. If a drop zone is already configured with a custom subpage, it will not be available for configuration with embedded related content.

## Related Links

"Configuring PeopleTools Options for Fluid Applications" (PeopleTools 8.58: Fluid User Interface Developer's Guide)

[Previewing Pages in the Browser](#)

"Working with Embedded Related Content" (PeopleTools 8.58: Fluid User Interface Developer's Guide)

## Creating Custom Subpages for Drop Zones

### Considerations for Creating Custom Subpages

Consider the following when creating custom subpages for dynamic injection into drop zones:

- The records and fields defined on your subpage will be loaded into the component buffer along with the records and fields defined on the page containing the drop zone.
  - However, the fields from your subpage that are dynamically added to the component buffer at runtime are not available in the component's search record or its add search record.
  - In addition, the fields from your subpage that are dynamically added to the component buffer at runtime are also not available in component interfaces.
- Multiple updatable tables are allowed at level 0 only.
- If you add a grid or scroll area to the subpage, you *must* add a horizontal rule after it to reset the level to 0.
- Unlike when a subpage is added directly as a page control on a main page definition, with this sort of dynamically injected subpage you cannot perform a record name substitution (that is, identify a *from record* on the subpage and a *to record* from the main page as described in [Understanding Subpages](#)).
- Record field PeopleCode defined on your subpage will execute as part of the events in the component processor flow. If your implementation requires other scenarios or PeopleCode events, (for example, page Activate, PreBuild, PostBuild, component record, or component record field events), then you must use PeopleCode event mapping to avoid customizing delivered components and pages. See "Mapping Application Class PeopleCode to Component Events " (PeopleTools 8.58: Portal Technology) for more information.

---

**Note:** While drop zones can be added to pages in unregistered components, unregistered components do not support event mapping.

---

### Creating a Fluid Subpage Definition

To create a fluid subpage definition:

1. In Application Designer, select File, New.

2. Select Page (Fluid) in the New Definition dialog box, and click OK.
3. Select *PSL\_SIMPLE\_SBP* to create a fluid subpage.
4. Click Choose, and then enter the name for your custom subpage in the Save As dialog box.
5. Indicate whether you'd like to save the PeopleCode associated with the layout page for your new page (Yes/No).

---

**Note:** Typically, click Yes to include any PeopleCode from the layout page.

---

6. Open the Page Properties dialog box.
7. On the Use tab, select *Subpage* to specify this as a fluid subpage.
8. Add page controls on your subpage definition.

### Creating a Classic Subpage Definition

To create a classic subpage definition:

1. In Application Designer, select File, New.
2. Select Page in the New Definition dialog box, and click OK.
3. Open the Page Properties dialog box.
4. On the Use tab, select *Subpage* to specify this as a classic subpage.
5. Insert a container that encompasses the full extents of the page definition. All other page controls inserted on your custom classic subpage must be enclosed by this container. You can use either a group box or a frame as this container.
6. Apply styling and settings to the container per your requirements. In some circumstances, you may want a title and borders on the container:

For a group box container:

---

**Important!** Do not select Drop Zone Group Box on the Use tab. This setting pertains only to the drop zone itself, which is found on the main page.

---

- Clear the label text on the Label tab.
- Set the Label Style to *PAGROUPBOXLABELINVISIBLE*.
- If the drop zone appears in a classic plus component, set the Body Style to *PSGROUPBOXCONTAINER* to remove margins, padding, and the label from the container.
- Select the *Adjust Layout for Hidden Fields* check box.
- Optionally, select the *Hide Border* check box.

For a frame container:

- Clear the label text on the Label tab.

- Set the Style to *PSGROUPBOXCONTAINER*.
- If the drop zone appears in a classic plus component, set the Body Style to *PSGROUPBOXCONTAINER* to remove margins, padding, and the label from the container.
- Select the *Adjust Layout for Hidden Fields* check box.
- Optionally, select the *Hide Border* check box.

7. Add page controls on your subpage definition.

## Related Links

[Understanding Page Design and Development](#)

[Using Subpages](#)

## Configuring Drop Zones

Use the Configure Drop Zones pages to search for, select, and configure components containing configurable drop zones, including unregistered components.

### Navigation

PeopleTools >Portal >Configure Drop Zones

### Image: Configure Drop Zones search page

This example illustrates the fields and controls on the Configure Drop Zones search page. You can find definitions for the fields and controls later on this page.

**Component Search Criteria**

Use the following criteria to search for a component to be configured for drop zones. You may use a percent sign (%) to indicate a wildcard.

Note: Search results may include components that cannot be configured because no drop zones are available in the component.

Component

Type

Description

Market

Object Owner ID

Configured Subpage

---

**Search Results** 30 rows

Component Name	Market	Object Owner ID	Description	Configured	List of Configured Subpages
HGA_ABS_PGLT	Global	TL Rules and Monitoring	Absences Approval	No	
HGA_CAN_XFER	Global	Absence Management	Absence Cancel transfer	No	
HGA_DYN_TIL_CON_FL	Global	Absence Management	Dynamic Tile Content	No	
HGA_EA_CS_DATA	Global	Absence Management	Extended Absence Detail	No	
HGA_EA_REQ_DTL_FLU	Global	Absence Management	Manage Extended Absence	No	

You must enter one or more search criteria to perform a search using this page. You may use % as a wildcard.

<b>Component</b>	Enter a definition name for the component as search criteria.
<b>Type</b>	Select either <i>Fluid</i> or <i>Classic</i> to limit search results to either fluid or classic components.
<b>Description</b>	Enter the description as defined on the General tab of the Component Properties dialog box as search criteria.
<b>Market</b>	Select the market for the component from the drop-down list.
<b>Object Owner ID</b>	Select the object owner ID for the component from the drop-down list.
<b>Configured Subpage</b>	Enter the definition name for an already configured subpage as search criteria.

**Important!** Search results may include components that cannot be configured because no drop zones are available in the component. Clicking such a component in the list will display a message that no drop zones are available.

In the search results, click a row to configure the available drop zones for that component.

**Image: Configure Drop Zones configuration page**

This example illustrates the fields and controls on the Configure Drop Zones configuration page. You can find definitions for the fields and controls later on this page.

<b>Component</b>					
Component HGA_EA_REQ_DTL_FLU					
Description Manage Extended Absence					
Type Fluid					
<b>Drop Zones by Page</b>					6 rows
Page Name	Tab Order	Drop Zone	Subpage Name	Reconfigured	
HGA_EA_DATA_FLU	2	DZ-Top of Extended Absence Template Data	MY_EXT_ABS_TMP_SBF	<input type="text"/>	
HGA_EA_DATA_FLU	6	DZ-Bottom of Extended Absence Template Data		<input type="text"/>	
HGA_EA_REQ_DTL_FLU	13	DZ-Top of View Extended Absence		<input type="text"/>	
HGA_EA_REQ_DTL_FLU	57	DZ-Bottom of View Extended Absence		<input type="text"/>	
HGA_EA_REQ_HST_SCF	3	DZ-Top of Request History	MY_REQ_HIST_SBF	<input type="text"/>	
HGA_EA_REQ_HST_SCF	15	DZ-Bottom of Request History		<input type="text"/>	Y
<input type="button" value="Save"/> <input type="button" value="Return to Component Selector"/>					

**Page Name** Displays the name of the *main* page that contains a drop zone or that contains a subpage with a drop zone, or it displays the name of a secondary page that contains a drop zone.

**Note:** Subpage names are not displayed in the grid; only the name of the main page that contains the subpage or nested subpage is displayed.



---

**Note:** If you are attempting to configure a secondary page and that page does not appear on the list for this component, then the link to this secondary page is missing—that is, there is no secondary page control on the main page or subpage that launches the secondary page. Since modifying the main page or subpage yourself would be considered a customization, contact support to determine whether a bug should be logged.

---

**Tab Order**

Displays the tab order number for the drop zone from the Order tab of the page definition (page or subpage) where the drop zone group box is physically defined.

**Drop Zone**

Displays the label for the drop zone, which is derived from these values in descending order of precedence:

- The label for the drop zone group box.
- The default label for the record field associated with the group box.
- A string that is the concatenation of the page definition (page or subpage) where the related content group box is physically defined plus the field ID for the group box as found on the Order tab. For example:

```
PAGE_NAME_ID.Field_ID
```

---

**Important!** If the label of a field other than the drop zone group box is displayed, then the PT\_ERCSUBPAGE\_STUB subpage is positioned incorrectly on the page definition. In particular, check the Order tab. Since modifying the main page or subpage yourself would be considered a customization, contact support to determine whether a bug should be logged.

---

**Used By Related Content**

(Fluid only) Indicates that this drop zone has been configured for fluid embedded related content. Reconfiguring it with a subpage overrides the embedded related content configuration.

**Subpage Name**

Select a subpage to associate with the drop zone.

---

**Note:** Because fluid drop zones can be associated with fluid subpages only and classic drop zones can be associated with classic subpages only, the search results are filtered to show valid subpages only, and not all subpages.

---

To remove a subpage configuration, clear the Subpage Name field and save your changes.

**Reconfigured**

Indicates that an existing subpage configuration has been changed.

---

**Note:** This indicator is displayed only after you save your changes. It is not displayed if you return to reconfigure drop zones for this component.

---

## Related Links

"Working with Embedded Related Content" (PeopleTools 8.58: Fluid User Interface Developer's Guide)

---

## Producing Pages

This section provides an overview of page production and discusses how to:

- Change general page information.
- Change page use information.
- Save pages.
- Rename and delete pages.
- Print page definitions.
- Alter page setup.
- Read a page definition report.

## Understanding Page Production

If you change pages or delete controls in the page definition, use the tools in the Edit and File menus. To avoid making changes that might adversely affect your application database, review your plans with your database administrator. Together, you can evaluate the effect that your actions might have on the system database as a whole.

Several additional steps in the page design process help make future editing of page definitions easier.

After you design a page, you must set the attributes for how the page should function and make sure that you have the proper documentation to assist you when performing upgrades. Access the Page Properties dialog box by selecting File > Definition Properties in page definition mode.

Use the General tab in the Page Properties dialog box to document the page. Enter both short and long descriptions of the page here. You can also document what changes have been made, or must be made, to a page.

## Changing General Page Information

Access the Page Properties dialog box and select the General tab. Enter a description and any comments about the page and assign an Owner ID.

**Image: Page Properties dialog box: General tab**

This example illustrates the fields and controls on the Page Properties dialog box: General tab.

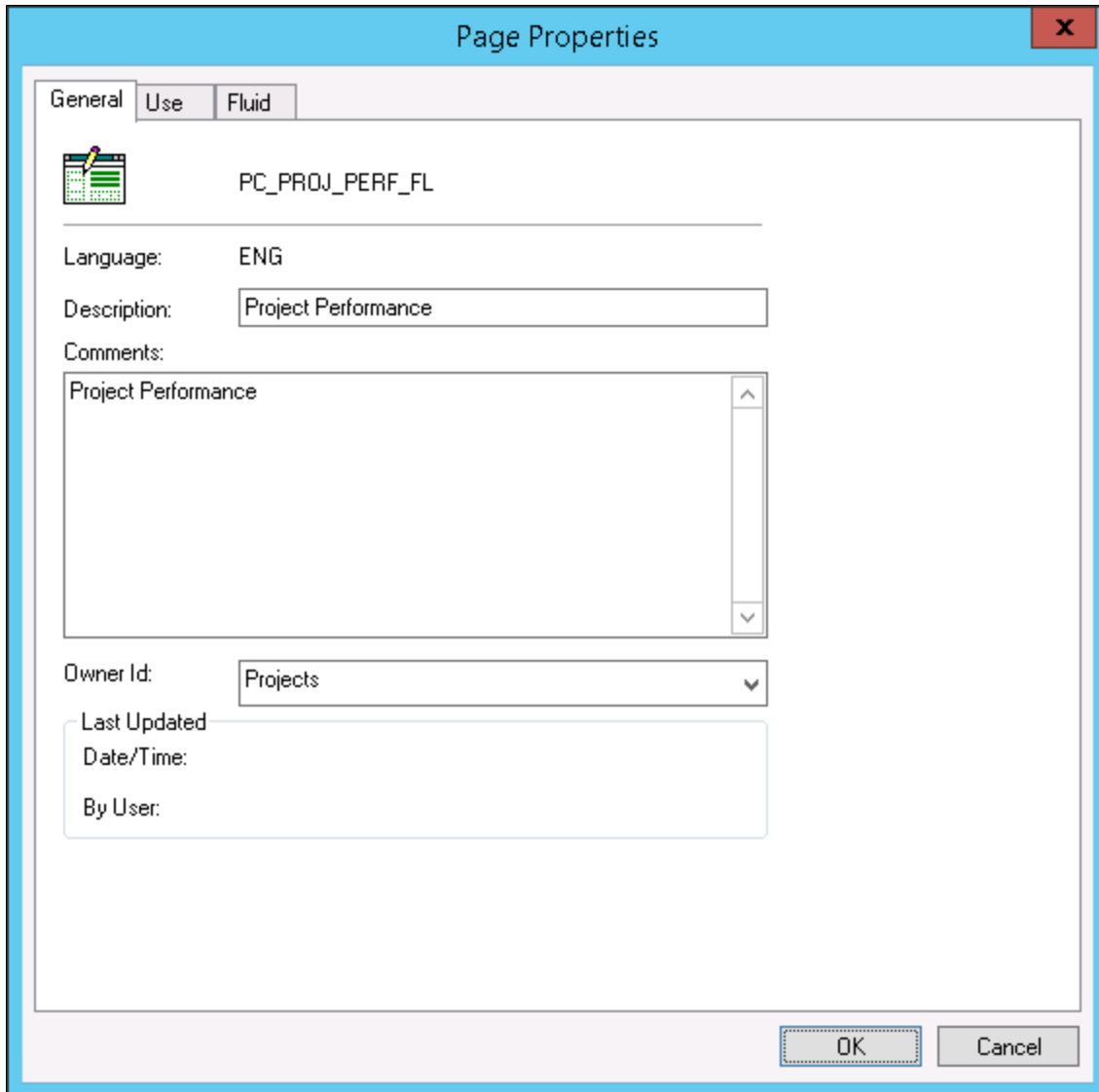
**Changing Page Use Information**

Access the Page Properties dialog box and select the Use tab.

**Image: Page Properties dialog box: Use tab**

This example illustrates the fields and controls on the Page Properties dialog box: Use tab. You can find definitions for the fields and controls later on this page.

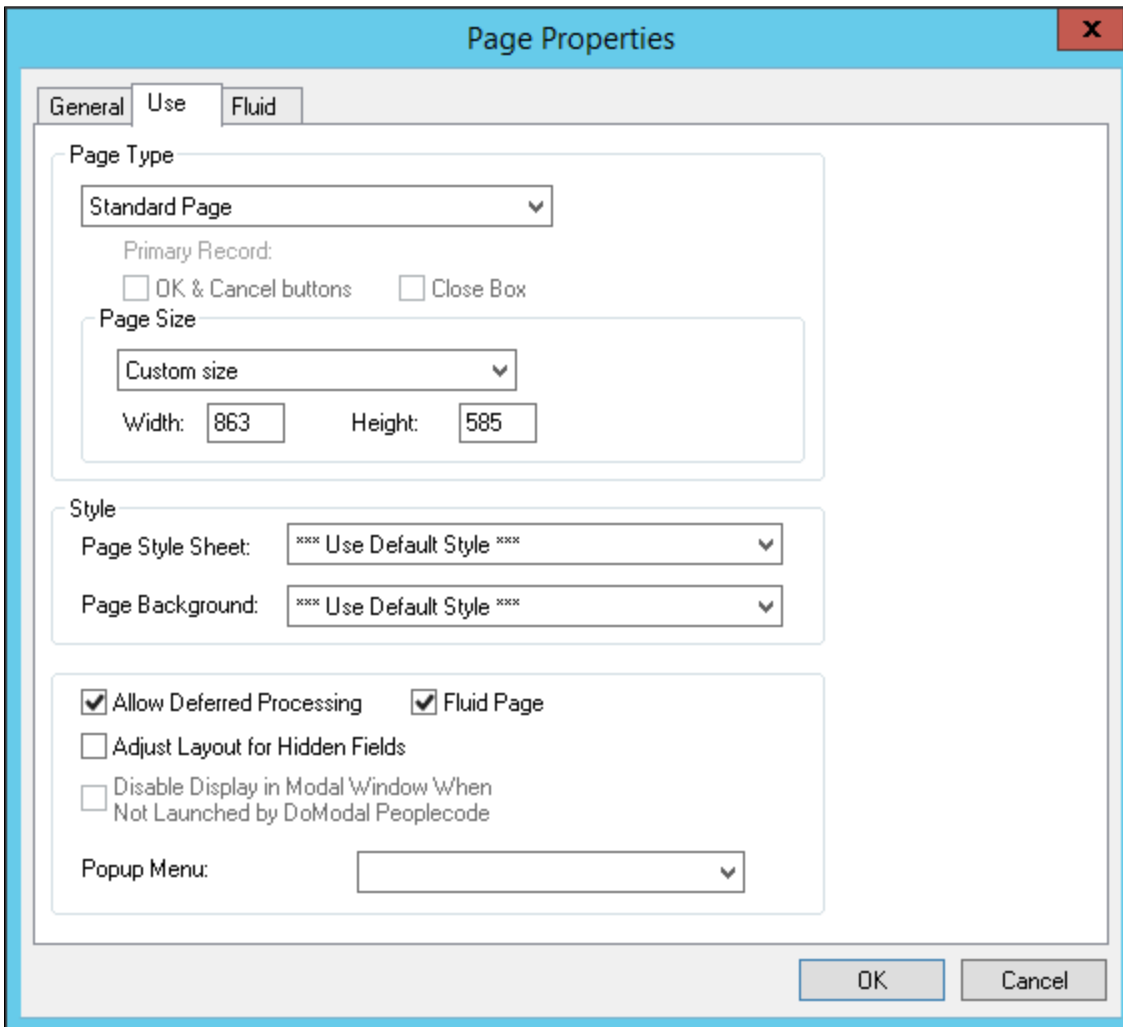

**Page Type**

Select *Standard page*, *Subpage*, *Secondary page*, or *Popup page* from the drop-down list box.

See [Understanding Subpages](#).

See [Understanding Secondary Pages](#).

See [Using Pop-up Pages](#).

**Page Size**

To accommodate different types of workstation monitors, you can adjust the page size.

**800×600 page inside portal**

This value is the standard option for viewing pages in the portal, providing room for the universal navigation header and the menu. It provides a default page size of 570×330 in PeopleSoft Application Designer.

**800×600 page without portal**

You should develop most pages using this option. It is the standard option for viewing pages, providing room for the navigation header and the menu. This option provides a default page size of 760×330 in PeopleSoft Application Designer.

**1024×768 page inside portal**

Selecting this option provides an optimal display for users with a 1024×768 resolution, showing the full transaction page and the menu. Users with an 800×600 display will see the full transaction page without the menu when the menu is enabled. This option provides a default page size of 760×498 in PeopleSoft Application Designer.

**1024×768 page without portal**

For the power user, this is a high-resolution option. It provides a default page size of 984×498 in PeopleSoft Application Designer.

**240×Var portal home page comp.**  
(240×variable portal home page component)

Use this setting only for creating pagelets for the portal. This size is most usable because it can be viewed in both the narrow area and the wide area of the portal. The system sets the width to 240, but you set the height.

**490×Var portal home page comp.**  
(490×variable portal home page component)

Use this setting only for creating pagelets for the portal. Pagelets that use this setting can appear only in the wide area of the portal. The system sets the width to 490, but you set the height.

**640×480 Windows screen**

This option is a deprecated feature used only for Windows client users. This option is designed for VGA resolution. The pages are actually less than 640×480 pixels in size in PeopleSoft Application Designer because they provide space for various windows items, such as the window title, menu bar, and toolbar.

**800×600 Windows screen**

This option is a deprecated feature used only for Windows client users. This option is designed for Super VGA resolution. These pages provide space for the window title, menu bar, toolbar, folder tabs, and status line, as well as space at the bottom for the toolbar.

**Custom size**

Select to set a specific page size other than those listed previously. Set the width and height manually.

**Style****Page Style Sheet**

Select a different style sheet for a specific page to override the style sheet that is selected for the application. If you do not select a different page style sheet (keeping *\*\*\*Use Default Style\*\*\**), the system uses the style sheet that is specified on the PeopleTools Options page.

**Page Background**

Select a different page background style class to override the background style of the page style sheet specified above. If you keep the *\*\*\*Use Default Style\*\*\** setting, the system uses the default background of the page style sheet.

---

**Note:** The style options that you select in the design time environment might look different at the runtime rendering of the page. For example, font and page control sizing metrics are different in the design time Windows environment and the runtime browser environment. As such, when developing pages, do not rely entirely on the rendering of the page in PeopleSoft Application Designer to gauge layout considerations, such as font size and the placement of controls. You should view all pages in the runtime browser environment and adjust them accordingly.

---

## Additional Settings

<b>Allow Deferred Processing</b>	Deselect if you want the page and all of its fields to follow standard processing. Deferred processing is the default.
<b>Fluid Page</b>	Select this option only if creating a page for a fluid application. This setting is required for fluid pages only.  For more information on creating fluid pages, see "Creating Fluid Pages" (PeopleTools 8.58: Fluid User Interface Developer's Guide).
<b>Adjust Layout for Hidden Fields</b>	Select to set the page to resize automatically when hidden fields are present.
<b>Disable Display in Modal Window When Not Launched by DoModal PeopleCode</b>	Applies only to secondary pages. Select to enable the modal window only when launched by DoModal PeopleCode.
<b>Pop-Up Menu</b>	See <a href="#">Defining Pop-up Menus</a> .
<b>Free Form StyleSheet</b>	Select a free form style sheet containing styles used by this page.

## Setting Fluid Properties for Pages

The Fluid tab applies only to pages created for fluid applications. For more information on creating fluid applications, refer to the product documentation for *Fluid User Interface Developer's Guide*.

For general information on the fluid user interface, see "Fluid User Interface Overview" (PeopleTools 8.58: Fluid User Interface Developer's Guide).

For information on fluid page properties, see "Setting Properties for Fluid Pages" (PeopleTools 8.58: Fluid User Interface Developer's Guide).

## Saving Pages

To save your work, select File > Save or File > Save As.

When you save your page, the system performs various edits and issues warning messages as appropriate. The warning explains any errors that are associated with each control. You can disregard these messages and save your work anyway, but you cannot view the page in the browser until all errors are corrected.

Access the explanation of an error message by clicking the Explain button in the warning message box. You can fix the problem immediately or save the page and return later to correct it.

## Renaming and Deleting Pages

If you rename a page, the change is reflected throughout the system, including in PeopleCode, so you do not have to change the page name anywhere else.

To delete a page, particularly a subpage or a secondary page, first use the Find Definition References option to determine which page, component, and menu definitions refer to or use the page you want to delete.

### Related Links

[Renaming Definitions](#)

[Deleting Definitions](#)

[Finding Definition References](#)

## Printing Page Definitions

To keep track of your application definitions and refinements, print your page definitions and keep a log or binder with your new and revised pages as you reconfigure your applications. You may want a reference for each page that includes both the on-screen image and the page control information (the record definitions and special uses or edits that you applied), as well as the information for any subpages that are included in the page definition.

Printing page definitions also helps you debug during testing. Each report includes a unique identifier that the system automatically increments each time you change the page.

To print a page definition:

1. Open the appropriate page.
2. Select File > Print.

## Altering Page Setup

Access the Print Setup dialog box by selecting File > Print Setup.

### Print

All print options are selected by default.

<b>Definition</b>	Select to print the list of fields on the page and all of the parameters that you set for each one.
<b>PeopleCode</b>	Select if you used PeopleCode to design your page
<b>Graphics</b>	Select to provide a snapshot of your page design. Graphics generally take longer to print than page descriptions or PeopleCode reports.

### Borders

**Header** Select to print a header at the top of the report indicating the date and time that you printed the report and the database name,

page name, version number, and page number. This option is selected by default.

**Footer**

Select to print a footer at the bottom of the report indicating the date and time that you printed the report and the database name, page name, version number, and page number. This option is deselected by default.

**Border**

Select to print a border or box around a page report. This option is deselected by default.

**Border Space (mm)** (border space (in millimeters))

Select to insert a set amount of space between a graphical border around the page report and the margins of the report. Deselect this option to print in character mode (faster) rather than in graphics mode (slower). The default space is 3 mm, but you can change it.

**Margins**

Set the distance, in millimeters, from the edge of the page to the left, right, top, and bottom edges of the page image or report. The defaults are:

- Top: 20.
- Bottom: 5.
- Left: 10.
- Right: 0.

**Reading a Page Definition Report**

This table lists the columns on the page definition report and describes their content:

<b>Column</b>	<b>Content</b>
Num (Number)	Sequential number that shows the position of the field in the field order list for the page.
Field Type	Field type, such as edit box.
Label Text	The label associated with the field, regardless of whether the label appears on the page.



<b>Column</b>	<b>Content</b>
Label Type	<ul style="list-style-type: none"> <li>• None: Label does not appear on the page.</li> <li>• Text: Static text.</li> <li>• RFT Long: Long name for the field (from the record definition).</li> <li>• RFT Short: Short name for the field (from the record definition).</li> <li>• XLAT Long: Long name for the value (from the Translate Table).</li> <li>• XLAT Short: Short name for the value (from the Translate Table).</li> <li>• Bitmap: Bitmap appears on button face.</li> </ul>
Record Name	Record name where the field is located.
Field Name	Field name on the record definition with which the page field is associated.
Siz (size)	Field size (custom, minimum, or maximum).
Alg (alignment)	Alignment (left or right).
On	Value of the radio button or the on value of the check box (typically Y).
Off	The value of the radio button or the off value of the check box (typically N).
DSP (display)	Yes indicates a display-only field.
INV (invisible)	Yes indicates an invisible field.
CTL (control)	Yes indicates a display control field.
REL (related)	Yes indicates a related display field.
RelNum (related number)	Number (Num column) of the display control field for this related display field.
CUR (currency)	Yes indicates a multi-currency field that does not appear unless the user is operating in multi-currency mode.
DER (derived)	Yes indicates a field from a derived or work record.
OccLvl (occurs level)	Occurs level of scroll bar that governs this field.

You may see additional reference lines following each field or at the end of the report:

<b>Reference</b>	<b>Description</b>
Page Help Context: <i>nnn</i>	Indicates that the page was assigned a page help context number that links it to a help file that describes how the field is used wherever it appears in the database.
Field Help Context: <i>nnn</i>	Indicates that this field, as used on this page, was assigned a record field help context number that links it to a help file that describes how the field is used only as it appears in this record definition.

---

## Working with Pages in Foreign Languages

This section provides an overview of working with pages in a foreign language and discusses how to:

- Perform a Save As using foreign language pages.
- Delete foreign language pages.

### Understanding Working with Pages in a Foreign Language

Many organizations are multinational, operating their business in multiple countries and continents. For efficiency, these organizations typically deploy a single application in multiple languages. However, because internal application developers and administrators may not be familiar with each language in which applications are deployed, this can cause difficulty when updating or maintaining the applications. To assist developers at multinational organizations, PeopleSoft provides a Save As option and a Delete option when working with foreign language pages.

### Performing a Save As Using Foreign Language Pages

PeopleSoft Application Designer enables developers to modify pages in their base language and save the page in another language. This capability decreases the time required to develop pages in other languages, and it relieves developers from having to modify pages in languages they do not understand. To open a page definition in your base language and save the changes to another language, use the Save As option.

The Language drop-down list box on the Save As dialog box is only available when you are signed onto the database in the base language. When performing the Save As, select the appropriate language from the Language drop-down list box.

If the page definition exists in the foreign language (in the non-base language), the system prompts you to confirm an overwrite of the definition.

---

**Note:** You can save modifications to a non-base language only if the base language definition already exists. If the base language page does not exist, then the system saves the page to the base language, regardless of the language selected.

---

**Note:** After doing a Save As to another language, the page will still appear in PeopleSoft Application Designer in the base language.

---

## Deleting Foreign Language Pages

When you are signed onto the database in the base language, the Delete dialog box contains the Language drop-down list box. The Language drop-down list box enables you to delete multiple pages from multiple non-base languages.

---

**Note:** Deleting the base language page automatically deletes all translated pages for the deleted base language page.

---

## Improving Online Performance

To improve the online performance of internet applications, you must optimize the transmissions to the server. Optimizing transmissions improves overall processing speed, reduces a user's data entry time, and increases productivity.

## Understanding Processing Modes

PeopleSoft applications can run in two different processing modes: interactive and deferred.

### Interactive Mode

In interactive mode (formerly called standard), when the user exits a field that has a field-level event (for example, FieldChange, FieldEdit, or RowInit PeopleCode; prompt validation; related display; and so on):

1. A transmission to the application server occurs immediately so that it runs the field-level event.
2. The system refreshes the information.

### Deferred Mode

In deferred mode, the application enables you to temporarily delay many of the conditions that need server processing until you encounter an event or condition that *requires* immediate processing or until you request processing manually. For example, when a user exits a field that has a field-level event (like FieldChange or FieldEdit PeopleCode, prompt validation, related display, and so on), that event is not processed until the next transmission to the application server. When the next transmission to the server occurs, PeopleTools determines which fields have changed since the last transmission. Then, logic on the application server runs the appropriate system edits and PeopleCode events (in field layout order).

Deferred processing is the default mode at the field, page, and component levels. However, you can select interactive processing at the field, page, and component levels. Setting a page field to interactive affects that field only. Setting a page to interactive affects all page fields on that page, regardless of whether they are set to deferred. Similarly, setting a component to interactive affects all pages and all page fields within the component, regardless of their individual settings.

Transactions that are designed using deferred mode reduce traffic to the application server but do not operate interactively.

### Related Content and Processing Mode

When designing related content, you should carefully review and understand the interaction between the processing mode of any fields, pages, or components to which you associate related content services. This

type of careful review will reduce the likelihood that unexpected or contextually irrelevant data appears when the processing mode is incorrect.

You should use deferred processing judiciously when interacting with related content services.

## Refreshing Pages

Click the Refresh button on a page to force processing on the application server to determine which fields have changed since the last transmission and to run processing logic that is associated with those changes.

Users can also refresh by pressing the alt-0 hot key, which keeps the cursor in the same field when the system displays the page. You can refresh at any time during data entry to enable an expert user to:

- Update related display field values for data that is already entered.
- Recalculate totals and balances.
- Provide defaults that are based on data that was entered previously on the page.
- Validate the data that has been entered on the page so far.
- Invoke any Hide, UnHide, Gray, or UnGray PeopleCode that is associated with specific fields.

---

**Note:** The Refresh button does not refresh the page from the database. It does cause a server trip so that any deferred PeopleCode changes can be processed. If no deferred changes were made or the deferred changes do not cause any errors or other changes on the page, then clicking Refresh has no effect. The user might think that nothing happened. Fields on derived work records are not updated if the user clicks the Refresh button.

---

## Triggering Server Processing

The following table shows the events that cause the PeopleTools runtime environment to process logic on the application server when operating in deferred or interactive processing mode:

<i><b>Event</b></i>	<i><b>Deferred Processing</b></i>	<i><b>Interactive Processing</b></i>
Entering data in fields with PeopleCode (for example, FieldEdit and FieldChange) associated with them.	NA	X
Entering data in fields that have prompt table edits.	NA	X
Entering data in fields that have related displays.	NA	X
Inserting a row or series of rows in a grid or scroll area.	X	X
Deleting a row from a grid or scroll area.	X	X
Using the grid or scroll area controls to move forward or back.	X	X

<b><i>Event</i></b>	<b><i>Deferred Processing</i></b>	<b><i>Interactive Processing</i></b>
Selecting another page tab.	X	X
Selecting another grid tab.	X	X
Expanding or collapsing a collapsible section.	X	X
Clicking any button or icon on the page.	X	X
Clicking any link on the page.	X	X
Clicking the Refresh toolbar button.	X	X
Using the Refresh hot key.	X	X

## Working with Page Controls In Interactive Mode

Creating a page with numerous fields in interactive mode (Allow Deferred Processing is not selected) can affect page performance and functionality, depending on:

- The position of the interactive fields.
- How the end users will use the application.

If the interactive fields are in close proximity, end users may attempt to enter information into an interactive field, while another interactive field is processing information entered previously. This can cause page failure and information loss. This tends to occur more often when users tab quickly through page fields while entering information.

To avoid potential processing overlaps, Oracle PeopleTools recommends that you avoid placing interactive fields close to each other on the page, in terms of location and tab order.

## Using PeopleCode in Deferred Mode

When designing transactions to run in deferred mode, you:

- Code field edits in FieldEdit PeopleCode; you do not need to move field edits to SaveEdit PeopleCode.
- Code field change logic in FieldChange PeopleCode.
- Set all fields, including those that have FieldEdit or FieldChange PeopleCode, to deferred processing.
- Do not use gray and hide fields on the same page to achieve a form of progressive disclosure on the page.

Specifically, do not include Hide or UnHide and Gray or UnGray FieldEdit and FieldChange PeopleCode for definitions on the same page unless the page is triggered by a separate push button. Instead, use either page Activate PeopleCode or FieldChange PeopleCode for definitions that are on another page in the component. The appearance of the page should be static as the user enters values and moves between fields on the page.

You should hide or reveal definitions or set them to display-only in page Activate PeopleCode before the initial appearance of the page based on setup data, configuration options, or personalization settings. Set fields to display-only in PeopleCode by setting the DisplayOnly property in the Field class to *True*.

- Show all fields as a static form and perform cross-validation edits to prevent invalid data combinations from being written to the database.
- For cross-validation edits, always assume that the controlling field (for example, a radio button, check box, drop down list box, and so on) is correct when editing for invalid combinations.

Use SaveEdit to code cross-validation edits. If the transaction requires that the edits be performed before the user can select another folder tab, then code the edits in a function that is called from the page Activate PeopleCode for every other visible page in the component. If the transaction is a sequential process, add the cross-validation edits to the Next and Previous buttons that a user uses to navigate through the process. Code cross-validation edits at the record level if the cross-validation edits apply to all components, and at the component level if they apply to only one component.

## Publishing Messages in PeopleCode

Use the SavePostChange event, either from record-field or component PeopleCode, to publish messages online. PeopleTools has special logic in SavePostChange PeopleCode that defers publishing until just before the commit for the transaction. This PeopleCode minimizes the time that the system locks single-threaded PeopleSoft Integration Broker tables.

## Related Links

"Deferred Processing Mode" (PeopleTools 8.58: PeopleCode Developer's Guide)

## Using Page Controls in Deferred Mode

Consider the following information when you design transaction pages to run in deferred mode.

### Edit Tables

Set fields that have edit table validations to deferred. The user can click the Refresh button for immediate validation of the field; otherwise, the prompt validation is deferred until the next required transmission to the application server.

### Prompt Tables

Use deferred processing for prompt table edits that use %EditTable to set the prompt keys based on the values of other fields on the page. Deferred processing still results in the appropriate behavior being run. For example, if the user clicks the prompt icon, the system:

1. Determines which fields have changed since the previous server transmission.
2. Runs the appropriate PeopleCode events.
3. Applies the values from the page to the buffer.

This action results in setting the correct values before resolving the %EditTable function, provided that any controlling fields come before the prompt table edit based on the page layout order.

4. Runs the prompt table edit lookup logic for the corresponding field.

## Drop-Down List Boxes

Do not use drop-down list boxes when the high-order key values are set on the same page. If you do, it requires the server to transmit the correct drop-down list box values based on the high-order key values. Therefore, set the high-order keys on another page, if possible, or use a prompt lookup instead.

For pages that have an effective-dated scroll area and a drop-down list box based on the PSXLATITEM translate table, the drop-down list box is not refreshed when the effective date is changed on the page. However, the drop-down list box does accurately reflect the new effective date the next time that the page is displayed. Evaluate whether this is a problem for the transaction, based on whether customers typically enter effective-dated XLAT rows for the field and on how often changes to the XLAT values are made. If this is an issue, either replace the drop-down list box with an edit box and a prompt, or use the refresh icon after the effective date field.

Drop-down list boxes are a good design choice because they present users with a small number of selections from which they must select one. They are typically more appropriate than prompts for transactions that are targeted at casual, untrained users. Prompts are more appropriate when a power user is entering the transaction from a paper form or document that contains the necessary codes.

## Check Boxes and Radio Buttons

Remove any FieldChange PeopleCode associated with check boxes in a grid that are mutually exclusive (meaning only one row can be checked). Instead, implement cross-validation edits in SavePreChange PeopleCode. When you design cross-validation edits between a radio button or check box and any associated edit box fields, assume that the controlling field (in this case, the radio button or check box) is correct.

## Related Displays

When you include related displays on your pages, make sure that they are set to deferred mode and that the standard Refresh button is enabled. Then, users can press the Refresh hot key to display related displays when they want to see them. Self-service transactions should not display the code and corresponding related display; they should use descriptive prompts.

## Adding Multiple Rows

This feature enables the user to specify the number of blank rows to be added when clicking the Insert Row button.

The number of blank rows that the user specifies is included on the page when it is refreshed, so application server processing is no longer required to add individual rows.

Do not use this feature for effective-dated grids or scroll areas.

Multiple row inserts might not apply if the entire row is populated using PeopleCode, especially if the data is copied from previous rows. If a multiple row insert does apply, the default value of the ChangeOnInit property can be used. (The default value is True, which means that any PeopleCode updates done in the RowInit or RowInsert events set the IsChanged and IsNew properties to True.)

After a transaction is saved, empty rows are discarded before the page is displayed again to the user. An empty row means that the user did not access the data and that PeopleCode or record defaults might have been used to initialize the row for the initial display.

PeopleCode Save processing (that is, SaveEdit and SavePreChange PeopleCode) runs for all rows that are in the buffer (including the empty ones). Therefore, SaveEdit and SavePreChange PeopleCode should be coded so that it runs only if the field contains data or if the row properties IsNew and IsChanged are both true.

An alternative method is adding PeopleCode in the first save program in the component to explicitly delete any row based on the IsNew and IsChanged properties. If you choose this method, then rows should be deleted from the bottom of the data buffer to the top (last row first).

To implement multiple row insert:

1. Ensure that deferred processing is set.

Open PeopleSoft Application Designer and ensure that deferred mode is set for the component, all pages in the component, and all fields on each page.

2. Access the Page Properties dialog box of the appropriate control.
3. Enable multiple row insert.

For each grid or scroll area where appropriate, select the Allow Multi-row Insert check box under the Use tab in the grid or scroll area property sheet.

4. Add ChangeOnInit PeopleCode.

Setting the ChangeOnInit property for a rowset to FALSE enables PeopleCode to modify data in the row set during RowInit and RowInsert events without flagging the rows as changed. This functionality ensures that only changes entered by the user cause the affected row to be saved.

---

**Note:** Each rowset that is referenced by a grid or scroll area with multiple row insert enabled should have the ChangeOnInit property for the rowset, including child or lower-level rowsets, set to False. In addition, you must set this property before any RowInsert or RowInit PeopleCode for the affected row.

---

## Using Error and Warning Messages

When components, pages, and fields are set to deferred mode, FieldEdit PeopleCode errors and warnings do not appear when a user exits a field; they appear after the next application server transmission. Therefore, users might not receive an error message until they enter all of the data and click the Save button.

For FieldEdit error messages running in deferred mode, the system changes the field to red and positions the cursor at the field in error when it displays the message, enabling the user to associate the error message with a specific field. However, for warning messages, the system does not display fields nor reposition the cursor. Consequently, create warning messages that clearly describe to which fields they apply. For example, if a page contains a "Date out of range" warning, users will be confused if multiple date fields appear on the page.

## Processing on Autocomplete Fields

With fields configured for autocomplete (also referred to as type ahead), the system behaves as follows with respect to deferred processing:

- The system executes all pending PeopleCode events prior to displaying the autocomplete list.



- The system does not trigger a server trip after the user makes the selection from the autocomplete list.
- If there is a FieldChange event, the system will trigger a server trip, but only after the user tabs out of the field.

## Enabling Automatic Save for a Page

PeopleTools provides the ability for an application to enable automatic saves for pages. Each application may or may not utilize this feature, and each application may implement the feature differently. Review your PeopleSoft application documentation to determine if automatic saving has been implemented. The description in this section describes the general intent and behavior of this feature. If implemented by your application, then your application documentation will describe the implementation details for that application.

When a system timeout has been reached, the system displays a timeout warning to end users. When they click OK to acknowledge the timeout warning, the system begins a new timeout interval of the session. If the user fails to acknowledge the timeout warning, after a specified time after the warning has been displayed, the system times out. Any data entered after the last user save and prior to the timeout will be lost. The automatic save feature provides the ability to modify a page definition to avoid data loss as a result of session timeout.

The implementation of this capability involves adding a hidden push button to your page that points to a specific record field combination. If your application has implemented this feature, the record `XXX_ICAUTOSAVE` will exist in your database. The "XXX" refers to your application's three-letter identifier, such as HCM for Human Capital Management. This record contains one field (typically), named `ICAUTOSAVE`. For example, in the case of Human Capital Management, the push button points to `HCM_ICAUTOSAVE.ICAUTOSAVE`.

If this hidden push button exists on a page referencing the `XXX_ICAUTOSAVE` record, PeopleTools internal processing detects it and performs an automatic save of that page under these conditions:

1. The system has reached the end of a session timeout interval.
2. The system has displayed a timeout warning to the end user.
3. The end user has not acknowledged the timeout warning by clicking OK.

For more information, refer to your latest PeopleSoft application documentation and release notes.



# Creating Component Definitions

---

## Understanding Component Definitions

A component represents a complete business transaction. It comprises either a single page or a set of pages that is meant to be processed as one page. After you create pages, you add them to one or more components to access them through menus or in business processes.

This section discusses:

- What component definitions manage.
- The component buffer.

## What Component Definitions Manage

Component definitions manage:

- Groupings of pages and their associated tab labels.
- Search records that are used to retrieve data for the page.
- Access keys for folder tab navigation.
- Links at the bottom of a page.
- The toolbar at the bottom of a page.

This example shows a sample component with multiple pages:

**Image: Sample component with multiple pages (tabs)**

This example illustrates a sample component with multiple pages (tabs).

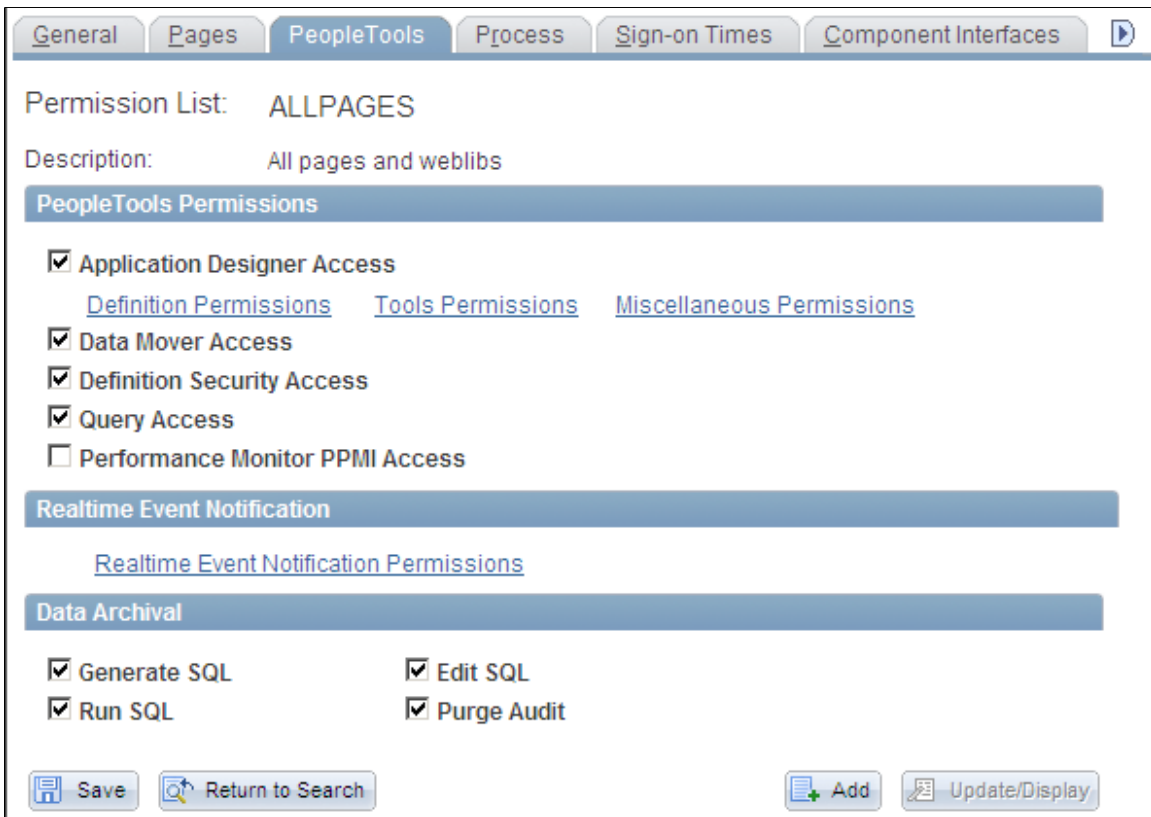

If a component contains more than one page, you can control which page appears first by setting the display order in PeopleSoft Application Designer. At runtime, the user navigates among the pages of a component by selecting:

- Folder tabs at the top of the page.
- Links at the bottom of the page.
- Specified keyboard shortcuts (designated by the underscore in the label of the page tab).

**The Component Buffer**

When you open any page in a component, the system retrieves all of the data records for the component and stores them in one set of record buffers organized by scroll level and then by page level. The component buffer consists of rows of buffer fields that hold data for the various records that are associated with page controls, including the primary records, related display records, derived work records, and Translate Table records.

You can change the records in memory either through the user actions on the page or through the PeopleCode that is associated with the different page controls. At runtime, you open and save the entire component, not just the individual pages. When you save any page in a component, you automatically save the whole component.

## Related Links

"Understanding Data Buffer Access" (PeopleTools 8.58: PeopleCode Developer's Guide)

## Defining Components

This section provides an overview of the component definition window and discusses how to:

- Create new component definitions.
- Open existing component definitions.
- Add pages to components.
- Reorder pages in a component.
- Copy or move pages to another component.
- Set page attributes.
- Validate components.

## Understanding the Component Definition Window

When you design component pages, the pages must share the same Level 0 key structure because they share the same search record.

Depending on the complexity of a component, the system may take longer to display the first page than to display other pages in the component (or even display the first page again) because it is loading records for the entire component.

The component definition window has two tabs, Definition and Structure, that provide different views of a component.

### Definition Tab

The default component definition view displays the page items and corresponding attributes of a component definition. You double-click the page name to open the page definition:

#### Image: Component definition view

This example illustrates the fields and controls on the Component definition view. You can find definitions for the fields and controls later on this page.

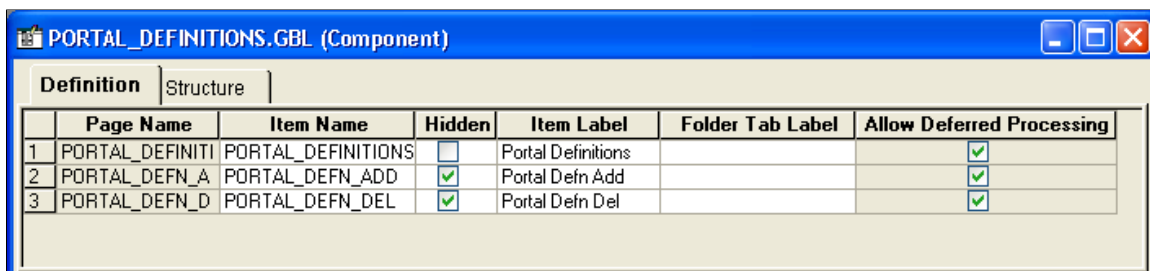

	Page Name	Item Name	Hidden	Item Label	Folder Tab Label	Allow Deferred Processing
1	PORTAL_DEFINITI	PORTAL_DEFINITIONS	<input type="checkbox"/>	Portal Definitions		<input checked="" type="checkbox"/>
2	PORTAL_DEFN_A	PORTAL_DEFN_ADD	<input checked="" type="checkbox"/>	Portal Defn Add		<input checked="" type="checkbox"/>
3	PORTAL_DEFN_D	PORTAL_DEFN_DEL	<input checked="" type="checkbox"/>	Portal Defn Del		<input checked="" type="checkbox"/>

## Structure Tab

The structure view shows records and scrolls in a tree representation. It provides information about page levels and component records and their roles. You double-click the objects in this view to open their definitions:

### Image: Component structure view

This example illustrates the fields and controls on the Component structure view. You can find definitions for the fields and controls later on this page.

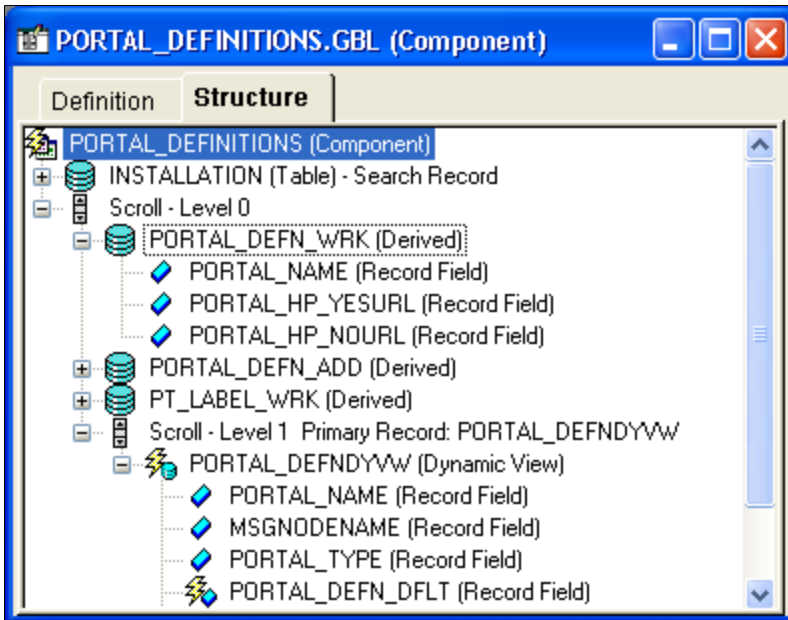

To view the PeopleCode that is attached to any of the components, right-click and select the View PeopleCode option from the pop-up menu. The PeopleCode Editor opens directly in the workspace, displaying the related PeopleCode.

---

**Note:** The Structure tab only displays the runtime state of the PeopleCode. That is, it only displays record field PeopleCode. For example, PeopleCode programs that are orphaned as a result of a page definition change do not appear in the Structure tab. On the other hand, these orphaned PeopleCode programs do appear in the PeopleCode Editor, which displays the design-time view of PeopleCode.

---



A key icon appears next to all key and alternative search key fields in the component structure view.



An asterisk icon appears next to all fields that are required.

## Creating New Component Definitions

To create a new component definition:

1. With a new or existing project open in PeopleSoft Application Designer, select File > New.
2. Double-click Component.

The new component definition appears in the workspace.

When saving a component definition, make sure to adhere to the accepted naming conventions for PeopleSoft definitions.

See [Saving Definitions](#).

## Opening Existing Component Definitions

To open an existing component definition:

1. Select File > Open.
2. Select Component as the type.
3. Specify the selection criteria.

The component definition appears in the workspace.

## Adding Pages to Components

This section discusses how to:

- Use the Insert menu to add a page.
- Drag a page into the component.

---

**Note:** The system does not allow you to move or delete all pages from a component definition. The component must contain at least one page definition.

---

### Using the Insert Menu to Add a Page

To use the Insert menu to add a page:

1. Open a new or existing component in the workspace and make the definition active.
2. Select Insert > Page into Component.
3. To narrow your search, enter selection criteria, such as name, description, or project.
4. Click Insert.

A list of available pages matching your search criteria appears.

5. Select the page that you want to add to the component.
6. Click Insert.

The page that you selected appears in the component in the workspace.

7. When you are finished adding pages to your component, click Close.
8. Save your component.

Component names can be up to 18 characters in length.

## Dragging a Page Into a Component

To drag a page into a component:

1. Open the project and component.
2. Drag pages from the project workspace to the component.

This is an example of dragging a page into a component definition:

### Image: Dragging from the project workspace to a component

This example illustrates the fields and controls on the Dragging from the project workspace to a component. You can find definitions for the fields and controls later on this page.

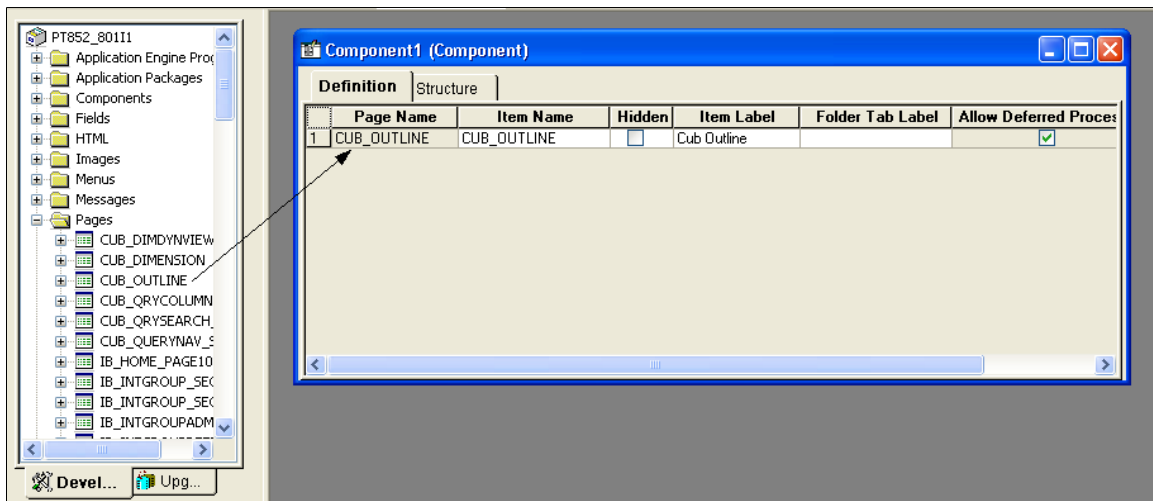

## Reordering Pages in a Component

After you add pages to a component, you can change the order in which they appear in the component.

### Image: Moving a page in a component

This example illustrates the fields and controls on the Moving a page in a component. You can find definitions for the fields and controls later on this page.

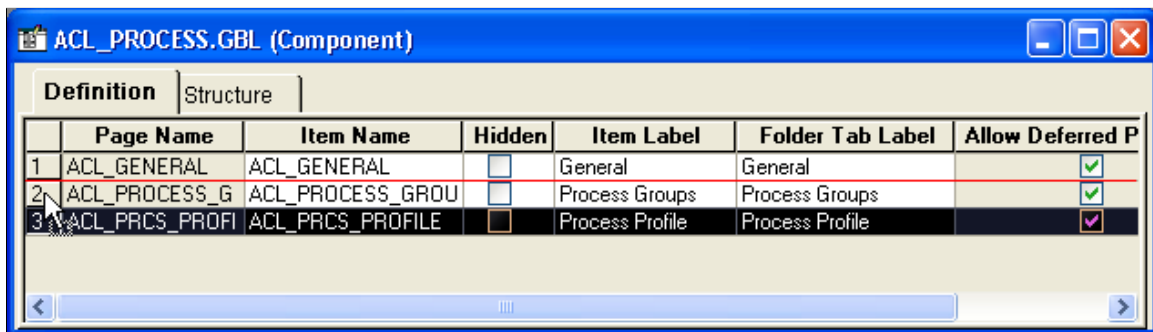

To reorder a page in a component:



1. Select a row number on the left-hand side of the component definition.
2. Drag the row to the correct position.

The page is inserted immediately below the highlighted line. In the preceding example, the third page (UK) becomes the second page.

## Copying or Moving Pages to Another Component

After you create a component, you can copy or move pages from one component to another.

---

**Note:** The system does not allow you to move or delete all pages from a component definition. The component must contain at least one page definition.

---

To copy or move a page from one component to another:

1. Open both components.
2. In the left-hand column, select the number of the page that you want to copy.
3. Copy or cut the page:
  - To copy the page to another component, select Edit > Copy.
  - To move the page to another component, select Edit > Cut.
4. Select the other component.
5. Select Edit > Paste.

## Setting Page Attributes

Each page in a component has attributes. Each attribute is represented by a column in the component definition:

### Image: Component item label and tab label

This example illustrates the fields and controls on the Component item label and tab label. You can find definitions for the fields and controls later on this page.

	Page Name	Item Name	Hidden	Item Label	Folder Tab Label	Allow Deferred Processing
1	AMM_OVERVIEW	AMM_OVERVIEW	<input type="checkbox"/>	Overview		<input checked="" type="checkbox"/>
2	AMM_PUBLIST	AMM_PUBLIST	<input type="checkbox"/>	Message Instances		<input checked="" type="checkbox"/>
3	AMM_PUBCONLIS	AMM_PUBCONLIST	<input type="checkbox"/>	Pub Contracts		<input checked="" type="checkbox"/>
4	AMM_SUBCONLIS	AMM_SUBCONLIST	<input type="checkbox"/>	Sub Contracts		<input checked="" type="checkbox"/>
5	AMM_SYNCMSGGLI	AMM_SYNCMSGGLIST	<input type="checkbox"/>	Synchronous Messa		<input checked="" type="checkbox"/>
6	AMM_CHNL_STAT	AMM_CHNL_STATUS	<input type="checkbox"/>	Channel Status		<input checked="" type="checkbox"/>
7	AMM_NODE_STAT	AMM_NODE_STATUS	<input type="checkbox"/>	Node Status		<input checked="" type="checkbox"/>
8	AMM_MULTIDOM	AMM_MULTIDOM	<input type="checkbox"/>	Domain Status		<input type="checkbox"/>
9	AMM_STATISTICS	AMM_STATISTICS	<input type="checkbox"/>	Statistics		<input checked="" type="checkbox"/>
10	PT_APMMSGQRY_P	PT_APMMSGQRY_PG	<input checked="" type="checkbox"/>	Queries		<input type="checkbox"/>
11	AMM_SHARED	AMM_SHARED	<input type="checkbox"/>	Amm Shared		<input checked="" type="checkbox"/>
12	IB_AMM_FAILOVE	IB_AMM_FAILOVER	<input checked="" type="checkbox"/>	Ib Amm Failover		<input type="checkbox"/>

#### Page Name

Displays the read-only name of the page definition. If you rename the page, the system updates this column automatically.

When creating page definitions, you might want to use similar names to make them easily recognizable as a group of pages.

For example, if you create three pages to hold the information for the Personal Data Table, the page names might be:

- PERSONAL\_DATA1
- PERSONAL\_DATA2
- PERSONAL\_DATA3

#### Item Name

Displays a name for each page in the component. This name must be unique in the component, and the default is the page name. This name is for informational purposes only. If you use the same page for more than one component, you might want to change the item name to reflect the purpose of the page in the component.

#### Hidden

Specifies whether the page can be viewed by the user at runtime. Pages are usually hidden when they are used in work groups or associated with derived work records. For example, information from a page might need to be loaded into the buffer for PeopleCode to perform calculations, but the user does not need to see it.

---

**Note:** Marking the page as hidden also hides the toolbar, including the Save button, even if you choose to display the page by means of another method, such as the Transfer PeopleCode function.

---

**Item Label**

Serves as the default folder tab label unless you specify a different label. The item label should be unique for each page in a single component menu. The folder tab label is usually used when shorter names are needed for folder tabs.

In the preceding example (BANK\_ACCOUNT.GBL), the same text appears on both the folder tab and the component menu for the first page in the component. The second and third pages have different menu names and folder tabs.

**Folder Tab Label**

Displays the text that appears on the folder tab label. If no text is specified, the system uses the text of the item label on the folder tabs.

**Allow Deferred Processing**

Indicates whether deferred processing is active for that page in its property settings.

**Setting Access Keys**

You can set access keys by placing an ampersand (&) in the text of each item label. Put the ampersand in front of the letter that you want to be underlined on the folder tab at runtime:

**Image: Item labels with ampersands**

This example illustrates the fields and controls on the Item labels with ampersands. You can find definitions for the fields and controls later on this page.

	Page Name	Item Name	Hidden	Item Label	Folder Tab Label
1	ACL_GENERAL	ACL_GENERAL	<input type="checkbox"/>	&General	&General
2	ACL_MENU2	ACL_MENU2	<input type="checkbox"/>	&Pages	&Pages
3	ACL_MISCTOOLS	ACL_MISCTOOLS	<input type="checkbox"/>	People&Tools	&PeopleTools
4	ACL_PROCESS	ACL_PROCESS	<input type="checkbox"/>	P&rocess	P&rocess
5	ACL_SIGNON2	ACL_SIGNON2	<input type="checkbox"/>	&Sign-on Times	&Sign-on Times

At runtime, a user can navigate between pages by pressing the Alt key plus the letter that is underlined, followed by the Enter key.

**Image: Underlined access keys on tabs**

This example illustrates the fields and controls on the Underlined access keys on tabs. You can find definitions for the fields and controls later on this page.

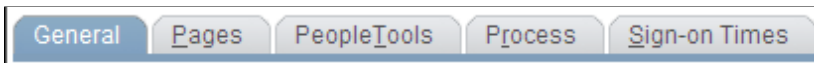

**Related Links**

Accessibility Guide

**Validating Components**

PeopleSoft Application Designer includes a validate utility to verify the integrity of components. The validate utility runs a series of tests on components to check that they will operate properly at runtime, and it sends the results to the Validate tab in the output window.

To validate a component:

1. Open the desired component definition.
2. Select Tools > Options > Validate and make sure that the Validate PeopleSoft Internet Architecture Execution option is selected.

---

**Note:** This option must be selected for the validate tests to be invoked.

---

3. Select Tools > Validate Component.
4. View the results that appear on the Validate tab and correct any errors.

### Related Links

[Setting PeopleTools Options](#)

[Validating Projects](#)

---

## Specifying Market-Specific Components

You might want to add custom features to a component that is specific to an international market or region. For example, suppose that a page is used in a procedure for hiring new employees and that the procedure includes special transactions that are required only when an employee is hired in Brazil. You can create a custom component using the same component name as the component from which it is derived and saving it using a market setting of *BRA*:

### Image: Component saved with BRA Market setting

This example illustrates the fields and controls on the Component saved with BRA Market setting. You can find definitions for the fields and controls later on this page.

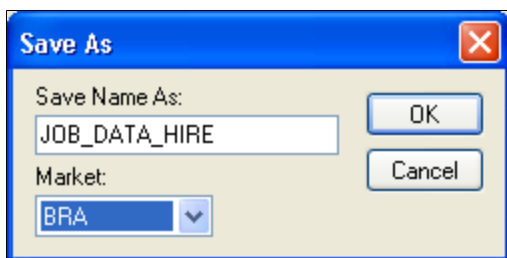

Market-specific components are independent of system-side language settings and are accessible to any users who have security access to the component. This setting enables an English-speaking user in New York, for example, to perform a procedure for hiring an employee in Brazil.

Access the market setting of a component using the PeopleCode %Market system variable. Consequently, you can maintain a single set of PeopleCode programs for a set of market-specific components and build conditional logic into the PeopleCode programs that run only in components with specific market settings.

### Related Links

["%Market" \(PeopleTools 8.58: PeopleCode Language Reference\)](#)

---

## Locating Component Definition References In Menus

The Find Definition References feature enables you to generate a list of the menus in the database that reference a specific component; that is, a list of the menus in which the component is used. You can invoke this feature from either the project workspace or the definition workspace. To invoke this feature, select Find Definition References from the Edit menu.

### Related Links

[Finding Definition References](#)

---

## Setting Component Properties

This section describes the properties you can set for components.

### Opening the Component Properties Dialog Box

To open the Component Properties dialog box:

1. Open the component definition.
2. Select File > Definition Properties.

The Component Properties dialog box appears with the General tab active.

### Setting General Properties

Access the Component Properties dialog box.

<b>Description</b>	Enter a descriptive name for the component.
<b>Owner ID</b>	Select the application to which this component belongs. This list is helpful to identify the applications that are associated with the component during the application development phase.
<b>Last Updated</b>	View the date and time of the last modification made to the component and the name of the user who made the modification.

### Setting Use Properties

Access the Component Properties dialog box and select the Use tab.

**Image: Component Properties dialog box: Use tab**

This example illustrates the fields and controls on the Component Properties dialog box: Use tab. You can find definitions for the fields and controls later on this page.

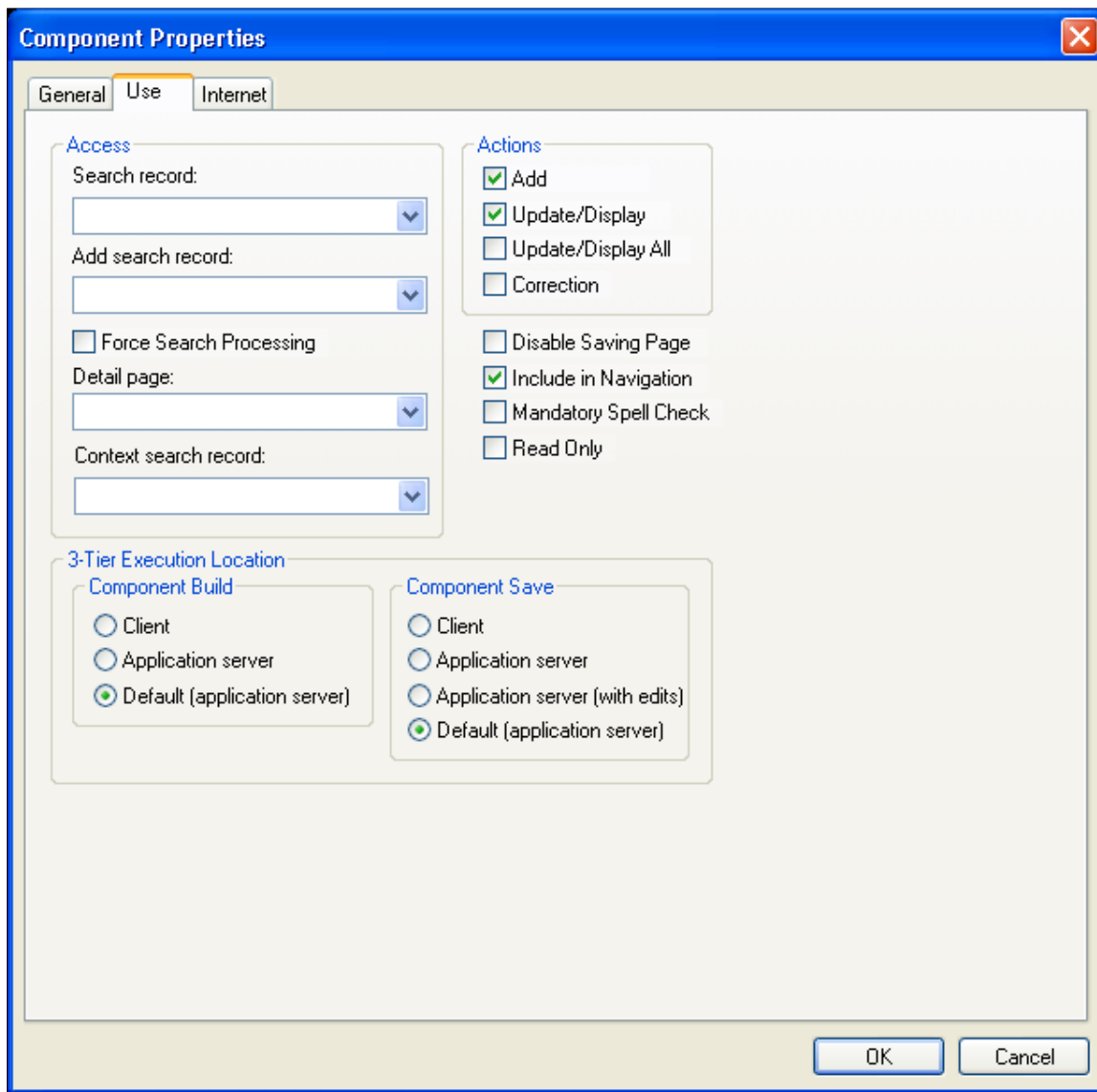

**Access**

**Search record**

Specify the search record for this component.

**Add search record**

Specify if you want a different search record specifically for add actions. For example, if you selected the auto-numbering option for employee IDs (EMPLID), do not include EMPLID in the search record. Likewise, you might want to create special security views for add actions that limit the rows that users can add based on specific search criteria. The system default is the standard search record if you do not specify an add search record.

**Force Search Processing**

Select to always run search logic (SearchInit PeopleCode) for this component. The default is deselected.

---

**Note:** If you select this option, all persistent search functionality for the component is disabled, regardless of system settings.

---

**Important!** Persistent search, the drop-down menu, and other forms of classic navigation are no longer supported. The default navigational interface for PeopleSoft applications in the current release is based on the fluid banner, which can be used for both classic and fluid applications.

---

See "Configuring Web Profiles" (PeopleTools 8.58: Portal Technology).

**Detail page**

No longer used in PeopleSoft applications. This option appears for upgrade purposes only.

**Context search record**

Specify the record that defines the service parameters that you must map for PeopleSoft component URL-related content services or content reference service types. The system uses the context search record only when no key fields are defined for the primary search record and only in a related content configuration.

"Understanding the PeopleSoft Related Content Framework" (PeopleTools 8.58: Portal Technology)

---

**Note:** To see a subset of search records, type a few characters first. The drop-down list box is populated with a list of all record definitions with names that begin with those characters, thus reducing access time and enabling you to find specific records faster.

---

**Actions****Add**

Select to add a new high-level key, such as a new employee ID or customer. Except in the case of effective dating, use Add to insert a new current row or to update future rows.

**Update/Display**

Select to update existing rows only.

**Update/Display All**

Select to update current and future rows in an effective-dated record. Use only with effective-dated records. Do not use these actions unless the main record that is associated with the page definitions is effective dated. This information is translated to include history at runtime.

**Correction**

Select to update any rows (history, current, and future) in an effective-dated record. Use only with effective-dated records. This information is translated to correct history at runtime.

**Disable Saving Page**

Select when you want to hide the Save button in the toolbar and disable the Alt+1 (Save) hot key. Selecting this option

prevents users from being prompted to save when exiting a page. However, it does not prevent using PeopleCode to save a page with the `DoSave()` or `DoSaveNow()` functions. This functionality can be helpful for applications in which the user is not making database changes and does not need to be prompted to save.

### **Include in Navigation**

Select to include the component in the menu navigation at runtime. The default is selected. If you do not want the component included, deselect the check box.

### **Mandatory Spell Check**

Select to ensure that spell check is run on all eligible spell check enabled fields in the component when a user saves the page.

A field is eligible if it has been changed (or its `ReEdit` flag has been set) and it has not already been manually spell checked since it was last changed.

---

**Note:** Spell check at the component level is not currently supported in fluid applications.

---

### **Read Only**

Select to have the component run against the standby database, which is used in systems where Oracle Golden Gate or Oracle Active Data Guard have been configured. For more information, see "Configuring Read-Only Components" (PeopleTools 8.58: Data Management).

---

**Note:** If you must add a new high-level key, such as a new employee number or customer, select both Add and Update/Display. If you are adding information to an existing high-level key, such as adding education data for an employee, select only Update/Display. You are not adding a new employee ID; it already exists on the database.

---

## **Three-Tier Execution Location**

This section applies only to Windows client applications.

To partition application processing between the client and the application server, you must define units that, as a whole, run in one location or the other. We call these units processing groups. Processing groups can encompass one or more PeopleCode events.

### **Component Build**

Specify where you want all processing to occur after the key list of a page is selected and before the user can interact with the page. Processing includes building component buffers and running many types of PeopleCode.

### **Component Save**

Specify where you want all processing to occur after the user saves the component and `SaveEdit` PeopleCode validations have succeeded. Processing includes `SavePreChange`, `Workflow`, `SavePostChange` PeopleCode, and updates to the database.



## Setting Internet Properties

Access the Component Properties dialog box and select the Internet tab.

### Image: Component Properties dialog box: Internet tab

This example illustrates the fields and controls on the Component Properties dialog box: Use tab. You can find definitions for the fields and controls later on this page.

The screenshot shows the 'Component Properties' dialog box with the 'Internet' tab selected. The dialog is divided into several sections:

- Search Page:**
  - Primary Action:  New,  Search,  Keyword Search
  - Default Search Action: Update/Display (dropdown)
  - Default Search/Lookup Type:  Basic,  Advanced,  Keyword Only
  - Allow Action Mode Selection
  - Link To Add Page: Message Set/Nbr: 124 / 62
  - Link To Find Existing Value Page: Message Set/Nbr: 124 / 63
  - Link To Realtime Search Page: Message Set/Nbr: 124 / 63
  - Link To Keyword Search Page: Message Set/Nbr: 124 / 433
  - Instructional Text: Message Set/Nbr: 124 / 50
- Multi-Page Navigation:**
  - Display Folder Tabs (top)
  - Display Hyperlinks (bottom)
  - Page Navigation in History
  - Return to Last Page in History
- Processing Mode:**
  - Interactive,  Deferred
  - Allow Expert Entry
  - WSRP Compliant
- Pagebar:**
  - Help Link
  - Copy URL Link
  - New Window Link
  - Customize Page Link
  - Disable Pagebar
- Toolbar:**
  - Selected Toolbar Actions:
    - Save,  Refresh
    - Cancel,  Notify
    - Spell Check,  View WorkList
    - Return to List,  Next in WorkList
    - Next in List,  Previous in WorkList
    - Previous in List,  Add
    - Next Page in Component,  Update/Display
    - Previous Page in Component,  Update/Display All
    - Hide Back Button,  Correction
  - Disable Toolbar

Buttons: OK, Cancel

## Search Page

### Primary Action

Select the default mode by which the user accesses the component.

Select New to access the component in Add mode.

Select Search to access the component in the mode that is specified in the Default Search Action field.

Select Keyword Search to access the component using the Keyword Search page. The Keyword Search page is available only if you have configured the PeopleSoft Search Framework and mapped the component to a search definition.

See "Working with Search Pages" (PeopleTools 8.58: Search Technology).

Specify where you want all processing to occur after the key of a page is selected and before the user can interact with the page. Processing includes building component buffers and running many types of PeopleCode.

**Default Search Action**

Select from a list of the actions that you set in the Actions group box on the Use tab of the Components Properties dialog box. If you set only one action, this drop-down list box provides that choice as the default. The default search action determines the default that users see, but they can select another option from the toolbar at runtime.

**Default Search/Lookup Type**

Specify the type of search or lookup which appears by default when users access the search page and lookup pages associated with the component.

Select Basic display the Basic search page by default. The Basic search page provides access to a list of search key and alternate search key fields from which the user can choose one field to search. You should select Basic as the default search type for new users because a basic search page is easier to use than other types of search pages.

Select Advanced to display the Advanced search page by default. The Advanced search page provide access to all search key and alternate search key fields simultaneously. You should select Advanced as the default search type for power users because an advanced search page enables complex searches.

Select Keyword Only to display just the Keyword Search page by default. The Keyword Search page is available only if you have configured the PeopleSoft Search Framework and mapped the component to a search definition.

See "Working with Search Pages" (PeopleTools 8.58: Search Technology).

**Allow Action Mode Selection**

Select to display the Include History and Correct History check boxes on a search page. If a user selects Include History on a search page, the page appears in Update/Display All mode. If a user selects Correct History, the page appears in Correction mode. However, both of these check boxes appear only on the search page if Update/Display All and Correction were selected as actions in the Use properties for the component and the user

has security access to the modes. This check box is selected by default.

**Link to Add Page**

Enter the message set and number that stores the text that comprises the link which users click to access the standard add page.

**Link to Find Existing Value Page**

Enter the message set and number that stores the text that comprises the link which users click to access the standard search page.

**Link to Realtime Search Page**

Enter the message set and number that stores the text that comprises the link which users click to access the Realtime Search page. Because Realtime search functionality is disabled by default, these values are the same as the values associated with the Link to Find Existing Value Page. However, if you enable Keyword Search, you can enter different values so that the link text accurately indicates the type of search page that users access via the link.

**Link to Keyword Search Page**

Enter the message set and number that stores the text that comprises the link which users click to access the Keyword Search page, which appears only when Keyword Search is enabled for the component.

**Instructional Text**

You set this option to display the Find an Existing Value heading on the search page. You can change the default message or redirect the component to use another message that is more appropriate for your use.

**Toolbar**

Select the toolbar actions that you want to appear on the component pages. When you select a check box, that item appears as a toolbar button at the base of the component at runtime. All toolbar actions are set to display by default with the exception of Next Page in Component , Previous Page in Component, and Notify. Note that the default settings for the Action and Save buttons are affected by settings on the Use tab of the Component Properties dialog box.

Disabling any of the toolbar options also disables the hot key for that option in the PeopleSoft Pure Internet Architecture.

**Save**

Adds a Save, OK, or Apply button to the toolbar, depending on the page type.

**Cancel**

For modal components only. Deselecting this check box removes the Cancel button from the toolbar.

**Spell Check**

Runs spell check for all spell check-enabled fields in the component, regardless of whether any changes were made to the field.

---

**Note:** Spell check at the component level is not currently supported in fluid applications.

---

<b>Return to List</b>	Returns users to the search page.
<b>Next in List and Previous in List</b>	Populates the page with the next or previous row of data from the database as shown on the Search page.
<b>Next Page in Component and Previous Page in Component</b>	Opens the next or previous page in the component if it has more than one page.
<b>Hide Back Button</b>	<p>Select to hide the Back button in the fluid-like portal header for classic components. This setting does not affect fluid components.</p> <p>In some situations, you may want to force end users to utilize only the navigation provided by the application, such as the Next or Previous buttons for example.</p> <p>Hiding the Back button enables you to keep the user within an expected procedural sequence and can avoid confusion between a Back and a Previous button if both are displayed. The Previous button would take the user to the previous page in the current application procedure, while the Back button takes the user entirely out of the current procedure to a previous location, such as a homepage or a search results page, without saving any entered data.</p> <hr/> <p><b>Note:</b> Hiding the back button is performed only with Application Designer. In the current release, there is no programmatic control over hiding or displaying the Back button. This property is a global setting at the component level.</p> <hr/>
<b>Refresh</b>	Displays the page again without saving any entered data.
<b>Notify</b>	Enables the user to send a notification to other users.
<b>View Worklist</b>	Enables the user to view the worklist from the current component page.
<b>Next in Worklist and Previous in Worklist</b>	Enables the user to access the next or previous item in the worklist.
<b>Add, Update/Display, Update/Display All, and Correction</b>	<p>Select each option to enable these toolbar buttons for this component.</p> <p>See <a href="#">Setting Use Properties</a>.</p>
<b>Disable Toolbar</b>	Select if you do not want the toolbar to appear on the component pages.
<b>Multi-Page Navigation</b>	
<b>Display Folder Tabs</b>	Select to display folder tabs at the top of the component page.
<b>Display Hyperlinks</b>	Select to display links at the bottom of the component page.

**Page Navigation in History**

Enables the system to store the visited pages in the Back button history. This setting applies to the pages within the current component.

This can be enabled also using the `SetTransferAttributes` PeopleCode built-in function.

For more information, see "SetTransferAttributes" (PeopleTools 8.58: PeopleCode Language Reference).

**Return to Last Page in History**

Select to return the user to the last viewed page within a component after being transferred to a different component.

This setting applies in the event of a transfer between components.

The default behavior when using the Back button to return from a transfer between components is to display the initial page of the component, regardless if it was the last viewed page.

For example, with Return to Last Page in History selected, if the user was on the third page within the component prior to the transfer to another component, the system displays the third page in the original component after using the Back button to return from the transfer.

This can be enabled also using the `SetTransferAttributes` PeopleCode built-in function.

For more information, see "SetTransferAttributes" (PeopleTools 8.58: PeopleCode Language Reference).

**Processing Mode****Interactive**

Select to send messages to the server whenever logic must be run. When the user presses Tab to exit a field-level event, a transmission to the application server occurs to run that field-level event and the page is refreshed.

**Deferred**

Selected as the default. This mode reduces transmissions to the application server.

See [Understanding Processing Modes](#).

**Allow Expert Entry**

This option is available for both processing modes.

See [Enabling the Expert Entry Feature in the Security Component](#).

**WSRP Compliant Option**

Select the WSRP Compliant option to enable the component for Web Services for Remote Portlets (WSRP) publishing. If the component is enabled for WSRP publishing, then users can render the component in-line within the WSRP consuming portal.

If the component is *not* enabled for WSRP, when users navigates to the component from within a WSRP portlet the system will direct them to the PeopleSoft Portal, which loads the component. The user will effectively leave the WSRP consuming portal page and navigate to the PeopleSoft system.

---

**Note:** This option enables you to distinguish between components that are known to function only in the PeopleSoft Portal and those that are WSRP-compliant.

---

**Note:** The WSRP Compliant option applies only to classic applications. In the current release, fluid applications are not WSRP producible.

---

For more information, see "Understanding WSRP" (PeopleTools 8.58: Portal Technology).

## Pagebar

The pagebar is a small menu bar that appears at the top of each component page just below the universal navigation header. You can select which options appear to the user for each component. All options are selected by default. Select the Disable Pagebar check box to disable the pagebar.

### Help Link

Opens the online help PeopleBook entry for the current page.

### Copy URL Link

Copies the current page URL to the clipboard. The copied URL includes page, action, and search key information that appears in the context of the portal if the user passed through the portal. If the user did not pass through the portal, then only the page appears, without the portal frames.

This option adds a small http button to the pagebar.

### New Window Link

Opens a new browser window with the search page for the current component. Users can view or enter data in the new window.

### Personalize Page Link

Opens the Page Personalizations page, which allows users to control the initial appearance of the component. This option enables users to:

- Select the initial page in the component that appears.
- Save the state of the expanded and collapsed sections.
- Save the state of the View All settings on the page for grids and scroll areas.
- Personalize the page field tab order.

Users can also elect to copy and share their settings for the component with other users.

---

**Note:** If you set this option for a particular component, all users accessing the component are able to personalize the pages in the component unless their personalization options prevent them from customizing pages. Security permission list settings or personalization options do not allow the option to be enabled or disabled per end user per component.

---

See "Personalizing Pages" (PeopleTools 8.58: Applications User's Guide).

You can also enable or disable any of these options using PeopleCode.

---

**Note:** To enable the Print link in the pagebar, select the Enable Print option on the General page of the web profile and ensure Disable Pagebar is not selected. The appearance of the Print link is controlled by the web profile, not the component-level settings.

---

See "Understanding Page Class" (PeopleTools 8.58: PeopleCode API Reference).

## Personalize Page Option

For the page personalization option to appear to users, the following criteria, in addition to the selection of the Page Customization Link in the pagebar, must be met:

- A PeopleSoft Pure Internet Architecture page, including search and secondary pages, must be visible to the user.
- The page cannot be a PeopleTools-generated page, such as the Page Personalization page or the Personalize Column and Sort Order page for grids.
- The current page cannot be an iScript.
- The Personalize Pagelink cannot be hidden using PeopleCode for the current component.
- The Personalize Page Settings, CUSTOMPGSET, personalization option on the Define Personalizations page must be enabled.

This option is enabled by default. If this option is disabled, the end user cannot define, share, or copy page personalizations and all existing page personalizations for the user are deleted.

- The current page must allow some form of personalization based on the end user's security profile and meet *at least one* of these conditions:
  - Display more than one page element with a TABINDEX  $\geq 1$  supporting personalization (assume that all collapsible sections are expanded when determining visibility).
  - Contain at least one visible scroll area or grid with a visible View All link, enabled or disabled.
  - Contain at least one visible collapsible section.

## Related Links

"Working with Search Pages" (PeopleTools 8.58: Search Technology)

## Setting Fluid Properties

Access the Component Properties dialog box and select the Fluid tab.

The properties on the Fluid tab apply only to fluid components. These settings are ignored for classic components.

For more information on creating fluid components, see "Setting Component Properties for Fluid Components" (PeopleTools 8.58: Fluid User Interface Developer's Guide).

## Setting Style Properties

Access the Component Properties dialog box and select the Style tab.

The Style tab enables you to apply custom style sheets and JavaScript at the component level as part of your branding configuration.

---

**Note:** In addition, the Component Branding page can be used to specify custom style sheet objects and JavaScript objects in addition to those specified here in Application Designer. For more information on this PeopleTools branding feature, see "Branding Classic Components" (PeopleTools 8.58: Portal Technology).

---



### Image: Component Properties dialog box: Style tab

This example illustrates the fields and controls on the Component Properties dialog box: Style tab. You can find definitions for the fields and controls later on this page.

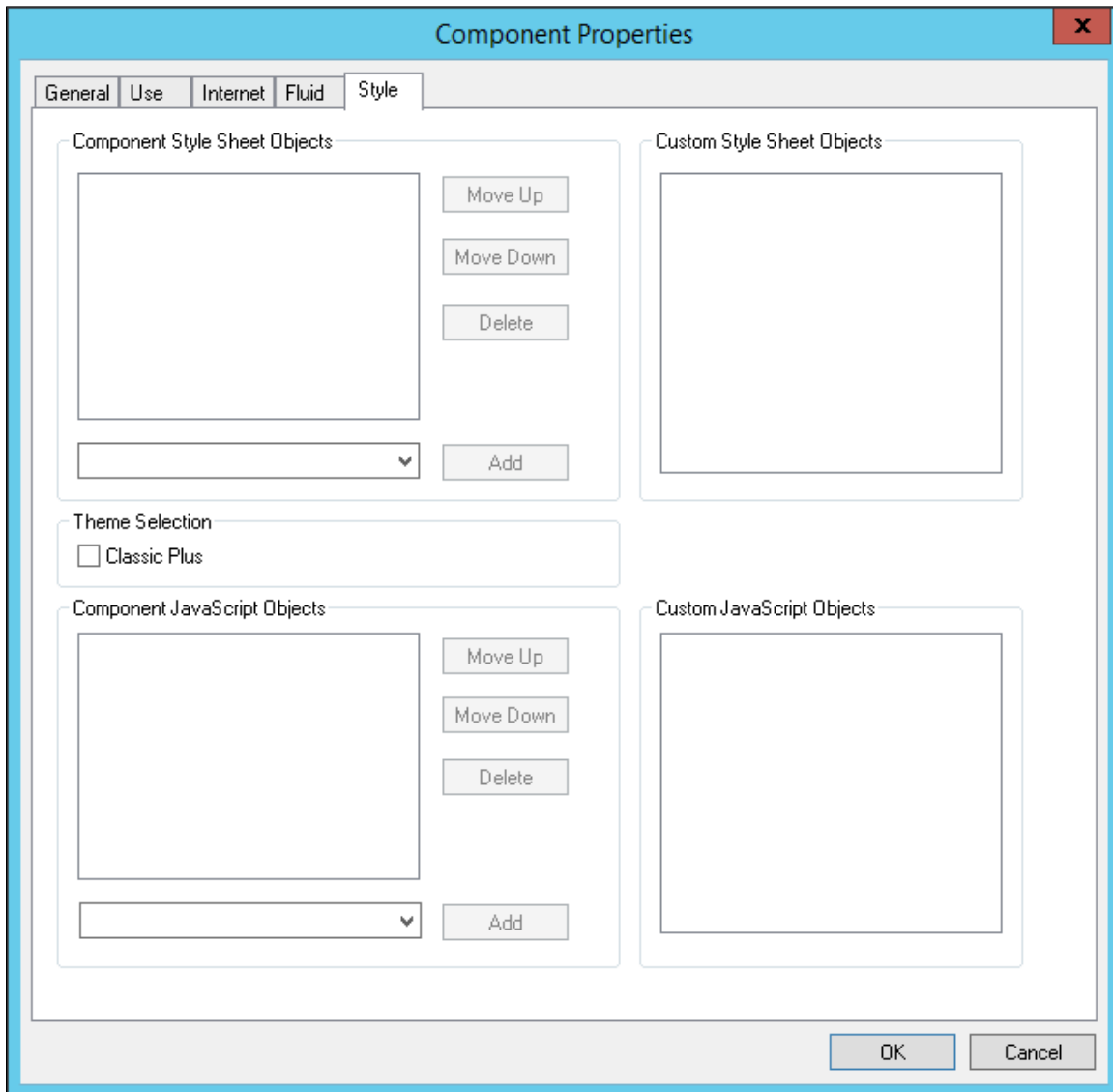

#### Component Style Sheet Objects

Create the “developer’s list” of style sheets applied to this component. The *developer list* refers to the style sheets added on the Style tab by a developer using Application Designer. Use the Add drop-down list to add style sheets to the list.

#### Custom Style Sheet Objects

Displays style sheets applied to the component by a portal administrator using the Component Branding page (PeopleTools, Portal, Branding, Component Branding). The portal administrator list is read-only in Application Designer.

#### Classic Plus

Select for this component to display with fluid-like styling, which is also referred to as *classic plus*.

If your end users are interacting with both fluid and classic components, having classic components and fluid components display with similar styling creates a more uniform experience.

This component property takes effect only when the Theme Style Type has been set to either *Classic Plus* or *Classic Plus Pre 858* on the Branding Systems Options page. The Branding System Options page setting enables classic plus at the *system level*, while selecting this property enables classic plus display for the individual component.

See "Configuring Branding System Options" (PeopleTools 8.58: Portal Technology).

PeopleTools and PeopleSoft applications deliver numerous components pre-configured for classic plus display. Refer to the product documentation for your PeopleSoft applications for a list of delivered classic plus components. For a list of delivered PeopleTools classic plus components, see "PeopleTools Components Delivered as Classic Plus" (PeopleTools 8.58: Portal Technology).

If you enable this property, you will first need to test, and possibly adjust page layout so that pages and page elements display as desired in classic plus. See the following section, [Reworking Components for Classic Plus Display](#).

### Component JavaScript Objects

Create the “developer’s list” of JavaScript objects applied to this component. The *developer list* refers to the JavaScript added on the Style tab by a developer using Application Designer. Use the Add drop-down list to add JavaScript to the list.

---

**Note:** JavaScript is stored in HTML definitions.

---

### Custom JavaScript Objects

Displays style sheets applied to the component by a portal administrator using the Component Branding page (PeopleTools, Portal, Branding, Component Branding). The portal administrator list is read-only in Application Designer.

### Add

For the Component Style Sheet Objects list and the Component JavaScript Objects list, use the Add drop-down list to add objects to the lists.

### Move Up

To adjust the order of the listed branding objects, use Move Up to move the object toward the top of the sequence.

### Move Down

To adjust the order of the listed branding objects, use Move Down to move the object toward the bottom of the sequence.

---

**Note:** The list of style sheet objects and JavaScript objects entered on the Style tab in Application Designer, referred to as the *developer list*, is separate from the list entered through the Component Branding page, which is the *portal administrator list*. The system loads the objects in the developer list *before* the portal administrator list.

---

**Note:** The Style tab applies only to classic components. It does not appear for fluid component definitions.

---

## Reworking Components for Classic Plus Display

If you have custom classic components that your end users access along with fluid components and you want to provide a more uniform experience, you can set your components to display in classic plus as described in the previous section. Before end users access classic plus components in a live system, verify that the classic plus rendering continues to meet your requirements and rework and reposition any of the page elements as needed. Using the page preview feature in Application Designer, you can preview any classic page definitions as classic plus, regardless of whether the component property is enabled for classic plus. See “Previewing a Page as Classic Plus” in [Previewing Classic Pages](#) for more information.

---

**Note:** The page controls on these classic plus pages will resemble the page controls on fluid pages. However, because these components and pages remain as classic definitions, certain aspects of the PeopleSoft fluid user interface experience will be absent—for example, dynamic, responsive rendering across all supported device types.

---

The following list provides a set of guidelines to assist in the transition from classic to classic plus for your custom components:

- Perform side-by-side comparisons with the page in classic and classic plus to help identify rendering, alignment, and behavior issues.
- Classic plus incorporates larger font sizes and larger control sizes, which means the page layout requirements can increase up to 20% in some situations. In addition, PeopleTools adds some vertical padding to reduce clutter between page controls, which increases overall page height. Look for overlapping issues, text truncation issues, alignment issues and so on. Typically, you can adjust the page controls slightly in the page definition to resolve these issues.
- If the page appears to have grown too big when rendered in classic plus, try to reduce the white space in the page layout and look for ways to use the space more efficiently.
- The PeopleTools Save button (the delivered Save button), renders as the *primary button* in classic plus by default. If you do not have the Save button on a page, or you have a set of custom buttons on your page, you may want to set one button as the primary button.

To make any button other than the PeopleTools Save button a primary button, open the Push Button/ Hyperlink Properties dialog box for that button. On the Use tab, select the Activate by Enter Key check box. With this selection, the system renders your button as the primary button on the page, which end users recognize by its solid color.

- If you have custom buttons, remove any images in the buttons for classic plus rendering.
- If you are using images in your page, they must be scalable vector graphics (SVG).

- Make sure to test all page control types, such as grids, scroll areas, group boxes, drop-down lists, date selectors, hyperlinks, and so on.
- Test classic plus pages in all of the browsers used by your organization.
- If a page contains HTML areas, custom style classes, or custom style sheets, you need to update the custom HTML and CSS manually to match the classic plus experience.

### Related Links

Oracle Support Document 2472858.1 (Guidelines for Optimizing Pages for Classic Plus)

---

## Using Search Records

---

**Important!** Persistent search, the drop-down menu, and other forms of classic navigation are no longer supported. The default navigational interface for PeopleSoft applications in the current release is based on the fluid banner, which can be used for both classic and fluid applications.

---

This section provides overviews of search records and search records and persistent search results, and discusses how to:

- Create search records.
- Override search records.

## Understanding Search Records

You must correctly configure and select the search record for a component because the system uses the search record for several purposes:

- The search record builds the search page for the component.
- The search record builds the search query, which retrieves the component data and populates level 0 for every page in the component.
- The search record builds the recent search results page for persistent searches.
- The search record defines the service parameters that must be mapped for related content service definition of the PeopleSoft Component URL type.

When you click a content reference to access a component, the system examines the search record and dynamically builds the search page based on the search key, alternate search key, and list box item properties of the search record. If you designate fields as search keys or alternate search keys, then those fields appear on the search page. When the user enters values in the search fields and clicks the Search button, the system incorporates those values into the WHERE clause of the search query. If the values provided by the user uniquely identify one row of data, then the system proceeds directly to the main page with the available information. Otherwise, the query retrieves the rows that match the criteria and displays the rows in a list box at the bottom of the search page. If you define fields as list box items on the search record, the system displays those fields as columns grid in the result set.

You can use the %OPRCLAUSE meta-variable to filter the search results based on user profile settings for implementing row-level security. For more information on using this meta-variable see "%OPRCLAUSE" (PeopleTools 8.58: PeopleCode Language Reference).

This example shows elements of a search page:

### Image: Search page with search keys, alternate search keys, and list box items

This example illustrates the fields and controls on the Search page with search keys, alternate search keys, and list box items. You can find definitions for the fields and controls later on this page.

**Resolution**  
Enter any information you have and click Search. Leave fields blank for a list of all values.

[Find an Existing Value](#) [Add a New Value](#)

Resolution ID: = [ ] [ ]  
 State: = [ ] [0120-Posted]  
 Resolution Type: = [ ] [ ]  
 Bundle ID: = [ ] [ ] [ ]  
 Create Date: = [ ] [ ] [ ] [ ]  
 Created By Name: begins with [ ] [ ] [ ] [ ] [ ]  
 Resolved By Name: begins with [ ] [ ] [ ] [ ] [ ]  
 Subject: begins with [ ] [ ] [ ] [ ] [ ]

These are Search Key and Alternate Search Key fields on the Search record.

[Search](#) [Clear](#) [Basic Search](#) [Save Search Criteria](#)

**Search Results**  
Only the first 300 results can be displayed. Enter more information above and search again to reduce the number of search results.

[View All](#)

Resolution ID	State	Resolution Type	Bundle ID	Lead Product	Create Date	Created By ID	Created By Name
870196	Posted	Applic	0	HRMS Global Payroll Core 9.1	08/11/2011	SRINSHAR	Srinivasa Sharma
870085	Posted	Applic	0	FIN Expenses 9.1	08/08/2011	22383	Rafael Almeida
870077	Posted	Applic	0	CRM Enterprise Components 9.1	08/08/2011	15463	Shelly Bowman
870063	Posted	Applic	0	PRTL Applications Portal 8.9	08/08/2011	T12987	Madanagopal Damodharan
870003	Posted	Applic	0	CRM Advanced Configurator 9.1	08/05/2011	C8V/PATEL	Vishnukumar Patel
869878	Posted	Applic	0	CRM Online Marketing 9.1	08/02/2011	AZEEM	Abdul Azeem

These are List Box fields on the Search record. Note that "Lead Product" and "Created By ID" aren't key fields, just Listbox items, so they aren't shown above, just here.

As soon as the system retrieves the search results, they appear as rows in the list box or grid. If recent search results caching is enabled, the system also temporarily stores this most recent (or persistent) search in the menu structure—in the navigation path and in the Recent Search Results menu under the Favorites drop-down menu.

When you select a row from the list box, the runtime system generates a second query to fill the level 0 row in the component. The runtime system examines the level 0 record for the component and checks its key fields. It tries to retrieve level 0 key field values from the fields in the list box and uses those values in the WHERE clause used to populate the level 0 record.

**Note:** This process is the same whether you select the row from the initial search results list or from a persistent search.

The search record for a component might differ from the level 0 record definition for a component and might contain any number of search keys and list box items, but it must contain all of the key fields that are in the level 0 record for a component.

See [Setting Record Field Use Properties](#).

---

**Note:** When you add page items that are based on derived work records, do not select that record definition as the search record. Instead, select a record definition that stores the primary key or a SQL view that searches for the criteria that best enables users to identify the rows that they want to retrieve. The search record might also contain logic to refine the search and limit rows of data. PeopleSoft applications implement data permission (or row-level) security in this way.

To configure menus in a PeopleSoft application, the easiest way to decide which search record to use is to look at the other search records that are used on the same menu. Look for pages with similar key structures and then evaluate the search records to see if any are suitable. You might want to print the PeopleTools Menu Listing cross-reference report (XRFMENU) to review which search records are used for pages and gain a better understanding of how search records are assigned in the application.

---

## Understanding Search Records and Recent (Persistent) Search Results

---

**Important!** Persistent search, the drop-down menu, and other forms of classic navigation are no longer supported. The default navigational interface for PeopleSoft applications in the current release is based on the fluid banner, which can be used for both classic and fluid applications.

---

When you perform a component search, the results of your most recent search are temporarily stored—they persist—in the portal drop-down menu structure. The system stores the most recent component search results for the currently active component in the navigation path (breadcrumbs). Here is an example of the search results icon in the navigation path:

### Image: Search icon at the far right in the navigation path

This example illustrates the fields and controls on the Search icon at the far right in the navigation path. You can find definitions for the fields and controls later on this page.

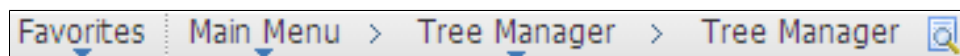

The most recent search for each of the five most recently visited components appear in the Recent Search Results menu:

**Image: Recent Search Results menu showing two recent component searches**

This example illustrates the fields and controls on the Recent Search Results menu showing two recent component searches. You can find definitions for the fields and controls later on this page.

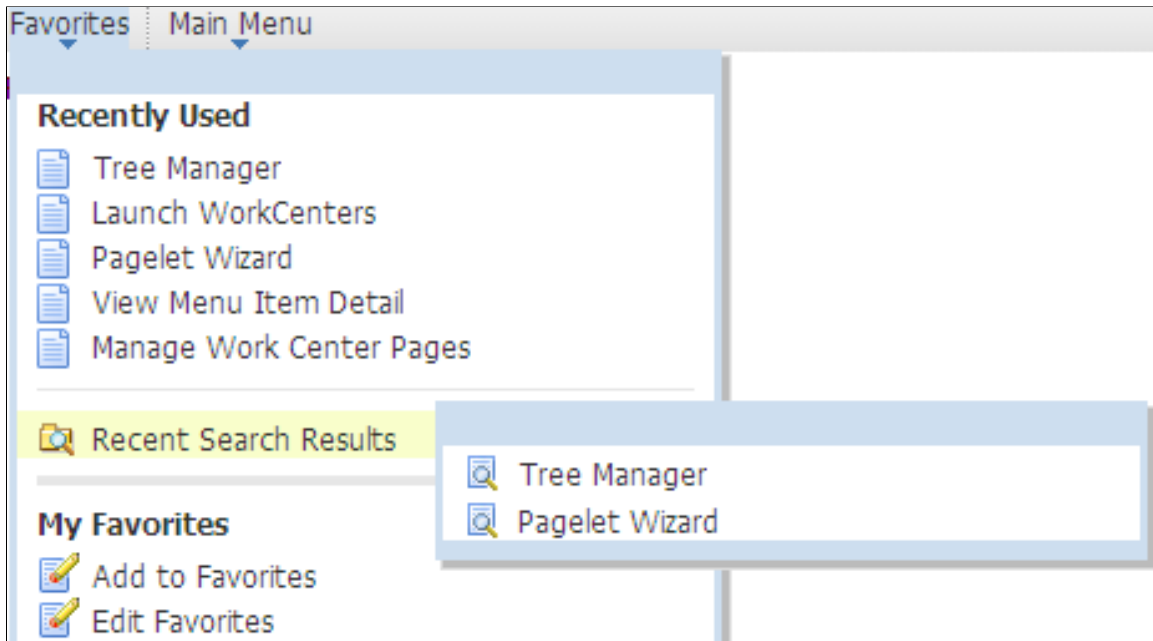

---

**Note:** Components that do not generate search pages do not generate search results and, therefore, do not appear in the Recent Search Results menu or the navigation path.

---

When you access a recent search either from the navigation path or the recent search menu, the system displays the results in a grid on a modal pop-up page, which hovers over the currently active page.

Here you see the Recent Search Results pop-up page for the Tree Manager component:

**Image: Tree Manager Recent Search Results pop-up page showing results grid**

This example illustrates the fields and controls on the Tree Manager Recent Search Results pop-up page showing results grid. You can find definitions for the fields and controls later on this page.

Tree Name	SetID	Set Control Value	Effective Date	Tree Branch
<a href="#">QE ACCOUNTS</a>	QEDM2	(blank)	1900-01-01	(blank)
<a href="#">QE ACE 848 EMPL</a>	QEDM1	(blank)	1900-01-01	(blank)
<a href="#">QE ACE AFTREE</a>	QEDM1	(blank)	1900-01-01	(blank)
<a href="#">QE ACE DGC BU</a>	QEDM1	(blank)	1900-01-01	(blank)
<a href="#">QE ACE DGC DEPT</a>	QEDM1	(blank)	1900-01-01	(blank)
<a href="#">QE ACE DGC DTRG1</a>	QEDM1	(blank)	1900-01-01	(blank)
<a href="#">QE ACE DGC EMPD2</a>	QEDM1	(blank)	1900-01-01	(blank)
<a href="#">QE ACE DGC EMPD3</a>	QEDM1	(blank)	1900-01-01	(blank)
<a href="#">QE ACE DGC EMPD4</a>	QEDM1	(blank)	1900-01-01	(blank)
<a href="#">QE ACE DGC PRDID</a>	QEDM1	(blank)	1900-01-01	(blank)
<a href="#">QE ACE DGC PROD</a>	QEDM1	(blank)	1900-01-01	(blank)
<a href="#">QE ACE PRODUCT</a>	QEDM1	(blank)	1900-01-01	(blank)
<a href="#">QE ACE PROD TREE</a>	QEDM1	(blank)	1900-01-01	(blank)
<a href="#">QE CUBT PRODUCTS</a>	QEEU	(blank)	2009-02-27	(blank)
<a href="#">QE CUBT REGION</a>	(blank)	(blank)	2009-03-01	(blank)
<a href="#">QE DEPT DYNAMIC</a>	QEDM1	(blank)	1999-01-01	(blank)
<a href="#">QE DEPT SEC</a>	QEDM2	(blank)	2001-01-01	(blank)
<a href="#">QE JOBCODES</a>	(blank)	(blank)	1999-01-01	(blank)
<a href="#">QE PERS DATA</a>	QEDM1	(blank)	1997-05-05	(blank)
<a href="#">QE PROJECTS</a>	(blank)	QEBU1	2000-04-25	(blank)

---

**Important!** You must enable recent search results caching at the system level. The default setting for recent search results caching is disabled.

---

**Recent Search Results Process**

A persistent search enables you to circumvent the first part of the component search process by temporarily storing all search keys, which the system uses in the WHERE clause of the second part of the search process, in the menu structure. When you access a recent search and select an item from the list, the second query is generated and populates the component buffer.



Although the search process remains the same, the appearance of the search results page differs from component search pages.

Note these points about the search results page:

- It is modal; it hovers over the transaction page, which is inactive until you dismiss the modal page or select a list item.
- It is compact; it displays a maximum of five of the temporarily stored fields in the results grid.
- It is moveable, which enables you to view the current transaction and see the search results simultaneously.
- It displays an active link, a link that you can click to retrieve a specific row of data, in only the first column; all other columns are inactive.
- It is configurable.

See [Configuring Search Results Grid Columns in Persistent Searches](#).

Note these points about the accessibility and availability of persistent search results:

- The most recent transaction search results for the currently active component appear in the navigation path next to the content reference name; a search icon is the visual indicator.
- The one most recent search for each of the five most recently viewed components appears in the Favorites, Recent Search Results menu. The results appear by component name, for example, User Profiles.
- The navigation path retains the most recent transaction search results until another search is performed.

---

**Note:** If you leave a component and return to it without having performed another search, the most recent search results reappear.

---

- Any persistent search remains in the portal menu structures only until your PeopleSoft session expires, you sign out, or you close the browser.

## Recent Search Results Page Construction

The standard, default Recent Search Results page uses these criteria to determine the fields that appear on the page:

- Fields marked as search key fields appear in the results grid in the order in which they are listed in the record definition.
- If the search record contains more than five search key fields, the other search key fields, while stored in the menu structure and accessible by the search process, are hidden from view.
- If the search record contains fewer than five search keys, the fields marked as list box items appear in the grid in the order that they are listed in the record definition until the column limit of five is reached.

You can override which columns appear on the recent results search page by using the Persist in Menu property of the search record.

## Related Links

[Setting Record Field Properties](#)

## Creating Search Records

To create a search record:

1. Create the record definition and add the fields.

See [Creating New Record Definitions](#).

2. Select the key fields, search key fields, and list box items.

See [Setting Record Field Properties](#).

3. If the record is a view, write the SQL statement in the SQL editor.

See "Using the SQL Editor" (PeopleTools 8.58: PeopleCode Developer's Guide).

4. Save and build the record definition.

See [Running the Build Process](#).

## Overriding Search Records

You might want to reuse a component, changing only its search record.

You can accomplish this by overriding the component search record at the time that the component is invoked from a menu. To override a component search record, specify a different search record in the properties of the menu item that invokes the component. The component uses the override search record when it is invoked from that specific menu item; the search record set in the component properties remains unchanged.

By reusing components in this way, you can limit redundancy, keeping your application smaller and easier to maintain.

---

## Accessing the Message Catalog

Message sets and number settings come from the PeopleTools Message Catalog.

To access the Message Catalog:

1. Select PeopleTools > Utilities > Administration > Message Catalog.
2. On the search page, enter the message set number that you want to access.

Component definitions support messages between 0 and 99,999.

3. Click Search to access a Message Catalog page.
4. Enter the message set and number on the Internet tab of the Component Properties dialog box.

For example, enter message set and number *124* and *50* to display the Find an Existing Value message on the search page in the browser.

---

## Enabling the Expert Entry Feature in the Security Component

This section provides an overview of the Expert Entry feature and discusses how to enable it in Security.

### Understanding the Expert Entry Feature

The Expert Entry feature enables users to change from interactive to deferred mode at runtime for appropriate transactions.

---

**Note:** Only expert users who understand how all of the fields in a transaction behave should use the Expert Entry feature. These users must know the exact keystroke sequence for the transaction. This sequence typically varies for a transaction by customer, depending on the customer's setup and entry requirements. Therefore, occasional users should not use the Expert Entry feature because they might not be aware of the nuances of the transaction and when it is necessary to press the Refresh hot key.

---

To use Expert Entry, select:

- The Allow Expert Entry check box on the Internet tab of the Component Properties dialog box.
- The Enable Expert Entry check box in the user's profile.

If these check boxes are selected, an Expert Entry check box appears at the bottom of the page at runtime. If users select this check box, the transaction runs in deferred mode, regardless of the setting on the component, page or field property.

When you set the component property to deferred mode, that component operates in deferred mode processing for all users, not just those who have Expert Entry enabled in their profiles.

If you want the component to process in deferred mode for some users and in interactive mode for other users:

- Set the component property to Interactive mode.
- Select the Allow Expert Entry check box.

These settings enable security user profiles to control the users for whom deferred mode processing is possible.

---

**Warning!** Users who modify component properties from interactive mode to deferred mode or select the Allow Expert Entry check box should understand that this is an adaptation of the software and, as such, they are responsible for thoroughly testing and supporting this change.

---

### Refresh Button

The Expert Entry feature enables you to specify whether a Refresh button should be included on the component toolbar when the system displays the page. The Refresh button forces a transmission to the

server to determine which fields have changed since the last transmission to the server and to run any processing logic that is associated with those changes.

Users can also refresh by pressing the Alt+0 hot key, which keeps the cursor in the same field when the page is refreshed. One can refresh any time during data entry to enable an expert users to:

- Update related display field values for data that was already entered.
- Recalculate totals and balances.
- Provide defaults based on data that was entered previously on the page.
- Validate data entered on the page thus far.
- Invoke the code to hide or gray items associated with specific fields.

## Limitations of Expert Entry

These limitations exist when expert entry is enabled:

### Hidden and disabled fields

The user must click the Refresh button after entering a value in a field that is associated with PeopleCode that hides, reveals, enables, or disables other fields on the same page.

### Drop-down list box

The user must click the Refresh button after entering a value in a field that is a high-order key that is used to control the values in a drop-down list box.

### Default values

Whenever expert entry is properly enabled and selected by a user at runtime, the transaction runs in deferred mode. As such, defaults, totals, balances, and related displays are not updated until the next transmission to the application sever (for example, when the user clicks a button, icon, link, or another tab). If a user wants the page updated before then, she or he must click the Refresh button.

## Enabling Expert Entry in Security

To have the Expert Entry check box appear in the component at runtime, the security administrator must enable per user profile. The Expert Entry check box will then appear in any components for which you select the Allow Expert Entry property on the Internet tab of the Component Properties dialog box.

To enable expert entry for a user:

1. Sign in to the PeopleSoft system in your browser.
2. Select PeopleTools > Security > User Profiles > User Profiles.
3. Search for and select a user profile.
4. Select the General tab.
5. Select Enable Expert Entry in the General Attributes group box.

6. Click Save.



## Chapter 12

# Creating Menu Definitions

---

## Understanding Menus

A menu is a logical grouping of components for assigning security to your system. You create a menu as an organizer for components. After you save a menu, use the Registration Wizard to assign components and security.

You can create two types of menus using PeopleSoft Application Designer:

- Custom (component) menus provide an internal reference for components and pages. They are grouped logically into menu groups to assign security. They are not used for navigational purposes.
- Pop-up menus appear when a user clicks a pop-up button.

### Related Links

[Understanding the Registration Wizard](#)  
Security Administration

---

## Defining Custom Component Menus

This section discusses how to:

- Create custom component menus.
- Set menu item properties.
- Set general properties.
- (Optional) Set use properties.

## Creating Custom Component Menus

After you create records, pages, and components, register your new component using the Registration Wizard. To do so you must first create a menu definition if one does not already exist. This definition enables you to add the component to the new menu (for navigational purposes) and register it in the portal.

To create a new menu definition:

1. From the PeopleSoft Application Designer toolbar, select File > New..
2. Select Menu from the list.
3. Click OK.

4. Select the Standard option for the menu type.
5. Click OK.

The thick rectangle surrounding the bar item indicates that this element in the menu definition is currently selected. The empty, dashed rectangle is a placeholder for a new bar item label.

6. Assign a bar name and label.

You can define multiple menu bars for the menu. Double-click the rectangle to display the Bar Item Properties dialog box.

7. Enter the bar item name and label.

The most commonly used bar item name is Use..

8. Click OK to accept the settings in the Bar Item Properties dialog box.

The new label appears in the menu, and the empty rectangle appears in a new location.

9. Set the menu item properties.

When creating a menu simply as a placeholder for components for the Registration Wizard, you need only add a separator bar to save the menu.

10. Set the menu properties.

11. Save the menu definition.

## Related Links

[Understanding the Registration Wizard](#)

## Setting Menu Item Properties

Set the menu item properties to define your menu item. When creating a new menu definition to be used in the Registration Wizard, select Separator from the Type area of the Menu Item Properties dialog box to save the menu definition for use in the Registration Wizard. If you decide not to use the Registration Wizard, complete the following procedure, and set the general and use properties for the menu definition.

To define a menu item:

1. In a standard menu definition, double-click a menu item to access its properties.

To create a new menu item, double-click the empty rectangle at the bottom of the menu.

2. Specify the menu item.

### **Name**

Specify the system name for the menu or menu item. Menu and menu item names must conform to a specific set of naming conventions for the system to recognize them: all uppercase letters, no embedded spaces, and no special characters (for example, %, ^, &, \*, \$, #).

### **Label**

Specify the text label to appear on the menu. The label appears in the Home bar item or in a cascade menu of a



menu group. You can place an ampersand in the text to assign a keyboard shortcut for the menu.

3. Select the menu item type.

**Component**

Select for a standard component menu item.

**PeopleCode**

PeopleCode menu items trigger PeopleCode programs. The program runs in a component buffer context, which allows PeopleCode to access values in the component buffer.

**Separator**

Select this option when creating a menu for the Registration Wizard. Selecting this option disables all other fields in the Menu Item Properties dialog box.

4. Click the Select button.
5. Select an enabling component in the Open dialog box.

At runtime, standard PeopleCode menu items are always visible in a menu, but they are active (enabled) only when their enabling components are open.

6. Save the menu item if it has not yet been saved.
7. In the menu definition, right-click the menu item, and then select *View PeopleCode*.

The PeopleCode Editor appears.

8. Add a PeopleCode program in the ItemSelected event of the menu item.
9. After you enter a program, save the PeopleCode program and close the PeopleCode editor.
10. (Optional) Override the component search record.

You might want to reuse the same component multiple times with different search records. You can accomplish this by overriding the component search record at runtime when the component is opened from a menu item without creating separate copies of the component. The component override is temporary and occurs only when the component is opened from the menu item in which the override is set. It does not change the component definition.

Select the Override check box, and then select an override search record from the Override prompt field. The override search record must be a valid search record for the component; that is, it must have all of the search key fields that are at level 0 of the component pages.

11. Click OK to accept the settings.
12. Save the menu definition.

## Setting General Properties

When you create or make changes to a menu, you should document the changes for future reference. You can do this on the General tab of the Menu Properties dialog box.

<b>Description</b>	Enter a descriptive name for the menu.
<b>Comments</b>	Add a description of the menu or any other useful information.
<b>Owner ID</b>	View a list of applications with which this menu is used. This list is helpful to identify the applications with which the menu is associated during application development.
<b>Last Updated</b>	View the date and time of the last modification and the name of the user who made the modification.

## (Optional) Setting Use Properties

Setting properties on the Use tab of Menu Properties is optional. Any settings you assign are stored internally only.

---

## Working With Menu Definitions

You should not modify PeopleTools or other application-specific menus; instead, create your own custom menus.

This section discusses how to:

- Add components to a menu.
- Rename menu definitions.
- Copy menu definitions.
- Delete menu items.
- Print menu definitions.
- Set up menu security.
- Import menu groups into portals.

## Adding Components to a Menu

Use the Registration Wizard to add components to a menu.

See [Understanding the Registration Wizard](#).

## Renaming Menu Definitions

When you change the name of a menu definition, you do not change the name of the application window that appears when you select the new menu from the PeopleSoft application.

To rename a menu definition:

1. Close all open definitions in the definition workspace.

2. Select File > Rename.

The Rename Definition dialog box appears.

3. Select *Menu* from the Definition Type drop-down list box.
4. Click Rename.
5. From the list of available menus, double-click the menu that you want to rename.
6. Type the new name over the name that is selected on the menu definition.
7. Click Rename.

---

**Note:** If you rename a menu definition, be sure to rename the corresponding registry entries manually.

---

## Copying Menu Definitions

Creating a copy of a menu definition is different from renaming a definition. The Save As command creates a copy of the definition with a new name while keeping the old menu definition unchanged.

To copy a menu definition:

1. Open the menu definition that you want to copy.
2. Select File > Save As.  
The Save As dialog box appears.
3. Type a new name for the copy of the menu definition.
4. Click OK.

You are prompted to save a copy of any PeopleCode that you have associated with the menu definition.

## Deleting Menu Items

Delete an item to remove it permanently from a menu definition. To help prevent accidental deletions, you can delete only one entry at a time.

To delete a menu item:

1. Select the menu item that you want to delete.
2. Select Edit > Clear.

If you attempt to delete a menu item that is linked to PeopleCode, the system issues a warning.

If you proceed to delete it, the linked PeopleCode menu items are also deleted.

If you delete an item by mistake, before you perform any additional edits or saves, select Edit > Undo to restore the menu item.

---

**Note:** When deleting menu items, remember to delete any corresponding registry entries.

---

## Printing Menu Definitions

In addition to printing a menu definition from the definition workspace, you can obtain a formatted report of all menu definitions by printing the PeopleTools Menu Listing cross-reference report (XRFMENU). This report lists application windows in alphabetical order, and details all menus in each window and all page definitions in each menu. It also includes the associated search record definition name and detail page definition name.

To print a menu definition:

1. Open the menu definition that you want to print so that it appears in the definition workspace as the current definition.
2. Select File > Print.

The standard Windows Print dialog box appears.

## Setting Up Menu Security

Whenever you make a change or add items to an existing custom menu definition, you might need to adjust your security settings. When you add a new menu to a security profile, that menu is available the next time that you sign in to the system. Use the Registration Wizard to assign security.

### Related Links

[Understanding the Registration Wizard](#)  
Security Administration

## Importing Menu Groups Into Portals

The menu import process creates content references for all components and pages that belong to a menu group. Use this process only to migrate custom menus.

### Related Links

"Importing Menu Groups into the Portal Registry" (PeopleTools 8.58: Portal Technology)

---

## Defining Pop-up Menus

This section provides an overview of classic pop-up menus and discusses how to:

- Create pop-up menus.
- Define transfer menu items.

---

**Important!** Classic pop-up menus are not supported in fluid applications. The use of these pop-up menus can produce unpredictable results with other features of fluid applications. See "Creating Fluid Pop-up Menus" (PeopleTools 8.58: Fluid User Interface Developer's Guide) for information on how to create pop-up menus for fluid applications.

---

## Understanding Pop-up Menus

Pop-up menus define the transition to another page—either a system-defined page containing a set of standard commands or a pop-up menu page that was created and associated with the pop-up button by an application developer.

You can also use pop-up menus to run a PeopleCode program. PeopleCode in pop-up menus does not share the same limitations as PeopleCode in standard menus, so pop-up transition menus provide an effective alternative to using command push buttons on pages. Pop-up menu PeopleCode programs can be used for any number of purposes, for example:

- To perform a modal transfer.
- To recalculate a field value.
- To trigger a PeopleSoft Workflow business event.

### Behavior of Pop-up Menus in Pages

These standard icons appear on the page at runtime when a pop-up menu is defined for a page field:



If the pop-up menu contains more than one menu item, the open pop-up menu button (PT\_POPUP) is displayed on the page.

When a user clicks this button, a list of menu items is displayed from which to select.



If the pop-up menu contains only one menu item, the skip pop-up menu button (PT\_POPUP\_SKIP) is displayed on the page instead. When a user clicks this button, the target transaction page appears immediately, skipping the intermediate list displaying just one menu item.

### Image: Pop-up menu button on a page

For example, the Amount field on the following page contains a pop-up menu button, which opens the Display in Other Currency page.

The screenshot shows a web application interface titled "Select Type of Benefits" for employee "Cherie Raymond". The page includes several sections:

- Plan Type:** A search field containing "5A" and a magnifying glass icon, with the text "Company Car" displayed to the right.
- Coverage Details:** A section with a search field containing "08/17/2011" and a calendar icon, and a "Coverage Election" sub-section.
- Coverage Election:** A sub-section with three radio button options: "Elect" (which is selected), "Waive", and "Terminate". Below these is a field for "\*Elect Date:" containing "08/17/2011" and a calendar icon.
- \*Benefit Plan:** A search field with a magnifying glass icon.
- Allowance Taken:** A checkbox that is currently unchecked.
- Amount:** A search field with a magnifying glass icon and a currency selection button (a small icon with a dollar sign and a plus sign).
- Currency:** A search field.
- Status:** A text field containing "Active".
- Description:** A text field containing "HRMS Integration".
- Currency:** A text field containing "USD".

This type of transfer to another component is called a *definitional transfer* to distinguish it from transfers that are made using PeopleCode programs—for example, modal transfers. Definitional transfers are always replace the current page in the current window. To perform a modal transfer, you must use PeopleCode.

## Creating Pop-up Menus

This section discusses how to:

- Create new pop-up menus.
- Associate pop-up menus with page fields.

### Creating New Pop-up Menus

To create a new pop-up menu:

1. Select File > New.

The New dialog box appears.

2. Select Menu.
3. Click OK.

The New Menu dialog box appears.

4. Select the Popup option for the menu type.

5. Click OK.  
A new pop-up menu definition appears.
6. Define the menu items for the pop-up menu.
7. Set the menu properties:
  - a. Add a description and comments about your pop-up menu.
  - b. On the Use tab, type the menu label that you want to appear for that pop-up.
8. Save the pop-up menu definition.
9. To provide users with access to the pop-up menu, associate it with a page field.

### **Associating Pop-up Menus With Page Fields**

To associate a pop-up menu with a page field:

1. Open the page definition that contains the page field to which you want to associate the pop-up menu.
2. Right-click the page field and select Page Field Properties.
3. When the properties dialog box for that field appears, select the Use tab.
4. In the Popup Menu group box, select from the available pop-up menus in the drop-down list box.
5. Click OK.
6. Save the page definition.

### **Related Links**

[Setting Menu Item Properties](#)

## **Defining Transfer Menu Items**

Transfer menu items, which you create only in pop-up menus, enable you to specify a menu, component, and page to which the user is taken when the transfer menu item is selected. The following procedure describes how to create a new transfer menu item or redefine an existing menu item as a transfer menu item.

To define a transfer menu item:

1. In a pop-up menu definition, double-click a menu item to access its properties.  
To create a menu item, double-click the empty rectangle at the bottom of the menu. The Menu Item Properties dialog box for pop-up menus appears.
2. If this is a new menu item, enter a menu item name and label text in the Menu Item fields.  
You can create a shortcut key for the menu item by placing an ampersand in the label.
3. Set the transfer properties.

- Click the Transfer button to make this a transfer menu item.
- Click the Define Transfer button to display the Transfer Properties dialog box.

This dialog box enables you to define the properties of a definitional transfer that is made from a pop-up menu item. The component from which you are transferring is the originating component. The component to which you are transferring is the destination component.

4. Specify the following:

<b>Portal</b>	Select the navigation registry, such as employee portal.
<b>Node</b>	Select the PeopleSoft database to which you want the transfer menu to point. <i>Local</i> is the default. Valid values include all of the values in the MSGNODENAME column of the PSMMSGNODEDEFN table. If you select a node other than <i>Local</i> , the system deselects the Use data from current page in search dialog check box.
<b>Menu</b>	Select the name of the menu containing the destination component.
<b>Component</b>	Select the name of the destination component.
<b>Market</b>	Select the market of the destination component.
<b>Component Item</b>	Select the name of the page to display at the front of the destination component.
<b>Action</b>	Select an action mode ( <i>Update/Display</i> , <i>Update/Display All</i> , <i>Correction</i> , or <i>Data Entry</i> ) to constrain the user profile to a specific action mode at the time of the transfer. The action modes that are available in the prompt list depend on which modes are specified as valid in the destination component definition.  Select <i>Prompt</i> to enable the user profile to select an available action mode at the time of the transfer. The action modes that the user profile can select depend on which action modes are defined as valid in the destination component definition and to which action modes the user profile is granted access in Maintain Security.

5. Set the transfer type.

<b>Re-use current window</b>	Select to transfer to the component in the same window in which the transfer is initiated.
<b>Use new window (minimize current window)</b>	Select to minimize the current window and open the destination component in a separate window.

6. Specify whether to supply search key values from the originating component.



**Use data from current page in search dialog** Select to use the values from the originating component search keys in the search dialog box of the destination component. If these values allow the system to select a unique row from the search record, the search dialog box is bypassed and the destination component opens immediately.

Deselect this check box if you want the user to type the search key values into the search dialog box.

7. Click OK to accept the Transfer Properties dialog box settings.
8. Click OK to accept the Menu Item Properties dialog box settings.
9. Save the menu definition.



## Chapter 13

# Using the Registration Wizard

---

## Understanding the Registration Wizard

This section provides an overview of the Registration Wizard.

### Common Elements Used in This Topic

<b>Content reference</b>	A reference to a URL for a transaction page. Appears as a link in the navigation menu at runtime.
<b>iScript</b>	A specialized PeopleCode function that generates dynamic web content.  See "Understanding Internet Script Classes" (PeopleTools 8.58: PeopleCode API Reference).
<b>Permission list</b>	A set of access rights to application objects, including processes and reports, web libraries, functions, and other elements.  See "Understanding Permission Lists" (PeopleTools 8.58: Security Administration).
<b>Portal registry</b>	A tree structure in which content for a portal is organized, classified, and registered. A portal registry consists of folders, content references, and nodes.  See "Portal Registry" (PeopleTools 8.58: Portal Technology).

### Component Registration

After you create pages and assign them to a component, you must register that component to display the transaction page in the browser. You can use the Registration Wizard to do this. The wizard gathers information, attaches the component to a menu, assigns a permission list to allow security access rights, and places a content reference entry in the portal registry, which displays the component to the user on the navigation menu.

---

**Note:** Before running the Registration Wizard, the menu definition, permission list, and folder must exist. The wizard does not create these definitions. Instead, it matches existing definitions to one another and creates the content reference.

If change control is enabled while you are using the Registration Wizard, you will only be allowed to associate components with locked menus.

---

---

## Registering Components and iScripts

In PeopleSoft Application Designer, open the component definition that you want to register. If you are creating a new component, make sure that you save it before opening the Registration Wizard. For iScripts, open the record definition that holds the iScript function. By convention, such records begin with a WEBLIB\_ prefix.

You can access the Registration Wizard using any of these methods:



Click the Register Component or Register iScript icon in the toolbar.

### Pop-up menu

Select Register Component from the pop-up menu after right-clicking the component.

### Tools menu

Select Register Component or Register iScript from the Tools menu.

---

**Note:** All settings in the Registration Wizard are provided by default from those referenced in the previous wizard session.

---

To register a component or iScript:

1. Open the component or iScript you want to register.

You can also launch the Registration Wizard from the menu definition by right-clicking a menu item that points to a component.

2. Open the Registration Wizard.

Select Tools > Register in Portal or click the icon on the Toolbar.

The Start screen of the Registration Wizard provides the option of adding the component to a menu, a portal registry, a permission list, or a combination of the three. If the component is new and you are running the wizard for the first time, you should select all three options. If you have already run the wizard on this particular component and just need to add it to an additional permission list or portal, deselect the other option, Add this component to a menu.

### Image: Registration Wizard - Start dialog box

This example illustrates the fields and controls on the Registration Wizard - Start dialog box. You can find definitions for the fields and controls later on this page.

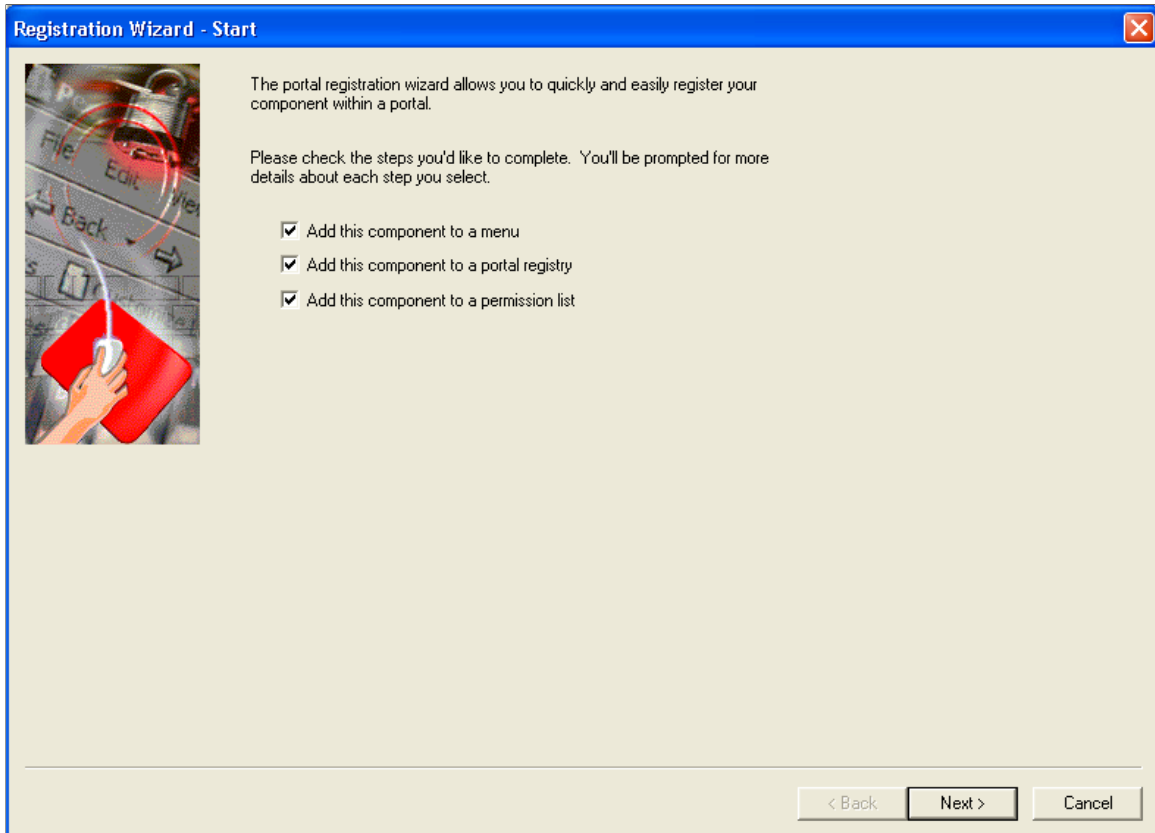

#### **Add this component to a menu**

Select to add the component to a menu. You must create the menu definition first if it does not already exist. You specify the menu on the following screen of the Registration Wizard. If you do not select this option, you will need to add the component to the menu manually using the Menu designer.

See [Creating Custom Component Menus](#).

#### **Add this component to a portal registry**

Select if you want to create a content reference for the component and add it to the portal registry you specified on the Create Content Reference screen of the Registration Wizard.

#### **Add this component to a permission list**

Select if you want to specify the permission list on the final screen of the Registration Wizard.

If the component or iScript is new and you are running the Registration Wizard for the first time, you will probably want to select all three options. If you are rerunning the wizard to add the component to an additional permission list or another portal, you would deselect the other option, , Add this component to a menu.

The wizard remembers the selection that you made the last time that you ran the wizard and selects those values by default.

3. Click the Next button.

If you selected to add the component to a menu, then the next screen, Add to Menu and Bar, opens.

**Image: Registration Wizard - Add to Menu and Bar dialog box**

This example illustrates the fields and controls on the Registration Wizard - Add to Menu and Bar dialog box. You can find definitions for the fields and controls later on this page.

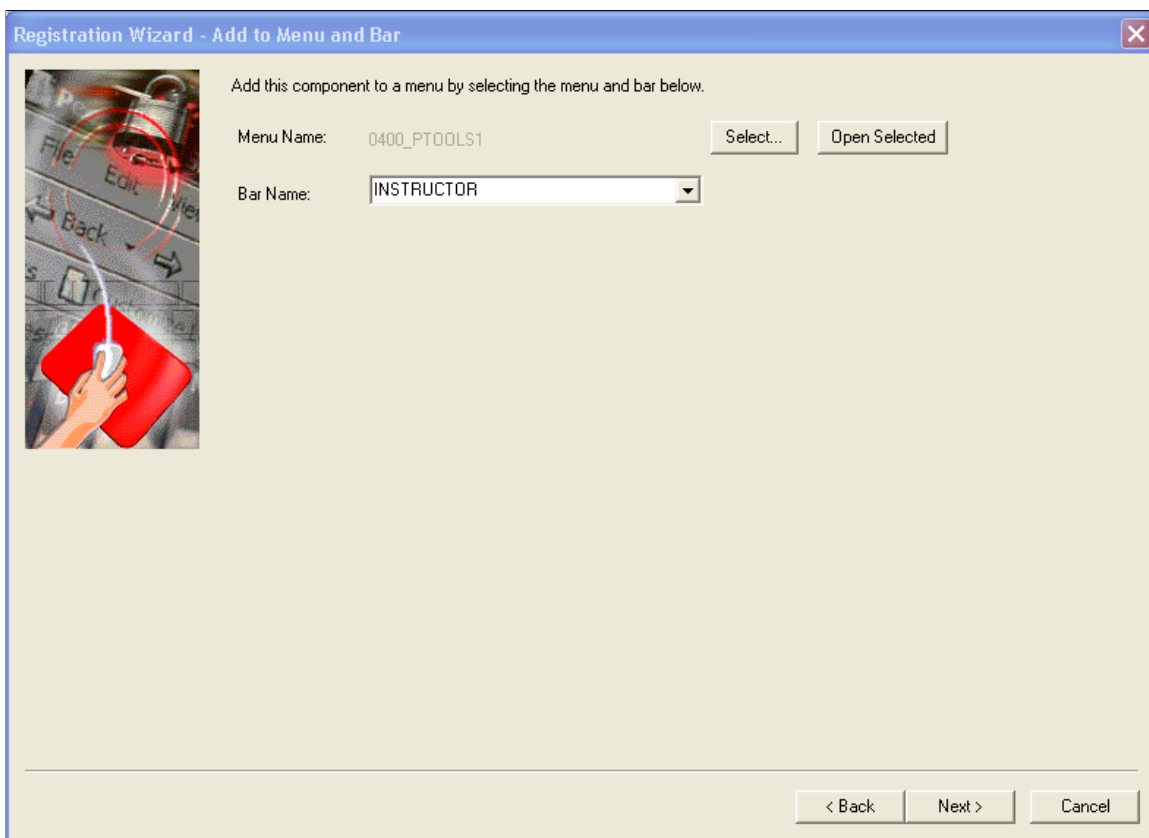

4. Click the Select button to find the menu name, click the Bar Name drop-down list box to assign the bar name, and then click the Next button.

These names are not exposed to users, but they are required for internal location purposes. Click the Open Selected button to open the menu that you selected in PeopleSoft Application Designer. To view the menu definition without closing the wizard, drag the Registration Wizard to the side.

5. On the Create Content Reference page, select Target Content or Homepage Pagelet.

If the component is a standard transaction, register it as Target Content.

## Image: Registration Wizard - Create Content Reference dialog box

This example illustrates the fields and controls on the Registration Wizard - Create Content Reference dialog box. You can find definitions for the fields and controls later on this page.

- Complete all fields in the Create Content Reference page.

### Target Content

Select this check box to register all forms of target content (excluding the homepage).

### Homepage Pagelet

Select to register a new homepage pagelet. The system applies the homepage template automatically.

### Portal Name and Folder Name

Click the Select button to change the portal or folder name. Click the Open Selected button to launch a browser that will take you to the administration page to create a new folder, if necessary. The default values are the last ones referenced by the wizard.

### Content Reference Name

The name is automatically generated, including the market code as the suffix.

### Content Reference Label

Enter the name of the CREF hyperlink that the user sees as the registry entry.

### Long Description

Enter hover text for the CREF link.

<b>Sequence Number</b>	Enter a numeral to control the order in which the component appears within the chosen folder.
<b>Product</b>	Enter a two-character product code.
<b>Template Name</b>	Specify the template to be used from the drop-down menu.  If you specified that the target content should be accessed as a homepage pagelet, then this field will not appear and the system will apply the homepage template automatically.
<b>Object Owner Id</b>	Select the application development group that owns the object.
<b>Node Name</b>	Click Select to change the Node name, or click the Open Selected button to launch the administration page to view the properties of the node.
<b>Always use default local node</b>	Select to always override the selected node name with the specified default local node.
<b>"Open" URI Base</b>	Enter the Universal Resource Identifier (URI) that specifies for PeopleSoft Application Designer the location of your PeopleSoft Pure Internet Architecture site. This entry is for informational purposes only. It is used only for the Open Selected button and not stored to the database.  If you entered a base URI on the Browser tab of the Options dialog box, that value appears in this field.  The URI you enter in this field is reflected on the remaining pages of the Registration Wizard. If you make a change to this field on any page, the change is reflected throughout.

7. Click the Next button.
8. You see the Add to Permission List page.



### Image: Registration Wizard - Add to Permission List dialog box

This example illustrates the fields and controls on the Registration Wizard - Add to Permission List dialog box. You can find definitions for the fields and controls later on this page.

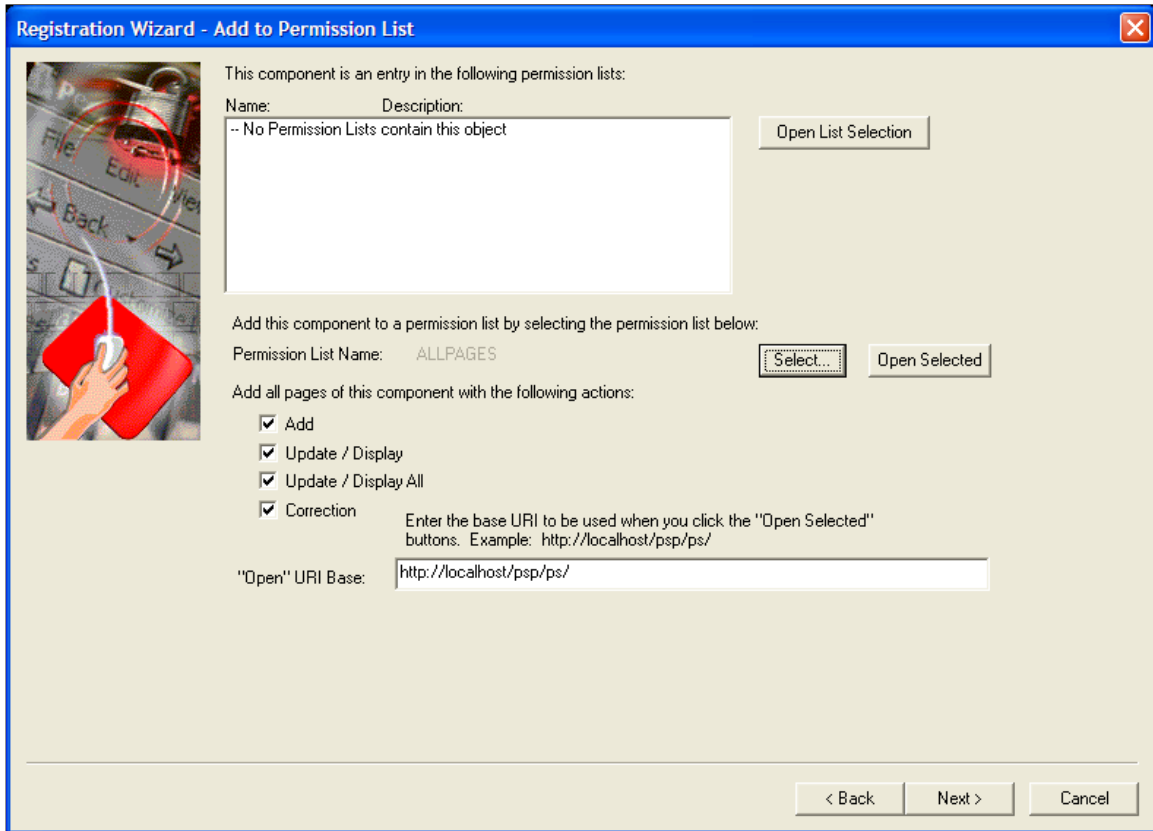

Click the Select button to find the menu name, and then use the drop-down list box to select the name that appears in the bar.

Menus are used as logical groupings to which you can apply security. PeopleSoft components are addressed by menu name (the URL includes the menu name). To add this component to a menu, specify the menu name and bar name.

If you did not select the Add this component to a menu check box on the Prompt page, this page displays the menu name and the Select button only. You then must select the correct menu that already contains the component.

If you are working with an iScript, you must select the iScript function to register.

9. Click the Next button.
10. Select Target Content if your component is a standard transaction and complete the appropriate fields.

The previous term table defines each of these fields.

If you did not select Add this Component to a Portal Registry on the Prompt page, this page does not appear.

11. Click the Next button.

12. Select the appropriate permission list, select all the actions that you want to grant this component or iScript, and enter the base URI.

Use the Select button to view and select a permission list.

If you did not select Add this Component to a Permission List, this page does not appear.

13. Click the Next button.

14. Use the Finish page to review the selections made so far. If you need to change anything, use the Back button to edit your entries.

Select the options in the Add to project area to place your item into an active PeopleTools project. This is cumulative behavior: the more times you run the wizard while the project is active, the more menus, registry structures, and permission lists are added to that project.

15. Click Finish to complete the registry process into the specified portal.

If you click Cancel all of the entries that you have made in the wizard will be lost and no changes will be made.

### Related Links

[Understanding Menus](#)

"Understanding Permission Lists" (PeopleTools 8.58: Security Administration)

---

## Registering Components in Multiple Portals

After you use the Registration Wizard to register your new component into the portal, you may need to register the component in other portals also.

You can do this in two ways.

- You can use the Registration Wizard again. Select only the second option, Add this component to a portal registry. Then reenter the content reference label, long description, and sequence number (if not 1) to match the entry of the other portal.
- In the browser, you can copy the content reference definition to other portals using Structure and Content.

### Related Links

"Copying Folders and Content References" (PeopleTools 8.58: Portal Technology)

## Chapter 14

# Creating Style Sheet Definitions

---

## Understanding Style Sheets and Style Classes

This section discusses:

- Overview of style sheets and style classes.
- Style sheet types.
- Style classes.

## Overview of Style Sheets and Style Classes

Style sheets are definitions that store margins, spacing, fonts, borders, color and other layout settings for particular elements of a page. When you use a style sheet, the system applies the predefined layout settings or style classes to every page in an application. By storing all page layout settings in a style sheet definition, you eliminate the need to redefine the same settings for each page separately, you can quickly reconfigure and apply new settings, and you maintain a consistent appearance throughout the application.

In PeopleSoft applications, a style sheet is a definition, like a record or page definition, that you create and maintain in PeopleSoft Application Designer. A style sheet is a standalone definition that you can upgrade, delete, rename, and so on.

You define style sheets by using the Fixed Form and Free Form tabs.

In this example, you see the Fixed Form tab, which you access to insert style sheets, sub style sheets, free form sub style sheets, or style classes into a definition:

### Image: Style sheet definition showing the Fixed Form tab

This example illustrates the fields and controls on the Style sheet definition showing the Fixed Form tab. You can find definitions for the fields and controls later on this page.

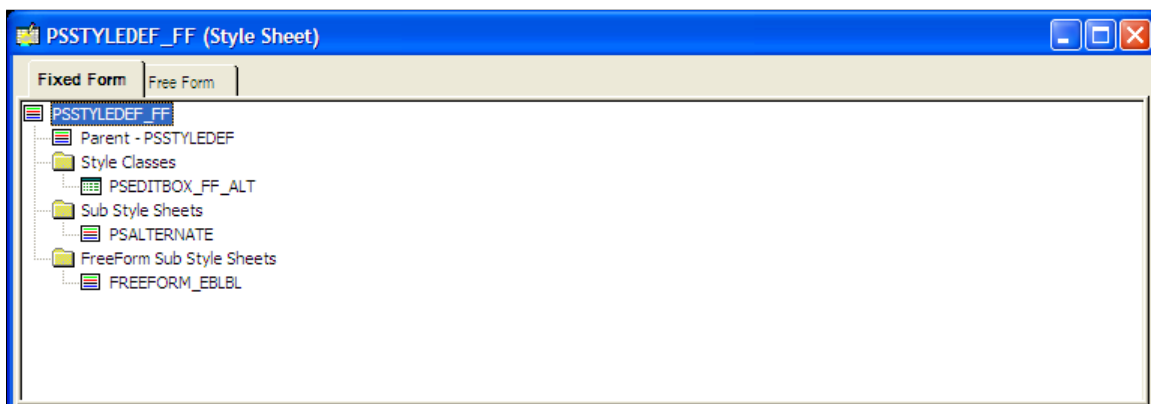

In this example, you see the Free Form tab, which you access to enter text when you create a free form sub style sheet. For standard style sheets and sub style sheets, use this view to examine or copy the text that is generated by the style sheet definition:

### Image: Style sheet definition showing the Free Form tab

This example illustrates the fields and controls on the Style sheet definition showing the Free Form tab. You can find definitions for the fields and controls later on this page.

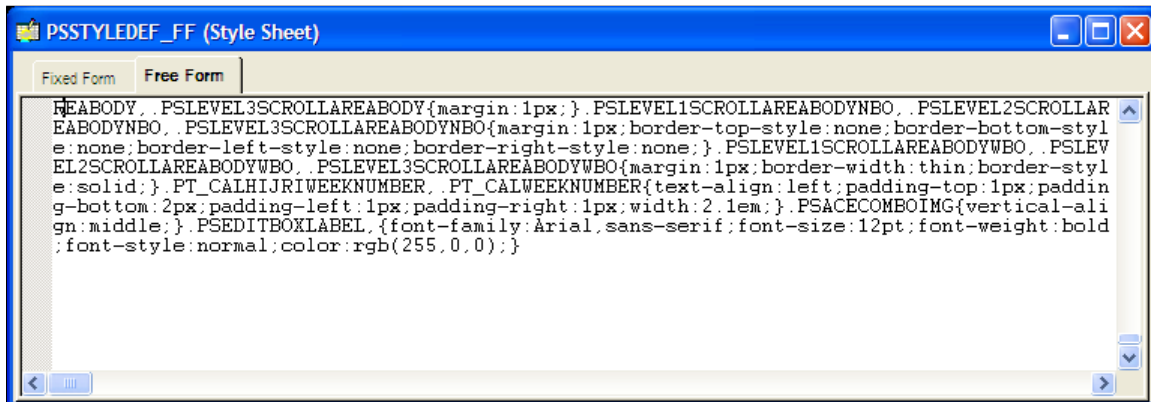

---

**Note:** For standard style sheets and sub style sheets, the Free Form tab text is read-only.

---

**Note:** Administrators can create HTML definitions (including JavaScript definitions) and free form style sheets, and upload images through portal branding pages (PeopleTools, Portal, Branding Objects), without requiring access to Application Designer. While the administrators cannot directly view or update the definitions created in Application Designer from the branding pages, definitions created with the portal branding pages can be viewed and edited in Application Designer. When creating a new definition using the portal branding pages, if the administrator uses an existing definition name of the same type, the system displays a prompt to overwrite an existing definition when saved.

---

## Style Sheet Types

You can create three style sheet types using PeopleSoft Application Designer:

- Standard style sheet
- Sub style sheet
- Free form sub style sheet

### Standard Style Sheet

This is an example of a standard style sheet:

### Image: Example of a standard style sheet

This example illustrates the fields and controls on the Example of a standard style sheet. You can find definitions for the fields and controls later on this page.

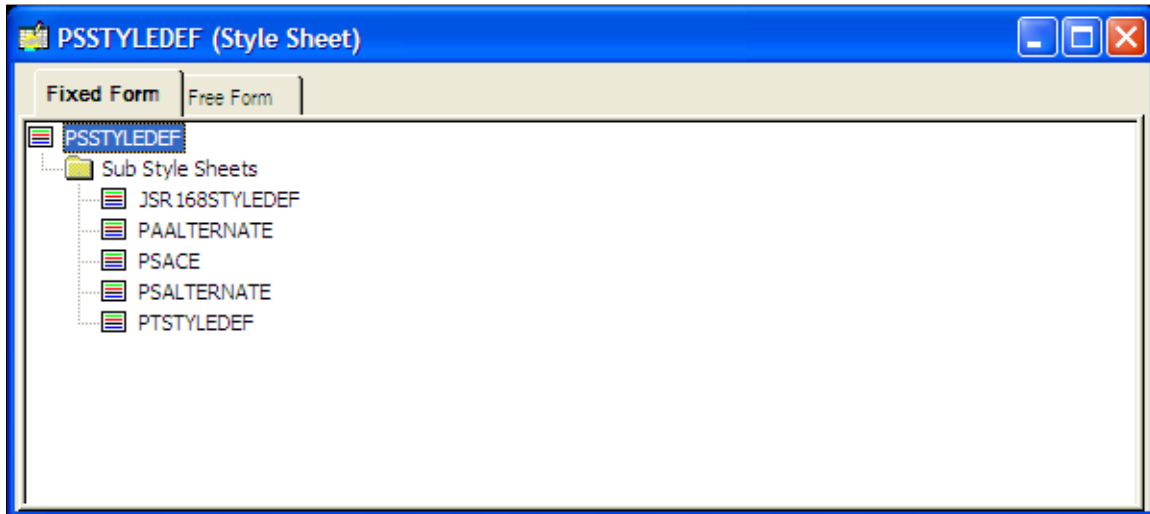

Standard style sheets are the primary organizers for working with style sheets and style classes. Standard style sheets are containers that can include sub style sheets, free form sub style sheets, and style classes in any combination; however, standard style sheets cannot contain other standard style sheets.

Standard style sheets can inherit style classes from other standard style sheet definitions through the Parent Style Sheet property. The parent style sheet propagates all of its style classes to the child style sheet. Only standard style sheets can have parent style sheets and be used as parent style sheets.

### Sub Style Sheet

This is an example of a sub style sheet:

#### Image: Example of a sub style sheet

This example illustrates the fields and controls on the Example of a sub style sheet. You can find definitions for the fields and controls later on this page.

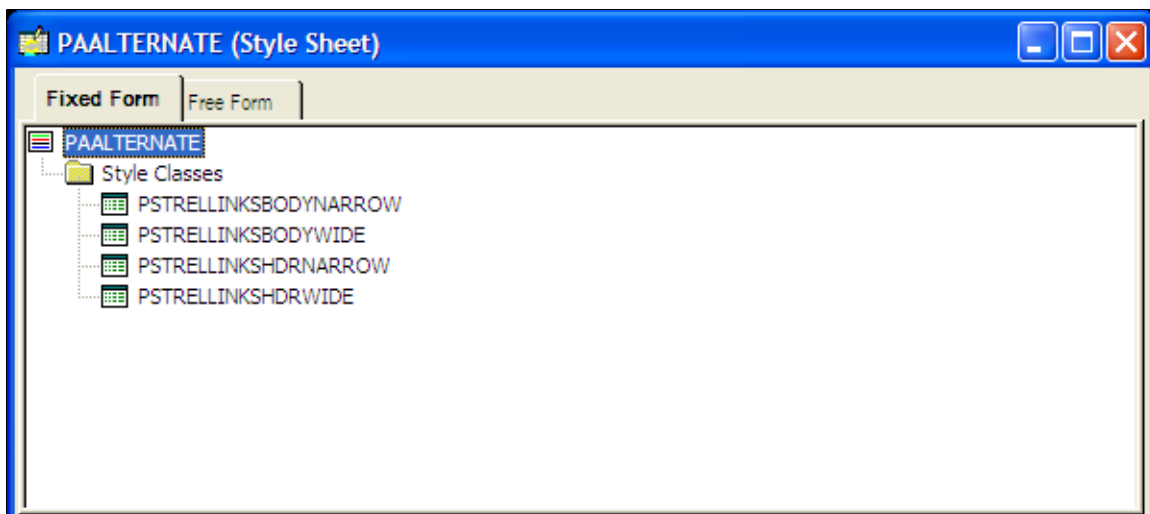

In the same way that PeopleTools supports subrecords, you can define sub style sheets. The primary purpose of sub style sheets is to organize and reuse style classes. You can insert sub style sheets into standard style sheets as well as into other sub style sheets. Sub style sheets neither have parent style sheets nor can be used as parent style sheets.

To use sub style sheets, you must insert them into standard style sheets.

## Free Form Sub Style Sheet

This is an example of a free form sub style sheet:

### Image: Example of a free form sub style sheet

This example illustrates the fields and controls on the Example of a free form sub style sheet. You can find definitions for the fields and controls later on this page.

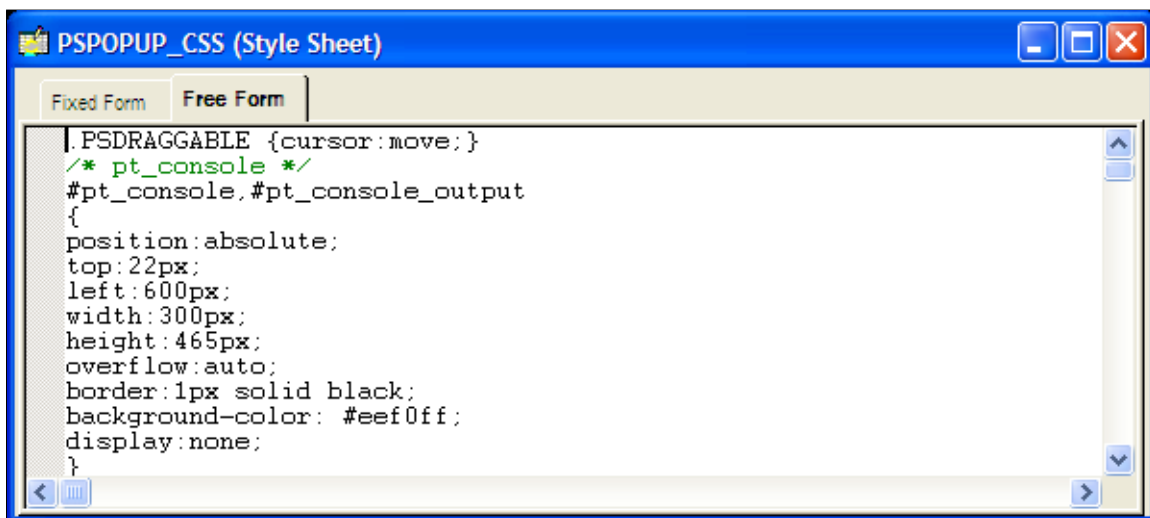

Free form sub style sheets are text-based sub style sheets that enable you to take advantage of Cascading Style Sheets - Level 2 (CSS2), AJAX, and DHTML features. With a free form sub style sheet, you can create the style sheet in a third-party editor and then copy the style sheet text into the Free Form tab of the free form sub style sheet. On free form sub style sheets, the Fixed Form tab is grayed out because free form sub style sheets do not support inheritance or aggregation. Free form sub style sheets cannot have parent style sheets nor can they be used as parent style sheets.

Note these important points regarding the use of free form sub style sheets:

- Like other sub style sheets, to use free form sub style sheets you must insert them into a standard style sheet or into a sub style sheet that is part of a standard style sheet.
- When creating free form style sheets, style class names must be identical to the PeopleTools default style class names.

If you replace the default style sheet or override the page style sheet with a style sheet that includes only free form text, the free form sub style sheet must define and include *all* default style classes used by the application. Unexpected results will occur in both PeopleSoft Application Designer and PeopleSoft Internet Architecture pages if a default style class is missing.

- At runtime, style classes in free form sub style sheets take precedence over PeopleTools-formatted style classes of the same name.

---

**Note:** Free form sub style sheets are supported in PeopleTools release 8.50 and later. If you attempt to import a free form sub style sheet into an earlier release, the free form sub style sheet imports as an empty standard style sheet.

---

## Style Classes

Access a style class dialog box.

### Image: PSEDITBOX style class properties dialog box

This example illustrates the fields and controls on the PSEDITBOX style class properties dialog box. You can find definitions for the fields and controls later on this page.

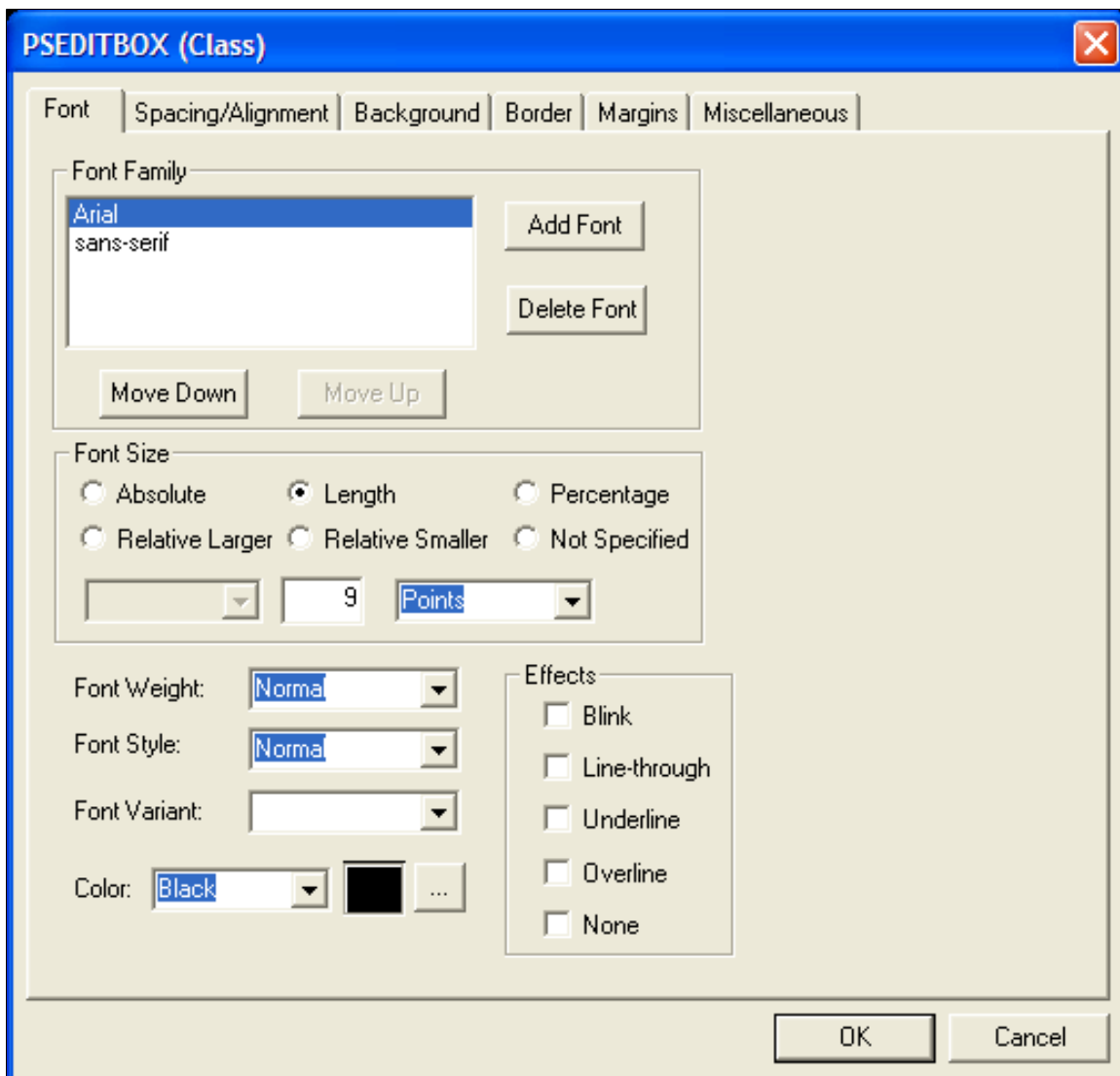

Standard style sheets and sub style sheets comprise standard style classes. The style class determines the visual properties of pages and page controls by controlling a broad range of characteristics, including font size, spacing, alignment, border width, font weight, and color.

Style classes in different style sheets are independent of each other. You can copy existing style classes and paste, or insert, them into any style sheet. However, the most efficient way to share style classes across multiple style sheets is to group style classes into sub style sheets.

## Default Style Classes

Default style classes are the PeopleTools style classes that the system explicitly associates with a page element, such as the page, each page control type, page control labels, and so on. PeopleSoft applications use the default style classes to render the page and all page elements at design time and at runtime, unless you specify a style property override.

See [Overriding Default Page Style Properties](#).

Note these points about default style classes:

- If you change an attribute of a default style class, the change affects *every* occurrence of the page element throughout an application, except the instances that do not use the default style.
- The application style sheet (or any page level override) must include *all* default style classes for the system to render pages correctly at design time and at runtime. The default style classes can be accounted for in standard or free form format in any combination. However, unexpected results will occur in both PeopleSoft Application Designer and PeopleSoft Internet Architecture pages if a default style class is missing.

---

**Note:** PeopleTools style sheets include all default style classes. You should not modify any PeopleTools style sheets or the attributes of default style classes.

---

Most default style class names enable you to easily identify the page element with which they are associated. For example, PSEDITBOX is the name of the default style class for all edit box page controls. When you examine a specific edit box control, the value in the Style field, however, is not the *name* of the default style class. The Style field value of *\*\*\*Use Default Value\*\*\** identifies any page element using its default style class.

This product documentation includes a topic that lists and describes the default style classes.

See [Default Style Classes](#).

## Custom Style Classes

This list includes some examples of custom style classes:

- Creating new PeopleTools style classes, inserting them into standard style sheets, and using them as style overrides to create unique pages in an application.
- Creating and inserting override style classes that supplant style classes inherited from a parent style sheet.
- Overriding page style classes with non-default, existing PeopleTools style classes.
- Creating free form style sheets that reconfigure one or more default style classes.

---

## Creating Standard and Sub Style Sheets

This section discusses how to:

- Create standard style sheets or sub style sheets.



- Rename standard style sheets or sub style sheets.
- Delete standard style sheets or sub style sheets.
- Insert sub style sheets into style sheets.
- Insert style classes into style sheets.
- Inserting override style classes into style sheets.

## Creating Standard Style Sheets or Sub Style Sheets

To create a new standard style sheet or sub style sheet:

1. Select File > New.
2. Select *Style Sheet* from the Definition drop-down list box and click the OK button.
3. Select the style sheet type.
4. Click the OK button.
5. Select File > Definition Properties.
6. Select the style sheet type and parent style sheet.

The Parent Style Sheet field is enabled if you create a standard style sheet only. The default parent style sheet is the application style sheet that you set on the PeopleTools Options page.

7. Enter a description.
8. Save the style sheet.

## Renaming Standard Style Sheets or Sub Style Sheets

To rename standard or sub style sheets:

1. Select File > Rename.
2. Select *Style Sheet* in the Definition drop-down list box and then enter search criteria to find the style sheet definition that you are deleting.
3. Click the Rename button; the definitions that match the search criteria appear in the list box.
4. Double-click the style sheet definition that you want to rename.
5. Enter the new name of the style sheet definition in the highlighted area and press the Enter key.
6. Click the OK button to confirm the rename.

---

**Note:** When you rename a standard or sub style sheet, PeopleSoft Application Designer automatically renames all references to the style sheet.

---

## Deleting Standard Style Sheets or Sub Style Sheets

To delete standard or sub style sheets:

1. Select File > Delete.
2. Select *Style Sheet* in the Definition drop-down list box and then enter search criteria to find the style sheet definition that you want to delete.
3. Press the Delete key; the definitions that match the search criteria appear in the list box.
4. Click the style sheet that you want to delete and press the Delete key.
5. Click the OK button to confirm the deletion or click the Cancel button to cancel the operation.

---

**Note:** When you delete a style sheet, PeopleSoft Application Designer automatically deletes all references to the deleted style sheet. If you delete a style sheet that contains sub style sheets, the sub style sheets are *not* deleted; they become independent definitions.

---

## Inserting Sub Style Sheets into Style Sheets

You can insert a sub style sheet into a standard style sheet or another sub style sheet.

To insert a sub style sheet into style sheets:

1. Create or open the receiving style sheet.
2. Select Insert > Insert Sub Style Sheet.
3. In the drop-down list boxes, select the sub style sheet type and the sub style sheet that you want to insert.
4. Click the OK button.
5. Save the sub style sheet.

You can remove sub style sheets from within other style sheets by highlighting the sub style sheet and pressing the Delete key. This action does *not* delete the definition from the database; it removes the sub style sheet from the current definition only.

## Inserting Style Classes into Style Sheets

You can insert style classes into any standard style sheet or sub style sheet.

To insert a style class into a style sheet:

1. Open the style sheet in which you want to create the new style class.
2. Select Insert > Insert Style Class.
3. Enter the name of the new class.

---

**Note:** Style class names can be upper case, lower case, or mixed case.

---

---

**Note:** If you import a lower case or mixed case style class into a PeopleTools version prior to PeopleTools 8.53, it may not work as expected.

---

4. Copy attributes from another style class by selecting the style class name from the Copy Values From Style Class drop-down list box.

Leave the Copy Values From Style Class field empty if you want to set all style class properties manually.

5. Click the OK button.
6. Configure style class attributes, as necessary.

See [Setting Style Class Attributes](#).

You can remove a style class from a style sheet by highlighting the class and pressing the Delete key. This action *does* delete this instance of the style class from the database.

---

**Note:** For efficiency, clone style classes from other style sheets. Then, either use the Insert menu or paste the style class into the new style sheet. At that time, the system enables you to enter the new style class name. Be aware that when copying style classes, the copy or clone will not contain any of the related language data associated with the original.

---

## Inserting Override Style Classes into Style Sheets

When you create a style sheet and configure the Parent Style Sheet property, the new style sheet inherits all of the style classes of the parent. If you want to change the attributes of an inherited default style class in the new style sheet, you insert an override style class. To insert an override style class into a style sheet:

1. Open the style sheet.
2. Verify that the Parent Style Sheet property is configured correctly.
3. Select Insert > Override Style Class.
4. Select the style class name from the Style Class drop-down list box and click the OK button.

The class properties dialog box appears showing the old settings.

5. Configure the override style class, as necessary.

See [Setting Style Class Attributes](#).

6. Click the OK button.
7. Save the style sheet definition.

---

## Setting Style Class Attributes

This section provides overviews of class attributes and fonts and discusses how to:

- Access class attributes.

- Specify fonts.
- Set font attributes for a specific language.
- Specify spacing and alignment.
- Specify background attributes.
- Reference a background image URL.
- Specify border attributes.
- Specify margins.
- Specify miscellaneous attributes.

## Understanding Class Attributes

Class attributes are grouped into categories and appear in a tabbed dialog box for each class.

---

**Note:** PeopleSoft Application Designer does not render certain style class formatting attributes at design time. You might be able to see the attribute at runtime only. Also, not all browsers support every style class attribute.

---

PeopleSoft Pure Internet Architecture supports the attributes that are listed in the World Wide Web Consortium (W3), Cascading Style Sheets, Level 1.

See <http://www.w3.org/TR/REC-CSS1>.

Every class has each of these major attributes, which correspond to a tab in the Class dialog box.

<b>Font</b>	Controls the font in which text appears. If more than one font is specified, the browser displays the first font; if it cannot find it, it displays the next font.
<b>Spacing/Alignment</b>	Controls the spacing in addition to the default spacing. You can specify additional spacing between words and between letters. You can also specify the alignment, height, indent, and white space.
<b>Background</b>	Controls the background colors for the page control. If the background is an image, you can select how the image appears.
<b>Border</b>	Controls the border that appears around the element. You can specify width, color, and style.
<b>Margins</b>	Controls the margins and padding on each side of the element.
<b>Miscellaneous</b>	Controls the display of list-item markers, URLs, and cursor formats.

## Understanding Generic and Installed Fonts

When you add a font, the dialog box provides a choice between generic fonts and installed fonts.

Generic fonts can appear in all browsers. This table lists examples of some of the generic fonts:

<b>Generic Font</b>	<b>Example</b>
Cursive	Zapf-Chancery
Fantasy	Western
Monospace	Courier
Sans serif	Helvetica
Serif	Times New Roman

## Installed Fonts

Installed fonts are installed on your computer. If you use an installed font for a style class, you should:

- Verify that *all* users of your application have the same installed font.
- Specify the installed font first, followed by a generic font.

If the installed font is not available to users of your application, they can use the generic font.

## Accessing Class Attributes

To access class attributes:

1. Open a style sheet.
2. Double-click the class name.

## Specifying Fonts

Access the class dialog box and select the Font tab.

**Image: PSLONGEDITBOX (Class) dialog box: Font tab**

This example illustrates the fields and controls on the PSLONGEDITBOX (Class) dialog box: Font tab. You can find definitions for the fields and controls later on this page.

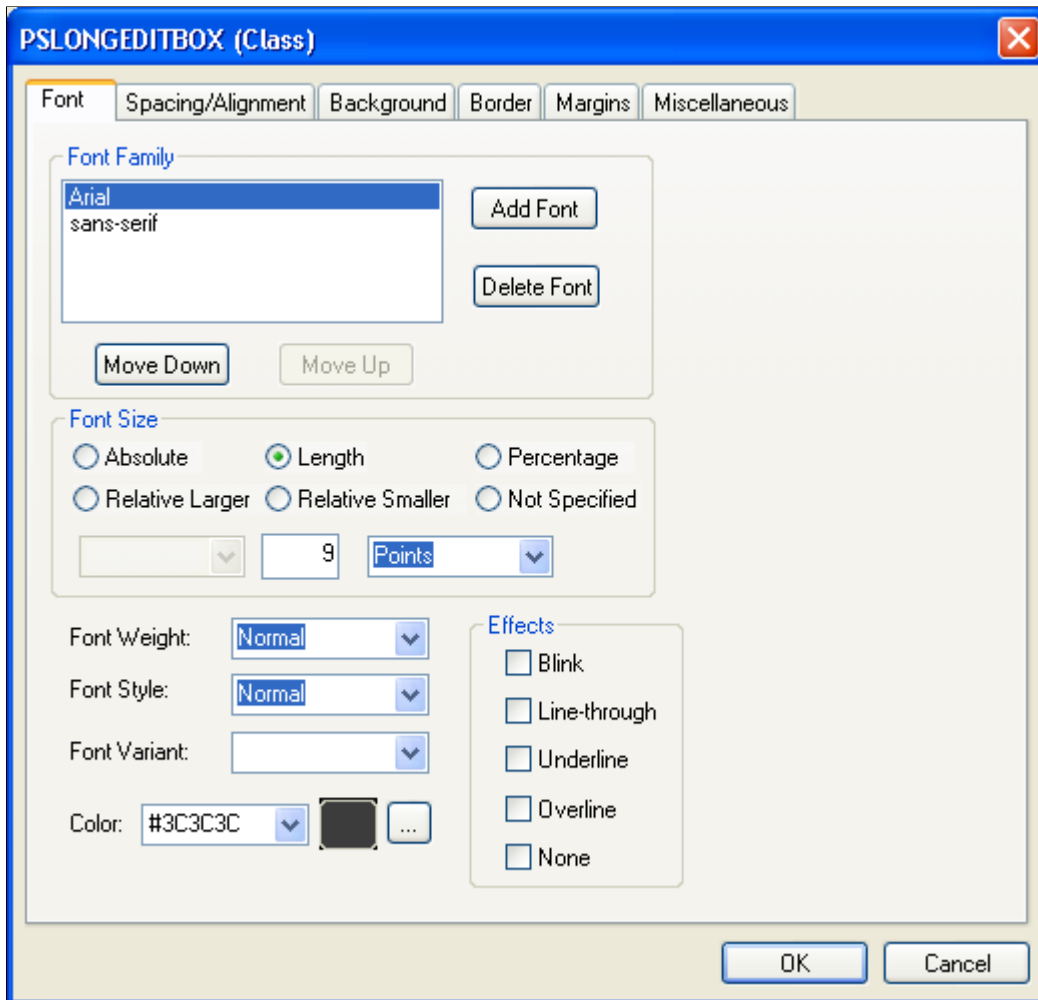
**Font Family**

Specify the font in which you want the text to appear. You can specify more than one font so that if the browser cannot display the first font, it will attempt to display the next font, and so on, until it finds a font that it can display.

**Font Size****Absolute**

Select to use a size from the drop-down list box (*xx-small*, *x-small*, *small*, *medium*, and so on). Adjacent sizes have a scaling factor of 1.5 between them.

**Length**

Specify the size with a number and select the measurement type from the drop-down list box (*em*, *ex*, *Pixels*, *Inches*, *Millimeters*, and so on).

<b>Percentage</b>	Specify a number, followed by a percent sign (%). Percentage values are always relative to the parent element.
<b>Relative Larger and Relative Smaller</b>	Select to interpret the font relative to the table of font sizes and the font size of the parent element. For example, if the parent element has a font size of medium and you select Relative Larger, this font size is large.
<b>Font Weight</b>	Select the weight of the font. The values <i>100</i> to <i>900</i> form an ordered sequence in which each number indicates a weight that is at least as dark as its predecessor. The value <i>Normal</i> is synonymous with <i>400</i> , and <i>Bold</i> is synonymous with <i>700</i> .
<b>Font Style</b>	Select the style of the font. Values are: <i>Normal</i> , <i>Italic</i> , or <i>Oblique</i> . These values are matched to existing fonts with those names.
<b>Font Variant</b>	Select a variant. Values are: <i>Normal</i> or <i>Small Caps</i> . In a small caps font, the lowercase letters look similar to the uppercase ones, but they are a smaller size and have slightly different proportions.
<b>Color</b>	Specify a color or select a color from a color palette.

## Setting Font Attributes for a Specific Language

You can change the fonts that are available based on the base language settings. The default for the base language is English, providing generic fonts. If these fonts are not appropriate for a particular language, you must set the language preference before opening a style sheet. You can then set the font name list, font size, or font weight for the selected language.

To set font attributes for a specific language:

1. Select PeopleTools > Utilities > International > Preferences from your browser.
2. Select the appropriate language for the style sheet from the drop-down list box.
3. Save the new selected language as the base language.
4. Open the style sheet definition in which you want to save the font name list, font size, or font weight for the selected language.

## Specifying Spacing and Alignment

Access the class dialog box and select the Spacing/Alignment tab.

**Image: PSEDITBOX (Class) dialog box: Spacing/Alignment tab**

This example illustrates the fields and controls on the PSEDITBOX (Class) dialog box: Spacing/Alignment tab. You can find definitions for the fields and controls later on this page.

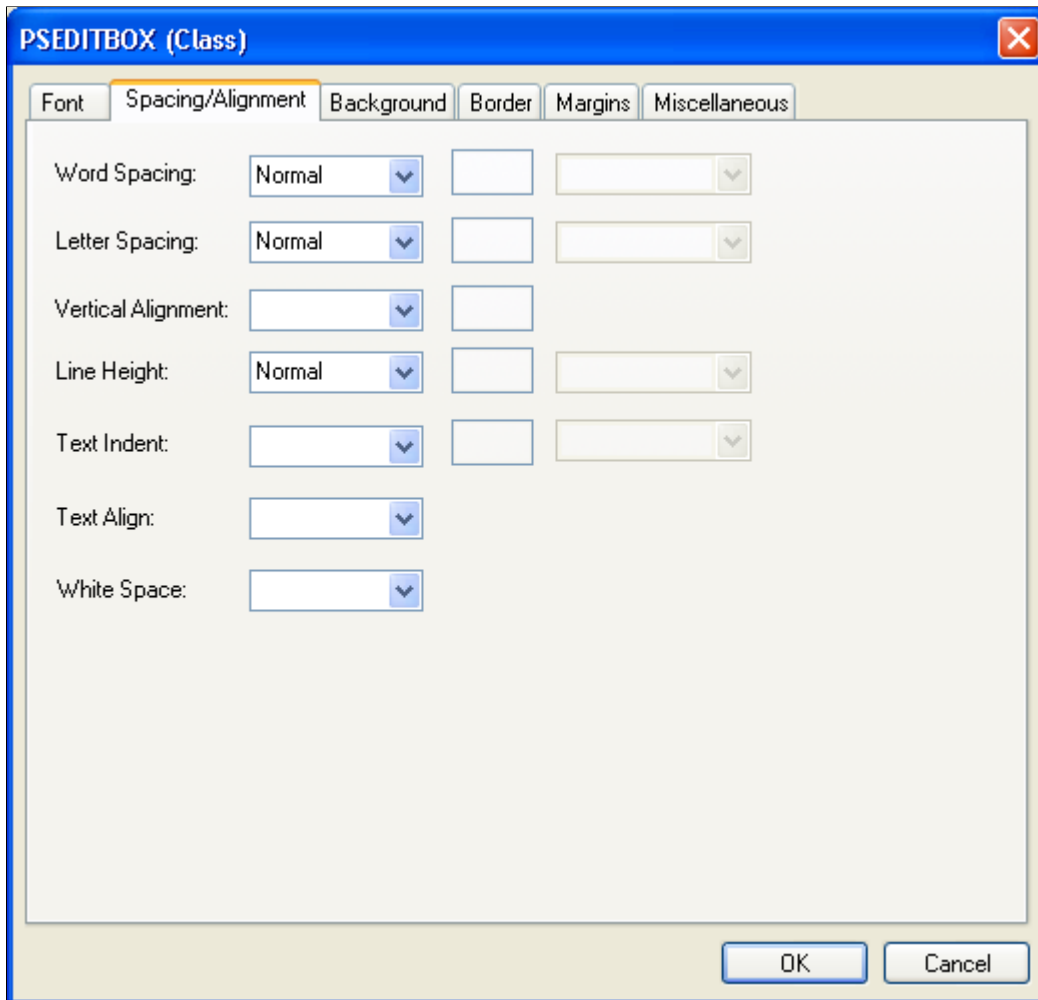
**Word Spacing and Letter Spacing**

Select *Normal* or *Length*. If you select *Length*, specify a number to indicate an addition to the default space between words or letters. Values can be negative, but implementation-specific limits might exist.

**Vertical Alignment**

Select the vertical positioning of the element. Values are:

*Baseline*: Aligns the baseline (or the bottom if the element does not have a baseline) of the element with the baseline of the parent.

*Sub*: (subscript) Aligns the top of the element with the baseline of the parent element.

*Super*: (superscript) Aligns the baseline of the element with the top of the parent element.

*Top*: Aligns the top of the element with the tallest element in the line.



*Text Top:* Aligns the top of the element with the top of the parent elements font.

*Middle:* Aligns the vertical midpoint of the element (typically an image) with the baseline plus half of the  $x$ -height of the parent.

*Bottom:* Aligns the bottom of the element with the lowest element on the line.

*Text Bottom:* Aligns the bottom of the element with the bottom of the parent elements font.

*Percentage:* Refers to the value of the line-height property of the element itself. It raises the baseline (or the bottom if it has no baseline) of the element to the specified amount above the baseline of the parent. Negative values are possible. For example, a value of  $-100%$  lowers the element so that the baseline of the element is where the baseline of the next line should have been. This setting allows precise control over the vertical position of elements (such as images that are used in place of letters) that do not have a baseline.

---

**Note:** Using the top and bottom alignments could cause a loop in which element dependencies occur.

---

## Line Height

Set the distance between the baselines of two adjacent lines.

When a numerical value is specified, the line height is provided by the font size of the current element multiplied with the numerical value. This differs from a percentage value in the way it inherits. When a numerical value is specified, child elements inherit the factor itself, not the resultant value (as is the case with percentage and other units). Negative values are not allowed.

## Text Indent

Specify the indentation that appears before the first formatted line. This value can be negative, but implementation-specific limits might exist. An indentation is not inserted in the middle of an element that was broken by another.

## Text Align

Specify how text is aligned in the element. Because Text Align inherits, all block-level elements inside the DIV element with CLASS=center are centered.

---

**Note:** Alignments are relative to the width of the element, not the canvas.

---

## White Space

Specify how to handle white space inside the element. Values are:

*Normal:* White space is collapsed.

*Pre:* Behaves like the PRE element in HTML.

*Nowrap*: Wrapping is done only through elements with a line break.

## Specifying Background Attributes

Access the class dialog box and select the Background tab.

### Image: PSEDITBOX (Class) dialog box: Background tab

This example illustrates the fields and controls on the PSEDITBOX (Class) dialog box: Background tab. You can find definitions for the fields and controls later on this page.

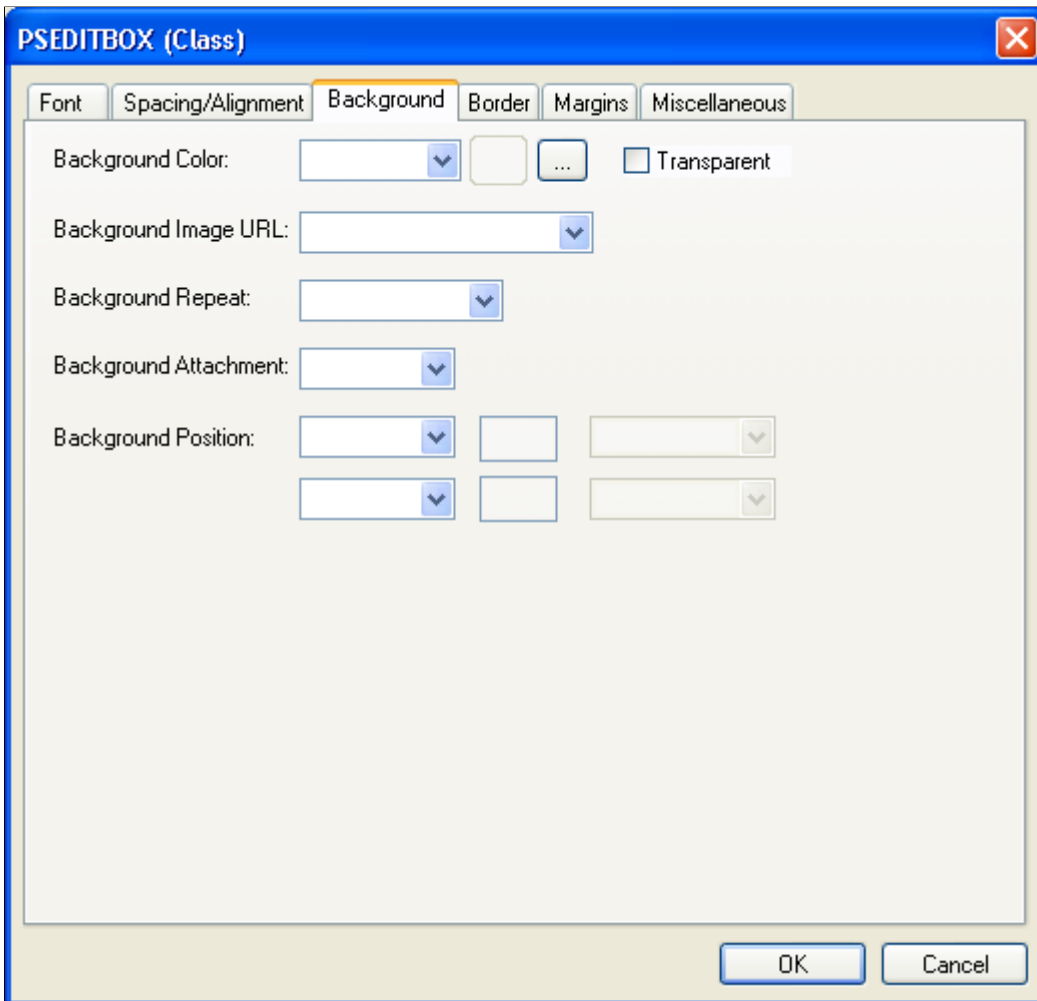

#### Background Color

Specify the background color of an element.

#### Background Image URL

Set the background image of an element to an image file that was previously defined. When you set a background image, also set a background color to use when the image is unavailable. When the image is available, it appears on top of the background color.

See [Setting Style Class Attributes](#).

**Background Repeat**

If you specify a background image, indicate whether the image is repeated and, if it is, how many times.

**Background Attachment**

If you specify a background image, indicate whether it is fixed to the canvas or whether it scrolls along with the content.

**Background Position**

If you specify a background image, set its initial position. Values are:

*Top:* Aligns the background to the top of the element.

*Left:* Aligns the background to the left of the element.

*Center:* Aligns the background to the midpoint of the element (typically an image).

*Bottom:* Aligns the background to the bottom of the element.

*Right:* Aligns the background to the right of the element.

*Length:* Specifies the length of the background and the unit of measure.

*Percentage:* Refers to the value of the line-height property of the background itself. It raises the baseline of the element (or the bottom, if it has no baseline) the specified amount above the baseline of the parent. Negative values are possible. For example, a value of  $-100%$  lowers the element so that the baseline of the element is where the baseline of the next line should have been. This setting allows precise control over the vertical position of elements without a baseline, such as images used in place of letters.

**Examples of Percentage and Length Value Pairs and Keywords**

This table lists background positions, value pairs, and their effect:

<b><i>Background Position</i></b>	<b><i>Value Pair</i></b>	<b><i>Effect</i></b>
Percentage	0 and 0	Places the upper, left-hand corner of the image in the upper, left-hand corner of the box that surrounds the content of the element (that is, not the box that surrounds the padding, border, or margin).
Percentage	100 and 100	Places the lower, right-hand corner of the image in the lower, right-hand corner of the element.

<b>Background Position</b>	<b>Value Pair</b>	<b>Effect</b>
Percentage	14 and 84	Places the point that is 14 percent across and 84 percent down the image at the point that is 14 percent across and 84 percent down the element.
Length	2cm and 2cm	Places the upper, left-hand corner of the image 2 centimeters (cm) to the right and 2 cm below the upper, left-hand corner of the element.
Top Left or Left Top	NA	The same as 0 percent and 0 percent.
Top Center or Center Top	NA	The same as 50 percent and 0 percent.
Right Top or Top Right	NA	The same as 100 percent and 0 percent.
Left Center or Center Left	NA	The same as 0 percent and 50 percent.
Center and Center	NA	The same as 50 percent and 50 percent.
Right Center or Center Right	NA	The same as 100 percent and 50 percent
Bottom Left or Left Bottom	NA	The same as 0 percent and 100 percent.
Bottom Center or Center Bottom	NA	The same as 50 percent and 100 percent.
Bottom Right or Right Bottom	NA	The same as 100 percent and 100 percent.

**Note:** If you set only one percentage or length value, the system sets the horizontal position only and the vertical position becomes the default 50 percent. If you set two values, the first one is the horizontal position. You can set negative positions and combinations of length and percentage values, for example 50 percent and 2 cm.

## Referencing a Background Image URL

To specify a background image URL, select from a drop-down list box that is populated by entries in the URL Maintenance table (PeopleTools Utilities, Administration, URL Maintenance). To reference a background image file on a designated server, add its location to the URL Maintenance table.

You reference a background image in the URL Maintenance table in the same way you would register any other URL.

See "Understanding the PeopleTools Utilities" (PeopleTools 8.58: System and Server Administration).

## Specifying Border Attributes

Access the class dialog box and select the Border tab.

**Image: PSGROUPBOX (Class) dialog box: Border tab**

This example illustrates the fields and controls on the PSGROUPBOX (Class) dialog box: Border tab. You can find definitions for the fields and controls later on this page.

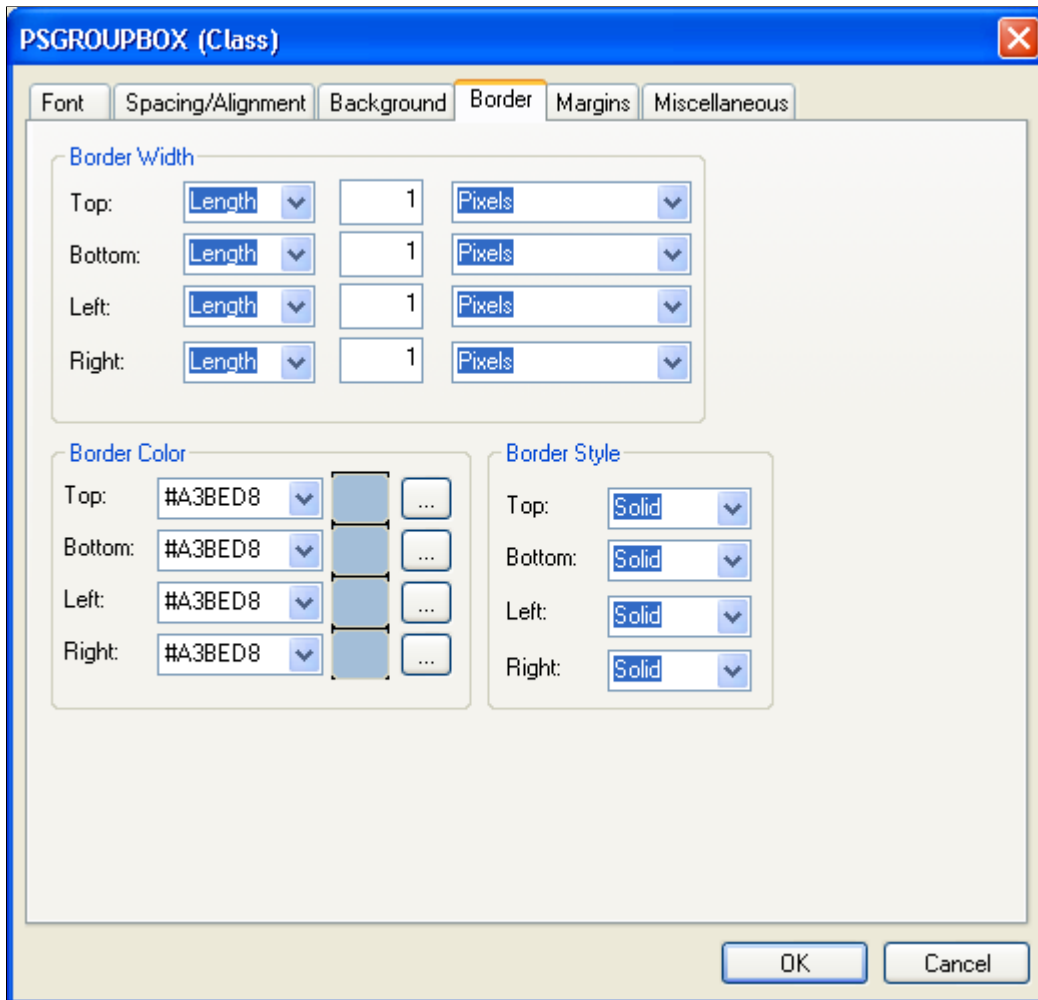
**Border Width**

Specify the width of each line in the border. Values are: *Thin*, *Medium*, or *Thick*, or you can specify *Length*, which enables you to specify a font size (with a number) and the measurement type from the drop-down list box (*Pixels*, *Inches*, *Millimeters*, and so on).

**Border Color**

Specify the color of each line in the border. You can specify a hexadecimal value for the color or select the color from a color palette.

**Border Style**

Specify the style of line in the border. Values are:

*None*: No border is drawn (regardless of the `<border-width>` value).

*Dotted*: Border is a dotted line that is drawn on top of the background of the element.

*Dashed:* Border is a dashed line that is drawn on top of the background of the element.

*Solid:* Border is a solid line.

*Double:* Border is a double line that is drawn on top of the background of the element. The sum of the two single lines and the space between equals the `<border-width>` value.

*Groove:* Border is a three-dimensional groove that is drawn in colors based on the `<color>` value.

*Ridge:* Border is a three-dimensional ridge that is drawn in colors based on the `<color>` value.

*Inset:* Border is a three-dimensional inset that is drawn in colors based on the `<color>` value.

*Outset:* Border is a three-dimensional outset is that is drawn in colors based on the `<color>` value.

## Specifying Margins

Access the class dialog box and select the Margins tab.

**Image: PSGROUPBOX (Class) dialog box: Margins tab**

This example illustrates the fields and controls on the PSGROUPBOX (Class) dialog box: Margins tab. You can find definitions for the fields and controls later on this page.

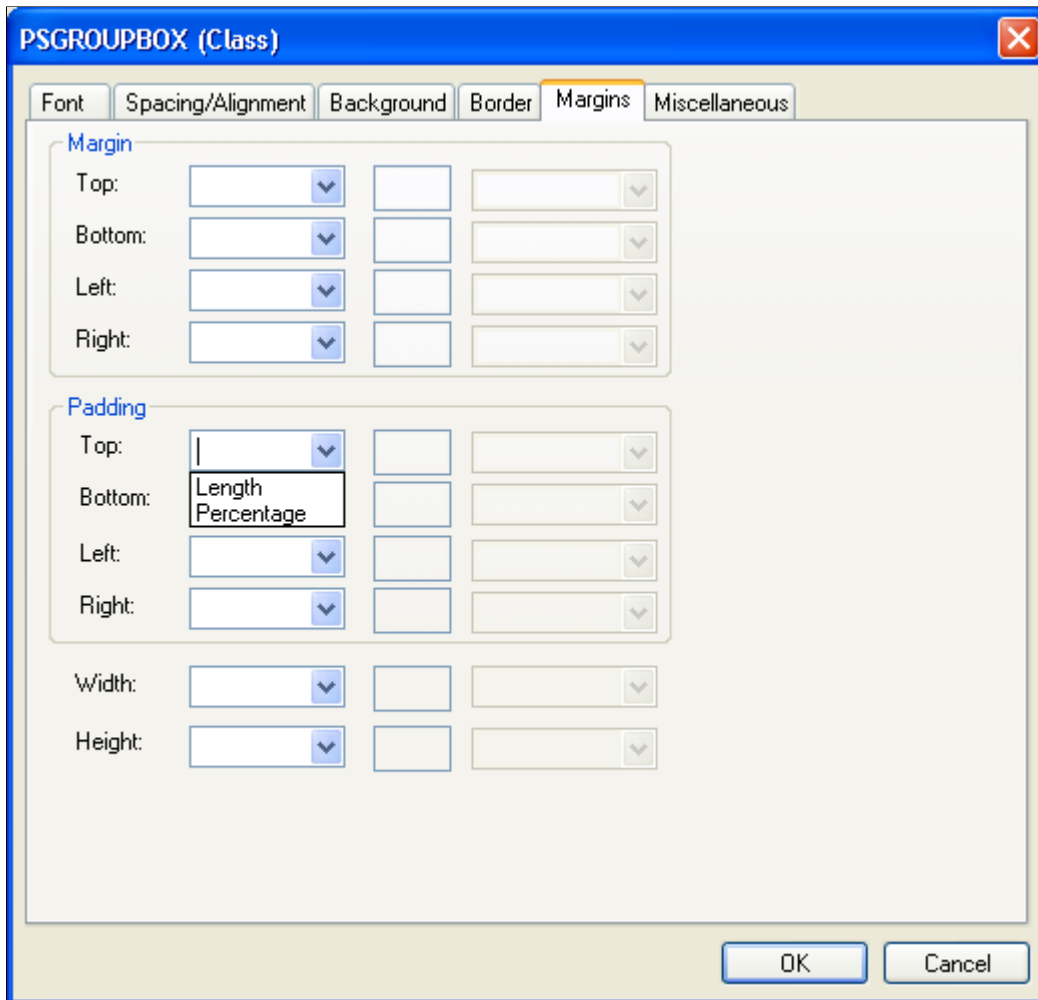
**Margin and Padding**

Specify the margin and padding for each side of the element. Values are:

*Length:* Specify a font size and the measurement type from the drop-down list box (*pixels, inches, millimeters, and so on*).

*Percentage:* Specify a number, followed by a percent sign (%). The percentage value is relative to the parent element.

*Auto:* The system calculates the width.

Do not use negative values for padding.

**Width and Height**

Set the width and height of text elements. These properties are most useful with replaced elements, such as images. The system scales the image to fit the value that you specify. If you set either property to *Auto* and the image needs scaling, the system preserves the aspect ratio of the image. Do not use negative values.

---

**Note:** If the width and height of a replaced element are both set to *Auto*, the system sets these properties to the intrinsic dimensions of the element.

---

## Specifying Miscellaneous Attributes

Access the class dialog box and select the Miscellaneous tab.

### Image: PSHYPERLINK (Class) dialog box: Miscellaneous tab

This example illustrates the fields and controls on the PSHYPERLINK (Class) dialog box: Miscellaneous tab. You can find definitions for the fields and controls later on this page.

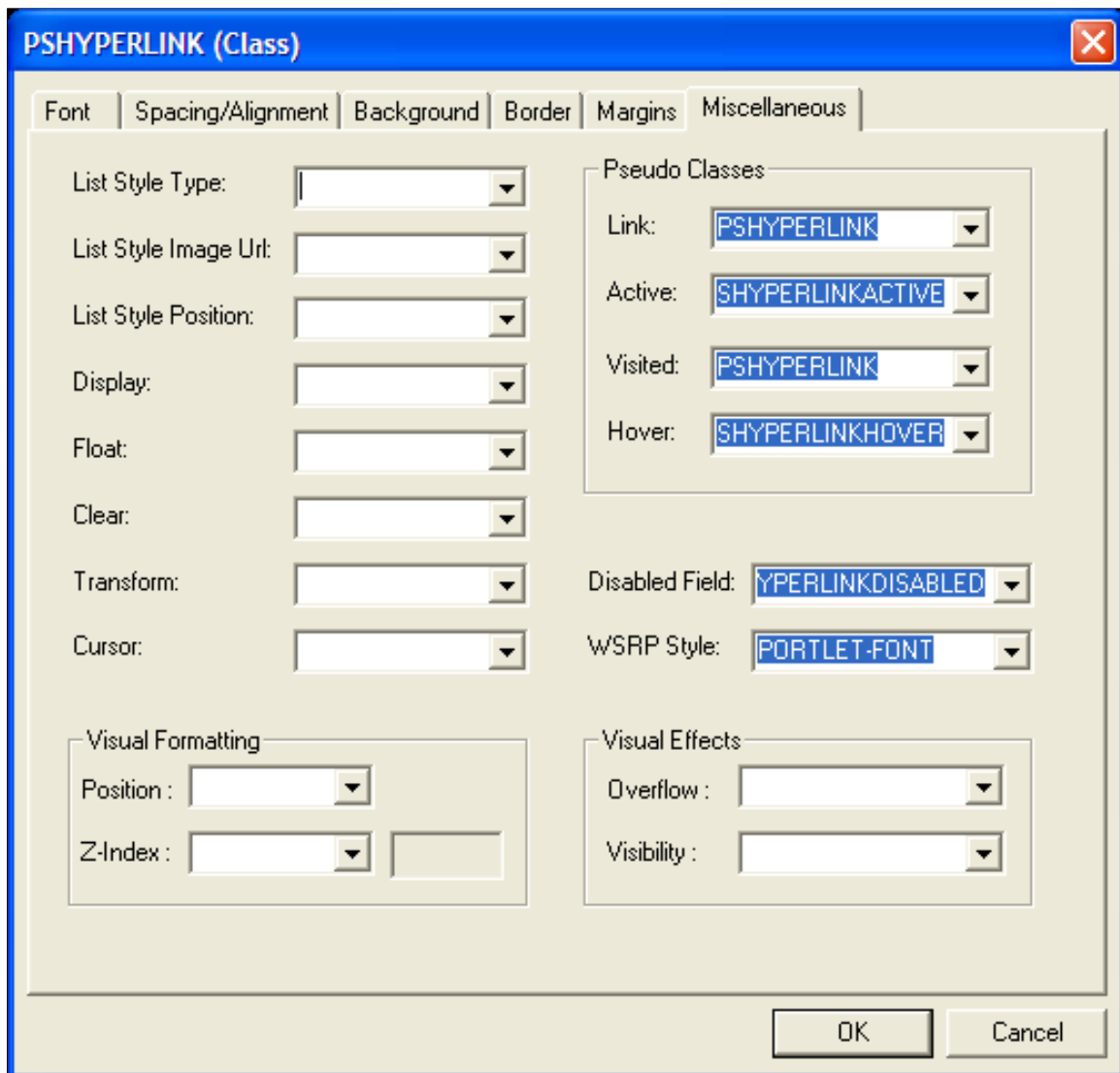

#### List Style Type

Specify the appearance of the list-item marker if the List Style Image URL field is blank or if the system cannot display the image that the URL referenced.



<b>List Style Image Url</b> (list style image URL)	Specify the URL containing the image to display as the list-item marker.
<b>List Style Position</b>	Specify how the list-item marker is drawn relative to the content. Values are: <i>Inside</i> and <i>Outside</i> .
<b>Display</b>	Specify how an element appears on the canvas, which might be a printed page or a computer display. Values are:  <i>Block</i> : Opens a new box. The box is positioned relative to adjacent boxes. Typically, elements like H1 and P are block types.  <i>ListItem</i> : Similar to block except that a ListItem marker is added. In HTML, LI typically has this value.  <i>Inline</i> : Results in a new inline box on the same line as the previous content. The box dimensions are based on the formatted size of the content. If the content is text, it might span several lines and each line will have a box. The margin, border, and padding properties apply to inline elements but do not affect line breaks.  <i>None</i> : Deactivates the display of the element, including children elements and the surrounding box.
<b>Float</b>	Specify how the element floats with the text. Values are:  <i>None</i> : Causes the element to appear where it appears in the text.  <i>Left</i> and <i>Right</i> : Causes the element to move to the left or right, and the text wraps on the right-hand or left-hand side of the element, respectively. With a <i>Left</i> or <i>Right</i> value, the system treats the element as block-level and ignores the Display property.
<b>Clear</b>	Specify the sides of an element on which floating elements are not accepted. Values are:  <i>Left</i> : An element appears below any floating element on the left-hand side.  <i>Right</i> : An element appears below any floating element on the right-hand side.  <i>Both</i> : An element appears below any floating element on the left-hand and the right-hand side.  <i>None</i> : Floating elements are allowed on all sides.
<b>Transform</b>	Use for text elements only. Values are: <i>Capitalize</i> , <i>Uppercase</i> , <i>Lowercase</i> , and <i>None</i> .

<b>Cursor</b>	Specify the appearance of the cursor when it passes over an element.
<b>Disabled Field</b>	Specify the appearance of the link when the link (or field) is disabled.
<b>WSRP Style</b> (web services for remote portlets style)	Specify the appearance of the link when the link appears in a portlet.

## Pseudo Classes

Pseudo classes are mechanisms that extend the expressiveness of style sheets. Using pseudo classes, you can change the style of page links based on whether and when the links have been visited. Pseudo classes do not exist in HTML; that is, they are not visible in the HTML code.

PeopleSoft applications uses pseudo classes to specify how a browser indicates to a user the status of links in a document that the user is viewing. For example, a browser might display a document link in a different color than the rest of the text.

<b>Link</b>	Specify the normal appearance of a link.
<b>Active</b>	Specify the appearance of a link that is actively selected.
<b>Visited</b>	Specify the appearance of a link that has been visited.
<b>Hover</b>	Specify the appearance of a link when it is designated but not activated. For example, when the cursor hovers over a box that an element generated.

## Visual Formatting

<b>Position</b>	<p>The position property places an element in a static, relative, absolute, or fixed position.</p> <p><i>Static:</i> The page element always has the position the normal flow of the page gives it (a static element ignores any top, bottom, left, or right declarations). This value is the default.</p> <p><i>Relative:</i> The page element moves relative to its normal position, for example, <i>left:20</i> adds 20 pixels to the left position of the element.</p> <p><i>Absolute:</i> The page element is positioned at the specified coordinates relative to its containing block. The position of the element is specified with the <i>left</i>, <i>top</i>, <i>right</i>, and <i>bottom</i> properties.</p> <p><i>Fixed:</i> The page element is positioned at the specified coordinates relative to the browser window.</p> <p><i>Absolute:</i> The page element is positioned at the specified coordinates relative to its containing block. The position of</p>
-----------------	--------------------------------------------------------------------------------------------------------------------------------------------------------------------------------------------------------------------------------------------------------------------------------------------------------------------------------------------------------------------------------------------------------------------------------------------------------------------------------------------------------------------------------------------------------------------------------------------------------------------------------------------------------------------------------------------------------------------------------------------------------------------------------------------------------------------------------------------------------------------------------------------------------------------------------------------------------------------------------

the element is specified with the *left*, *top*, *right*, and *bottom* properties.

## Z-Index

Positioning of elements in CSS occurs in three dimensions, not just two. The placement of elements along this third axis, a z-axis, is exactly what this property controls. The third dimension is perpendicular to the screen, giving the screen a sense of depth. Elements can be overlapped, with higher or closer elements obscuring elements that are lower or farther away (element transparency becomes an important issue with this capability).

The rendering box for each element is automatically assigned an integer z-index stacking level based on its context in the document. Boxes with greater z-axis numbers will appear in front of boxes with lower z-axis numbers (0 and negative numbers are allowed). Explicitly setting the z-index property for an element box not only sets its z-position relative to other element boxes in its current context, it also initiates a new stacking context hierarchy that affects the current element box and its child elements. If two or more boxes have the same stacking level within the same context, then they are rendered back to front in the order of the document tree. If no z-index property is set for an element box, then it inherits the stacking level of its parent element box.

## Visual Effects

### Overflow

This property specifies whether the content of a block-level element is clipped when it overflows the element box (which acts as a containing block for the content).

*Visible:* This value indicates that content is not clipped; it may be rendered outside the block box.

*Hidden:* This value indicates that the content is clipped and that no scrolling mechanism should be provided to view the content outside the clipping region; users will not have access to clipped content. You specify the size and shape of the clipping region using the *Clip* property.

*Scroll:* This value indicates that the content is clipped and that if the user agent uses scrolling mechanism that is visible on the screen (such as a scroll bar), a box should display the mechanism whether any of its content is clipped. This setting avoids any problem with scroll bars appearing and disappearing in a dynamic environment. When this value is specified and the target medium is print or projection, overflowing content should be printed.

*Auto*: The behavior of this value is user agent-dependent, but it should cause a scrolling mechanism to be provided for overflowing boxes.

## Visibility

This property specifies whether the boxes generated by an element are rendered. Invisible boxes still affect layout (set the `Display` property to `None` to suppress box generation altogether).

*Visible*: The generated box is visible.

*Hidden*: The generated box is invisible (fully transparent) but still affects layout.

*Collapse*: This property may be used in conjunction with scripts to create dynamic effects on rows and columns. If used on elements other than rows or columns, *Collapse* has the same meaning as *Hidden*.

---

## Working With Free Form Sub Style Sheets

This section discusses how to:

- Create free form sub style sheets.
- Insert free form sub style sheets into standard style sheets.
- Convert standard style sheets into free form sub style sheets.
- Rename free form sub style sheets.
- Delete free form sub style sheets.
- Include meta-variables and comments in free form sub style sheets.
- Change font and color settings in free form sub style sheets.

## Creating Free Form Sub Style Sheets

To create a free form sub style sheet:

1. Select `File > New`.
2. Select `Style Sheet` from the list.
3. Select the `Free Form Sub Style Sheet` style sheet type.
4. Select `File > Definition Properties` to enter a description for documentation purposes; when done, click the `OK` button.
5. Select the `Free Form` tab and enter the text for the style sheet.

6. Save the style sheet.

---

**Important!** The Style Sheet Editor does not perform any syntax checking on free form sub style sheets. You must verify and correct any style errors that occur at runtime.

---

## Inserting Free Form Sub Style Sheets into Standard Style Sheets

To insert a free form sub style sheet into a standard style sheet:

1. Open the receiving standard or sub style sheet.
2. Click the Fixed Form tab.
3. Select Insert > Insert Sub Style Sheet.
4. Select *Freeform Sub Style Sheet* from the Sub Style Sheet Type drop-down list box.
5. Select the free form style sheet from the Sub Style Sheet drop-down list box.
6. Click the OK button and save the style sheet.

## Converting Style Sheets to Free Form Sub Style Sheets

To convert a style sheet to a free form sub style sheet:

1. Open a standard style sheet or sub style sheet.
2. Select File > Definition Properties.
3. In the Style Sheet Type drop-down list box, select *Freeform Sub Style Sheet* and click the OK button.

---

**Note:** You will be warned that once the style sheet is saved as a free form type the style sheet data cannot be converted back to the standard or sub style sheet type.

---

4. Dismiss the warning dialog box.
5. Save the style sheet.

---

**Note:** You should not modify a PeopleTools style sheet; instead, clone the style sheet and make changes to the copy.

---

## Renaming Free Form Sub Style Sheets

To rename a free form sub style sheet:

1. Select File > Rename.
2. Select *Style Sheet* in the Definition drop-down list box and then enter search criteria to find the style sheet definition that you are renaming.
3. Click the Rename button; the definitions that match the search criteria appear in the list box.
4. Double-click the style sheet definition that you want to rename.

5. Enter the new name of the style sheet definition in the highlighted area and press the Enter key.
6. Click the OK button to confirm the rename.

---

**Note:** When you rename a free form sub style sheet, PeopleSoft Application Designer automatically renames all references to the style sheet.

---

## Deleting Free Form Sub Style Sheets

To delete a free form sub style sheet:

1. Select File > Delete.
2. Select *Style Sheet* in the Definition drop-down list box and then enter search criteria to find the style sheet definition that you are deleting.
3. Press the Delete key; the definitions that match the search criteria appear in the list box.
4. Click the style sheet that you want to delete and press the Delete key.
5. Click the OK button to confirm the deletion or click the Cancel button to cancel the operation.

---

**Note:** When you delete a style sheet, PeopleSoft Application Designer automatically deletes all references to the deleted style sheet.

---

## Including Meta-Variables and Comments in Free Form Sub Style Sheets

This section discusses:

- Meta-variables.
- Comments.

### Meta-Variables

Free form sub style sheets support these PeopleTools meta-variables:

- %AlignStart
- %AlignEnd
- %AlignAmount
- %Image

See "Understanding Meta-HTML" (PeopleTools 8.58: PeopleCode Language Reference).

See "Working with HTML Areas and Style Sheets" (PeopleTools 8.58: Global Technology).

---

**Note:** The system ignores any other meta-variables.

---

Meta-variables in the free form sub style sheet are resolved at runtime before the style sheet is downloaded to the client. Meta-variable processing does not occur at design time. In PeopleSoft

Application Designer, if you select Layout > View in Browser, you do not see any results from meta-variable processing.

## Comments

To insert comments, include the text between `/*` and `*/`.

The use of `//` is not supported.

## Changing Font and Color Settings in Free Form Sub Style Sheets

When entering code in the Free Form tab of free form sub style sheets, the appearance of the various elements of the code, such as comments, is based on the default font and color settings in the Font and Color Settings dialog box.

Access the Font and Color Settings dialog box. (Open a free form sub style sheet and select Edit, Display Font and Colors.)

### Image: Font and Color Settings dialog box

This example illustrates the fields and controls on the Font and Color Settings dialog box. You can find definitions for the fields and controls later on this page.

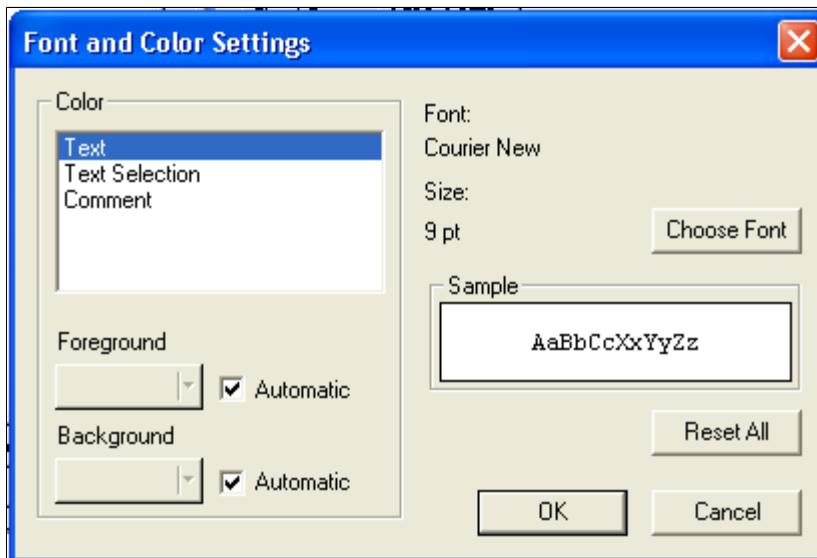

**Color** Select the item whose color you want to change. Values are:

*Text*

*Text Selection*

*Comment*

**Foreground** Click to select a font color.

**Background** Click to select the color of the background behind the font.

**Choose Font** Click to select a font.

**Reset All** Click to reset all defaults to the original settings.

You can change the default font and color settings for free form sub style sheets.

### Changing the Default Font and Color Settings

To change a default font and color setting:

1. In the Color group box, select an item from these choices:

*Text*

*Text Selection*

*Comment*

2. Select a color from the Foreground drop-down list box.
3. Select a color from the Background drop-down list box.
4. Click the Choose Font button to select another font.
5. Click Reset All to restore the settings to the default settings.
6. Click the OK button.

## Working with the Default Style Sheet

Classic PeopleSoft applications use a default style sheet that contains all default style classes. You specify the default application style sheet on the PeopleTools, Branding, Branding System Options page. Depending on what you install (PeopleTools or a PeopleSoft application) and what version, the default style sheet differs. These style sheets are delivered:

<b>Classic Style Sheet</b>	<b>Release</b>
PSSTYLEDEF	PeopleTools 8.53 and lower. PeopleSoft applications 9.0 and lower.
PSSTYLEDEF_SWAN	PeopleSoft applications for releases 9.1.
PSSTYLEDEF_TANGERINE	PeopleSoft applications for releases 9.2.

**Note:** You can only use standard style sheets as a default application style sheet.

PSSTYLEDEF\_FMODE is the default style sheet for fluid applications.

### Related Links

"Identifying PeopleTools Style Sheets" (PeopleTools 8.58: Fluid User Interface Developer's Guide)



## Working with PSSTYLEDEF

### Image: PSSTYLEDEF style sheet

This example illustrates the look and feel of the PSSTYLEDEF style sheet.

The screenshot shows the configuration page for user PSADMIN. The interface is organized into several sections:

- General:** User ID: PSADMIN, Description: PeopleSoft Administrator, Account Locked Out? (checkbox).
- Logon Information:** Symbolic ID: SYSADM (dropdown), Password: (masked), Confirm Password: (masked), Password Expired? (checkbox), User ID Alias: (text field).
- General Attributes:** Language Code: English (dropdown), Currency Code: (dropdown), Default Mobile Page: (text field with search icon), Enable Expert Entry (checkbox).
- Permission Lists:** Navigator Homepage: QEPAGES, Process Profile: QEPAGES, Primary: QEPAGES, Row Security: QEPAGES.

Navigation buttons at the bottom include: Save, Return to Search, Previous in List, Next in List, Add, and Update/Display. A breadcrumb trail at the bottom reads: General | ID | Roles | Workflow | Audit | Links | User ID Queries.

PSSTYLEDEF is the default application style sheet. The PSSTYLEDEF style sheet comprises all default style classes and includes these sub style sheets:

- JSR168STYLEDEF: Defines PeopleSoft Portlet default style classes.
- PAALTERNATE: Defines PeopleSoft Portal Solutions alternatives to PS default style classes.
- PSACE: Defines analytic calculation engine and analytic grid default style classes.
- PSALTERNATE: Defines application alternatives to PS default style classes.
- PSCHARTSTYLE: Defines charting default style classes.
- PSORGCHART: Defines organization chart default style classes.
- PSRATEBOX: Defines rating box default style classes.
- PTSTYLEDEF: Defines the standard PeopleSoft Pure Internet Architecture and portal default style classes.
- PSNAV2: Defines the 8.5x Menu navigation style classes. This sub style sheet is free form.
- PSPOPUP\_CSS: Defines the pop-up dialog box page style classes. This sub style sheet is free form.
- PSTAB\_PTCSS: Defines the page tab style classes. This sub style sheet is free form.

---

**Note:** You should not modify PSSTYLEDEF or other PeopleTools style sheets; instead, clone existing style sheets and make changes to the copy.

---

## Working with PSSTYLEDEF\_SWAN

### Image: PSSTYLEDEF\_SWAN style sheet

This example illustrates the look and feel of the PSSTYLEDEF\_SWAN style sheet.

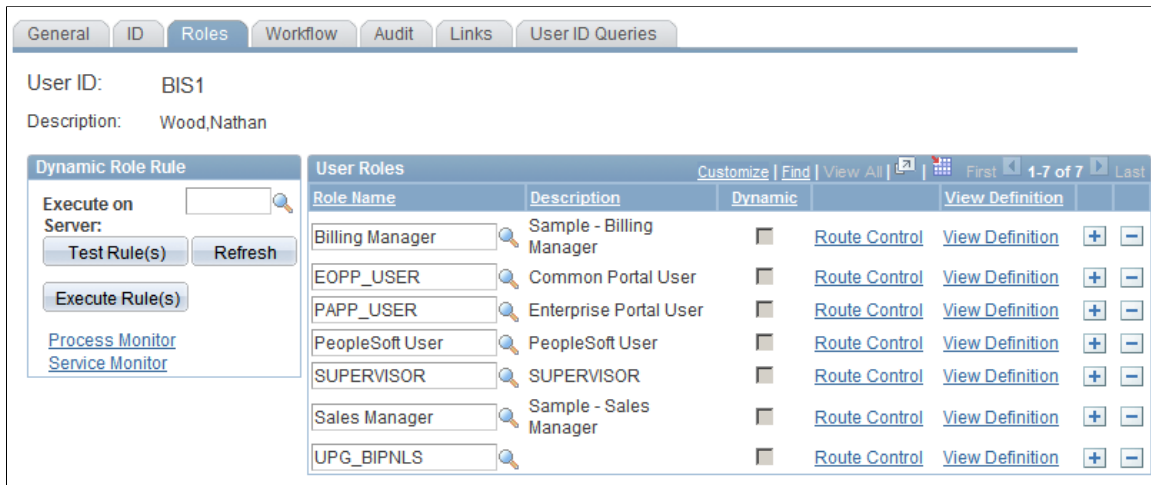

The style classes in the PSSTYLEDEF\_SWAN style sheet are comparable to those in the PSSTYLEDEF style sheet. The page styles provided by PSSTYLEDEF\_SWAN are the standard design for all Oracle Applications products.

---

**Note:** The My Reports pagelet contains exceptions to the SWAN style sheet and might appear to look different from the standard SWAN style.

---

**Note:** Any custom style sheets or sub style sheets that you use with PSSTYLEDEF\_SWAN must include SWAN in the definition name.

---

The PSSTYLEDEF\_SWAN style sheet comprises all default style classes and includes these sub style sheets:

- JSR168STYLEDEF\_SWAN: Defines PeopleSoft Portlet default style classes.
- PAALTERNATE\_SWAN: Defines PeopleSoft Portal Solutions alternatives to PS default style classes.
- PSACE\_SWAN: Defines analytic calculation engine and analytic grid default style classes.
- PSALTERNATE\_SWAN: Defines application alternatives to PS default style classes.
- PSCHARTSTYLE\_SWAN: Defines charting default style classes.
- PSORGCHART\_SWAN: Defines organization chart default style classes.
- PSRATEBOX\_SWAN: Defines rating box default style classes.
- PTSTYLEDEF\_SWAN: Defines the standard PeopleSoft Pure Internet Architecture and portal default style classes.
- PSNAV2\_SWAN: Defines the 8.5x Menu navigation style classes. This sub style sheet is free form.
- PSPOPUP\_CSS\_SWAN: Defines the pop-up dialog box page style classes. This sub style sheet is free form.

- PSTAB\_PTCSS\_SWAN: Defines the page tab style classes. This sub style sheet is free form.

**Note:** You should not modify PSSTYLEDEF\_SWAN or other PeopleTools style sheets; instead, clone existing style sheets and make changes to the copy.

**Important!** Do not use the \*\_SWAN images in any customized code. These images are used by an Application Engine program to toggle between the new appearance and classic appearance. Using these images or modifying them in any way changes the attributes and has unexpected distortions in the appearance of your application pages. In addition, these images are subject to change in future releases of the application.

## Working with PSSTYLEDEF\_TANGERINE

### Image: PSSTYLEDEF\_TANGERINE style sheet

This example illustrates the look and feel of the PSSTYLEDEF\_TANGERINE style sheet.

The screenshot displays a configuration page for a user profile. At the top, there are tabs for 'General', 'ID', 'Roles', 'Workflow', 'Audit', 'Links', and 'User ID Queries'. The 'General' tab is selected. The user ID is 'PSADMIN' and the description is 'Administrator'. There is a checkbox for 'Account Locked Out?'. Below this is a section for 'Logon Information' with fields for 'Symbolic ID' (set to 'SYSADM'), 'Password', and 'Confirm Password'. There is also a checkbox for 'Password Expired?'. Below that is a section for 'General Attributes' with fields for 'Language Code' (set to 'English'), 'Currency Code', and 'Default Mobile Page'. There is a checkbox for 'Enable Expert Entry'. At the bottom is a section for 'Permission Lists' with fields for 'Navigator Homepage', 'Process Profile', 'Primary', and 'Row Security'. The page includes navigation buttons like 'Save', 'Return to Search', 'Previous in List', 'Next in List', 'Add', and 'Update/Display'.

The PSSTYLEDEF\_TANGERINE style sheet comprises all default style classes, uses PSSTYLEDEF and PSSTYLEDEF\_SWAN as a base, and includes these sub style sheets:

- JSR168STYLEDEF\_SWAN: Defines PeopleSoft Portlet default style classes.
- PAALTERNATE\_SWAN: Defines PeopleSoft Portal Solutions alternatives to PS default style classes.
- PSACE\_CSS3: Defines analytic calculation engine and analytic grid default style classes.
- PSALTERNATE\_TANGERINE: Defines application alternatives to PS default style classes.
- PSCHARTGANTT\_TANGERINE: Defines Gantt chart default style classes.
- PSCHARTSTYLE\_TANGERINE: Defines charting default style classes.
- PSORGCHART\_TANGERINE: Defines organization chart default style classes.

- PSRATEBOX: Defines rating box default style classes.
- PTSTYLEDEF\_TANGERINE: Defines the standard PeopleSoft Pure Internet Architecture and portal default style classes.
- PSNAV2\_CSS3: Defines the 8.5x Menu navigation style classes. This sub style sheet is free form.
- PSPOPUP\_CSS\PSPOPUP\_CSS3: Defines the pop-up dialog box page style classes. This sub style sheet is free form.
- PSTAB\_PTCSS3: Defines the page tab style classes. This sub style sheet is free form.

## Changing the Default Style Sheet

To change the default application style sheet, modify the options on the Branding System Options page.

See "Configuring Branding System Options" (PeopleTools 8.58: Portal Technology).

## Configuring Other Default Style Sheets

You can use other style sheets as the default, including those that comprise free form text only, as long as the style sheet contains all default style classes.

To change the default application style sheet:

1. In the browser, select PeopleTools > Utilities > Administration > PeopleTools Options.
2. Enter the style sheet in the Style Sheet Name field.
3. Save the page.
4. Select PeopleTools > Portal > Portal Utilities > System Options.
5. Enter the style sheet name in the Style Sheet Name field.
6. Save the page.
7. In the browser, select PeopleTools > Portal > Portal Utilities > Registry Options.
8. Enter the style sheet name in the Style Sheet Name field.
9. Save the page.
10. Stop the web server, delete all cache files, and restart the web server.
11. Stop the application server, delete all cache files, and restart the application server.

---

## Overriding Default Page Style Properties

Unless you override the default style sheet at the page level, the browser renders all pages and page fields based on the default style classes that comprise the application style sheet. If you want to use different styles to create subtle changes or entirely unique pages, you can override styles at the page and page field levels.

This section discusses how to:

- Override the default page style sheet.
- Override the default page background style.
- Override default page field styles.

## Overriding the Default Page Style Sheet

You can override the default page style sheet by accessing the page properties dialog box of any PeopleSoft page. When you override the default page style sheet, you are not changing the default style classes for the page; you are indicating to the system to select the default style classes from a different style sheet. Note these points when overriding the page style sheet:

- Changing the page style sheet overrides the default style sheet only for the selected page.
- Only the custom and default style classes that comprise the current page style sheet—whether default or override—are available for use by the page and its elements. Style classes on other style sheets are inaccessible.
- If you select a page style sheet that comprises only free form sub style sheets, the system constrains all subordinate page elements to their default style classes.
- If you select a page style sheet that comprises only free form sub style sheets, the page designer renders the page using the application style sheet, not the free form style sheet.

To override the default page style sheet:

1. Open the page in PeopleSoft Application Designer.
2. Select File > Definition Properties to access the Page Properties dialog box.
3. Select the Use tab.
4. Click the Page Style Sheet drop-down list box and select a style.
5. Click the OK button and save the page.
6. Select Layout, View in Browser to preview the page.

Unlike the page designer view, this option renders the page with all style classes, including free form styles.

## Overriding the Default Page Background Style

The page background derives from the Background tab of the PSPAGE style class contained in the current page style sheet, whether default or override. You can override the default page background style.

Note these points about changing the default value of the page background style:

- Changing the page background style value for a specific page overrides the background properties of only the current page.

- If the current page style sheet comprises only free form sub style sheets, the system constrains the page background style to the default style class.
- The Page Background Style drop-down list box displays only the style classes that comprise the current page style sheet, whether default or override. Style classes that do not appear in the current page style sheet do not appear in the list.

To override the default page background style:

1. Open the page in PeopleSoft Application Designer.
2. Select File > Definition Properties to access the Page Properties dialog box.
3. Select the Use tab.
4. Click the Page Background Style drop-down list box and select a style.
5. Click the OK button and save the page.
6. Select Layout > View in Browser to preview the page.

Unlike the page designer view, this option renders the page with all style classes, including free form styles.

## Overriding the Default Page Field Styles

You can override the default style of most page field controls, such as edit boxes, drop-down list boxes, and so on. Many page field controls include a separate label style that enables you to override the label style independent of the control style itself.

Note these points about changing the default style of a page field:

- The Style drop-down list box displays only the style classes that comprise the current page style sheet, whether default or override. Style classes that do not appear in the current page style sheet do not appear in the list.
- If the page style sheet comprises only free form sub style sheets, then the system constrains all page field controls to the default style despite the Style field value.

To override the default page field style:

1. Open a page in PeopleSoft Application Designer.
2. Double-click the page field control to access the Properties dialog box.
3. Select the Record tab.
4. Click the Style drop-down list box and select a new style.
5. Click the Label tab.
6. Click the Style drop-down list box and select a new style.
7. Select Layout > View in Browser to preview the page.

Unlike the page designer view, this option renders the page with all style classes, including free form styles.

8. Save the page.

In addition to setting the style property at design time, you can also use the PeopleCode Field object Style property to programmatically change the style class of a field at runtime.

See "Using the Field Object Style Property" (PeopleTools 8.58: PeopleCode Developer's Guide).

---

## Modifying Page Tabs

This section provides an overview of tabs and discusses how to:

- Create tab images.
- Customize page tab style sheets.

## Understanding Tabs

To provide a greater degree of and simpler user-level configuration, PeopleSoft applications use the sliding door technique for tabs. Cascading style sheets (CSS) have the advantage of layering background images, which enables them to slide over each other to create visually interesting effects.

The default style sheet and the SWAN style sheet contain CSS tabs. You can, however, change the background colors of these CSS folder and grid tabs. To change the background colors of tabs, you should have a basic understanding of how tab definitions are constructed and stored in the database.

### Sliding Doors Technique

Sliding door tabs expand and contract based on the size of the text by using two separate background images: one image to render the left side of a tab and the other image to render the right. Think of these two images as the sliding doors that complete one opening. The doors slide together and overlap more to fill a narrower space, or slide apart and overlap less to fill a wider space. The background images only show in the available doorway of the element to which they are applied (content area plus padding). The two images are anchored to the outside corners of their respective elements. The visible portions of these background images fit together inside the doorway to form a tab-like shape.

### Sliding Door Tab Images

You need to know the following image names to modify the style sheets that ship with PeopleSoft applications.

For the dark blue look and feel, folder tabs and grid tabs use these images:

- PSTAB\_LEFT.gif
- PSTAB\_RIGHT.gif

For the SWAN look and feel, the folder tabs and the grid tabs use these images:

- PSTAB\_LEFT\_SWAN.gif

- PSTAB\_RIGHT\_SWAN.gif

The CSS code behind the rendering of the tab image is:

```
#PSTAB a { background:transparent url(%IMAGE(PSTAB_LEFT)) no-repeat left top; padding:0 2px 0 5px; } #PSTAB a span { font-size:9pt; background:transparent url(%IMAGE(PSTAB_RIGHT)) no-repeat right top; padding:4px 14px 2px 5px; }
```

When working with sliding door tabs, the images load faster, are simpler to maintain, and the text within them can be scaled up or down significantly in size without breaking the page. Along with these new images, applications take advantage of the CSS background-position property to move into view the appropriate portion of the combined-state background image when the user hovers over a tab.

### Image: Style sheet sliding door tab preload technique

The following image is an example of a Style sheet sliding door tab preload technique

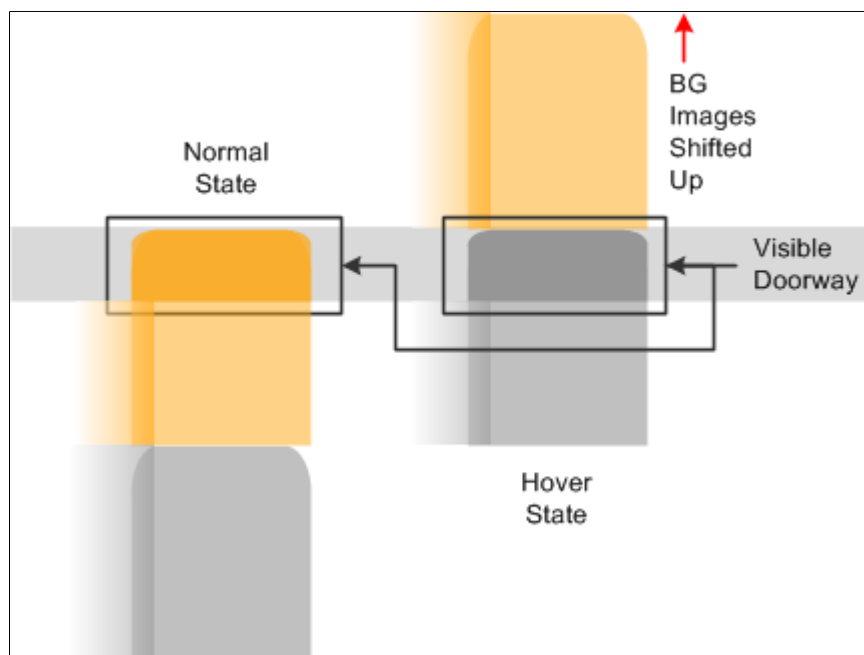

Applications use the shifted background positions from the active, inactive, and hover states.

## Creating Tab Images

Before you can assign a new background color to the active, inactive, and hover states of the tabs, you must create the necessary tab images in that color. To produce tabs in a different color combination:

1. In PeopleSoft Application Designer, open the image definitions for the tabs that you want to change.
2. Select File, Export Image and, in the Save Image dialog box, select the directory in which you want to place the images.
3. Use any image editor to alter the image colors to the same as the new background color you choose.



---

**Note:** Do not replace any of the transparent pixels with solid pixels. Additionally, you should leave the size and shape as they are even though the style sheets allows you to alter the size and shape of images.

---

4. Select File, New, Image to add the new image definitions to the database.
5. Save the new image files under the appropriate names.
6. Customize the tabs.

See [Customizing Page Tab Style Sheets](#).

## Customizing Page Tab Style Sheets

After you create the new images, you must change the properties of the style classes rendering the new sliding door tabs. The style classes that render the folder tabs and the grid tabs are PSTAB and PTGRIDTAB, respectively. Both style classes are part of the PSTAB\_PTCSS free form style sheet.

To modify the tab properties:

1. Open the appropriate free form style sheet, PSTAB\_PTCSS if you are using the default style sheet or PSTAB\_PTCSS\_SWAN if you are using the SWAN style sheet.
2. For folder tabs, modify the PSTAB style class; for grid tabs, modify the PTGRIDTAB style class.

For example, if you have two new folder tab images, the left and the right image of the tab, each has a different name and you must change the code as you see here:

```
#PSTAB a
{
background:transparent url(%IMAGE(<newlyCreatedLeftSideTabImageName>)) no-repe=>
at left top;
....
}
#PSTAB a span
{
font-size:9pt;
background:transparent url(%IMAGE(<newlyCreatedRightSideTabImageName>)) no-rep=>
eat right top;
....
}
```

---

**Note:** You must replace `<newlyCreatedLeftSideTabImageName>` and `<newlyCreatedRightSideTabImageName>` with the names of the new images that you create. You might have to modify the position property if the new images vary in size from the original images.

---

3. Because the image contains all active, inactive, and hover color properties, you only need to change the pixel properties and background positioning if the delivered images have changed in size and shape.
4. You can modify style class properties such as border, padding, font, and text to create the required look for the tabs you are implementing.
5. You can override the tab bottom line by changing the following code: `#PSTAB #TABBOTTOMLINE { Color: #809EBA; background: repeat-x right 18px; }`

6. You can adjust the hover properties as shown in this example: 

```
#PSTAB a:hover a { color: #555555; } #PSTAB a:hover span {font-size:9pt; background-position:100% -50px; }
```

---

**Note:** The `<span>` element renders the main part of the tab. Adjust any necessary properties, such as `background-position` in the `<span>` element to render the image correctly. The left image is small, and you need to adjust only the color and possibly the border properties.

---

7. Save the style sheet.
8. Stop the application server, clear the cache, and restart the application server.
9. Stop the web server, clear the cache, and restart the web server.

---

## Modifying Push Buttons in SWAN Style Sheets

This section provides an overview of push buttons in the SWAN style sheet and discusses how to:

- Create SWAN style sheet push button images.
- Customize SWAN push buttons in HTML areas.

### Understanding Push Button in the SWAN Style Sheet

PeopleSoft applications provide the PTPUSHBUTTON free form style sheet as part of the SWAN style sheets. You can edit all properties in the PTPUSHBUTTON style sheet to change the look and feel of the classic yellow push button. Like sliding door tabs, push buttons expand and collapse to accommodate the button text, and the buttons come with a left and right image. The left image is associated with the `<a>` element, and the right image is associated with the `<span>` element. The `<span>` element contains text and font properties for the button. The PTPUSHBUTTON free form style sheet overrides the existing properties provided in the PSPUSHBUTTON style class in the PSSTYLEDEF\_SWAN style sheet. You edit push buttons similarly to the way that you edit sliding door tabs.

### Creating SWAN Style Sheet Push Button Images

All the steps for altering sliding door tab images are the same as for sliding door buttons. Do not alter the size of a button because doing so will affect the way the background position is defined for the button.

### Customizing SWAN Push Buttons in HTML Areas

If any custom-defined push buttons in HTML areas appear in the yellow button background, you can change them to look like the SWAN push button style. To customize SWAN push buttons in HTML areas:

1. Open the HTML area that contains the push button you want to modify.
2. Locate the `<input type=button.../>` tag.
3. Following the `<input type...>` tag, insert the following tags: `<a class='PSPUSHBUTTON'><span> ... </span></a>` .

## Related Links

[Modifying Page Tabs](#)

## Style Sheets Definitions List

The following table describes the user interface elements with their respective style sheets. It covers details about modifying styles in classic pages.

<b>Section</b>	<b>Element</b>	<b>Fixed Form Styles</b>	<b>Free Form Styles</b>	<b>Style Sheet</b>	<b>Description</b>
Page Header	Bread crumb section background and its other related styles.		#pthnavcontainer	PSHNAV_CSS3	The background Image and other attributes such as border, height, padding etc. can be customized by changing the styles of id - #pthnavcontainer in PSHNAV_CSS3
Page Header	Header background image below bread crumb section and its other related styles		#pthdr2container	PSHDR2_SWAN_CSS3	The background Image and other attributes such as border, height, padding etc can be customized by changing the styles of id - #pthnavcontainer in PSHDR2_SWAN_CSS3
Page Header	Styles of separator between home and Add to favorites link		.pthdr2sep	PSHDR2_SWAN_CSS3	The separator styles can be customized by modifying style properties of class .pthdr2sep and its IE hack styles in PSHDR2_SWAN_CSS3 .
Page Header	Color of links such as Home and Favorites link		dl#pthdr2links dt a	PSHDR2_SWAN_CSS3	This can be customized by changing the styles of id #pthdr2links in PSHDR2_SWAN_CSS3
Page Header	Bread Crumb hyperlink color		.pthnav a, .pthnav span, #pthnavbc a, #pthnavbc span	PSHNAV_CSS3	This can be achieved by changing the styles of class .pthnav and its IE hack styles in PSHNAV_CSS3

<b>Section</b>	<b>Element</b>	<b>Fixed Form Styles</b>	<b>Free Form Styles</b>	<b>Style Sheet</b>	<b>Description</b>
Page Header	Global search drop down select box text font styles.		a#selsrchgrp span	PSHDR2_SWAN_CSS3	This can be achieved by changing the styles of id selsrchgrp and its IE hack styles in PSHDR2_SWAN_CSS3
Page Header	Search box text content styles		input.pthdr2srcheditgbl	PSHDR2_SWAN_CSS3	This can be achieved by changing the styles of input tag with id pthdr2srcheditgbl and its IE hack styles in PSHDR2_SWAN_CSS3
Page Header	Header search link styles		table#ipthdr2linksgbl td a	PSHDR2_SWAN_CSS3	This can be achieved by changing the styles of id pthdr2linksgbl and its IE hack styles in
Page Header	Header search box border styles		input.pthdr2srcheditgbl , #selsrchgrp,	PSHDR2_SWAN_CSS3	This can be achieved by changing the styles of class pthdr2srcheditgbl and id selsrchgrp and its IE hack styles in PSHDR2_SWAN_CSS3
Page Header	Header search text box alignment styles		input.pthdr2srcheditgbl	PSHDR2_SWAN_CSS3	This can be achieved by changing the styles of class pthdr2srcheditgbl and its IE hack styles in PSHDR2_SWAN_CSS3
Page Header	Header bottom border styles		#pthdr2container	PSHDR2_SWAN_CSS3	This can be achieved by changing the styles of id pthdr2container in PSHDR2_SWAN_CSS3
Bread Crumb Drop Down Menu	Header bread crumb links drop down menu hyperlink styles		.pthnav li li a, #pthnavbc li li a	PSHNAV_CSS3	This can be achieved by customizing the styles of class pthnav in pshnav_css3
Bread Crumb Drop Down Menu	Header bread crumb links drop down menu border styles		.pthnavshadow	PSHNAV_CSS3	This can be achieved by customizing the styles of class pthnavshadow in PSHNAV_CSS3

<b>Section</b>	<b>Element</b>	<b>Fixed Form Styles</b>	<b>Free Form Styles</b>	<b>Style Sheet</b>	<b>Description</b>
Bread Crumb Drop Down Menu	Styles of Drop Down menu which opens up on click of Bread Crumb links. ( Click on Main Menu from bread crumb, it opens up a drop down menu with Crefs )		li div.pthnavflyout, #pthnavbc li div.pthnavflyout	PSHNAV_CSS3	This can be achieved by modifying the attributes of id given here.
Bread Crumb Drop Down Menu	Bread crumb drop down menu shadow effect styles		.pthnavshadow	PSHNAV_CSS3	Modify the style attributes of class mentioned here.
Bread Crumb Drop Down Menu	Bread crumb drop down menu -Search box section styles		div#pthnavsrchlbl, #pthnavsrchform, #pthnavgoIm	PSHNAV_CSS3	Modify the styles of id's given here to customize the styles of search box section and its label.
Bread Crumb Drop Down Menu	Bread crumb drop down menu - Sort icon section styles		div.pthnavsort	PSHNAV_CSS3	Modify the styles of class mentioned here
Bread Crumb Drop Down Menu	Bread crumb drop down menu content section styles		.pthnavscroll	PSHNAV_CSS3	Customize the background styles of drop down menu by pthnavscroll class as mentioned here.
Bread Crumb Drop Down Menu	Bread Crumb drop down menu - CREF link styles and right arrow styles		.pthnav li li, #pthnavbc li a, .pthnav li li a, #pthnavbc li li a, .pthnavrightarrow	PSHNAV_CSS3	This can be achieved by modifying the styles of id's and classes mentioned here in PSHNAV_CSS3 stylesheet.
Bread Crumb Drop Down Menu	Bread Crumb drop down menu - folder image and cref image styles		.pthnavfldrimg, .pthnavcrefimg	PSHNAV_CSS3	This can be achieved by modifying the styles of classes mentioned here in PSHNAV_CSS3 stylesheet.
Pagelets Section in WorkCenter Page	Pagelet header font styles		.ptalPglAreaHeader Label a span	PTAL_SUBSTYLE_REQ_TANGERINE	This can be achieved by customizing the styles of class talPglAreaHeader Label in PTAL_SUBSTYLE_REQ_TANGERINE

<b>Section</b>	<b>Element</b>	<b>Fixed Form Styles</b>	<b>Free Form Styles</b>	<b>Style Sheet</b>	<b>Description</b>
Pagelets Section in WorkCenter Page	Styles of hyperlinks in the pagelets		.PSHYPERLINK, . PSHYPERLINK:visited	PSROUNDED CORNER_CSS3	This can be achieved by customizing the styles of class . PSHYPERLINK in PSROUNDED CORNER_CSS3
Pagelets Section in WorkCenter Page	Tabs outline styles which gets displayed in the pagelets		.ptalPageletGroupTab a, . ptalPageletGroupTab . selected a	PTAL_SUBSTYLE _REQ_ TANGERINE	This can be achieved by customizing the styles of class . ptalPageletGroupTab in PTAL_ SUBSTYLE_REQ_ TANGERINE
Pagelets Section in WorkCenter Page	Borders of the pagelets		.ptpgltheadr	PTAL_SUBSTYLE _REQ_ TANGERINE	This can be achieved by customizing the styles of class ptpgltheadr in PTAL_ _SUBSTYLE_REQ_ TANGERINE
Home Page, Menu Pagelet Section	Styles of hyperlinks which appears in this section		.ptnav2fldr a	PSHNAV2_CSS3	This can be achieved by customizing the styles of class . ptnav2fldr in PSHNAV2_CSS3
Home Page, Menu Pagelet Section	Height of header row	PTPAGELET HEADER		PTSTYLEDEF_ TANGERINE	This can be achieved by customizing fixed form style as shown.
Home Page, Menu Pagelet Section	Border styles for this.	PTPAGELET HEADER, PTPAGELET BODY	.ptalPglArea _docked . ptalPglAreaResizeBar	PTAL_SUBSTYLE _VL_TANGERINE and PTSTYLEDEF _TANGERINE	This can be achieved by customizing the styles of class . ptalPglAreaResizeBar in PTAL_ SUBSTYLE_VL_ TANGERINE and fixed form styles as shown.
Tab outline in User Profiles Page	Styles of tabs in User Profiles Page. PeopleTools -> Security -> User Profiles		PSTAB, PSTABNBO in PSTAB_ PTCSS3 and PSBOTTOMLINE in PSROUNDEDCORNER _CSS3	PSTAB_PTCSS3, PSROUNDED CORNER_CSS3	This can be achieved by customizing the styles of id PSTAB, PSTABNBO in PSTAB_PTCSS3 and PSBOTTOMLINE class in PSROUNDED CORNER_CSS3 as shown.

<b>Section</b>	<b>Element</b>	<b>Fixed Form Styles</b>	<b>Free Form Styles</b>	<b>Style Sheet</b>	<b>Description</b>
Push Button	Gradient and border styles of push button		.PSPUSHBUTTON#Left, .PSPUSHBUTTON#Left: hover, .PSPUSHBUTTON#Left: hover	PTPUSHBUTTON_CSS3	This can be achieved by customizing the styles of class PSPUSHBUTTON, PSPUSHBUTTON in PTPUSHBUTTON_CSS3 as shown
Push Button	Hover styles of push button		.PSPUSHBUTTON#Left: hover, .PSPUSHBUTTON#Left: hover	PTPUSHBUTTON_CSS3	This can be achieved by customizing the styles of class PSPUSHBUTTON:, PSPUSHBUTTON in hover state in PTPUSHBUTTON_CSS3 as shown
Disabled Push Button	Styles of disabled push button. ( Main Menu, Usage Monitoring page - Stop Test push button)		input.PSPUSHBUTTON DISABLED, .PSPUSHBUTTON DISABLED#Left	PTPUSHBUTTON_CSS3	The style customization of disabled push button can be achieved by modifying the styles of PTPUSHBUTTONDISABLED class
Grids	Styles of tabs inside the grids, tab font color styles and border styles		#PSTAB #selected a span, #PTGRIDTAB #selected a span, #PSTABNBO #selected a span, #PSTAB a span, #PTGRIDTAB a span, #PSTABNBO a span, #PTGRIDTABNBO a span. For tab outline border styles in grid, modify pstab_ptcss3 #PTGRIDTAB a span, #PTGRIDTABNBO a span	PSTAB_PTcss3	This can be achieved by customizing the styles of class PSTAB in PSTAB_PTcss3 as shown
Grids	Grids Table without border - grid border styles.	PAGROUPDIVIDER		Fixed form PSALTERNATE_TANGERINE	This can be achieved by customizing the styles of fixed form class PAGROUPDIVIDER in PSALTERNATE_TANGERINE as shown

<b>Section</b>	<b>Element</b>	<b>Fixed Form Styles</b>	<b>Free Form Styles</b>	<b>Style Sheet</b>	<b>Description</b>
Grids	Grids Table with border - grid border styles for table with border .	PSLEVEL1GRID WBO, PSLEVEL2GRID WBO, PSLEVEL3GRID WBO.		Modify the styles in fixed form PTSTYLEDEF_TANGERINE	This can be achieved by customizing the styles of fixed form class PSLEVEL1GRIDWBO in PTSTYLEDEF_TANGERINE as shown
Grids	Background color of grid box header section		.PSLEVEL1 GRIDLABEL, .PSLEVEL2 GRIDLABEL, .PSLEVEL3 GRIDLABEL	PSROUNDED CORNER_CSS3	Modify the styles in PSROUNDEDCORNER_CSS3 for classes . PSLEVEL1GRIDLABEL, . PSLEVEL2GRIDLABEL, and . PSLEVEL3GRIDLABEL
Grids	Font styles, border styles, padding and margin styles in grid box header section	.PSLEVEL1GRID LABEL, .PSLEVEL2GRID LABEL, .PSLEVEL3GRID LABEL		PTSTYLEDEF_TANGERINE	Modify the styles in fixed form PTSTYLEDEF_TANGERINE
Grids	Gradient styles for table header row in grid box.		.PSLEVEL1GRID COLUMNHDR:link, .PSLEVEL1GRID COLUMNHDR:visited, .PSLEVEL1GRID COLUMNHDRDISABLED, .PSLEVEL1SSGRID COLUMNHDR:link,	PSROUNDEDCORNER_CSS3	Modify the styles for the classes given here, modify the same style class for different level of grids like level2, level3 etc.
Grids	Font styles for table header row in grid box.		.PSLEVEL1GRID COLUMNHDR:link, .PSLEVEL1GRID COLUMNHDR:visited, .PSLEVEL1GRID COLUMNHDRDISABLED, .PSLEVEL1SSGRID COLUMNHDR:link, .PSLEVEL1SSGRID COLUMNHDR:visited	PSROUNDEDCORNER_CSS3	Modify the styles for the classes given here, modify the same style class for different level of grids like level2, level3 etc.
Grids	Border styles for table header row in grid box.	PSLEVEL1GRID COLUMNHDR, PSLEVEL2GRID COLUMNHDR, PSLEVEL3GRID COLUMNHDR		PTSTYLEDEF_TANGERINE	Modify the border styles for the fixed form classes mentioned here.



<b>Section</b>	<b>Element</b>	<b>Fixed Form Styles</b>	<b>Free Form Styles</b>	<b>Style Sheet</b>	<b>Description</b>
Grids	Odd and even row styles for table inside the grid box.	PSLEVEL1GRID ODDROW, PSLEVEL1GRID EVENROW, PSLEVEL2GRID ODDROW, PSLEVEL2GRID EVENROW, PSLEVEL3GRID ODDROW, PSLEVEL3GRID EVENROW,		PTSTYLEDEF_ TANGERINE	Modify the styles for the fixed form classes mentioned here.
Group box	Width of group box with border and group box without border	PSGROUPBOXNBO and PSGROUPBOXWBO		PSALTERNATE_ TANGERINE	Modify the style attributes for fixed form style classes PSGROUPBOXNBO and PSGROUPBOXWBO
Group box	Group box styles - header border styles , font styles, height and padding styles for group box without border	PAGROUPDIVIDER		PSALTERNATE_ TANGERINE	Modify the style attributes for fixed form style class PAGROUPDIVIDER
Group box	Group box styles - border styles for a table inside group box	PSGROUPBOXWBO and PSGROUPBOXLABEL.		Modify the styles in fixed form PTSTYLEDEF_ TANGERINE	This can be achieved by customizing the styles of fixed form class PSGROUPBOXWBO and PSGROUPBOXLABEL in PTSTYLEDEF_TANGERINE as shown
Group box	Group box styles - styles of the text content section inside group box. ( Main Menu, My Feeds Page - Text content inside Additional instructions group box )	PAADDITIONAL INSTRUCTACTIVE, .PAADDITIONAL INSTRUCTIONS:link, .PAADDITIONAL INSTRUCTIONS:active		Modify the styles in fixed form PSALTERNATE_ TANGERINE	This can be achieved by customizing the styles of fixed form class PAADDITIONAL INSTRUCTACTIVE
Group box	Group box styles - label styles in group box	PSGROUPBOX LABEL.		PTSTYLEDEF_ TANGERINE	Modify the style attributes for fixed form style class PSGROUPBOX LABEL.

<b>Section</b>	<b>Element</b>	<b>Fixed Form Styles</b>	<b>Free Form Styles</b>	<b>Style Sheet</b>	<b>Description</b>
Home Page Tabs	Home Page Tabs - styles of tabs in home page such as My Page, Guest, Investor , Administration tabs.		.pthomepagetabactive, .pthomepagetabinactive	PSROUNDED CORNER_CSS3	The styles customized by modifying the styles of classes pthomepagetabactive and pthomepagetabinactive in free form style sheet PSROUNDED CORNER_CSS3
Navigation Collection Section	Styles of Navigation collection table section , for example in Application diagnostics page. Navigation Path - Main Menu - > Application Diagnostics page	EOPP_SCPAGEBORDER, EOPP_SCSECTIONFOLDER		PTSTYLEDEF_TANGERINE	This can be achieved by customizing the styles of fixed form class EOPP_SCPAGEBORDER and EOPP_SCSECTIONFOLDER in PTSTYLEDEF_TANGERINE as shown
Drop Down Menu	Styles of drop down menu list box	PSDROPDOWNLIST, PSDROPDOWNLABEL		PTSTYLEDEF_TANGERINE	Modify the styles in fixed form PTSTYLEDEF_TANGERINE for class PSDROPDOWNLIST and PSDROPDOWNLABEL
Text Box	Styles of text box	PSEDITBOX	PSROUNDEDCORNER_CSS3	PTSTYLEDEF_TANGERINE	Modify the styles in fixed form PTSTYLEDEF_TANGERINE for class PSEDITBOX and check if free form styles are also present in PSROUNDEDCORNER_CSS3
Long Edit Text box	Styles of long edit text box and long edit label	PSLONGEDITBOX, PSLONGEDITLABEL		PTSTYLEDEF_TANGERINE	Modify the styles of fixed form classes given here.
Radio Button	Styles of radio button .	PSRADIOBUTTON		PTSTYLEDEF_TANGERINE	Modify the styles in fixed form PTSTYLEDEF_TANGERINE for class PSRADIOBUTTON

<b>Section</b>	<b>Element</b>	<b>Fixed Form Styles</b>	<b>Free Form Styles</b>	<b>Style Sheet</b>	<b>Description</b>
Check Box	Styles of check box.	PSCHECKBOX		PTSTYLEDEF_TANGERINE	Modify the styles in fixed form PTSTYLEDEF_TANGERINE for class PSHECKBOX
Home Page, Menu Pagelet Section	Styles of search text box and it related styles		#ptnav2srchinput, #pthnavsrchinput, #ptnav2goImg, #ptnav2go, #ptnavgo	PSHNAV_CSS3	Modify the styles of id's given here in PSHNAV_CSS3
Home Page, Menu Pagelet Section	Styles of settings drop down menu in pagelet header section		.ptalPglcontrols dropdown, .ptalPglcontrols dropdownclickedTopBorder, .ptalPglcontrols dropdownclickedBottomBorder	PTAL_SUBSTYLE_REQ_TANGERINE	Modify the styles of the class given here.
Home Page, BI Publisher Pagelet Section	Styles of navigation section folder styles inside the pagelet.	.EOPP_SC SECTIONFOLDER, .EOPP_SC SECTIONCONTENTLINK, .EOPP_SC SECTIONFOLDERLINK, .EOPP_SC CHILDCONTENTLINK, .EOPP_SC CHILDFOLDERLINK, .EOPP_SC MORELINK		PTSTYLEDEF_TANGERINE	Modify the styles of the fixed form classes given here.
Pagelets Loading/ Processing Icon	Loading icon in the pagelets throughout the application		.ptalPageletLoading	PTAL_SUBSTYLE_REQ_TANGERINE	Modify the styles of ptalPageletLoading class, update the background attribute here with the new loading image.
Modal Popup - Personalize Content Modal Popup outline styles	Outline styles of modal pop which opens up on click of Personalize content link in home page		.PSMODALTABLE	PSPOPUP_CSS3	Modify the border styles, box shadow effect styles, padding styles of the class PSMODALTABLE to alter the styles of the pop up
Modal Popup - Personalize Content Modal Popup header section styles	Header part styles of modal pop which opens up on click of Personalize content link in home page		.PSMODALHEADER, .PTPOPUP_HEADER	PSPOPUP_CSS3	Modify the background color styles, height attribute and border styles of the class mentioned here.

<b>Section</b>	<b>Element</b>	<b>Fixed Form Styles</b>	<b>Free Form Styles</b>	<b>Style Sheet</b>	<b>Description</b>
Modal Popup - Personalize Content Modal Popup header section styles	Title styles in modal pop up header		.PSMODALTITLE, .PTPOPUP_TITLE	PSPOPUP_CSS, PSPOPUP_CSS3	Modify the styles of PSMODALTITLE and PTPOPUP_TITLE class in the styles sheets mentioned here.
Modal Popup - Personalize Content Modal Popup content section styles	Styles of modal pop up content section		.PSMODALCONTENT	PSPOPUP_CSS, PSPOPUP_CSS3	Modify the styles of .PSMODALCONTENT class in the styles sheets mentioned here. The inner content has classes PSPAGECONTAINER and table PSLEVEL2GRIDNBO, related style attributes can be modified in fixed form PTSTYLEDEF_TANGERINE
Modal Popup - With alert message and OK button	Styles of modal pop up alert message and ok button		#alertmsg, #okbutton	PSPOPUP_CSS3	Modify the styles of id alertmsg and ok button
Page Title section	Styles of the title in a page . ( Main Menu, My Feeds Page- "Search and View published feeds" title section ) ( Main Menu, System Profile Page - "General Profile Information" title section)	.PAPAGETITLE, .PAPAGEINSTRUCTIONS		PSALTERNATE_TANGERINE	Modify the font, border and color styles of the title section by changing the attributes of PAPAGETITLE and PAPAGEINSTRUCTIONS class
Navigation Collection Pages	Styles of Navigation collection table border. ( Main Menu, Tree Manager page)	EOPP_SCPAGEBORDER		PTSTYLEDEF_TANGERINE	Modify the border and other styles for fixed form class EOPP_SCPAGEBORDER class in PTSTYLEDEF_TANGERINE stylesheet.

<b>Section</b>	<b>Element</b>	<b>Fixed Form Styles</b>	<b>Free Form Styles</b>	<b>Style Sheet</b>	<b>Description</b>
Navigation Collection Pages	Styles of Navigation collection table, bread crumb section	EOPP_ SCBREADCRUMBSECTION		PTSTYLEDEF_ TANGERINE	Modify the border and other styles for fixed form class EOPP_ SCBREADCRUMBSECTION class in PTSTYLEDEF_ _TANGERINE stylesheet.
Navigation Collection Pages	Styles related to title section in Navigation Collection table.	EOPP_ SCPAGETITLESECTION		PTSTYLEDEF_ TANGERINE	Modify the border and other styles for fixed form class EOPP_ SCPAGETITLESECTION class in PTSTYLEDEF_ _TANGERINE stylesheet.
Navigation Collection Pages	Styles of description section in Navigation collection table.	EOPP_ SCPAGEDESCRSECTION		PTSTYLEDEF_ TANGERINE	Modify the border and other styles for fixed form class EOPP_ SCPAGEDESCRSECTION class in PTSTYLEDEF_ _TANGERINE stylesheet.
Navigation Collection Pages	Styles of each navigation section , links and text content inside those section . ( Main Menu, Tree Manager Page - Tree View Manager section, Tree Structure section , Tree utilities etc)	EOPP_ SCSECTIONFOLDER, .EOPP_ SCSECTIONCONTENT, EOPP_ SCSECTIONFOLDERLINK, EOPP_ SCADDITIONALTEXT, EOPP_ SCCHILDCONTENTLINK, EOPP_ SCMORELINK, EOPP_ SCSECTIONLEFT		PTSTYLEDEF_ TANGERINE	Customize the styles of icons in navigation section, folder links styles, text styles, links and sub link styles, more links styles by changing the style attributes of fixed form class mentioned here.
Search Module and Search Table	Styles of labels in search page. ( Main Menu, People Tools, Security, User Profiles Page, Find an existing Value tab)	PSSRCHSUBTITLE, PSSRCHTITLE,		PTSTYLEDEF_ TANGERINE	Modify the styles of PSSRCHSUBTITLE and PSSRCHTITLE as mentioned here.



<b>Section</b>	<b>Element</b>	<b>Fixed Form Styles</b>	<b>Free Form Styles</b>	<b>Style Sheet</b>	<b>Description</b>
Scroll Area Table	Body section styles of scroll area table - Main menu , My Personalizations page	.PSLEVEL1SCROLLAREA .PSLEVEL2SCROLLAREA .PSLEVEL3SCROLLAREA	REABODY,	PSROUNDEDCORNER_CSS3, PTSTYLEDEF_TANGERINE	Customize the body section styles of scroll area table by modifying the styles of fixed form classes mentioned here. The styles is also applied through free form styles sheet PSROUNDEDCORNER_CSS3
Tree Structure in Navigator Page	Styles of Tree Structure Label - Main Menu, Worklist Navigator	.PTBREADCRUMB .PTBREADCRUMB	MARGIN,	PTSTYLEDEF_TANGERINE	The label section styles can be modified by changing the styles of fixed form classes mentioned here.
Tree Structure in Navigator Page	Styles of links in Tree Structure - Main Menu, Worklist Navigator	.PTMENULINK, PTMENULINKSELECTED		PTSTYLEDEF_TANGERINE	The styles of links in the tree structure can be customized by changing the styles of fixed form classes PTMENULINK and PTMENULINKSELECTED .
Navigation Collection Pages	Details about fixed form classes associated with Navigation Collection Pages ( Main Menu Work List page or Main Menu Tree Manager Page )	EOPP_SCCHILDINDENT		PTSTYLEDEF_TANGERINE	Navigation collection child folder indentation.
Navigation Collection Pages	Details about fixed form classes associated with Navigation Collection Pages ( Main Menu Work List page or Main Menu Tree Manager Page )	EOPP_SCPAGEBORDER		PTSTYLEDEF_TANGERINE	Navigation collection page border.
Navigation Collection Pages	Details about fixed form classes associated with Navigation Collection Pages ( Main Menu Work List page or Main Menu Tree Manager Page )	EOPP_SCSECTIONCONTENT	DARK	PTSTYLEDEF_TANGERINE	Navigation collection section content dark style.

<b>Section</b>	<b>Element</b>	<b>Fixed Form Styles</b>	<b>Free Form Styles</b>	<b>Style Sheet</b>	<b>Description</b>
Navigation Collection Pages	Details about fixed form classes associated with Navigation Collection Pages ( Main Menu Work List page or Main Menu Tree Manager Page )	EOPP_SCSECTIONFOLDER	DARK	PTSTYLEDEF_TANGERINE	Navigation collection section folder dark style.
Navigation Collection Pages	Details about fixed form classes associated with Navigation Collection Pages ( Main Menu Work List page or Main Menu Tree Manager Page )	EOPP_SCSECTIONCONTENT		PTSTYLEDEF_TANGERINE	Navigation collection section content.
Navigation Collection Pages	Details about fixed form classes associated with Navigation Collection Pages ( Main Menu Work List page or Main Menu Tree Manager Page )	EOPP_SCSECTIONFOLDER		PTSTYLEDEF_TANGERINE	Navigation collection section folder.
Navigation Collection Pages	Details about fixed form classes associated with Navigation Collection Pages ( Main Menu Work List page or Main Menu Tree Manager Page )	EOPP_SCPAGETITLESECTION		PTSTYLEDEF_TANGERINE	Navigation collection page title.
Navigation Collection Pages	Details about fixed form classes associated with Navigation Collection Pages ( Main Menu Work List page or Main Menu Tree Manager Page )	EOPP_SCBREADCRUMBSECTION		PTSTYLEDEF_TANGERINE	Navigation collection breadcrumbs.



<b>Section</b>	<b>Element</b>	<b>Fixed Form Styles</b>	<b>Free Form Styles</b>	<b>Style Sheet</b>	<b>Description</b>
Navigation Collection Pages	Details about fixed form classes associated with Navigation Collection Pages ( Main Menu Work List page or Main Menu Tree Manager Page )	EOPP_SCADDITIONALTEXT		PTSTYLEDEF_TANGERINE	Navigation collection additional text.
Navigation Collection Pages	Details about fixed form classes associated with Navigation Collection Pages ( Main Menu Work List page or Main Menu Tree Manager Page )	EOPP_SCPAGEDESCRSECTION		PTSTYLEDEF_TANGERINE	Navigation collection page description.
Navigation Collection Pages	Details about fixed form classes associated with Navigation Collection Pages ( Main Menu Work List page or Main Menu Tree Manager Page )	EOPP_SCCHILDCONTENTLINK		PTSTYLEDEF_TANGERINE	Navigation collection child content link.
Navigation Collection Pages	Details about fixed form classes associated with Navigation Collection Pages ( Main Menu Work List page or Main Menu Tree Manager Page )	EOPP_SCCHILDFOUNDERLINK		PTSTYLEDEF_TANGERINE	Navigation collection child folder link.
Navigation Collection Pages	Details about fixed form classes associated with Navigation Collection Pages ( Main Menu Work List page or Main Menu Tree Manager Page )	EOPP_SCCHILDINDENT		PTSTYLEDEF_TANGERINE	Navigation collection child folder indentation.

<b>Section</b>	<b>Element</b>	<b>Fixed Form Styles</b>	<b>Free Form Styles</b>	<b>Style Sheet</b>	<b>Description</b>
Navigation Collection Pages	Details about fixed form classes associated with Navigation Collection Pages ( Main Menu Work List page or Main Menu Tree Manager Page )	EOPP_SCMORELINK		PTSTYLEDEF_TANGERINE	Navigation collection more link.
Navigation Collection Pages	Details about fixed form classes associated with Navigation Collection Pages ( Main Menu Work List page or Main Menu Tree Manager Page )	EOPP_SCSECTIONCONTENTLINK		PTSTYLEDEF_TANGERINE	Navigation collection section content link.
Navigation Collection Pages	Details about fixed form classes associated with Navigation Collection Pages ( Main Menu Work List page or Main Menu Tree Manager Page )	EOPP_SCSECTIONFOLDERLINK		PTSTYLEDEF_TANGERINE	Navigation collection section folder link.
Label / Text Styles	Check box label.	PSCHECKBOX		PTSTYLEDEF_TANGERINE	
Label / Text Styles	Disabled field value font type, size, and color.	PSDISABLED		PTSTYLEDEF_TANGERINE	
Label / Text Styles	Drop-down list box label.	PSDROPDOWNLABEL		PTSTYLEDEF_TANGERINE	
Label / Text Styles	Drop-down list box text.	PSDROPDOWNLIST		PTSTYLEDEF_TANGERINE	
Label / Text Styles	Edit box label.	PSEDITBOX		PTSTYLEDEF_TANGERINE	
Label / Text Styles	Disabled edit box style (white background with a thin, gray border).	PSEDITBOX_DISABLED		PTSTYLEDEF_TANGERINE	
Label / Text Styles	Display-only edit boxes.	PSEDITBOX_DISPONLY		PTSTYLEDEF_TANGERINE	
Label / Text Styles	Edit box text.	PSEDITBOXLABEL		PTSTYLEDEF_TANGERINE	

<b>Section</b>	<b>Element</b>	<b>Fixed Form Styles</b>	<b>Free Form Styles</b>	<b>Style Sheet</b>	<b>Description</b>
Label / Text Styles	Error field background color and text.	PSERROR		PTSTYLEDEF_TANGERINE	
Label / Text Styles	Strong emphasis for text on a page.	PABOLDBLUETEXT		PSALTERNATE_TANGERINE	
Label / Text Styles	Field value emphasis.	PABOLDTEXT		PSALTERNATE_TANGERINE	
Label / Text Styles	Text for numeric days on calendars.	PACALENDARDAYNUM		PSALTERNATE_TANGERINE	
Label / Text Styles	Text for numeric days on calendars (disabled state).	PACALENDARDAYNUMDISABLED		PSALTERNATE_TANGERINE	
Label / Text Styles	Inline error message text font type, color, and size.	PAERRORETEXT		PSALTERNATE_TANGERINE	
Label / Text Styles	Smaller font size to demonstrate an example.	PAEXAMPLE		PSALTERNATE_TANGERINE	
Label / Text Styles	Emphasized label text size and weight.	STRONG		PTSTYLEDEF_TANGERINE	
Label / Text Styles	Emphasized text size and weight that will break to the next line in long sentences.	STRONGWRAP		PTSTYLEDEF_TANGERINE	
Label / Text Styles	Descriptive text in the PeopleSoft Pure Internet Architecture navigation.	MUTE		PTSTYLEDEF_TANGERINE	
Label / Text Styles	Additional instructions on the page (slightly smaller font).	PAADDITIONALINSTRUCTIONS		PSALTERNATE_TANGERINE	
Label / Text Styles	Chart axis labels.	PSCHARTAXISTITLE		PTSTYLEDEF_TANGERINE	
Label / Text Styles	Default chart text.	PSCHARTDEFAULT		PTSTYLEDEF_TANGERINE	
Label / Text Styles	Chart title text.	PSCHARTTITLE		PTSTYLEDEF_TANGERINE	

<b>Section</b>	<b>Element</b>	<b>Fixed Form Styles</b>	<b>Free Form Styles</b>	<b>Style Sheet</b>	<b>Description</b>
Hyperlinks		PSHYPERLINK		PTSTYLEDEF_TANGERINE	
Hyperlinks	Disabled link.	PSHYPERLINKDISABLED		PTSTYLEDEF_TANGERINE	
Hyperlinks	Link when the mouse hovers over it.	PSHYPERLINKHOVER		PTSTYLEDEF_TANGERINE	
Hyperlinks	Link with no underline.	PSHYPERLINKNOUL		PTSTYLEDEF_TANGERINE	
Hyperlinks	Previously visited link.	PSHYPERLINKVISITED		PTSTYLEDEF_TANGERINE	
Hyperlinks	Link with a yellow background.	PSHYPERLINKYELLOWBKGRD		PTSTYLEDEF_TANGERINE	
Hyperlinks	Link in a scroll area or grid header.	PSHEADERHYPERLINK		PTSTYLEDEF_TANGERINE	
Hyperlinks	Disabled link in a scroll area or grid header.	PSHEADERHYPERLINKD		PTSTYLEDEF_TANGERINE	
Hyperlinks	Links conveying an error status (use with image).	PAHYPERLINKERRSTAT		PSALTERNATE_TANGERINE	
Hyperlinks	Link style for grid odd rows that use the PeopleCode style property.	PAHYPERLINKLV1ODD		PSALTERNATE_TANGERINE	
Hyperlinks	Links conveying a successful status (use with image).	PAHYPERLINKSUCCESSSTAT		PSALTERNATE_TANGERINE	
Hyperlinks	Links conveying a warning status (use with image).	PAHYPERLINKWARNSTAT		PSALTERNATE_TANGERINE	
Group Boxes	Group boxes.	PAGROUPBOX		PSALTERNATE_TANGERINE	
Group Boxes	Invisible group box label.	PAGROUPBOXLABELINVISIBLE		PSALTERNATE_TANGERINE	
Group Boxes	Group box labels at level 1.	PAGROUPBOXLABELLEVEL1		PSALTERNATE_TANGERINE	
Group Boxes	Group box labels at level 2.	PAGROUPBOXLABELLEVEL2		PSALTERNATE_TANGERINE	

<b>Section</b>	<b>Element</b>	<b>Fixed Form Styles</b>	<b>Free Form Styles</b>	<b>Style Sheet</b>	<b>Description</b>
Group Boxes	Group box labels at level 3.	PAGROUPBOXLABEL	LEVEL3	PSALTERNATE_TANGERINE	
Group Boxes	Group box body at level 1.	PAGROUPBOXLEVEL1		PSALTERNATE_TANGERINE	
Group Boxes	Group box body at level 2.	PAGROUPBOXLEVEL2		PSALTERNATE_TANGERINE	
Group Boxes	Group box body at level 3.	PAGROUPBOXLEVEL3		PSALTERNATE_TANGERINE	
Group Boxes	Group box label style on self-service pages.	PAGROUPDIVIDER		PSALTERNATE_TANGERINE	
Group Boxes	Group box body style on developer-defined advanced search pages.	PAGROUPDIVIDERBODY		PSALTERNATE_TANGERINE	
Group Boxes	Group box borders and body style.	PSGROUPBOX		PTSTYLEDEF_TANGERINE	
Group Boxes	Group box labels.	PSGROUPBOXLABEL		PTSTYLEDEF_TANGERINE	
Tabs	Active Sub tab style.	PASUBTABLINKACTIVE		PSALTERNATE_TANGERINE	
Tabs	Inactive Sub tab style.	PASUBTABLINKINACTIVE		PSALTERNATE_TANGERINE	
Tabs	Active tab labels and background colors.	PSACTIVETAB		PTSTYLEDEF_TANGERINE	
Tabs	Tab bottom line style to specify height and width. Height can be set to 0 if tab bottom line is not required.	PSBOTTOMLINE		PTSTYLEDEF_TANGERINE	
Tabs	Inactive tab labels and background colors.	PSINACTIVETAB		PTSTYLEDEF_TANGERINE	
Tabs	Inactive tab labels and background colors when the mouse hovers over them.	PSINACTIVETABHOVER		PTSTYLEDEF_TANGERINE	

<b>Section</b>	<b>Element</b>	<b>Fixed Form Styles</b>	<b>Free Form Styles</b>	<b>Style Sheet</b>	<b>Description</b>
Long Edit Boxes	Long edit box data.	PSLONGEDITBOX		PTSTYLEDEF_TANGERINE	
Long Edit Boxes	Long edit box labels.	PSLONGEDITLABEL		PTSTYLEDEF_TANGERINE	
Push Buttons	Push button labels and background.	PSPUSHBUTTON		PTSTYLEDEF_TANGERINE	
Push Buttons	Disabled push button labels and background color.	PSPUSHBUTTONDISABLED		PTSTYLEDEF_TANGERINE	
Pagelets	Homepage pagelet border thickness and color.	PTPAGELET		PTSTYLEDEF_TANGERINE	
Pagelets	Homepage pagelet font type and size, border thickness, border color, and padding.	PTPAGELETBODY		PTSTYLEDEF_TANGERINE	
Pagelets	Homepage pagelet header font type, size, and color; background color; border thickness; border color; and padding.	PTPAGELETHEADER		PTSTYLEDEF_TANGERINE	
Content References	Selected content reference background color (in navigation).	PTNAVSELCHILDBK		PTSTYLEDEF_TANGERINE	
Content References	Background dark color on the top edge of the selected content reference (in navigation).	PTNAVSELCHILDEDEDK		PTSTYLEDEF_TANGERINE	
Content References	Background color on the top edge of the selected content reference (in navigation).	PTNAVSELCHILDEDEGELT		PTSTYLEDEF_TANGERINE	
Content References	Selected content reference link font type and color (in navigation).	PTNAVSELCHILDLINK		PTSTYLEDEF_TANGERINE	
Folder Navigation Links	Selected folder background color (in navigation).	PTNAVSELFOLDERBK		PTSTYLEDEF_TANGERINE	

<b>Section</b>	<b>Element</b>	<b>Fixed Form Styles</b>	<b>Free Form Styles</b>	<b>Style Sheet</b>	<b>Description</b>
Folder Navigation Links	Selected parent link color (in navigation).	PTNAVSELPARENTLINK		PTSTYLEDEF_TANGERINE	
Folder Navigation Links	Selected parent folder background color (in navigation).	PTNAVSELPARENTBK		PTSTYLEDEF_TANGERINE	
Folder Navigation Links	Background color on the edge of the selected parent folder (in navigation).	PTNAVSELPARENTEEDGE		PTSTYLEDEF_TANGERINE	
Level 1 Scroll Areas	Level 1 scroll area body.	PSLEVEL1SCROLLARE	REABODY	PTSTYLEDEF_TANGERINE	
Level 1 Scroll Areas	Level 1 scroll area footer.	PSLEVEL1SCROLLARE	REAFooter	PTSTYLEDEF_TANGERINE	
Level 1 Scroll Areas	Level 1 scroll area header.	PSLEVEL1SCROLLARE	REAHeader	PTSTYLEDEF_TANGERINE	
Level 2 Scroll Areas	Level 2 scroll area body.	PSLEVEL2SCROLLARE	REABODY	PTSTYLEDEF_TANGERINE	
Level 2 Scroll Areas	Level 2 scroll area footer.	PSLEVEL2SCROLLARE	REAFooter	PTSTYLEDEF_TANGERINE	
Level 2 Scroll Areas	Level 2 scroll area header.	PSLEVEL2SCROLLARE	REAHeader	PTSTYLEDEF_TANGERINE	
Level 3 Scroll Areas	Level 3 scroll area body.	PSLEVEL3SCROLLARE	REABODY	PTSTYLEDEF_TANGERINE	
Level 3 Scroll Areas	Level 3 scroll area footer.	PSLEVEL3SCROLLARE	REAFooter	PTSTYLEDEF_TANGERINE	
Level 3 Scroll Areas	Level 3 scroll area header.	PSLEVEL3SCROLLARE	REAHeader	PTSTYLEDEF_TANGERINE	
Grids	Grid column headers for self-service grids without navigation controls.	PAGRIDHEADER		PSALTERNATE_TANGERINE	
Grids	Grid column header texts.	PSGRIDCOLUMNHDR		PTSTYLEDEF_TANGERINE	

<b>Section</b>	<b>Element</b>	<b>Fixed Form Styles</b>	<b>Free Form Styles</b>	<b>Style Sheet</b>	<b>Description</b>
Grids	Color for the row counter text displayed in the grid header.	PSGRIDCOUNTER		PTSTYLEDEF_TANGERINE	
Grids	Sorted even row style in a grid.	PSGRIDEVENROWSORTED		PTSTYLEDEF_TANGERINE	
Grids	Sorted odd row style in a grid.	PSGRIDODDROWSORTED		PTSTYLEDEF_TANGERINE	
Grids	Grid row style on mouse over.	PTGRIDROWMOUSEOVER		PTSTYLEDEF_TANGERINE	
Grids	Grid row style for a selected row.	PTGRIDROWSELECT		PTSTYLEDEF_TANGERINE	
Grids	Grid row style on mouse over.	PTGRIDROWMOUSEOVER		PTSTYLEDEF_TANGERINE	
Grids	Grid row style for a selected row.	PTGRIDROWSELECT		PTSTYLEDEF_TANGERINE	
Level 1 Grids	Level 1 grid background colors, border settings, and fonts.	PSLEVEL1GRID		PTSTYLEDEF_TANGERINE	
Level 1 Grids	Active tab labels and background colors on level 1 grids.	PSLEVEL1GRIDACTIVETAB		PTSTYLEDEF_TANGERINE	
Level 1 Grids	Grid column labels on level 1 grids.	PSLEVEL1GRIDCOLUMNHDR		PTSTYLEDEF_TANGERINE	
Level 1 Grids	Level 1 grid column header text style	PSLEVEL1GRIDCOLUMNHDRTXT		PTSTYLEDEF_TANGERINE	
Level 1 Grids	Even rows on level 1 grids.	PSLEVEL1GRIDEVENROW		PTSTYLEDEF_TANGERINE	
Level 1 Grids	Inactive tab labels and backgrounds on level 1 grids.	PSLEVEL1GRIDINACTIVETAB		PTSTYLEDEF_TANGERINE	
Level 1 Grids	Inactive tab labels and backgrounds (when mouse hovers over them) on level 1 grids.	PSLEVEL1GRIDINACTIVETABHOVER		PTSTYLEDEF_TANGERINE	
Level 1 Grids	Level 1 grid labels.	PSLEVEL1GRIDLABEL		PTSTYLEDEF_TANGERINE	



<b>Section</b>	<b>Element</b>	<b>Fixed Form Styles</b>	<b>Free Form Styles</b>	<b>Style Sheet</b>	<b>Description</b>
Level 1 Grids	Navigation bars on level 1 grids.	PSLEVEL1GRIDNAVIGATIONBAR		PTSTYLEDEF_TANGERINE	
Level 1 Grids	Odd rows on level 1 grids.	PSLEVEL1GRIDODDROW		PTSTYLEDEF_TANGERINE	
Level 1 Grids	Level 1 grid background settings, border settings, and fonts.	PSLEVEL1GRIDROW		PTSTYLEDEF_TANGERINE	
Level 2 Grids	Level 2 grid background colors, border settings, and fonts.	PSLEVEL2GRID		PTSTYLEDEF_TANGERINE	
Level 2 Grids	Active tab labels and background colors on level 2 grids.	PSLEVEL2GRIDACTIVETAB		PTSTYLEDEF_TANGERINE	
Level 2 Grids	Grid column labels on level 2 grids.	PSLEVEL2GRIDCOLUMNHDR		PTSTYLEDEF_TANGERINE	
Level 2 Grids	Level 2 grid column header text style.	PSLEVEL2GRIDCOLUMNHDRTXT		PTSTYLEDEF_TANGERINE	
Level 2 Grids	Even rows on level 2 grids.	PSLEVEL2GRIDEVENROW		PTSTYLEDEF_TANGERINE	
Level 2 Grids	Inactive tab labels and backgrounds on level 2 grids.	PSLEVEL2GRIDINACTIVETAB		PTSTYLEDEF_TANGERINE	
Level 2 Grids	Inactive tab labels and backgrounds (when mouse hovers over it) on level 2 grids.	PSLEVEL2GRIDINACTIVETABHOVER		PTSTYLEDEF_TANGERINE	
Level 2 Grids	Labels on level 2 grids.	PSLEVEL2GRIDLABEL		PTSTYLEDEF_TANGERINE	
Level 2 Grids	Navigation bars on level 2 grids.	PSLEVEL2GRIDNAVIGATIONBAR		PTSTYLEDEF_TANGERINE	
Level 2 Grids	Odd rows on level 2 grids.	PSLEVEL2GRIDODDROW		PTSTYLEDEF_TANGERINE	
Level 2 Grids	Level 2 grid background settings, border settings, and fonts.	PSLEVEL2GRIDROW		PTSTYLEDEF_TANGERINE	

<b>Section</b>	<b>Element</b>	<b>Fixed Form Styles</b>	<b>Free Form Styles</b>	<b>Style Sheet</b>	<b>Description</b>
Level 3 Grids	Level 3 grid background settings, border settings, and fonts.	PSLEVEL3GRID		PTSTYLEDEF_TANGERINE	
Level 3 Grids	Active tab labels and background colors on level 3 grids.	PSLEVEL3GRIDACTIVETAB		PTSTYLEDEF_TANGERINE	
Level 3 Grids	Grid column labels on level 3 grids.	PSLEVEL3GRIDCOLUMNHDR		PTSTYLEDEF_TANGERINE	
Level 3 Grids	Level 3 grid column header text style.	PSLEVEL3GRIDCOLUMNHDRTEXT		PTSTYLEDEF_TANGERINE	
Level 3 Grids	Even rows on level 3 grids.	PSLEVEL3GRIDEVENROW		PTSTYLEDEF_TANGERINE	
Level 3 Grids	Inactive tab labels and backgrounds on level 3 grids.	PSLEVEL3GRIDINACTIVETAB		PTSTYLEDEF_TANGERINE	
Level 3 Grids	Inactive tab labels and backgrounds (when the mouse hovers over them) on level 3 grids .	PSLEVEL3GRIDINACTIVETABHOVER		PTSTYLEDEF_TANGERINE	
Level 3 Grids	Labels on level 3 grids.	PSLEVEL3GRIDLABEL		PTSTYLEDEF_TANGERINE	
Level 3 Grids	Navigation bars on level 3 grids.	PSLEVEL3GRIDNAVIGATIONBAR		PTSTYLEDEF_TANGERINE	
Level 3 Grids	Odd rows on level 3 grids.	PSLEVEL3GRIDODDROW		PTSTYLEDEF_TANGERINE	
Level 3 Grids	Level 3 grid background settings, border settings, and fonts.	PSLEVEL3GRIDROW		PTSTYLEDEF_TANGERINE	
Frames	Level 1 frames.	PAFRAMELEVEL1		PSALTERNATE_TANGERINE	
Frames	Level 2 frames.	PAFRAMELEVEL2		PSALTERNATE_TANGERINE	
Frames	Level 3 frames.	PAFRAMELEVEL3		PSALTERNATE_TANGERINE	
Horizontal Rules	Horizontal rule at level 1.	PAHORIZONTALRULELEVEL1		PSALTERNATE_TANGERINE	

<b>Section</b>	<b>Element</b>	<b>Fixed Form Styles</b>	<b>Free Form Styles</b>	<b>Style Sheet</b>	<b>Description</b>
Horizontal Rules	Horizontal rule at level 2.	PAHORIZONTALRULE	ELEVEL2	PSALTERNATE_TANGERINE	
Horizontal Rules	Horizontal rule at level 3.	PAHORIZONTALRULE	ELEVEL3	PSALTERNATE_TANGERINE	
Breadcrumbs	Breadcrumbs.	PTBREADCRUMB		PTSTYLEDEF_TANGERINE	
Breadcrumbs	Current location on a breadcrumb trail.	PTBREADCRUMBCUR		PTSTYLEDEF_TANGERINE	
Breadcrumbs	Breadcrumb margins.	PTBREADCRUMB	MARGIN	PTSTYLEDEF_TANGERINE	
Frames	Background for the customer relationship management (CRM) toolbar.	PAHEADERTOOLBAR	BODY	PSALTERNATE_TANGERINE	
Frames	Borders for the CRM toolbar.	PAHEADERTOOLBAR	FRAME	PSALTERNATE_TANGERINE	
Text	Description for links on application homepages.	PAHYPERLINKDESCR		PSALTERNATE_TANGERINE	
Group Boxes	Body color for legends on pages.	PALEGENDBACKGROUND		PSALTERNATE_TANGERINE	
Level 0	High-level key data on self-service pages.	PALEVEL0PRIMARY		PSALTERNATE_TANGERINE	
Level 0	Additional fields to identify the object.	PALEVEL0SECONDARY		PSALTERNATE_TANGERINE	
Page	Text instructions on the top of the page.	PAPAGEINSTRUCTIONS		PSALTERNATE_TANGERINE	
Page	Page title	PAPAGETITLE		PSALTERNATE_TANGERINE	
Search	Group boxes around search criteria.	PASEARCHBOXBODY		PSALTERNATE_TANGERINE	
Page	Step-by-step transaction.	PASTEPPBYSTEP	TITLE	PSALTERNATE_TANGERINE	

<b>Section</b>	<b>Element</b>	<b>Fixed Form Styles</b>	<b>Free Form Styles</b>	<b>Style Sheet</b>	<b>Description</b>
Page	Text background.	PATEXTBACKGROUND		PSALTERNATE_ TANGERINE	
Page	Transaction name above the current page title.	PATRANSACTIONTITLE		PSALTERNATE_ TANGERINE	
Page	Frame borders.	PSFRAME		PTSTYLEDEF_ TANGERINE	
Page	Meant for PeopleTools usage for buttons.	PSHEADERTOOLBARFRAME		PTSTYLEDEF_ TANGERINE	
Horizontal Rules	Horizontal rule.	PSHORIZONTALRULE		PTSTYLEDEF_ TANGERINE	
Images	Image border style, width, and colors.	PSIMAGE		PTSTYLEDEF_ TANGERINE	
Page	Links at the first level of the PeopleSoft Pure Internet Architecture navigation.	MID		PTSTYLEDEF_ TANGERINE	
Page	Portal administration left navigation*.	KNOCKOUT		PTSTYLEDEF_ TANGERINE	
Page	Body background of hidden group boxes and grids.	PABACKGROUNDINVISIBLE		PSALTERNATE_ TANGERINE	
Page	Footer borders for ChartField grids.	PACFGRIDFOOT		PSALTERNATE_ TANGERINE	
Page	Header label background for ChartField grids.	PACFGRIDLABEL		PSALTERNATE_ TANGERINE	
Page	Expandable and collapsible area borders.	PAEXPANDCOLLAPSE		PSALTERNATE_ TANGERINE	
Page	Information on PAFRAMEBACKGROUND fixed form class	PAFRAMEBACKGROUND		PSALTERNATE_ TANGERINE	
Page	Multilingual field background.	PSMULTILANG		PTSTYLEDEF_ TANGERINE	
Page	Left navigation link color.	PSNAVPARENTLINK		PTSTYLEDEF_ TANGERINE	

<b>Section</b>	<b>Element</b>	<b>Fixed Form Styles</b>	<b>Free Form Styles</b>	<b>Style Sheet</b>	<b>Description</b>
Page	Page background color and margins.	PSPAGE		PTSTYLEDEF_TANGERINE	
Page	Background color for the page container.	PSPAGECONTAINER		PTSTYLEDEF_TANGERINE	
Page	Shaded background for page personalization image.	PSPAGECUST		PTSTYLEDEF_TANGERINE	
Page	Processing message background color.	PSPROCESSING		PTSTYLEDEF_TANGERINE	
Page	Footer text font type, size, weight, and color.	PSPSMALLTEXT		PTSTYLEDEF_TANGERINE	
Page	Style for Portal tab label.	PSPTABLABLE		PTSTYLEDEF_TANGERINE	
Radio Buttons	Radio buttons.	PSRADIOBUTTON		PTSTYLEDEF_TANGERINE	
Page	Style specification for Show following Tabs and Show previous Tabs button.	PSRIGHTLEFTSCROLL		PTSTYLEDEF_TANGERINE	
Search	Font style for Search action.	PSSRCHACTION		PTSTYLEDEF_TANGERINE	
Search	Search check box.	PSSRCHCHECKBOX		PTSTYLEDEF_TANGERINE	
Search	Search drop-down labels.	PSSRCHDROPDOWNLABEL		PTSTYLEDEF_TANGERINE	
Search	Search edit box labels.	PSSRCHEDITBOXLABEL		PTSTYLEDEF_TANGERINE	
Search	Search instructions.	PSSRCHINSTRUCTIONS		PTSTYLEDEF_TANGERINE	
Search	Search page font type, background color, and margins.	PSSRCHPAGE		PTSTYLEDEF_TANGERINE	

<b>Section</b>	<b>Element</b>	<b>Fixed Form Styles</b>	<b>Free Form Styles</b>	<b>Style Sheet</b>	<b>Description</b>
Search	Even rows on search page result grids.	PSSRCHRESULTSEVENROW		PTSTYLEDEF_TANGERINE	
Search	Footer on search page result grids.	PSSRCHRESULTSFOOTER		PTSTYLEDEF_TANGERINE	
Search	Header on search page result grids.	PSSRCHRESULTSHDR		PTSTYLEDEF_TANGERINE	
Search	Header text style for search results.	PSSRCHRESULTSHDRTXT		PTSTYLEDEF_TANGERINE	
Search	Navigation links above the search results.	PSSRCHRESULTSHYPERLINK		PTSTYLEDEF_TANGERINE	
Search	Disabled navigation links above the search results.	PSSRCHRESULTSHYPERLINKD		PTSTYLEDEF_TANGERINE	
Search	Odd rows on search page result grids.	PSSRCHRESULTSODDROW		PTSTYLEDEF_TANGERINE	
Search	Instructional text on search results page.	PSSRCHRESULTSTITLE		PTSTYLEDEF_TANGERINE	
Search	Search results section title.	PSSRCHSUBTITLE		PTSTYLEDEF_TANGERINE	
Search	Search tips.	PSSRCHTIPS		PTSTYLEDEF_TANGERINE	
Search	First-level title on a search page.	PSSRCHTITLE		PTSTYLEDEF_TANGERINE	
Images	Static image border styles, width, and colors.	PSSTATICIMAGE		PTSTYLEDEF_TANGERINE	
Text	Static text controls.	PSTEXT		PTSTYLEDEF_TANGERINE	
Menus	No longer used.	PSTLEFTMENU		PTSTYLEDEF_TANGERINE	
Trees	Selected tree node.	PSTREENODESELECTED		PTSTYLEDEF_TANGERINE	
MultiChannel Framework	Any additional instructions/error messages with small font.	PT_MCFADDITIONALINSTRUCTIONS		PTSTYLEDEF_TANGERINE	

<b>Section</b>	<b>Element</b>	<b>Fixed Form Styles</b>	<b>Free Form Styles</b>	<b>Style Sheet</b>	<b>Description</b>
MultiChannel Framework	Self chat message class.	PT_MCFCHATME		PTSTYLEDEF_TANGERINE	
MultiChannel Framework	System chat message.	PT_MCFCHATSYSMSG		PTSTYLEDEF_TANGERINE	
MultiChannel Framework	Chat message from others.	PT_MCFCHATTHEM		PTSTYLEDEF_TANGERINE	
MultiChannel Framework	Chat message from another Agent.	PT_MCFCHATUS		PTSTYLEDEF_TANGERINE	
MultiChannel Framework	MCF check box.	PT_MCFCHECKBOX		PTSTYLEDEF_TANGERINE	
MultiChannel Framework	MCF check box label.	PT_MCFCHECKBOXLABEL		PTSTYLEDEF_TANGERINE	
MultiChannel Framework	MCF drop-down list box.	PT_MCFDROPDOWNLIST		PTSTYLEDEF_TANGERINE	
MultiChannel Framework	MCF edit box.	PT_MCFEDITBOX		PTSTYLEDEF_TANGERINE	
MultiChannel Framework	REN event name in tracer log.	PT_MCFEVTNAME		PTSTYLEDEF_TANGERINE	
MultiChannel Framework	REN event value in tracer log.	PT_MCFEVTVALUE		PTSTYLEDEF_TANGERINE	
MultiChannel Framework	Non-editable gray text.	PT_MCFGRAYTEXT		PTSTYLEDEF_TANGERINE	
MultiChannel Framework	MCF group box style.	PT_MCFGROUPBOX		PTSTYLEDEF_TANGERINE	
MultiChannel Framework	MCF header style.	PT_MCFHEADER		PTSTYLEDEF_TANGERINE	
MultiChannel Framework	MCF label style.	PT_MCFLABEL		PTSTYLEDEF_TANGERINE	
MultiChannel Framework	MCF page title style.	PT_MCFPAGETITLE		PTSTYLEDEF_TANGERINE	
MultiChannel Framework	MCF push button style.	PT_MCFPUSHBUTTON		PTSTYLEDEF_TANGERINE	
MultiChannel Framework	Row style in an MCF table.	PT_MCFROW		PTSTYLEDEF_TANGERINE	
MultiChannel Framework	Table style for MCF monitoring supervisor.	PT_MCFSPVSRTABLE		PTSTYLEDEF_TANGERINE	

<b>Section</b>	<b>Element</b>	<b>Fixed Form Styles</b>	<b>Free Form Styles</b>	<b>Style Sheet</b>	<b>Description</b>
MultiChannel Framework	Table style.	PT_MCFTABLE		PTSTYLEDEF_TANGERINE	
MultiChannel Framework	Transparent table header style.	PT_MCFTABLEHEADER		PTSTYLEDEF_TANGERINE	
MultiChannel Framework	Table header style.	PT_MCFTABLEHEADER		PTSTYLEDEF_TANGERINE	
MultiChannel Framework	REN event in tracer window style	PT_MCFTRACEREVENT		PTSTYLEDEF_TANGERINE	
MultiChannel Framework	REN request in tracer window style.	PT_MCFTRACERREQ		PTSTYLEDEF_TANGERINE	
Context Manager	Context manager “Administer Pagelets” bar style.	PTCXADMINBAR		PTSTYLEDEF_TANGERINE	
Context Manager	Context Manager “Administer Pagelets” link style.	PTCXADMINLINK		PTSTYLEDEF_TANGERINE	
Context Manager	Context Manager template pagelet body background.	PTCXMPAGELETBODYBAK		PTSTYLEDEF_TANGERINE	
Context Manager	Context Manager template pagelet header background	PTCXMPAGELETHEADERBAK		PTSTYLEDEF_TANGERINE	
Context Manager	Context Manager template pagelet header link.	PTCXMPGLTHDRLINK		PTSTYLEDEF_TANGERINE	
Context Manager	Context Manager template pagelet header link hover.	PTCXMPGLTHDRLINKHOVER		PTSTYLEDEF_TANGERINE	
Menus	Link on level 2 of the PeopleSoft Pure Internet Architecture navigation.	PTMENULINK		PTSTYLEDEF_TANGERINE	
Menus	Background style in navigation menu.	PTNAVBACKGROUND		PTSTYLEDEF_TANGERINE	
Menus	Content reference link style.	PTNAVLINK		PTSTYLEDEF_TANGERINE	



<b>Section</b>	<b>Element</b>	<b>Fixed Form Styles</b>	<b>Free Form Styles</b>	<b>Style Sheet</b>	<b>Description</b>
Menus	Content reference link style when the mouse hovers over it.	PTNAVLINKHOVER		PTSTYLEDEF_TANGERINE	
Menus	Search divider element style (in navigation).	PTNAVSEARCHDIVIDER		PTSTYLEDEF_TANGERINE	
Menus	Search label style (in navigation).	PTNAVSEARCHLABEL		PTSTYLEDEF_TANGERINE	
Pop-up Pages	Header style for pop up page element.	PTPOPUP_HEADER		PTSTYLEDEF_TANGERINE	
Pop-up Pages	Title style that appears in the header of the pop-up page element.	PTPOPUP_TITLE		PTSTYLEDEF_TANGERINE	
Page	Query style definition.	PTQUERYSTYLESUB		PTSTYLEDEF_TANGERINE	
Page	Portal layout page selection box body.	PTSELECTBODY		PTSTYLEDEF_TANGERINE	
Page	Portal layout page selection box header.	PTSELECTHEADER		PTSTYLEDEF_TANGERINE	
Page	Text style in Search results header.	PTSRCHRESULTSHDRTXT		PTSTYLEDEF_TANGERINE	
Page	Invalid word for the spell check (highlighted in black with white text).	PTSPELLCHECKERROR		PTSTYLEDEF_TANGERINE	
Page	Displays text labels as transparent so that they are not visible in standard layout mode but are embedded in the HTML so that they can be read by a screen reader.	PTTRANSPARENT		PTSTYLEDEF_TANGERINE	

<b>Section</b>	<b>Element</b>	<b>Fixed Form Styles</b>	<b>Free Form Styles</b>	<b>Style Sheet</b>	<b>Description</b>
Page	Default PeopleSoft Pure Internet Architecture navigation.	RESET		PTSTYLEDEF_TANGERINE	
Page	Link on the portal homepage personalization page and portal structure breadcrumbs.	SMALL		PTSTYLEDEF_TANGERINE	
Pivot Grid - Grid	'Download to Excel Icon' in grid		PSPGDOWNTOEXCEL	PT_ACE_SS1_CSS3	Modify the background URL property for this class to point to a different image.
Pivot Grid - Grid	'Help Icon' in the grid		PSPGHELPFORDD	PT_ACE_SS1_CSS3	Modify the background URL property for this class to point to a different image.
Pivot Grid - Grid	'Show Filter Icon' in the grid		PSPGSHOWFILTER	PT_ACE_SS1_CSS3	Modify the background URL property for this class to point to a different image.
Pivot Grid - Grid	'Hide Filter Icon' in the grid		PSPGHIDEFILTER	PT_ACE_SS1_CSS3	Modify the background URL property for this class to point to a different image.
Pivot Grid - Grid	'Show Scrolling Icon' in the grid		PSPGSHOWSCROLL	PT_ACE_SS1_CSS3	Modify the background URL property for this class to point to a different image.
Pivot Grid - Grid	'Show All Columns Icon' in the grid		PSPGNOSCROLL	PT_ACE_SS1_CSS3	Modify the background URL property for this class to point to a different image.
Pivot Grid - Grid	'Drop down icon' in the grid		PSPGFILTERDDIMG	PT_ACE_SS1_CSS3	Modify the background URL property for this class to point to a different image.

<b>Section</b>	<b>Element</b>	<b>Fixed Form Styles</b>	<b>Free Form Styles</b>	<b>Style Sheet</b>	<b>Description</b>
Pivot Grid - Grid	'Expand dimension total icon' in the grid		PSPGCOLLAPSE	PT_ACE_SS1_CSS3	Modify the background URL property for this class to point to a different image.
Pivot Grid - Grid	'Collapse dimension total icon' in the grid		PSPGEXPAND	PT_ACE_SS1_CSS3	Modify the background URL property for this class to point to a different image.
Pivot Grid - Grid	Background color for filter region	PSACESLICE		PSACE_CSS3	Modify the background color property for this class.
Pivot Grid - Grid	Border size and Border color of the filter value region which contains the drop down icon	PSACECOMBO		PSACE_CSS3	Modify the border width and border color property for this class.
Pivot Grid - Grid	Background color and font style and color for grid column header		PT_PGCOLUMNHEADER	PT_ACE_SS1_CSS3	Modify the background color and font properties for this class.
Pivot Grid - Grid	Background color and font style and color for grid row header		PT_PGROWHEADER		Modify the background color and font properties for this class.
Pivot Grid - Grid	Background color and font style and color for grid empty column header		PT_PGEMPTYCOLUMNHEADER	PT_ACE_SS1_CSS3	Modify the background color and font properties for this class.
Pivot Grid - Grid	Background color and font style and color for grid row header		PT_PGEMPTYROWHEADER	PT_ACE_SS1_CSS3	Modify the background color and font properties for this class.
Pivot Grid - Grid	Background color and font style and color for label row header i.e. cell 1 in the grid		PT_PGLABELROWHEADER	PT_ACE_SS1_CSS3	Modify the background color and font properties for this class.
Pivot Grid - Grid	Font styles and background for a filter name	PSPGFILTERNAME		PSACE_CSS3	Modify the background color and font properties for this class.

<b>Section</b>	<b>Element</b>	<b>Fixed Form Styles</b>	<b>Free Form Styles</b>	<b>Style Sheet</b>	<b>Description</b>
Pivot Grid - Grid	Font styles and background for a filter value shown before the filter drop down image	PSPGFILTERVALUE		PSACE_CSS3	Modify the background color and font properties for this class.
Pivot Grid - Grid & Pivot Grid - Chart	Font styles and background for a fixed filter value i.e. one where there is no drop down for filter value in both Grid only and chart-only pivot grids		PSPGFIXEDFILTERVALUE	PT_ACE_SS1_CSS3	Modify the background color and font properties for this class.
Pivot Grid - Grid	Font properties, text alignment properties and text-decoration properties on hover for the value links with drill down in the grid		PT_PGVALLINK	PT_ACE_SS1_CSS3	Modify the font properties like style, family and color and also text-align properties for this class. Modify the text-decoration property for :hover selector of this class.
Pivot Grid - Grid	Font properties and text alignment properties for the value links without drill down in the grid This is generally a 0 in the grid.		PT_PGVAL	PT_ACE_SS1_CSS3	Modify the font properties like style, family and color and also text-align properties for this class.
Pivot Grid - Chart	Filter border style for chart-only pivot grids	PSPGCHARTBORDER		PSACE_CSS3	Modify the border properties for this class.
Pivot Grid - Chart	Border size and Border color of the filter value region which contains the drop down icon	PSACECOMBO_CHART		PSACE_CSS3	Modify the border width and border color property for this class.
Pivot Grid - Chart	Font styles and background for a filter name in chart-only pivot grids	PSPGCHARTFILTERNAME		PSACE_CSS3	Modify the background color and font properties for this class.

<b>Section</b>	<b>Element</b>	<b>Fixed Form Styles</b>	<b>Free Form Styles</b>	<b>Style Sheet</b>	<b>Description</b>
Pivot Grid - Chart	Font styles and background for a filter value shown before the filter drop down image in chart-only pivot grids	PSPGCHARTFILTERVALUE		PSACE_CSS3	Modify the background color and font properties for this class.
Pivot Grid - Narrow Chart Viewer	Font styles and background for a filter name in narrow chart pivot grids	PSPGCHARTFILTERNAME_NARO		PSACE_CSS3	Modify the background color and font properties for this class.
Pivot Grid - Narrow Chart Viewer	Font styles and background for a filter value shown before the filter drop down image in narrow chart pivot grids	PSPGCHARTFILTERVALUE_NARO		PSACE_CSS3	Modify the background color and font properties for this class.
Pivot Grid - Narrow Chart Viewer	Font styles and background for a fixed filter value i. e. one where there is no drop down for filter value in narrow chart pivot grids		PSPGFIXEDFILTERVALUE_NARO	PSACE_SS1_CSS3	Modify the background color and font properties for this class.



# Creating Image Definitions

---

## Understanding Image Definitions

Image definitions are image files that you import, store, and manage using PeopleSoft Application Designer. Image definitions, similar to field definitions, are reusable. After you create image definitions, you can associate them with page controls and reference them in code as often as you want. Most images that you see in PeopleSoft applications are image definitions. Image definitions appear throughout PeopleSoft applications, and serve many purposes, such as:

- In the page headers as a logo to enhance the appearance of the application.
- In Pagelet Wizard as numbers to sequence the individual tasks in a process.
- In the Main Menu as folders to indicate subordinate menus.
- In scroll area and grid headers to navigate among rows of data.
- In charts as connectors to indicate relationships among nodes.

PeopleSoft Application Designer enables you to import all types of graphics or image files and store them in the image catalog. After you finish this process, you can access the image definition and use it throughout the PeopleSoft application.

---

**Note:** Administrators can create HTML definitions (including JavaScript definitions) and free form style sheets, and upload images through portal branding pages (PeopleTools, Portal, Branding Objects), without requiring access to Application Designer. While the administrators cannot directly view or update the definitions created in Application Designer from the branding pages, definitions created with the portal branding pages can be viewed and edited in Application Designer. When creating a new definition using the portal branding pages, if the administrator uses an existing definition name of the same type, the system displays a prompt to overwrite an existing definition when saved.

---

**Note:** PeopleTools includes many image-related features. Image *definitions* are discussed in this topic; the other image-related features, such as fields and page controls, are discussed separately in this documentation.

---

See [Specifying Image Field Attributes](#), [Specifying ImageReference Field Attributes](#), [Setting Static Image Properties](#), [Setting Image Properties](#).

### Image Catalog

PeopleSoft Application Designer stores all image definitions in the PSCONTDEFN PeopleTools table. The collective set of image definitions that exist in this table is the image catalog. The image catalog holds all PeopleTools image definitions in addition to any image definitions that you create.

## Image File Types

Image file types or formats are a systematized means of storing digital images. File types vary in purpose and quality based on factors such as compression and color palette. You might want to use different file types for different images because of business or technical considerations that apply to your PeopleSoft implementation or because quality is more important to you than file size. The three most common file types that developers use most often to display images on the Internet are Graphics Interchange Format (GIF), Joint Photographic Experts Group (JPEG or JPG), and Portable Network Graphics (PNG).

Some developers believe, for example, that JPG is the best format for photographic images because it provides the greatest compression of any bitmap format in common use. However, some believe that the JPG file type is not as effective in compressing text and drawings as it is at compressing photographs. Similarly, many designers consider the GIF file type the optimal format for line drawings and text because it limits the color palette and compresses text in a way that retains the sharpness of images such as logos. The GIF file type also supports features such as image transparency and animation. These same characteristics of limited color and text compression make this file type less than optimal as the format for photographic images. Due to the proprietary nature of the GIF format, the PNG file type evolved as the free open-source response to the patented GIF format. The robust PNG file type supports more colors than the GIF, offers excellent online viewing, and streams well on modern displays.

While PeopleSoft Application Designer can create image definitions from image files that use the wireless bitmap (WBMP) format, these image definitions are visible in the runtime environment only through a mobile device. Because WBMP image types do not appear in the design time environment, PeopleSoft Application Designer offers you the option to provide an alternate image type of the image, such as JPG, for viewing purposes only. The image that you view at runtime in the wireless application is still the original WBMP image.

---

**Note:** PeopleSoft Mobile Agent is a deprecated product. Features related to mobile technology are included only for upgrade and backward compatibility.

---

See [Importing and Creating Alternate Image Types](#).

You should make your choice of file types by weighing the benefits and detractors of the image file types in the context of your implementation and technical requirements. PeopleSoft Application Designer can process image files regardless of file type, convert them into image definitions, and maintain them in the image catalog.

## Image File Size

The maximum image file size depends on the database platform that you are using. Some database platforms support much larger image sizes, while others limit the size. PeopleSoft Application Designer displays a warning message if the image size is greater than 32 kilobytes.

## Understanding the Image Catalog

PeopleSoft Application Designer stores all image definitions in the PSCONTDEFN PeopleTools table. The collective set of image definitions that exist in this table is the image catalog. The image catalog holds all PeopleTools image definitions in addition to any image definition that you create. The image catalog stores all image definitions and makes them available for use by developers.

## PeopleTools Image Definitions

In general:



- Most PeopleTools image definitions start with *PT\_*.
- Any image definition with *\_D* at the end of the name is the disabled mode of the image.
- All images that start with *PT\_TAB* are used for tab construction and colors.

A list of the PeopleTools images most common to all PeopleSoft application is located in another topic in this product documentation.

---

## Creating Image Definitions

This section discusses how to:

- Create image definitions.
- Set image properties.
- Import and create alternate image types.

## Creating Image Definitions

To create an image definition from an image file:

1. Select File > New.
2. Select Image.
3. Click OK to access the Open Image File dialog box.
4. Select an image file.

---

**Note:** PeopleSoft applications support animated GIF files. You will not see the animation in PeopleSoft Application Designer at design time; however, you will see the animation on the page at runtime.

---

**Note:** Some browsers do not support all image types.

---

See *Troubleshooting Browser Limitations* available on the My Oracle Support website.

5. Select an image file name.

PeopleSoft Application Designer displays a warning message if the image size is greater than 32 kilobytes. The maximum image size depends on the database platform that you are using. Some database platforms support much larger image sizes, while others limit the size.

6. Select Open.

The image appears as an image definition in the definition workspace.

7. Select File > Save to save the image definition in the PeopleSoft image catalog.

The Image Properties dialog box appears.

## Setting Image Properties

After you create a new image definition, you can set the image properties.

To set image properties:

1. Access the Image Properties dialog box.

If it is not already open, select File > Definition Properties.

2. (Optional) Enter a description on the General tab.
3. Select the Use tab to view image use properties.

### **Image Format**

Specify the main and alternate image formats. The main image format, which appears at runtime, is the format in which the image was imported, such as BMP. The alternate format is the optional image format that you can specify if you want a WBMP image as the main image format that appears at runtime.

### **Image URL**

Specify a reference to an image on a web server. This reference can be used as an alternative to storing an image definition in the database after an image definition is saved. When a user opens a page containing a control that is associated with this image definition, the application retrieves the image from the URL rather than from the database. Set up URLs in the URL Maintenance utility (PeopleTools, Utilities, Administration, URLs ).

### **Mirror this image in right-to-left contexts**

Select this property to have the system flip the image horizontally when a language that is read right-to-left (RTL) is in use.

Pages in languages with an RTL reading order, for example, Arabic, might also display images whose directionality depends on the directionality of the language. For example, an arrow in a margin that points to the text in a left-to-right (LTR) language, such as English, will point to the right; but in an RTL language, the arrow should point to the left.

### **Used in Workflow Maps**

Select to filter images that appear in a list box for the Change Icon function for PeopleSoft Workflow designers.

## Importing and Creating Alternate Image Types

To import a WBMP image type:

1. Select File > New.
2. Select Image.

The Open Image File dialog box appears.

3. Select *WBMP* from the Files of Type drop-down list box.
4. Locate the image that you want to import.
5. Click the Open button.

The Content Repository Interface dialog box appears, prompting you to select an alternate image.

6. Select Yes.

The Open Alternate Image File dialog box appears, prompting you to select an alternate image type. You must have the same image stored in the directory under a different file type, such as JPG, to view the image in PeopleSoft Application Designer. If you select No, you can still open the WBMP image definition, but you cannot see it. Instead, you receive a message that the image cannot be viewed in PeopleSoft Application Designer.

7. Select the alternate image format and the appropriate file.
8. Click Open.
9. Select File > Save As.

Upon saving, the Image Properties dialog box appears. If you select the Use tab, the Image Format group box shows the main image format as WBMP and the alternate image format as JPG. Now you can view the image in PeopleSoft Application Designer as a JPG image and still display the image at runtime as WBMP.

---

## Opening Image Definitions

To open an image definition:

1. Select File > Open.
2. Select *Image* from the Definition drop-down list box.
3. Click Open to view the full list of image definitions and brief descriptions.

---

## Updating Image Definitions

This section discusses how to:

- Update image definitions.
- Change an image display size.
- Specify an image storage format.

## Updating Image Definitions

Occasionally, the original image file from which you created an image definition might change. To keep the image definitions current, you might want to update them rather than create entirely new image definitions.

To update an image definition:

1. To change the image for a saved image definition, right-click the open definition and select Update Image.

The Open Image File dialog box appears, in which you can select the changed image file to replace the open image definition.

2. Click Open.

The previous image in the image definition is replaced with the new image that you selected.

3. Select File > Save to save the current image definition with the new image.

## Changing an Image Display Size

If an image file is smaller than you want it to appear in the open image definition, you can increase the size by zooming in on the definition workspace. The size of the image in the image catalog does not change.

To change an image definition display size:

1. Open the image.
2. Right-click the image and select Zoom to see the different size ratios.
3. Select a new image display percentage.

The image automatically changes to that selection.

## Specifying an Image Storage Format

You can specify a default format in which image definitions are stored. For example, if JPG is specified as the preferred storage format, then a BMP image is stored as a JPG after it is converted to an image definition.

To specify an image definition storage format:

1. Select Tools > Options to open the Options dialog box.
2. Select the Image tab.

### **No conversion**

Select to import all image definitions in their original formats. This value is the default.

### **DIB and JPG**

Select to convert and store the imported image definitions as either DIB or JPG in the PeopleSoft Application Designer

image catalog. GIF and WBMP images cannot be converted to DIB or JPG.

3. Click the OK button.

## Converting Images to JPGs

Not all browsers support all image formats, but most browsers support the JPG image type. Therefore, PeopleSoft Application Designer has a utility to convert all application images to JPG.

### Image: Convert Images dialog box

This example illustrates the fields and controls on the Convert Images dialog box. You can find definitions for the fields and controls later on this page.

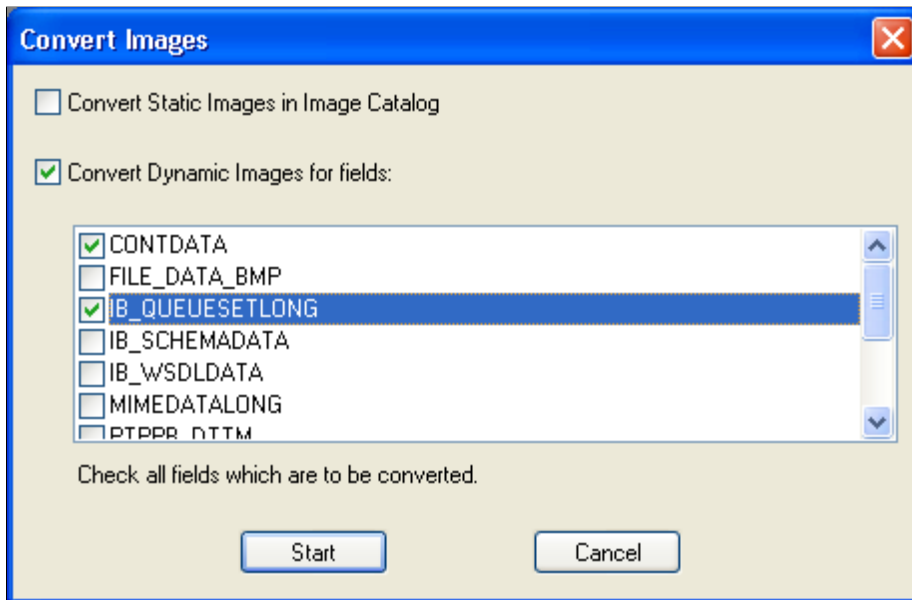

To convert images to JPG format:

1. Select Tools > Upgrade > Convert Images.
2. Select one of these check boxes:

**Convert Static Images in Image Catalog**

Converts all image definitions that are stored in the image catalog of the PeopleSoft database.

**Convert Dynamic Images for fields**

Converts all images that are dynamically referenced by PeopleCode to appear in image fields.

3. Select the fields to convert.
4. Click the Start button.

When the process is complete, a confirmation message appears in the Image tab of the output window.

## Consolidating Images

Use the Consolidate Images tool if you create custom image definitions and use them in multiple record definitions. Consolidating images helps you avoid having the same image stored in several places. All image definitions included in the PeopleSoft system have already been consolidated.

### Image: Consolidate Images dialog box

This example illustrates the fields and controls on the Consolidate Images dialog box. You can find definitions for the fields and controls later on this page.

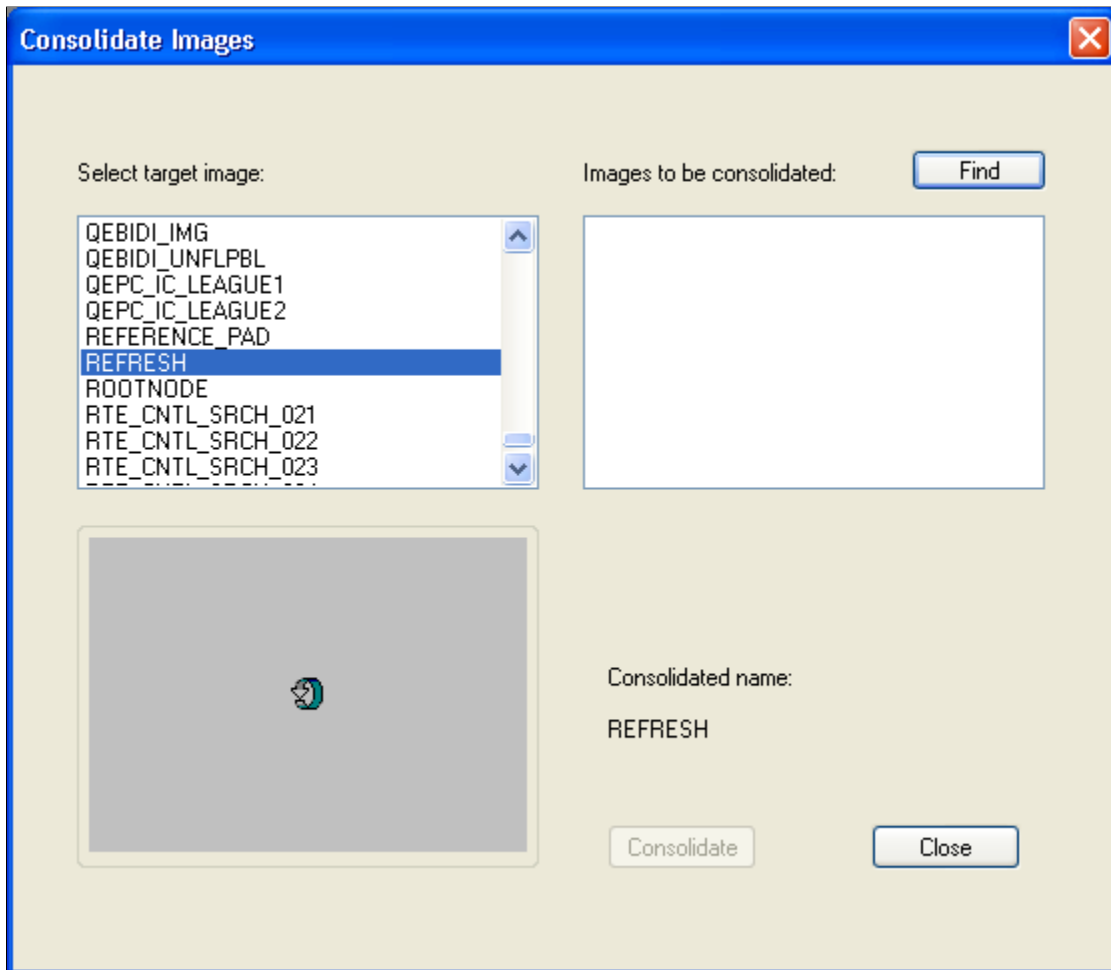

To consolidate custom image definitions:

1. Open an existing image definition in the definition workspace.
2. Select Tools > Consolidate Images.
3. Select a target image from the list.
4. Click Find to gather all of the consolidated image candidates.
5. Select all of the images.
6. Click Consolidate.

The selected image definitions are removed from the Images to be consolidated list box and consolidated into the target image.

7. Click Close.





# Creating HTML Definitions

---

## Understanding HTML Definitions

An HTML definition is a blank window where you can enter HTML. Use HTML definitions for storing long strings of HTML text or HTML text that you use repeatedly in your application. Later, you can access the definition dynamically from an HTML area control by using the GetHTMLText PeopleCode function.

See "GetHTMLText" (PeopleTools 8.58: PeopleCode Language Reference).

You can reference HTML definitions from an HTML area control statically or dynamically. However, the most common usage is to reference HTML definitions dynamically.

---

**Note:** Administrators can create HTML definitions (including JavaScript definitions) and free form style sheets, and upload images through portal branding pages (PeopleTools, Portal, Branding Objects), without requiring access to Application Designer. While the administrators cannot directly view or update the definitions created in Application Designer from the branding pages, definitions created with the portal branding pages can be viewed and edited in Application Designer. When creating a new definition using the portal branding pages, if the administrator uses an existing definition name of the same type, the system displays a prompt to overwrite an existing definition when saved.

---

There are a variety of ways to incorporate JavaScript and CSS into your applications.

<i>Application Type</i>	<i>Methods</i>
Fluid	<ul style="list-style-type: none"><li>• AddStyleSheet, AddJavaScript, AddOnLoadScript PeopleCode functions.  See "Built-In Functions" (PeopleTools 8.58: Fluid User Interface Developer's Guide).</li><li>• Page Properties: Fluid tab  See "Setting Fluid Properties" (PeopleTools 8.58: Fluid User Interface Developer's Guide).</li><li>• Properties (for any page control): Fluid tab  See "Setting Properties on the Fluid Tab" (PeopleTools 8.58: Fluid User Interface Developer's Guide).</li></ul>
Classic	<ul style="list-style-type: none"><li>• HTML Areas  See <a href="#">Using HTML Areas</a>.</li><li>• Component Properties: Style tab  See <a href="#">Setting Style Properties</a>.</li></ul>

---

## Creating HTML Definitions

To create an HTML definition:

1. Select File, New.

The New Definition dialog box opens, enabling you to select the definition you want.

2. Select HTML from the scroll area.
3. Click OK to open a new HTML definition.
4. Type or paste the HTML text directly into the open definition window.
5. Select File, Save to save the HTML definition.

The system saves the HTML definition in the current database.

---

## Opening HTML Definitions

To open an HTML definition:

1. Select File, Open to access the Open Definition dialog box.
2. Select *HTML* from the Definition drop-down list box.
3. Click Open to show all of the HTML definitions that are currently stored in the database.

You can also enter a letter or word in the Name edit box to filter the display. For example, entering the letter *H* reveals all of the HTML definitions that begin with *H* in the database.

Naming a group of HTML definitions with the same introductory phrase can help keep them together for easy selection.

---

## Referencing HTML Definitions Dynamically

To reference an HTML definition dynamically:

1. Add an HTML area control to a page definition.
2. Open the HTML Area Properties dialog box.
3. Select the *Constant* option.
4. On the HTML tab, enter the GetHTMLText PeopleCode function for the HTML definition that you want to reference.
5. Click OK.

## Related Links

[Populating HTML Areas](#)

[Adding Page Controls](#)

"Using HTML Definitions and the GetHTMLText Function" (PeopleTools 8.58: PeopleCode Developer's Guide)

---

## Working with JavaScript in HTML Definitions

This topic contains an overview and discusses:

- Disabling Minified JavaScript for a PIA Domain.
- Disabling Minified JavaScript for the Current User.

## Understanding PeopleTools Minified JavaScript

At runtime, PeopleTools minifies any JavaScript code stored within an HTML definition so that the JavaScript runs more efficiently on the web server. This is the default runtime behavior. JavaScript that has been minified has been stripped down to only the essential strings required for runtime execution. It runs in this compressed, or minified, format to save bandwidth.

Knowing that the JavaScript will be minified at runtime enables developers to more freely add comments and formatting to code, making it easier to understand during design time, without introducing processing overhead at runtime.

During “minification”, PeopleTools removes the following items from JavaScript code within HTML definitions:

- comments
- most extraneous white space
- most carriage returns
- most tabs

If during testing or debugging you need to examine the web server cache, note that JavaScript files stored in the web server cache follow a different naming convention depending on whether they are in a minified format. For example, JavaScript in the minified format contains a *MIN* in the filename. For example:

```
PT_ACE_SERVICE_win0_MIN_4.js
```

```
PT_ACE_SCROLL_MIN_1.js
```

The same JavaScript that has not been minified has the following filenames:

```
PT_ACE_SERVICE_win0_4.js
```

```
PT_ACE_SCROLL_1.js
```

By default, PeopleTools runs JavaScript in minified mode on the web server. For development or debugging tasks, you can disable the default runtime mode for an entire PIA domain or for the current

user. In general, if you are including custom JavaScript, it is recommended that you make sure it runs in unminified and minified modes. Errors as a result of minification typically generate messages in the application server log similar to:

*JavaScript Minification: Found an unterminated regular expression set in <HTML Definition Name> set in <line number>.*

---

**Note:** PeopleTools only minifies JavaScript contained in HTML Definitions.

---

## Disabling JavaScript Minification for a PIA Domain

A web profile setting controls the JavaScript minification behavior for a PIA domain.

To disable minification system-wide:

1. Select PeopleTools, Web Profile, Web Profile Configuration.
2. Select the desired web profile name.
3. Select the Debugging tab.
4. Make sure the Use Unminified JavaScript check box is checked.
5. Click Save.
6. Restart the PIA domain.

## Disabling JavaScript Minification for the Current User

---

**Note:** Disabling minified JavaScript for the current user mainly applies to a development or test environment where the Show Trace Link at Signon setting has been enabled for the current web profile, and a developer or tester was monitoring JavaScript execution in a single session. This is not an option intended for end users of a PeopleSoft application.

---

To disable minification for a single user:

1. Sign out of the current application.
2. On the PeopleSoft signon page click the Set Trace Flags link.
3. On the trace page under the Page Generation trace settings: heading, select Unminified javascript.
4. Enter the user ID and password and click Sign In.

### Related Links

"Configuring Web Profiles" (PeopleTools 8.58: Portal Technology)

# Constructing File Layouts and Performing Data Interchanges

---

## Understanding File Layouts

This section discusses:

- File layouts.
- Field formats in a flat file.
- Fixed-position (FIXED) format files.
- Comma-separated value (CSV) format files.
- XML-tagged (XML) format files.

## File Layouts

A file layout is a definition that represents the data structure of a flat (text) file to be processed. When reading from or writing to a flat file, PeopleCode can use a file layout as a template to identify and correctly process the records and fields of the file. File layouts work with hierarchical and non-hierarchical data, and they can handle files that combine data records with non-data (audit or control) records.

To access data in a file, you do not have to create a file layout. PeopleTools supports reading and writing to plain text files, as well as to files that have a format based on a file layout:

- If the file is a plain text file, you use text strings to read or write data.
- If the file is based on a file layout, you can use text strings, rowsets, or record objects.

Using a file layout greatly simplifies reading, writing, and manipulating hierarchical transaction data with PeopleCode. It can facilitate transactions between a PeopleSoft application and a third-party system when the third-party system does not support PeopleSoft Integration Broker or component interfaces.

---

**Note:** Do not create or save files in Microsoft Excel and then use those files for file processing. File layouts do not have any related-language processing abilities.

---

## Applying File Layouts to Data Interchanges

In addition to manipulating transaction data, you can employ file layouts to move data between a PeopleSoft database and external systems (data interchange) by using flat files as the transmission medium. File layouts enable you to:

- Export hierarchical PeopleSoft data to several flat file formats.

- Map incoming hierarchical file data directly to PeopleSoft tables.
- Preview and troubleshoot the input data and its formatting before importing it.
- Automatically generate the Application Engine and PeopleCode programs that are needed to perform data import.
- Use batch processes to perform large-volume data imports and exports.

## Related Links

[Performing Data Interchanges](#)

"Understanding File Layout" (PeopleTools 8.58: PeopleCode API Reference)

## Field Formats in a Flat File

A flat file, in the simplest sense, is a collection of fields in text format. The file must be formatted in a way that enables the PeopleCode to locate each field. PeopleSoft file layouts support three formats:

- **FIXED:** Each field has a starting position and a length that together specify its location in the file.  
This format is the default for new file layouts.
- **CSV:** Fields are located in the file by their sequence, separated by commas.
- **XML:** Fields are located by the named XML tags that surrounding them, not by their position or sequence within a record.

To preserve relationships between fields, you group fields into logical collections. In relational databases, these collections are records. Each line within a file is a collection of fields.

---

**Note:** With some file formats, the logical concept of a record may actually span multiple physical lines, but the concept of field collections remains.

---

The conceptual structure of all three file formats is represented in a file layout as follows:

### Image: File layout structure

The following is a screen image that explains the conceptual structure of all three file formats in a File layout

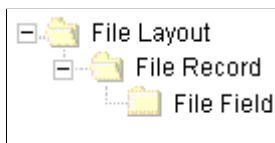

A file layout is a collection of file records, which in turn is a collection of fields, each of which has a describable location.

---

**Note:** To avoid confusion with the standard terms *record* and *field*, when working with a file layout we refer to a collection of fields as a *file record* and to fields as *file fields*.

---

## FIXED Format Files

FIXED format files are the most common type of flat file that is currently processed by PeopleSoft EDI Manager. Almost all electronic data interchange (EDI) type processing uses this file type where each data element is oriented by a fixed, or column-dependent, position within the file.

The following table describes the properties of FIXED format files:

<b>Property</b>	<b>Description</b>	<b>PeopleSoft EDI Manager Equivalent</b>
File Layout Format	File format (FIXED).	None.
File Record ID	A group of numbers that can be used to identify the file record.	RowID.
ID Start Position	The column starting position of the file record ID.	Treated as a field within each map.
(Record) ID Length	The length of the file record ID.	Treated as a field within each map.
File Record Name	A user-specified name for the file record.	PeopleSoft record name.
File Field	A user-specified name for the file field.	PeopleSoft record field name.
(Field) Start Position	The column starting position of the file field.	Starting position.
Field Length	The length of the file field.	Length of the field.
Field Format	The formatting options for both inbound and outbound field processing.	Based on the field type.

### Considerations for FIXED Format Files

Consider the following points when working with FIXED format files:

- Be careful when you change the length or starting position of any file fields or when you insert a new file field between two existing ones.

You might overlay fields, with unpredictable results.

- When you insert a record into a file layout, fields of the Long type are converted to the Character type with a length of 0.

You must set the field length to a number greater than 0 before you can save the file layout.

## CSV Format Files

In this type of file, each data element is surrounded with a separator, a delimiter, or both. You can use file record IDs to determine the source table and the target table; however, in most cases this type of file contains homogenous records.

In the following example, the qualifier is a double quote (") and the delimiter is a comma (,):

```
"NAME", "ADDRESS", "PHONE"
```

File layout definitions store the file record ID (when used) and the relative sequence number of the field. In the preceding example, "PHONE" is sequence number 3.

The following table describes the properties of CSV format files:

<i>Property</i>	<i>Description</i>	<i>EDI Manager Equivalent</i>
File Format	File format (CSV).	None.
File Record ID	A group of numbers that can be used to identify the file record.	RowID.
ID Sequence Number	The sequence number of the field that contains the file record ID.	Treated as a field within each map.
Qualifier	The character that surrounds a field to mark its extent. This character can be set at the file layout, file record, or file field level.	Delimiter.
Delimiter	The character used to separate fields from each other. This character can be set at the file layout or file record level.	Separator.
File Record Name	A user-specified name for the file record.	None.
File Record Field	A user-specified name for the file field.	None.
Field Format	The formatting options for both inbound and outbound field processing.	Based on the field type.

## Considerations for CSV Format Files

Consider the following points when working with CSV format files:

- Both the qualifier and the delimiter accept a blank as a valid value.
- If a field is null, you do not have to use qualifiers.

In the following example, Field2 is null:

```
Field1,,Field3,Field4. . .
```

- The system automatically pads the decimal places with zeros when amounts do not have values beyond the decimal point.

For example, 100 is automatically written as 100.00.

## Parsing Support for CSV Format Files

The following list summarizes parsing support in preview and runtime for all CSV file types:

- All blank lines are ignored.



In the past, blank lines came in as empty records.

- All empty fields are returned as empty strings or zeros.
- Fields, including commas or new lines, are surrounded in quotes.
- When a field is in quotes, any embedded quotes must be escaped by two quotes.
- When non-Microsoft Excel format backslashes are embedded within a string, they must be double backslashes to be interpreted as a backslash; otherwise, they are interpreted as an escape character.

## Parsing Support for Microsoft Excel CSV Format

The following table summarizes the differences between Microsoft Excel CSV parsing and non-Microsoft Excel CSV parsing:

<i>Item</i>	<i>Microsoft Excel CSV Parsing</i>	<i>Non-Microsoft Excel CSV Parsing</i>
White space	Leading and trailing white space is significant for strings.	Leading and trailing whites paces are ignored, including converted tabs.
Backslash	Not interpreted as special characters except for new lines.	Interpreted.
Quotes inside quoted string	Double quoted.	Escaped.
Tab	Converted to a single space.	Interpreted as tabs and ignored.

## XML Format Files

This type of file contains data that is represented in a hierarchical or tree-type structure. A tag surrounds each data element. A file record tag might group multiple entries.

File layout definitions tie the identifier, along with parent and child relationships, to the file record and file field.

PeopleSoft EDI Manager has no equivalent format.

The following table describes the properties of XML format files:

<i>Property</i>	<i>Description</i>
File Format	The XML file format.
File Record ID	The tag name representing the file record.
Field Identifier	The tag name representing the file field.
Field Format	The formatting options for both inbound and outbound field processing.
File Record Name	A user-specified name for the file record.

<b>Property</b>	<b>Description</b>
Field Name	A user-specified name for the file field.

## Considerations for XML Format Files

Consider the following points when working with XML format files:

- The XML input file must contain at least the fields that are specified in the file layout definition that you use.

If the file is missing any fields, the input rowset does not contain any data.

- If the XML input file contains extra fields that are not specified in the file layout definition, then the ReadRowset method ignores the extra fields.
- When you insert a record into a file layout, fields of the Long type are converted to the Character type, with a length of 0.

You must set the field length to a number greater than 0 before you can save the file layout.

- The system automatically pads the decimal places with zeros when amounts do not have values beyond the decimal point.

For example, 100 is automatically written as 100.00.

- When importing XML files, the longest tag name supported is 30 characters. This restriction is only an issue when importing XML files because PeopleSoft Application Designer automatically enforces the limit .

## Exporting Data to ISO Standard-Format XML Files

If you need to export data to an ISO standard-format XML file, with respect to thousands separators, decimal separators, and date format for XML format files, you can enable that behavior for the system by adding a custom section and parameter to the application server and/or Process Scheduler configuration file of the appropriate server process.

If the file layout output is generated from PeopleCode embedded in a PeopleSoft page, the application server configuration file setting is used. If the file layout output is generated by running an Application Engine program through Process Scheduler, the Process Scheduler configuration file is used.

The following procedure assumes a working knowledge of PeopleSoft server administration. See "Understanding PSADMIN" (PeopleTools 8.58: System and Server Administration).

To add the custom File Layout settings:

1. Open the configuration file of the appropriate domain.

For a Process Scheduler domain, open PSPRCS.CFG, and for the application server domain , open PSAPPSRV.CFG.

2. Add a new section to the file: *[File Layout]*.
3. In the *[File Layout]* section, add the parameter IsoXmlOutput and set it to Y.

For example:

```
[File Layout]
IsoXmlOutput=Y
```

4. Save the configuration file.
5. Reboot the Process Scheduler domain or application server domain.
6. Repeat these steps for additional domains involved.

Once enabled, XML file layout output would follow ISO standards, regardless of any regional personalizations set by the end-user. For example, these ISO standards would appear in the XML output.

- No thousands separator and a dot (period) for a decimal separator.

*8000.00*

- Dates in the YYYY-MM-DD format.

*2014-01-12*

---

**Note:** Enabling ISO output for XML file layouts affects export behavior only (from a database table to a file). It does not change the existing import behavior (from a file to a database table) of an XML-type file layout. As a result, a file exported with IsoXmlOutput enabled may not necessarily be able to act as the source file for importing data into the system.

---

---

## Constructing File Layouts

This section discusses topics related to creating file layouts.

### Creating New File Layout Definitions

In PeopleSoft Application Designer, select File > New > File Layout.

**Image: File layout with two records in a hierarchy**

This example illustrates the fields and controls on the File layout with two records in a hierarchy. You can find definitions for the fields and controls later on this page.

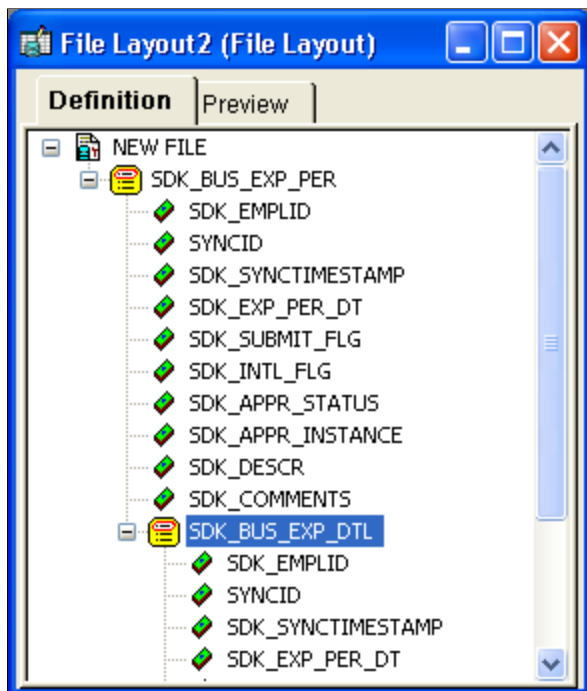

A new file layout contains only one element, the root node to which file records are attached. The default root node name is NEW FILE.

Save the new file layout definition. You are prompted to name the file layout, which also becomes the name of the root node.

---

**Note:** The default file layout format is FIXED.

---

**Related Links**

[Specifying File Layout, Record, and Field Properties](#)

**Adding File Records and File Fields**

You can add file records and file fields to your file layout in two ways:

- Base them on existing record and field definitions in the database.
- Construct them directly in the file layout without reference to any database records or fields.

A file record that you construct in this way is added as a segment, but the result is an ordinary file record.

You can use both methods in any combination when creating file records and file fields in a file layout definition. Each file record and file field is generically referred to as a node.

---

**Important!** Regardless of the method that you use, file records and file fields exist only as definitions within a file layout and have no connection with any database record or field. Even with file records based on records in the database, a change to the database record definition is *not* reflected in the file layout. After any update to PeopleTools, you should regenerate all file layout definitions.

---

## Using a Segment Instead of a Record

Suppose that in the file that is provided to you, some of the file records contain new data and must be inserted, while others contain data that updates existing data. You can add a segment with a single field (like `AUDIT_ACTION`) that indicates whether the file record is new or changed. When you process the file, you can use PeopleCode to look at this field and, based on its value, perform the appropriate action.

As another example, suppose that you want to include only two fields from the `PERSONAL_DATA` table in the file. You have two choices: insert the `PERSONAL_DATA` table and manually delete all of the unwanted fields or insert a segment, name it `PERSONAL_DATA`, and then insert the two fields that you want.

## Using Segments in Data Interchanges

If you create a file layout for a data interchange, you can use segments, but each file record must correspond to a record with the same name in the PeopleSoft database, and its file fields must have the same names and data formats as the fields of the database record. The file record can contain a subset of the fields in the corresponding database record. It can also contain a subset or a superset of the fields that are provided in the corresponding file data.

## Adding File Records

To add a file record to the file layout definition, use one of the following methods:

- Drag and drop a database record.

Drag a record definition from the project window into the definition window of the file layout. When dropping a record from a project onto a file layout definition, keep these items in mind:

- If you drop the record onto the root node, it becomes the first top-level segment of the target root node.
  - If you drop the record onto a segment, it becomes a segment on the same level as the target segment, immediately following it in the order.
  - If you drop the record onto a file field of segment, it becomes the first child segment of the target segment.
  - The system inserts all of the constituent fields of the dragged record as well.
  - Whether a node is currently selected does not matter. The system only considers the location of the cursor when you drop the record (the drop site) in determining the placement of the resulting segment.
- Insert a database record.

With the root node or a file record highlighted, select `Insert > Record`. When you select a record, the new file record appears following the highlighted file record and at the same level. The system automatically inserts all of the constituent fields of the record as well.

- Insert a segment.

With the root node or a file record highlighted, select Insert > Segment > and enter a file record name. When you click OK, the new file record appears following the highlighted file record and at the same level.

- Insert a child segment.

With a file record highlighted, select Insert > ChildSegment and enter a file record name. When you click OK, the new file record appears one level below the highlighted file record but before any others at that level.

---

**Note:** When you add a file record at the root level, it appears immediately below the root node, before all of the other file records.

---

## Adding File Fields

To add a file field to the file layout definition, use one of the following methods:

- Drag and drop a database field.

Drag a field definition from the Project window into the Definition window of the file layout, dropping it on any existing file record or file field. Confirm the field name or enter a different one, and click OK. The new file field appears following the node that you dropped it on.

- Insert a database field.

With a file record or file field highlighted, select Insert > Database Field. Confirm the field name or enter a different one and click OK. The new file field appears following the highlighted node.

- Insert a file field.

With a file record or file field highlighted, select Insert > FileField > and enter a file field name. When you click OK, the new file field appears following the highlighted node.

---

**Note:** Each file field must have a unique name within its parent file record, but file fields in different file records can have the same name.

---

## Reordering File Layout Nodes

The file layout definition provides a set of directional arrow buttons in the toolbar, which you can use to reposition any file record within the hierarchy of the file layout or any file field within its parent file record.

The up and down arrows do not change the level of the selected item, just its order among other items at that level. The right and left arrows move the selected item lower and higher in the file layout hierarchy.

---

**Note:** When you reposition a file record in the file layout, its child records are also repositioned, and their child records are repositioned, and so on.

---

## Naming File Layouts, Records, and Fields

File layout names can be 30 characters in length, and file record and file field names can be 15 characters in length. All names should follow PeopleSoft naming standards.

Each file record within a file layout must have a unique name, but one file record can have the same name as the file layout. Each file field within a given file record must have a unique name, but file fields in different file records can have the same name.

### Using WriteRecord, ReadRowset, and WriteRowset

If you use the WriteRecord, ReadRowset, or WriteRowset file layout methods for writing to or reading from records, the application record and the file record *must* have the same name, and the application record fields and the file fields *must* have the same names. These methods write only to like-named records and like-named fields within a given record. If you rename a record or a field after you use it to create a file layout definition, you must rename the file record or file field to the exact same name.

In a file layout definition containing more than one record, the system ignores records and fields that are not like-named. Like-named records do not have to contain all of the same fields, and like-named fields do not have to be the same length. Like-named fields should, however, be of the same type.

### Related Links

[Naming Record Definitions](#)

## Applying Field Formats

The following topics discuss issues you must consider when specifying field formats.

### Numbers Format in FIXED Files

When you write numeric data to a FIXED format flat file, all numbers are right-justified in the file field. Numbers with decimal places specified are written with zeros padding the unused decimal places.

For example, a sequence of records with numbers of varying precision is written this way:

```
001      53.2700BUY
002  2174.0933SELL
003   108.0000SELL
```

### Date, Time, and Datetime Field Lengths

In accordance with the International Organization for Standardization (ISO) 8601 standards, the field lengths for date, time, and Datetime fields are fixed in the file layout, regardless of the file format:

- Date fields have a fixed length of 10.
- Time fields have a fixed length of 20.
- Datetime fields have a fixed length of 31.

Datetime fields must use one of these formats.

- CCYY-MM-DD HH:MM:SS
- CCYY-MM-DDTHH:MM:SS (with time separator)

- CCYY-MM-DD HH:MM:SS.ssssss (with fraction of seconds)
- CCYY-MM-DDTHH:MM:SS.ssssss (with time separator and fraction of seconds)
- CCYY-MM-DD HH:MM:SS.ssssss+hhmm or CCYY-MM-DD HH:MM:SS.ssssss-hhmm (with fraction of seconds and universal time zone offset)
- CCYY-MM-DDTHH:MM:SS.ssssss+hhmm or CCYY-MM-DDTHH:MM:SS.ssssss-hhmm (with time separator, fraction of seconds, and universal time zone offset)

---

**Note:** PeopleSoft applications comply with ISO 8601 guidelines for representing date field data. Refer to the ISO 8601 guidelines for more information.

---

See <http://www.w3.org/TR/NOTE-datetime>.

### Date Format with the ReadRowset Method

Single digits in dates in the form MMDDYY or MMDDYYYY must be padded with zeros. That is, if the date in the data is February 3, 2002, then the format must be:

- 02/03/2002
- 02/03/02

The format 2/3/02 is *not* valid.

When using the date format DDMMYY, single digits should also be padded with zeros, and the month value should be all uppercase letters. For example, if the date in the data is February 2, 2003, then the format must be 02-FEB-03. The format 2-Feb-03 is *not* valid.

### Related Links

"File Layout Error Processing" (PeopleTools 8.58: PeopleCode API Reference)

---

## Specifying File Layout, Record, and Field Properties

This section discusses how to:

- Specify file layout properties.
- Specify file record properties.
- Specify file field properties.

---

**Note:** Some properties are available only for a specific file layout format. For example, a file definition tag is available only for an XML format file. When a property is available only for a particular format, the format is noted in parentheses after the name of the property (such as File Definition Tag [XML]).

---

**Note:** Each property that appears in the Preview tab of the File Layout Designer is only another view of the corresponding property of the same name that appears in the Properties dialog box when working with the Definition tab. Changing any property value in one view changes the same property value in another view.

---



---

**Important!** It is important to keep in mind that the information about file layout segments and file layout fields is stored in the database separately from the information about the associated records, record fields, and database fields. This separate storage can cause problems, for example, if the data type or size of a database field changes while the corresponding information about an associated file layout field remains unchanged. Another example might be if a record field is removed from a record while the corresponding file layout field remains in the associated file layout segment. Because of the potential for the file layout and the underlying database structure to diverge over time if changes are made to the system, it is very important (particularly after an upgrade) to confirm that each file layout segment be kept in sync with its associated record and that each file layout field be kept in sync with its associated database field.

---

## Specifying File Layout Properties

The File Layout Definition Properties dialog box contains all of the information that is stored at the file layout (root) level.

Access the dialog box by using one of the following methods:

- Select File > Object Properties.
- Press the Alt+Enter keys.
- Double-click the topmost (root) node of a file layout definition.
- Right-click an open file layout and select Data Object Properties.

The General tab of the dialog box contains description information for the file layout. The Use tab contains specific information for the file layout:

**Image: File Layout Definition Properties dialog box: Use tab**

This example illustrates the fields and controls on the File Layout Definition Properties dialog box: Use tab. You can find definitions for the fields and controls later on this page.

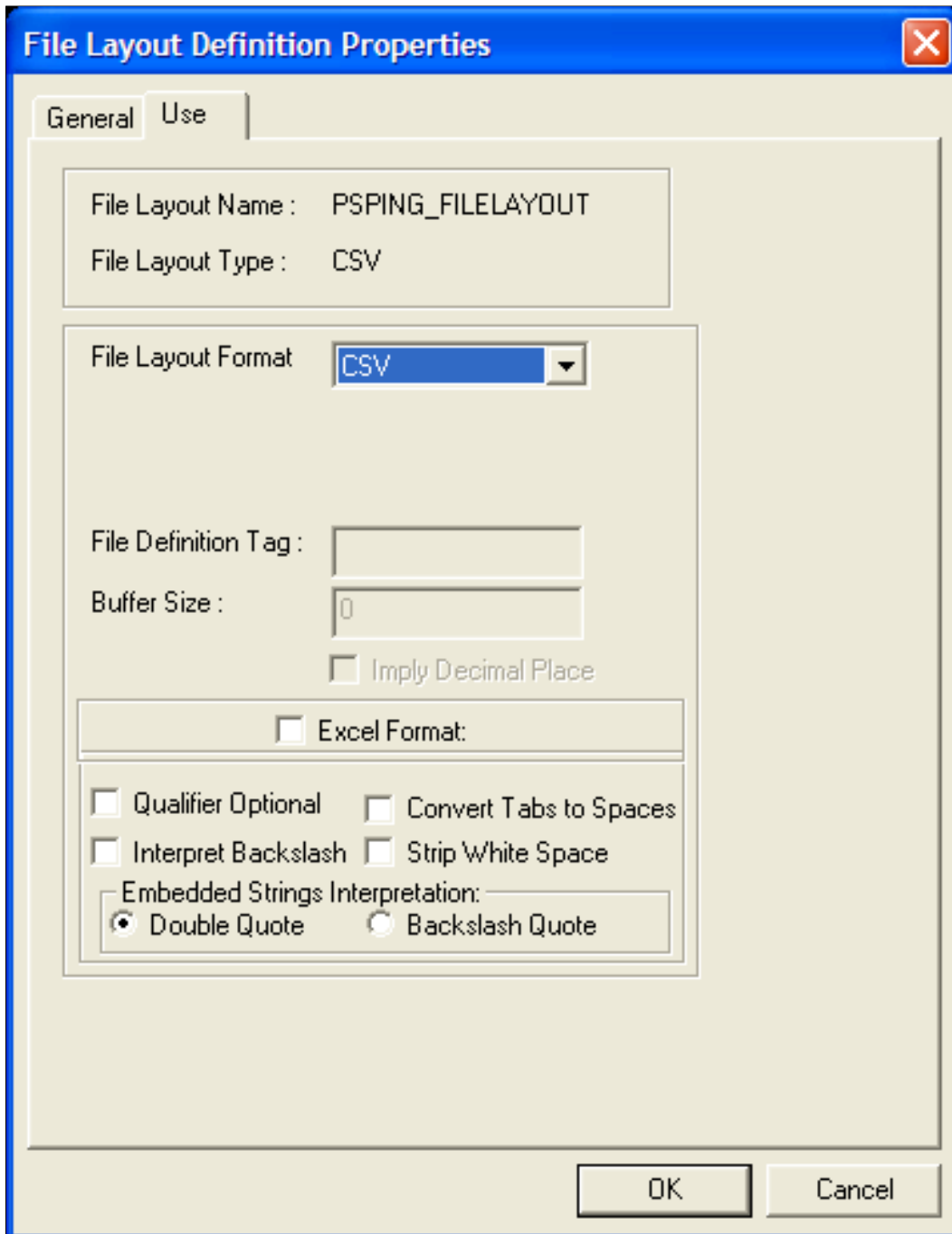
**File Layout Format**

Displays the type of file layout. Values are *FIXED*, *CSV*, and *XML*.

**File Definition Tag**

Enter the XML tag name that is associated with this layout (or transaction). This tag can be 30 characters in length. This tag must be unique in the file layout.

This field is active when the file layout format is XML.

---

**Note:** If you leave this field blank, the system inserts `<start>` into the file as the default tag value. Enter any value to prevent the system from inserting the default `<start>` tag into the file.

---

**Buffer Size**

Displays the size of the input buffer that is used at runtime.

This field is active when the file layout format is XML.

---

**Note:** Do not edit this value directly.

---

**Imply Decimal Place**

Select to automatically add a decimal place based on the decimal value that is specified in the field definition when you import a file into a PeopleSoft database and no decimal place is specified for numeric values in the file.

If you select this option, make sure that the length that you specify for the Number field includes a decimal point, even though it is not visible. In this case, the decimal point is counted as a space. For each occurrence of numeric data that is missing a decimal point character in the input file, a space character is also required in the input file; locate the space character either immediately before the numeric characters or immediately after them.

This field is active when the file layout format is FIXED.

**Excel Format**

Select to parse the field by using Microsoft Excel CSV specifications.

This field is active when the file layout format is CSV.

**Qualifier Optional**

Select to parse the field based on delimiters. When a qualifier exists, the field is parsed by using a closing matched qualifier. The system ignores all characters before and after the qualifier.

This field is active when the file layout format is CSV.

If you do not select this check box, the field *must* have qualifier pairs. The system ignores all characters before and after the qualifier.

**Convert Tabs to Spaces**

Select to convert all tabs within the field to spaces. If you do not select this option, the system ignores all tabs.

This field is active when the file layout format is CSV.

---

**Note:** If the Strip White Space option is also selected, the system removes trailing and leading tabs.

---

**Interpret Backslashes**

Select to interpret backslashes within field data as escape characters.

The following characters have special meanings:

- \t represents a tab.
- \n represents a new line.

If you do not select this check box, the system considers backslashes to be regular text data.

This field is active when the file layout format is CSV.

### Strip White Space

Select to remove all leading and trailing white space within field data from the output data.

This field is active when the file layout format is CSV.

---

**Note:** If you select this option, the system removes trailing and leading tabs, regardless of whether you selected the Convert Tabs to Spaces option.

---

### Double Quote

Select to interpret two double quotes (" "), as one double quote (") in output data.

For example, if you enable this option, abc""def" is interpreted as abc"def.

This field is active when the file layout format is CSV.

### Backslash Quote

Select to interpret backslash quotes (\") as one double quote (") in output data.

For example, if you enable this option, "abc\"def" is interpreted as abc"def.

This field is active when the file layout format is CSV.

### Related Links

[Understanding File Layouts](#)

## Specifying File Record Properties

The File Layout Segment Properties dialog box contains information that is stored at the file record level:

**Image: File Layout Segment Properties dialog box: Use tab**

This example illustrates the fields and controls on the File Layout Segment Properties dialog box: Use tab. You can find definitions for the fields and controls later on this page.

The screenshot shows the 'File Layout Segment Properties' dialog box with the 'Use' tab selected. The fields and their values are as follows:

Field	Value
File Layout Name	PSPING_FILELAYOUT
File Layout Type	CSV
File Record Name	TP_TST_CASE_VW
ID Seq No	1
Max Rec Length	106
File Record ID	
ID Start Position	0
ID Length	0
Default Qualifier	
Seg Terminator	
Field Delimiter	Comma
Record Tag	PTP_TST_CASE_V
Record Description	

At the bottom of the dialog box are 'OK' and 'Cancel' buttons.

Access the dialog box using one of the following methods:

- Double-click the file record node.
- Right-click the file record node and select Selected Node Properties.

<b>File Record Name</b>	Enter a file record name that is associated with this file record. This name is used to access the file record from PeopleCode. Every file record in a file layout must have a unique name.
<b>ID Seq No. (CSV)</b> (identification sequence number)	Enter a sequence number for the field that contains the file record ID.
<b>Max Rec Length</b> (maximum record length)	Displays the default maximum length of the combined field sizes of the record. This value is automatically updated.
	<hr/> <b>Warning!</b> Any inbound or outbound data is truncated beyond this value. <hr/>
<b>File Record ID</b>	Enter a number that uniquely identifies the file record in the file layout. You can use this number for processing the file. This number is automatically written to the file if you use the WriteRecord or WriteRowset methods and if the file type is FIXED or CSV.
<b>ID Start Position (FIXED)</b>	Enter the column or starting position in the file record where the file record ID starts.
<b>ID Length (FIXED, CSV)</b>	Displays the length of the file record ID. This number is automatically generated when you enter the file record ID.
	<hr/> <b>Note:</b> Do not edit this value directly. <hr/>
<b>Default Qualifier (CSV)</b>	Enter a qualifier that is used for the file record ID and as the default for fields when no field qualifier is specified. This value overrides the definition qualifier that is specified in the File Layout Definition Properties dialog box. When you first create a file layout, this property is blank.
<b>Seg Terminator (FIXED, CSV)</b> (segment terminator)	Enter characters to be placed at the end of each segment when the layout is written to a file.
	<hr/> <b>Note:</b> The segment terminator of a file record is <i>not</i> the same as its record terminator. The segment terminator occurs immediately after a single row of data; it is defined only at design time in the File Layout Designer. The record terminator occurs immediately after the segment terminator; it is defined only at runtime by the SetRecTerminator method of the File class. See "SetRecTerminator" (PeopleTools 8.58: PeopleCode API Reference) for more information on the SetRecTerminator method. <hr/>
<b>Field Delimiter (CSV)</b>	Enter a delimiter that is used for all fields in the file record. This value overwrites the definition delimiter that is specified on the File Layout Definition Properties dialog box.
<b>Record Tag (XML)</b>	Enter an XML tag name for this file record. The default value is the file record name.

---

**Note:** Within a particular file layout, each record name and record tag must be unique.

---

### **Record Description**

Enter a description of the record for documentation purposes only.

## **Specifying File Field Properties**

The File Layout Field Properties dialog box contains information that is stored at the file field level:

**Image: File Layout Field Properties dialog box: Use tab**

This example illustrates the fields and controls on the File Layout Field Properties dialog box: Use tab. You can find definitions for the fields and controls later on this page.

The screenshot shows the 'File Layout Field Properties' dialog box with the 'Use' tab selected. The dialog is titled 'File Layout Field Properties' and has a blue header bar. Below the header, there is a 'Use' tab. The main area contains several sections:

- Layout Information:** Layout Name: PSPING\_FILELAYOUT, Sequence No: 1, Layout Type: CSV.
- Field Name:** PTP\_TEST\_CASE\_ID
- Start Position:** 1
- Length:** 30
- Field Type:** Character (dropdown menu)
- Qualifier:** (empty text box)
- Decimal:** 0
- Field Tag:** PTP\_TEST\_CASE\_ID
- Propagate:** 0 (with left and right arrow buttons)
- Strip Characters:** (empty text box)
- Field Description:** (empty text area)
- Default Value:** (empty text box)
- Field Inheritance:** Record: DO-NOT-INHERIT (dropdown menu), Field: (dropdown menu)

At the bottom of the dialog are 'OK' and 'Cancel' buttons.

**Important!** You must manually synchronize the file layout field properties with the related properties of any associated field definition. Unexpected results can occur when the properties are not synchronized. These properties are most likely to be not synchronized immediately after an upgrade.

Access the dialog box using one of the following methods:

- Double-click the file field node.



- Right-click the file field node and select Selected Node Properties.

Most individual properties are usable by all field types. However, some are specific to a particular field type, for example, the Upper Case check box is applicable to character fields only, the Date Separator field is applicable to date fields only, and so on. The preceding dialog box shows the properties for a character type of field. The following descriptions include all possible properties.

**Date Format (Date)** Select a date format, such as MMDDYY, DDYYMM, and so on.

**Date Separator (Date)** Enter a character that is used to separate date values. The default value is /.

**Decimal** Enter the number of decimal positions to the right of the decimal point. This property is valid only for fields that are defined as number or signed number.

---

**Note:** Only 31 characters plus a decimal point are allowed.

---

**Default Value** Enter the default value to be used by a call to ReadRowset when the corresponding data is imported from a file via a file layout definition.

---

**Note:** You cannot use the system variables related to date and time (for example, %Date, %Time, %DateTime) to specify the value of the default-value property of a file layout field. The value of the default-value property of a file layout field has no relationship to the value of the default-value property of any corresponding record field (one having the same record name and field name). When data is imported from a file via a file layout definition, the value used for a file layout field that is empty in the input file is determined by the default value of the corresponding file layout field, not the default value of any corresponding record field (even if the value of the default-value property of the file layout field is empty and even if that record field is required).

---

**Field Description** Enter a description of the field for documentation purposes only.

**Field Inheritance** Optionally select a parent file record and field from which the current field value is to be inherited. If you write to a file, the value is written only in the parent file record, not in the child (inheriting) file record; the value is not written more than once to a file. If no value is present in the parent field, then the system uses the default value that is specified here.

For example, the following file sample shows both the EMPLID (8113) and EFFDT (08/06/1999) written only once to a file, though these fields are repeated in the third file record (with a file record ID of 102):

```
100 8113 Frumman,Wolfgang
101      08/06/1999      000001      219 Going to London of⇒
fice
102      100 000015 I 08/06/1999
```

```

102                200 000030 I 08/06/1999
102                300 000009 I 08/06/1999
102                400 000001 I 08/06/1999
102                500 000011 I 08/06/1999

```

<b>Field Name</b>	Enter the name that is associated with this file field. Use this name when accessing the file field from PeopleCode. Every field within a file record must have a unique name; however, two different file records can contain the same file field.
<b>Field Tag (XML)</b>	Enter an XML tag name to be used around the field. The default value is the name of the field.
	<hr/> <b>Note:</b> Within a particular file record, each field name and field tag must be unique. <hr/>
<b>Field Type</b>	Select the data type of the file field.
<b>Length</b>	Enter the maximum number of characters in this field.
	<hr/> <b>Note:</b> You are allowed only 32-character precision for number and signed number fields; that is, a total of 32 characters both to the right and left of the decimal. Other fields, such as character fields, can be longer. You cannot set a field length for Date, Time, and Datetime type fields. These field lengths are automatically set to the ISO standards for such fields. <hr/>
<b>Pad Field (CSV)</b>	Select to enable field padding. The field will be padded with space characters up to the value of the length property. Character data will be left justified, numeric data right justified.
<b>Propagate (FIXED)</b>	If a field position or length is changed, enter an amount here to increment (positive number) or decrement (negative number) the current field and all fields before it (<<<<) or after it (>>>>).
<b>Qualifier (CSV)</b>	Enter a qualifier for the field, that is, the character that surrounds this field, separating it from other fields. Specifying this value overwrites the value that is specified in the file layout properties and file record properties.
<b>Start Position (FIXED)</b>	Enter the starting position (column) of the field within the file record.
	<hr/> <b>Important!</b> If you specify a start position for a field that overwrites a previous field, no data is written to the file. Use Propagate to change the start positions for your file fields. <hr/>
<b>Strip Characters</b>	Specify any characters to be removed from the input buffer. Use this field to preprocess input strings. For example, if a field in the input file contains hyphens but you want to remove the hyphens before processing the field, you can enter a hyphen here and it will be stripped out while being read. You can specify more than one character to be stripped out. Be sure to

not separate the strip characters. For example, the following code strips out all semicolons and hyphens:

```
;-
```

The following code strips out all semicolons, hyphens, and spaces:

```
; -
```

### Trim Spaces

Select to remove trailing spaces only from an input string. This option is active only for FIXED and CSV formats.

This option is different from the Strip Characters field, which removes all spaces from the entire input field if you specify a space.

### UpperCase (Char)

Select to convert lowercase text to uppercase during inbound processing. Use this option primarily when customer data is in lowercase and the PeopleSoft software requires the data to be in uppercase.

---

**Note:** PeopleSoft applications do not accept numbers that contain thousand separators, as in "," or ".". For example, if you exchange data with Microsoft Excel, you need to disable the "Use 1000 Separator (,)" property.

---

### Related Links

[Understanding Field Definitions](#)

---

## Performing Data Interchanges

This section provides an overview of the import process and discusses how to:

- Preview input data.
- Generate and run the import program.
- Export data.

## Understanding the Import Process

To help you troubleshoot and import flat file data, the file layout definition provides a data preview page. It can also generate an Application Engine program with the associated PeopleCode that is necessary to import the data.

---

**Note:** The Application Engine program that the system automatically generates should be viewed as containing sample PeopleCode that you need to review and modify, especially when a single file layout involves multiple records.

---

## Data Import Activities

Importing data by using a file layout requires the following sequence of activities:

1. Provide the import data in a properly formatted flat file.

Each record in the file must correspond to a record with the same name in the PeopleSoft database, and its fields must have the same names and data formats as the fields in the database record. Each record in the file must end with a new line character.

2. Create a file layout definition to match the record and field structure of the data.

Insert the appropriate record definitions into the file layout, and then reposition the file records and file fields to match the record and field positions in the file.

3. Preview and troubleshoot the input data format and content.
4. Generate the data import Application Engine program and PeopleCode.
5. Run the Application Engine program to import the data.

## Field Inclusion and Exclusion

The fields in the records of the data file can be a subset of the fields in the database record. Define your file layout with only the file fields that you expect to receive.

The fields in the records of the data file can be a superset of the fields in the database record; you must define your file layout to suppress or ignore the extra fields. For FIXED files, do not define a field at the corresponding position in the file layout definition. For CSV files, the file layout must have the same number of fields in each record as there are in the corresponding file record; for each field that you do not want to import, define a field in the file layout at that position that does not correspond to any field in that database record. For XML files, the system automatically ignores any extra fields.

Your data file can contain a subset or a superset of the records that are defined in the file layout. The system imports only a file record with a matching file record ID in the file layout.

## Record Hierarchy

In theory, you can ignore rowset hierarchy when importing file data, because the PeopleSoft database stores each record independently of the others, and the import process does not use rowsets. However, many records are designed with hierarchical dependencies in mind. The input file might omit inherited field values or order the data records in a way that reflects such dependencies.

If the input file omits inherited field values, make sure that the records in the file layout of the inheriting fields are children of the ones from which they inherit their values and set up Field Inheritance appropriately.

If the records to be imported contain key fields that reflect a rowset hierarchy, they might be in an order in the file that also reflects the hierarchy. Make sure your file layout reflects that hierarchy as well.

---

**Important!** The completed file layout must have exactly one file record at the root level; all other file records must be below that level.

---

## Related Links

[Reordering File Layout Nodes](#)

## Previewing Input Data

In PeopleSoft Application Designer, select File > New > File Layout > Preview.

### Image: File layout preview

This example illustrates the fields and controls on the File layout preview. You can find definitions for the fields and controls later on this page.

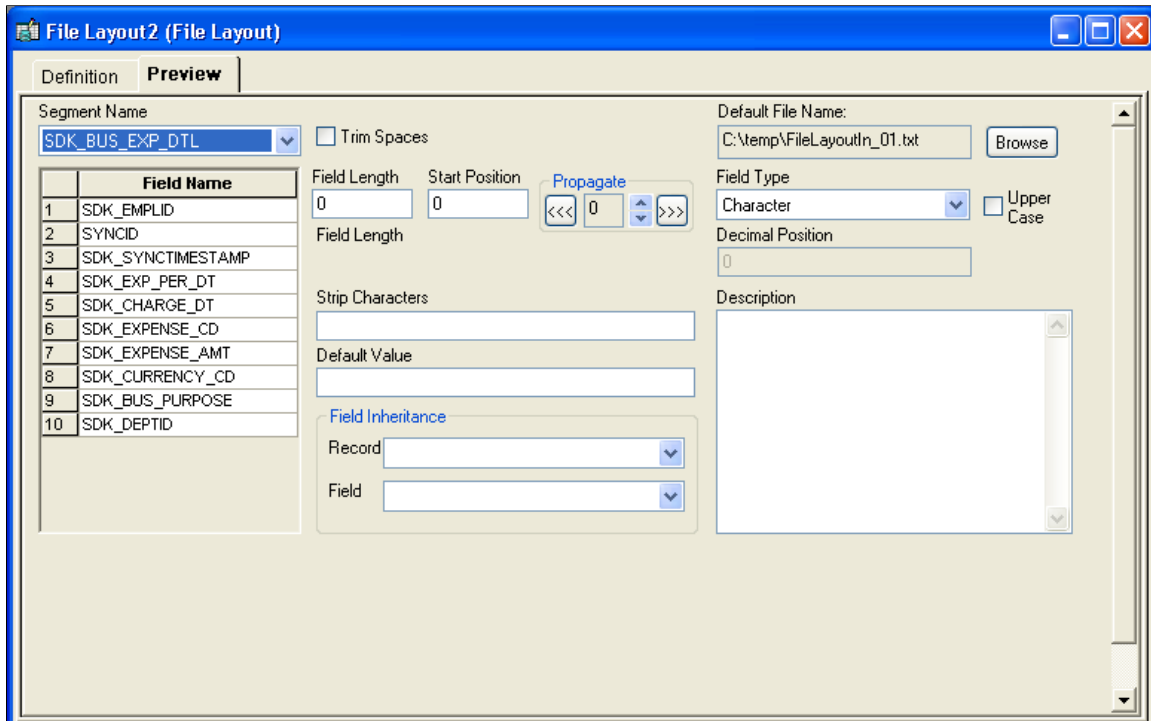

The Preview tab displays no information initially.

---

**Note:** With an XML file, you cannot preview the data, although you can generate and run an import program.

---

To preview input data:

1. Click Browse and select the import file.

The name of the import file appears in the Default File Name text box.

2. Select a file layout segment from the Segment Name drop-down list box.

The file layout fields corresponding to the selected segment appear in the list below the segment name. This list comes from the file layout definition, and it does not depend on your selecting a valid import file.

3. Click the Refresh button on the toolbar to refresh the preview data.

At the bottom of the window, the first five rows of the selected segment in the selected import file are available for preview in the grid.

You can also select **View > Automatically Read Preview Data**. While this menu item is selected, the file layout refreshes the preview automatically; when it is cleared, you need to click the **Refresh Preview Data** button to see the effects of changes you make to the property settings or data.

---

**Note:** Preview file data is available only for FIXED and CSV file layouts. The preview data appears only if you selected an import file, if the file format matches the format specified for the file layout definition, and if it contains a file record ID that matches the file record ID of the selected segment.

---

4. Select one of the fields in the Field Name list box.

The properties of the field that you select appear in the appropriate display fields. These properties are actually the file layout field properties of the field; you can change all field property settings from this view.

---

**Note:** Only the field properties that are appropriate to the file layout format that you specified in the File Layout Definition Properties dialog box are visible in this view. For example, the Start Position and Field Length fields are available only for a FIXED format file layout.

---

## Examining the Input Data for Errors

The following table shows examples of input data errors:

<b>Symptom</b>	<b>Possible Reason</b>	<b>Solution</b>
The preview grid does not appear.	The input file format does not match the file layout format that you specified in the File Layout Definition Properties dialog box.  A CSV file does not use the definition qualifier you specified in the File Layout Definition Properties dialog box.	Change the file layout format to match the input file format.  Change the definition qualifier to match the one used in the input file.
Only the first column of the preview grid is populated.	A CSV file does not use the definition delimiter you specified in the File Layout Definition Properties dialog box.	Change the definition delimiter to match the one used in the input file.
The preview grid appears for some records but not for others.	The record IDs of the file for the missing records do not match the file record IDs specified in the File Layout Segment Properties dialog box.	Specify file record IDs that match the input file records.
Data for a field appears truncated in the preview grid.	With a FIXED file, the field length that you specified in the File Layout Field Properties dialog box is too short to accommodate the field data.	Increase the field length to accommodate the input data.

<b>Symptom</b>	<b>Possible Reason</b>	<b>Solution</b>
A field appears to start in the middle of the data.	With a FIXED file, the start position that you specified in the File Layout Field Properties dialog box is too great to include the start of the field data.	Decrease the start position and adjust the field length to match the input data start position and length.

## Generating and Running the Import Program

This part of the process imports the file data.

To generate and run the import program:

1. After you preview the file layout and review the input data, click the AE button on the toolbar.

The system generates the Application Engine import program with its associated import PeopleCode.

2. Enter a name for the Application Engine program and click OK.

The system automatically saves the program, which is ready to run as soon as its definition appears in PeopleSoft Application Designer.

3. Click the Run Program button on the toolbar.

The database imports the file data.

## Exporting Data

The method that you use to export data from the PeopleSoft system depends on the requirements of the target application. To export data to a flat file, you create a file layout definition and then write PeopleCode to transfer the data to a file. You can initiate the PeopleCode from the Application Engine or from any event. It should populate text strings, rowset objects, or record objects, and it should apply the WriteRecord or WriteRowset method from the File class to transfer the data to the file by using the file layout definition to position the records and fields as required by the target application.

---

**Note:** To generate valid XML files, be sure to use the Close method in the File class when you finish writing to the file.

---



---

**Important!** As is the case with imports, the completed file layout that you use to export the data must have exactly one file record at the root level; all other file records must be below that level.

---

### Related Links

"Understanding File Layout" (PeopleTools 8.58: PeopleCode API Reference)

---

## Producing Sample File Layouts

This section discusses how to:

- Create file layout definitions.

- Adjust file layout properties.
- Insert segments and fields.

## Creating File Layout Definitions

The following example shows how to create a file layout to be used with the QE\_ABSENCE\_HIST record:

### Image: QE\_ABSENCE\_HIST record definition

This example illustrates the fields and controls on the QE\_ABSENCE\_HIST record definition. You can find definitions for the fields and controls later on this page.

Num	Field Name	Type	Len	Format	Short Name	Long Name
1	QE_EMPLID	Char	11	Upper	ID	EmplID
2	QE_ABSENCE_TYPE	Char	3	Upper	Type	Absence Type
3	QE_BEGIN_DT	Date	10		Begin Date	Begin Date
4	QE_RETURN_DT	Date	10		Return Dt	Return Date
5	QE_DURATION_DAYS	Nbr	3		Days	Duration (Days)
6	QE_DURATION_HOURS	Nbr	1.1		Hours	Duration (Hours)
7	QE_REASON	Char	30	Mixed	Reason	Reason
8	QE_PAID_UNPAID	Char	1	Upper	Paid/Unpd	Paid/Unpaid
9	QE_EMPLOYER_APPROV	Char	1	Upper	Approved	Employer-Approved
10	QE_COMMENTS	Long	0		QE_COMMENTS	QE_COMMENTS

For simplicity, suppose that each row in the FIXED format file has the following structure:

```

888 A
000 8001 VAC 1981-09-12 1981-09-26 14 .0 P Y
888 A
000 8001 VAC 1983-03-02 1983-03-07 5 .0 P Y
888 A
000 8001 VAC 1983-08-26 1983-09-10 13 .0 P Y
888 A
000 8516 MAT 1986-06-06 1986-08-01 56 .0 P Y
888 C
000 8516 SCK 1988-08-06 1988-08-07 1 .0 P Y
888 A
000 8516 VAC 1987-07-14 1987-07-28 14 .0 P Y
888 A
000 8553 JUR 1990-12-12 1990-12-17 5 .0 Local Jury Duty P N
888 A
000 8553 MAT 1992-02-20 1992-10-01 224 .0 Maternity Leave U N
888 A
000 8553 MAT 1994-08-19 1995-03-01 194 .0 Maternity U Y
888 A
000 8553 PER 1993-04-15 1993-04-19 4 .0 U N Personal
Day required
888 C
000 8553 SCK 1987-01-28 1987-01-30 2 .0 Hong Kong Flu P N
888 A
000 8553 SCK 1988-08-02 1988-08-03 1 .0 Sick P N
888 A
000 8553 SCK 1995-09-12 1995-09-13 1 .0 P N
888 C
000 G001 MAT 1991-07-02 1991-09-28 88 .0 3-month Maternity P Y Maternity will
be paid as 80% of Claudia's current salary.
    
```



000 is the file record ID for ABSENCE\_HIST, and each field appears in the same order as in the ABSENCE\_HIST database record. 888 is the file record ID for an extra segment called CHANGE\_ACTION, which contains an AUDIT\_ACTION field with the following meanings:

- A: Row inserted.
- C: Row updated, but no key fields changed.

---

**Note:** The end of file (EOF) character must be on a separate line and not on a line containing data for any incoming file, regardless of the file type. Each data line needs to be terminated with an end of line (EOL) character, which is different than an EOF character.

---

To create a file layout definition:

1. Use the QE\_ABSENCE\_HIST record definition as the template for the file layout.

Create a new file layout and then drag the QE\_ABSENCE\_HIST record into the open file layout.

2. Save the file layout with the name ABS\_HIST.

The name of the first node changes from NEW FILE to ABS\_HIST.

## Adjusting File Layout Properties

In the file layout definition, open the file layout, record, or field properties as appropriate for each step in the following procedure.

To adjust file layout, record, and field properties:

1. Change the file layout properties.
  - a. Double-click the topmost node in the file layout, ABS\_HIST, to display the file layout properties.
  - b. Enter a short and long description of the file layout you are creating. For this example, you are creating a FIXED file layout, so you do not need to make any changes on the Use tab.

2. Change the file record properties.

- a. Double-click the QE\_ABSENCE\_HIST file record to display its properties. Enter a record ID of 000, and a starting position of 1. The ID length is automatically set.

When you click OK, you see a message asking if you want to increment the start positions for all fields.

- b. Click Yes to automatically increment the start position numbers for every field to take the length of the file record ID that you just added into account. If you do not click Yes, you must manually increment the start position for all fields.

You just created the file record ID for the QE\_ABSENCE\_HIST record:

```
000 8001      VAC  1981-09-12 1981-09-26 14  .0      P Y
000 8001      VAC  1983-03-02 1983-03-07 5   .0      P Y
```

3. Change the file field properties.

When a record definition is used as a template for a file layout, the default starting position for each field is based on the order in which it appears in the record as well as its length.

- a. Double-click the QE\_EMPLID file field to display its properties.

The start position is automatically set to 4 because the file record ID is 3 characters long. However, in the example, an extra space is between the end of the file record ID and the first field. Therefore, you need to change the start position of this field and all of the fields that follow this field to increment the starting position of this field and all fields following this field by 1. To do this:

- b. Click the up arrow under Propagate to change that number from 0 to 1.
  - c. Click the button with the arrows pointing right (>>>).
4. (Optional) Adjust other fields.

The last field (QE\_COMMENTS) has a length of 0 because it is based on a Long field type.

---

**Note:** When a Long field type is inserted into a file layout, the system converts it to a Character field type with a length of 0.

---

Because the format for this file layout is FIXED, you have to change the field length of that file field so that it is long enough to accommodate the data that you expect from the file.

You do not have to propagate this change because this is the last field in the record.

## Inserting Segments and Fields

Open the file layout definition based on the ABS\_HIST record:

**Image: File layout with new segment and field added**

This example illustrates the fields and controls on the File layout with new segment and field added. You can find definitions for the fields and controls later on this page.

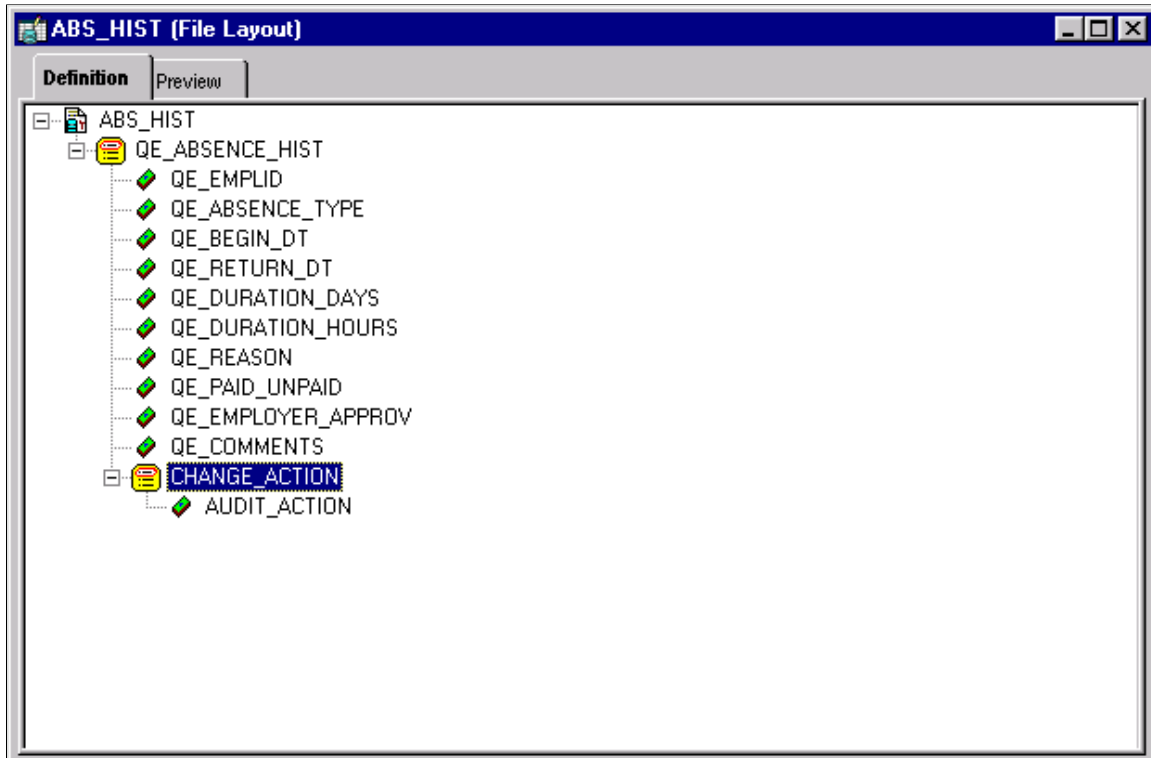

---

**Note:** You will insert a segment that is a sibling, that is, it has the same level as the QE\_ABSENCE\_HIST record.

---

To insert a segment and then a field into that segment:

1. Select Insert Segment from the pop-up menu or select Insert > Segment to insert a segment.

The Insert New Segment dialog box appears. This dialog box is identical to the File Layout Segment Properties dialog box.

2. On the Insert New Segment dialog box:
  - a. Enter the file record name, file record ID, and ID start position.
  - b. Click the OK button to insert the segment.

---

**Note:** If you provide a Record File ID when adding a segment to a file layout that is either CSV or FIXED, the system prefixes this Record File Id to every row of data that is written.

---

3. Insert a file field.
  - a. Select Insert FileField from the pop-up menu.

The Insert New Field dialog box appears. It is identical to the File Layout Field Properties dialog box.

- b. Enter a field name, start position, and field length, and then click the OK button.

---

**Note:** The start position is not automatically set when you add a file field to the file record. For this example, the AUDIT\_ACTION field requires a start position of 5.

---

4. Select File, Save, or click the save icon in the toolbar to save your changes to the file layout.

Now that you have created and saved a file layout, you must use PeopleCode to access the data. File layouts rely solely on PeopleCode as the engine behind the actual data access and movement.

### **Related Links**

"Understanding File Layout" (PeopleTools 8.58: PeopleCode API Reference)

## Chapter 18

# Using Change Control

---

## Understanding Change Control Features

The Change Control feature has three main functions to help you manage and track development. You can enable one or all of these functions to control how much access each user has to the Change Control commands.

This section discusses:

- Change Control locking
- Change Control history
- Change Control stamping

### Change Control Locking

Change Control locking is keyed by PeopleSoft user IDs. When a definition is locked, it cannot be modified by anyone other than the user ID who locked it, and it can be unlocked only by that same user or by a Change Control administrator.

A locked definition is identified by:

- A small padlock icon above the definition in the project workspace (development view) of PeopleSoft Application Designer.
- The user ID of the person who locked the definition, which appears next to the name of the definition.

Your user ID does not appear for definitions that you locked.

For example, the following icons seen in the project workspace display two locked and one unlocked record definitions:

#### Image: Locked and unlocked record icons

The following icons shown in the below project workspace image display two locked and one unlocked record definitions

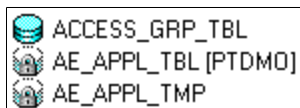

The top record is unlocked; the middle record is locked by another user ID (PTDMO), and the bottom record (with no ID displayed) is locked by you, the current user.

---

**Note:** Standard Change Control locking is supported only for definitions that you can modify with PeopleSoft Application Designer. Other PeopleSoft definitions can be added to a project for upgrading, but they cannot be locked by developers. If you are a Change Control administrator, you can lock all upgradable database definitions, both PeopleSoft Application Designer development definitions and other types. However, for non-PeopleSoft Application Designer definitions, this action prevents unauthorized upgrading only, not unauthorized development.

---

## Locking Projects

With Change Control, projects are treated like all other PeopleSoft Application Designer definitions: you must lock them before you can modify them. However, locking a project does not lock the definitions in the project, and modifying a definition in a project does not modify the project itself.

A project definition includes a name and a list of definitions. When you lock a project definition, other users cannot add or remove definitions from the project, and they cannot rename or delete the project. However, locking does not restrict access to the definitions that are named in the project definition. Likewise, modifying a definition has no effect on the definition of any project to which the definition might belong.

---

**Note:** PeopleSoft Application Designer provides an option to load the last open project on startup. If this option is enabled on your machine and Change Control locking is activated, you might receive an *open in read-only mode?* message at startup if you had not locked the project before or if someone else has the project locked. In either case, you can open the project in read-only mode. Remember, locking does not restrict your access to definitions in the project.

---

## Locking Compared to Version Control

Change control locking is not the same as version control. With a version control system, you check out a copy of a definition and make your changes to the copy. After you check in the changed version, you can always undo your changes. This is not the case with change control locking.

Locking a definition prevents other users from modifying it. However, any changes that you save are written directly to the database, overlaying or replacing the existing definition. You cannot restore a previous version of a definition.

## Locking and Upgrades

When preparing to upgrade a database, all development *must* cease in the source database to assure that the Compare process works with a static environment. It also assures that changes are not made to any definitions between the time that you set the upgrade defaults and the time that you copy the definitions.

You can freeze all development by using the Change Control Administrator dialog box to lock all database definitions. When the upgrade is done, use the same dialog box to unlock all definitions. However, be aware that this action *permanently* removes all previous lock settings from all definitions. Developers have no way of resetting their locks except by manually relocking. When you lock definitions in this way, it is not reflected in the Locked Objects dialog box or in the project workspace. If a developer has unsaved changes when you lock all definitions, the developer cannot save those changes.

For all of these reasons, you must inform developers that you plan to lock all definitions and you must give them time to save their changes, perhaps even to view the Locked Definitions dialog box and print the screen.

Locking definitions with the Change Control Administrator dialog box does not actually mark every definition as locked. Instead, it adds a single row at the top of the locking table. The presence of this row indicates to the system that full database locking is in effect, and it stores the user ID of the administrator who enabled the locking.

Full database locking also plays a role in the target database during the upgrade copy process. During a copy, the system always checks the locking status of the target database definitions to see if they are locked and by whom. If they were locked by a user ID other than the one performing the copy, then those definitions are not modified.

In major upgrades, checking the locking status of each definition before copying severely affects performance. To prevent this, use the Change Control Administrator dialog box to lock all target database definitions before copying. During the copy process, if the entire target database is locked, the system verifies that the user ID performing the copy process is the same user ID that locked the database. If these conditions are true, the system assumes that it was locked for the purpose of the upgrade and that it can safely copy all definitions without checking each one individually.

---

**Note:** When you copy a project, the system does not check the locking status of the definitions in the source database. However, you should keep your definitions locked until the copy is complete.

---

## Change Control History

When Change Control history is enabled, you can enter comments about the modifications that you made to PeopleSoft Application Designer development definitions. History entries contain a common set of information, including who created the entry, when, and the type of action that is associated with the entry. For example, when a user locks a definition, a history entry is automatically created containing the user ID, the date and time, and an action value of Add. This entry can also contain a project name, incident ID, and comment.

### Automated History Prompting

Although you can always insert history entries manually, in many situations PeopleSoft Application Designer automatically inserts history entries and prompts you for comments. In special circumstances, the system adds entries without a prompt. For example, an action history provides some idea of what has happened to a definition, even if no comments were entered. This table describes possible action entries:

<b>Action Entry</b>	<b>Description</b>
Lock and Unlock	Whenever a definition is locked or unlocked, you are automatically prompted for a comment, after which a Lock or Unlock action entry is added to the definition history.

<b>Action Entry</b>	<b>Description</b>
Rename	<p>When you rename a definition, you are prompted for a comment, after which a Rename action entry is added to the definition history. The system provides a default comment of &lt;name1&gt; renamed to &lt;name2&gt;:</p> <ul style="list-style-type: none"> <li>• &lt;name1&gt; is the previous name of the definition.</li> <li>• &lt;name2&gt; is the new name that you gave it.</li> </ul> <hr/> <p><b>Note:</b> If the definition is locked when you try to rename it, the system unlocks it before renaming it and then relocks it afterward. In this case, three history entries are added: one for unlocking, one for renaming, and one for relocking.</p>
Delete	<p>When you delete a PeopleSoft Application Designer definition, its history is retained. During the deletion, PeopleSoft Application Designer prompts you to add a final comment into the definition history, after which a Delete action entry is added to the definition history.</p> <hr/> <p><b>Note:</b> If Change Control locking is enabled, you can only delete locked definitions. After a locked definition is deleted, it is automatically unlocked and an Unlock action history entry is added. You are not prompted for comments for this unlock event.</p>
Add	<p>When you create a new definition, PeopleSoft Application Designer creates a history entry with an Add action. You are not prompted for comments.</p>
Copy	<p>If Change Control history is enabled in the target database when you perform an upgrade copy, a Copy action entry is inserted into the histories for any added, replaced, or deleted definitions. You are not prompted for comments.</p>

## History and Upgrades

Change Control history is not copied along with its associated definition during an upgrade. However, if history is enabled in the source database, then the history of each affected target definition is updated with a comment noting when the copy was performed and by whom.

This history updating occurs in the background for all target definitions that are affected by the copy process, even non-PeopleSoft Application Designer definitions with histories that you cannot update or view, regardless of whether Change Control history is enabled in the source database.

## Change Control Stamping

Change Control stamping is always in effect, regardless of whether locking and history are also enabled. For every definition in the database, PeopleTools maintains a last updated stamp, which denotes the date



and time of the last update and the user ID of the person who saved the definition. When a PeopleSoft application delivers a new database, all of the definitions are stamped with a PeopleSoft proprietary ID: PPLSOFT.

## Stamping and Upgrades

Change Control stamping provides critical information during an upgrade comparison. Because the system tracks the user ID of whoever last changed each definition, you can easily identify your adaptations. (Any definition that is stamped with a user ID that is not the PeopleSoft proprietary ID is considered an adaptation.) Whether you made an adaptation before or after the last update is irrelevant; the adaptation is always identified as such.

During a comparison, definitions that you last modified are given a status of Custom Changed (if you have changed them since the compare date) or Custom Unchanged (if you have not changed them since the compare date). PeopleSoft-modified definitions are given a status of either Changed or Unchanged.

---

## Understanding Implementation Considerations

When deciding how to implement Change Control, consider:

- The level of development control that you want to maintain.
- The amount of freedom that developers need.
- The security requirements of the site.

<b>How to Implement</b>	<b>Advantage</b>	<b>Disadvantage</b>
Individual Control	For maximum control of the development environment, use both locking and history, and assign each developer a unique user ID. Then, definitions can be modified by only one developer (user ID) at a time, and developers are always prompted for comments when they lock and unlock definitions.	Developers can share ownership of their definitions only by unlocking them after each change.
Group Control	For flexibility, use locking and history, but assign developers who work on the same project a common ID. Then, developers can share definitions with other members of their group, but not with members of other groups. Administering security is also easier, because you have fewer user IDs to maintain.	The protection from simultaneous development of definitions is decreased. History is harder to track unless developers always include their names in their comments.
History Only	Provides the least restricted Change Control environment. In this situation, all developers can share all definitions.	Developers are not automatically prompted for comments. They can all share the same ID. If you have a very small development team, this option might be good.

## Understanding Change Control Information Reporting

Currently, no predefined reports for retrieving Change Control information are available. However, you can create your own reports by querying the Change Control tables.

The two tables that you can use for reporting are the Change Control History table (PSCHGCTLHIST) and the Change Control Locking table (PSCHGCTLLOCK). These tables have an almost identical column structure:

### Image: Structure of PSCHGCTLHIST

This example illustrates the fields and controls on the Structure of PSCHGCTLHIST. You can find definitions for the fields and controls later on this page.

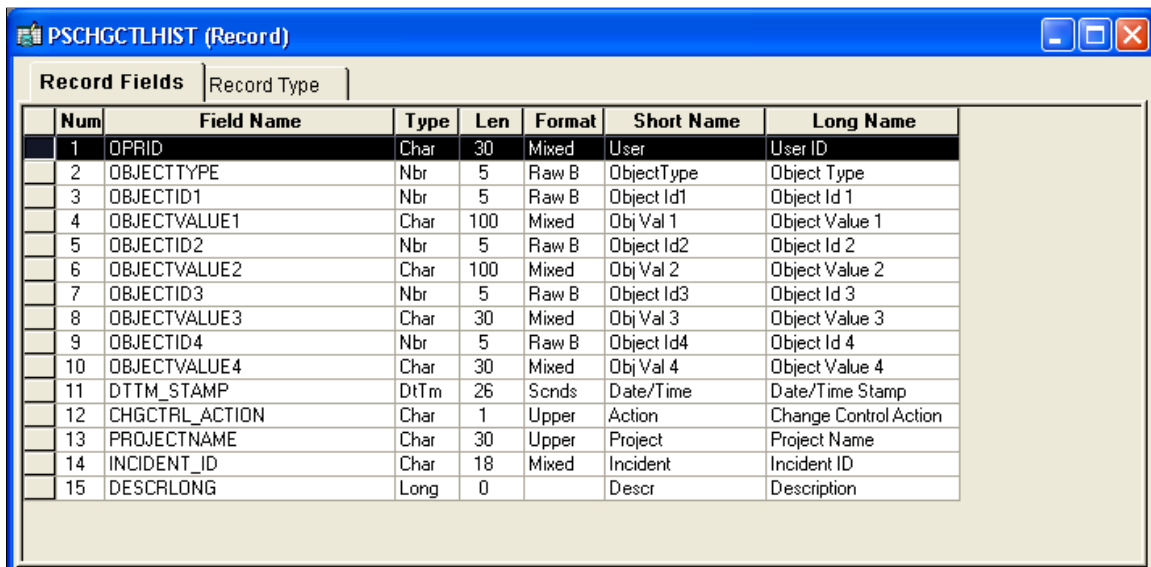

The screenshot shows a window titled "PSCHGCTLHIST (Record)" with a "Record Fields" tab selected. The window displays a table with the following columns: Num, Field Name, Type, Len, Format, Short Name, and Long Name. The table contains 15 rows of field definitions.

Num	Field Name	Type	Len	Format	Short Name	Long Name
1	OPRID	Char	30	Mixed	User	User ID
2	OBJECTTYPE	Nbr	5	Raw B	ObjectType	Object Type
3	OBJECTID1	Nbr	5	Raw B	Object Id1	Object Id 1
4	OBJECTVALUE1	Char	100	Mixed	Obj'Val 1	Object Value 1
5	OBJECTID2	Nbr	5	Raw B	Object Id2	Object Id 2
6	OBJECTVALUE2	Char	100	Mixed	Obj'Val 2	Object Value 2
7	OBJECTID3	Nbr	5	Raw B	Object Id3	Object Id 3
8	OBJECTVALUE3	Char	30	Mixed	Obj'Val 3	Object Value 3
9	OBJECTID4	Nbr	5	Raw B	Object Id4	Object Id 4
10	OBJECTVALUE4	Char	30	Mixed	Obj'Val 4	Object Value 4
11	DTTM_STAMP	DtTm	26	Scnds	Date/Time	Date/Time Stamp
12	CHGCTRL_ACTION	Char	1	Upper	Action	Change Control Action
13	PROJECTNAME	Char	30	Upper	Project	Project Name
14	INCIDENT_ID	Char	18	Mixed	Incident	Incident ID
15	DESCRLONG	Long	0		Descr	Description

The main difference between these two tables is that PSCHGCTLHIST contains a CHGCTRL\_ACTION field, while PSCHGCTLLOCK does not.

Each PeopleSoft definition in these tables is uniquely identified by numeric codes (DEFINITIONID columns) and names (DEFINITIONVALUE columns). The different DEFINITIONID and DEFINITIONVALUE column pairs correspond to the various definition key types and values for each kind of definition. You can see these definition keys when you view the upgrade definition window. For example, translate values have these keys—Field Name, Field Value, and Effective Date, as in this example:

### Image: Viewing definition keys

This example illustrates the fields and controls on the Viewing definition keys. You can find definitions for the fields and controls later on this page.

Translate Values Key								
	Field Name	Field Value	Effective Date	Source	Target	Action	Upgrade	Done
1	AE_ABEND_ACTION	A	1900-01-01	Unknown	Unknown	Copy	<input checked="" type="checkbox"/>	<input type="checkbox"/>
2	AE_ABEND_ACTION	B	1900-01-01	Unknown	Unknown	Copy	<input checked="" type="checkbox"/>	<input type="checkbox"/>
3	AE_ABEND_ACTION	I	1900-01-01	Unknown	Unknown	Copy	<input checked="" type="checkbox"/>	<input type="checkbox"/>
4	AE_ABEND_ACTION	S	1900-01-01	Unknown	Unknown	Copy	<input checked="" type="checkbox"/>	<input type="checkbox"/>
5	AE_ACTIVE_STATUS	A	1900-01-01	Unknown	Unknown	Copy	<input checked="" type="checkbox"/>	<input type="checkbox"/>
6	AE_ACTIVE_STATUS	I	1900-01-01	Unknown	Unknown	Copy	<input checked="" type="checkbox"/>	<input type="checkbox"/>
7	AE_ADJUST_STATU	A	1900-01-01	Unknown	Unknown	Copy	<input checked="" type="checkbox"/>	<input type="checkbox"/>
8	AE_ADJUST_STATU	D	1900-01-01	Unknown	Unknown	Copy	<input checked="" type="checkbox"/>	<input type="checkbox"/>
9	AE_ADJUST_STATU	M	1900-01-01	Unknown	Unknown	Copy	<input checked="" type="checkbox"/>	<input type="checkbox"/>
10	AE_ADJUST_STATU	X	1900-01-01	Unknown	Unknown	Copy	<input checked="" type="checkbox"/>	<input type="checkbox"/>

In the Change Control tables, the row containing the first translate value in the preceding example has the following field values:

<i>DEFINITIONVALUE1</i>	<i>DEFINITIONVALUE2</i>	<i>DEFINITIONVALUE3</i>
AE_ABEND_ACTION	A	1900-01-01

When reporting on a particular definition type, you want to retrieve definition values, but you must limit the query by using the definition IDs for the definition type. The following tables list all of the upgradable definition types, their corresponding definition ID codes, and the type of value that each ID represents (in parentheses).

## PeopleTools Definition Types

This table lists PeopleTools definition types and their definition IDs:

<i>Definition Type</i>	<i>DEFINITIONID1</i>	<i>DEFINITIONID2</i>	<i>DEFINITIONID3</i>	<i>DEFINITIONID4</i>
Access Groups	17 (name)	0	0	0
Activities	18 (name)	0	0	0
Application Engine Programs	66 (name)	Not applicable (NA)	NA	NA
Application Engine Sections	66 (name)	77 (section)	NA	NA
Application Package	104 (name)	NA	NA	NA
Approval Rule Sets	85 (name)	21 (effective date)	NA	NA
Business Interlink	64 (name)	NA	NA	NA
Business Processes	7 (name)	NA	NA	NA

<b>Definition Type</b>	<b>DEFINITIONID1</b>	<b>DEFINITIONID2</b>	<b>DEFINITIONID3</b>	<b>DEFINITIONID4</b>
Colors	19 (name)	25 (user ID)	0	0
Components	10 (name)	39 (market)	NA	NA
Component Interfaces	74 (name)	NA	NA	NA
Cube Definitions	54 (name)	55 (description)	NA	NA
Cube Instance Definitions	56 (name)	57 (description)	NA	NA
Dimensions	51 (name)	52 (dimension type)	53 (description)	0
Fields	6 (name)	0	0	0
Field Formats	23 (family name)	0	0	0
File Layout Definitions	71 (name)	NA	NA	NA
HTML	90 (name)	95 (type)	NA	NA
Images	91 (name)	95 (type)	NA	NA
Indexes	1 (name)	24 (index ID)	0	0
Job Definitions	27 (name)	NA	NA	NA
Menus	3 (name)	0	0	0
Message Catalog Entries	48 (message set number)	48 (message number)	16 (language code)	50 (description)
Message Channels	61 (name)	NA	NA	NA
Message Definitions	60 (name)	NA	NA	NA
Mobile Page	111 (name)	NA	NA	NA
<b>Important!</b> PeopleSoft Mobile Agent is a deprecated product. These features exist for backward compatibility only.				
Message Nodes	62 (name)	NA	NA	NA
Pages	9 (name)	NA	0	0
PeopleCode	See PeopleCode Definition Types	NA	NA	NA
Problem Type	109 (name)	NA	NA	NA

<b>Definition Type</b>	<b>DEFINITIONID1</b>	<b>DEFINITIONID2</b>	<b>DEFINITIONID3</b>	<b>DEFINITIONID4</b>
Process Definitions	29 (process type)	28 (name)	0	0
Process Type Definitions	29 (name)	26 (operating system)	20 (database type)	NA
Project	255 (name)	NA	NA	NA
Queries	30 (name)	25 (user ID)	0	0
Records	1 (name)	2 (RecField name)	0	0
Recurrence Definitions	31 (name)	NA	NA	NA
Roles	32 (name)	0	0	0
Server Definitions	33 (name)	NA	NA	NA
SQL	65 (name)	81 (SQL type)	NA	NA
Styles	35 (name)	0	0	0
Style Sheets	94 (name)	NA	NA	NA
Translate Values	6 (database field name)	22 (value)	21 (effective date)	NA
Trees	34 (setID)	68 (user key value)	36 (tree name)	21 (effective date)
Tree Structures	37 (name)	0	0	0

## PeopleCode Definition Types

This table lists PeopleCode definition types and their definition IDs:

<b>Definition Type</b>	<b>DEFINITIONID1</b>	<b>DEFINITIONID2</b>	<b>DEFINITIONID3</b>	<b>DEFINITIONID4</b>
Application Engine	66 (PeopleSoft Application Engine program)	77 (section, market, database type, effective date)	78 (step)	12 (method)
Application Package	104 (application package)	NA	NA	NA
Component Interface	74 (business component)	12 (method)	NA	NA
Menu	3 (menu)	4 (bar)	5 (item)	12 (method)
Message	60 (message)	12 (method)	NA	NA
Page	9 (panel)	16 (language code)	12 (method)	NA
Page Field	9 (panel)	16 (language code)	67 (field)	12 (method)

<b>Definition Type</b>	<b>DEFINITIONID1</b>	<b>DEFINITIONID2</b>	<b>DEFINITIONID3</b>	<b>DEFINITIONID4</b>
Component	10 (panel group)	39 (market)	12 (method)	NA
Component Record	10 (panel group)	39 (market)	1 (record)	12 (method)
Component Record Field	10 (panel group)	39 (market)	1 (record)	2 (fieldname, method)
Record	1 (record)	2 (field)	12 (method)	NA
Subscription	60 (message)	87 (subscription)	12 (method)	NA

## Change Control Supported Definition Types

These are the supported definition types for change control:

- Activity
- Application Engine Program
- Application Package
- Approval Rule Set
- Business Interlink
- Business Process
- Component
- Component Interface
- Field
- File Layout
- HTML
- Image
- Menu
- Message
- Message Channel
- Problem Type
- Page
- Project
- Record
- SQL

- Style Sheet

When reporting on Change Control history, consider one other field: CHGCTRL\_ACTION. This field stores the one-letter code for the various actions that Change Control history tracks:

- A (Add)
- C (Copy)
- D (Delete)
- I (Informational)
- L (Lock)
- R (Rename)
- U (Unlock)

Here's an example of a SQL query to report on all deleted definitions:

```
select oprid, definitionvalue1, definitionvalue2,
definitionvalue3, definitionvalue4, dtm_stamp, projectname,
incident_id, descrlong
from pschgctlhist
  where chgctrl_action = 'D'
  order by oprid, definitionvalue1
```

---

**Note:** Full history tracking is supported only for PeopleSoft Application Designer definitions: business processes, business process maps, fields, menus, panels, panel groups, projects, and records. Other definition types have history entries only when the CHGCTL\_ACTION field value is C, and only if they have been upgraded.

---

## Setting Up Change Control

This section provides an overview of Change Control security and discusses how to:

- Appoint a Change Control administrator.
- Enable or disable Change Control.

## Understanding Change Control Security

Using the Security component, you can assign users one of three Change Control access levels, depending on how much authority you want them to have. This table describes the available access levels:

<i>Change Control Access Level</i>	<i>Description</i>
Restricted access	Restricts users from locking or unlocking definitions. When Change Control locking is enabled, users with restricted access can open PeopleSoft Application Designer development definitions in read-only mode only. Users are also unable to view or update definition histories.

<b>Change Control Access Level</b>	<b>Description</b>
Developer access	Allows users to lock any unlocked definitions and to unlock any definitions that they have locked. They can then manipulate definitions as they are allowed to in their security profile. Users can also view and enter definition history comments.
Supervisor access	Allows users to unlock any locked definitions, regardless of who locked them. They can also access the Change Control Administrator dialog box, in which you lock and unlock all definitions at one time and enable and disable Change Control locking and history.

If Change Control locking is disabled, these access levels have no security value. If history is disabled, users with developer and supervisor access can still view the History dialog box, but users with restricted access cannot.

Remember that Change Control is based on user ID. If developers all share the same user ID, then Change Control offers no advantage in control because each developer can modify definitions that are locked by others.

## Appointing a Change Control Administrator

Appoint Change Control administrators by giving certain users supervisor-level access to Change Control. When users have this access level, they can enable and disable Change Control.

See "Setting PeopleTools Permissions" (PeopleTools 8.58: Security Administration).

## Enabling or Disabling Change Control

To enable or disable Change Control:

1. In PeopleSoft Application Designer, select Tools > Change Control > Administrator.

The Change Control Administrator dialog box appears.

2. Specify the System Wide Options and access control:

**Use change control locking**

Select to require that PeopleSoft Application Designer definitions be locked before they can be modified.

**Use change control history**

Select to enable PeopleSoft Application Designer developers to insert comments about open definitions.

If both Use change control locking and Use change control history check boxes are selected, developers are prompted for comments when locking and unlocking definitions.

---

**Note:** Because these are system-wide settings, if you change them all users must log off and on again for the changes to take effect.

---



**Lock all definitions**

Select or deselect to lock or unlock all definitions in the database. Usually, you lock all definitions only before a major upgrade, because it permanently removes all individual developer locks.

---

## Using Projects

This section provides an overview of projects and discusses how to:

- Use multiple databases for development.
- Use distributed development environments.

## Understanding Projects

You can use all levels of Change Control with or without also using projects. If you decide not to use projects, you rely on the Locked Objects dialog box, rather than the project workspace, to identify locked definitions. The dialog box provides a better overall view of locking status because it shows all of the PeopleSoft Application Designer definitions in the database, not just those in the current project.

Use projects to track the definitions that are changed as part of a change or feature request. This set of definitions is commonly referred to as the change set. The Options dialog box has an option to insert a definition into a project when it is modified and saved. If you start with an empty project, this option provides an easy way of tracking the change set for this incident. When the change request is completed, the project contains everything that is associated with the change. You should also use the Comments field in the Project Properties dialog box to list any external definitions, like COBOL or Structured Query Report (SQR) modules, that must be migrated with this change.

## Using Multiple Databases for Development

Managing change in a single database environment is straightforward, but very few PeopleSoft users operate in a single database environment. The classic development model uses three databases: development, test, and production. You apply all changes to the development database. After you unit-test the change, migrate the change set to the test database, where it goes through more rigorous testing. Usually, you would run one or more regression test suites to ensure that you resolve the issue that you intended to resolve with no unwelcome side effects. Finally, that change set is migrated into the production database. If you find a problem at any stage in the process, the incident is sent back to development and the process begins again.

This model assumes that the development database is the master database. You can use the Change Control locking feature to lock down the modules on which you and other developers are working. When developers complete the changes in the development database, they notify the Change Control administrator and use the upgrade copy facility to copy the change set into the test environment. As long as you use the technique that is described previously in this section, the project should contain the entire change set. The system tracks all of the documentation for the change in the development database. The only information that appears in the test and production databases is a history line indicating it was copied. Definitions move only in one direction in this model: from development to test, then from test to production.

---

**Note:** The only case in which you can copy a definition back to development from either test or production is if a problem must be recreated and another change was already made to the affected definition. Do this with extreme care because upgrade copies are destructive and cannot be undone if you discover that you overlaid another developer's change. For this reason, you should apply changes directly to test or production databases only rarely.

---

**Note:** This Change Control model is just one that you can use. We provide it to give you an idea of how you can implement Change Control in your environment. While you do not need to follow this model exactly, you should implement a Change Control model that enables you to track changes to the system and prevent developers from overwriting each other's changes.

---

## Using Distributed Development Environments

You should use a master development database even if each development team works on its own copy of the database. Developers should lock down the definitions on which they intend to work in the master development database, and then copy those modules to their private databases. This method ensures that no other developer makes a change to those definitions while they are checked out.

When a developer is ready to copy changes back to the master development database, you check the Change Control history of the locked definitions in the master development database. Do this before using upgrade copy to migrate them back, just in case a Change Control administrator has overridden a lock and made a change while the definitions were checked out.

---

**Note:** Change Control administrators should always notify the developer who has a lock on a definition before they override to avoid unexpected surprises later.

---

---

## Using Change Control

This section discusses how to:

- Lock and unlock definitions.
- View locked definitions.
- Insert comments.
- Delete page definitions.
- View Change Control history.

## Locking and Unlocking Definitions

You can lock and unlock definitions manually. You can also have PeopleSoft Application Designer lock unlocked definitions for you each time that you open them.

You must have developer or supervisor access to Change Control to lock and unlock definitions. If you have supervisor access, you can also lock all definitions at once, which can be helpful when performing upgrades to ensure that definitions are not modified in the middle of the process.

This section discusses how to:

- Lock or unlock an unopened definition in the current project.
- Unlock an unopened definition that is not in the current project.
- Lock or unlock an open definition.
- Lock definitions automatically when you open them.
- Lock or unlock all definitions at once.

## Locking or Unlocking an Unopened Definition in the Current Project

To lock or unlock an unopened definition in the current project:

1. In the project workspace, select the Development tab at the base of the workspace window to activate the development view.
2. Select the definitions that you want to lock or unlock.
3. Right-click any of the selected definitions and select Lock Definition or Unlock Definition.

## Unlocking an Unopened Definition Not in the Current Project

To unlock an unopened definition that is not in the current project:

1. Select Tools > Change Control > View Locked Definitions.

The Locked Definitions dialog box appears.

---

**Note:** The View Locked Definitions menu item is not available if you have restricted access to Change Control.

---

2. Select the definition type and user.

You can view all locked definitions of the specified type by selecting *all* from the User drop-down list box.

3. Select the definitions to unlock.
4. Right-click any selected definition and select Unlock Definition.

If Change Control history is enabled, the system will prompt you for comments.

## Locking or Unlocking an Open Definition

To lock or unlock an open definition:

1. Activate the definition.
2. Select Tools > Change Control and then select either Lock Definition or Unlock Definition.

## Locking Definitions Automatically When You Open Them

To lock definitions automatically when you open them:

1. Select Tools > Options > Change Control.

2. Select Lock definition when it is opened.

Now, whenever you open a definition it is locked automatically, unless you have only restricted access to Change Control. In this case, the system will notify you that you have restricted access and will ask whether you want to open the definition in read-only mode.

---

**Note:** Like all settings in the Application Designer Options dialog box, this setting controls the behavior on your workstation only. Also, definitions cannot be unlocked automatically; you must always unlock them manually.

---

## Locking or Unlocking All Definitions at Once

To lock or unlock all definitions at once:

1. Select Tools > Change Control > Administrator.

The Change Control Administrator dialog box appears.

2. Select Lock all definitions to lock all definitions or deselect it to unlock all definitions.

Locking all definitions applies a database-wide lock that is tagged with your user ID.

---

**Warning!** Selecting this check box removes individual locks from all database definitions. You should proceed with this step only if you have informed all of your developers and given them an opportunity to save any unsaved work.

---

3. Click OK.

If you are locking all definitions, the system warns you that this action permanently cancels existing locks. Click Yes.

## Viewing Locked Definitions

At times you may want to see a definition even if it is locked.

To view locked definitions:

1. Select Tools > Change Control > View Locked Definitions.

The Locked Definitions dialog box appears.

2. Select the user whose locked definitions you want to view.
3. Select the type to display.

You can view only one definition type at a time. You can also unlock definitions in this dialog box.

## Inserting Comments

When Change Control history is enabled, you can insert comments about an open definition at any time. To help ensure that you insert new comments with each modification, you can instruct PeopleSoft Application Designer to prompt you for a comment every time you save a definition, every time you lock or unlock a definition, or both.

This section discusses how to:

- Insert a comment for an unopened definition in the current project.
- Insert a comment for an open definition.
- Enable a prompt for comments when saving a definition.

## Inserting a Comment for an Unopened Definition in the Current Project

To insert a comment for an unopened definition in the current project:

1. In the project workspace, select the Development tab at the base of the workspace window to activate the development view.

2. Select the definition for which you want to insert comments.

You cannot insert comments for more than one definition at a time.

3. Right-click the selected definition and select Insert Comment.

The Insert Comment dialog box appears.

4. Enter the necessary information:

<b>Project</b>	Displays the name of the current project by default, but you can delete or replace this value.
<b>Incident ID</b>	Enter the incident identification to which your development corresponds.
<b>Comments</b>	Enter information about why and how you are modifying the definition.

If you click OK, the information is inserted into the definition history and the dialog box closes. If you click Apply, your comments are inserted, but the dialog box remains open. You can then enter comments for another history entry. When you click OK or Apply, the new comments are inserted as a new history entry; they do not replace the previous entry.

## Inserting a Comment for an Open Definition

To insert a comment for an open definition:

1. Use the list in the Window menu to navigate to the definition.
2. Select Tools > Change Control > Insert Comment.
3. Enter the name of the project and incident ID.
4. Enter your comments.
5. Click OK or Apply.

## Enabling a Prompt for Comments When Saving a Definition

To be prompted for comments when saving a definition:

1. Select Tools > Options > Change Control.

The Change Control page appears.

2. Select Prompt for comments when definition is saved.

Whenever you save a definition, the system prompts you to insert history comments.

---

**Note:** This setting affects the behavior on your workstation only. One possible drawback to using this setting is that a definition might be saved many times as part of a single change, and you will be prompted for comments at every save.

---

## Deleting Page Definitions

When deleting page definitions with Change Control enabled, the system presents this message:

Are you sure you want to delete <definition name> definition? You are presented with Yes and No options. If you click the Yes button and the page is locked, then the system will delete the page. If you click the Yes button and the page is not locked, then this message box appears:

You must lock <definition name> before you may rename or delete it.

You must lock the page before you are allowed to delete it.

If you click the No button, then the system does not delete the definition.

---

**Note:** If the definition is a base language page, then the system also deletes all non-base language pages. If the definition is a non-base language page, then the system deletes only the selected non-base language page.

---

If you select multiple pages to delete but the base language page is not included in the selection, then the system prompts you for lock comments for each selected non-base language page. If you select multiple pages to delete and the base language page is included in the selection, then the system prompts you for lock comments for only the base language page.

### Related Links

"Designing Global-Ready Pages" (PeopleTools 8.58: Global Technology)

## Viewing Change Control History

For every PeopleSoft Application Designer development definition in the database, you can view its Change Control history.

To view Change Control history:

1. Select Tools > Change Control > View History.

The History dialog box appears.

2. Select a definition type and name.

The Definition Name list box contains only the names of PeopleSoft Application Designer definitions that have at least one history entry. Click the Refresh button to ensure that you are viewing the most recent listing of locked definitions.

The history table contains these columns:

<b>Date</b>	Displays when each entry was added.
<b>User</b>	Displays who added an entry.
<b>Action</b>	Displays why a comment was entered. Five of these Action types—Lock, Informational, Unlock, Rename, and Delete—represent actions that you perform in PeopleSoft Application Designer and for which the system prompts for comments.
<b>Add</b>	Denotes an automatic history entry that PeopleTools inserts when a new definition is created. In this case, and whenever the system performs a background lock or unlock, the system does not prompt you for comments. The Comment column contains the text System Generated.
<hr/>	
	<b>Note:</b> PeopleSoft Application Designer performs automatic locks and unlocks under certain situations. For example, when you rename a locked definition, that definition must be unlocked before it is renamed and then relocked afterward. Likewise, when you delete a locked definition, the definition is automatically unlocked following the deletion. The system does not prompt you for comments during any of these unlock or relock actions, but it adds corresponding history entries automatically.
<hr/>	
<b>Copy</b>	The system adds this type of history entry automatically when a definition is copied into the current database. In this case, the Project value is the name of the copied project in the source database, and no comments are added.
<b>Project, Incident ID, and Comment</b>	Displays the project name, incident ID, and relevant comments.

3. Double-click a row in the grid to open a history entry, if necessary.

The History Details dialog box appears. This dialog box is a read-only version of the Insert Comments dialog box. You cannot update the information that appears in this dialog box.





## Appendix A

# Understanding Functional Indexes

---

## Functional Indexes for Microsoft SQL Server

The following example shows how the key fields are concatenated:

```
USE FS840U70
go
SET IMPLICIT_TRANSACTIONS ON
go
IF EXISTS (SELECT 'X' FROM SYSOBJECTS WHERE TYPE = 'U' AND NAME =
'PS_QE_ALTER_NEW') DROP TABLE PS_QE_ALTER_NEW
go
CREATE TABLE PS_QE_ALTER_NEW (QE_ALTER_FLD1 NCHAR(1) NOT null,
QE_ALTER_FLD2 NCHAR(1) NOT null,
QE_ALTER_FLD3 NCHAR(1) NOT null,
QE_ALTER_FLD4 NCHAR(10) NOT null,
QE_ALTER_FLD5 NCHAR(20) NOT null,
QE_ALTER_FLD6 NCHAR(11) NOT null,
QE_ALTER_FLD7 NCHAR(1) NOT null,
QE_ALTER_FLD8 NCHAR(1) NOT null,
QEPC AGE SMALLINT NOT null,
QEPC_FILE_NUM DECIMAL(6, 2) NOT null,
QE_BEGIN_DT PSDATE null,
QE_BIRTHDATE PSDATE null,
QE_31DIGFLD9 DECIMAL(31, 8) NOT null,
QE_ANNUAL_PCT DECIMAL(3, 1) NOT null,
QE_MS_DTTM1 PSDATETIME null,
QE_MS_DTTM2 PSDATETIME null,
QE_ALTER_TIMEA PSTIME null,
QE_ALTER_TIMEB PSTIME null,
MSSCONCATCOL AS QE_ALTER_FLD1 + QE_ALTER_FLD2 + QE_ALTER_FLD3 +
QE_ALTER_FLD4 + QE_ALTER_FLD5 + QE_ALTER_FLD6 + QE_ALTER_FLD7 +
QE_ALTER_FLD8 + CONVERT(NCHAR, QEPC_AGE) + CONVERT(NCHAR
, QEPC_FILE_NUM) + CONVERT(NCHAR(16), QE_BEGIN_DT, 109) +
CONVERT(NCHAR(16), QE_BIRTHDATE, 109) + CONVERT(NCHAR, QE_31DIGFLD9) +
CONVERT(NCHAR, QE_ANNUAL_PCT) + CONVERT(NCHAR(16), QE_MS_DTTM1, 109) +
CONVERT(NCHAR(16), QE_MS_DTTM2, 109) + CONVERT(NCHAR(16)
, QE_ALTER_TIMEA, 109))
go
COMMIT
go
SET ARITHABORT ON
go
CREATE UNIQUE CLUSTERED INDEX PS_QE_ALTER_NEW ON PS_QE_ALTER_NEW
(MSSCONCATCOL)
go
CREATE NONCLUSTERED INDEX PSWQE_ALTER_NEW ON PS_QE_ALTER_NEW
(QE_ALTER_FLD1,
QE_ALTER_FLD2,
QE_ALTER_FLD3,
QE_ALTER_FLD4,
QE_ALTER_FLD5,
QE_ALTER_FLD6,
QE_ALTER_FLD7,
QE_ALTER_FLD8,
QEPC_AGE,
QEPC_FILE_NUM,
QE_BEGIN_DT,
QE_BIRTHDATE,
```

```
QE_31DIGFLD9,  
QE_ANNUAL_PCT,  
QE_MS_DTTM1,  
QE_MS_DTTM2)  
go  
COMMIT  
Go
```

## Appendix B

# Referencing Selections for Command Line Parameters

---

## Database Type Selections

This table lists the database type values:

<b>Database</b>	<b>Database Description</b>
DB2ODBC	Db2 for z/OS
MICROSFT	Microsoft SQL Server
ORACLE	Oracle

---

## Definition Type Selections

This table lists the definition type values:

<b>Number</b>	<b>Definition Description</b>
0	Records
1	Indexes
2	Fields
3	Format definitions
4	Translate values
5	Pages
6	Menus
7	Components
8	Record PeopleCode
9	Menu PeopleCode
10	Queries

<b>Number</b>	<b>Definition Description</b>
11	Tree structures
12	Trees*
13	Access groups*
14	Colors
15	Styles
16	Not used
17	Business processes
18	Activities
19	Roles*
20	Process definitions
21	Process servers
22	Process types
23	Process jobs
24	Process recurrences
25	Message catalog entries*
26	Dimensions*
27	Cube definitions*
28	Cube instance definitions*
29	Business interlinks
30	SQL definitions
31	File layout definitions
32	Component interfaces
33	Application Engine programs
34	Application Engine sections
35	Message nodes
36	Message channels
37	Message definitions

<b>Number</b>	<b>Definition Description</b>
38	Approval rule sets
39	Message PeopleCode
40	Subscription PeopleCode
41	Not used
42	Component interface PeopleCode
43	Application engine PeopleCode
44	Page PeopleCode
45	Page field PeopleCode
46	Component PeopleCode
47	Component record PeopleCode
48	Component record field PeopleCode
49	Images
50	Style sheets
51	HTML
52	Not used
53	Permission lists
54	Portal registry definitions
55	Portal registry structures
56	URL definitions
57	Application Packages
58	Application Package PeopleCode
59	Portal Registry User homepages
60	Problem type definitions
61	Archive templates (deprecated in PeopleTools release 8.44 and above)
62	XSLT
63	Portal Registry User Favorites

<b>Number</b>	<b>Definition Description</b>
64	Mobile pages <hr/> <b>Important!</b> PeopleSoft Mobile Agent is a deprecated product. These features exist for backward compatibility only. <hr/>
65	Relationships
66	Component Interface Property PeopleCode**
67	Optimization Models***
68	File References***
69	File Reference Type Code***
70	Archive object definitions***
71	Archive Templates (Type 2)***
72	Diagnostic Plug-Ins***
73	Analytic Models
74	Not Used
75	Java Portlet User Preferences
76	WSRP Remote Producers
77	WSRP Remote Portlets
78	WSRP Cloned Portlet Handles
79	Services
80	Service Operations
81	Service Operation Handlers
82	Service Operation Version
83	Service Operation Routings
84	IB Queues
85	BIP Template Definitions
86	BIP Report Definitions
87	BIP File Definitions
88	BIP Data Source Definitions

<b>Number</b>	<b>Definition Description</b>
89	WSDL
90	Message Schemas
91	Connected Query Definition
92	Logical Schemas
93	XML Schemas
94	Relational Schemas
95	Dependency Documents
96	Document Schema
97	Essbase Cube Dimensions
98	Essbase Cube Outlines
99	Essbase Cube Connections
100	Essbase Cube Templates
101	Delimited Schemas
102	Positional Schemas
103	Application Data Set Definitions
104	Test Definitions
105	Test Framework Test Cases
106	Application Data Set Bindings
107	Feed Definitions
108	Feed Categories
109	Feed Data Type
110	JSON Documents
111	Related Content Definition
112	Related Content Services
113	Related Content Configurations
114	Related Content Layouts
115	Search Attributes

<b>Number</b>	<b>Definition Description</b>
116	Search Definitions
117	Search Categories
118	Search Contexts
119	Integration Groups
120	HTML Schema
121	Document Layout Manager
122	Document Template Manager
123	Composite Query Manager
124	Document PeopleCode Manager
125	MAP Administration Manager
126	MAP Store Manager
127	Related Content User Personalization Manager
128	External Entity Manager
256	Invalid Object Type

---

## Language Selections

This table lists the language code values:

<b>Code</b>	<b>Language Description</b>
ARA	Arabic
BUL	Bulgarian
CFR	Canadian French
CRO	Croatian
CZE	Czech
DAN	Danish
DUT	Dutch
ENG	English



<b>Code</b>	<b>Language Description</b>
ESP	Spanish
FIN	Finnish
FRA	French
GER	German
GRK	Greek
HEB	Hebrew
HUN	Hungarian
ITA	Italian
JPN	Japanese
KOR	Korean
MAY	Bahasa Malay
NOR	Norwegian
POL	Polish
POR	Portuguese
ROM	Romanian
RUS	Russian
SER	Serbian
SLK	Slovak
SLV	Slovenian
SVE	Swedish
THA	Thai
TUR	Turkish
UKE	UK English
ZHS	Simplified Chinese
ZHT	Traditional Chinese
COMMON	Non-language attributes

---

## Available Release Numbers

The available release numbers are:

- Core 5.10.00.000
- Core 6.00.00.000
- Core 6.10.00.000
- Core 7.00.00.000
- Core 7.50.00.000
- Core 8.00.00.000
- Core 8.10.00.000
- Core 8.40.00.000
- Core.8.50.00.000

## Appendix C

# Using Default Style Classes

## Default Style Classes

This table lists many of the default style classes that come with PeopleSoft applications, a brief description of the style class, and the style sheet to which each class belongs:

**Note:** Applying a default style class in way other than its intended purpose—for example, for styling alone when the style class also has a functional purpose—may cause undesirable results.

<b>Style Class</b>	<b>Description</b>	<b>Style Sheet</b>
EDGE	Default PeopleSoft Pure Internet Architecture navigation*.	PTSTYLEDEF
EOPP_SCCHILDINDENT	Navigation collection child folder indentation.	PTSTYLEDEF
EOPP_SCPAGEBORDER	Navigation collection page border.	PTSTYLEDEF
EOPP_SCSECTIONCONTENTDARK	Navigation collection section content dark style.	PTSTYLEDEF
EOPP_SCSECTIONFOLDERDARK	Navigation collection section folder dark style.	PTSTYLEDEF
EOPP_SCSECTIONCONTENT	Navigation collection section content.	PTSTYLEDEF
EOPP_SCSECTIONFOLDER	Navigation collection section folder.	PTSTYLEDEF
EOPP_SCPAGETITLESECTION	Navigation collection page title.	PTSTYLEDEF
EOPP_SCBREADCRUMBSECTION	Navigation collection breadcrumbs.	PTSTYLEDEF
EOPP_SCADDITIONALTEXT	Navigation collection additional text.	PTSTYLEDEF
EOPP_SCPAGEDESCRSECTION	Navigation collection page description.	PTSTYLEDEF
EOPP_SCCHILDCONTENTLINK	Navigation collection child content link.	PTSTYLEDEF
EOPP_SCCHILDFOUNDERLINK	Navigation collection child folder link.	PTSTYLEDEF
EOPP_SCCHILDINDENT	Navigation collection child folder indentation.	PTSTYLEDEF
EOPP_SCMORELINK	Navigation collection more link.	PTSTYLEDEF

<b>Style Class</b>	<b>Description</b>	<b>Style Sheet</b>
EOPP_SCPAGEBORDER	Navigation collection page border.	PTSTYLEDEF
EOPP_SCSECTIONCONTENT	Navigation collection section content.	PTSTYLEDEF
EOPP_SCSECTIONCONTENTDARK	Navigation collection section content dark style.	PTSTYLEDEF
EOPP_SCSECTIONFOLDERDARK	Navigation collection section folder dark style.	PTSTYLEDEF
EOPP_SCSECTIONCONTENTLINK	Navigation collection section content link.	PTSTYLEDEF
EOPP_SCSECTIONFOLDERLINK	Navigation collection section folder link.	PTSTYLEDEF
HEADERLINK	Used by Branding area links on a page.	PTSTYLEDEF
HEADERLINKACTIVE	Used by Branding area links on a page that are active.	PTSTYLEDEF
HILEFT1	Default PeopleSoft Pure Internet Architecture navigation*.	PTSTYLEDEF
HILEFT2	Default PeopleSoft Pure Internet Architecture navigation*.	PTSTYLEDEF
KNOCKOUT	Portal administration left navigation*.	PTSTYLEDEF
LEVEL1	Default PeopleSoft Pure Internet Architecture navigation*.	PTSTYLEDEF
LEVEL2	Default PeopleSoft Pure Internet Architecture navigation*.	PTSTYLEDEF
LEVEL3	Default PeopleSoft Pure Internet Architecture navigation*.	PTSTYLEDEF
MID	Links at the first level of the PeopleSoft Pure Internet Architecture navigation.	PTSTYLEDEF
MUTE	Descriptive text in the PeopleSoft Pure Internet Architecture navigation.	PTSTYLEDEF
PAADDITIONALINSTRUCTIONS	Additional instructions on the page (slightly smaller font).	PSALTERNATE
PABACKGROUNDINVISIBLE	Body background of hidden group boxes and grids.	PSALTERNATE
PABOLDBLUETEXT	Strong emphasis for text on a page.	PSALTERNATE
PABOLDTEXT	Field value emphasis.	PSALTERNATE
PACALENDARDAYNUM	Text for numeric days on calendars.	PSALTERNATE

<b>Style Class</b>	<b>Description</b>	<b>Style Sheet</b>
PACALENDARDAYNUMDISABLED	Text for numeric days on calendars (disabled state).	PSALTERNATE
PACFGRIDFOOT	Footer borders for ChartField grids.	PSALTERNATE
PACFGRIDLABEL	Header label background for ChartField grids.	PSALTERNATE
PAERRORETEXT	Inline error message text font type, color, and size.	PSALTERNATE
PAEXAMPLE	Smaller font size to demonstrate an example.	PSALTERNATE
PAEXPANDCOLLAPSE	Expandable and collapsible area borders.	PSALTERNATE
PAFRAMEBACKGROUND	Same as the PAGROUPDIVIDER style class except that it allows text on the dividing bar for self-service pages.	PSALTERNATE
PAFRAMELEVEL1	Level 1 frames.	PSALTERNATE
PAFRAMELEVEL2	Level 2 frames.	PSALTERNATE
PAFRAMELEVEL3	Level 3 frames.	PSALTERNATE
PAGRIDHEADER	Grid column headers for self-service grids without navigation controls.	PSALTERNATE
PAGROUPBOX	Group boxes.	PSALTERNATE
PAGROUPBOXLABELINVISIBLE	Invisible group box label.	PSALTERNATE
PAGROUPBOXLABELLEVEL1	Group box labels at level 1.	PSALTERNATE
PAGROUPBOXLABELLEVEL2	Group box labels at level 2.	PSALTERNATE
PAGROUPBOXLABELLEVEL3	Group box labels at level 3.	PSALTERNATE
PAGROUPBOXLEVEL1	Group box body at level 1.	PSALTERNATE
PAGROUPBOXLEVEL2	Group box body at level 2.	PSALTERNATE
PAGROUPBOXLEVEL3	Group box body at level 3.	PSALTERNATE
PAGROUPDIVIDER	Group box label style on self-service pages.	PSALTERNATE
PAGROUPDIVIDERBODY	Group box body style on developer-defined advanced search pages.	PSALTERNATE
PAHEADERTOOLBARBODY	Frame background for the customer relationship management (CRM) toolbar.	PSALTERNATE

<b>Style Class</b>	<b>Description</b>	<b>Style Sheet</b>
PAHEADERTOOLBARFRAME	Frame borders for the CRM toolbar.	PSALTERNATE
PAHORIZONTALRULELEVEL1	Horizontal rule at level 1.	PSALTERNATE
PAHORIZONTALRULELEVEL2	Horizontal rule at level 2.	PSALTERNATE
PAHORIZONTALRULELEVEL3	Horizontal rule at level 3.	PSALTERNATE
PAHYPERLINKDESCR	Text description for links on application homepages.	PSALTERNATE
PAHYPERLINKERRSTAT	Links conveying an error status (use with image).	PSALTERNATE
PAHYPERLINKLVL1ODD	Link style for grid odd rows that use the PeopleCode style property.	PSALTERNATE
PAHYPERLINKSUCCESSSTAT	Links conveying a successful status (use with image).	PSALTERNATE
PAHYPERLINKWARNSTAT	Links conveying a warning status (use with image).	PSALTERNATE
PALEGENDBACKGROUND	Group box body color for legends on pages.	PSALTERNATE
PALEVEL0PRIMARY	Level 0, high-level key data on self-service pages.	PSALTERNATE
PALEVEL0SECONDARY	Additional fields to identify the object.	PSALTERNATE
PAPAGEINSTRUCTIONS	Text instructions on the top of the page.	PSALTERNATE
PAPAGETITLE	Page title.	PSALTERNATE
PASEARCHBOXBODY	Group boxes around search criteria.	PSALTERNATE
PASSINFORMATIONALTEXT	Text instructions on the top of the page.	PSALTERNATE_SWAN
PASSTRANSACTIONALTITLE	Transaction name above the current page title.	PSSTYLEDEF_SWAN
PASTEPBYSTEPSTITLE	Step-by-step transaction.	PSALTERNATE
PASUBTABLINKACTIVE	Active Sub tab style.	PSALTERNATE
PASUBTABLINKINACTIVE	Inactive Sub tab style.	PSALTERNATE
PATEXTBACKGROUND	Text background.	PSALTERNATE
PATRANSACTIONTITLE	Transaction name above the current page title.	PSALTERNATE
PSACTIVETAB	Active tab labels and background colors.	PTSTYLEDEF

<b>Style Class</b>	<b>Description</b>	<b>Style Sheet</b>
PSBOTTOMLINE	Tab bottom line style to specify height and width. Height can be set to 0 if tab bottom line is not required.	PTSTYLEDEF
PSCHARTAXISTITLE	Chart axis labels.	PTSTYLEDEF
PSCHARTDEFAULT	Default chart text.	PTSTYLEDEF
PSCHARTTITLE	Chart title text.	PTSTYLEDEF
PSCHECKBOX	Check box label.	PTSTYLEDEF
PSDISABLED	Disabled field value font type, size, and color.	PTSTYLEDEF
PSDROPDOWNLABEL	Drop-down list box label.	PTSTYLEDEF
PSDROPDOWNLIST	Drop-down list box text.	PTSTYLEDEF
PSEDITBOX	Edit box label.	PTSTYLEDEF
PSEDITBOX_DISABLED	Disabled edit box style (white background with a thin, gray border).	PTSTYLEDEF
PSEDITBOX_DISPONLY	Display-only edit boxes.	PTSTYLEDEF
PSEDITBOXLABEL	Edit box text.	PTSTYLEDEF
PSERROR	Error field background color and text.	PTSTYLEDEF
PSFRAME	Frame borders.	PTSTYLEDEF
PSGRIDCOLUMNHDR	Grid column header texts.	PTSTYLEDEF
PSGRIDCOUNTER	Color for the row counter text displayed in the grid header.	PTSTYLEDEF
PSGRIDEVENROWSORTED	Sorted even row style in a grid.	PTSTYLEDEF
PSGRIDODDROWSORTED	Sorted odd row style in a grid.	PTSTYLEDEF
PSGROUPBOX	Group box borders and body style.	PTSTYLEDEF
PSGROUPBOXLABEL	Group box labels.	PTSTYLEDEF
PSHEADERHYPERLINK	Link in a scroll area or grid header.	PTSTYLEDEF
PSHEADERHYPERLINKD	Disabled link in a scroll area or grid header.	PTSTYLEDEF
PSHEADERTOOLBARFRAME	Meant for PeopleTools usage for buttons.	
PSHORIZONTALRULE	Horizontal rule.	PTSTYLEDEF

<b>Style Class</b>	<b>Description</b>	<b>Style Sheet</b>
PSHYPERLINK	Link.	PTSTYLEDEF
PSHYPERLINKACTIVE	Selected link.	PTSTYLEDEF
PSHYPERLINKDISABLED	Disabled link.	PTSTYLEDEF
PSHYPERLINKHOVER	Link when the mouse hovers over it.	PTSTYLEDEF
PSHYPERLINKNOUL	Link with no underline.	PTSTYLEDEF
PSHYPERLINKVISITED	Previously visited link.	PTSTYLEDEF
PSHYPERLINKYELLOWBKGRD	Link with a yellow background.	PTSTYLEDEF
PSIMAGE	Image border style, width, and colors.	PTSTYLEDEF
PSINACTIVETAB	Inactive tab labels and background colors.	PTSTYLEDEF
PSINACTIVETABHOVER	Inactive tab labels and background colors when the mouse hovers over them.	PTSTYLEDEF
PSLEVEL1GRID	Level 1 grid background colors, border settings, and fonts.	PTSTYLEDEF
PSLEVEL1GRIDACTIVETAB	Active tab labels and background colors on level 1 grids.	PTSTYLEDEF
PSLEVEL1GRIDCOLUMNHDR	Grid column labels on level 1 grids.	PTSTYLEDEF
PSLEVEL1GRIDCOLUMNHDRTXT	Level 1 grid column header text style	PTSTYLEDEF
PSLEVEL1GRIDEVENROW	Even rows on level 1 grids.	PTSTYLEDEF
PSLEVEL1GRIDINACTIVETAB	Inactive tab labels and backgrounds on level 1 grids.	PTSTYLEDEF
PSLEVEL1GRIDINACTIVETABHOVER	Inactive tab labels and backgrounds (when mouse hovers over them) on level 1 grids.	PTSTYLEDEF
PSLEVEL1GRIDLABEL	Level 1 grid labels.	PTSTYLEDEF
PSLEVEL1GRIDNAVIGATIONBAR	Navigation bars on level 1 grids.	PTSTYLEDEF
PSLEVEL1GRIDODDROW	Odd rows on level 1 grids.	PTSTYLEDEF
PSLEVEL1GRIDROW	Level 1 grid background settings, border settings, and fonts.	PTSTYLEDEF
PSLEVEL1SCROLLAREABODY	Level 1 scroll area body.	PTSTYLEDEF
PSLEVEL1SCROLLAREAFOOTER	Level 1 scroll area footer.	PTSTYLEDEF



<b>Style Class</b>	<b>Description</b>	<b>Style Sheet</b>
PSLEVEL1SCROLLAREAHEADER	Level 1 scroll area header.	PTSTYLEDEF
PSLEVEL2GRID	Level 2 grid background colors, border settings, and fonts.	PTSTYLEDEF
PSLEVEL2GRIDACTIVETAB	Active tab labels and background colors on level 2 grids.	PTSTYLEDEF
PSLEVEL2GRIDCOLUMNHDR	Grid column labels on level 2 grids.	PTSTYLEDEF
PSLEVEL2GRIDCOLUMNHDRTXT	Level 2 grid column header text style.	PTSTYLEDEF
PSLEVEL2GRIDEVENROW	Even rows on level 2 grids.	PTSTYLEDEF
PSLEVEL2GRIDINACTIVETAB	Inactive tab labels and backgrounds on level 2 grids.	PTSTYLEDEF
PSLEVEL2GRIDINACTIVETABHOVER	Inactive tab labels and backgrounds (when mouse hovers over it) on level 2 grids.	PTSTYLEDEF
PSLEVEL2GRIDLABEL	Labels on level 2 grids.	PTSTYLEDEF
PSLEVEL2GRIDNAVIGATIONBAR	Navigation bars on level 2 grids.	PTSTYLEDEF
PSLEVEL2GRIDODDROW	Odd rows on level 2 grids.	PTSTYLEDEF
PSLEVEL2GRIDROW	Level 2 grid background settings, border settings, and fonts.	PTSTYLEDEF
PSLEVEL2SCROLLAREAABODY	Level 2 scroll area body.	PTSTYLEDEF
PSLEVEL2SCROLLAREAFOOTER	Level 2 scroll area footer.	PTSTYLEDEF
PSLEVEL2SCROLLAREAHEADER	Level 2 scroll area header.	PTSTYLEDEF
PSLEVEL3GRID	Level 3 grid background settings, border settings, and fonts.	PTSTYLEDEF
PSLEVEL3GRIDACTIVETAB	Active tab labels and background colors on level 3 grids.	PTSTYLEDEF
PSLEVEL3GRIDCOLUMNHDR	Grid column labels on level 3 grids.	PTSTYLEDEF
PSLEVEL3GRIDCOLUMNHDRTXT	Level 3 grid column header text style.	PTSTYLEDEF
PSLEVEL3GRIDEVENROW	Even rows on level 3 grids.	PTSTYLEDEF
PSLEVEL3GRIDINACTIVETAB	Inactive tab labels and backgrounds on level 3 grids.	PTSTYLEDEF
PSLEVEL3GRIDINACTIVETABHOVER	Inactive tab labels and backgrounds (when the mouse hovers over them) on level 3 grids .	PTSTYLEDEF

<b>Style Class</b>	<b>Description</b>	<b>Style Sheet</b>
PSLEVEL3GRIDLABEL	Labels on level 3 grids.	PTSTYLEDEF
PSLEVEL3GRIDNAVIGATIONBAR	Navigation bars on level 3 grids.	PTSTYLEDEF
PSLEVEL3GRIDODDROW	Odd rows on level 3 grids.	PTSTYLEDEF
PSLEVEL3GRIDROW	Level 3 grid background settings, border settings, and fonts.	PTSTYLEDEF
PSLEVEL3SCROLLAREABODY	Level 3 scroll area body.	PTSTYLEDEF
PSLEVEL3SCROLLAREAFOOTER	Level 3 scroll area footer.	PTSTYLEDEF
PSLEVEL3SCROLLAREAHEADER	Level 3 scroll area header.	PTSTYLEDEF
PSLONGEDITBOX	Long edit box data.	PTSTYLEDEF
PSLONGEDITLABEL	Long edit box labels.	PTSTYLEDEF
PSMULTILANG	Multilingual field background.	PTSTYLEDEF
PSNAVPARENTLINK	Left navigation link color.	PTSTYLEDEF
PSPAGE	Page background color and margins.	PTSTYLEDEF
PSPAGECONTAINER	Background color for the page container.	PTSTYLEDEF
PSPAGECUST	Shaded background for page personalization image.	PTSTYLEDEF
PSPROCESSING	Processing message background color.	PTSTYLEDEF
PSPSMALLTEXT	Footer text font type, size, weight, and color.	PTSTYLEDEF
PSPTABTABLE	Style for Portal tab label.	PTSTYLEDEF
PSPUSHBUTTON	Push button labels and background.	PTSTYLEDEF
PSPUSHBUTTON*	Style class for push buttons in non-SWAN mode. For example, , PSPUSHBUTTONRETURN, when clicked returns to the previous page.	PTSTYLEDEF
PSPUSHBUTTONDISABLED	Disabled push button labels and background color.	PTSTYLEDEF
PSRADIOBUTTON	Radio buttons.	PTSTYLEDEF
PSRIGHTLEFTSCROLL	Style specification for Show following Tabs and Show previous Tabs button.	
PSSRCHACTION	Font style for Search action.	

<b>Style Class</b>	<b>Description</b>	<b>Style Sheet</b>
PSSRCHCHECKBOX	Search check box.	PTSTYLEDEF
PSSRCHDROPDOWNLABEL	Search drop-down labels.	PTSTYLEDEF
PSSRCHEDITBOXLABEL	Search edit box labels.	PTSTYLEDEF
PSSRCHINSTRUCTIONS	Search instructions.	PTSTYLEDEF
PSSRCHPAGE	Search page font type, background color, and margins.	PTSTYLEDEF
PSSRCHRESULTSEVENROW	Even rows on search page result grids.	PTSTYLEDEF
PSSRCHRESULTSFOOTER	Footer on search page result grids.	PTSTYLEDEF
PSSRCHRESULTSHDR	Header on search page result grids.	PTSTYLEDEF
PSSRCHRESULTSHDRTXT	Header text style for search results.	PTSTYLEDEF
PSSRCHRESULTSHYPERLINK	Navigation links above the search results.	PTSTYLEDEF
PSSRCHRESULTSHYPERLINKD	Disabled navigation links above the search results.	PTSTYLEDEF
PSSRCHRESULTSODDROW	Odd rows on search page result grids.	PTSTYLEDEF
PSSRCHRESULTSTITLE	Instructional text on search results page.	PTSTYLEDEF
PSSRCHSUBTITLE	Search results section title.	PTSTYLEDEF
PSSRCHTIPS	Search tips.	PTSTYLEDEF
PSSRCHTITLE	First-level title on a search page.	PTSTYLEDEF
PSSTATICIMAGE	Static image border styles, width, and colors.	PTSTYLEDEF
PSTEXT	Static text controls.	PTSTYLEDEF
PSTLEFTMENU	No longer used.	PTSTYLEDEF
PSTREENODESELECTED	Selected tree node.	PTSTYLEDEF
PSTRELINKSBODYNARROW	Related links body for narrow templates.	PAALTERNATE
PSTRELINKSBODYWIDE	Related links body for wide templates.	PAALTERNATE
PSTRELINKSHDRNARROW	Related links header label for narrow templates.	PAALTERNATE
PSTRELINKSHDRWIDE	Related links header label for wide templates.	PAALTERNATE

<b>Style Class</b>	<b>Description</b>	<b>Style Sheet</b>
PTBREADCRUMB	Breadcrumbs.	PTSTYLEDEF
PTBREADCRUMBCUR	Current location on a breadcrumb trail.	PTSTYLEDEF
PTBREADCRUMBARGIN	Breadcrumb margins.	PTSTYLEDEF
PTGRIDROWMOUSEOVER	Grid row style on mouse over.	PTSTYLEDEF
PTGRIDROWSELECT	Grid row style for a selected row.	PTSTYLEDEF
PT_MCFADDITIONALINSTRUCTIONS	Any additional instructions/error messages with small font.	PTSTYLEDEF
PT_MCFCHATME	Self chat message class.	PTSTYLEDEF
PT_MCFCHATSYSMSG	System chat message.	PTSTYLEDEF
PT_MCFCHATTHEM	Chat message from others.	PTSTYLEDEF
PT_MCFCHATUS	Chat message from another Agent.	PTSTYLEDEF
PT_MCFCHECKBOX	MCF check box.	PTSTYLEDEF
PT_MCFCHECKBOXLABEL	MCF check box label.	PTSTYLEDEF
PT_MCFDROPDOWNLIST	MCF drop-down list box.	PTSTYLEDEF
PT_MCFEDITBOX	MCF edit box.	PTSTYLEDEF
PT_MCFEVTNAME	REN event name in tracer log.	PTSTYLEDEF
PT_MCFEVTVALUE	REN event value in tracer log.	PTSTYLEDEF
PT_MCFGRAYTEXT	Non-editable gray text.	PTSTYLEDEF
PT_MCFGROUPBOX	MCF group box style.	PTSTYLEDEF
PT_MCFHEADER	MCF header style.	PTSTYLEDEF
PT_MCFLABEL	MCF label style.	PTSTYLEDEF
PT_MCFPAGETITLE	MCF page title style.	PTSTYLEDEF
PT_MCFPUSHBUTTON	MCF push button style.	PTSTYLEDEF
PT_MCFROW	Row style in an MCF table.	PTSTYLEDEF
PT_MCFSPVSRTABLE	Table style for MCF monitoring supervisor.	PTSTYLEDEF
PT_MCFTABLE	Table style.	PTSTYLEDEF
PT_MCFTABLEHEADER	Transparent table header style.	PTSTYLEDEF

<b>Style Class</b>	<b>Description</b>	<b>Style Sheet</b>
PT_MCFTABLEHEADER1	Table header style.	PTSTYLEDEF
PT_MCFTRACEREVENT	REN event in tracer window style	PTSTYLEDEF
PT_MCFTRACERREQ	REN request in tracer window style.	PTSTYLEDEF
PTCXMADMINBAR	Context manager “Administer Pagelets” bar style.	PTSTYLEDEF
PTCXMADMINLINK	Context Manager “Administer Pagelets” link style.	PTSTYLEDEF
PTCXMPAGELETBODYBAK	Context Manager template pagelet body background.	PTSTYLEDEF
PTCXMPAGELETHEADERBAK	Context Manager template pagelet header background	PTSTYLEDEF
PTCXMPGLTHDRLINK	Context Manager template pagelet header link.	PTSTYLEDEF
PTCXMPGLTHDRLINKHOVER	Context Manager template pagelet header link hover.	PTSTYLEDEF
PTGRIDROWMOUSEOVER	Grid row style on mouse over.	PTSTYLEDEF
PTGRIDROWSELECT	Grid row style for a selected row.	PTSTYLEDEF
PTMENULINK	Link on level 2 of the PeopleSoft Pure Internet Architecture navigation.	PTSTYLEDEF
PTNAVBACKGROUND	Background style in navigation menu.	PTSTYLEDEF
PTNAVLINK	Content reference link style.	PTSTYLEDEF
PTNAVLINKHOVER	Content reference link style when the mouse hovers over it.	PTSTYLEDEF
PTNAVSEARCHDIVIDER	Search divider element style (in navigation).	PTSTYLEDEF
PTNAVSEARCHLABEL	Search label style (in navigation).	PTSTYLEDEF
PTNAVSELCHILDBK	Selected content reference background color (in navigation).	PTSTYLEDEF
PTNAVSELCHILDEDGEDK	Background dark color on the top edge of the selected content reference (in navigation).	PTSTYLEDEF
PTNAVSELCHILDEDGELT	Background color on the top edge of the selected content reference (in navigation).	PTSTYLEDEF

<b>Style Class</b>	<b>Description</b>	<b>Style Sheet</b>
PTNAVSELCHILDLINK	Selected content reference link font type and color (in navigation).	PTSTYLEDEF
PTNAVSELFOLDERBK	Selected folder background color (in navigation).	PTSTYLEDEF
PTNAVSELPARENTLINK	Selected parent link color (in navigation).	PTSTYLEDEF
PTNAVSELPARENTBK	Selected parent folder background color (in navigation).	PTSTYLEDEF
PTNAVSELPARENTEEDGE	Background color on the edge of the selected parent folder (in navigation).	PTSTYLEDEF
PTPAGELET	Homepage pagelet border thickness and color.	PTSTYLEDEF
PTPAGELETBODY	Homepage pagelet font type and size, border thickness, border color, and padding.	PTSTYLEDEF
PTPAGELETHEADER	Homepage pagelet header font type, size, and color; background color, border thickness; border color; and padding.	PTSTYLEDEF
PTPOPUP_HEADER	Header style for pop up page element.	PTSTYLEDEF
PTPOPUP_TITLE	Title style that appears in the header of the pop-up page element.	PTSTYLEDEF
PTQUERYSTYLESUB	Query style definition.	PTSTYLEDEF
PTSELECTBODY	Portal layout page selection box body.	PTSTYLEDEF
PTSELECTHEADER	Portal layout page selection box header.	PTSTYLEDEF
PTSRCHRESULTSHDRTXT	Text style in Search results header.	PTSTYLEDEF
PTSPELLCHECKERROR	Invalid word for the spell check (highlighted in black with white text).	PTSTYLEDEF
PTTRANSPARENT	Displays text labels as transparent so that they are not visible in standard layout mode but are embedded in the HTML so that they can be read by a screen reader.	PTSTYLEDEF
RESET	Default PeopleSoft Pure Internet Architecture navigation*.	PTSTYLEDEF
SMALL	Link on the portal homepage personalization page and portal structure breadcrumbs.	PTSTYLEDEF
STRONG	Emphasized label text size and weight.	PSSTYLEDEF

<b>Style Class</b>	<b>Description</b>	<b>Style Sheet</b>
STRONGWRAP	Emphasized text size and weight that will break to the next line in long sentences.	PTSTLYEDEF_SWAN

\* Default PeopleSoft Pure Internet Architecture styles are no longer in use.

---

**Note:** Style classes with the suffix *WBO* have border properties. For example, the style PSGROUPBOXWBO enables you to define border properties such as color, width, and style under the Border tab of the style property.

Style classes with the suffix *NBO* have no border properties. For example, the style PSGROUPBOXNBO enables you to define a border property having *None* as its style.

---

## **Related Links**

[Style Sheets Definitions List](#)





## Appendix D

# Modifying Classic Style Sheet Tabs

## Understanding Classic Tab Definitions

You can change the background colors of folder tabs in a component and tabs in a grid. To change the background colors of tabs, you should have a basic understanding of how tab definitions are built and stored in the database.

PeopleSoft applications store tab definitions as images. Each tab, or image definition, has three parts that are stored as rows in the database:

- Row 1 contains code representing the top border.
- Row 2 contains the tab itself.
- Row 3 contains the bottom border.

Because tabs look different, depending on where they are located relative to other tabs and whether they are active, you must define them in sets for a combination of active and inactive tab colors.

### Image: Active General tab with inactive tabs

The following is an image of Active General tab with inactive tabs



The tab image names reflect the role of the image in the tab row and the colors that it uses. Colors are encoded using the 6-character, hexadecimal RGB value of the color.

When the system displays tabs on a page, it verifies the existence of all of the images that are required for the pair of colors that is specified by the active and inactive tab styles. If the system finds these images, the tabs are drawn using these colors. If the system cannot find the images, it uses white (FFFFFF) for the active tab and blue (6666FF) for the inactive tab. If the images for these colors are not in the database, then the tabs do not appear at all.

### Classic Tab Image Naming Scheme

This topic details how classic tab images are named. However, to change tab colors, change only the RGB values.

All tab images are named in this format:

PT\_TABNABRRGGBB

- PT\_TAB: System-defined image definition name prefix.
- N: HTML table row.

Values are 1, 2, or 3. Create images only for 2 or 3.

- A: Location of the tab parts in a tab.

Values are:

- L: Left end.
- B: Between.
- R: Right end.
- M: Middle of a tab.

- BB: Relative position to other tabs.

Values are:

- AI: Piece between active and inactive.
- IA: Piece between inactive and active.
- II: Piece between two inactive tabs.
- AX: Piece of an active tab.
- IX: Piece of an inactive tab.

- RRGGBB is either omitted (when the tab image does not use any color), or is one or two 6-character hexadecimal codes for inactive and active tab colors.

---

## Modifying Classic Style Sheet Tabs

This section discusses how to create tab images.

### Creating Tab Images

Before you can assign a new background color to the active or inactive tabs, you must create the necessary tab images with that color.

To produce tabs in a different color combination:

1. Open the image definitions for the tabs that you want to change.

Because you want to change only the color of tabs, open only those image definitions that already contain an RGB color code.

If you are changing both the active and inactive tab color, access these image definitions:

- PT\_TAB2LAXFFFFFFF
- PT\_TAB2RAXFFFFFFF
- PT\_TAB2LIXB8B090

- PT\_TAB2RIXB8B090
- PT\_TAB2BAIB8B090FFFFFF
- PT\_TAB2BIAB8B090FFFFFF
- PT\_TAB2BIIB8B090
- PT\_TAB3LAXFFFFFF
- PT\_TAB3RAXFFFFFF
- PT\_TAB3MAXFFFFFF
- PT\_TAB3LIXB8B090
- PT\_TAB3RIXB8B090
- PT\_TAB3MIXB8B090
- PT\_TAB3BAIB8B090FFFFFF
- PT\_TAB3BIAB8B090FFFFFF
- PT\_TAB3BIIB8B090

If you are changing only the inactive color, which is beige, you only need the files that contain the beige color code, B8B090. Similarly, if you are changing only the active tab color, which is white, you only need the files that include FFFFFFFF. However, for the changes to apply, you must change all those files with that color code. If one file is missed or a file name has a typographical error, the default style still applies.

2. To export the file to a directory, select File > Export Image.
3. In the Save Image dialog box, select the directory in which you want to place the image.
4. Use any image editor to alter the image colors.

---

**Note:** Do not change the size or shape of the images and do not replace any of the transparent pixels with solid pixels.

---

5. In PeopleSoft Application Designer, add the new image definitions by selecting File > New > Image.

Save the new image files under the appropriate name. The new images must have new names reflecting the HTML colors that they represent. For example, replace FFFFFFFF with the new active tab color, and replace B8B090 with the new inactive tab color. Be careful when naming these images. If the images with the correct colors for the tab style are not in the database, the system automatically applies the default images.

6. Open the appropriate style sheet.

If you are changing the tab folder colors, use PSSTYLEDEF. If you are changing grid tabs, use PSSTYLEDEF or the style sheet that is associated with the page definition in which the grid is located.

---

**Note:** You can set the grid tab styles for each grid individually using the grid properties. However, for page tabs, you can set the styles using only the default styles in the application style sheet.

---

You must access PSACTIVETAB, PSINACTIVETAB, and any other tab classes that your application uses (for example, PSLEVEL1GRIDACTIVETAB).

7. For folder tabs, open the PSACTIVETAB class by double-clicking the class name.
8. On the Background tab, select the color of the background of the active tab (matching the color of the tab image that you created).  
  
Use the drop-down list box to find the color or browse through the color choices.
9. Do the same for the PSINACTIVETAB class (or any others that you need) for folder tabs by double-clicking the class name and selecting the Background tab.
10. For grid tabs, access the style class that is associated with the grid tab.
11. Change the colors as indicated in the previous steps.
12. Save the style sheet.

## Examples

This is an example of folder tabs with a green background. In addition, the color of the text on the tabs was changed to black:

### Image: Example of green tabs

The following image is an example of folder tabs with a green background with the color of the text on the tabs changed to black



In the example, the active tab color stayed the same (FFFFFF). Only the inactive tab color changed. Therefore, only these files were created and added to the list of images:

- PT\_TAB2LIX80FF80
- PT\_TAB2RIX80FF80
- PT\_TAB2BAI80FF80FFFFFF
- PT\_TAB2BIA80FF80FFFFFF
- PT\_TAB2BII80FF80
- PT\_TAB3LIX80FF80
- PT\_TAB3RIX80FF80
- PT\_TAB3MIX80FF80
- PT\_TAB3BAI80FF80FFFFFF

- PT\_TAB3BIA80FF80FFFFFFF
- PT\_TAB3BII80FF80

**Related Links**

[Style Sheets Definitions List](#)



# Using Images in PeopleSoft Applications

## Understanding Image-Related Elements

You find images throughout PeopleSoft applications. Images serve many purposes such as identifying an employee or indicating to a user their current step in a series of steps in a process. PeopleSoft Application Designer offers several image-related elements, each of which you use depending on the purpose of the image. The following table describes the usage of each image-related element and provides an example of it:

<i>Image-Related Feature</i>	<i>Usage</i>	<i>Example</i>
Image field	Use to create a field in a database table that stores images in a user-defined format, such as portable network graphic (PNG) or bitmap (BMP). Like all fields, you place image fields in record definitions.	The EMPLOYEE_PHOTO field is an image field in the EMPLOYEE_PHOTO record definition.
ImageReference field	Use to create a field in a derive/work table that temporarily holds an image that can change programmatically at runtime using PeopleCode. Like all fields, you place image fields in record definitions.	The LOGO field is an image reference field that appears in the TE_HTL_LIST derived work record definition.
Image definition	Use to store an image file as a PeopleTools-managed item in the image catalog.	For example, the spinning image that appears when the system processes user information is the PT_PROCESSING image definition
Image control	Use to display image data that is stored in image fields in the database.	For example, an image control appears on the EMPLOYEE_PHOTO page; this control references the EMPLOYEE_PHOTO record field.
Static image control	Use to display a static image that is stored in the image catalog.	For example, a static image control appears on the COMPANY_CAR page; this control references the CAR_STOCK image in the image catalog.

### Related Links

[Specifying Image Field Attributes](#)

[Specifying ImageReference Field Attributes](#)

[Setting Image Properties](#)

[Setting Static Image Properties](#)

## Using PeopleTools Image Definitions

All PeopleSoft applications include a common set of PeopleTools images that in the image catalog. If you use PeopleTools images when developing your own applications, you should use each image in a way that is consistent with its use in PeopleSoft applications.

**Important!** Do not change PeopleTools image definitions. If you want to change a PeopleTools image definition, copy it and then modify the copy.

The following list contains many common PeopleTools images and their standard usage; the list is not exhaustive. The images are categorized by function and listed alphabetically by image name.

### General Images



PT\_ABORT: Abort a transaction. Used in some PeopleCode message boxes.



PT\_APPLY: Apply changes that were made to the database. Usually found when transferring to another page through PeopleCode.



PT\_CALENDAR: Open the calendar prompt.



PT\_COPYURL: Used in the pagebar. Copy contents of address bar to the clipboard.



PT\_IGNORE: Used in some PeopleCode message boxes.

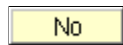

PT\_NO: Used in some PeopleCode message boxes.

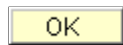

PT\_OK: Accept the input on a secondary page and return to the main page.



PT\_POPUP: Open a pop-up menu from which the user can select a page to which to transfer.



PT\_POPUP\_SKIP: Use if a pop-up menu has only one menu item to select from; bring the user directly to a page.



PT\_PRINT: Open the print dialog box for the designated item.



PT\_PROCESSING: Appears as animated image while accessing a server or database.



PT\_PROMPT\_LOOKUP: Lookup button for a field prompt table.



PT\_SPELLCHECK: Opens the spell check page for the current field.





PT\_REPORT\_DIST\_ICN: Usually found on the Process Scheduler Request page, this button takes you to the Distribution Detail page. Use to select roles and users who can access or receive an email of report output.

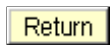

PT\_SEC\_RETURN: Return from a secondary page to the main (calling) page.



PT\_WF\_ACTIVITY: Used for a subprocess of the business task for workflow, consisting of one or more steps.



PT\_WF\_BUSPROC: Depict a complete business task for workflow.



PT\_WF\_STEP: Show a discrete step in the business process that corresponds to a single transaction that is performed on an application page or through an external program.

## Scroll or Grid Action Images

Use these images when creating scroll areas, scroll bars, and grids.



PT\_ADD: Add a row button.

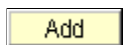

PT\_ADD\_LARGE: Add a large row button. Alternative to PT\_ADD if the page has enough room.



PT\_DELETE: Delete a row button.

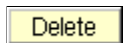

PT\_DELETE\_LARGE: Delete a large row button. Alternative to PT\_DELETE if the page has enough room.



PT\_GRID\_NO\_TABS: Expand grid button. Expand grid columns horizontally so that grid tabs no longer show.



PT\_GRID\_SHOW\_TABS: Tabbed grid button. Collapse grid columns horizontally so that grid tabs show.



PT\_NEXTROW: View the next row button.



PT\_PREVIOUSROW: View the previous row button.

## Tab Images

Use these images to change the look of both folder and grid tabs.



PT\_TAB\_LSCROLL: Scroll left to the previous tab in a page or grid.



PT\_TAB\_RSCROLL: Scroll right to the next tab in a page or grid.



PT\_TABxxx through PT\_TABxxxxxxxx: Selection of more than 80 images you can use to create folder tabs.

## Lookup and Search Page Images

Use these images on lookup and search pages.



PT\_CANCEL: Cancel a lookup page.

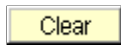

PT\_CLEAR: Clear search criteria from the page (appears only on an Advanced Search/Lookup page).



PT\_LOOKUP: Begin looking up data.



PT\_SEARCH: Start a search on the search page.

## Query Images



PT\_QUERY\_ADD\_CRITERIA: Add criteria to a query.



PT\_QUERY\_KEY: Denotes a query key field.



PT\_QUERY\_SORT: Sort query fields alphabetically.

## Tree Images

Use these tree images with PeopleSoft Tree Manager.

Tree node and leaf images include:



PSTREEMGR\_COL\_BRANCH: Identifies the root node for a branch.



PSTREEMGR\_COL\_NODE: Standard node image.



PSTREEMGR\_COL\_SKNODE: Tree node that has skipped a level.



PSTREEMGR\_END\_NODE: Tree node that has no children; that is, a terminal node.



PSTREEMGR\_EXP\_BRANCH: Root node on a branched tree.



PSTREEMGR\_EXP\_NODE: Expanded node.



PSTREEMGR\_EXP\_SKNODE: Expanded node that has skipped a level.



PSTREEMGR\_LEAF: Lowest-level detail value of a tree.

Node and leaf command button images include:



PTTREE\_ADDCHILD: Add a new child node.



PTTREE\_ADDLEAF: Add a new detail value, such as a leaf.



PTTREE\_ADDSIB: Add a new node as a sibling to the selected node.



PTTREE\_CUT: Cut a node or leaf and place it on the clipboard.



PTTREE\_DELETELEAF: Delete a leaf.



PTTREE\_DELETENODE: Delete a node.



PTTREE\_DISP\_AS\_ROOT: Redisplay the tree, starting with the currently selected node being displayed as the root node.



PTTREE\_EDITDATA: Display the underlying user data page.



PTTREE\_MAKEBRANCH: Create a new tree branch, starting with the selected node.



PTTREE\_PASTECHILD: Paste the node on the clipboard as a child of the currently selected node.



PTTREE\_PASTESIB: Paste the node on the clipboard as a sibling of the currently selected node.



PTTREE\_UNBRANCH: Unbranch a branch.



PTTREE\_UPDATELEAF: Update the values and properties for a leaf.



PTTREE\_UPDATENODE: Update the value or properties for a node.

## Portal Images

Use these images to perform a specific action. Additional portal images, such as PT\_PORTAL\_HEADER\_BG, are purely aesthetic. In general, all images that are reserved for the portal contain the word *PORTAL* in the image name, such as PT\_PORTAL\_SEPARATOR.



PT\_PORTAL\_DOWN\_ARROW\_Y: Move a pagelet down when personalizing a portal layout.



PT\_PORTAL\_IC\_CLOSE: Remove a pagelet from a homepage.

## Toolbar Button Images

Toolbar buttons are HTML buttons, not images. HTML defines the buttons and the text on the buttons. To modify toolbar buttons, use a style class.

See [Setting Style Class Attributes](#).

---

**Note:** Icons that appear on toolbar buttons are images.

---



---

## Generating a List of Images in the Image Catalog

To generate a list of images in the image catalog, you can:

- In PeopleSoft Application Designer, select File > Open > Image and click the Open button.
- In the query tool for your database platform, enter and run this SQL statement to list all image definitions:

```
SELECT DISTINCT CONTNAME FROM PSCONTDEFN WHERE CONTTYPE = 1.
```

- In the query tool for your database platform, enter and run this SQL statement to the language-dependent versions of images, :

```
SELECT CONTNAME, LANGUAGE_CD, CONTTYPE CONTFMT DESCR FROM  
PSCONTDEFNLANG WHERE CONTTYPE = 1
```

---

**Note:** Before signing into PeopleSoft Application Designer in a different language, you must enable the language support. Use PeopleTools Utilities to enable support.

---

- Create a query definition in PSQuery that uses the PSCONTDEFN record, the CONTNAME field from that record, and select for images where the CONTTYPE = 1 only.

---

## Viewing All Images in the Image Catalog

You might want to see the images that exist in the image catalog. PeopleSoft Application Designer enables you to see some of the image definitions. However, you have to open each image definition. You can view all images online by creating a custom component. The elements of the component should include:

1. A record definition that contains one long character field.
2. A page definition that contains an HTML area you associate to the record field.
3. A SQL definition that retrieves the names of all image definitions in the image catalog.
4. A PeopleCode program that generates text in HTML format.

The program should generate the HTML by looping through and enclosing each image definition name in the appropriate HTML and meta-HTML tags. The program can also add the image name and

a line break so that the page is crisper. The program must concatenate the lines together to form the HTML as a string. Each line of HTML should look similar to this line:

```
|"<img src='%Image("&ImageDefinitionName|")' />"|&ImageDefinitionName|"<BR />"=>
```

Finally, the program must assign the string output to the HTML record field that you associated to the HTML area.

After you create the component, you must register it and grant the appropriate permissions. Then you can access the page and view the images.



# Performing Bulk Operations

---

## Understanding Bulk Operations

PeopleTools enables administrators to perform bulk operations on fields that might be in many different records or pages.

---

**Note:** For security reasons, only those users logged in to PeopleSoft Application Designer using the PeopleSoft Administrator role have access to the Bulk Operations menu items. For all other users, these menu options are disabled. To gain access, navigate to PeopleTools > Security > User Profiles > User Profiles > Roles tab.

---

Bulk operations are useful for financial ChartFields. *ChartField* is an accounting term that describes a small group of character fields, typically 5 to 20, that are present in many records and pages. ChartFields can be between 1 and 30 characters long, with an average length of 10. They often identify organization-wide attributes, such as DEPTID (department identification).

---

**Important!** Many PeopleSoft financial applications have a standardized way to modify ChartFields by using standard pages and their corresponding PeopleCode. PeopleSoft FSCM applications do more than just invoke the bulk operations to modify ChartFields. For this reason, users of these applications should follow the applications guidelines rather than using these bulk operations menu items in PeopleSoft Application Designer. Consult your application to ensure that you are using the appropriate mechanism to update your ChartFields before using the PeopleSoft Application Designer Bulk Operations tool.

---

---

## Performing Bulk Insertions

To perform bulk insertions using PeopleSoft Application Designer, select Tools > Bulk Operations > Insert.

This section lists common elements and discusses how to insert:

- Fields into records.
- Record fields onto pages.
- Fields into records and onto pages.

---

**Note:** If you try to insert a field that is already present in a record or on a page, no processing occurs.

---

## Common Elements Used in This Section

<b>Model Field</b>	Specify a field with record attributes that you want to copy to all inserted fields.
<b>Clone PeopleCode of model field</b>	Select if you want PeopleCode in the record fields to be copied and references modified to the inserted field.

## Inserting Fields into Records

To perform bulk insertions using PeopleSoft Application Designer, select Tools > Bulk Operations > Insert.

You can insert a source field into selected records only if the model field exists in those records. The source field is assigned the same record field properties as the model field in each record and is inserted immediately following the model field.

If the model field has a prompt table, then the system creates a prompt table for the source field by using the name of the source field with *TBL* appended to it.

If the record is either a SQL view or a dynamic view type, then the system modifies the associated SQL by expanding the SELECT clause to include the new field.

If the record is a subrecord, then the system updates the parent records of the SQL view or dynamic view type that contain this subrecord. If the SQL contains the model field in the WHERE clause or if the SQL is complex, then the system inserts the associated record into a project called BLK\_<SOURCEFIELDNAME> and displays a status message. Examine the contents of that project after the operation completes to verify successful completion.

If the model field has PeopleCode associated with it in the record or in a component, then the system copies this PeopleCode to the new field with all of the references to the model field changed to refer to the new field.

---

**Note:** Because performing this operation changes records that are used to build application tables, you must rebuild (alter) the database before these changes can be used.

---

## Inserting Record Fields onto Pages

To perform bulk insertions by using PeopleSoft Application Designer, select Tools > Bulk Operations > Insert.

This operation inserts the specified record field onto each page that is listed if the model field exists on the page.

If the model field is in a grid, the system inserts the new field into the grid next to the model field and assigns it the same page field properties.

If the model field is not in a grid, the system inserts the new field to the right of the model field (in the first open space) and assigns it the same page field properties. If the system detects a questionable field position, it inserts the page into a project called BLK\_<SOURCEFIELDNAME> and displays a status message. Examine that project after the operation completes to verify successful completion.



The page field name property is not cloned if it exists on the model field. Instead, the system uses the name of the new field because the page field name should be a unique identifier for page elements.

---

**Note:** You do not need to rebuild the database after performing this operation. The changes take effect when you open the page.

---

<b>Record Name</b>	Enter the record name containing the field to insert onto the pages.
<b>Get Pages from Project</b>	Specify the project name containing the pages to modify.
<b>Get Records from Project</b>	Specify the project containing the records to modify.

## Inserting Fields into Records and onto Pages

To perform bulk insertions by using PeopleSoft Application Designer, select Tools > Bulk Operations > Insert.

This operation is a combination of inserting fields into records and inserting record fields onto pages. The system examines each record to see if a model field exists. If so, it inserts the source field (including all field properties, PeopleCode, and SQL additions to itself and parent records) after the model field. Then, for each record, the system checks all pages to see if the new record field should be inserted.

If the system detects a questionable field position, it inserts the page into a project called BLK\_<SOURCEFIELDNAME> and displays a status message. Examine that project after the operation completes.

**Get Records and Pages from Project** Specify the project containing the records and pages to modify.

---

## Performing Bulk Modifications

To perform bulk modifications by using PeopleSoft Application Designer, select Tools > Bulk Operations > Modify.

This section discusses how to:

- Modify record fields.
- Modify page fields.
- Reorder or resize grid fields.
- Change page field attributes.

## Modifying Record Fields

To perform bulk modifications by using PeopleSoft Application Designer, select Tools > Bulk Operations > Modify.

Use this operation to modify record fields by applying record field properties to a field in a set of records. All of the properties that are associated with the page are set for the record field in the listed records. Therefore, after this operation completes, the source field in these records contains identical record field properties.

---

**Note:** In most cases, you must rebuild the database for these attributes to take effect.

---

<b>Field will be modified on records from Project</b>	Specify the project name containing the record fields to modify.
<b>Records</b>	Specify the records containing the fields with attributes that you want to modify.
<b>Change Attributes</b>	Click to open the menu to select specific attributes. Enter the appropriate attributes for the modified fields.

## Modifying Page Fields

To perform bulk modifications by using PeopleSoft Application Designer, select Tools > Bulk Operations > Modify.

Use this operation to modify page fields in a variety of ways. You can specify a source field list from a list of fields, records, pages, or projects. You can only modify page field attributes on a single field at a time; therefore, if you do not specify a single field, the Change Attributes button is unavailable.

<b>Field, From Record, From Page, and From Project</b>	Specify the source that is used to populate the Fields to be modified list.
<b>Get Pages from Project</b>	Specify the project that is used to populate the Pages to be modified list.
<b>Reorder/Resize Grid Fields</b>	Click to access the Modify Order of Page Grid Fields dialog box and specify the order and width of the Fields to be modified fields on all listed pages.
<b>Change Attributes</b>	Click to access the Modify Page Field Attribute dialog box and specify the attributes of the field on all listed pages.

## Reordering or Resizing Grid Fields

To perform bulk modifications by using PeopleSoft Application Designer, select Tools > Bulk Operations > Modify.

You can rearrange columns as needed, and the order is applied on target pages. The reordering algorithm groups the fields together at the first instance of any of the fields in a target page grid and forces the remaining fields into the specified order.

Pages that have these fields outside of grids are not affected by these changes. The resize operation applies only to grid column widths.

This example shows the Modify Order of Page Grid Fields dialog box:

**Image: Modify Order of Page Grid Fields dialog box**

This example illustrates the fields and controls on the Modify Order of Page Grid Fields dialog box. You can find definitions for the fields and controls later on this page.

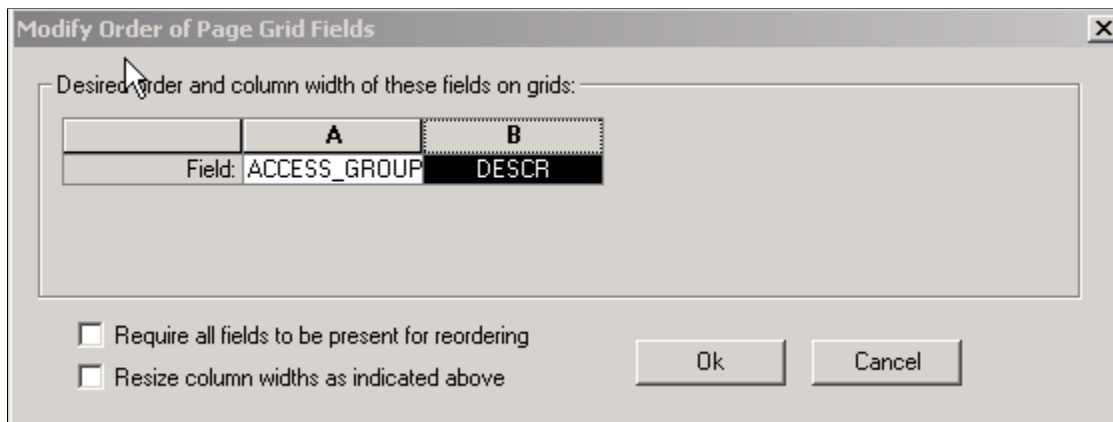

**Require all fields to be present for reordering**

Select if you do not want to modify pages that do not have all of the fields in the grid.

**Resize column widths as indicated above**

Select to resize the columns to the column widths that are defined.

---

**Note:** These changes take effect immediately; no database build is required.

---

## Changing Page Field Attributes

To perform bulk modifications by using PeopleSoft Application Designer, select Tools > Bulk Operations > Modify.

Like record field attributes, you can modify page field attributes for the selected field (on the selected set of pages) by using the Modify Page Field Attribute dialog box. The system applies all of the attributes on the screen to the page field on all pages.

## Performing Bulk Deletions

To perform bulk deletions by using PeopleSoft Application Designer, select Tools > Bulk Operations > Delete.

Use the delete operation to:

- Remove the field from a list of pages, regardless of where the field exists on the page or whether it is in a grid.
- Remove the field from the list of records.

The delete operation removes associated PeopleCode and modifies associated SQL either in the record or, if the record is a subrecord, in parent records.

If the field is in the SELECT clause of the SQL, the removal is straightforward. However, if the field is also used in a WHERE clause or if the field is the only item in the SELECT clause, then the record is not modified. Instead, it is inserted into a project called BLK\_<SOURCEFIELDNAME> as noted in messages in the status screen.

---

**Note:** Users should examine a project with a targeted field in SQL statements individually to delete the field as required from the associated SQL.

---

Deleting fields from records and pages does *not* remove the field definition itself and does not remove the field from other applications, such as BI Publisher.

---

**Note:** Because performing this operation changes records, you must subsequently rebuild the database because each application data table is based on the record definition.

---

# Running PeopleTools Cross-Reference Reports

---

## Understanding Cross-Reference Reports

Using PeopleTools, you can create new applications by defining menus and pages that you use to enter data and database tables. PeopleTools includes a variety of cross-reference reports (similar to blueprints) that guide you through the definitions (such as menus, pages, and records) that are delivered with the system and those that you create or adapt with PeopleTools.

PeopleTools cross-reference reports are predefined SQR reports, not unlike the standard reports that are delivered with the PeopleSoft application. Like other standard reports, you can identify cross-reference reports by the three-character prefix XRF. The reports provide several views of the application, ranging from high-level lists of the windows, menus, and pages to the detailed database attributes of fields.

---

**Note:** Cross-reference reports are delivered in SQR format.

---

You should already be familiar with the types of definitions that are delivered with the PeopleSoft application, as well as with PeopleTools and relational databases.

This table describes the cross-reference reports:

<b>Report</b>	<b>ID</b>	<b>Description</b>
Fields and Pages	XRFFLPN	Lists all fields in alphabetical order. It includes the names of all record and page definitions in which the fields occur and lists the field long names.
Fields and Records	XRFR CFL	Lists all fields in alphabetical order by the associated record definition name. It details the field long name, type, length, and formatting.
Records and Fields	XRFFLRC	Lists all fields in alphabetical order. It includes the field long name, type, length, and formatting, as well as the names of all record definitions that contain the field.
Applications and Fields	XRFAPFL	Lists all menus, such as general tables, in alphabetical order, including the fields in each menu. For each field, it lists the field name, type, length, and format, as well as all record and page definitions that contain the field (in the window).

<b>Report</b>	<b>ID</b>	<b>Description</b>
Fields Referenced by PeopleCode Programs	XRFFLPC	Lists all PeopleCode programs in alphabetical order by the associated record definition and field. It includes the types of fields that are referenced in the PeopleCode program.
Field Listing	XRFIELDS	Lists all fields in alphabetical order. It includes field type, length, format, long name, and short name.
Menu Listing	XRFMENU	Lists all menus in alphabetical order, including all page definitions in each menu. It includes the associated search record definition name and detail page definition name.
Page Listing	XRFPAGE	Lists all page definitions in alphabetical order.
PeopleCode Programs and Field References	XRFPCFL	Lists record definitions that contain fields with PeopleCode program attributes. It includes the field name, as well as the associated record definitions and fields that are referenced in the PeopleCode program.
Pages with PeopleCode	XRFNPC	Lists all pages that contain fields with PeopleCode attributes. For each page, it includes the name of the record definitions that contain the field, as well as the field name and type.
Records and Pages	XRFRCPN	Lists all record definitions in alphabetical order. It includes the menu and page definitions that are associated with each record definition.
Window Listing	XRFWIN	Lists all application menu windows in alphabetical order.

**Note:** In addition to standard cross-reference reports, if you are familiar with the PeopleSoft database you can generate additional ad hoc reports to extract the exact combination of information that you need.

## Running SQR Reports

This section discusses how to generate Field Cross Reference (XRFIELDS) reports.

You run cross-reference reports on the Process Scheduler Request page.

Access the Process Scheduler Request page.

1. Select PeopleTools >Process Scheduler >System Process Requests.

The Sample Processes search page appears.

2. Click Add a New Value.
3. Enter a run control ID.
4. Click Add.
5. Click Run.

The Process Scheduler Request page appears.

### Image: Process Scheduler Request page

This example illustrates the fields and controls on the Process Scheduler Request page.

Select	Description	Process Name	Process Type	*Type	*Format	Distribution	File Dependency
<input type="checkbox"/>	Generates 2 Copies of XRFWIN	XRFWIN2	SQR Report	Web	PDF	<a href="#">Distribution</a>	
<input type="checkbox"/>	Cross Reference Window Listing	XRFWIN	SQR Report	Web	PDF	<a href="#">Distribution</a>	
<input type="checkbox"/>	XRFWIN	XRFWIN	BOE Report	Web	PDF	<a href="#">Distribution</a>	
<input type="checkbox"/>	Cross Reference Window Listing	XRFWIN	BI Publisher	Web	HTM	<a href="#">Distribution</a>	
<input type="checkbox"/>	Cross Reference - Records and	XRFRCPN	SQR Report	Web	PDF	<a href="#">Distribution</a>	
<input type="checkbox"/>	Cross Reference - Records and	XRFR CFL	SQR Report	Web	PDF	<a href="#">Distribution</a>	
<input type="checkbox"/>	Cross Reference - Panels with	XRFNPC	SQR Report	Web	PDF	<a href="#">Distribution</a>	
<input type="checkbox"/>	PeopleCode and Field Cross Ref	XRFP CFL	SQR Report	Web	PDF	<a href="#">Distribution</a>	
<input type="checkbox"/>	Panel Cross Reference Report	XRF PANEL	SQR Report	Web	PDF	<a href="#">Distribution</a>	
<input type="checkbox"/>	Menu Listing Report	XRF MENU	SQR Report	Web	PDF	<a href="#">Distribution</a>	
<input type="checkbox"/>	Cross Reference Field Listing	XRFIELDS	SQR Report	Web	PDF	<a href="#">Distribution</a>	

6. Select the row in the Process List grid containing the attributes *Cross Reference Field Listing*, *XRFIELDS*, and *SQR Report* options by clicking the Select check box next to each of these values in the Process List grid.
7. Click OK to generate a formatted display of this SQR report in HTML.





# Creating Custom Plug-In Files for the Rich Text Editor

---

## Creating Custom Buttons

Plug-ins enable you to add custom buttons to the rich text editor toolbar.

To create custom buttons:

1. Create a new HTML definition and save it with the prefix `PT_RTE_PLUGIN_`, for example, `PT_RTE_PLUGIN_MYPLUGIN`.
2. Use JavaScript to code the functionality of the button in the HTML definition. This is sample code for a button that will create a new page:

```
CKEDITOR.plugins.add( 'TestPlugin',
{
  init : function( editor )
  {

    editor.addCommand( 'Oracle_New_Page',
    {
      modes : { wysiwyg:1, source:1 },

      exec : function( editor )
      {
        editor.setData( editor.config.newpage_html );
        editor.focus();
      }
    });
    var iconpath= CKEDITOR.getUrl('skins/' + editor.config.skin + '/icons.png'
    );
    editor.ui.addButton( 'TestPlugin',
    {
      label : '?Oracle_New_Page?',
      command : 'Oracle_New_Page',
      icon: iconpath,
      iconOffset : 0
    });
  }
});
```

---

## Using Images with Plug-Ins

To use images with plug-ins:

1. Add the images to the database by creating new image definitions in PeopleSoft Application Designer.
2. Create an iScript method to download the images you need for the plug-in, for example:

```
Function IScript_ GetImages
```

```

    &ImageUrl = %Response.GetImageUrl (Image.XYZ);
    %Response.Write (&ImageUrl);
End-Function;

```

3. Send an AJAX request from the plug-in to the iScript method.

The response is the image URL.

4. Use the image URL to display the image for the plug-in.

## Adding Multilingual Support

To add multilingual support to the button:

1. Add any Message Catalog entries necessary for multilingual support.
2. Create an iScript method to get the language-specific information from the Message Catalog. This is an example:

```

Function IScript_GetData
    %Response.Write (MsgGetText (1234, 1, "Message not found.));
End-Function;

```

3. Send an AJAX request from the plug-in to the iScript method.

The response is the language-specific information.

4. Use the data as the new language information for the button.

## Adding Plug-Ins to the Configuration File

To add plug-ins to the configuration file:

1. Add the new toolbar button to the toolbar set in the configuration file.

This is an example of the code for the new Oracle\_New\_Page button:

```

CKEDITOR.config.toolbar =
[
    ['Preview', 'Print', '-', 'Cut', 'Copy', 'Paste', '-', 'Undo', 'Redo', '-', 'Find', 'Rep⇒
lace', 'Oracle_New_Page']
];

```

2. Add the plug-in that hosts the new button.

This is an example of the code:

```

                CKEDITOR.plugins.addExternal( 'Oracle_New_Page', CKEDITOR.con⇒
fig.PluginPath );
CKEDITOR.config.plugins += ', 'Oracle_New_Page';

CKEDITOR.config.toolbar =
[
    ['Preview', 'Print', '-', 'Cut', 'Copy', 'Paste', '-', 'Undo', 'Redo', '-', 'Find', 'Rep⇒
lace', 'Oracle_New_Page']
];

```

```
];
```

If you are displaying the rich text editor in a limited space, you must group the editor controls using brackets [ ], as you see in this example:

```
config.toolbar =  
[  
    ['Maximize','Preview','Print'], ['Cut','Copy','Paste'], ['Undo','Redo'], ['Find',  
d','Replace'],  
    ['HorizontalRule','Table','imageUPLOAD'], ['Link','Unlink','SpecialChar'],  
    ['Format','Font','FontSize'], ['Bold','Italic','Underline','Strike'],  
    ['JustifyLeft','JustifyCenter'], ['JustifyRight','JustifyBlock'],  
    ['NumberedList','BulletedList'], ['Outdent','Indent'],  
    ['TextColor','BGColor']  
];
```

If you do not group the editor controls in this way, the application will not render the editor correctly.

---

## Specifying the Plug-In File ID Value

To specify the plug-in File ID value:

1. In PeopleSoft Application Designer, access the properties for the rich text-enabled long edit box.
2. Click the Options tab.
3. Select the name of the plug-in file from the Plugin File Id drop-down list box.
4. Save the page definition.



# Configuring Rich Text-Enabled Fields to Store Accented Western European Characters

---

## Enabling Field-Level Support For Accented Characters

By default, when you enter accented Western European characters in a rich text-enabled field, the rich text editor encodes the accented characters as HTML entities before the system stores the data in the database. For example, the word *Französisch* is stored as `<p>Franz&ouml;sisch</p>`. As a result of being encoded as HTML entities, the characters (and affected data) appear as the user entered the data only when viewed in HTML, such as on a transaction page. When the data is viewed in a non-HTML format, such as reporting, searches, queries, or direct SQL, the characters do not appear as expected.

You can enable support for accented characters at these two levels:

- The individual rich text field.
- System-wide.

To enable support for accented characters at the individual field level:

1. Create a custom HTML definition for the specific field.

See [Creating Custom Configurations](#).

2. Add these two lines to the HTML in the definition:

```
CKEDITOR.config.entities_latin = false;
CKEDITOR.config.entities_greek = false;
```

3. Save the HTML definition.

---

**Important!** You must use this naming convention: `PT_RTE_CFG_<name>`.

---

4. To use the new configuration, open the Long Edit Box Page Field Properties dialog box; select the Options tab; click the Configuration Settings Iddrop-down list box; and then select the HTML definition name from the list of values that appear.

See [Setting Page Field Properties for Controls](#).

5. Click the OK button and save the page definition.

## Sample HTML

The two relevant lines of code appear in bold in this sample HTML:

```

/*
Copyright (c) 2003-2009, CKSource - Frederico Knabben. All rights reserved.
For licensing, see LICENSE.html or http://ckeditor.com/license
*/

CKEDITOR.config.entities_latin = false;CKEDITOR.config.entities_greek = false;
CKEDITOR.editorConfig = function( config )
{
    // Define changes to default configuration here. For example:
    // config.autoLanguage = false;
    // config.defaultLanguage = 'pt-br';
    config.skin='office2003';
    config.resize_enabled = false;
    config.removePlugins = 'elementspath';

    config.toolbar =
    [
        ['Maximize','Preview','Print','-','Cut','Copy','Paste','-','Undo','Redo','-','Find',
        'Replace','-','HorizontalRule','Table','imageUPLOAD','Link','Unlink','SpecialChar',
        ],
        ['Format','Font','FontSize','-','Bold','Italic','Underline','Strike'],
        ['JustifyLeft','JustifyCenter','JustifyRight','JustifyBlock','-','NumberedList','BulletedList','Outdent','Indent','-','TextColor','BGColor']
    ];

    config.keystrokes =
    [
        [ CKEDITOR.ALT + 121 /*F10*/, 'toolbarFocus' ],
        [ CKEDITOR.ALT + 122 /*F11*/, 'elementsPathFocus' ],
        [ CKEDITOR.SHIFT + 121 /*F10*/, 'contextMenu' ],
        [ CKEDITOR.CTRL + 90 /*Z*/, 'undo' ],
        [ CKEDITOR.CTRL + 89 /*Y*/, 'redo' ],
        [ CKEDITOR.CTRL + CKEDITOR.SHIFT + 90 /*Z*/, 'redo' ],
        [ CKEDITOR.CTRL + 76 /*L*/, 'link' ],
        [ CKEDITOR.CTRL + CKEDITOR.SHIFT + 76 /*L*/, 'unlink' ],
        [ CKEDITOR.CTRL + 66 /*B*/, 'bold' ],
        [ CKEDITOR.CTRL + 73 /*I*/, 'italic' ],
        [ CKEDITOR.CTRL + 85 /*U*/, 'underline' ],
        [ CKEDITOR.CTRL + CKEDITOR.ALT + 13 /*ENTER*/, 'maximize' ],
        [ CKEDITOR.CTRL + 77 /*M*/, 'imageUPLOAD' ]
    ];

};

```

---

## Enabling System-Wide Support For Accented Characters

To enable system-wide support for accented characters in rich text fields:

1. Navigate to *PS\_HOME\webserv\your web server name\applications\peoplesoft\PORTAL.war\sitename\ckeditor*.
2. Open the *config\_psft.js* file, which is located in the *ckeditor* folder.
3. Add these two lines to the beginning of the configuration file:

```

CKEDITOR.config.entities_latin = false;

CKEDITOR.config.entities_greek = false;

```

4. Save the configuration file.
5. Restart the webserver.

---

## Sample config\_psft.js File

This is a sample configuration file:

```
/*
Copyright (c) 2003-2009, CKSource - Frederico Knabben. All rights reserved.
For licensing, see LICENSE.html or http://ckeditor.com/license
*/

CKEDITOR.config.entities_latin = false; CKEDITOR.config.entities_greek = false;
var ImageUpload = CKEDITOR.getUrl('imageupload.js');
CKEDITOR.plugins.addExternal( 'imageUPLOAD', ImageUpload );
CKEDITOR.config.plugins += ',imageUPLOAD';
CKEDITOR.config.plugins = CKEDITOR.config.plugins.replace(',image', '' );
CKEDITOR.config.menu_groups = CKEDITOR.config.menu_groups.replace(',image', '' );
CKEDITOR.config.menu_groups = CKEDITOR.config.menu_groups.replace(',imagebutton', '⇒
' );
CKEDITOR.config.menu_groups +=',imageUPLOAD';
CKEDITOR.config.scayt_autoStartup = false;
CKEDITOR.on( 'instanceReady', function( evt )
{
    function noBubbling( evt ) { evt.data.stopPropagation(); }
    // Stop keystroke event bubbling from editor chrome.
    var container = evt.editor.container;
    container.on( 'keydown', noBubbling );
    container.on( 'keypress', noBubbling );
    container.on( 'keyup', noBubbling );
});
```





# Configuring Embedded Help to Display UPK Content

---

## Modifying the UPK Player Package Link

As part of the embedded Help functionality, you can include links to Oracle UPK modules and topics.

To modify the UPK player package link:

1. Contact your UPK system administrator to obtain the player package link (URL). It should look similar to this:

*[http://upkservername/upk/content\\_subject/toc.html](http://upkservername/upk/content_subject/toc.html)*

2. Change the file name toc.html to kp.html so that the URL looks similar to this:

*[http://upkservername/upk/content\\_subject/kp.html](http://upkservername/upk/content_subject/kp.html)*

The kp.html file lists your UPK modules and topics. Pointing directly to the kp.html file, which is located in the player package folder, enables you to manually link to a specific mode for a topic.

3. Paste the link into your browser to access the file.
4. Find the topic that you want to use in embedded help, and then right-click the Concept or Do It link associated with the topic.

If you are creating task oriented related content, right-click the Do It link, otherwise click the Concept link.

5. From the pop-up menu, select Copy Shortcut or Copy Link Location. You will need the URL in the next topic, *Adding UPK-Based URLs to the Application*.

As an alternative, select Properties and then copy the URL that you see on the dialog box.

- For conceptual information, the URL should look similar to this:

*<http://upkserver/upk/hcmam91/tpc/1d1a9fb4-aa18-407a-b50c-f5e0e65e4bb8/index.html>*

- For task oriented information, the URL should look similar to this:

*[http://upkserver/upk/peopletools/dhtml\\_kp.html?Guid=69f0376e-70fc-417c-a43cecd6afb72b29&Mode=D&Back](http://upkserver/upk/peopletools/dhtml_kp.html?Guid=69f0376e-70fc-417c-a43cecd6afb72b29&Mode=D&Back)*

---

**Note:** The URL for each UPK mode ends differently. Look for &Mode= near the end of the URL.

---

This table lists the different URL endings and the corresponding UPK mode for each ending:

<b>URL Ending</b>	<b>UPK Mode</b>
&Mode=D	Do It
&Mode=K	Know It
&Mode=T	Try It
&Mode=S	See It
&Mode=P	Print It
Index.html	Concept

---

## Adding UPK-Based URLs to the Application

To add UPK-based URLs to the application:

1. Select Main Menu > PeopleTools > Utilities > Administration > URLs.
2. Add a new value, such as UPK\_QRY\_1.  
This is the URL identifier. You will need this later.
3. Click the Add button.
4. Enter a description.
5. Paste the URL the you copied in the previous topic into the URL field.
6. Remove *&Back* from the end of the URL so that the URL ends in the mode, for example, *&Mode=D*.
7. Save the URL.

---

## Embedding UPK-Based URLs in Messages

To embed UPK-based URLs in messages:

1. Select Administration from the drop-down menu, and then select Message Catalog.
2. Click Add a New Value.
3. Enter 21000. (You want to enter a value that isn't reserved by PeopleTools or PeopleSoft applications.)
4. Enter a description.
5. Enter message text.

---

**Note:** The message text is the link text that appears in the embedded help pop up. A phrase such as, "Show me" or another generic phrase works well.

---

6. Enter a description. In the description, include this code:

```
%PBURLTBL(URL_ID, setnbr, mnbr)
```

7. Replace *URL\_ID* with the URL identifier that you added earlier.
8. Replace *setnbr* with the set number of your message.
9. Replace *mnbr* with the message number of your message.

The following example would access the UPK\_QRY\_1 URL and display message set 3, message number six:

```
%PBURLTBL(UPK_QRY_1, 3, 61)
```

10. Save the message.

---

## Adding Embedded Help to Page Controls

To add embedded Help to page controls:

1. Open the page definition.
2. Double-click the scroll area or grid to access the properties dialog box.
3. Click the Label tab.
4. In the Embedded Help Popup section, select the Message Catalog Popup option.
5. Enter the Message Set/Number values of the message that you want to appear in the embedded help pop-up page.

The message should appear in the Text field.

6. Verify that the message in the Text field is correct.
7. Click the OK button.
8. Save the page definition.
9. In the browser, access the page and test the embedded help.

