

Oracle Financial Services Basel Regulatory Compliance

User Guide

Release 8.1.2.0.0

May 2022

ORACLE
Financial Services

Oracle Financial Services Basel Regulatory Compliance User Guide

Copyright © 2022 Oracle and/or its affiliates. All rights reserved.

This software and related documentation are provided under a license agreement containing restrictions on use and disclosure and are protected by intellectual property laws. Except as expressly permitted in your license agreement or allowed by law, you may not use, copy, reproduce, translate, broadcast, modify, license, transmit, distribute, exhibit, perform, publish, or display any part, in any form, or by any means. Reverse engineering, disassembly, or decompilation of this software, unless required by law for interoperability, is prohibited.

The information contained herein is subject to change without notice and is not warranted to be error-free. If you find any errors, please report them to us in writing.

If this is software or related documentation that is delivered to the U.S. Government or anyone licensing it on behalf of the U.S. Government, then the following notice is applicable.

U.S. GOVERNMENT END USERS: Oracle programs, including any operating system, integrated software, any programs installed on the hardware, and/or documentation, delivered to U.S. Government end users are “commercial computer software” pursuant to the applicable Federal Acquisition Regulation and agency-specific supplemental regulations. As such, use, duplication, disclosure, modification, and adaptation of the programs, including any operating system, integrated software, any programs installed on the hardware, and/or documentation, shall be subject to license terms and license restrictions applicable to the programs. No other rights are granted to the U.S. Government.

This software or hardware is developed for general use in a variety of information management applications. It is not developed or intended for use in any inherently dangerous applications, including applications that may create a risk of personal injury. If you use this software or hardware in dangerous applications, then you shall be responsible to take all appropriate fail-safe, backup, redundancy, and other measures to ensure its safe use. Oracle Corporation and its affiliates disclaim any liability for any damages caused by use of this software or hardware in dangerous applications.

Oracle and Java are registered trademarks of Oracle and/or its affiliates. Other names may be trademarks of their respective owners.

Intel and Intel Xeon are trademarks or registered trademarks of Intel Corporation. All SPARC trademarks are used under license and are trademarks or registered trademarks of SPARC International, Inc. AMD, Opteron, the AMD logo, and the AMD Opteron logo are trademarks or registered trademarks of Advanced Micro Devices. UNIX is a registered trademark of The Open Group.

This software or hardware and documentation may provide access to or information about content, products, and services from third parties. Oracle Corporation and its affiliates are not responsible for and expressly disclaim all warranties of any kind with respect to third-party content, products, and services unless otherwise set forth in an applicable agreement between you and Oracle. Oracle Corporation and its affiliates will not be responsible for any loss, costs, or damages incurred due to your access to or use of third-party content, products, or services, except as set forth in an applicable agreement between you and Oracle.

For information on third party licenses, see the [OFSAA Licensing Information User Manual](#).

Document Control

Version Number	Revision Date	Change Log
1.0	May 2022	Updated documentation for the 8.1.2 release of CAP

Table of Contents

1	Getting Started.....	XV
1.1	Intended Audience.....	xv
1.2	Conventions	xv
1.3	Installing this Major Release.....	xv
1.4	Related Information Sources.....	xvi
2	What's New in this Release	17
3	Introduction to Basel Regulatory Capital.....	18
3.1	Key Features.....	21
4	Overview of OFSAA Infrastructure.....	22
4.1	Components of OFSAAI.....	22
5	Application Processing.....	24
5.1	Data Requirements.....	24
5.2	Data Assumptions.....	24
5.2.1	<i>Data Loading</i>	25
5.2.2	<i>Reclassification Rules</i>	26
5.3	Processing.....	26
5.3.1	<i>Batch Processing</i>	27
5.3.2	<i>Basel Configurations</i>	27
5.3.3	<i>Reporting</i>	42
6	Bank for International Settlements (BIS)	43
6.1	Introduction of OFSAA Portfolio Definitions.....	43
6.1.1	<i>Banking</i>	44
6.1.2	<i>Investment</i>	45
6.1.3	<i>Derivative</i>	46
6.1.4	<i>Securities and Financing Transactions</i>	47
6.1.5	<i>Securitization</i>	48
6.1.6	<i>Credit Valuation Adjustment</i>	49
6.1.7	<i>Operational Risk</i>	50

6.2	Overview of Basel III.....	50
6.2.1	Credit RWA	51
6.2.2	Counterparty Credit RWA.....	51
6.2.3	Default Fund Contributions Related Capital Charge	51
6.2.4	Credit Valuation Adjustments.....	52
6.2.5	Credit RWA for Securitization	52
6.2.6	Market Risk RWA	52
6.2.7	Operational Risk RWA.....	52
6.2.8	Capital Structure	53
6.2.9	Capital Buffers.....	53
6.2.10	Large Exposures.....	54
6.2.11	Leverage Ratio.....	54
6.3	Overview of Basel III: Finalizing Post Crisis Reforms	54
7	Basel III Standardized Approach.....	56
7.1	Credit RWA.....	56
7.1.1	Banking Portfolio	56
7.1.2	Investment Portfolio.....	65
7.2	Counterparty Credit RWA.....	74
7.2.1	Derivatives Portfolio.....	74
7.2.2	Securities Financing Transactions Portfolio	84
7.2.3	Pooling and Optimizer	95
7.3	Default Fund Contributions Related Capital Charge	95
7.3.1	Capital Charge for Non-QCCP	96
7.3.2	Capital Charge for QCCP.....	96
7.4	Underlying Exposures Treatment	98
7.5	Credit RWA for Securitization.....	99
7.5.1	Securitization – Revised Framework.....	99
7.5.2	Rating Population	100
7.5.3	Data Population	101
7.5.4	Shareholding Percent Multiplication	102
7.5.5	Common Reclassification Rules	102
7.5.6	Asset Reclassification Rules	103

7.5.7	<i>Due Diligence Requirement for Securitization Exposures</i>	103
7.5.8	<i>Sec Approach Selection</i>	103
7.5.9	<i>Pooling and Optimizer</i>	109
7.6	Market Risk RWA	110
7.6.1	<i>Standardized Approach</i>	110
7.6.2	<i>Data Population</i>	111
7.6.3	<i>Shareholding Percent Multiplication</i>	111
7.6.4	<i>Currency Conversion</i>	112
7.6.5	<i>Common Reclassification Rules</i>	112
7.6.6	<i>Position Conversion</i>	112
7.6.7	<i>General Market Risk Charge Calculation</i>	117
7.6.8	<i>Specific Market Risk Charge Calculation</i>	119
7.7	Process Flow for Credit Valuation Adjustments	120
7.8	Credit Valuation Adjustments	120
7.8.1	<i>Assumptions</i>	121
7.8.2	<i>Process Flow for Credit Valuation Adjustments</i>	121
7.9	Operational Risk Portfolio	126
7.9.1	<i>Data Population</i>	128
7.9.2	<i>Shareholding Percent Multiplication</i>	129
7.9.3	<i>Reclassification Rules</i>	129
7.9.4	<i>Capital Charge Approaches</i>	129
7.9.5	<i>Key Data Elements</i>	135
7.10	Capital Structure	135
7.10.1	<i>Assumption</i>	136
7.10.2	<i>Data Population</i>	136
7.10.3	<i>Shareholding Percent Multiplication</i>	137
7.10.4	<i>Common Reclassification Rules</i>	137
7.10.5	<i>Gross Capital Calculations</i>	137
7.10.6	<i>Minority Interest Calculations</i>	138
7.10.7	<i>Internal Transactions Deduction</i>	138
7.10.8	<i>Regulatory Adjustments & Deductions from Each Tier of Capital</i>	138
7.10.9	<i>Certain Deductions part of Corresponding Deduction Approach</i>	138
7.10.10	<i>Threshold Deduction Treatment</i>	141

7.10.11	Net Capital Calculations.....	142
7.11	Capital Buffers	143
7.11.1	Data Population	144
7.11.2	Buffer Requirements.....	144
7.11.3	Required Buffers	145
7.11.4	Assumptions	146
7.11.5	Key Data Elements	146
7.12	Large Exposures.....	147
7.12.1	Data Population	147
7.12.2	Reclassification.....	148
7.12.3	Computation of the Direct Exposures.....	148
7.12.4	Computation of Indirect Exposures	149
7.12.5	Computation of Synthetic Exposures.....	149
7.12.6	Exempted Exposures.....	149
7.12.7	Calculation of Total Exposure to a counterparty	149
7.12.8	Identification of Related Parties	150
7.12.9	Calculation of Total Exposure to a group of related counterparties	150
7.12.10	Total Capital of the Bank.....	150
7.12.11	Identification of Large Exposure Counterparties	150
7.12.12	Threshold criteria for Large Exposure Counterparties.....	150
7.12.13	Large Exposure Breach Calculations.....	151
7.13	Leverage Ratio	151
7.13.1	Data Population	152
7.13.2	Exposure Measure Calculations	153
8	Basel III IRB Approach.....	157
8.1	Credit RWA.....	157
8.1.1	Banking Portfolio	159
8.1.2	Investment Portfolio.....	164
8.1.3	Pooling and Optimizer.....	168
8.2	Counterparty Credit RWA.....	169
8.2.1	Derivatives Portfolio.....	169
8.2.2	Securities Financing Transactions Portfolio.....	173

8.2.3	<i>Pooling and Optimizer</i>	178
8.3	Default Fund Contributions Related Capital Charge	179
8.3.1	<i>Capital Charge for Non-QCCP</i>	179
8.3.2	<i>Capital Charge for QCCP</i>	180
8.4	Credit RWA for Securitization.....	181
8.4.1	<i>Data Population</i>	182
8.4.2	<i>Shareholding Percent Multiplication</i>	182
8.4.3	<i>Common Reclassification Rules</i>	182
8.4.4	<i>Exposure at Default Amount Calculation</i>	183
8.4.5	<i>Risk Weight Assignment Rules</i>	183
8.4.6	<i>Sec Pre-CRM RWA Computation</i>	184
8.4.7	<i>Credit Risk Mitigation Process</i>	184
8.4.8	<i>Pooling and Optimizer</i>	185
8.5	Market Risk RWA.....	186
8.6	Operational Risk RWA.....	186
8.7	Capital Structure.....	186
8.7.1	<i>Provision calculation changes specific for IRB</i>	186
8.8	Capital Buffer	186
8.9	Large Exposures.....	186
8.10	Leverage Ratio	186
9	Basel III: Finalizing Post Crisis Reforms - Standardized Approach	187
9.1	Credit RWA.....	187
9.1.1	<i>Banking Portfolio</i>	187
9.1.2	<i>Investment Portfolio</i>	198
9.2	Counterparty Credit RWA.....	211
9.2.1	<i>Derivatives Portfolio</i>	211
9.2.2	<i>Securities Financing Transactions Portfolio</i>	223
9.2.3	<i>Pooling and Optimizer</i>	234
9.3	Credit valuation Adjustment	234
9.3.1	<i>Rating Population</i>	235
9.3.2	<i>CVA Based on CCR Capital Charge</i>	236
9.3.3	<i>CVA Basic Approach Reduced Version</i>	236

9.4	Default Fund Contributions Related Capital Charge	240
9.4.1	<i>Capital Charge for Non-QCCP</i>	240
9.4.2	<i>Capital Charge for QCCP</i>	241
9.5	Underlying Exposures Treatment	242
9.5.1	<i>Underlying Flow</i>	242
9.6	Credit RWA for Securitization	243
9.6.1	<i>Securitization – Revised Framework</i>	244
9.6.2	<i>Rating Population</i>	245
9.6.3	<i>Data Population</i>	246
9.6.4	<i>Shareholding Percent Multiplication</i>	246
9.6.5	<i>Common Reclassification Rules</i>	247
9.6.6	<i>Asset Reclassification Rules</i>	247
9.6.7	<i>Due Diligence Requirement for Securitization Exposures</i>	247
9.6.8	<i>Sec Approach Selection</i>	248
9.6.9	<i>Pooling and Optimizer</i>	253
9.7	Operational Risk (OR) – The Standardized Approach	254
9.7.1	<i>Data Population</i>	254
9.7.2	<i>Internal Loss Multiplier</i>	256
9.8	Capital Structure	258
9.8.1	<i>Assumption</i>	260
9.8.2	<i>Data Population</i>	260
9.8.3	<i>Shareholding Percent Multiplication</i>	260
9.8.4	<i>Common Reclassification Rules</i>	261
9.8.5	<i>Gross Capital Calculations</i>	261
9.8.6	<i>Minority Interest Calculations</i>	261
9.8.7	<i>Internal Transactions Deduction</i>	262
9.8.8	<i>Regulatory Adjustments & Deductions from Each Tier of Capital</i>	262
9.8.9	<i>Certain Deductions part of Corresponding Deduction Approach</i>	262
9.8.10	<i>Threshold Deduction Treatment</i>	265
9.8.11	<i>Net Capital Calculations</i>	265
9.9	Capital Buffers	267
9.9.1	<i>Data Population</i>	268
9.9.2	<i>Buffer Requirements</i>	269

9.9.3	Required Buffers	269
9.9.4	Assumptions	270
9.9.5	Key Data Elements	270
9.10	Large Exposures.....	271
9.10.1	Data Population	271
9.10.2	Reclassification.....	272
9.10.3	Computation of the Direct Exposures.....	273
9.10.4	Computation of Indirect Exposures	273
9.10.5	Computation of Synthetic Exposures.....	273
9.10.6	Exempted Exposures.....	273
9.10.7	Calculation of Total Exposure to a counterparty	274
9.10.8	Identification of Related Parties	274
9.10.9	Calculation of Total Exposure to a group of related counterparties	274
9.10.10	Total Capital of the Bank.....	274
9.10.11	Identification of Large Exposure Counterparties	275
9.10.12	Threshold criteria for Large Exposure Counterparties.....	275
9.10.13	Large Exposure Breach Calculations.....	275
9.11	Leverage Ratio	275
9.11.1	Data Population	276
9.11.2	Exposure Measure Calculations	277
10	Basel III: Finalizing Post Crisis-IRB Approach	281
10.1	Credit RWA.....	281
10.1.1	Banking Portfolio	283
10.1.2	Investment Portfolio.....	289
10.1.3	Pooling and Optimizer	294
10.2	Counterparty Credit RWA.....	294
10.2.1	Derivatives Portfolio.....	295
10.2.2	Securities Financing Transactions Portfolio	301
10.2.3	Pooling and Optimizer	306
10.3	Credit valuation Adjustment	307
10.3.1	Rating Population	308
10.3.2	CVA Based on CCR Capital Charge.....	308

10.3.3	CVA Basic Approach Reduced Version	308
10.4	Default Fund Contributions Related Capital Charge	312
10.4.1	Capital Charge for Non-QCCP	312
10.4.2	Capital Charge for QCCP.....	313
10.5	Credit RWA for Securitization.....	314
10.5.1	Data Population	315
10.5.2	Shareholding Percent Multiplication	315
10.5.3	Common Reclassification Rules	316
10.5.4	Exposure at Default Amount Calculation.....	316
10.5.5	Risk Weight Assignment Rules.....	316
10.5.6	Sec Pre-CRM RWA Computation.....	317
10.5.7	Credit Risk Mitigation Process	317
10.5.8	Pooling and Optimizer	318
10.6	Market Risk RWA	319
10.7	Capital Structure.....	319
10.7.1	Provision calculation changes specific for IRB.....	319
10.8	Capital Buffer	319
10.9	Large Exposures.....	319
10.10	Leverage Ratio	319
11	Account Clustering	320
11.1	Introduction	320
11.1.1	Summary.....	320
11.1.2	Approaches Followed in the Product.....	321
11.1.3	Modeling Framework Tools or Techniques used in Account Clustering	322
11.1.4	Data Requirements.....	324
11.1.5	Account Clustering Process Flow	326
11.1.6	Account Clustering UI navigation for model training and execution	327
12	User Interface for Reclassification And Regulatory Predefined Values.....	333
12.1	Introduction	333
12.2	Regulatory Reclassification User Interface	333
12.2.1	Summary View of the Regulatory Reclassification	333
12.2.2	Reclassification View.....	334

12.3	Regulatory Worklist User Interface	337
12.3.1	Review Requests.....	337
12.4	Regulatory Threshold for Operational Risk	338
12.4.1	Summary View of the Regulatory Threshold.....	338
12.4.2	VIEW THRESHOLD VALUES	338
12.4.3	Modify Threshold Values	339
12.5	Capital Threshold Setup	339
12.5.1	Summary View of Capital Threshold Setup	339
12.5.2	View Capital Threshold Setup.....	340
12.5.3	Modify Capital Threshold Setup.....	340
12.6	User Roles and Functions.....	341
13	Multiple data load for a particular date	343
13.1	Introduction.....	343
13.2	Functionality for the multiple data load	343
14	Incremental Exposure Processing	344
14.1	Introduction.....	344
15	Annexure A: Key Concepts.....	347
15.1	Slow Changing Dimensions.....	347
15.2	Exhibit 1 - Mitigant Allocation Optimizer	349
15.2.1	FIRB Minimum Collateralization Check (IRB Approach)	349
15.2.2	FIRB Over Collateralization Amount Adjustment (IRB Approach).....	350
15.2.3	Double Default Treatment (IRB Approach).....	350
15.2.4	Double Mitigant Treatment (Standardized Approach and IRB Approach)	350
15.2.5	Allocation of Mitigants (IRB Approach and Standardized Approach).....	351
15.3	Exhibit 3: Currency Conversion.....	354
15.4	Exhibit 4: FSI_CAPITAL_STANDARD_MAPPING Table Mapping	355
15.5	Exhibit 5: Data Expectations for few of the Basel Products	356
15.5.1	Equity Exposures Data Expectations.....	356
15.5.2	Securitization Exposures Data Expectations.....	356
15.5.3	Securities Financing Transaction Related Exposures Data Expectations.....	357
15.5.4	Account Mitigant Mapping Data Expectations.....	357

15.5.5	<i>Commitment Contract Data Expectations</i>	358
15.5.6	<i>Credit Line Issued Data Expectations</i>	358
15.5.7	<i>Forward Contract Data Expectations</i>	358
15.5.8	<i>Asset Sold Data Expectations</i>	358
15.5.9	<i>Spot Forex Data Expectations</i>	359
15.5.10	<i>Underlying Exposures for Derivatives</i>	359
15.5.11	<i>Underlying Exposures for CIU</i>	360
15.6	<i>Exhibit 6: Design Changes</i>	360
15.6.1	<i>Design Changes for Handling Organization Structure</i>	360
16	Annexure B: Technical Details	362
16.1	<i>Download Specifications</i>	362
16.2	<i>Regulatory Definition Setup for Creating a Run</i>	362
16.2.1	<i>Selecting Run Definition for Execution</i>	375
16.2.2	<i>Importing Run Definitions</i>	376
16.2.3	<i>Exporting Definitions</i>	377
16.2.4	<i>BackDated Execution - Run Execution Parameter</i>	377
16.3	<i>Using Process Modelling Framework</i>	378
16.3.1	<i>Basel CAP PACK Process Modelling Framework Filters and Decision Rules</i>	378
16.4	<i>Regulatory Definition Setup for Creating a Run</i>	384
16.4.1	<i>Selecting Run Definition for Execution</i>	392
16.4.2	<i>Importing Run Definitions</i>	392
16.4.3	<i>Exporting Optimizer Definitions</i>	393
16.4.4	<i>BackDated Execution - Run Execution Parameter</i>	394
16.5	<i>Data Transformation Details for Portfolio or Module</i>	395
16.5.1	<i>DT Details – Banking</i>	395
16.5.2	<i>DT Details - Investment</i>	395
16.5.3	<i>DT Details - Derivative</i>	395
16.5.4	<i>DT Details - Secured Financial Transactions (SFT)</i>	396
16.5.5	<i>DT Details – Securitization</i>	396
16.5.6	<i>DT Details - Market Risk</i>	396
16.5.7	<i>DT Details - Operational Risk</i>	397
16.5.8	<i>DT Details - Capital Structure</i>	397

16.6	Implementing Basel.....	398
16.6.1	<i>Rules List for Configuration</i>	398
16.6.2	<i>Custom Reclassification Rules</i>	398
16.6.3	<i>Seeded Values Used</i>	398
16.7	Basel Analytics Table Population - Reporting T2T	400
16.7.1	<i>Credit Risk and Counterparty Credit Risk – Non-Securitization</i>	400
16.7.2	<i>Credit Risk – Securitization</i>	402
16.7.3	<i>Common Mitigant Flow</i>	403
16.7.4	<i>Operational risk</i>	403
16.7.5	<i>Market Risk</i>	403
16.7.6	<i>Forecasted RWA Granularity</i>	404
16.7.7	<i>Entity Level Capital Accounting Head Granularity</i>	405
16.8	Basel Analytics Table Population - Processing T2T.....	405
17	Annexure C: Frequently Asked Questions.....	406
17.1	Leverage Ratio	406
17.2	Capital Buffers	406
17.3	Credit Valuation Adjustment.....	408
17.4	Operational Risk	408
17.5	Capital Structure (Basel III).....	409
17.6	Securitization.....	409
17.7	Capital Structure (Basel II).....	413
17.8	Market Risk (Basel II)	414
17.9	Mitigant Eligibility (Basel III).....	414
17.10	Haircut Assignment (Basel III).....	414
17.11	Cleared Transactions.....	415
18	Glossary	416

1 Getting Started

1.1 Intended Audience

Welcome to Release 8.1.2.0.0 of the Oracle Financial Services Basel Regulatory Compliance User Guide.

This guide is intended for:

- **Technical Analyst:** This user ensures that the data is populated in the relevant tables as per the specifications, executes, schedules, and monitors the execution of Runs as batches.
- **Business Analyst:** This user reviews the functional requirements and information sources, like reports.
- **Data Analyst:** This user is involved with cleaning, validation, and importing of data into the OFSAA Download Specification Format.
- **Administrator:** The Administrator maintains user accounts and roles, archives data, loads data feeds, and so on. The administrator controls the access rights of users.

1.2 Conventions

The following text conventions are used in this document.

Table 1: Document Conventions

Convention	Meaning
boldface	Boldface type indicates graphical user interface elements associated with an action or terms defined in text or the glossary.
<i>Italic</i>	Italic type indicates book titles, emphasis, or placeholder variables for which you supply particular values.
Monospace	Monospace type indicates commands within a paragraph, URLs, code in examples, file names, text that appears on the screen, or text that you enter.
Hyperlink	Hyperlink type indicates the links to external websites and internal document links.

1.3 Installing this Major Release

For detailed instructions to install this Major Release, see the [Oracle Financial Services Capital Adequacy Installation and Configuration Guide](#).

1.4 Related Information Sources

We strive to keep this and all other related documents updated regularly; visit the [OHC Documentation Library](#) to download the latest version available there. The list of related documents is provided here.

- [OHC Documentation Library](#) for **OFS Capital Adequacy (OFS CAP) Application Pack**:
 - Oracle Financial Services Capital Adequacy Pack Installation Guide
- [OHC Documentation Library](#) for **OFS AAI Application Pack**:
 - *OFS Advanced Analytical Applications Infrastructure (OFS AAI) Application Pack Installation and Configuration Guide*
 - *OFS Analytical Applications Infrastructure User Guide*
 - *OFS Analytical Applications Infrastructure Administration Guide*
 - *Oracle Financial Services Analytical Applications Infrastructure Environment Check Utility Guide*
- **Additional documents:**
 - [OFSAA Licensing Information User Manual](#)
 - [OFS Analytical Applications Infrastructure Security Guide](#)
 - [OFSAAI FAQ Document](#)
 - [OFS Analytical Applications Technology Matrix](#)
 - [Oracle Financial Services Analytical Applications Infrastructure Cloning Guide](#)

2 What's New in this Release

As part of this release, the solution is compliant with the Basel III: Finalizing Post Crisis Reforms and the Basel Framework updates for the Credit Risk, Counterparty Credit Risk and Operational Risk. The key functionalities addressed in this release are as below:

- Credit Risk
 - Revised Foundation IRB Approach
 - Revised Advanced IRB Approach
- Counterparty Credit Risk
 - Credit Valuation Adjustment – Basic Approach – Reduced Version
- Operational Risk
 - Revised Standardized Approach

Also, there has been process modeling changes to cater with the Basel III: Credit Valuation Adjustment for the Standardized Approach.

The application also supports:

- Incremental Exposure Processing
 - Functionality to support processing of specific exposures, for a particular reporting date, and using the previous reporting date's calculation for other exposures, to arrive at the final capital charge, risk weighted assets and total capital, across approaches.
- Back dated Exposure Processing
 - Functionality to support processing of data for a previous date, which might be changes due to regulations becoming effective retrospectively or due to any strategic decisions that affect the regulatory calculations retrospectively.
- User Interface for Reclassification
 - Functionality allowing the user to view the reclassification of bank specific data to the regulatory / OFSAA specific data. This also has the functionality to enable user to edit and make changes to it, using a controlled workflow.
- User Interface for Operational Risk
 - Functionality allowing the user to view the thresholds specified by the regulator for the loss calculations.

There have been changes to certain processes to help in reducing the end to end processing time and helping in achieve a better performance.

3 Introduction to Basel Regulatory Capital

In 1988, the Bank for International Settlements published the first guidelines on Capital Adequacy called the Basel I accord which primarily focused on credit risk. Assets of banks were classified and grouped into five categories of credit risk, with specific risk weights. On 4 July 2006, the BIS Committee issued a comprehensive version of the Basel II Framework. This document also consisted of the changes in the June 2004 Basel II Framework, the elements of the 1988 Accord that were not revised during the Basel II process, and the 1996 Amendment to the Capital Accord to incorporate Market Risks. The major outlines of the Basel II accord are to comply with the three pillars.

- The First Pillar: Minimum Requirements for:
 - Tier 1, Tier 2 and Tier 3 capital
 - Credit Risk
 - Market Risk
 - Operational Risk
- The Second Pillar: Supervisory Review Process and
- The Third Pillar: Market Discipline

In 2010, the regulatory body met and published the guidelines of Basel III. The main highlights of Basel III accord of December 2010 (rev June 2011) were:

- **Stricter Capital norms:** Basel III requires banks to hold 4.5% of common equity (up from 2% in Basel II) and 6% of Tier I capital (up from 4% in Basel II) of risk-weighted assets (RWA).
- **Capital Buffer:** Basel III also introduced additional capital buffers, (i) a mandatory capital conservation buffer of 2.5% and (ii) a discretionary countercyclical buffer, which allows national regulators to require up to another 2.5% of capital during periods of high credit growth and (iii) a discretionary G-SIB / D-SIB buffer as applicable.
- **Leverage Ratio:** Also, Basel III introduced a minimum leverage ratio and two required liquidity ratios. The leverage ratio is calculated by dividing Tier 1 capital by the bank's Total Exposure. Banks are expected to maintain the leverage ratio above 3%.
- **CVA Risk:** Basel III introduced CVA risk charge in addition to counterparty default risk charge for Over the Counter (OTC) derivative portfolio.

Post 2011, there were multiple revisions to the guidelines. The main highlights of the changes were:

- **Counterparty Credit Risk:** The changes were to the existing treatment of Exposure measure calculation, and the new calculations pertaining to the Standardized Approach of EAD Calculation (SA CCR) was published, along with changes to the Internal Model Method. As these exposures also impact the Central Counterparty, changes were published for the same.

- **Securitization:** The Securitization framework underwent complete change in the way the treatment happened for the exposures, with a new hierarchy of approaches. There was a significant new treatment for Simple, transparent and comparable securitization transactions.
- **Leverage Ratio:** There were changes to the Exposure Measure calculation.
- **Total Loss Absorbing Capacity:** This was mostly the requirement to hold long term debt instruments to absorb the losses as a Tier 2 Capital instrument. And this also included specific buffer requirements to be met by G-SIBs.
- **Large Exposure:** There were significant calculation requirements to restrict the exposure measure to a group of related counterparties, and to ensure there are stricter capital requirements to be met, in case of them breaching the threshold.

Basel III – Finalizing Post Crisis Reforms was published in December 2017. There were changes published as part of the consolidated Basel framework that comes into effect from January 2023. The main highlights of these changes were:

- **Credit Risk:** Changes to the Standardized Approach of Capital Calculations by updating the risk weight across multiple asset classes. IRB had changes specifically on the modeling aspects and also for applying output floors as per the transition.
- **CVA:** The CVA calculations were revamped, and new approaches were suggested for the calculations.
- **Operational Risk:** The operational risk calculation was revamped and new standardized approach was suggested.
- **Market Risk:** The Market Risk calculations were completely revamped with the introduction of three new approaches namely:
 - FRTB- Standardized Approach
 - FRTB- Internal Model Approach
 - FRTB- Simplified Standardized Approach

The new Standardized approach incorporates sensitivity, liquidity horizon and correlation parameter and introduces new risk charge concepts such as Residual Risk Add on and Default Risk Charge.

The new Model Approach replaces the Value at Risk (VaR) based approach with Expected Shortfall (ES) based approach and introduced quantitative and qualitative criteria for Modelling and Non Modelling Risk factors. It also introduced the concept of Trading Desk Approval which requires the meeting of Profit and Loss Attribution Test (P&L) and Back testing requirement.

The Simplified Standardized Approach is applicable for less complex Trading Book Positions based on certain quantitative and qualitative criteria.

The Oracle Financial Services Basel Regulatory Capital application consists of Capital Adequacy and Risk-Weighted Assets computations as prescribed in Basel I, Basel II, Basel III and Basel III: Finalizing Post Crisis Reforms Accord.

The Oracle Financial Services (OFS) Basel Regulatory Capital application is categorized into two versions:

- OFS Basel Regulatory Capital Basic supports the Standardized Approach and its variant based on the BIS Guidelines, and also other jurisdictions by considering the national discretions – USA, Canada, European Union, Saudi Arabia, Thailand, Hong Kong, Australia, and India
- OFS Basel Regulatory Capital Internal Rating Based Approach is based on the approaches supported by the OFS Basel Regulatory Capital Basic Application and the advanced approaches based on the BIS Guidelines, and also other jurisdictions by considering the national discretions – USA, Canada, European Union, Saudi Arabia, Thailand, Hong Kong, Australia, and India

The following approaches are supported in the application:

- Credit Risk
 - Credit Risk – Standardized Approach & IRB Approach
 - Basel III
 - Basel III: Finalizing Post Crisis Reforms
 - Securitization Risk – Standardized Approach, External Ratings Based Approach & IRB Approach
- Counterparty Credit Risk
 - Standardized Approach & IRB Approach for Risk Weighting
 - Standardized Approach of EAD (SA CCR), Current Exposure Method (CEM), Original Exposure Method (OEM), Adjusted Current Exposure Method (ACEM) Calculations for OTC Derivatives and Cleared Transactions
 - Capital Charge for QCCP and Non QCCP
 - Credit Value Adjustment Risk
 - Standardized and Advanced Approach as per Basel III
 - Basic Approach Reduced Version and Capital Charge Based on CCR RWA as per Basel III: Finalizing Post Crisis Reforms
- Market Risk
 - Market Risk – Standardized Approach & FRTB Standardized Approach
- Operational Risk
 - Basic Indicator Approach, Standardized Approach, Alternative Standardized Approach as per Basel III
 - Standardized Approach as per Basel III: finalizing Post Crisis Reforms
- Capital Structure & Buffers
- Large Exposure Calculations – Connected Parties, and Single Counterparty/ Group of Linked Counterparties
- Leverage Ratio – Leverage Exposure Measure, Leverage Ratio & Buffers

3.1 Key Features

The important features of the OFS Basel Regulatory Capital application are as follows:

- One integrated application which allows for different approaches configured for various portfolios.
- Financial institutions can migrate to more advanced approaches as and when required.
- Comprehensive coverage of Credit Risk Mitigation techniques which ensures optimum allocation of Credit Risk Mitigants to exposures for maximum RWA reduction using the optimizer functionality in the application.
- Extensive, pre-built instrument coverage, built to meet Basel III and Basel III : Finalizing Post Crisis Reforms guidelines, which means banks, can get 'up and running' quickly with minimal pre-processing.
- It is a fully transparent application where all Rules and Approaches are visible to business users, reviewers, or auditors.
- It is fully traceable with metadata lineage to ensure it is compliant with BCBS 239 guidelines on Risk Data Aggregation.
- Audit Trail is present to maintain accountability of Rules changes, user activity, or system modifications.
- Comprehensive functionality to enable user to compute the capital charge or risk weighted assets only for the exposures undergoing changes in their key measures, thereby ensuring that the processing happens incrementally, and this reduces the time taken for processing. This is handled by the Incremental Exposure processing feature.
- Financial Institutions can retrospectively move to previous version of the regulatory calculations or take into effect any guideline that comes into effect with retro effect and do an assessment for the strategy decisions by making use of Back dated execution capabilities.
- It is a fully transparent reclassification user interface where all business rules of reclassification to Regulatory or OFSAA specific data are visible to all business users, reviewers or auditors. This also comes with a well-defined audit workflow, enabling a controlled approval for the changes.
- It is a fully transparent user interface to view the regulatory thresholds prescribed by the regulator for the operational risk loss calculations and also for the supervisory internal loss multiplier.

4 Overview of OFSAA Infrastructure

Oracle Financial Services Analytical Applications Infrastructure is the complete end-to-end Business Intelligence solution that is easily accessible via your desktop. A single interface lets you tap your company's vast store of operational data to track and respond to business trends. It also facilitates analysis of the processed data. Using OFSAAI you can query and analyze data that is complete, correct, and consistently stored at a single place. It has the prowess to filter data that you are viewing and using for analysis.

It allows you to personalize information access to the users based on their role within the organization. It also provides a complete view of your enterprise along with the following benefits:

- Track enterprise performance across information data store.
- Use one interface to access all enterprise databases.
- Create consistent business dimensions and measures across business applications.
- Automate the creation of coordinated data marts.
- Use your own business language to get fast and accurate answers from all your databases.
- Deploy an open XML and web-based solution against all major relational or multi-dimensional databases on Microsoft Windows and UNIX servers.

This chapter provides an overview of Infrastructure, its components, and explains how these components are organized in the Splash window with the user login process.

4.1 Components of OFSAAI

The OFSAA Infrastructure consists of the following components/modules that are used to deploy an analytical solution.

- Data Model Management
- Data Management Tools
- Unified Analytical Metadata
- Rules Run Framework
- Metadata Browser
- Operations
- Questionnaire
- Process Modelling Framework
- System Configuration & Identity Management
- Object Administration
- Forms Framework

See [OFS Analytical Applications Infrastructure User Guide](#) for more information on all important components/modules of OFSAAI.

5 Application Processing

This section provides details on the application processing components.

5.1 Data Requirements

Data can be divided into the two categories – Setup Tables, and Slow Changing Dimensions (SCD), and can be set up by the bank

- **Setup Tables**

A setup table is a set of data that is static and does not change at regular intervals.

- **Dimension Tables**

A slowly changing dimension table is a set of data that is static and does not change at regular intervals. For more information on SCD, see the section [Slow Changing Dimensions](#) in the [Annexure](#).

5.2 Data Assumptions

This section aims to identify certain data related assumptions for specific tables that help in the smooth functioning of the Basel Regulatory Capital application.

Data Format

- In all the date columns, data is expected as per the MIS_DATE_FORMAT of the atomic schema.
- Country and Currency codes are expected as per the ISO standard.

Dimension Table

DIM_CAPITAL_ACCT_HEAD: General Ledger items and Non-General Ledger items are differentiated in the column **F_GL_IDENTIFIER** by the flag Y that indicates the General Ledger items and the flag N that indicates non-General Ledger items.

Mapping Table

FSI_CAPITAL_STANDARD_MAPPING: For certain standard account headline items that are processed by the application, for example, Net Tier 1 Capital, Total eligible Capital, Tier 1 Capital Ratio, and Capital Ratio, you are expected to provide mapping for these items as Others in the column **V_CAPITAL_ACCOUNT_IDENTIFIER** in the **FSI_CAPITAL_STANDARD_MAPPING** table. These capital line items mapped as others are used in the **T2T - CAPITAL_STD_ACCT_HEAD_POP** to insert records into **FCT_STANDARD_ACCT_HEAD** from **FCT_CAPITAL_ACCT_HEAD**.

Across the Basel product, in all the seeded data tables, the open-end date is mentioned as 31-DEC-9999. You must not modify this value.

FACT Table

FCT_CAPITAL_ACCT_HEAD: General Ledger items and non-General Ledger items are differentiated in the column **F_GL_IDENTIFIER** with the flag Y that indicates General Ledger items and the flag N that indicates non-General Ledger items. The T2T that

populates data from the table **STG_GL_DATA** to the **FCT_CAPITAL_ACCT_HEAD** table populates the value Y in the column **F_GL_IDENTIFIER**. The T2T that populates data from the **STG_STANDARD_ACCT_HEAD** table to the table **FCT_CAPITAL_ACCT_HEAD** populates the value N in the column **F_GL_IDENTIFIER**. The reclassification of General Ledger and non-General Ledger skews to standard account head skew (**N_STD_ACCT_HEAD_SKEY**) happens in the **FCT_CAPITAL_ACCT_HEAD** table by either of the following tables:

- A Type 2 rule is used to reclassify by using the **DIM_CAPITAL_ACCT_HEAD** and **DIM_STANDARD_ACCT_HEAD** tables.
- The referencing the mapping table **FSI_CAPITAL_STANDARD_MAPPING**

From the **FCT_CAPITAL_ACCT_HEAD** table, General Ledger and Non-General Ledger data flows into the **FCT_STANDARD_ACCT_HEAD** table. Again, the distinction is based on the flag Y in the column **F_GL_IDENTIFIER**.

5.2.1 Data Loading

The OFSAAI Data Integrator framework allows you to move data flexibly within the Oracle Financial Services Analytical Applications (OFSAI) Data Model at different levels of granularity and various stages of the process.

Data can be loaded into the required Stage or Setup Tables in the following ways:

- **Connecting to other databases:** Relational data sources can be defined to connect to any of the Relational Database Management System (RDBMS) like Oracle, IBM DB2, MS SQL Server, and any RDBMS through native connectivity drivers or ODBC. RDBMS data source lets you define the RDBMS engine present locally or remotely with FTP access to the remote server
- **Flat-Files:** Flat File data source lets you define the flat-file present locally or remotely with FTP access to the remote server. Data files can be made available in the standard staging area configured in OFSAI. A Flat-File data source is a local data source residing in the staging area of the Infrastructure Database Server.

For more information on the format of the flat file or RDBMS file, see the [Download Specifications](#) document.

Further, data can be loaded or maintained by using the following components available in the Data Integrator Framework:

Excel upload: Choose this option when you have moderate quantities of data that are available in an excel file format.

Manual Data Entry – Forms: The Data Entry Forms and Queries (DeFQ) module of the Data Integrator is designed to create user-friendly Data Entry windows with a choice of layouts, which enables data viewing and data manipulation easily. You can select tables based on which you can create forms that can be used in any application.

For more information on data loading activities like Flat File Source and Connecting to other databases, see the [OFS Advanced Analytics Infrastructure User Guide](#).

5.2.2 Reclassification Rules

A sample list of products, customer types, issuer types, collateral types, credit ratings, and organization structure is pre-defined in the application. However, the list and naming convention of products, customer types, and so on, might differ from one bank to another. The application re-classifies the bank's data into standard data, which does not change for a given set of regulations, and then processes it based on standard classifications. This restricts the level of modifications needed for each implementation for re-classifying the bank's data into the relevant standard classifications.

The list of reclassification rules required for the population is attached in the Annexure.

Setting up the Data

The respective Dimension Tables corresponding to products (**DIM_PRODUCT**), customer types, issuer types (**DIM_PARTY_TYPE**), collateral type (**DIM_MITIGANT_TYPE**), credit ratings (**RATING_SRC_MASTER** and **DIM_CREDIT_RATING**), and organization structure (**DIM_ORG_STRUCTURE**) are populated with the list of product types, customer types, issuer types, collateral types, ratings, and organization structure as used in the respective bank.

As described in the [Data Requirements](#) section, these tables can be populated by directly uploading data into the tables if they are not likely to change frequently or by using the SCD component, if the data is likely to change over some time.

Also, data is expected in **STG_PRODUCT_MASTER**, **STG_PARTY_TYPE_MASTER**, and **STG_MITIGANT_TYPE_MASTER** for the product, party type, and mitigant types. SCDs populate data from these tables into **DIM_PRODUCT**, **DIM_PARTY_TYPE**, and **DIM_MITIGANT_TYPE**.

Modifying the Re-Classification Rules

You must only populate the SCD tables through the [SCD Batches](#). The hierarchies related to Product Types, Customer Types, and so on, must be re-saved if the data keeps on changing. This can be done individually for each hierarchy using the Unified Metadata Manager or in bulk using the Save Metadata link under Administration on the LHS pane of the OFSAAI window. A new node is created in the source hierarchy. This node is mapped to the node in the target to be added to the target hierarchy. The pre-configured reclassification rules are modified to map the Bank's data to the Standard data using the Rules Framework.

5.3 Processing

After data stores are created and Rules, Processes, and Runs are defined, the timing and frequency of the Execution can be established. For more information on the Runs pre-configured with the application, see the Run Charts. To execute Runs as batches, see the Operations section in the [Oracle Financial Services Analytical Applications Infrastructure User Guide](#).

The scheduling of Runs within OFSAAI can be managed on a real-time or batch basis. Batch processes can be executed daily, weekly, monthly, or to meet specific business needs. The Run Management facility also provides the ability to run jobs on a manual or

real-time basis, as required. Existing investments in external schedulers can also be used to call web services within this infrastructure.

5.3.1 Batch Processing

A batch refers to a set of executable processes based on a specified rule. Batches relating to the application must be executed as specified below. These batches are executed from the Operations Menu of OFSAAI. For more information on the Operations section, see the OFSAAI 8.1 User Guide.

Slowly Changing Dimension batch: This must be executed when you are installing the application for the first time. Subsequently, this batch must be executed only when new data is added. The tasks processed and the order in which the tasks are processed, are specified in the Run Charts.

5.3.1.1 Basel Common Batch

The following tasks are mapped to the Basel Common batch:

- Date Population: This task populates the table DIM_DATES.
- Party Role Map Calculation: This task populates the party and the role mapping from STG_PARTY_ROLE_MAPPING to FSI_PARTY_ROLE_MAPPING.
- FSI IRCS Calculation: This task populates FSI_IRCS from STG_IRC_RATE_HIST.

5.3.1.2 PARTY_FIN_DATA_POP Batch

Populates the party financial data and executed as required when the party financial data is available.

5.3.1.3 BASEL_DAILY Batch

This batch is to be executed daily. This batch is used to populate the exchange rate between different currencies for each date.

5.3.1.4 BASEL_SETUP_TBL_POP Batch

This batch is used for Basel set up tables' population. This batch contains T2Ts to populate data from setup tables into the corresponding processing tables. and includes rules to mark the latest data indicators. You are required to provide data in setup tables whichever applicable. The tasks in this batch are ad hoc and can be selected as applicable.

For more information on the setup tables for the batches, see the [Setup Table Batch Details](#) file.

5.3.2 Basel Configurations

The Basel Configuration framework is a unique feature of the Basel Regulatory Capital application that enables a business user to easily define a Portfolio and a Run. The framework allows you to define a Run by selecting a combination of different Basel

approaches for RWA computation. It also allows you to define a Run for a combination of portfolios.

You can execute the Runs as a PMF batch from the Process Modeler window. The Regulatory Calculation Definition UI lists all the Runs defined in the Framework. For more information on the Process Modelling Framework, refer to [Oracle Financial Services Analytical Applications Infrastructure Process Modelling Framework Orchestration Guide](#).

The Basel Configurations feature consists of the following functionalities:

- Optimizer
- Portfolio Definition
- Regulatory Calculation Definition
- Account Clustering

5.3.2.1 Optimizer

A prerequisite for defining the Optimizer is to update the pool ID in the sub-exposures FCT_SUB_EXPOSURES table for the selected Run.

5.3.2.1.1 Viewing an Optimizer

To view the optimizer, perform these steps:

1. Log in to the application and select **Financial Services Basel Regulatory Capital Basic**.
2. On the LHS menu, click **Basel Regulatory Capital Basic**, click **Basel Configurations**, and then click **Optimizer** to open the **Optimizer Models** window.

Figure 1: The Optimizer Models window

The screenshot shows the 'Optimizer Models' window with a search bar and a table of models. The table has three columns: Model Name, Parameters, and Date/Status. The models listed are:

Model Name	Parameters	Date/Status
Basel III Non Sec Optimization	DSMIT015 Undefined MSMIT045	2020-01-22 11:18:00.0
Basel III Non Sec Optimization		NA
Basel III Sec Optimization	DSMIT015 Undefined MSMIT045	2020-01-22 11:18:00.0
Basel III Sec Optimization Model		NA
Basel III Dilution Risk Optimization	DSMIT016 Undefined MSMIT045	2020-01-22 11:18:00.0
Basel III Dilution Risk Optimization		NA

3. Select an optimizer to view it.

5.3.2.1.2 Executing an Optimizer

Prerequisites:

You must ensure the following before executing the optimizer:

Complete the pooling process and update the N_POOL_ID column in the FSI Sub Exposures (FSI_SUB_EXPOSURES) table.

Optimizer models are defined and accessible on the Optimizer Models page. These models are mandatory to execute the model for a particular exposure type.

Executing an Optimizer through an Independent Process

Follow these steps to execute an optimizer as an independent process:

1. Log in to the application as a System Administrator.
2. Click **Basel Regulatory Capital Internal Ratings Based Approach** or **Basel Regulatory Capital Basic** depending on the application that you have the license for.
3. Click **Process Modelling** and then click **Process Modeler**.
4. Click **Add**  to open the **Process Details** window.

Figure 2: The Process Details window



Populate the fields in the **Process Details** form as tabulated.

Table 2: The Process Details form

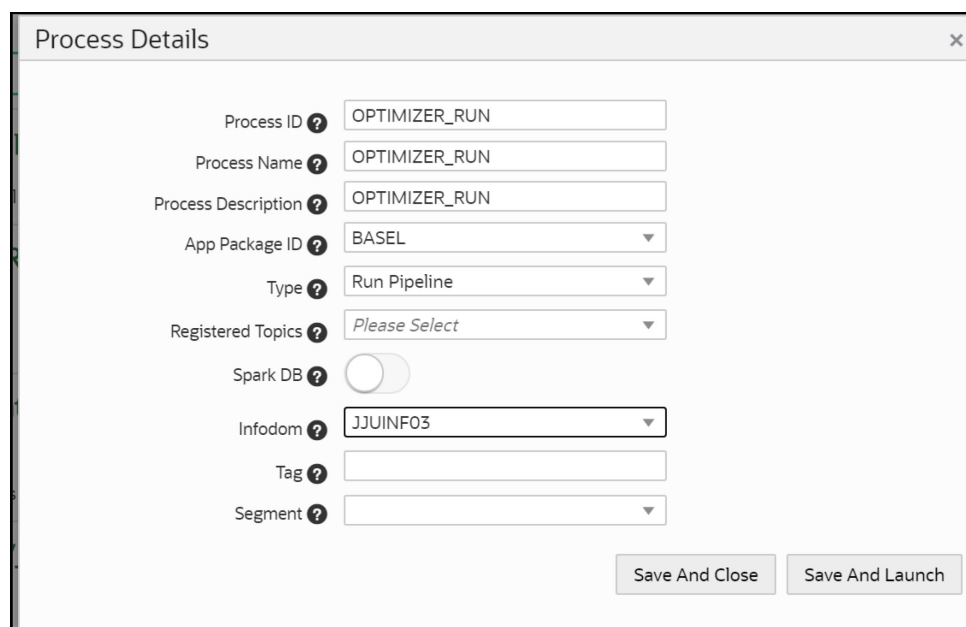
Fields	Description
Process ID	Enter an ID for the optimizer process.
Process Name	Enter a name for the optimizer process.
Process Description	Enter a description for the optimizer process.
App Package ID	Select an application package ID from the drop-down list.
Type	Select the type from the drop-down list.
Spark DB	Do not enable this field if you want to keep the default settings.
Infodom	Select the infodom from the drop-down list.
Tag	Enter the names of the tags to be used for the optimizer process.
Segment	Select a segment from the drop-down list.

5. Click **Save and Launch** to open the **Process Definition** window.
6. Click **Start** and drag the **Start** process in to the canvas.

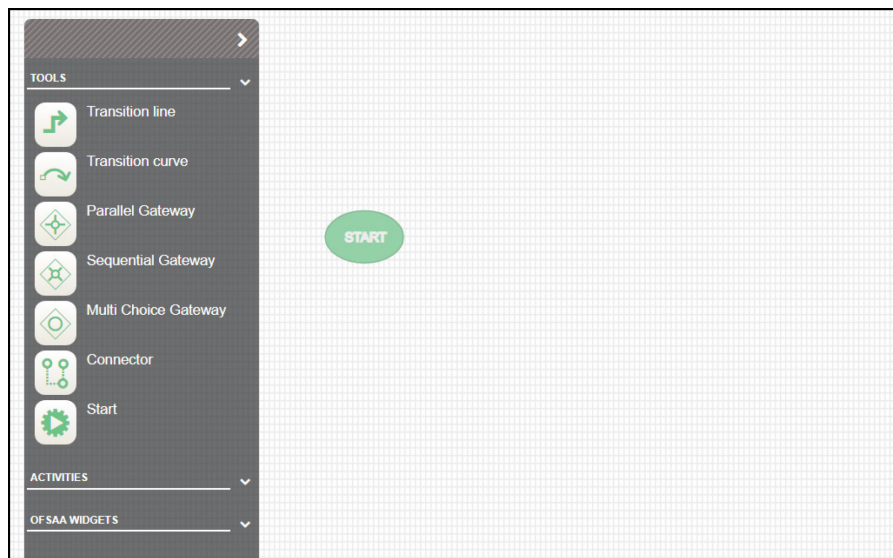
Figure 3: The Start Process has been added to the Canvas

7. Click **ACTIVITIES** to expand it.
8. Click and drag **Service Task** process component into the canvas.

Figure 4: The Service Task Process has been added to the Canvas

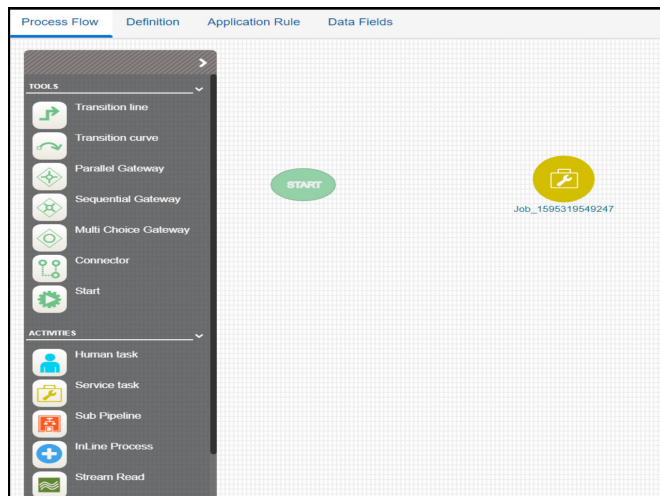

9. Join the **Start** component to the service task component by dragging the **Transition line** connector into the canvas.

Figure 5: The Transition Line connector has been added to the Canvas

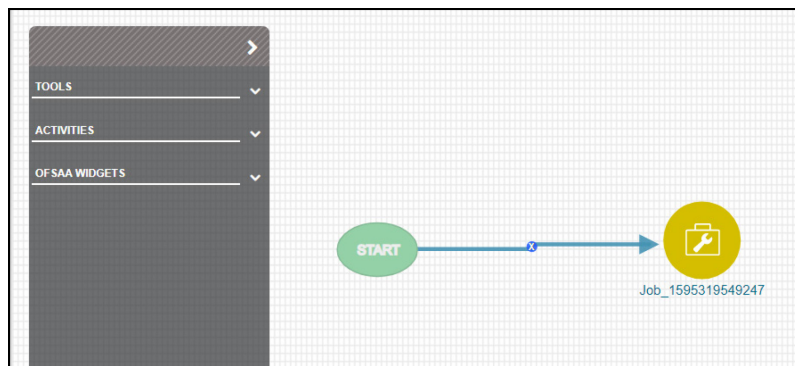

10. Double click the service task component to open the settings window.

Figure 6: The Settings Window

The screenshot shows the settings window for the service task component. It has a toolbar at the top with icons for undo, redo, refresh, settings, and warning. The main area contains the following fields:

- Activity ID ? Job_1595319549247
- Activity Name ? Job_1595319549247
- Activity Desc ?
- Activity Type ? AUTOMATIC
- Status ?
- Outcomes ?

11. Click **Settings**  to open the **Settings** tab.

Figure 7: The Settings Tab

Rule

Infodom ? JJUINF03

Execution Rule ? Default

Parameters

Add

Pre/Post Processing

Pre Rule ? Default

Post Rule ? Default

12. Click **Find**  to open the **Participant Details** screen.

Figure 8: The Participant Details Window

select	ID	Name
<input type="radio"/>	-1	Default
<input type="radio"/>	1583752751365	Basel Execution Parameter
<input type="radio"/>	1587987965211	Basel Run Parameter Population
<input type="radio"/>	1587391742168	Basel Non Sec FIRB Parameter Selection
<input type="radio"/>	1587391808333	Basel Non Sec AIRB Parameter Selection
<input type="radio"/>	1587383054709	Basel Non Sec STD Parameter Selection
<input type="radio"/>	1587750075132	Basel SFT or Derivatives Approach Applica
<input checked="" type="radio"/>	1585310048380	Basel Optimizer Solver for Covered Factor Estimation
<input type="radio"/>	1583935823415	Basel Non Sec STD Run Parameters
<input type="radio"/>	1580115440473	Basel CRM Pool Id Assignment
<input type="radio"/>	1579612670828	Basel CRM Method Assignment
<input type="radio"/>	1587999922087	Basel SACCB EAD Method Assignment

Ok

13. Click the rule **Basel Optimizer Solver for Covered Factor Estimation** and then click **OK**.
14. Click **Add** to open the **Binding Details** window. The Data Field is automatically populated with the input value **BASEL_OPTIMIZER_MODEL_CODE**.

Figure 9: The Binding Details

The screenshot shows a dialog box titled "Binding Details" with a close button (X) in the top right corner. It contains three input fields, each with a question mark icon to its left:

- Data Field**: A dropdown menu showing "BASEL_OPTIMIZER_MODEL_CO..."
- Parameter Type**: A dropdown menu showing "Static"
- Value**: A text input field containing "2020810000001"

An "Ok" button is positioned at the bottom right of the dialog box.

15. Click **Ok**.

In case the model code is not available on the screen, you can retrieve it from the FSI_BASEL_OPTIMIZER_MODEL_TL table.

Figure 10: Sample Model Code Retrieval Query

```
Select * from FSI_BASEL_OPTIMIZER_MODEL_TL where
V_MODEL_DESC = 'Basel III Non-Sec Optimization';
```

The **Parameters** pane is populated with the values that you added in the Binding Details window.

Figure 11: The Parameters pane is populated with the Values

The screenshot displays a software interface with several sections:

- Rule**: Includes "Infodom" (JJUINF03) and "Execution Rule" (Basel Optimizer Solve).
- Parameters**: A list of parameters where "BASEL_OPTIMIZER_MODEL_CODE" is selected, showing the value "2020810000001".
- Pre/Post Processing**: Includes "Pre Rule" and "Post Rule", both set to "Default".

At the top of the interface, there are several icons: a refresh icon, a gear icon, a curved arrow icon, another gear icon, and a warning triangle icon.

16. Click **Save**.

The newly created optimizer run appears on the **Process Modeler** page.

Figure 12: The Newly Created Optimizer Run appears on the Process Modeler Page

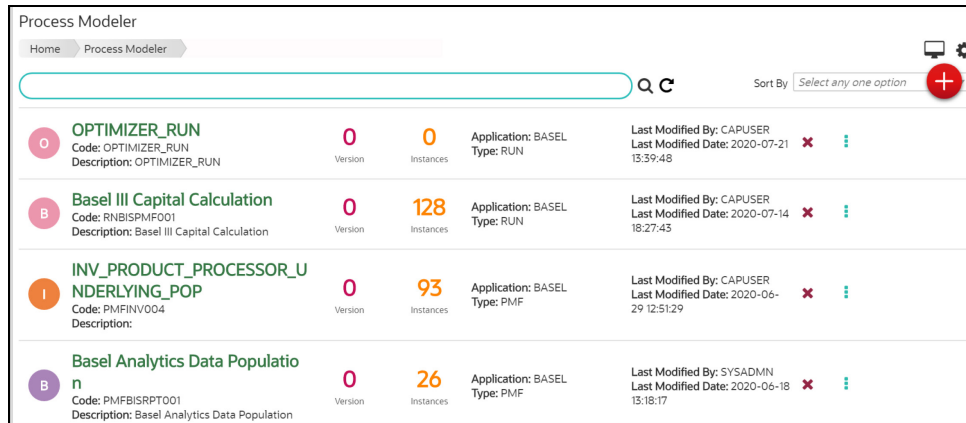

Run Name	Code	Description	Version	Instances	Application	Type	Last Modified By	Last Modified Date	Actions
OPTIMIZER_RUN	OPTIMIZER_RUN	OPTIMIZER_RUN	0	0	BASEL	RUN	CAPUSER	2020-07-21 13:39:48	✖ ⋮
Basel III Capital Calculation	RNBISPMF001	Basel III Capital Calculation	0	128	BASEL	RUN	CAPUSER	2020-07-14 18:27:43	✖ ⋮
INV_PRODUCT_PROCESSOR_UNDERLYING_POP	PMFINV004		0	93	BASEL	PMF	CAPUSER	2020-06-29 12:51:29	✖ ⋮
Basel Analytics Data Population	PMFBISRPT001	Basel Analytics Data Population	0	26	BASEL	PMF	SYSADMIN	2020-06-18 13:18:17	✖ ⋮

17. Click **More** to view additional actions.

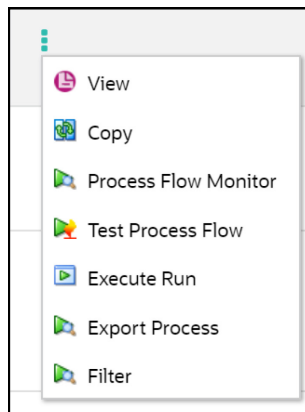

Figure 13: The Available Actions for a Run



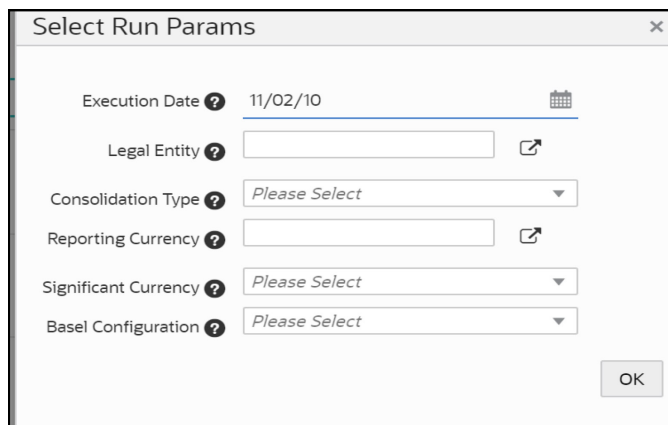

18. Click **Execute Run** to open the **Select Run Params** window.



Figure 14: The Select Run Params Window





Execution Date  11/02/10 

Legal Entity  

Consolidation Type 

Reporting Currency  

Significant Currency 

Basel Configuration 

19. Populate the **Select Run Params** form as tabulated.

Table 3: The Select Run Params pane

Field	Description
Execution Date	Select the Execution Date by clicking Calendar  .
Legal Entity	Select a legal entity.
Consolidation type	Select the consolidation type from the drop-down list.
Reporting Currency	Select the reporting currency.
Significant Currency	Select the Significant Currency from the drop-down list.
Basel Configuration	Select the Basel Configuration from the drop-down list.

20. Click **OK** to go back to the **Process Modeler** page.

The optimizer run is in progress.

21. Click **More**  and then select **Process Flow Monitor**.

The run status will be either Running or Completed.

Figure 15: The Status of the Run

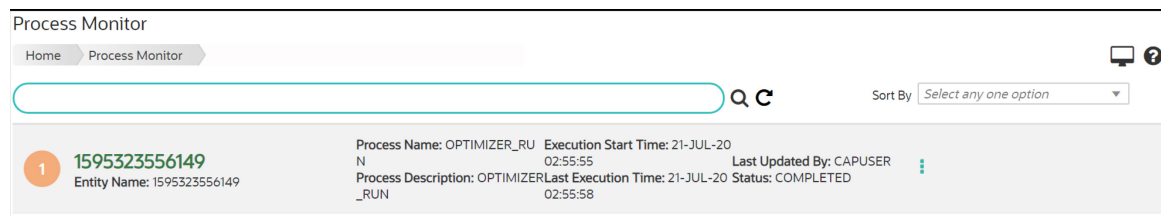

Executing an Optimizer via the Sub-process of a Different Run

The steps to execute an optimizer run via the sub-process of a different run is similar to the steps in the Executing an Optimizer through an Independent Process section. The only difference is that the optimizer run that you want to execute is connected to a different run in the canvas of the Process Details screen.

5.3.2.1.3 View the optimizer log

View the Optimizer Log on via the Process Monitor Page

Follow these steps to view the log from the Process Monitor screen:

On the Process Monitor pane, click the required optimizer for which you want to view the log to open the Process Definition window.

Double-click the service task process in the canvas to open the setting window.

Figure 16: The Setting Window

The screenshot shows a 'Setting Window' with a header bar containing a refresh icon and a clock icon. Below the header, the following fields are displayed:

Activity ID	Job_1595319549247
Activity Name	Job_1595319549247
Activity Desc	
Activity Type	AUTOMATIC
Status	N.A.
Execution Rule	Basel Optimizer Solver for Covered I

1. Click Log  to view the log of the optimizer run.

View the Optimizer Log on the Database Table

You can view the log by referring to the CL_LOG_MESSAGE column in the FSI_BASEL_OPT_SOLVER_BATCH_MASTER table.

View the Optimizer Log on the Server

The optimizer BaselSolver.log file is available in the server machine in the path:
 <web_container_location>/webapps/OFSCAP/logs

5.3.2.2 Portfolio

You can define a combination of portfolios to participate in a Run. For example: If an institution wants to process only On Balance Sheet data and not all the product types, then the institution has the choice of selecting a subtype of an entire portfolio for processing.

5.3.2.2.1 Adding a New Hierarchy for Portfolio Creation

To add a new hierarchy for portfolio creation, the hierarchy code must be added in PORTFOLIO_HIERARCHY_MASTER table as tabulated:

Table 4: The PORTFOLIO_HIERARCHY_MASTER table

Column	Indicative values
V_HIERARCHY_CODE	Contains hierarchy code of the hierarchy to be added
F_LATEST_RECORD_INDICATOR	To be set to 'Y' for the hierarchies which have to be displayed
D_RECORD_START_DATE	Start date of the hierarchy.
D_RECORD_END_DATE	The end date of the hierarchy.

5.3.2.2.2 Access Portfolio Definition

To access a portfolio definition, follow these steps:

1. Log in to the application and select **Financial Services Basel Regulatory Capital Basic**.
2. On the LHS menu, click **Basel Regulatory Capital Basic**, click **Basel Configurations**, and then click **Portfolio** to open the **Portfolio Definition** window.

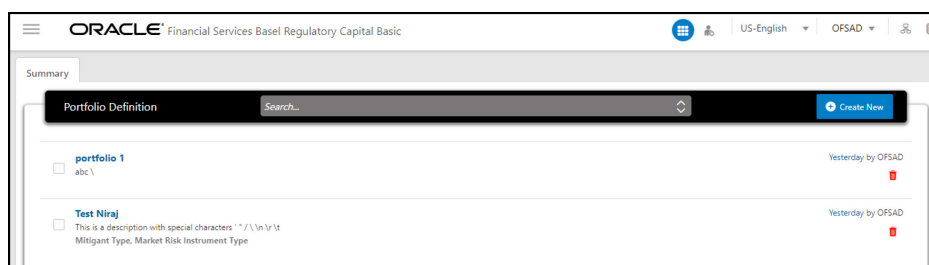
Figure 17: The Portfolio Definition window

5.3.2.2.3 Create a Portfolio Definition

To create a portfolio definition, follow these steps:



1. In the **Portfolio Definition** window, click **Create New**  to open the **New Portfolio Model** window.

Figure 18: The New Portfolio Model window

2. Populate the details as tabulated.

Table 5: The New Portfolio Model pane

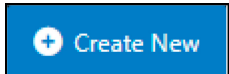
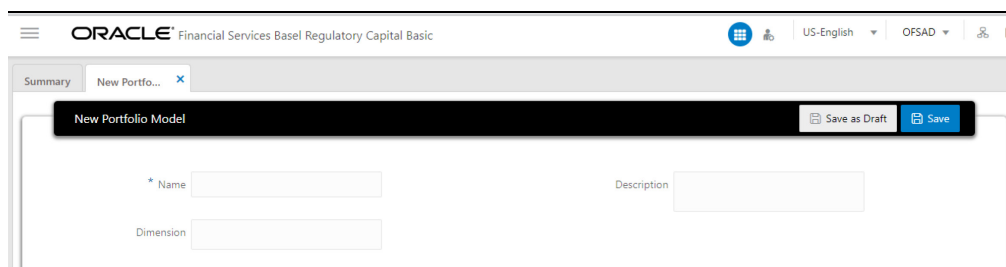
Field	Description
Name	Enter a name for the portfolio definition.
Dimension	Select a dimension(s) from the drop-down list. Available options are: <ul style="list-style-type: none"> • Counterparty Type • Market Risk Counter Party • Mitigant Type • Product • Market Risk Instrument Type
Description	Enter a description of the portfolio definition.
Add Dimension	This pane only appears after you select a dimension(s) in the Dimension field. Click Add  to open the window for the selected dimension and select the required options.

3. Click **Save as Draft** if you want to save a draft of the portfolio.
4. Click **Save**.

5.3.2.2.4 Delete a Portfolio

To delete a portfolio, follow these steps:

1. In the **Portfolio Definition** window, for the portfolio that you want to delete, click

Delete 

A confirmation message appears, asking you if you are sure that you want to delete the portfolio.

2. Click **Yes**.

The portfolio is deleted, and the Portfolio page is refreshed to display the updated list of portfolios.

5.3.2.3 Regulatory Calculation Definition

The Process Modelling Framework helps you to combine various components or processes and execute them with different underlying approaches. For more information on the Process Modelling Framework, refer to the [OFS Analytical Applications Infrastructure Process Modelling Framework Orchestration Guide](#).

5.3.2.3.1 Access the Regulatory Calculation Definition Page

Perform the following steps to access the **Regulatory Calculation Definition** window:

1. Log in to the application and select **Financial Services Basel Regulatory Capital Basic or Financial Services Basel Regulatory Capital IRB**.

2. On the LHS menu, click **Basel Regulatory Capital Basic** or **IRB**, click **Basel Configurations**, and then click **Regulatory Calculation Definition** to open the **Regulatory Calculation Definition** window.

5.3.2.3.2 Create a Regulatory Definition

To create a Regulatory definition, perform the following steps:

1. In the Regulatory Calculation Definition window, Click Create New

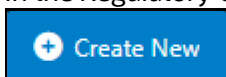

to open the New Run Definition window.

Figure 19: The New Regulatory Calculation Definition Window

2. Populate the details as per the following table:

Table 6: The New Regulatory Definition Form

Field	Description
Name	Enter a name for the Run definition.
Description	Provide a description for the Run definition.
Jurisdiction	Select a jurisdiction from the drop-down list. The available options are: <ul style="list-style-type: none"> • BIS • EU • INDIA
Regulation	Select a regulation from the drop-down list. The available options are: <ul style="list-style-type: none"> • BASEL III • BASEL III Post Crisis Reforms Depending on the value that you select in this field, the Regulatory Approaches pane is automatically updated.
Include pane	
Capital Structure & Capital Buffers	Click the  icon to enable this field.

Field	Description
Leverage Exposure Measure & Ratio Calculations	Click the  icon to enable this field.
Large Exposure Identification & Calculations	Click the  icon to enable this field.
Regulatory Approaches pane	
<p>NOTE:</p> <p>The Regulatory approaches that appear in this field depend on if you have the license for the Oracle Financial Services Basel Regulatory Capital Basic or Oracle Financial Services Basel Regulatory Capital IRB application pack and if you selected either BASEL III or BASEL III Post Crisis Reforms in the Regulation field.</p>	
Credit Risk and Counterparty Credit Risk for Non-Securitization Exposures – Standardized Approach	Click Select  to open the configurations window for this Regulatory approach. See Step 7 to view and populate the fields available in this window.
Credit Risk and Counterparty Credit Risk for Non-Securitization Exposures – Foundation IRB Approach	Click Select  to open the configurations window for this Regulatory approach. See Step 7 to view and populate the fields available in this window.
Credit Risk and Counterparty Credit Risk for Non-Securitization Exposures – Advanced IRB Approach	Click Select  to open the configurations window for this Regulatory approach. See Step 7 to view and populate the fields available in this window.
Credit Risk for Securitization Exposures – Standardized Approach	Click Select  to open the configurations window for this Regulatory approach. See Step 7 to view and populate the fields available in this window.
Credit Risk for Securitization Exposures – IRB Approach	Click Select  to open the configurations window for this Regulatory approach. See Step 7 to view and populate the fields available in this window.
Market Risk – Standardized Approach	Click Select  to open the configurations window for this Regulatory approach. See Step 7 to view and populate the fields available in this window.
Market Risk – Internal Models Approach	Click Select  to open the configurations window for this Regulatory approach. See Step 7 to view and populate the fields available in this window.

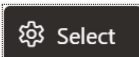
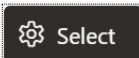
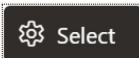
Field	Description
Operational Risk – Basic Indicator Approach	Click Select  to open the configurations window for this Regulatory approach. See Step 7 to view and populate the fields available in this window.
Operational Risk – Standardized Approach	Click Select  to open the configurations window for this Regulatory approach. See Step 7 to view and populate the fields available in this window.
Operational Risk – Alternative Standardized Approach	Click Select  to open the configurations window for this Regulatory approach. See Step 7 to view and populate the fields available in this window.

3. If you have enabled the **Regulatory Approaches** field, then in the required

approach pane, click **Select**  to open the **Configuration** window and populate the form as tabulated.

Table 7: The Configuration Form for a Selected Regulatory Approach

Field	Description
Risk Type pane	
Credit Risk	If the Regulatory approach requires this risk type, then select the checkbox.
Counterparty Credit Risk	If the Regulatory approach requires this risk type, then select the checkbox.
EAD & CRM Method Selection pane	
The Capital Calculation Methods that appear in this field depend on if you have the license for the Oracle Financial Services Basel Regulatory Capital Basic or Oracle Financial Services Basel Regulatory Capital IRB application pack and if you selected either BASEL III or BASEL III Post Crisis Reforms in the Regulation field. You must select a value from the drop-down lists. Details regarding these methods and options are provided under the section Run parameters setup .	
Supervisory Approved Option Selection pane	
The Capital Calculation Methods that appear in this field depend on if you have the license for the Oracle Financial Services Basel Regulatory Capital Basic or Oracle Financial Services Basel Regulatory Capital IRB application pack and if you selected either BASEL III or BASEL IV in the Regulation field. You must select a value from the drop-down lists. Details regarding these parameters and options are provided under the section Run parameters setup .	
Portfolio pane	
Select Applicable Portfolios	Select a portfolio from the drop-down list. The portfolios that you created in the Create a Portfolio Definition section appear in this field.

4. Select **Save as Draft** if you want to save a draft of this form.

5. Select **Save**.

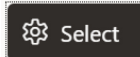
5.3.2.3.3 Delete a Regulatory Definition

To delete a Regulatory definition, follow these steps:

1. In the **Regulatory Calculation Definition** window, for the Run definition that you want to delete, click **Delete** .
2. A confirmation message appears, asking you if you are sure that you want to delete the Run definition.
3. Click **Yes**.
4. The definition is deleted, and the Summary Page is refreshed to display the updated list of Run definitions.

5.3.3 Reporting

Oracle Financial Services Basel Regulatory Capital Analytics provides the customer with a reporting-cum-information framework which can be used for generating reports and viewing information relevant to the capital computations and other aspects of the Basel framework. Basel Analytics provides pre-configured Basel dashboards for all the functionalities supported in the application, Pillar II reports covering most of the aspects related to stress testing and other supervisory review and quantitative reports supporting Pillar III analysis covering all market disclosure requirements of the Basel Accord.

For more information on Basel Regulatory Capital Analytics, see the Oracle Financial Services Basel Regulatory Capital Analytics User Guide.

Oracle Financial Services Basel Regulatory Capital Analytics must be licensed by the Bank separately.

6 Bank for International Settlements (BIS)

6.1 Introduction of OFSAA Portfolio Definitions

Every bank has different LOBs, and they have different functions. To aid the bank in its efficient management of regulatory calculations, the application has inbuilt portfolio definitions, concerning the banking book and trading book respectively. The different portfolio definitions help in the ease of calculations for the bank, and the parallel processing of the risk-weighted asset calculations. In many of the banks, the ownership of every portfolio might be different, and hence it becomes easier for the maintenance of the ownership for every data point and calculations. The data points concerning every portfolio are different.

The various portfolios concerning Credit Risk are the following:

- Credit Risk Non-Securitization
 - Banking Related Exposures
 - Investment Related Exposure (only belonging to banking book)
 - Counterparty Credit Risk – Non-Securitization
 - Derivative Related Exposures (both Banking and Trading book exposures)
 - Securities and Financing Transaction Related Exposures (Both Banking and Trading book exposures)
- Credit Risk Securitization
 - Securitization Related Exposures (only belonging to Banking book)
- The portfolio of trading book exposures is the portfolio for Market Risk.

Figure 20: OFSAA profile

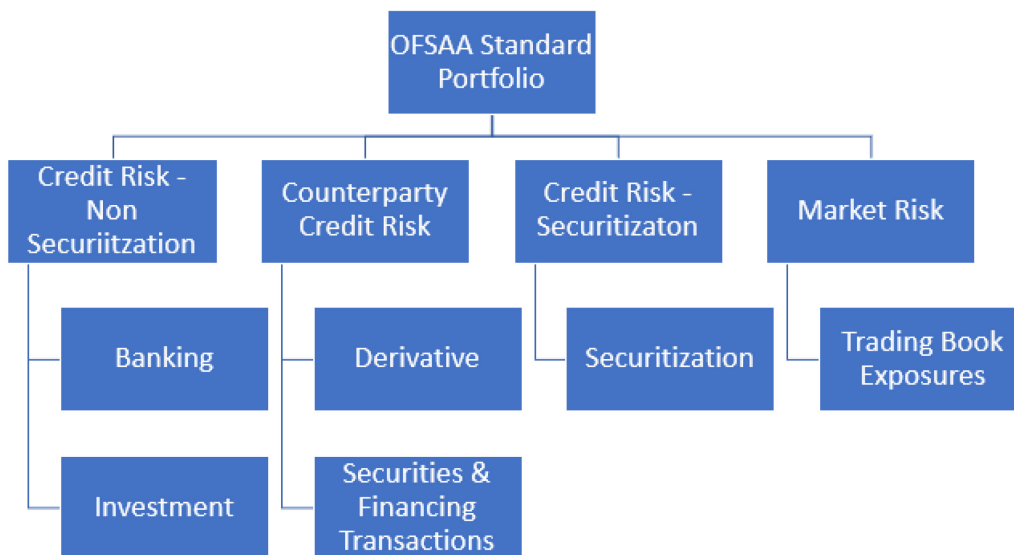
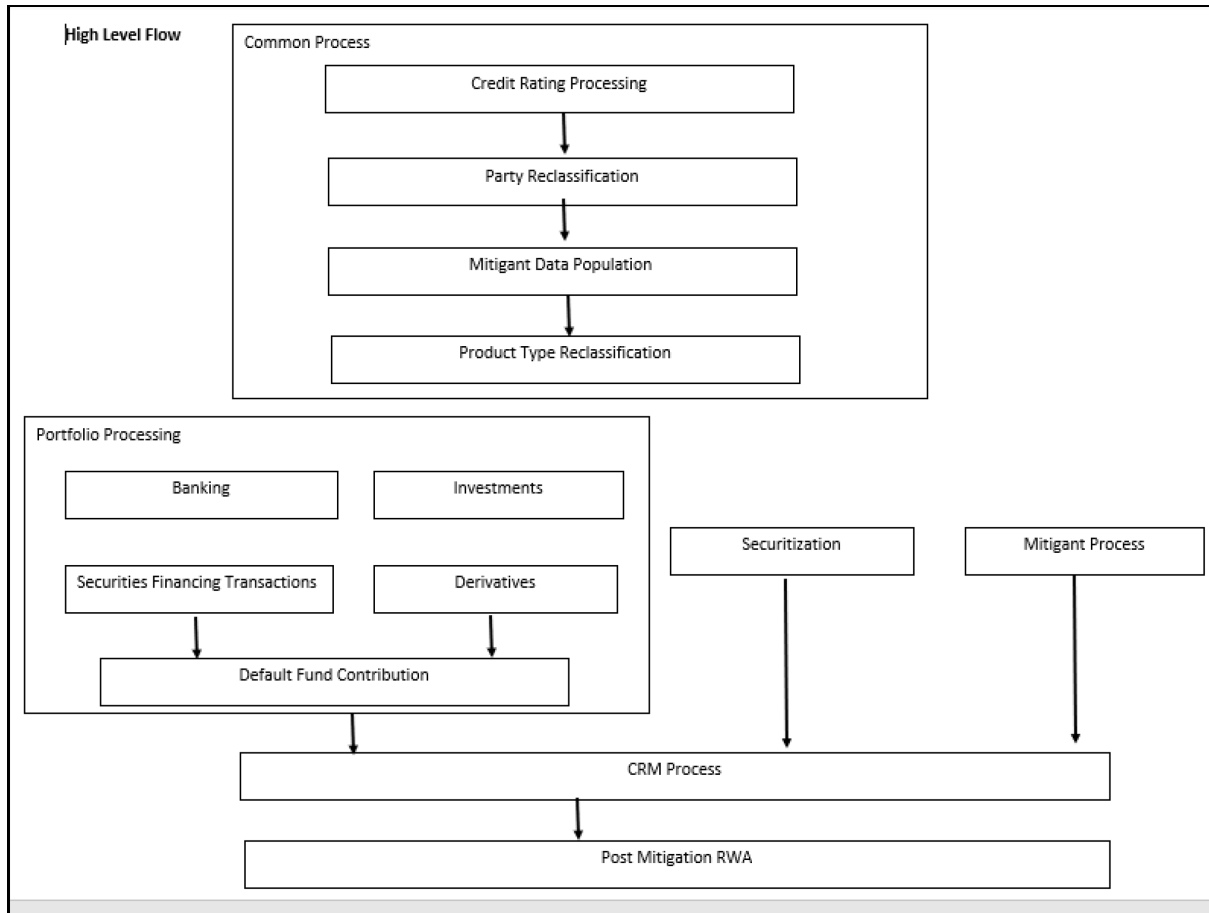

Figure 21: High-level design



6.1.1 Banking

The Banking portfolio caters to the core banking activities of the bank – be it corporate banking or retail banking. This includes all the various banking activities in the form of loans provided by the bank, cards issued by the bank, commitments issued by the bank, overdraft provided by the bank, and other such core banking specific activities. Since this will be a mandatory portfolio for all the banks, this portfolio has its own RWA calculations.

The Banking starts with Banking Data Population followed by Retail related data processing and Post Crisis Banking Data Processing.

Figure 22: Banking data processing

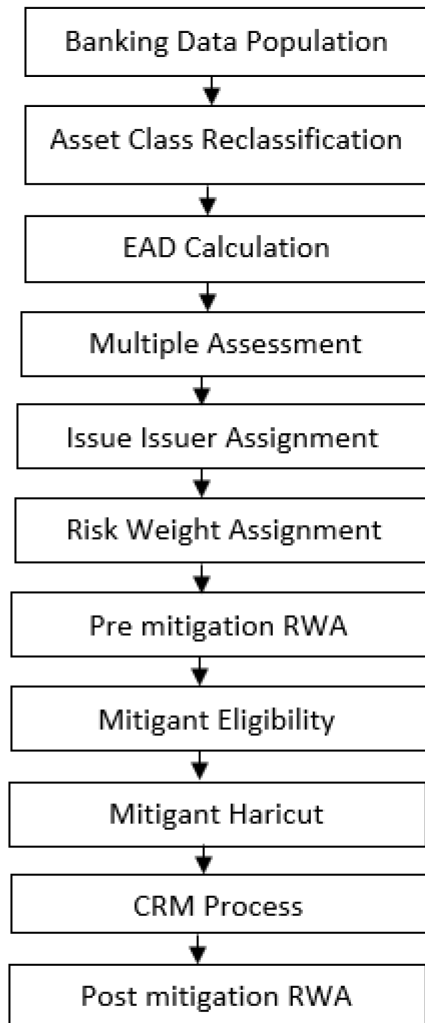

6.1.2 Investment

The Investment portfolio caters to any of the investment activities of the bank, for which the bank holds the assets till maturity. These are the exposures that the bank intent to hold in the Banking book. This includes all the investment in the form of any money market instruments or spot instruments or debt securities, held by the bank till maturity, and hence considered to be in the banking book. This also includes the bank’s investment in the form of fixed assets as well. This will be applicable only if the bank holds exposures in the form of investment related to the banking book.

Figure 23: Investment portfolio process flow

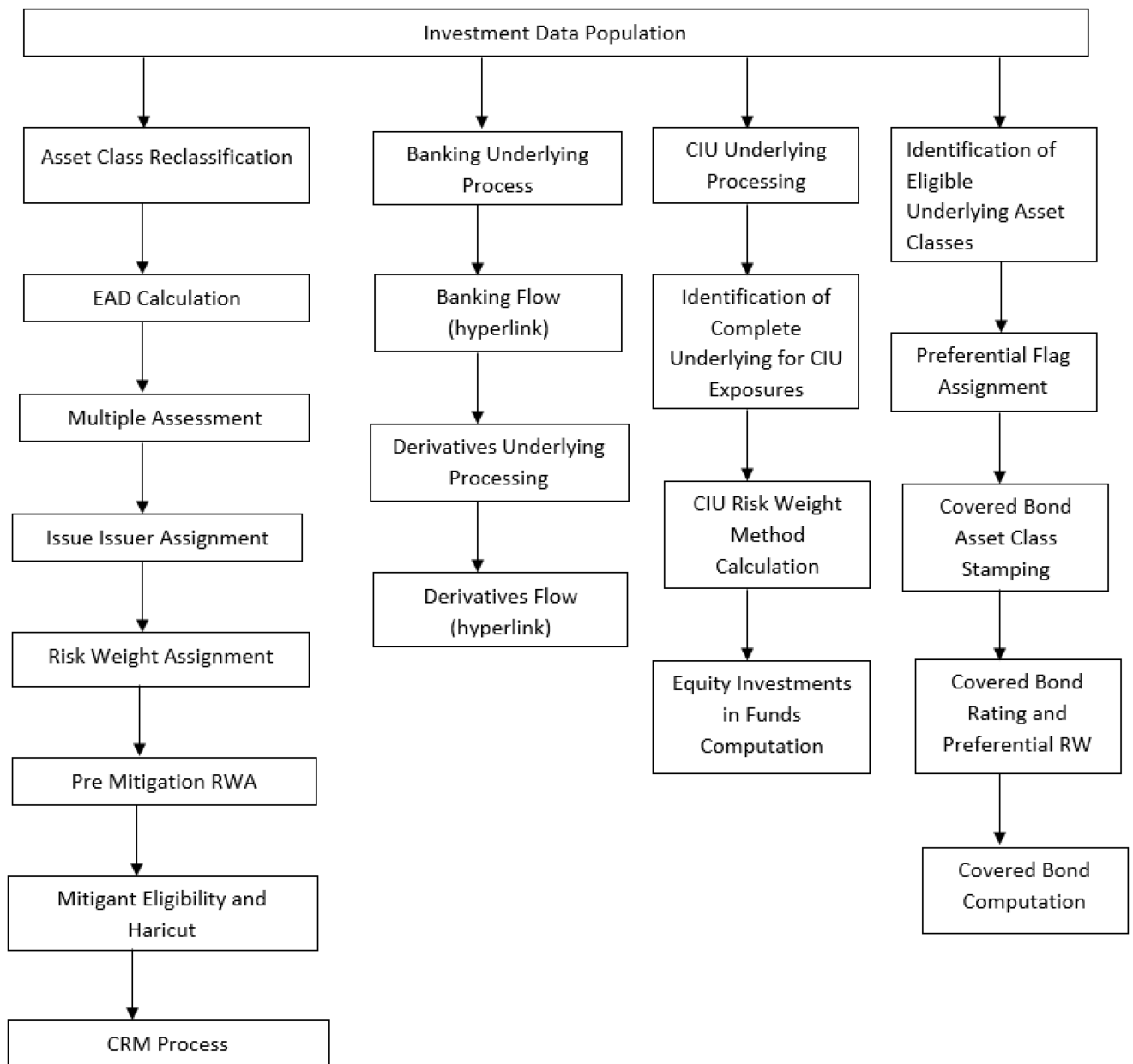

6.1.3 Derivative

The derivative portfolio caters to any of the derivative activities of the bank. These are the derivatives for which the bank is one of the counterparties or the bank acts as a clearing member or clearing member client. This includes derivatives in the form of credit derivatives, forwards, futures, options contracts, and swap contracts. This will include both the banking and trading book-related derivative exposures.

Figure 24: Derivative portfolio

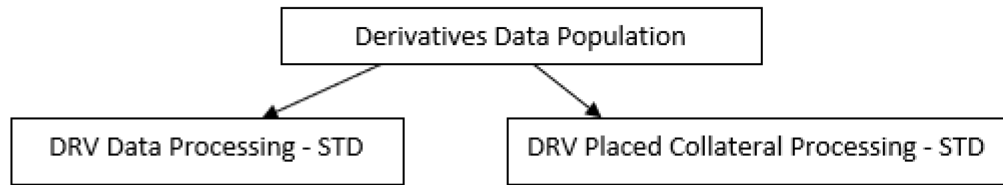

6.1.4 Securities and Financing Transactions

The Securities and Financing Transactions (SFT) portfolio caters to any of the securities financing activities of the bank. These are the SFT which the bank enters, or the bank acts as a clearing member or clearing member client. This includes SFT in the form of repurchase agreements, reverse repurchase agreements, margin lending transactions, securities lending, and borrowing transactions. This will include both the banking and trading book-related exposures.

Figure 25: Securities and Financing Transactions portfolio process flow

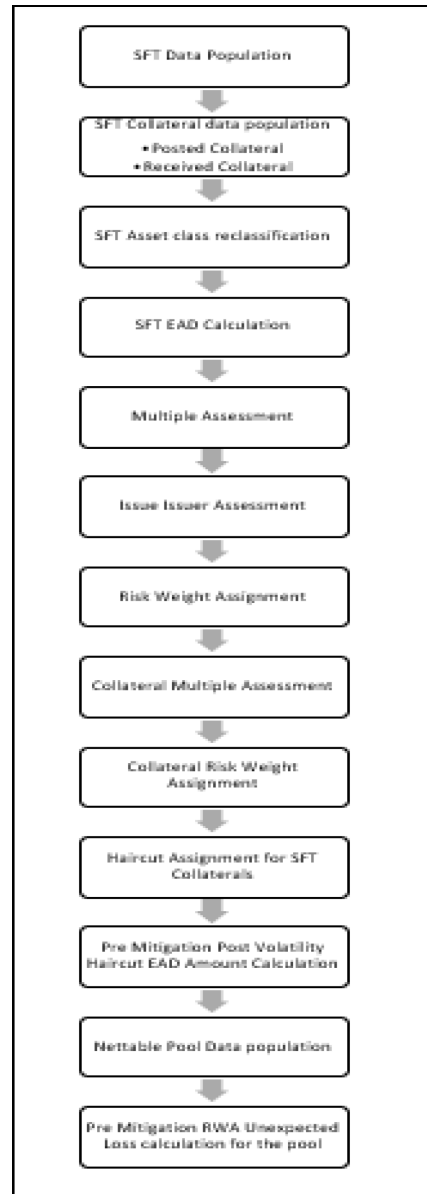

6.1.5 Securitization

The Securitization portfolio caters to the securitization activities of the bank, wherein the bank either acts as an investor/ originator/ sponsor, or in the form of any other party wherein the bank provides some credit enhancement or commitment to the securitization transaction. This includes banking book-related exposures.

Figure 26: Securitization portfolio process flow

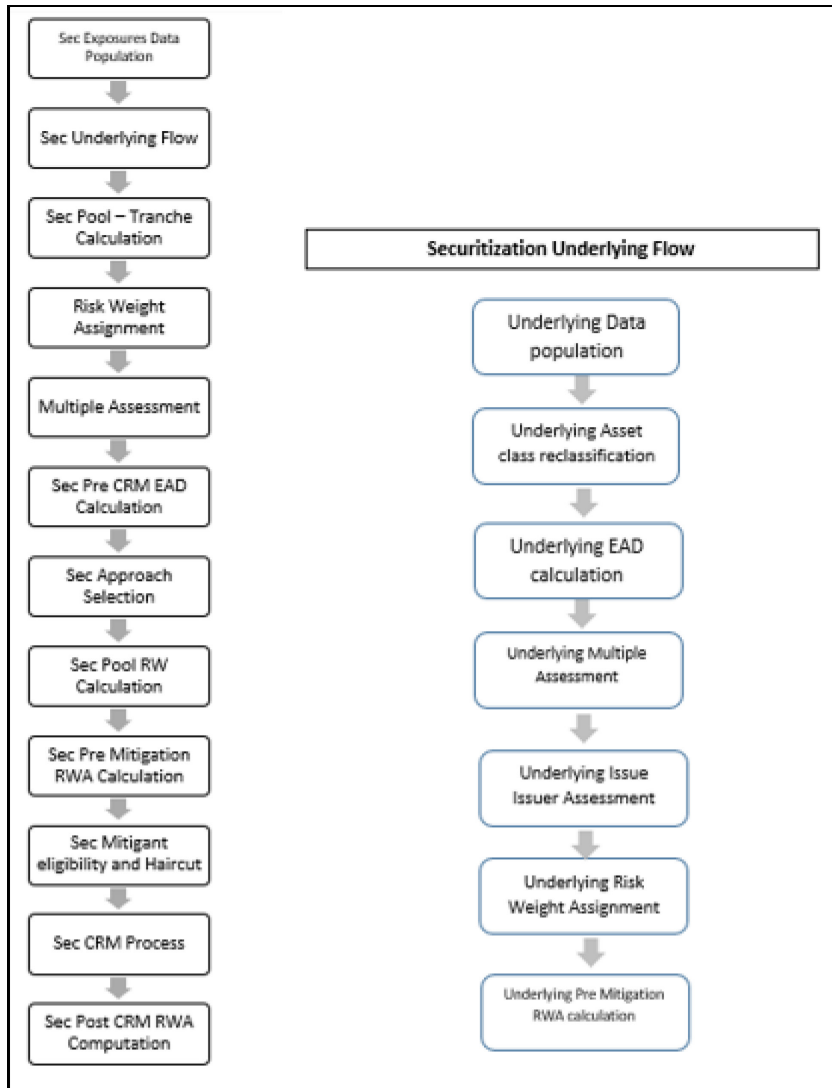

6.1.6 Credit Valuation Adjustment

Credit Valuation Adjustment is calculated at a counterparty level. CVA reflects the adjustment of default free risk prices of derivatives and SFT, due to potential default of the counterparty. Regulatory CVA can differ from Accounting CVA due to following reasons:

Regulatory CVA excludes the default due to bank’s own default. Best practices of accounting CVA are imposed in Regulatory CVA.

Figure 27: Process Flow for CVA

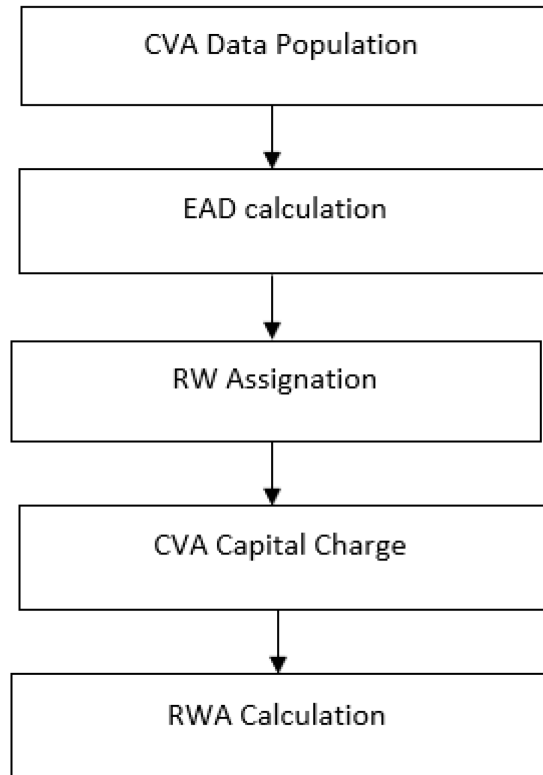

6.1.7 Operational Risk

The Operational risk related portfolio caters to all the Line of Business and its various Business Indicators. This includes all the losses incurred by the bank due to various Operational process in their various lines of business.

6.2 Overview of Basel III

The Basel Committee (BIS) published guidelines that encompass guidelines for capital adequacy. Concerning Capital Adequacy, multiple guidelines have been published from Basel committee from time to time, and the OFS Basel Regulatory Capital complies with all the latest guidelines that must be complied with, by the bank. The various guidelines are the ones listed below:

- International Convergence of Capital Measurement and Capital Standards - June 2006
- Revisions to the Basel II market risk framework - December 2010
- Basel III: A global regulatory framework for more resilient banks and banking systems - December 2010
- Capital requirements for banks' equity investments in funds - December 2013
- Basel III leverage ratio framework and disclosure requirements - January 2014
- The standardized approach for measuring counterparty credit risk exposures - March 2014
- Capital requirements for bank exposures to central counterparties - April 2014

- Supervisory framework for measuring and controlling large exposures - April 2014
- Revisions to the securitization framework - December 2014
- Minimum capital requirements for market risk - January 2016

The various functions that are encompassed as part of OFS Basel Regulatory Product are as follows:

Figure 28: Various functions of Basel Regulatory Product

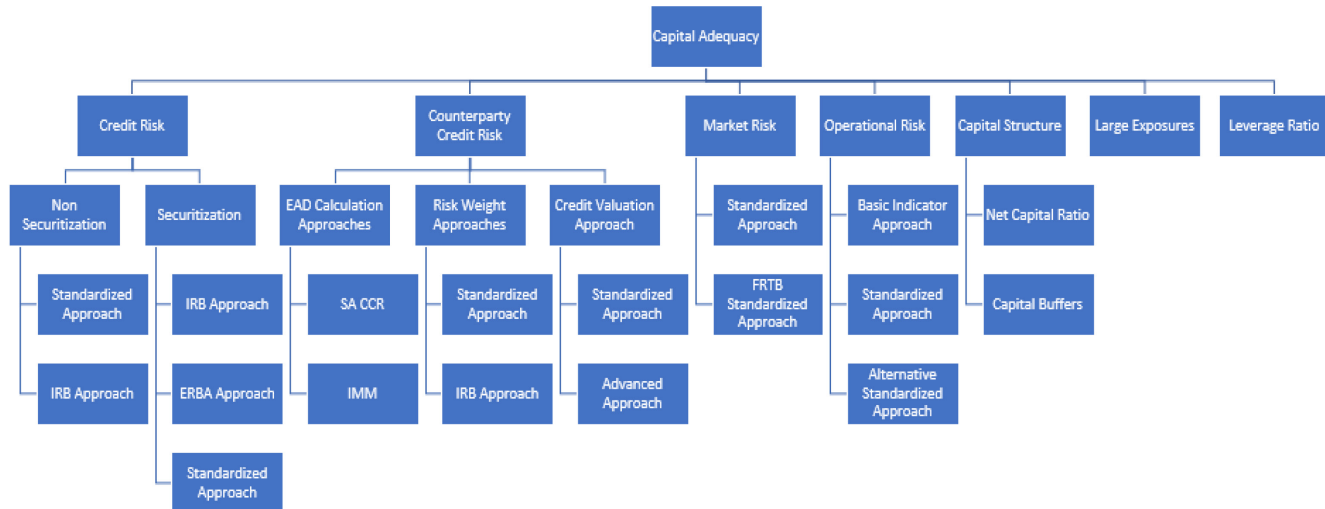

6.2.1 Credit RWA

Credit RWA is the calculation of Non-securitization RWA.

This includes the portfolio of banking and investment for the non-securitized exposures and securitization portfolio for the securitization positions. The application complies with the standardized approach and IRB approach of the credit risk calculations.

A few processes such as Credit Rating, Party Type Reclassification, and Mitigant Data Population are common between. Credit RWA and Counterparty Credit RWA.

This also includes the settlement risk calculation about the unsettled transactions depending on the number of days they are unsettled.

6.2.2 Counterparty Credit RWA

Counterparty Credit RWA is the calculation of the counterparty credit risk exposures. This includes the derivative portfolio and the Securities and Financing transaction portfolio. This also includes the exposures in both banking book and trading book.

6.2.3 Default Fund Contributions Related Capital Charge

A default fund contribution refers to the funds contributed, or commitments made by a clearing member to a Central Counterparty's (CCP) equalized loss-sharing agreement. The purpose of such default funds is to provide capital, in addition to the collateral posted by participants and in addition to capital provided by

the clearinghouse, as a safeguard against extraordinary losses that might occur in connection with. The application also helps in the computation of the default fund related capital charges.

6.2.4 Credit Valuation Adjustments

The mark to market counterparty credit losses or the spread migration risk is captured with CVA, which was not directly capitalized before. CVA is the difference between the risk-free portfolio value and the true portfolio value that considers the possibility of the counterparty's default. In other words, CVA is the market value of counterparty credit risk.

The application calculates CVA Charge for the OTC portfolio of a bank. When using the standardized approach, it is calculated at the portfolio level and for the advanced approach, it is calculated at the counterparty level. CVA Charge does not apply to the trades with the central counterparty and structured finance transactions. Structured Finance transactions are applicable only if the supervisor specifically mentions the same.

6.2.5 Credit RWA for Securitization

The application also complies with the required calculations for the securitization portfolio. This is dependent on the revised guidelines for securitization, which focused on addressing the shortcomings of the existing guidelines. This calculation complies with the underlying securitization being part of the banking portfolio and being part of either bank's assets or assets of other banks.

6.2.6 Market Risk RWA

The Basel Committee had introduced Market Risk Capital Charge calculation in 1996 as an amendment to the earlier Basel accord by considering the risk borne by a financial institution having exposures in the trading book. BIS defines Market Risk as "the risk of losses in the on and off-balance-sheet positions arising from movements in market prices". It is the risk that arises out of the adverse movements of the market factors. Market risk consists of the risk borne by the bank due to the positions in its trading book.

6.2.7 Operational Risk RWA

As per the Basel accord, "Operational Risk is the risk of loss resulting from inadequate or failed internal processes, people and systems, or external events". External losses can occur due to theft of information or hacking of systems. The Basel accord has prescribed three methods for calculating Operational Risk capital charges and banks can use any of these methods to calculate capital charge:

- Basic Indicator Approach
- Standardized Approach
- Alternative Standardized Approach

Figure 29: Different approaches in Operational Risk Portfolio

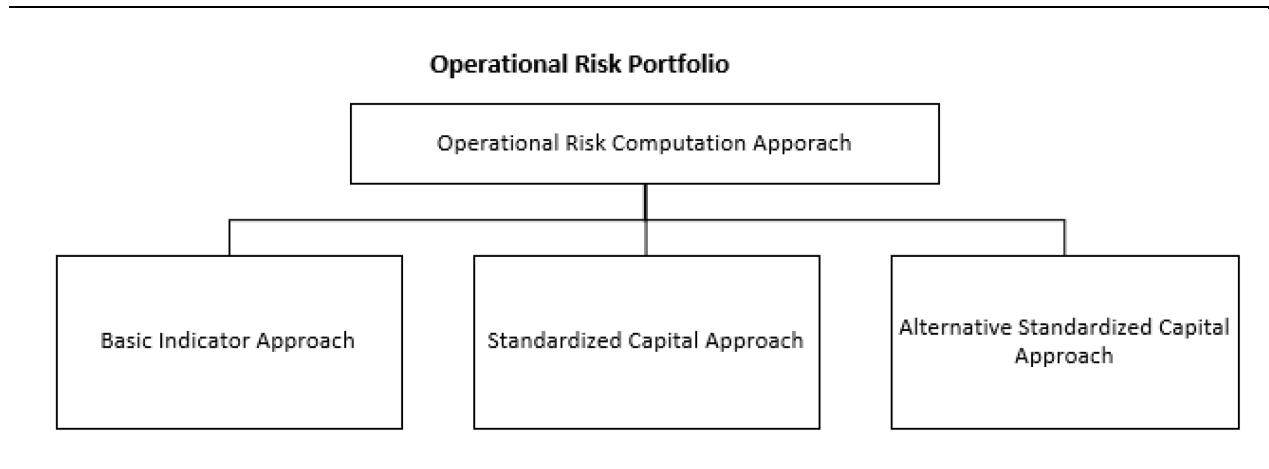

6.2.8 Capital Structure

During the economic crisis, the global banking system had an insufficient level of high-level quality capital. During the crisis, it was identified that there was inconsistency in the definition of capital across jurisdictions and lack of disclosure. To address this issue of inconsistency, the Basel committee has prescribed a new definition of capital to strengthen the global capital framework under Basel III.

As per the new definition in the Basel III accord, total capital consists of some of the following elements:

- Tier1 Capital that consists of
 - Common Equity Tier 1
 - Additional Tier 1
- Tier 2 Capital

Figure 30: Capital structure

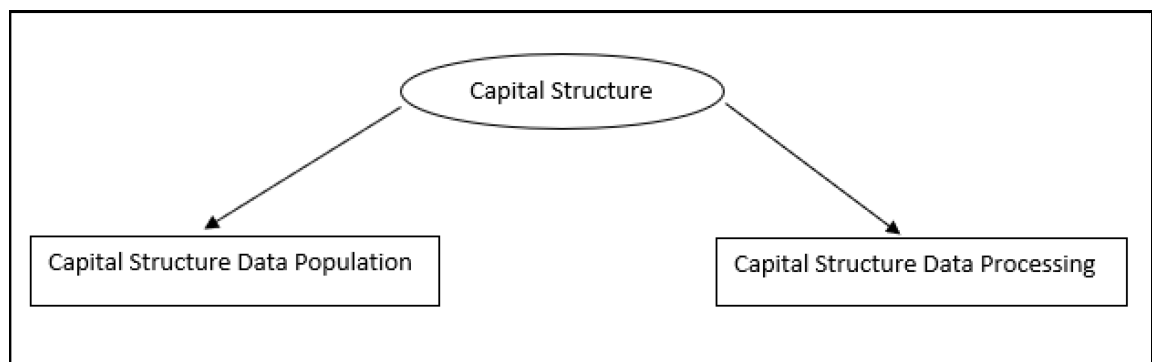

6.2.9 Capital Buffers

Capital Buffer is calculated after the calculation of Capital Ratios, as they go as an input to Buffer calculation. The application complies with the various buffer calculations of Capital Conservation Buffer, Countercyclical Buffer, and GSIB Buffers.

Figure 31: Capital buffer calculations

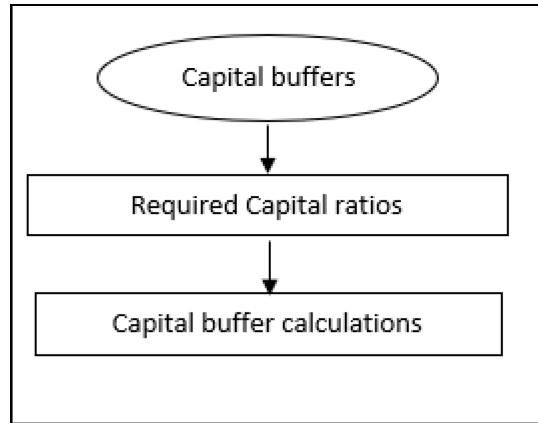

6.2.10 Large Exposures

The large exposure framework is a framework detailing how the banks have to manage their exposures to various parties both at the individual level, as well as to the group of connected clients' level.

The large exposure framework has to have complied by the bank at both solo and consolidated level. As part of the solo execution, the bank has to identify its large exposures and comply within the required threshold limit. And as part of the consolidation execution, the bank has to identify the total large exposures at the consolidated level and comply within the required threshold limit.

The solo and consolidation are as per the regulatory definition, and the same as the one which is being used for the regular capital adequacy.

The large exposures are identified based on the comparison of the total individual party's exposures to the Tier 1 Capital, which changes based on whether it is a solo execution or consolidation execution.

6.2.11 Leverage Ratio

During the financial crisis, banking institutions built-up excessive on-balance sheet and off-balance sheet leverage which forced the banking sector to reduce its leverage. To prevent the building of excessive leverage on the institutions' balance sheet, the BIS has introduced a non-risk-based leverage ratio which is a new regulatory tool supplementing risk-based capital requirement. The application calculates the leverage ratio for a reporting bank. The minimum required leverage ratio is 3%.

The leverage ratio is calculated by dividing an institution's Tier 1 capital measure by the total leverage exposure measure.

$$\text{Leverage Ratio} = \frac{\text{Tier 1 Capital}}{\text{Leverage Exposure Measure}}$$

6.3 Overview of Basel III: Finalizing Post Crisis Reforms

The Basel Committee (BIS) published guidelines for the Basel III: Finalizing Post Crisis Reforms, and it comes into compliance from January 2023. The guidelines that are part of this requirement are as below:

- Basel III: Finalizing post-crisis reforms – December 2017

- Minimum capital requirements for market risk – January 2019
- Leverage Ratio Treatment of Client Cleared Derivatives – June 2019
- Targeted revisions to the credit valuation adjustment risk framework – July 2020

The consolidated guidelines that come into effect from January 2023 are also available as part of the Basel Framework.

The guideline has made changes to the following functionalities:

- Credit Risk
 - Standardized Approach
 - IRB Approach
- Counterparty Credit Risk
 - Credit Valuation Adjustment – Basic Approach – Reduced Version
 - Credit Valuation Adjustment – Basic Approach – Full Version
 - Credit Valuation Adjustment – Standardized Approach – Reduced Version
- Market Risk
 - Standardized Approach using Fundamental Review of the Trading Book
 - Simplified Standardized Approach using Fundamental Review of the Trading Book
 - Internal Model Approach using Fundamental Review of the Trading Book
- Operational Risk
- Leverage Ratio

The OFS Basel Regulatory Capital complies with the following requirement

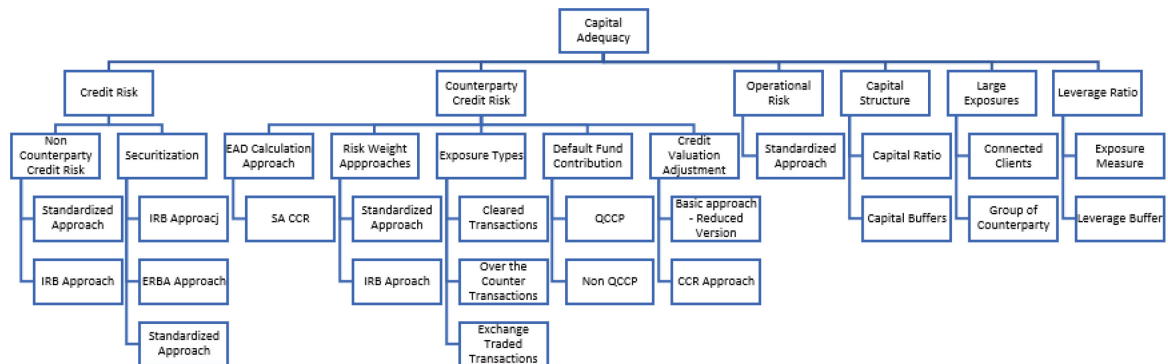

7 Basel III Standardized Approach

Capital Adequacy guidelines as issued in the following regulations are incorporated in OFS Financial Services Basel Regulatory Capital:

BIS Jurisdiction: International Convergence of Capital Measurement and Capital Standards, June 2006.

Basel III: A global regulatory framework for more resilient banks and banking systems, Dec 2010 (rev June 2011).

This approach covers the following topics:

- Credit RWA
- Counterparty Credit RWA
- Default Fund Contributions Related Capital Charge
- Credit Valuation Adjustments
- Credit RWA for Securitization
- Market Risk RWA
- Operational Risk RWA
- Capital Structure
- Capital Buffers
- Large Exposures
- Leverage Ratio

7.1 Credit RWA

Credit RWA is the calculation of Non-securitization RWA.

This includes the portfolio of banking and investment for the non-securitized exposures and securitization portfolio for the securitization positions. The application complies with the standardized approach and IRB approach of the credit risk calculations.

A few processes such as Credit Rating, Party Type Reclassification, and Mitigant Data Population are common between Credit RWA and Counterparty Credit RWA.

This also includes the settlement risk calculation about the unsettled transactions depending on the number of days they are unsettled.

7.1.1 Banking Portfolio

7.1.1.1 Rating Population

The data on ratings is captured in the following rating specific tables:

- Account Rating Table (**STG_ACCOUNT_RATING_DETAILS**)
 - Ratings of all Credit Risk Banking Exposures are captured in this table.

- Party Rating Table (**STG_PARTY_RATING_DETAILS**)
 - Credit Rating for all customers and issuers are captured in this table.
- Sovereign Rating Table (**STG_SOVEREIGN_RATING_DETAILS**)
 - Credit Rating for all countries is captured in this table.

7.1.1.2 Processing Steps

Banks obtain credit ratings from different sources, and these are provided as an input in the application through the rating tables mentioned in the preceding list.

This is handled in the sub-process RATING_RECLASSIFICATION_POPULATION in BIS Other Reclassification process.

The application re-classifies the rating information to BIS Specific standard ratings. The out-of-box application supports the Fitch / Moodys / S&P and DBRS credit rating reclassification for Long Term and Short-Term ratings.

This is handled in the sub-process Credit Rating Reclassification in Credit Rating Reclassification process.

The rating reclassification lookup table FSI Rating Classification (**FSI_RATING_CLASSIFICATION**) is used to lookup reclassified standard ratings so that the reclassification rule is not repeated for each of the rating processing tables.

Ratings are populated from the stage tables (for example, **STG_PARTY_RATING_DETAILS**) to FSI tables (for example, **FSI_PARTY_RATING_DETAILS**) using the lookup table (**FSI_RATING_CLASSIFICATION**) to obtain a reclassified rating.

Ensure that all the columns as indicated in the DL Specs are mandatorily populated with data. For example, in the Stage Party Rating Details (**STG_PARTY_RATING_DETAILS**) table: Rating source code (**V_RATING_SRC_CODE**), Party Code (**V_PARTY_CD**), Original Credit Rating Indicator (**F_ORIGINAL_CREDIT_RATING_IND**), Purpose (**V_PURPOSE**) are required to be populated. The purpose code is to indicate whether the rating is a domestic rating or foreign rating. If any other rating is provided, then the exposure is considered as unrated.

7.1.1.3 Data Population

Credit Risk exposures are updated in the application for all the product types through their respective input tables known as Product Processors. Main categories of Credit Risk Banking exposures, along with their respective table names that are used as an input, are as follows:

Table 8: Data population with product list and product processor

Product	Source Product Processor
Assets Sold	STG_ASSETS_SOLD
Bills	STG_BILLS_CONTRACTS
Credit Cards	STG_CARDS
Guarantees	STG_GUARANTEES
Lease Contracts	STG_LEASE_CONTRACTS
Letters of Credit	STG_LC_CONTRACTS
Line of Credit	STG_CREDIT_LINE_DETAILS
Commitment Contracts	STG_COMMITMENT_CONTRACTS
Loans	STG_LOAN_CONTRACTS
Overdraft	STG_OD_ACCOUNTS

There is a data population pertaining to the mitigants, that cater to all the types of mitigants like collateral, guarantee, and credit derivatives. There is a data population also for counter-guarantee provided for a mitigant.

Table 9: Mitigant list and their details

Product	Source Product Processor
Mitigants – Financial Collateral, Non-Financial Collateral. Pledged Instruments, Guarantee, Credit Derivatives	STG_MITIGANTS
Counter Guarantee	STG_MITIGANT_COUNTER_GUARANTEE

There is a data population pertaining to the mapping between the exposures and the mitigants, as well as mitigant to counter guarantee mapping.

Table 10: Mapping mitigants with source table

Product	Source Table
Mapping for Exposures and Mitigants	STG_ACCOUNT_MITIGANT_MAP
Mapping for Guarantee and Counter Guarantee	STG_MITIGANT_CNTR_GUAR_MAPPING

Processing table details

All Credit Risk Banking exposures are loaded into the table, FSI Cap Banking Exposures (FSI_CAP_BANKING_EXPOSURES) where further processing happens for this portfolio of exposures till the computation pertaining to Pre-Credit Risk Mitigation process.

This is handled in the process **Banking Data Population**.

7.1.1.4 Shareholding Percent Multiplication

Shareholding percent multiplication for common entity level data is a part of BIS Common Data Processing (PMFCOM020) process. In this the application updates the shareholding percentage against each entity is updated with the value of 1 as the shareholding percent and for each child entity, the percentage is based on the parent's holding percentage as specified for each child in Fact Entity Shareholding Percent table (FCT_ENTITY_SHR_HLD_PERCENT).

Shareholding percent multiplication for exposure level is part of each portfolio as well. In this process, the application multiplies the entity shareholding percentage for that entity with respect to parent entity against exposure amount, undrawn amount, provision amount and any other amount relevant for calculation related to that exposure and update the same.

This is handled in the sub-process BNK_SHAREHOLDING_CALCULATION_STD in the process Banking Data Processing – STD.

7.1.1.5 Common Reclassification Rules

The application reclassifies the bank's product types and party types to standard product and party types. Based on the standard product and party type, the asset class for each exposure is arrived at. Similarly, the application does reclassification for mitigant based on its mitigant types and reclassifies it to standard mitigant types.

Ensure that all product type, party type and mitigants which are bank-specific are reclassified, as part of the setup activity. If they are not reclassified, the treatment might not happen as expected by the regulator.

1. Product Type Reclassification

Product types used by the reporting bank as input data are reclassified to standard product types as recommended in the Accord. The product types after reclassification are stored as Basel product types. For Example, Housing Loan is reclassified as Residential Mortgage Exposure.

This is handled in the Basel Product Type Reclassification which is part of the COMMON_RECLASSIFICATION process.

2. Party Type Reclassification

Similar to the product type, the customer type (which are stored as counterparty type) are also reclassified as standard counterparty type. The customer information is expected in the Stage Party Master (STG_PARTY_MASTER), and this also includes the Party Type based on the Stage Party Type Master (STG_PARTY_TYPE_MASTER).

Party type reclassification Rules handle reclassification for customer types. For Example, an Individual is reclassified as Retail.

This is handled in the Party Type Reclassification which is part of PARTY_TYPE_RECLASSIFICATION_POPULATION_STD process.

3. Other Reclassification

As part of the reclassification rules, any other data which is being brought inside the application like seniority, transaction type and so on also get reclassified into OFSAA specific values. This is also

mandatory to be done, as otherwise data will not be available for processing as required by the regulator. This happens as part of the process **COMMON_RECLASSIFICATION**.

7.1.1.6 **Asset Reclassification Rules**

Based on Basel product type and standard counterparty type, an asset class is formed by the application. This asset class is used for data processing. The asset class is the same as specified in the accord.

For example, Standard counterparty is Corporate non-SME and Corporate SME, the asset class is corporate. For Basel product type Residential Mortgage Exposure, the asset class is Claims Secured by Residential Real Estate.

The asset class for all mitigants is reclassified based on their standard mitigant types and standard issuer type.

This happens in the BNK_RECLASSIFICATION_STD (PMFBNK002) sub-process of the process Banking Data Processing.

7.1.1.7 **Pre-mitigation Calculations**

Based on the asset class, the application calculates the Pre-Credit Risk Mitigation (CRM) Exposure at Default (EAD) for each exposure. This value signifies the maximum loss that the bank can suffer, in case of default on this exposure, before considering any mitigation effects.

Some exposures can be hedged against credit risk through various mitigants such as guarantees, collaterals, credit derivatives, and so on. These provide mitigation to credit risk and must be considered while computing Credit RWA, as per the Accord. Hence, the application calculates the pre-mitigation exposure amount and post-mitigation exposure amount.

The application also computes pre-mitigation risk-weighted assets (Pre CRM RWA) and post-mitigation risk-weighted assets (Post CRM RWA) by multiplying the respective EAD by risk weight. The risk weight is arrived at, by considering the credit rating of the exposures and mitigants as per the guidelines.

7.1.1.7.1 **Exposure at Default Amount Calculation**

Credit Conversion Factor (CCF Assignment)

This is an input required for converting the off-balance sheet component of the exposure (undrawn portion associated with an on-balance sheet or off-balance sheet product, or the exposure amount of an off-balance sheet product). This is based on the supervisory provided values and is determined based on the product type and the maturity associated with the exposure.

This populates the Drawn CCF (for the CCF to be assigned to the exposure amount of the off-balance sheet product) and the Undrawn CCF (for the CCF to be assigned to the undrawn portion of the on-balance sheet and off balance sheet exposures).

This happens in the process **BNK_CCF_ASSIGNMENT_STD in Banking Data Processing – STD process**.

Pre CRM EAD

Exposure at Default (EAD) is calculated for all the products. This is being computed using the Exposure Amount (EOP Balance of the Exposure and adjusting for Provision amount, if any), Undrawn Amount of the Exposure (Undrawn Amount) and the Credit Conversion Factor for the Off-Balance sheet Amount (CCF). This is computed for the on-balance sheet products separately, and the off-balance sheet products separately.

This happens in the sub-process **BNK_PRE_CRM_EAD_COMPUTATION_STD** in **Banking Data Processing – STD process**.

Post CRM EAD

Through the CRM process, the bank considers the effect of the mitigation and calculates the post-mitigation Exposure at Default amount. This signifies the maximum loss that the bank can suffer in case of default on this exposure, after considering the effects of the mitigation. This will be the EAD of the Exposure Pre-Mitigation less the covered portion of the mitigant.

7.1.1.7.2 Multiple Assessment

For exposures with multiple ratings, risk weight assignment is based on multiple assessment process. For each exposure, the final rating is the worst of the best two ratings assigned to the exposure. In case of exposure having multiple ratings associated with the same risk weight and belonging to an equivalent rating, the same will be assigned to the exposure. In the case of exposure having only a single rating, the single rating and corresponding risk weight will be considered for the exposure.

The risk weight corresponding to this rating is then assigned to the exposure.

Exposures for multiple rating assessment are first moved into the table FSI Multiple Rating Processing (FSI_MULTIPLE_RATING_PROCESSING) wherein the ranking and final selection of which rating to use takes place.

This happens in the sub process of

BNK_MULTIPLE_RATING_ASSESSMENT_DATA_POPULATION(PMFBNK009), wherein the data for the multiple assessment processing gets populated into the FSI table.

In the task **BNK_MULTIPLE_RATING_ASSESSMENT**, the identification of the multiple rating for the exposure happens, and the **BNK_RISK_WEIGHT_METHODODOLOGY_ASSIGNMENT** assigns the actual risk weight and final rating assignment happens for the exposures.

All the above fall under Banking Data Processing – STD process.

7.1.1.7.3 Issue Issuer Assessment

For all the exposures that remain unrated after the multiple assessment processes, the issue issuer process is performed. This happens in the Issue Issuer Assessment sub-process (**BNK_BNK_ISSUE_ISSUER_ASSESSMENT**). In this case, the unrated exposures are assigned a reference rating based on the reference issue available or the rating of the party, whichever is applicable. These unrated exposures are assigned a risk weight based on the reference rating.

The reference rating is expected to be provided by the bank for the corresponding counterparty that is unrated in the Stage Issue Details (**STG_ISSUE_DETAILS**). The reference issue must have the seniority also provided as that will be used for identifying whether the reference is an eligible issue for this assessment. For unrated Banking exposures, the application does an issue-issuer assessment to infer a rating of the unrated exposures, based on the rating of a similar instrument (referred to as reference issue hereafter) issued by the same issuer. The reference issue is used only when it is of the same currency as the exposure and the exposure is senior or equivalent to the same. For the unavailable reference issue, the party rating is used. In the case of the party also being unrated, the exposure remains unrated. The application also considers the Domestic and Foreign Ratings and Long term and short term ratings to be used for the sake of issue issuer assessment.

Also, the application populates whether the exposure is LT rated or ST rated, based on the rating assigned to the exposure.

7.1.1.7.4 Risk Weight Assignment Rules

Banking Exposures Risk Weight

Risk Weight is assigned based on asset class and the credit rating as per Basel guidelines. The risk weight rules operate on the risk weight table (**FSI_RW_MAP_MASTER**). Highly rated exposures are allocated low-risk weight and poorly rated exposures are allocated high-risk weights. If exposure has more than one rating (rated by more than one agency), then the final rating is assigned based on multiple assessments. The application updates the risk weights against the exposures directly, when ratings are not considered. Options for risk-weighting are selected during Run definition if the Run Management UI is used, to update the required calculations as allowed by the specific jurisdiction. For more details on the options, see the [Regulatory Definition](#) section

Figure 32: Risk weight process

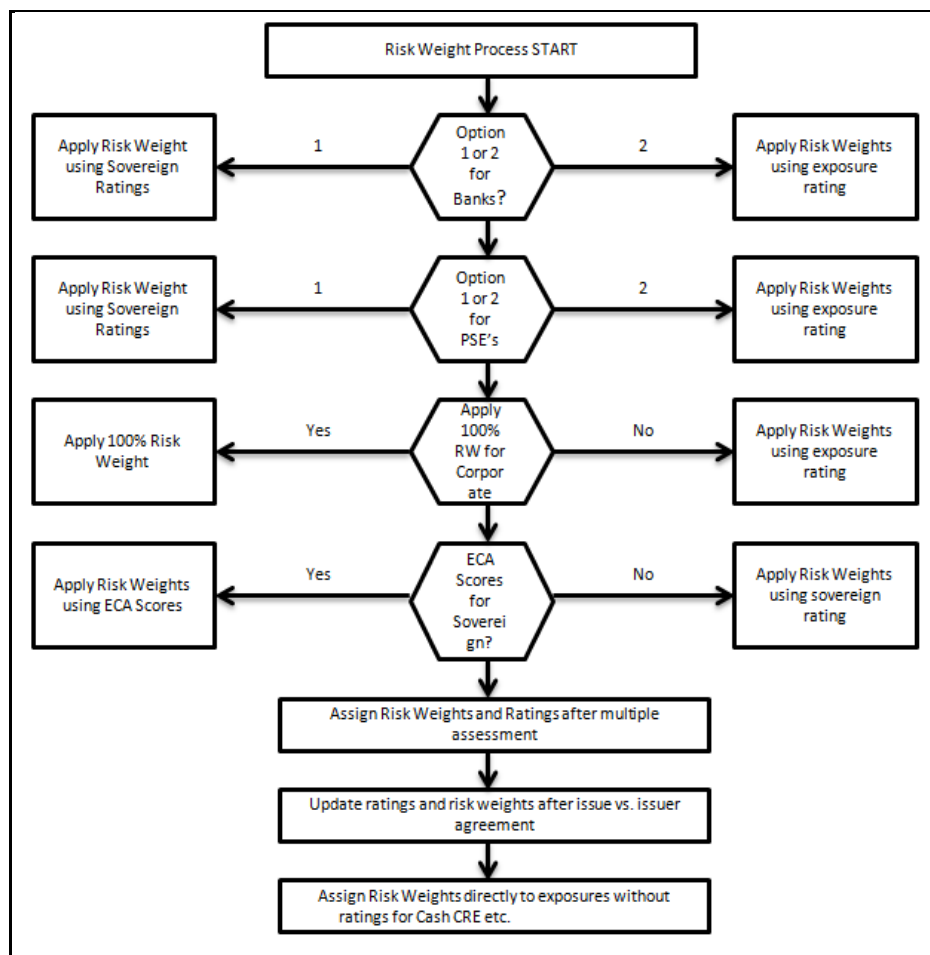

Risk weight assignment takes place in the sub-process: **BNK_RISK_WEIGHT_ASSIGNMENT_STD** in Banking Data Processing – STD process.

Risk Weight for Regulatory Retail Portfolio:

The risk weight specifically for Regulatory Retail Portfolio depends on the exposures satisfying different criterion like Orientation criterion, product criterion, Granularity criterion and low value of individual exposures criterion. All these criterion gets checked by the application and based on the exposure satisfying all of these criteria, the exposure gets assigned to regulatory retail portfolio. This gets handled in the sub process BNK_REGULATORY_RETAIL_PORTFOLIO in Banking Data Processing – STD process.

Risk Weight for Past Due Exposures:

The application identifies the past due exposures on the basis of the defaulted flag. In certain jurisdictions, wherein there is an option to consider even 150% RW exposures as defaulted exposures, the same also gets considered for the past due treatment. The risk weight for the past due exposures are assigned based on the portion of the exposure that is unsecured and the provision coverage ratio for the same, This gets handled in the sub process BNK_PAST_DUE_TREATMENT_STD in Banking Data Processing – STD process.

7.1.1.7.5 RWA Calculations

The RWA is calculated as the Pre-mitigation EAD multiplied by the Pre-Mitigation Risk Weight.

This is handled under the sub-process BNK_PRE_CRM_RISK_WEIGHTED_ASSET_CALCULATION_STD in Banking Data Processing – STD process.

7.1.1.8 Credit Risk Mitigation Process

In order to calculate the post CRM RWA, application needs to account for mitigants which may be in the form of collaterals, guarantees, credit derivatives. Not all mitigants are eligible for RWA computation. All the mitigants which get populated into the system are being made ineligible, and then the regulatory approved mitigant types and the issuer type combination are made eligible.

7.1.1.8.1 Mitigant Processing**Mitigant Data population**

Mitigant data is loaded from the Stage Mitigant table (STG_MITIGANTS) into the FSI CAP Mitigants table (FSI_CAP_MITIGANTS) where further processing takes place. This happens under the sub-process Mitigant Data Population under the process Mitigant Data Processing.

Mitigant Multiple assessment

Similar to exposures with multiple ratings, mitigants with multiple ratings are also subject to Multiple rating Assessment. This is handled under the sub-process Mitigant Multiple Rating Assignment – BIS under the process Mitigant Data Processing. In the case of mitigants, the data is expected only for Instruments and Party.

The Data Transformation **CAP_MITIGANT_MULTIPLE_ASSESSMENT_DATA_POP** performs this.

7.1.1.8.2 Mitigant Approaches and their Risk Weighting Rules**Mitigant Risk Weight**

For Simple approach, the application assigns risk weight to mitigants on the basis of credit rating (CAP Mitigant Basel Rating and Risk Weight Assignment), original maturity (CAP Mitigant RW Assignment

based on Original Maturity) and for Nettable Liabilities (CAP Mitigant RW Assignment for Nettable Liabilities). These fall under the process Mitigant RW Assignment – Simple –BIS.

Similarly, for Comprehensive approach, mitigant risk weights are assigned on the basis of credit rating (CAP Mitigant Basel Rating and Risk Weight Assignment), for financial collaterals (CAP Mitigant RW Assignment for Financial Collaterals - Comprehensive Approach) and for nettable liabilities (CAP Mitigant RW Assignment for Nettable Liabilities). These fall under the process Mitigant RW Assignment – BIS – Comprehensive Appr.

Mitigant Eligibility

The application identifies the eligible mitigants based on the criteria as mentioned by the Regulator. The application identifies the following standard mitigants– collateral, guarantees, and credit derivatives.

The application can use the Simple Approach and the Comprehensive Approach for the mitigants which are part of the collateral. The application identifies the eligibility of the financial collateral separately for the simple approach and the comprehensive approach. The eligibility of the collateral mitigants is based on the party type of the mitigant, mitigant types, the credit rating assigned to the mitigant or the party (as applicable), and the classification of collateral as senior or not. For equity, the eligibility is based on the main index equity and the equity trading status. This is handled in CAP Mitigant Eligibility for Equity - Simple approach under the process Mitigant Collateral Eligibility Simple Approach –BIS.

For mutual funds, the eligibility is based on the eligible mutual fund indicator. This is handled in CAP Mitigant Eligibility for Mutual Fund - Simple approach under the process Mitigant Collateral Eligibility Simple Approach -BIS

The application also identifies whether the mitigant is a Re-securitized exposure and if yes, makes it ineligible.

This is handled in CAP Collateral Eligibility - Simple Approach under the process Mitigant Collateral Eligibility Simple Approach -BIS

The application identifies the eligibility of the guarantees and credit derivatives based on the party type of the mitigant and the credit rating assigned to the issuer of the mitigant. This is handled in CAP Non Sec Mitigant Eligibility under the process Mitigant Collateral Eligibility Simple Approach –BIS.

Similar mitigant eligibility rules for Comprehensive Rule can be found in the process Mitigant Collateral Eligibility – Comprehensive Approach –BIS

The option for the bank to select Collateral Simple Approach or Comprehensive Approach is based on the Run Management option as selected in the UI.

7.1.1.8.3 Mitigant Haircut Assignment

Under Standardized approach, the bank has to follow supervisory estimates for Mitigant Haircut assignment. This is based on the various categories like mitigant type, residual maturity, rating, issuer type and so on. This is applicable only if the bank follows comprehensive approach for collateral.

Only eligible mitigants are considered for haircut assignment and for further processing. Post haircut assignment, the eligible mitigants are moved from mitigants table (**FSI_CAP_MITIGANTS**) to sub exposures table (**FSI_CAP_SUB_EXPOSURES**).

The application does computations for three kinds of mitigant haircuts which are Volatility haircut, Forex haircut, and Maturity Mismatch haircut.

Volatility Haircut

Volatility haircuts are assigned to the collateral to account for any future fluctuations in the market value of the financial collateral. The application assigns haircuts for various types of financial collateral like debt securities, equity, mutual funds, and so on. In the supervisory haircut method, the application assigns volatility haircut based on issues, issuer's ratings, mitigant's residual maturity, and type of mitigant.

This is handled in CAP CRM Mitigant Volatility Haircut - Supervisory Haircut under CRM Sub Exposure Data Haircut Assignment process.

Forex Haircut

If the exposure and collateral are in different currencies, then the application makes an adjustment by applying the Forex haircut.

This is handled in CAP CRM Forex Haircut Sub Exposures under CRM Sub Exposure Data Haircut Assignment process.

Maturity Mismatch Haircut

If the residual maturity of the Credit Risk Mitigant is less than that of the underlying credit exposure, then a maturity mismatch haircut is applied to adjust the value.

This is handled under CAP CRM Maturity Mismatch Haircut under CRM Sub Exposure Data Haircut Assignment process.

7.1.2 Investment Portfolio

7.1.2.1 Rating Population

The data on ratings is captured in the following rating specific tables:

- Instrument Rating Table (**STG_INSTRUMENT_RATING_DETAILS**)
 - Ratings for investment exposures subject to credit risk (one that is in **STG_INVESTMENTS**) and mitigants are captured in this table.
- Party Rating Table (**STG_PARTY_RATING_DETAILS**)
 - Ratings for the customer are captured in this table.
- Sovereign Rating Table (**STG_SOVEREIGN_RATING_DETAILS**)
 - Credit Rating for all countries is captured in this table.
- External Underlying Exposures Rating Table (**STG_EXT_ULY_ACCT_RATING_DTL**)
 - Credit Rating for all external underlying exposures is captured in this table. In the case of underlying exposures of CIU transactions, it is expected that the value of Exposure ID is that of the instrument ID to which the underlying exposures belong to. For example: If the Underlying Exposure ID EXP001, which belongs to the instrument INSTR001, and which has the parent ID as PARENT001; in this case, the data expected in this table is of the instrument INSTR001, with the Exposure ID as INSTR001.

7.1.2.2 Processing Steps

Banks obtain credit ratings from different sources, and these are provided as an input in the application through the rating tables mentioned in the preceding list.

This is handled in the sub-process Multiple Rating Assessment in BIS Other Reclassifications process.

The application re-classifies the rating information to BIS Specific standard ratings. The out-of-box application supports the Fitch / Moodys / S&P and DBRS credit rating reclassification for Long Term and Short-Term ratings.

This is handled in the sub-process Credit Rating Reclassification in Investment Data processing.

The rating reclassification lookup table (**FSI_RATING_CLASSIFICATION**) is used to lookup reclassified standard ratings so that the reclassification rule is not repeated for each of the rating processing tables. Ratings are populated from the stage tables (for example, **STG_PARTY_RATING_DETAILS**) to FSI tables (for example, **FSI_PARTY_RATING_DETAILS**) using the lookup table (**FSI_RATING_CLASSIFICATION**) to obtain a reclassified rating.

Ensure that the following columns are mandatorily populated with data in the **STG_PARTY_RATING_DETAILS** table: Rating source code (**V_RATING_SRC_CODE**), Party Code (**V_PARTY_CD**), Purpose (**V_PURPOSE**): In this field whether the rating is a domestic rating or foreign rating must be indicated. If any other rating is provided, then the exposure is considered as unrated. Data Population.

The following are the preprocessing steps:

Credit Risk exposures are updated in the application for all the product types through their respective input tables known as Product Processors. Main categories of Credit Risk Investment exposures, along with their respective table names that are used as an input, are as follows:

Table 11: List of products and source product processor

Product	Source Product Processor
Investment Products:	STG_INVESTMENTS
Money Market Instruments	STG_MM_CONTRACTS
Spot Forex Transactions	STG_FX_CONTRACTS
Fixed Assets	STG_FIXED_ASSETS

7.1.2.3 Data Population

There is a data population about the mitigants, which cater to all the types of mitigants like collateral, guarantee, and credit derivatives. There is one data population about the counter-guarantee for the guarantor.

Table 12: Data population list with source product processor

Product	Source Product Processor
Mitigants – Collateral, Guarantee, Credit Derivatives	STG_MITIGANTS
Mitigant Master Table	STG_MITIGANT_MASTER

There is a data population about the mapping between the exposures and the mitigants.

Table 13: Mapping for exposure and mitigants and source table

Product	Source Table
Mapping for Exposures and Mitigants	STG_ACCOUNT_MITIGANT_MAP

In the case of investments in funds (CIUs), the underlying of the CIU is captured in either of the below tables, depending on the data availability

Table 14: CIU for source product processor

Product Type	Source Product Processor
Underlying composition Details of CIU	STG_FUND_CIS_COMPOSITION
Underlying Exposures of CIU	STG_FUND_UNDERLYNG_COMPOSITION

Processing table details

All Credit Risk Investment exposures are loaded into the table, FSI CAP Investment Exposures, **FSI_CAP_INVESTMENT_EXPOSURES** where further processing happens for this portfolio of exposures till the computation pertaining to Pre-Credit Risk Mitigation process

This is handled in the process Investment Data Population.

7.1.2.4 Shareholding Percent Multiplication

Shareholding percent multiplication for common entity level data is a part of BIS Common Data Processing (PMFCOM020) process. In this the application updates the shareholding percentage against each entity. The parent entity is updated with the value of 1 as the shareholding percent and for each child entity, the percentage is based on the parent's holding percentage as specified for each child in fact entity shareholding percent table (**FCT_ENTITY_SHR_HLD_PERCENT**).

Shareholding percent multiplication for exposure level is part of each portfolio as well. In this process, the application multiplies the entity shareholding percentage for that entity with respect to parent entity against exposure amount, undrawn amount and provision amount for that exposure and update the same.

This is handled in the sub-process **INV_SHAREHOLDING_CALCULATION_STD** of the process Investment Data Processing – STD.

7.1.2.5 Common Reclassification Rules

The application reclassifies the bank's product types and party types to standard product and party types. Based on the standard product and party type, the asset class for each exposure is arrived at. Similarly, the application does reclassification for mitigant based on its mitigant types and reclassifies it to standard mitigant types.

Ensure that all products and party type and mitigants which are bank-specific are reclassified, as part of the setup activity. If they are not reclassified, the treatment might not happen as expected by the regulator.

1. Product Type Reclassification

Product types used by the reporting bank as input data are reclassified to standard product types as recommended in the Accord. The product types after reclassification are stored as Basel product types. For Example, Fixed Rate Bond is reclassified as Debt Securities

This is handled in the Basel Product Type Reclassification which is part of the **COMMON_RECLASSIFICATION** process.

2. Party Type Reclassification

Similar to the product type, the customer type (which are stored as counterparty type) are also reclassified as standard counterparty type. The customer information is expected in the Stage Party Master (**STG_PARTY_MASTER**), and this also includes the Party Type based on the Stage Party Type Master (**STG_PARTY_TYPE_MASTER**).

Party type reclassification Rules handle reclassification for customer types. For Example, housing finance company is reclassified as Corporate

This is handled in the Party Type Reclassification which is part of Investment Data Population

3. Other Reclassification

As part of the reclassification rules, any other data which is being brought inside the application like seniority, transaction type and so on also get reclassified into OFSAA specific values. This is also mandatory to be done, as otherwise data will not be available for processing as required by the regulator.

This happens as part of the process **COMMON_RECLASSIFICATION**.

7.1.2.6 Asset Reclassification Rules

Based on Basel product type and standard counterparty type, an asset class is formed by the application. This asset class is used for data processing. The asset class is the same as specified in the accord.

For example, Standard counterparty is Corporate non-SME and Corporate SME, the asset class is corporate. For Basel product type gold, the asset class is Gold.

The asset class for all mitigants is reclassified based on their standard mitigant types and standard issuer type.

This happens in the sub-process **INV_RECLASSIFICATION_STD** of the process Investment Data Processing - STD.

7.1.2.7 Pre-mitigation Calculations

Based on the asset class, the application calculates the Pre-Credit Risk Mitigation (CRM) Exposure at Default (EAD) for each exposure. This value signifies the maximum loss that the bank can suffer, in case of default on this exposure, before considering any mitigation effects.

Some exposures can be hedged against credit risk through various mitigants such as guarantees, collaterals, credit derivatives, and so on. These provide mitigation to credit risk and must be considered

while computing Credit RWA, as per the Accord. Hence, the application calculates the pre-mitigation exposure amount and post-mitigation exposure amount.

The application also computes pre-mitigation risk-weighted assets (Pre CRM RWA) and post-mitigation risk-weighted assets (Post CRM RWA) by multiplying the respective EAD by risk weight. The risk weight is arrived at, by considering the credit rating of the exposures and mitigants as per the guidelines.

7.1.2.7.1 Exposure at Default Amount Calculation

Pre CRM EAD

Exposure at Default (EAD) is calculated for all the products. This is being computed using the Exposure Amount (EOP Balance of the Exposure)

This happens in the process INV_PRE_CRM_EAD_COMPUTATION_STD of the process Investment Data Processing - STD.

Post CRM EAD

Through the CRM process, the bank considers the effect of the mitigation and calculates the post-mitigation exposure at the default amount. This signifies the maximum loss that the bank can suffer in case of default on this exposure, after considering the effects of the mitigation. This will be the EAD of the Exposure Pre-Mitigation less the covered portion of the mitigant

7.1.2.7.2 Multiple Assessment

For exposures with multiple ratings, risk weight assignment is based on multiple assessment process. For each exposure, the final rating is the worst of the best two ratings assigned to the exposure.

The risk weight corresponding to this rating is then assigned to the exposure.

Exposures for multiple rating assessment are first moved into the table FSI Multiple Rating Processing (**FSI_MULTIPLE_RATING_PROCESSING**) wherein the ranking and final selection of which rating to use takes place.

This happens in the sub process of **INV_MULTIPLE_RATING_ASSESSMENT_DATA_POPULATION**, wherein the data for the multiple assessment processing gets populated into the FSI table.

MULTIPLE_RATING_ASSESSMENT, wherein the identification of the multiple rating for the exposure happens, and the **INV_MULTIPLE_ASSESSMENT_BASED_RISK_WEIGHT_ASSIGNMENT** wherein the actual risk weight and final rating assignment happens for the exposures.

All the above fall under Investment Data Processing – STD.

7.1.2.7.3 Issue Issuer Assessment

For all exposures which remain unrated after the multiple assessment processes, the issue issuer process is performed. This happens in the Issue Issuer Assessment sub-process

INV_INV_ISSUE_ISSUER_ASSESSMENT). In this case, the unrated exposures are assigned a reference rating based on the reference issue available or the rating of the party, whichever is applicable. These unrated exposures are assigned a risk weight based on the reference rating.

For unrated non-Securitized exposures, the application does an issue-issuer assessment to infer a rating of the unrated exposures, based on the rating of a similar instrument (referred to as reference issue hereafter) issued by the same issuer. The reference issue is used only when it is of the same currency as the exposure and the exposure is senior or equivalent to the same. For the unavailable reference issue, the

party rating is used. In the case of the party also being unrated, the exposure remains unrated. Also, the application populates whether the exposure is LT rated or ST rated, based on the rating assigned to the exposure.

7.1.2.7.4 Risk Weight Assignment Rules

Non-Sec Exposures Risk Weight

Risk Weight is assigned based on asset class and the credit rating as per Basel guidelines. The risk weight rules operate on the risk weight table (**FSI_RW_MAP_MASTER**). Highly rated exposures are allocated low-risk weight and poorly rated exposures are allocated high-risk weights.

If exposure has more than one rating (rated by more than one agency), then the final rating is assigned based on multiple assessments. The application updates the risk weights against the exposures directly when ratings are not considered.

Options for risk-weighting are selected during Run definition if the Run Management UI is used, to update the required calculations as allowed by the specific jurisdiction. For more details on the options, see the [Run Management](#) section.

This is handled under the sub-process: **INV_RISK_WEIGHT_ASSIGNMENT_STD** in Investment Data Processing – STD process.

Funds/ Collective Investment Units

Equity Investments in Funds – (Collective Investment Units (CIU) Processing)

The CIU is funds that have invested in various exposures. The accord has specified various criteria for risk weighting CIU exposures. The application supports all the approaches. In the case of CIU, the application follows a hierarchy of approaches:

- Look Through Approach
- Mandate Based Approach
- Fall Back Approach

Figure 33: Processing CIU

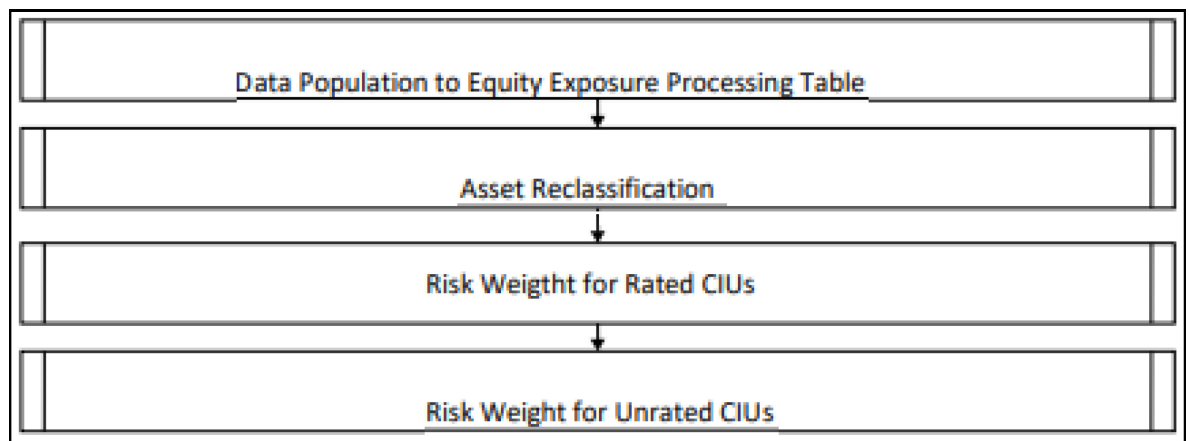

The exposures to CIU are expected in the table Stage Investments (**STG_INVESTMENTS**), and the instrument code is expected to be populated for these exposures. The static information related to the instruments is expected in the Instrument contract dimension table (**DIM_INSTRUMENT_CONTRACT**),

and the information about the instruments, which change periodically like the current outstanding issue amount, is expected in the Stage Instrument Contract Detail table (**STG_INSTRUMENT_CONTRACT_DTL**).

The underlying exposures of CIU are expected in **STG_FUND_CIS_COMPOSITION** with the fund code (instrument code) populated also into Parent Instrument Code.

The underlying composition of the CIU is expected in the table Stage Fund Underlying Composition (**STG_FUND_UNDERLYNG_COMPOSITION**). This has the underlying composition details of the fund, across various products, and the maximum permissible limit of investment in each of the product types, with the fund code as the Instrument ID.

NOTE:

The fund underlying composition and/or the underlying exposures are required for processing, only when the underlying of the fund is not available and when there is mandate information available for the fund.

When the derivatives products are underlying for a CIU, then the MTM value of the derivative is expected to be given as Asset MTM Value (N_ASSET_MTM_VALUE) in Stage Fund CIS Composition (**STG_FUND_CIS_COMPOSITION**). MTM value of the derivative must also be populated to Composition Value (N_COMPOSITION_VALUE).

NOTE:

Unless operational criteria are met, the look-through approach is not applicable.

Look Through Approach

The first approach in the hierarchy that application assigns based on the operational criteria given in the accord is LTA. To validate the operational criteria or conditions given, data is expected as input. Along with the suggested conditions application also checks for the availability of the underlying information. If all the sufficient information is available, the application assigns the Look Through Approach (LTA) and computation will be followed as given in the accord. If operational criteria are not met, the application checks for the immediate next approach.

The look through approach is handled in the sub-process CIU - INV – Risk Weight Method Assignment – Look Through Approach in the process **INV_CIU_RISK_WEIGHT_METHOD_CALCULATION**.

Mandate Based Approach

This approach is applied when the information of the underlying and the third-party risk weights that can be used under the look-through approach are not available. To continue with this approach banks, need to have the mandate information required. Once the application checks for the information and assigns the approach, computations for MBA under the Standardized approach are in line with the Basel Accord.

This is handled in the sub-process CIU - INV – Risk Weight Method Assignment – Mandate Based Approach in the process **INV_CIU_RISK_WEIGHT_METHOD_CALCULATION**.

Fall Back Approach

If no approach from the hierarchy is applicable based on the checks performed, the application assigns Fall Back Approach. In this approach, all the exposures will be risk-weighted at 1250%.

This is handled in the sub-process CIU - INV – Risk Weight Method Assignment – Fall Back Approach in the process **INV_CIU_RISK_WEIGHT_METHOD_CALCULATION**.

Partial use of an approach

A bank may use a combination of the three approaches when determining the capital requirements for an equity investment in an individual fund, provided that the conditions for all the approaches are met.

This will be applicable only in the case of the treatment of funds in other funds, as within a fund the method cannot be different.

Treatment of funds invested in other funds

If the underlying information is available, then application checks for the approach that is used by the funds. If the approach is not same across then FBA will be assigned i.e., if the approach used for determining the RW of a fund and the same approach is also where it is invested. Further, if same then application carry on with the same approach (Look through or Mandate based approach respectively), if not then we will assign 1250% under Fall Back Approach.

7.1.2.7.5 RWA Calculations

The RWA is calculated as the Pre-mitigation EAD multiplied by the Pre-Mitigation Risk Weight.

This is handled under the sub-process **INV_PRE_CRM_RISK_WEIGHTED_ASSET_CALCULATION_STD** under the process Investment Data Processing – STD.

7.1.2.8 Credit Risk Mitigation Process

To calculate the post CRM RWA, application needs to account for mitigants which may be in the form of collaterals, guarantees, credit derivatives. Not all mitigants are eligible for RWA computation. All the mitigants which get populated into the system are being made ineligible, and then the regulatory approved mitigant types and the issuer type combination are made eligible.

7.1.2.8.1 Mitigant Processing

Mitigant Data population

Mitigant data is loaded from the Stage Mitigant table (STG_MITIGANTS) into the FSI CAP Mitigants table (FSI_CAP_MITIGANTS) where further processing takes place. This is takes place under the sub-process Mitigant Data Population in the process Mitigant Data Processing.

Mitigant Multiple assessment

Similar to exposures with multiple ratings, mitigants with multiple ratings are also subject to Multiple rating Assessment. This is handled under the sub-process Mitigant Multiple Rating Assignment – BIS in the process Mitigant Data Processing -STD.

The Data Transformation “**CAP_MITIGANT_MULTIPLE_ASSESSMENT_DATA_POP**” performs this.

7.1.2.8.2 Mitigant Eligibility Approaches and their Risk Weighting Rules

Mitigant Risk Weight

For Simple approach, the application assigns risk weight to mitigants based on credit rating (CAP Mitigant Basel Rating and Risk Weight Assignment), original maturity (CAP Mitigant RW Assignment based on Original Maturity) and for Nettable Liabilities (CAP Mitigant RW Assignment for Nettable Liabilities). These fall under the process Mitigant RW Assignment – Simple –BIS.

Similarly, for Comprehensive approach, mitigant risk weights are assigned based on credit rating (CAP Mitigant Basel Rating and Risk Weight Assignment), for financial collaterals (CAP Mitigant RW Assignment for Financial Collaterals - Comprehensive Approach) and for nettable liabilities (CAP Mitigant RW Assignment for Nettable Liabilities). These fall under the process Mitigant RW Assignment – BIS – Comprehensive Appr.

Mitigant Eligibility

The application identifies the eligible mitigants based on the criteria as mentioned by the Regulator. The application identifies the following standard mitigants– collateral, guarantees, and credit derivatives.

The application can use the Simple Approach and the Comprehensive Approach for the mitigants which part of the collateral are. The application identifies the eligibility of the financial collateral separately for the simple approach and the comprehensive approach. The eligibility of the collateral mitigants are based on the party type of the mitigant, mitigant types, the credit rating assigned to the mitigant or the party (as applicable), and the classification of collateral as senior or not.

For equity, the eligibility is based on the main index equity and the equity trading status. This is handled in CAP Mitigant Eligibility for Equity - Simple approach under the process Mitigant Collateral Eligibility Simple Approach -BIS.

For mutual funds, the eligibility is based on the eligible mutual fund indicator. This is handled in CAP Mitigant Eligibility for Mutual Fund - Simple approach under the process Mitigant Collateral Eligibility Simple Approach -BIS

The application also identifies whether the mitigant is a Re-securitized exposure and if yes, makes it ineligible.

This is handled in CAP Collateral Eligibility - Simple Approach under the process Mitigant Collateral Eligibility Simple Approach -BIS

The application identifies the eligibility of the guarantees and credit derivatives based on the party type of the mitigant and the credit rating assigned to the issuer of the mitigant. This is handled in CAP Non-Sec Mitigant Eligibility under the process Mitigant Collateral Eligibility Simple Approach –BIS.

Similar mitigant eligibility rules for The Comprehensive Rule can be found in the process Mitigant Collateral Eligibility – Comprehensive Approach –BIS.

The option for the bank to select Collateral Simple Approach or Comprehensive Approach is based on the Run Management option as selected in the UI

7.1.2.8.3 Mitigant Haircut Assignment

Under Standardized approach, the bank must follow supervisory estimates for Mitigant Haircut assignment. This is based on the various categories like mitigant type, residual maturity, rating, issuer type and so on. This is applicable only if the bank follows comprehensive approach for collateral.

Only eligible mitigants are considered for haircut assignment and for further processing. Post haircut assignment, the eligible mitigants are moved from mitigants table (**FSI_CAP_MITIGANTS**) to sub exposures table (**FSI_CAP_SUB_EXPOSURES**).

The application does computations for three kinds of mitigant haircuts which are volatility haircut, FOREX haircut, and maturity mismatch haircut.

Volatility Haircut

Volatility haircuts are assigned to the collateral to account for any future fluctuations in the market value of the financial collateral. The application assigns haircuts for various types of financial collateral like debt securities, equity, mutual funds, and so on. In the supervisory haircut method, the application assigns volatility haircut based on issues, issuer's ratings, mitigant's residual maturity, and type of mitigant.

This is handled in CAP CRM Mitigant Volatility Haircut - Supervisory Haircut under CRM Sub Exposure Data Haircut Assignment process.

Forex Haircut

If the exposure and collateral are in different currencies, then the application makes an adjustment by applying the FOREX haircut.

This is handled in CAP CRM Forex Haircut Sub Exposures under CRM Sub Exposure Data Haircut Assignment process.

Maturity Mismatch Haircut

If the residual maturity of the Credit Risk Mitigant is less than that of the underlying credit exposure, then a maturity mismatch haircut is applied to adjust the value.

This is handled under CAP CRM Maturity Mismatch Haircut under CRM Sub Exposure Data Haircut Assignment process.

7.2 Counterparty Credit RWA

Counterparty Credit RWA is the calculation of the counterparty credit risk exposures. This includes the derivative portfolio and the Securities and Financing transaction portfolio. This also includes the exposures in both banking book and trading book.

The counterparty credit exposures also undergo additional RWA calculation in the form of Credit Valuation Adjustment (CVA). The mark to market counterparty credit losses or the spread migration risk is captured with CVA, which was not directly capitalized before. CVA is the difference between the risk-free portfolio value and the true portfolio value that considers the possibility of the counterparty's default. In other words, CVA is the market value of counterparty credit risk.

7.2.1 Derivatives Portfolio

7.2.1.1 Rating Population

The Data on ratings is captured in the following rating specific tables:

- Party Rating Table (**STG_PARTY_RATING_DETAILS**)
 - Credit rating for all is captured in this table.
- Sovereign Rating Table (**STG_SOVEREIGN_RATING_DETAILS**)
 - Credit Rating for all countries is captured in this table.
 - Instrument Rating Table (**STG_INSTRUMENT_RATING_DETAILS**)

Ratings for all instruments are captured in this table. Even the posted collateral (Placed Collateral) and received collateral (Mitigants) related ratings are captured in this table and this is handled in the process **DRV_INSTRUMENT_RATING_POPULATION**.

7.2.1.1.1 Processing Steps

Banks obtain credit ratings from different sources, and these are provided as an input in the application through the rating tables mentioned in the preceding list.

This is handled in the process **RATING_RECLASSIFICATION_POPULATION**.

The application re-classifies the rating information to BIS Specific standard ratings. The out-of-box application supports the Fitch / Moodys / S&P and DBRS credit rating reclassification for Long Term and Short-Term ratings.

This is handled in the process Credit Rating Reclassification.

The rating reclassification lookup table (**FSI_RATING_CLASSIFICATION**) is used to lookup reclassified standard ratings so that the reclassification rule is not repeated for each of the rating processing tables.

Ratings are populated from the stage tables (for example, **STG_PARTY_RATING_DETAILS**) to FSI tables (for example, **FSI_PARTY_RATING_DETAILS**) using the lookup table (**FSI_RATING_CLASSIFICATION**) to obtain a reclassified rating.

Ensure that all the relevant columns as indicated in the DL Specs are mandatorily populated with data. For example, in the Stage Party Rating Details (**STG_PARTY_RATING_DETAILS**) table: Rating source code (**V_RATING_SRC_CODE**), Party Code (**V_PARTY_CD**), Purpose (**V_PURPOSE**) are required to be populated. The purpose code is to indicate whether the rating is a domestic rating or foreign rating. If any other rating is provided, then the exposure is considered as unrated.

7.2.1.2 Data Population

The following are the preprocessing steps:

Credit Risk exposures are updated in the application for all the product types through their respective input tables known as Product Processors. Main categories of Counterparty Credit Risk exposures, along with their respective table names that are used as an input, are as follows:

Table 15: Product processors and source product processors

Product	Source Product Processor
Swaps	STG_SWAPS_CONTRACTS
Futures	STG_FUTURES
Options	STG_OPTION_CONTRACTS
Credit Derivatives	STG_CREDIT_DERIVATIVES
Forwards	STG_FORWARDS

There is a data population about the placed collateral and central counterparty details, which are required for the cleared transaction and default fund contribution treatment.

Table 16: Data population and source product processor

Product	Source Product Processor
Placed Collateral	STG_PLACED_COLLATERAL
Default Fund Contribution	STG_CCP_DETAILS

There is a data population about the mitigants, which cater to the applicable mitigant type like collateral received for the derivatives.

Table 17: Mitigant and source product processor

Product	Source Product Processor
Mitigants – Collateral received	STG_MITIGANTS

There is a data population about the mapping between the exposures and the mitigants. And one data population about the mapping between the exposures and the placed collateral

Table 18: One data population mapping the exposures

Product	Source Table
Mapping for Exposures and Mitigants	STG_ACCOUNT_MITIGANT_MAP
Mapping for Exposures and Placed Collateral	STG_ACCT_PLACED_COLL_MAP

Processing table details

All Counterparty credit Risk related derivative exposures are loaded into the table, FSI Cap Derivative (**FSI_CAP_DERIVATIVES**) where further processing happens for this portfolio of exposures till, they are moved to the Netting set granularity. This is handled in the process Derivative Data Population process, under sub process.

- DERIVATIVE_FORWARDS_EXPOSURE_DATA_POPULATION
- DERIVATIVE_SWAPS_EXPOSURE_DATA_POPULATION
- DERIVATIVE_FUT_EXPOSURE_DATA_POPULATION
- DERIVATIVE_OPT_EXPOSURE_DATA_POPULATION
- DERIVATIVE_CREDIT_DERIVATIVES_DATA_POPULATION

All placed collateral that the bank has placed, which are not specific to Securities Financing Transactions exposures, are loaded into the table, **FSI_PLACED_COLLATERAL**.

All the collateral that the bank has received, as part of the Derivative transactions, are loaded into the table, **FSI_CAP_MITIGANTS**.

7.2.1.3 Shareholding Percent Multiplication

Shareholding percent multiplication for common entity level data is a part of BIS Common Data Processing (PMFCOM020) process. In this the application updates the shareholding percentage against each entity. The parent entity is updated with the value of 1 as the shareholding percent and for each child

entity, the percentage is based on the parent's holding percentage as specified for each child in fact entity shareholding percent table (**FCT_ENTITY_SHR_HLD_PERCENT**).

Shareholding percent multiplication for exposure level is part of each portfolio as well. In this process, the application multiplies the entity shareholding percentage for that entity with respect to parent entity against exposure amount, undrawn amount and provision amount for that exposure and update the same.

This is handled in the sub-process **DRV_SHAREHOLDING_CALCULATION_STD** of the Derivatives Data Processing.

7.2.1.4 Common Reclassification Rules

The application reclassifies the bank's product types and party types to standard product and party types. Based on the standard product and party type, the asset class for each exposure is arrived at. Similarly, the application does reclassification for mitigant based on its mitigant types and reclassifies it to standard mitigant types.

Ensure that all products and party type and mitigants which are bank-specific are reclassified, as part of the setup activity. If they are not reclassified, the treatment might not happen as expected by the regulator.

1. Product Type Reclassification

Product types used by the reporting bank as input data are reclassified to standard product types as recommended in the Accord. The product types after reclassification are stored as Basel product types. For Example, Interest Rate Futures is reclassified as Futures

This is handled in the Basel Product Type Reclassification which is part of the BIS Other Reclassification process.

2. Party Type Reclassification

Similar to the product type, the customer type (which are stored as counterparty type) are also reclassified as standard counterparty type. The customer information is expected in the Stage Party Master (**STG_PARTY_MASTER**), and this also includes the Party Type based on the Stage Party Type Master (**STG_PARTY_TYPE_MASTER**).

Party type reclassification Rules handle reclassification for customer types. For Example, a small business entity is reclassified as Corporate SME.

This is handled in the Party Type Reclassification which is part **COMMON_RECLASSIFICATION** process.

Instrument Type Reclassification

Bank Instrument types used by the reporting bank as input data are reclassified to Instrument types. The instrument types after reclassification are stored as Instrument types. For Example, Interest Rate Future Contract is reclassified as Interest Rate Futures. This happens as part of the process **COMMON_RECLASSIFICATION** process.

Mitigant Reclassification

For mitigants the application reclassifies the mitigant type to the standard mitigant type like the debt securities.

The reclassification tasks are present in the **MITIGANT_TYPE_RECLASSIFICATION**.

7.2.1.5 Pre-mitigation Calculations - Exposure at Default Amount Calculation

Pre-mitigation Exposure at Default can be calculated as per Standardized Approach of calculations (SA CCR)

The Standardized Approach for Counterparty Credit Risk (SA-CCR) is an alternative for Standardized Method (SM) and Current Exposure Method (CEM) for Counterparty Credit Risk (CCR) in Credit Risk.

Banks can use the SA-CCR approach while they follow Standardized or IRB approaches for credit risk. The SA-CCR approach is applicable for Over the Counter (OTC) Derivatives, Exchange Traded Derivatives, and Long Settlement Transactions.

7.2.1.5.1 SA-CCR Method of EAD Computation

The exposures under the SA-CCR method consist of two components: Replacement Cost (RC) and Potential Future Exposure (PFE). The replacement cost is mostly related to the mark to market of the derivative contract, by considering the collateral and margin agreement as relevant. The potential future exposure consists of a multiplier that allows for the partial recognition of excess collateral and an aggregate add-on which is inside the sub process: **DERIVATIVES_SACCR_EAD_CALCULATION** which is part the Derivatives Multiple Assessment Risk Weight Assignment.

The following flowchart depicts the process flow of SA-CCR.

Figure 34: SACCR EAD calculation

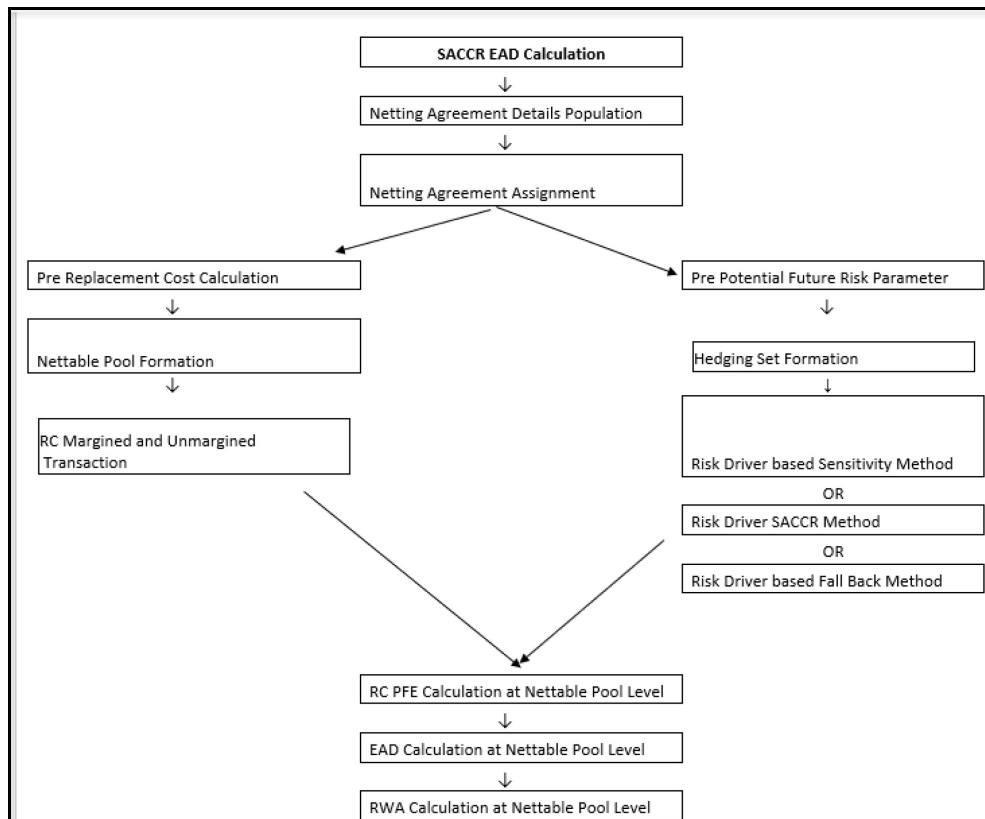

1. Netting Agreement:

For instruments participating in netting set, the netability flag should be set as 'Y'. Instruments with the same agreement code are netted in the same netting set.

The application creates new records for netting agreement and then populates into the FSI Netting Agreement Details (**FSI_NETTING_AGREEMENT_DETAILS**) table. The netting agreements will be populated in the process **NETTING_AGREEMENT_DETAILS_DATA_POP**.

In the case of the contracts not being part of any netting agreement, the application considers them as part of their own netting agreement or netting set, for the calculations of the different parameters.

2. Margin Agreement:

For both RC and PFE, if one of the netting agreements has multiple margin agreements, then this netting agreement should be divided into sub-netting agreements to align with the margin agreements. This is captured in **RC_MARGINED_UNMARGINED_TRANSACTION** process Placed Collateral & Mitigant – Eligibility Condition

3. Placed Collateral & Mitigant - Eligibility:

The placed collateral is captured in FSI Cap Placed Collateral (**FSI_CAP_PLACED_COLLATERAL**) and this also moves to FSI Cap Mitigants (**FSI_CAP_MITIGANTS**), wherein the placed collateral and the mitigants both undergo the same treatment. This is part of the process

FSI_PLACED_COLLATERAL_DATA_POPULATION and **FSI_CAP_MITIGANT_DATA_POPULATION**.

The mitigant is identified eligible are not based on the eligibility rules for CRM as mentioned in Basel III accord. Credit rating of the collateral is considered for all mitigants types issued by all party types, while deciding whether a mitigant is eligible for a particular exposure or not. Separate eligibility Rules exist for mitigants types like equity, mutual funds, or debt security, to perform these checks. For the remaining, a mitigant is marked as eligible only if its credit rating is better than the exposure to which it is providing protection and if it is classified as senior in position. This is handled in the sub process –**Mitigant Processing – STD** Approach (**FSI_CAP_MITIGANTS**). Mitigant eligibility is also checked based on the original and residual maturity of the collateral. Collateral is classified as eligible only if its original maturity is more than a year and residual maturity is more than 3 months.

4. Placed Collateral & Mitigant – Haircut Assignment:

The application assigns three kinds of mitigant haircut, which are volatility haircut, Forex haircut, and maturity mismatch haircut. Volatility haircuts are assigned to the collateral to account for any future fluctuations in the market value of the financial collateral. Separate Rules exist in the application for various types of financial collaterals like debt securities, equity, mutual funds, and so on. When the exposure and collateral are in different currencies, the application makes an adjustment by applying Forex haircut. If the residual maturity of CRM is less than the underlying credit exposure, then a maturity mismatch is applied. If there is a maturity mismatch and CRM have an original maturity of more than a year, the maturity mismatch haircut is applied to adjust the value. The application assigns a volatility haircut using Supervisory Haircut method when standardized approach is selected.

This is part of the process **FSI_PLACED_COLLATERAL_DATA_POPULATION** and **FSI_CAP_MITIGANT_DATA_POPULATION**

5. Replacement Cost:

The Replacement Cost (RC) is computed differently for margined and unmargined netting agreements.

All the required attributes for replacement cost are populated from the FSI Cap Derivative Exposures (**FSI_CAP_DERIVATIVES**) Cap Mitigants (**FSI_CAP_MITIGANTS**) and FSI Placed Collateral (**FSI_PLACED_COLLATERAL**) to the table **FSI_CAP_NETTABLE_POOL** wherein the replacement cost (N_REPLACEMENT_COST) calculation happens. Since there are different calculations required for the replacement cost, depending on whether it is a margined transaction or not, and depending on whether the netting set contains only a single margin agreement or multiple margin agreements, it happens in the table **FSI_MARGINED_EAD_CALC**. This is handled in the **RC_MARGINED_UNMARGINED_TRANSACTION** process.

In the case of contracts covered by margin agreement, the Initial margin and the Variation margin are expected at the netting agreement level. The minimum transfer amount and threshold amount are also expected at the netting agreement level and expected to be provided as an input in the Stage Net Exposures tables (**STG_NET_EXPOSURES**).

6. Methods of identifying various risk categories and risk drivers:

For each exposure, the banks must identify the primary risk driver of the risk factors such as interest rate, foreign exchange, credit, equity, or commodity. This is crucial because the Add-on formula for each risk category is different, and it depends on the nature of the risk factors. The risk categories can be identified by defining the primary risk factors of underlying exposures in the derivative contracts.

This is selected by the bank based on the Regulatory Definition Sensitivities Based Method

- SA-CCR Based Method
 - All the Add-ons are computed for the instrument, with respect to all material risk drivers as per the SA CCR calculation. Using this, the material risk categories are identified, as the one with the maximum absolute value of sensitivity multiplied by the risk weight. This gets handled in the process and the table.
- Fall Back Approach
 - All the Add-ons are computed for the instrument, with respect to all risk drivers. And all the risk categories will be considered as the material risk driver. This gets handled in the process and the table.

Essentially, it will be one instrument that can be mapped to multiple risk categories, with one material risk driver identified for each risk category. And the resultant replacement cost will be summation of the add-on across all the material risk categories.

The data for Risk Drivers and Categories will be from tables:

- FSI Cap Risk Category Master (**FSI_CAP_RISK_CATEGORY_MASTER**)
- FSI Cap Risk Driver Master (**FSI_CAP_RISK_DRIVER_MASTER**)
- FSI Cap Risk Driver Map Master (**FSI_CAP_RISK_DRIVER_MAP_MASTER**)
- Parameter Calculations for Potential Future Exposure
- The parameters to be considered for the Calculation of Potential Future Exposure, which is treated under the process **PRE_POTENTIAL_FUTURE_RISK_PARAMETERS**.

Multiplier

The multiplier in the PFE formula serves to reduce the add-on for over collateralization as in practice many banks hold excess collateral precisely to offset potential increases in exposure represented by the add-on.

Aggregate Add-on

The asset classes: interest rate, foreign exchange, credit, equity or commodity and a derivatives transaction is assigned to an asset class based on its primary risk driver. The add-ons for each asset class are simply aggregated.

Most derivative transactions have one primary risk driver, defined by its reference to underlying instrument.

Adjusted Notional

For interest rate and credit derivatives, the trade-level adjusted notional is the product of the trade notional amount, converted to the domestic currency, and the supervisory duration (SD).

Supervisory delta adjustments

These parameters are also defined at the trade level and are applied to the adjusted notional amounts to reflect the direction of the transaction. For derivatives that are not options, the value of this parameter is +1 for long (MTM increases when the value of the primary risk factor increases) or -1 for short (MTM decreases when the value of the primary risk factor increases).

Supervisory correlation parameters

These parameters only apply to the PFE add-on calculation for equity, credit and commodity derivatives. For these asset classes, the supervisory correlation parameters are derived from a single-factor model and specify the weight between systematic and idiosyncratic components.

Potential Future Exposure (PFE)

The Potential Future Exposure (PFE) is computed differently for each of the risk categories, and the final value is assigned to the netting set (stored at the FSI Cap Nettable Pool (**FSI_CAP_NETTABLE_POOL**)).

PFE add-ons are calculated for each asset class within a netting set and then aggregated. Add-ons for an asset class require the use of hedging sets, which are transactions within a single netting set within which partial or full offsetting is recognized in the methodology.

For Interest rate derivatives a hedging set consists of all derivatives Hedging sets which are further divided into maturity categories. Long and short positions in the same hedging set are permitted to fully offset each other within maturity categories; across maturity categories, partial offset is recognized.

For the calculation of PFE, it is required to adopt the unmargined methodology. This is because, one margin agreement applies to multiple netting agreements and collaterals are based on the netted MTM values of the derivative contracts.

This is handled in **FSI_POTENTIAL_FUTURE_EXP_CALC**.

Exposure at Default Calculations (EAD)

Through the CRM process, the bank considers the mitigation effect and calculates the post mitigation exposure at default amount. This signifies the maximum loss that the bank can suffer in case of default on this exposure, after considering all the mitigation effects. The application also computes pre-mitigation risk weighted assets in the process **DRV_PRE_CRM_RISK_WEIGHTED_ASSET_CALCULATION** and post mitigation risk weighted assets in the process

DRV_POST_CRM_RISK_WEIGHTED_ASSET_CALCULATION by multiplying the respective EAD by risk weight. The risk weight in this case is arrived at by analyzing the credit rating of the exposures or mitigants.

The risk weight is arrived at by multiplying pre-mitigation capital charge with 12.5. Through the Credit Risk Mitigation, the bank considers the effects of mitigation. The application checks mitigant eligibility based on the Basel specifications and assigns a haircut to each mitigant based on their currency, residual maturity, and expected volatility in their market value.

7.2.1.6 Multiple Assessment

For exposures with multiple ratings, risk weight assignment is based on multiple assessment process. For each exposure, the final rating is the worst of the best two ratings assigned to the exposure.

The risk weight corresponding to this rating is then assigned to the exposure.

Exposures for multiple rating assessment are first moved into the table FSI Multiple Rating Processing (**FSI_MULTIPLE_RATING_PROCESSING**) wherein the ranking and final selection of which rating to use takes place.

This happens in the sub process of **DRV_MULTIPLE_ASSESSMENT_PROCESSING_DATA_POP**, wherein the data for the multiple assessment processing gets populated into the FSI table. **MULTIPLE_RATING_ASSESSMENT**, wherein the identification of the multiple rating for the exposure happens, and the **DRV_MULTIPLE_ASSESSMENT_BASED_RISK_WEIGHT** wherein the actual risk weight and final rating assignment happens for the exposures.

7.2.1.7 Issue Issuer Assessment

For all the exposures which remain unrated after the multiple assessment processes, the issue issuer process is performed. This happens in the Issue Issuer Assessment sub-process (**DRV_ISSUE_ISSUER_ASSIGNMET**). In this case, the unrated exposures are assigned a reference rating based on the reference issue available or the rating of the party, whichever is applicable. These unrated exposures are assigned a risk weight based on the reference rating.

For Derivatives, the application does an issue-issuer assessment to infer a rating of the unrated exposures, based on the rating of a similar instrument (referred to as reference issue hereafter) issued by the same issuer. The reference issue is used only when it is of the same currency as the exposure and the exposure is senior or equivalent to the same. For the unavailable reference issue, the party rating is used. In the case of the party also being unrated, the exposure remains unrated. Also, the application populates whether the exposure is LT rated or ST rated, based on the rating assigned to the exposure.

7.2.1.8 Risk Weight Assignment Rules

1. Risk Weight Assignment to all Exposures

Risk Weight is assigned based on asset class and the credit rating as per Basel guidelines. The risk weight rules operate on the risk weight table (**FSI_RW_MAP_MASTER**). Highly rated exposures are allocated low-risk weight and poorly rated exposures are allocated high-risk weights. If exposure has more than one rating (rated by more than one agency), then the final rating is assigned based on multiple assessments. The application updates the risk weights against the exposures directly, when ratings are not considered.

Options for risk-weighting are selected during Run definition if the Run Management UI is used, to update the required calculations as allowed by the specific jurisdiction. For more details on the options, please refer the [Run Management](#) section.

Figure 35: Risk weight process flow

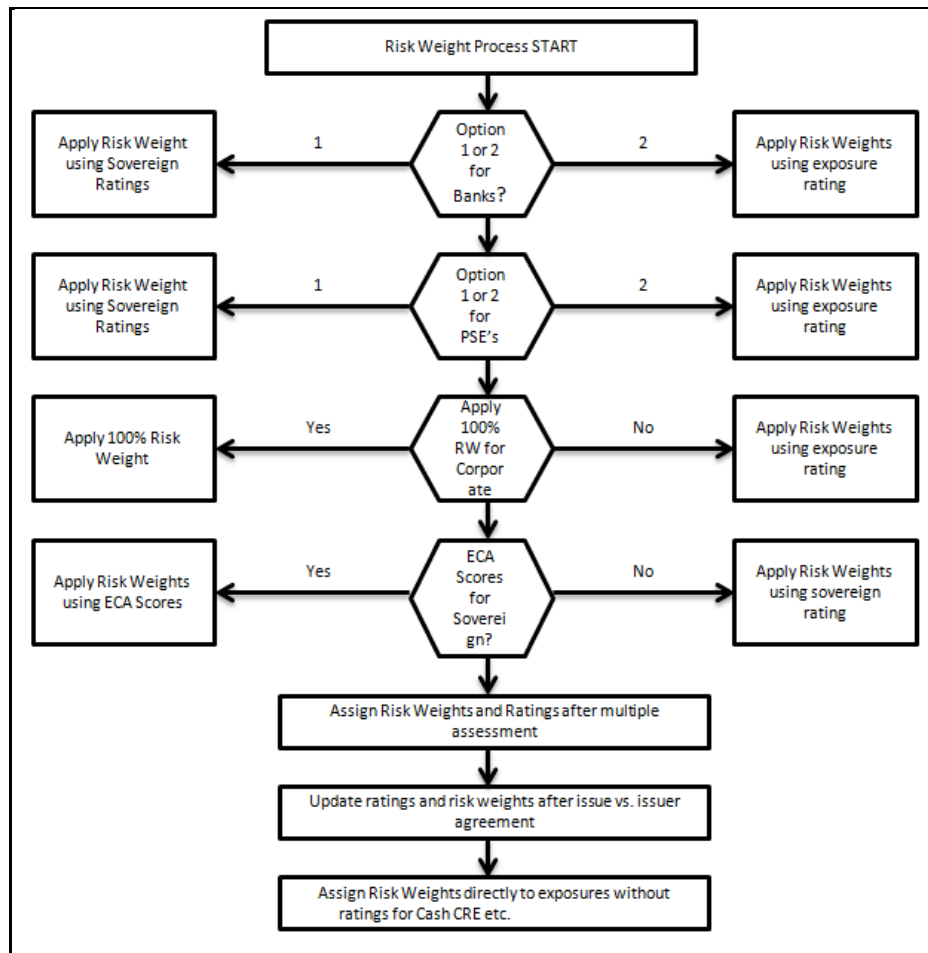

Risk weight assignment takes place in the sub-process: **DRV_RISK_WEIGHT_ASSIGNMENT_STD**.

2. Risk Weight Assignment to Sold Credit Protection Exposures

The sold credit protection data is specific to sold credit derivatives. This data is available in the product processor table **STG_CREDIT_DERIVATIVES**. The sold credit protection data is processed under **SOLD_PROTECTION_CREDIT_DATA_PROCESSING**. The underlying data are required for all the sold credit protection.

The risk weight assignment for the sold credit protection is based on the asset type of the underlying exposure captured in Non-Sec Pre-Mitigation RW Assignment for Rated SCP - STD

- The risk weight for the underlying exposure is calculated and this is updated to the sold credit protection exposure under the sub process Derivative Pre-Mitigation RW UL for SCP based on Revised Sec Framework
- The RWA is calculated as the Pre-mitigation EAD multiplied by the Pre-Mitigation Risk Weight
- In the case of sold credit protection exposures, the Pre-Mitigation EAD and the Post Mitigation EAD are the same since there are no mitigants for these exposures.

The underlying data for sold credit protection data is provided in the **STG_UNDERLYING_EXPOSURES** table which is stored in **DIM_UNDERLYING**. The underlying for

the sold credit protection has **V_UNDERLYING_DATA_IDENTIFIER** as “SCP”, to recognize this for the Sold credit protection treatment captured in sub process Derivatives Data processing.

3. Risk Weight Assignment to Cleared Transaction Exposures

Where a bank acts as a clearing member of a CCP for its own purposes, a risk weight of 2% must be applied to the bank’s trade exposure to the CCP in respect of OTC derivatives, exchange traded derivative transactions and SFTs.

Where the clearing member offers clearing services to clients, the 2% risk weight also applies to the clearing member’s trade exposure to the CCP that arises when the clearing member is obligated to reimburse the client for any losses suffered due to changes in the value of its transactions in the event that the CCP defaults.

This is captured in process **DRV_RISK_WEIGHT_ASSIGNMENT** (PMFDRV019) in sub process Derivative Basel III - RW Assignment for Cleared Transactions - Exposures - Revised Approach.

4. Risk Weight Assignment to Specific Wrong Way Risk Exposures

Specific Wrong Way Risk: Wrong-way risk is defined as the risk that occurs when exposure to counterparty is adversely correlated with the credit quality of that counterparty. It arises when default risk and credit exposure increase together.

For all the transactions which are identified as Specific wrong way risk, Risk weight is assigned in process **DRV_RISK_WEIGHT_ASSIGNMENT**.

7.2.1.9 RWA Calculations

The RWA is calculated as the Pre-mitigation EAD multiplied by the Pre-Mitigation Risk Weight.

In the case of sold credit protection exposures, the Pre-Mitigation EAD and the Post-mitigation EAD is the same since there are no mitigants for these exposures.

7.2.1.10 Post CRM RWA Calculations

In the case of derivatives, there are no additional mitigants, and hence both pre-CRM RWA calculations and post CRM RWA calculations are one and the same which is stored in **FSI_CAP_DERIVATIVES.N_EAD_POST_MITIGATION**.

7.2.1.11 Allocation of RWA at Exposures

CCR RWA calculated at the netting set level is allocated to the exposures of the nettable pool using the following formula:

$$\text{RWA at Exposure Level} = \text{Total CCR RWA at netting set level} * \text{Pre-Mitigation EAD for Exposure} / \text{Sum of Pre-Mitigation EAD for all Exposures part of CCR RWA at netting set level}$$

7.2.2 Securities Financing Transactions Portfolio

Securities Financing Transactions (SFT) include Repo Style transactions, Margin Lending, Security Financing Borrowing, and so on.

Under Standardized method we have two approaches –

- Simple Approach – this is the approach wherein the collateral is being substituted for the covered portion of the exposure, and the risk weights as applicable for the standard mitigant type and issuer type are assigned to the collateral.
- Comprehensive Approach – this is the approach wherein the collateral undergoes haircut treatment, and the exposure value gets reduced from this portion

For all SFT contracts which have a placed collateral or mitigant mapped to it, the application computes CRM based on the EAD approach undertaken by the bank.

Figure 36: Process Flow for Credit Risk Securities Financing Transactions

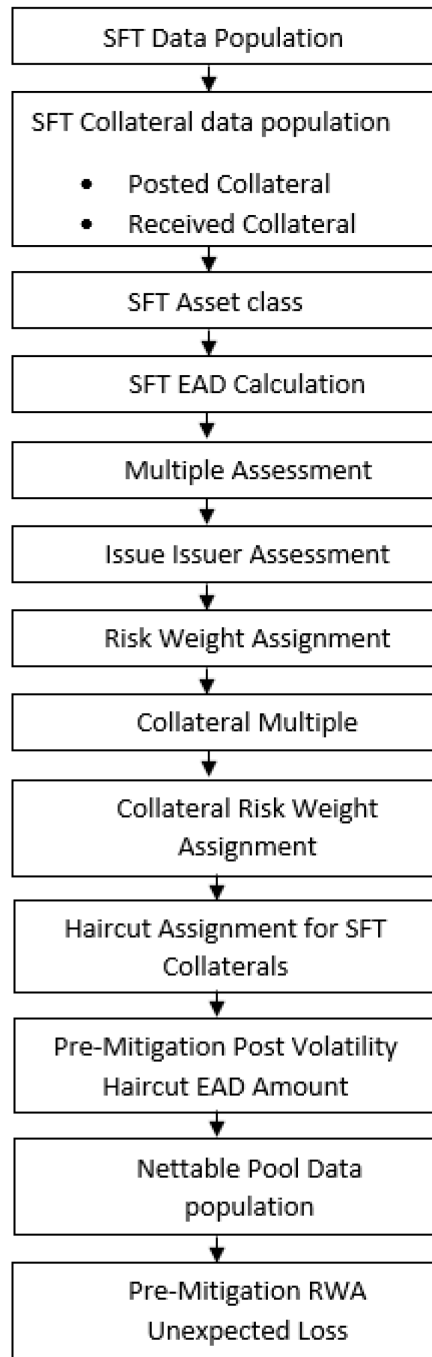

7.2.2.1 Rating Population

The data on ratings is captured in the following rating specific tables:

- Party Rating Table (**STG_PARTY_RATING_DETAILS**)
 - Credit Rating for all customers and issuers are captured in this table.

- Instrument Rating Table (STG_INSTRUMENT_RATING_DETAILS)
 - Credit Rating for all instruments which are in the form of collateral either placed or received, are captured in this table
- Sovereign Rating Table (STG_SOVEREIGN_RATING_DETAILS)
 - Credit Rating for all countries is captured in this table.

7.2.2.1.1 Processing Steps

Banks obtain credit ratings from different sources, and these are provided as an input in the application through the rating tables mentioned in the preceding list.

This is handled in the process Credit Rating Data Population.

The application re-classifies the rating information to BIS Specific standard ratings. The out-of-box application supports the Fitch / Moodys / S&P and DBRS credit rating reclassification for Long Term and Short-Term ratings.

This is handled in the process Credit Rating Reclassification.

The rating reclassification lookup table (FSI_RATING_CLASSIFICATION) is used to lookup reclassified standard ratings so that the reclassification rule is not repeated for each of the rating processing tables.

Ratings are populated from the stage tables (for example, STG_PARTY_RATING_DETAILS) to FSI tables (for example, FSI_PARTY_RATING_DETAILS) using the lookup table (FSI_RATING_CLASSIFICATION) to obtain a reclassified rating.

Ensure that all the relevant columns as indicated in the DL Specs are mandatorily populated with data. For example, in the Stage Party Rating Details (STG_PARTY_RATING_DETAILS) table: Rating source code (V_RATING_SRC_CODE), Party Code (V_PARTY_CD), Purpose (V_PURPOSE) are required to be populated. The purpose code is to indicate whether the rating is a domestic rating or foreign rating. If any other rating is provided, then the exposure is considered as unrated.

7.2.2.2 Data Population

Credit Risk exposures are updated in the application for all the product types through their respective input tables known as Product Processors. Main categories of Counterparty Credit Risk exposures, along with their respective table names that are used as an input, are as follows:

Table 19: Counterparty credit risk exposures

Product	Source Product Processor
Margin Lending Transactions	STG_LOAN_CONTRACTS
Re purchase contracts / Reverse Repurchase contracts / Security Lending & Borrowing	STG_REPO_CONTRACTS

There is a data population about the placed collateral that have been placed with respect to the SFT transaction.

Table 20: Mapping placed collateral to source product processor

Product	Source Product Processor
Placed Collateral	STG_PLACED_COLLATERAL

There is a data population about the mitigants, which cater to the mitigants that have been received with respect to the SFT transaction.

Table 21: Mapping Mitigant to source product processor

Product	Source Product Processor
Mitigants – Collateral Received	STG_MITIGANTS

There is a data population about the mapping between the exposures and the mitigants. And one data population about the mapping between the exposures and the placed collateral.

Table 22: Mapping exposures to source tables

Product	Source Table
Mapping for Exposures and Mitigants	STG_ACCOUNT_MITIGANT_MAP
Mapping for Exposures and Placed Collateral	STG_ACCT_PLACED_COLL_MAP

Processing table details

All Counterparty Credit Risk SFT exposures are loaded into the table, FSI Cap SFT Exposures (**FSI_CAP_SFT_EXPOSURES**) where further processing happens for this portfolio of exposures.

This is handled in the process **SFT_DATA_POPULATION**.

7.2.2.3 Shareholding Percent Multiplication

Shareholding percent multiplication for common entity level data is a part of BIS Common Data Processing (PMFCOM020) process. In this the application updates the shareholding percentage against each entity. The parent entity is updated with the value of 1 as the shareholding percent and for each child entity, the percentage is based on the parent's holding percentage as specified for each child in fact entity shareholding percent table (**FCT_ENTITY_SHR_HLD_PCT**).

Shareholding percent multiplication for exposure level is part of each portfolio as well. In this process, the application multiplies the entity shareholding percentage for that entity with respect to parent entity against exposure amount, undrawn amount and provision amount for that exposure and update the same.

This process is handled in the sub process **SFT_SHAREHOLDING_CALCULATION_STD** of the process **SFT_DATA_PROCESSING_STD**.

7.2.2.4 Common Reclassification Rules

The application reclassifies the bank's product types and party types to standard product and party types. Based on the standard product and party type, the asset class for each exposure is arrived at. Similarly, the

application does reclassification for mitigant based on its mitigant types and reclassifies it to standard mitigant types.

Ensure that all products and party type and mitigants which are bank-specific are reclassified, as part of the setup activity. If they are not reclassified, the treatment might not happen as expected by the regulator.

1. Product Type Reclassification

Product types used by the reporting bank as input data are reclassified to standard product types as recommended in the Accord. The product types after reclassification are stored as Basel product types. For Example, any security lending product is reclassified as Security lending and borrowing product type.

This is handled in the Basel Product Type Reclassification which is part of the **COMMON_RECLASSIFICATION** process.

2. Party Type Reclassification

Similar to the product type, the customer type (which are stored as counterparty type) are also reclassified as standard counterparty type. The customer information is expected in the Stage Party Master (STG_PARTY_MASTER), and this also includes the Party Type based on the Stage Party Type Master (STG_PARTY_TYPE_MASTER).

Party type reclassification Rules handle reclassification for customer types. For Example, any Country is reclassified as Sovereign.

This is handled in the Party Type Reclassification which is part of BIS Other Reclassification process.

3. Mitigant Reclassification

For mitigants the application reclassifies the mitigant type to the standard mitigant type like the debt securities, cash, and so on.

The reclassification tasks are present in the **MITIGANT_TYPE_RECLASSIFICATION**.

4. Other Reclassification

As part of the reclassification rules, any other data which is being brought inside the application like seniority, transaction type and so on also get reclassified into OFSAA specific values. This is also mandatory to be done, as otherwise data will not be available for processing as required by the regulator.

This happens as part of the process **COMMON_RECLASSIFICATION**.

7.2.2.5 Asset Reclassification Rules

Based on Basel product type and standard counterparty type, an asset class is formed by the application. This asset class is used for data processing. The asset class is the same as specified in the accord.

For example, Standard counterparty is Corporate non-SME and Corporate SME, the asset class is corporate.

The asset class for all mitigants is reclassified based on their standard mitigant types and standard issuer type.

This happens in the sub process **SFT_RECLASSIFICATION_STD** and in the process **SFT_DATA_PROCESSING_STD**.

7.2.2.6 Pre-mitigation Calculations

Based on the asset class, the application calculates the Pre-Credit Risk Mitigation (CRM) Exposure at Default (EAD) for each exposure. This value signifies the maximum loss that the bank can suffer, in case of default on this exposure, before considering any mitigation effects.

In the case of SFT Exposures, the exposures are hedged against credit risk through various collateral. These collaterals provide mitigation to credit risk and must be considered while computing Credit RWA, as per the Accord. Hence, the application calculates the pre-mitigation exposure amount and post-mitigation exposure amount.

The application also computes pre-mitigation risk-weighted assets (Pre CRM RWA) and post-mitigation risk-weighted assets (Post CRM RWA) by multiplying the respective EAD by risk weight. The risk weight is arrived at, by considering the credit rating of the exposures and mitigants as per the guidelines.

7.2.2.6.1 Exposure at Default Amount Calculation

Pre-mitigation Exposure at Default can be calculated using one of the two approaches of EAD – Simple Approach and Comprehensive Approach. This is based on regulatory definition selection.

1. Calculation of EAD – Comprehensive Approach

As per the Comprehensive Approach, the EAD is computed by considering the Exposure amount post haircut, and the collateral amount post haircut.

a. Exposure Amount Calculations for the Exposures

The exposure amount from the product processor tables **STG_REPO_CONTRACTS** and **STG_LOAN_CONTRACTS** for the respective products are based on their EOP balance i.e. nothing but the End of period balance, which will be populated into the processing table (**FSI_CAP_SFT_EXPOSURES**) for further calculations.

This is part of the process **SFT DATA POPULATION**.

b. Placed Collateral & Mitigant – Eligibility

The mitigant identified as eligible are not based on the eligibility rules for CRM as mentioned in Basel III accord. Credit rating of the collateral is considered for all mitigants types issued by all party types, while deciding whether a mitigant is eligible for a particular exposure or not. Separate eligibility Rules exist for mitigants types like equity, mutual funds, or debt security, to perform these checks. For the remaining, a mitigant is marked as eligible only if its credit rating is better than the exposure to which it is providing protection and also if it is classified as senior in position.

The received collateral is captured in FSI Cap Mitigants (**FSI_CAP_MITIGANTS**). Mitigant eligibility is also checked based on the original and residual maturity of the collateral. Collateral is classified as eligible only if its original maturity is more than a year and residual maturity is more than 3 months.

The placed collateral is captured in FSI Cap Placed Collateral (**FSI_CAP_PLACED_COLLATERAL**) and this also moves to FSI Cap Mitigants (**FSI_CAP_MITIGANTS**), wherein the placed collateral and the mitigants both undergo the same treatment.

This is part of the sub process Mitigant Processing – STD Approach – BIS in the process **SFT_PLACED_COLLATERAL_DATA_PROCESSING_STD**.

c. Placed Collateral & Mitigant – Haircut Assignment

The application assigns three kinds of mitigant haircut, which are volatility haircut, Forex haircut, and maturity mismatch haircut.

Volatility haircuts are assigned to the collateral to account for any future fluctuations in the market value of the financial collateral. Separate Rules exist in the application for various types of financial collaterals like debt securities, equity, mutual funds, and so on. The application assigns a volatility haircut using Supervisory Haircut method when standardized approach is selected.

When the exposure and collateral are in different currencies, the application makes an adjustment by applying Forex haircut.

If the residual maturity of CRM is less than the underlying credit exposure, then a maturity mismatch is applied. If there is a maturity mismatch and CRM have an original maturity of more than a year, the maturity mismatch haircut is applied to adjust the value.

This is part of the sub process **SFT_COMPREHENSIVE_APPROACH_HAIRCUT** in the process **SFT_PLACED_COLLATERAL_DATA_PROCESSING_STDEAD** Calculation for Exposures that are not part of netting agreement.

For SFT transaction, the application calculates EAD for the parent exposure, based on the underlying information. The underlying exposures (which are the mitigants received and the collateral placed) are moved to **FSI_SFT_UNDERLYING** table from **FSI_CAP_MITIGANTS**. Forex haircut is applied if the underlying and the parent contract are in a different currency. Each SFT underlying exposure adjusted for a haircut (EAD + haircut value) is added as EAD to the parent contract.

This is part of the process **SFT_EXP_AND_PLACED_COLLATERAL_PROCESSING_STD**.

d. EAD Calculation for Exposures that are part of netting agreement

The application nets SFT contracts based on the same customer, common netting agreement identifier, the transaction of Repo, Re-Repo or Margin Lending, Trading or Banking book, and so on. Margin lending transaction being SFT also follows the same EAD calculation methodology, however Repo or Reverse Repo and margin lending are not netted together.

The calculation happens in the table FSI Cap Nettable pool (**FSI_CAP_NETTABLE_POOL**). This is handled in the process **SFT_NETTING_CALCULATION**.

2. Calculation of EAD – Simple Approach

As per the Simple Approach, the EAD is computed by considering the Exposure amount and the mitigants assigned being sent under Credit Risk Mitigation process and assigning based on the Risk Weight of the Mitigants and the Exposures.

a. Exposure Amount Calculations for the Exposures

The exposure amount from the product processor tables **STG_REPO_CONTRACTS** and **STG_LOAN_CONTRACTS** for the respective products are based on their EOP balance i.e nothing but the End of period balance which will be populated in to the processing table (**FSI_CAP_SFT_EXPOSURES**) for further calculations. This is part of the process **SFT DATA POPULATION**.

b. Placed Collateral & Mitigant – Eligibility

The mitigant identified as eligible are not based on the eligibility rules for CRM as mentioned in Basel III accord. Credit rating of the collateral is considered for all mitigants types issued by all party types, while deciding whether a mitigant is eligible for a particular exposure or not. Separate eligibility Rules exist for mitigants types like equity, mutual funds, or debt security, to perform these checks. For the remaining, a mitigant is marked as eligible only if its credit rating is better than the exposure to which it is providing protection and also if it is classified as senior in position.

The received collateral is captured in FSI Cap Mitigants (**FSI_CAP_MITIGANTS**). Mitigant eligibility is also checked based on the original and residual maturity of the collateral. Collateral is classified as eligible only if its original maturity is more than a year and residual maturity is more than 3 months.

The placed collateral is captured in FSI Cap Placed Collateral (**FSI_CAP_PLACED_COLLATERAL**) and this also moves to FSI Cap Mitigants (**FSI_CAP_MITIGANTS**), wherein the placed collateral and the mitigants both undergo the same treatment. This is part of the sub process Mitigant Processing – STD Approach – BIS in the process **SFT_PLACED_COLLATERAL_DATA_PROCESSING_STD**.

c. Placed Collateral & Mitigant – Risk Weight Assignment

For Simple approach, the application assigns risk weight to mitigants on the basis of credit rating (CAP Mitigant Basel Rating and Risk Weight Assignment), and original maturity (CAP Mitigant RW Assignment based on Original Maturity). These fall under the process Mitigant RW Assignment – Simple –BIS.

This is part of the sub process Mitigant Processing – STD Approach – BIS in the process **SFT_PLACED_COLLATERAL_DATA_PROCESSING_STD**

d. EAD Calculation for Exposures that are not part of netting agreement

For SFT transaction, the application calculates EAD for the parent exposure, based on the underlying information.

The underlying exposures (which are the mitigants received and the collateral placed) are moved to **FSI_SFT_UNDERLYING** table from **FSI_CAP_MITIGANTS**.

This is part of the process **SFT_EXP_AND_PLACED_COLLATERAL_PROCESSING_STD** The SFT exposures EAD by considering the collateral placed and received are handled as part of the credit risk mitigation process. This is in the PMF process CRM Data Processing.

e. EAD Calculation for Exposures that are part of netting agreement

The application nets SFT contracts based on the same customer, common netting agreement identifier, the transaction of Repo, Re-Repo or Margin Lending, Trading or Banking book, and so on. Margin lending transaction being SFT also follows the same EAD calculation methodology, however Repo or Reverse Repo and margin lending are not netted together.

The netted exposure of the SFT gets computed without the effects of the collateral received and placed in the FSI Cap Nettable Pool (**FSI_CAP_NETTABLE_POOL**). This gets handled in the process **SFT_NETTING_CALCULATION**.

The SFT exposures EAD by considering the collateral placed and received are handled as part of the credit risk mitigation process. This is in the PMF process CRM Data Processing.

7.2.2.6.2 Risk Weight Assignment

1. Multiple Assessment

For exposures with multiple ratings, risk weight assignment is based on multiple assessment process. For each exposure, the final rating is the worst of the best two ratings assigned to the exposure.

The risk weight corresponding to this rating is then assigned to the exposure.

Exposures for multiple rating assessment are first moved into the table FSI Multiple Rating Processing (FSI_MULTIPLE_RATING_PROCESSING) wherein the ranking and final selection of which rating to use takes place.

Below are the related sub-processes:

SFT_MULTIPLE_RATING_ASSESSMENT_POPULATION_STD, wherein the data for the multiple assessment processing gets populated into the FSI table.

MULTIPLE_RATING_ASSESSMENT, wherein the identification of the multiple rating for the exposure happens, and the

SFT_MULTIPLE_ASSESSMENT_BASEL_RISK_WEIGHT_ASSIGNMENT, wherein the actual risk weight and final rating assignment happens for the exposures.

2. Issue Issuer Assessment

For all the exposures which remain unrated after the multiple assessment processes, the issue issuer process is performed. This happens in the Issue Issuer Assessment sub-process (SFT_ISSUE_ISSUER_ASSESSMENT)

In this case, the unrated exposures are assigned a reference rating based on the reference issue available or the rating of the party, whichever is applicable. These unrated exposures are assigned a risk weight based on the reference rating.

For unrated exposures, the application does an issue-issuer assessment to infer a rating of the unrated exposures, based on the rating of a similar instrument (referred to as reference issue hereafter) issued by the same issuer. The reference issue is used only when it is of the same currency as the exposure and the exposure is senior or equivalent to the same. For the unavailable reference issue, the party rating is used. In the case of the party also being unrated, the exposure remains unrated. Also, the application populates whether the exposure is LT rated or ST rated, based on the rating assigned to the exposure.

3. Risk Weight Assignment

Risk Weight is assigned based on asset class and the credit rating as per Basel guidelines. The risk weight rules operate on the risk weight table (FSI_RW_MAP_MASTER). Highly rated exposures are allocated low-risk weight and poorly rated exposures are allocated high-risk weights. If exposure has more than one rating (rated by more than one agency), then the final rating is assigned based on multiple assessments. The application updates the risk weights against the exposures directly, when ratings are not considered.

Options for risk-weighting are selected during Run definition if the Run Management UI is used, to update the required calculations as allowed by the specific jurisdiction. For more information on the options, see the [Regulatory Definition](#) section.

Risk Weight Assignment happens in the process “SFT_RISK_WEIGHT_ASSIGNMENT STD” for the SFT Exposures.

Figure 37: Risk weight process assignment

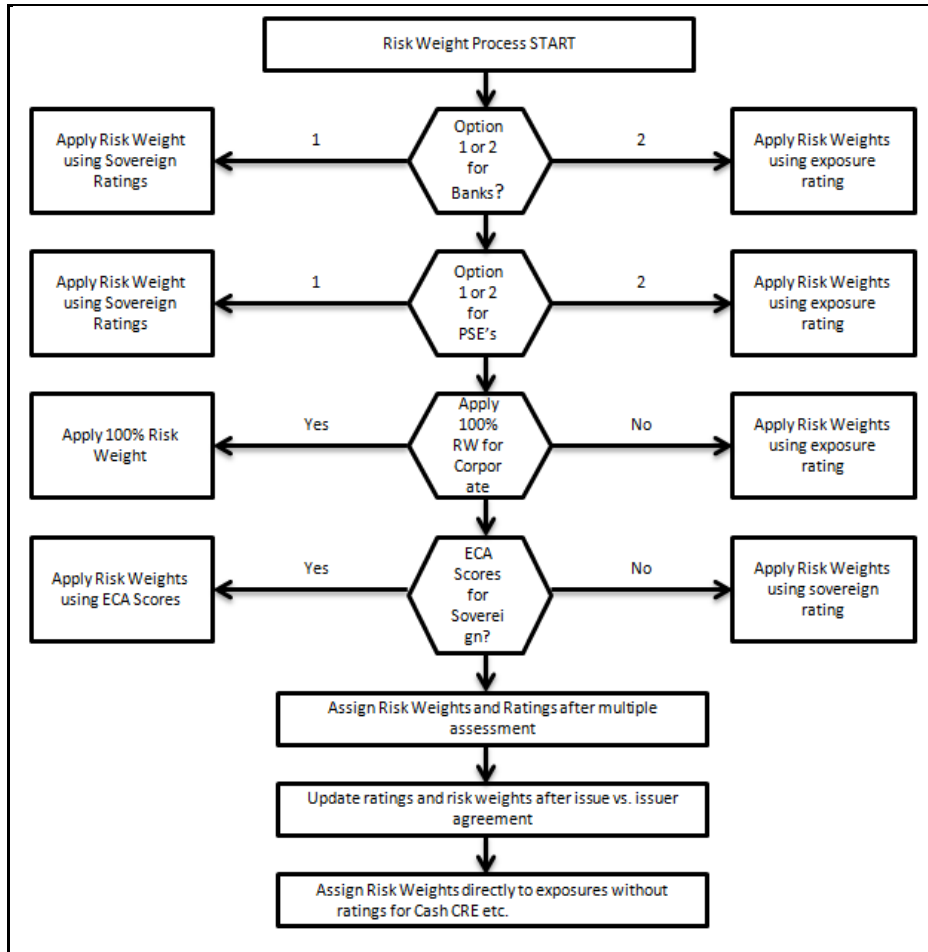

7.2.2.6.3 RWA Calculations

The RWA is calculated as the Pre-mitigation EAD multiplied by the Pre-Mitigation Risk Weight.

7.2.2.7 Credit Risk Mitigation Process

In order to calculate the post CRM RWA, application needs to account for mitigants which may be in the form of collaterals (for simple approach) or guarantees that are being provided by the bank. All the mitigants which get populated into the system are being made ineligible, and then the regulatory approved mitigant types and the issuer type combination are made eligible.

7.2.3 Pooling and Optimizer

7.2.3.1 Pooling

Pooling is one of the pre-requisites for the optimized allocation of the exposures.

Pooling pulls out an exposure, and identifies all the relevant mitigants mapped to it, and the corresponding exposures mapped to these mitigants, and again the corresponding newer mitigants mapped to these exposures. This pooling assigns the cardinality to the exposures based on the mitigant combination.

This happens in the FSI Cap Sub Exposures (FSI_CAP_SUB_EXPOSURES), and the pooling is part of the sub process

The relevant cardinalities that get assigned to the exposures, as part of this pooling process are as follows:

- 1-0 → One exposure not mapped to any mitigant
- 1-1 → One exposure mapped to one mitigant
- 1-N → One exposure mapped to multiple mitigants
- N-1 → Multiple exposures mapped to a single mitigant
- N-N → Multiple exposures mapped to Multiple mitigants

7.2.3.1.1 Optimizer

The optimizer is the process of allocation of the mitigants to the exposures, based on the different logic applicable for the various granularity. The details of this is available in the Annexure.

Both Pooling and Optimizer is handled under the process **CRM Sub Exposure Pooling and Optimizer Processing**.

7.2.3.2 Post CRM RWA

The application computes the covered amount and the uncovered amount for the exposures. The covered amount is computed by multiplying the covered factor with the exposure amount. To this covered amount, the application assigns the mitigant risk weight. The product of the covered amount and the mitigant risk weight is the covered RWA. The uncovered amount is computed by multiplying the uncovered factor (which is 1 – the sum of all covered factors for that exposure) with the exposure amount. This uncovered amount is multiplied by the exposure risk weight to get the uncovered RWA. The sum of the covered RWA and the uncovered RWA is the Post CRM RWA of the Exposure.

$$\text{Post-CRM RWA} = \text{Covered Amount} * \text{Risk Weight of the Mitigant} \\ + \text{Uncovered Amount} * \text{Risk Weight of the Exposure}$$

This is handled in the process Post CRM Expected and Unexpected Loss RWA Assignment

7.3 Default Fund Contributions Related Capital Charge

A default fund contribution refers to the funds contributed, or commitments made by a clearing member to a Central Counterparty's (CCP) equalized loss-sharing agreement. The purpose of such default funds is

to provide capital, in addition to the collateral posted by participants and in addition to capital provided by the clearinghouse, as a safeguard against extraordinary losses that might occur in connection with.

For example, a financial crisis in the market or the simultaneous defaults of several large members. The clearing members contribute to such default funds kept with the central counterparty (clearing house) in the proportion of their exposure to the central counterparty.

The default fund contributions by the clearing members contribute toward the central counterparty's regulatory capital along with CCP's contributions to the default fund. These contributions act as collaterals to mutually share in the losses incurred by the clearing members due to counterparty defaults.

For each clearing member, a contribution is made to the central counterparty's default fund.

This contribution acts as a relief against the defaults by any clearing member of the central counterparty.

The application handles the treatment of exposures to a QCCP and a Non-QCCP. This qualified CCP flag is expected to be provided as a download in the Party Master (**STG_PARTY_MASTER**) table.

7.3.1 Capital Charge for Non-QCCP

If the CCP is not qualified (non-QCCP), then the risk-weighted asset amount for the banking organization's default fund contribution is calculated using the Own fund's requirements for pre-funded contributions to the default fund of a non-qualifying CCP approach, as suggested in the accord.

7.3.2 Capital Charge for QCCP

If the CCP is a qualified CCP (QCCP), then the RWA amount is computed using one of the following two approaches stated below. Both are handled in the same Sub-process - RWA For Default Fund Contribution With QCCP. This is based on the run management option selected.

- Own funds requirements for pre-funded contributions to the default fund of a QCCP.
- An alternative calculation of own funds requirement for exposures to a QCCP.

The approach to the use of either the own fund requirements for QCCP or the alternative approach of the own fund requirements for QCCP is based on the run management option.

Approach 1

To compute the clearing member's capital requirement, which is the reporting bank's capital requirement for the contributions made to the CCP's default fund, the hypothetical capital requirement of the central counterparty for the default fund must be known. This must be computed by the central counterparty based on the exposures of all the clearing members to the default fund. After this figure is calculated by the CCP, it is shared with all the clearing members to enable them and to compute their respective capital requirements against the default fund.

When the reporting bank gets the hypothetical capital requirement from the QCCP, the next step is to compute the capital requirement of the reporting bank by finding out the proportion of the reporting bank's contribution in the total default fund contribution.

- The parameters considered for this purpose include the following QCCPs:
- Net potential exposure to the two largest clearing members,
- The total net potential exposure to all the clearing members,

- Total default fund contribution by all the clearing members,
- QCCP's contribution to the default fund, and
- The total number of clearing members for the default fund.

The last step is to compute the risk-weighted assets of the reporting bank corresponding to the default fund contribution to the QCCP by using the capital computed in the previous step.

These steps and the calculation involved are the following:

Step 1:

It requires the QCCP to calculate its hypothetical capital requirement (KCCP) for the default fund. This is done by the QCCP and is published to the clearing members for them to use for their respective capital calculations.

Step 2:

Compare KCCP with the funded portion of the default fund of a QCCP and calculate the capital requirement of the bank (KCM) by using the total of all the clearing members' capital requirements (K*CM). This capital requirement is considered on the contribution that the clearing members make to the default fund of the QCCP.

Approach 2

Capital Charge for the default fund contribution is calculated as follows:

Capital charge (Ki) = 8% * minimum (2% of Trade exposures to the QCCP + 1250% * default fund contribution to the QCCP, 20% * Trade Exposure Amount to the QCCP).

The application also supports the treatment of a CCP stopping to calculate its fund requirement to the CCP. The flag to indicate that the CCP has stopped calculating the own fund requirement is captured in the party table (**STG_PARTY_MASTER**). And based on the supervisory approval provided, in the run management option, the capital will be calculated using the Alternative approach. Else, it is treated as a normal Credit Risk Exposure, part of the Corporate Asset class.

The flag to indicate that the CCP has stopped calculating the capital requirement is expected as part of the Party Master Table (**STG_PARTY_MASTER**). In the case of this flag being null, it is expected that the CCP is calculating the Total Capital and normal processing of QCCP or Non-QCCP happens.

Key Data Elements

Key data elements to be noted are listed in this section. To view the complete list of tables used, see the Download Specification document in [MOS](#).

- Default fund contributions and related data are expected at the Default fund – Central Counterparty level in the entity Stage Central Counterparty Details (STG_CCP_DETAILS).
- Hypothetical Capital Requirement of CCP, Maximum Net Potential Exposure of clearing member of CCP, 2nd Maximum Net Potential Exposure of clearing member of CCP, Total Net Potential Exposure of clearing member of CCP, Number of Clearing Members to the CCP, Total funded Default Fund Contribution of all clearing members to the CCP, Total unfunded Default Fund Contribution of all clearing members to the CCP and Default fund contribution of CCP from its funds for each central counterparty level required.
- The application supports only the capital requirement of the bank (KCM) based on Funded/Unfunded default contributions from all clearing members not by Initial Margin. But the

data model supports place holders to capture Total Initial Margin by all clearing members to CCP and Bank's initial margin posted to CCP.

7.4 Underlying Exposures Treatment

UNDERLYING FLOW

Underlying Flow Related to Securitization

The application also supports Underlying exposures that are received as input through Stage Underlying Exposures table (STG_UNDERLYING_EXPOSURES). This is relevant for the securitization exposures,

Banking Underlying Exposures

For these exposures, the parent exposures are securitization exposures, mapped via the securitization pool, but the underlying are Banking exposures.

In such cases, exposures will have a record type as INV_NON_SEC_ULY (Investment Underlying) and will be populated and processed in the Banking table FSI_CAP_BANKING_EXPOSURES. This is handled in the process Bank Underlying Data Processing –STD.

Investment Underlying Exposures

For these exposures, the parent exposures as well as the underlying exposures are both investment exposures. Such exposures will have record type as INV_NON_SEC_ULY (Investment Underlying) and will be populated and processed in the Investments table, FSI_CAP_INVESTMENT_EXPOSURES.

This is handled in the similar way as a normal investment exposure in the process Investment Data Processing – STD.

Underlying Flow Related to CIU

The application also supports Underlying exposures that are received as input through Stage Fund Underlying Composition table (STG_FUND_UNDERLYING_COMPOSITION). This is relevant for the CIU exposures, the application also supports the underlying composition received as input through the Stage Fund CIS Composition table (STG_FUND_CIS_COMPOSITION)

Investment Underlying Exposures

For these exposures, the parent exposures as well as the underlying exposures are both investment exposures. Such exposures will have record type as INV_NON_SEC_ULY (Investment Underlying) and will be populated and processed in the Investments table, FSI_CAP_INVESTMENT_EXPOSURES.

Derivatives Underlying Exposures

For these exposures, the parent exposures are investment exposures, but the underlying are Derivatives exposures. Such exposures will have record type as INV_NON_SEC_ULY (Investment Underlying) and will be populated and processed in the Derivatives table FSI_CAP_DERIVATIVES.

This is handled in the process Derivatives Underlying Data Processing –STD.

7.5 Credit RWA for Securitization

As per the revised guidelines for securitization framework, which is focused on addressing the shortcomings of the existing guidelines, a revised hierarchy of approaches that replaces the existing approaches have been introduced.

The application assigns the appropriate approach to the exposures, based on the criteria specified in the Revised guidelines. The application assigns any of the below approaches under securitization standardized approach:

- Sec-External Ratings Based Approach (SEC-ERBA)
- Sec – IAA Approach
- Sec-Standardized Approach (SEC-STD)- SSFA
- Sec 1250% RW

7.5.1 Securitization – Revised Framework

The procedure by which the application handles the advanced approach of securitization exposures is as follows:

Figure 38: Securitization portfolio process flow

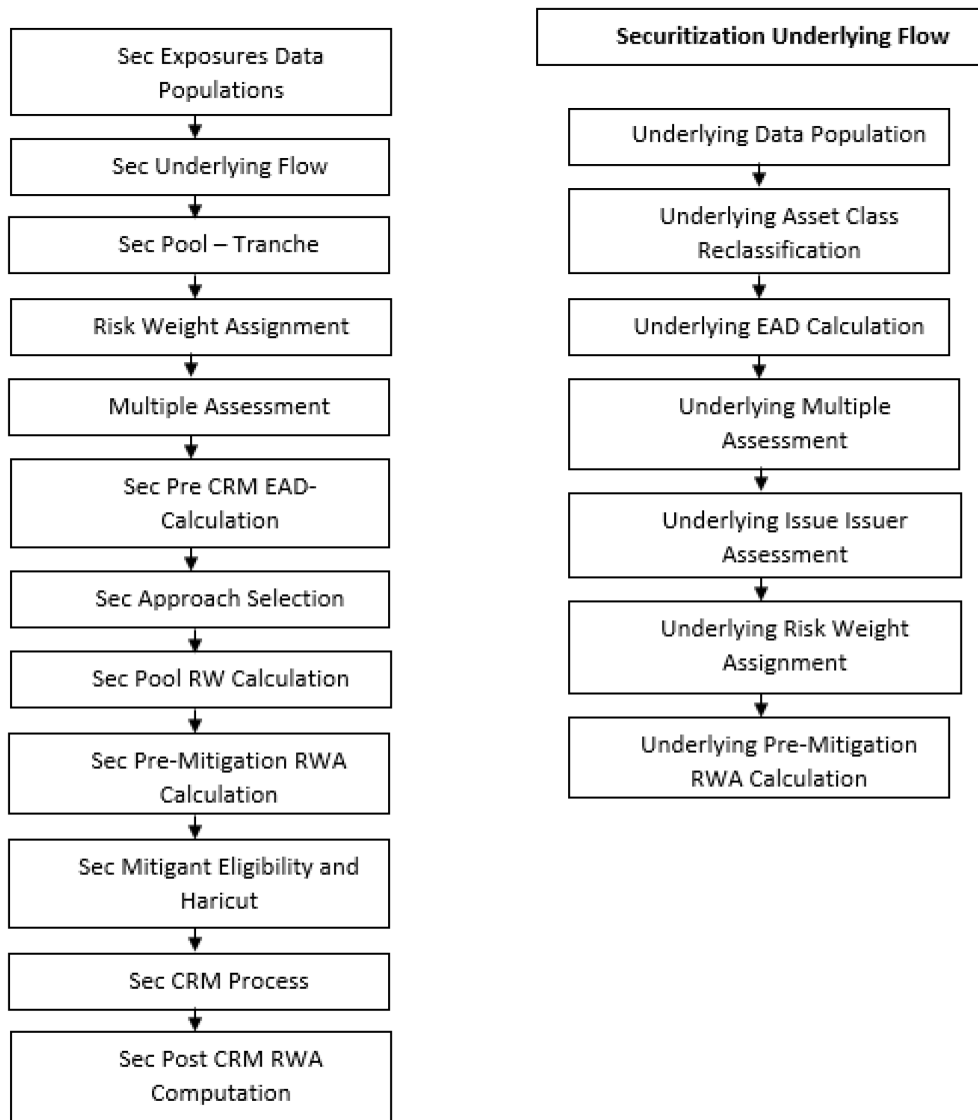

7.5.2 Rating Population

Credit Rating Process

The entire rating information of the exposures and the mitigants are populated from the staging tables to the processing tables. The exposure and the tranche rating information are captured in the account rating (**STG_ACCOUNT_RATING_DETAILS**) and the instrument rating (**STG_INSTRUMENT_RATING_DETAILS**) tables respectively and the mitigant rating information is captured in the instrument rating details (**STG_INSTRUMENT_RATING_DETAILS**) table.

- Account Rating Table (**STG_ACCOUNT_RATING_DETAILS**)
 - Credit Rating for all exposures

- Instrument Rating Table (STG_INSTRUMENT_RATING_DETAILS)
 - Credit Rating for all tranche and mitigants
- Party Rating Table (STG_PARTY_RATING_DETAILS)
 - Credit Rating for all issuers are captured in this table.
- Sovereign Rating Table (STG_SOVEREIGN_RATING_DETAILS)
 - Credit Rating for all countries is captured in this table.

The Processing Steps are as follows:

Banks obtain credit ratings from different sources, and these are provided as an input in the application through the rating tables mentioned in the preceding list.

This is handled in the process Credit Rating Data Population.

The application re-classifies the rating information to BIS Specific standard ratings. The out-of-box application supports the Fitch / Moodys / S&P and DBRS credit rating reclassification for Long Term and Short-Term ratings.

This is handled in the process Credit Rating Reclassification.

The rating reclassification lookup table (**FSI_RATING_CLASSIFICATION**) is used to lookup reclassified standard ratings so that the reclassification rule is not repeated for each of the rating processing tables.

Ratings are populated from the stage tables (for example, **STG_PARTY_RATING_DETAILS**) to FSI tables (for example, **FSI_PARTY_RATING_DETAILS**) using the lookup table (**FSI_RATING_CLASSIFICATION**) to obtain a reclassified rating.

Ensure that all the relevant columns as indicated in the DL Specs are mandatorily populated with data. For example, in the Stage Party Rating Details (STG_PARTY_RATING_DETAILS) table: Rating source code (V_RATING_SRC_CODE), Party Code (V_PARTY_CD), Purpose (V_PURPOSE) are required to be populated. The purpose code is to indicate whether the rating is a domestic rating or foreign rating. If any other rating is provided, then the exposure is considered as unrated.

7.5.3 Data Population

7.5.3.1 Pre-Processing Steps

Securitization and Mitigant Data Population with Mitigant Mapping

Below is the list of relevant tables with their exposure type:

Table 39: Table names and exposure type

Table Name	Exposure Type
STG_UNDERLYING_EXPOSURES	Exposure related to Investing Bank underlying pool
STG_SECURITIZATION_POOL	Total Pool Level attributes in the Stage Pool
STG_SECURITIZATION_TRANCHE	Tranche Level Attributes
STG_GUARANTEES	Credit protection exposure which are in form of guarantees

STG_CREDIT_DERIVATIVES	Credit derivative
STG_INVESTMENTS	regular investment in the Tranches by an investing bank, or it is part of the mandate for retention in the pool or tranche for an originating bank
STG_COMMITMENT_CONTRACTS	Exposures related to facility or service cash advance
STG_SWAPS_CONTRACTS	Exposures which are securitization hedges done through swaps

This is handled in the process Sec Data Population

With respect to the securitization, the underlying exposures, which are not securitization exposures, follow the process pertaining to the non-securitization exposures. The underlying exposures, which are securitization exposures, follow the process pertaining to the securitization exposures.

The mitigants data are populated from the staging table to the processing table. The exposures which are mapped to the mitigants are captured and populated from the staging table to the processing table.

Mitigant data population is handled by the process **Mitigant Data Population** in BIS Standard run.

Exposure mitigant mapping population is handled in the process **ACCT_MITIGANT_MAPPING_POP**

7.5.4 Shareholding Percent Multiplication

Shareholding percent multiplication for common entity level data is a part of BIS Common Data Processing (PMFCOM020) process. In this the application updates the shareholding percentage against each entity. The parent entity is updated with the value of 1 as the shareholding percent and for each child entity, the percentage is based on the parent's holding percentage as specified for each child in fact entity shareholding percent table (FCT_ENTITY_SHR_HLD_PCT).

Shareholding percent multiplication for exposure level is part of each portfolio as well. In this process, the application multiplies the entity shareholding percentage for that entity with respect to parent entity against exposure amount, undrawn amount and provision amount for that exposure and update the same. This is handled in the process Sec Data Population

7.5.5 Common Reclassification Rules

The application reclassifies the bank's product types and party types to standard product and party types. Based on the standard product and party type, it forms an asset class for each exposure is arrived at. Similarly, the application does reclassification for mitigant based on its mitigant types and reclassifies it to standard mitigant types.

Ensure that all products and party type and mitigants which are bank-specific are reclassified, as part of the setup activity. If they are not reclassified, the treatment might not happen as expected by the regulator.

1. Product Type Reclassification

Product types used by the reporting bank as input data are reclassified to standard product types as recommended in the Accord. The product types after reclassification are stored as Basel product types. For Example, Housing Loan is reclassified as Residential Mortgage Exposure.

This is handled in the Basel Product Type Reclassification which is part of the COMMON_RECLASSIFICATION.

2. Party Type Reclassification

Similar to the product type, the customer type (which are stored as counterparty type) are also reclassified as standard counterparty type. The Basel application is designed to include customer type, and legal entity type in a single table (STG_PARTY_MASTER). This is applicable for staging and the dimension model. These are reclassified together as well. Party type reclassification Rules handle reclassification for customer, and entity types. For Example, an Individual is reclassified as Retail.

This is handled in the BIS - Basel Party Type Classification which is part of COMMON_RECLASSIFICATION.

This is handled in the Party Type Reclassification which is part of BIS Other Reclassification process.

3. Mitigant Reclassification

For mitigants the application reclassifies the mitigant type to the standard mitigant type like the debt securities, cash, and so on.

The reclassification tasks are present in the MITIGANT_TYPE_RECLASSIFICATION sub process.

4. Other Reclassification

As part of the reclassification rules, any other data which is being brought inside the application like Pool Type, seniority, transaction type and so on also get reclassified into OFSAA specific values.

This is also mandatory to be done, as otherwise data will not be available for processing as required by the regulator. This happens as part of the process COMMON_RECLASSIFICATION.

7.5.6 Asset Reclassification Rules

This is applicable only for the underlying exposures. See the banking and investment process.

7.5.7 Due Diligence Requirement for Securitization Exposures

If a banking organization is able to meet due diligence requirements, a Bank can follow any risk weight approach under securitization, to all its securitized exposures, as per the revised hierarchy of approaches. If bank is not able to meet the due diligence requirements, then all the exposures will be risk weighted at 1250%.

The application assigns the appropriate approach to the exposures, based on the criteria specified in the Revised Accord.

This happens in the process SEC_DATA_PROCESSING_STD.

7.5.8 Sec Approach Selection

In the case of banks which follow the standardized approach for their credit risk of Non securitization approaches, the hierarchy is SEC-ERBA, SEC-IAA, SEC-STD and 1250% Risk Weight,

SEC-ERBA (Sec – External Ratings Based Approach) subject to supervisory approval is based on the external ratings assigned to the exposures or the instruments, and also depends on other attributes like the maturity and the tranche thickness.

In case of absence of external rating, the exposures will undergo SEC-IAA (Internal Assessment Approach), based on supervisory approval.

And, if these approaches are not applicable, then the exposures will be assigned a risk weight using SEC-STD Approach.

And if none of the approaches are applicable then the exposures will be assigned a risk weight of 1250%.

This happens part of the sub process SEC_EXPOSURES_METHODODOLOGY_ASSIGNMENT under the process SEC_DATA_PROCESSING_STD

7.5.8.1 Pre-mitigation Calculations

The application calculates the Pre-Credit Risk Mitigation (CRM) Exposure at Default (EAD) for each exposure. This value signifies the maximum loss that the bank can suffer, in case of default on this exposure, before considering any mitigation effects.

The application also computes pre-mitigation risk-weighted assets (Pre CRM RWA) and post-mitigation risk-weighted assets (Post CRM RWA) by multiplying the respective EAD by risk weight. The risk weight is arrived using the hierarchy of approaches as suggested above.

7.5.8.2 Exposure at Default Amount Calculation

Exposure at Default (EAD) is calculated using the Exposure Amount (EOP Balance of the Exposure), Undrawn Amount of the Exposure (Undrawn Amount) and also the Credit Conversion Factor for the Off-Balance sheet Amount (CCF). This is computed for the on-balance sheet products separately, and the off-balance sheet products separately.

This is handled in the sub process SEC_PRE_CRM_EAD_CALCULATIONS under the process SEC_DATA_PROCESSING_STD.

7.5.8.3 Multiple Assessment

For exposures with multiple ratings, risk weight assignment is based on multiple assessment process. For each exposure, the final rating is the worst of the best two ratings assigned to the exposure.

The risk weight corresponding to this rating is then assigned to the exposure.

Exposures for multiple rating assessment are first moved into the table FSI Multiple Rating Processing (FSI_MULTIPLE_RATING_PROCESSING) wherein the ranking and final selection of which rating to use takes place.

This happens in the process of SEC_MULTIPLE_ASSESSMENT, under that sub process the application has data transformation separately for exposures and its tranches.

7.5.8.4 Risk Weight Assignment

Sec-External Ratings Based Approach (SEC-ERBA)

If there is a supervisory approval, application continues with the computations else it will look for the next approach.

For exposures that follow the external ratings based approach, the risk weight assignment is based on the criteria used for risk weighting. This is handled as part of the sub process SEC_RISK_WEIGHT_ASSIGNMENT_BASED_ON_RATINGS.

The application uses the seniority position of the exposure, maturity, thickness of the exposure and the credit rating to assign the risk weight to the exposure.

To ensure that the exposures have the risk weight assigned based on their maturity term, the application supports interpolation of the risk weight to accommodate the varying maturity of the exposures.

The DT which is used for interpolation is "Sec_Interpolated_RW" which updates interpolated risk weights for each exposure in "FCT_SEC_EXPOSURES" table. Exposures updated include both "STC condition met" exposures and "STC condition not met" exposures.

This happens in the sub process SEC_INTERPOLATED_RISK_WEIGHT_AND_AVG_EXS_SPRD under SEC_DATA_PROCESSING_STD

Once the risk weights are assigned based on the above-mentioned process the application calculates the SEC_RISK_WEIGHT_CALCULATION under the process SEC_DATA_PROCESSING_STD.

SEC-IAA

Sec IAA is followed in the application based on Internal assessment on the exposures also based on the ABCP indicator. The exposures with that flag enabled F_ABCP_IND will undergo the SEC_IAA approach. The Sec IAA is also to be followed based on the supervisory approval. This SEC-IAA methodology is assigned on the sub process SEC_EXPOSURES_METHODOLGY_ASSIGNMENT.

Once after the approach assignment the application calculates the Risk weight as part of the sub process SEC_RISK_WEIGHT_ASSIGNMENT_BASED_ON_RATINGS under the process SEC_DATA_PROCESSING_STD and the risk weight calculations are handled in the sub process SEC_RISK_WEIGHT_CALCULATION under the process SEC_DATA_PROCESSING_STD.

Sec-Standardized Approach (SEC-STD)

For exposures following the sec-standardized approach, the application calculates the underlying weighted average capital requirement of the securitization pool (KSA). This is handled at sub process SEC_POOL_CAPITAL_CHARGE_CALCULATION_SA

Other parameters needed for SEC-STD are calculated by the application based on underlying data. This is handled as part of the sub process SEC_TRANCHE_CREDIT_ENHANCEMENT_CALCULATION and the pool level data calculation happens as part of the sub process SEC_POOL_DELINQUENT_BALANCE_CALCULATION.

After all the parameters are calculated, application computes SSFA (Simplified Supervisory formula approach) capital and uses below mentioned logic for risk weight computation. The exposures for which are detachment point (D) less than that of the KA, the exposures are deducted (it will be risk weighted at 1250%). The exposures for which the credit enhancement level is more than that of the KA, the exposures have the KSSFA (SSFA capital charge) computed. The exposures for which the credit enhancement level is less than that of the KA but the sum of the credit enhancement level and the tranche thickness are more than the KA, the exposures are straddled, and that is, the tranche to which the exposure belongs to is split into a position below KA and a position above KA. All the exposures mapped to the straddled tranche are also split by the application in the same proportion as the split tranche. Post straddling risk weight is computed using the computation logic mentioned by the accord.

This happens as part of the sub process SEC_TRANCHE_PARAMETER_CALCULATIONS.

For the calculation of Risk weight under standardized approach (SEC_STD) the below sub processes in the application calculates the respective values mentioned above in the processing table for each exposure. This happens part of the sub process SEC_SA_PRE_CRM_CAPITAL_CALCULATION under the process SEC_DATA_PROCESSING_STD

Maximum RW for Exposures

Maximum risk weight requirements for senior exposures for all the pools is handled by the application as per the logic given in the accord.

For Maximum capital requirement, in order to apply a maximum capital charge to a bank's securitization exposure, the following inputs are required: The largest proportion of interest that the bank holds for each tranche of a given pool (P).

In particular: – For a bank that has one or more securitization exposure(s) that reside in a single tranche of a given pool:

P equals the proportion (expressed as a percentage) of securitization exposure(s) that the bank holds in that given tranche (calculated as the total nominal amount of the bank's securitization exposure(s) in the tranche) divided by the nominal amount of the tranche.

For a bank that has securitization exposures that reside in different tranches of a given securitization, P equals the maximum proportion of interest across tranches, where the proportion of interest for each of the different tranches must be calculated as described above.

This happens in the sub process SEC_POOL_TRANCHE_PARAMETERS_UPDATE_EXPOSURES under the process SEC_DATA_PROCESSING_STD

If none of the approach is applicable for the exposures, then 1250% Risk Weight will be applicable. This approach assignment happens part of the sub process SEC_EXPOSURES_METHODODOLOGY_ASSIGNMENT under the process SEC_DATA_PROCESSING_STD. Once after the above sub process the risk weight calculation will happen based on the Sec 1250% risk weight in the sub process SEC_RISK_WEIGHT_CALCULATION under the process SEC_DATA_PROCESSING_STD.

Re-securitized exposures

Re-securitized exposures are the exposures which are issued out of a pool of underlying exposures which constitutes non-securitized exposures and some portion of securitized exposures. Application is capable of handling both securitized exposures and re-securitized exposures.

The securitized underlying of the re-securitization pool will be captured in the Stage underlying Exposures (STG_UNDERLYING_EXPOSURES). As per the revised framework, the approach that should be used for risk weight calculation is standardized approach only, no other approaches are applicable. The application assigns the same approach based on the re-securitization flag. For these exposures parameters that are used in standardized approach are calculated for both non-securitized and securitized exposures using the logic mentioned in the revised accord.

This happens in the sub process RESEC_POOL_RW_CALCULATIONS under the process SEC_DATA_PROCESSING_STD.

STC Transactions (STC Transaction)

As per the revised Basel guidelines the transaction with simplicity means the homogeneity of the underlying assets belong to same products / characteristics and simple in nature which have the transparency of the underlying assets, the details of the transactions are with sufficient information also they are easily comparable against the equivalent transactions. The eligibility of these conditions is checked for the transactions and these transactions are handled separately by the application

This is in the sub process SEC_ELIGIBILITY_FOR_STC_TRANSACTIONS under the process SEC_DATA_PROCESSING_STD. Once the Eligibility conditions are checked for the exposures based on

the above sub process the respective exposures are handled in the downstream sub process in the application which are stated above under various approaches.

Sec Pre-CRM RWA Computation

The application calculates the Pre-CRM RWA for the exposures by multiplying the Pre-CRM EAD with the risk weight of the exposures. Pre-CRM RWA is computed in the Sec Pre-CRM RWA Computation sub process.

This is handled in application under SEC_PRE_CRM_CAPITAL_CHARGE

7.5.8.5 Credit Risk Mitigation Process

To calculate the post CRM RWA, application needs to account for mitigants which may be in the form of collaterals, guarantees, credit derivatives. Not all mitigants are eligible for RWA computation. All the mitigants which get populated into the system are being made ineligible, and then the regulatory approved mitigant types and the issuer type combination are made eligible in Mitigant Processing.

Mitigant Data population

Mitigant data is loaded from the Stage Mitigant table (STG_MITIGANTS) into the FSI CAP Mitigants table (FSI_CAP_MITIGANTS) where further processing takes place. This is takes place under the process Mitigant Data Population.

Mitigant Multiple assessment

Similar to exposures with multiple ratings, mitigants with multiple ratings are also subject to Multiple rating Assessment. This is handled under the sub-process Mitigant Multiple Rating Assignment – BIS.

All the guarantees and credit derivatives issued by issuers that are reclassified as Other Entities are treated as eligible for Securitization exposures if they satisfy the current rating and the original rating criteria specified by the Basel accord. For processing the original rating of these issuers, the application performs the multiple assessments of the initial ratings.

The Data Transformation “CAP_MITIGANT_MULTIPLE_ASSESSMENT_DATA_POP” performs this.

Mitigant Eligibility Approaches and their Risk Weighting Rules

Mitigant Risk Weight

For Simple approach, the application assigns risk weight to mitigants on the basis of credit rating (CAP Mitigant Basel Rating and Risk Weight Assignment), original maturity (CAP Mitigant RW Assignment based on Original Maturity). These fall under the process Mitigant RW Assignment – Simple –BIS.

Similarly, for Comprehensive approach, mitigant risk weights are assigned on the basis of credit rating (CAP Mitigant Basel Rating and Risk Weight Assignment), for financial collaterals (CAP Mitigant RW Assignment for Financial Collaterals - Comprehensive Approach). These fall under the process Mitigant RW Assignment – BIS –Comprehensive Approach.

Mitigant Eligibility

The application identifies the eligible mitigants based on the criteria as mentioned by the Regulator. The application identifies the following standard mitigants– collateral, guarantees, and credit derivatives.

The application is capable of using the Simple Approach and the Comprehensive Approach for the mitigants which are part of the collateral. The application identifies the eligibility of the financial collateral

separately for the simple approach and the comprehensive approach. The eligibility of the collateral mitigants is based on the party type of the mitigant, mitigant types, the credit rating assigned to the mitigant or the party (as applicable), and the classification of collateral as senior or not.

This is handled in CAP Mitigant Eligibility for Equity - Simple approach under the process Mitigant Collateral Eligibility Simple Approach -BIS

For mutual funds, the eligibility is based on the eligible mutual fund indicator. This is handled in CAP Mitigant Eligibility for Mutual Fund - Simple approach under the process Mitigant Collateral Eligibility Simple Approach -BIS

The application also identifies whether the mitigant is a Re-securitized exposure and if yes, makes it ineligible.

This is handled in CAP Collateral Eligibility - Simple Approach under the process Mitigant Collateral Eligibility Simple Approach -BIS

The application identifies the eligibility of the guarantees and credit derivatives based on the party type of the mitigant and the credit rating assigned to the issuer of the mitigant. This is handled in the process Mitigant Collateral Eligibility Simple Approach -BIS.

Similar mitigant eligibility rules for Comprehensive Rule can be found in the process Mitigant Collateral Eligibility - Comprehensive Approach -BIS.

The option for the bank to select Collateral Simple Approach or Comprehensive Approach is based on the Run Management option as selected in the UI.

Mitigant Haircut Assignment

Under Standardized approach, the bank has to follow supervisory estimates for Mitigant Haircut assignment. This is based on the various categories like mitigant type, residual maturity, rating, issuer type and so on. This is applicable only if the bank follows comprehensive approach for collateral.

Only eligible mitigants are considered for haircut assignment and for further processing. Post haircut assignment, the eligible mitigants are moved from mitigants table (FSI_CAP_MITIGANTS) to sub exposures table (FSI_CAP_SUB_EXPOSURES).

The application does computations for three kinds of mitigant haircuts which are volatility haircut, Forex haircut, and maturity mismatch haircut.

Volatility Haircut

Volatility haircuts are assigned to the collateral to account for any future fluctuations in the market value of the financial collateral. The application assign haircuts for various type of financial collateral like debt securities, equity, mutual funds, and so on. In the supervisory haircut method, the application assigns volatility haircut based on issues, issuer's ratings, mitigant's residual maturity, and type of mitigant.

This is handled in CAP CRM Mitigant Volatility Haircut - Supervisory Haircut under CRM Sub Exposure Data Haircut Assignment process.

Forex Haircut

If the exposure and collateral are in different currencies, then the application makes an adjustment by applying the Forex haircut.

This is handled in CAP CRM Forex Haircut Sub Exposures under CRM Sub Exposure Data Haircut Assignment process.

Maturity Mismatch Haircut

If the residual maturity of the Credit Risk Mitigant is less than that of the underlying credit exposure, then a maturity mismatch haircut is applied to adjust the value.

This is handled under CAP CRM Maturity Mismatch Haircut under CRM Sub Exposure Data Haircut Assignment process.

7.5.9 Pooling and Optimizer

7.5.9.1 Pooling

Pooling is one of the pre-requisites for the optimized allocation of the exposures.

Pooling pulls out an exposure, and identifies all the relevant mitigants mapped to it, and the corresponding exposures mapped to these mitigants, and again the corresponding newer mitigants mapped to these exposures. This pooling assigns the cardinality to the exposures based on the mitigant combination.

This happens in the FSI Cap Sub Exposures (FSI_CAP_SUB_EXPOSURES), and the pooling is part of the sub process

The relevant cardinalities that get assigned to the exposures, as part of this pooling process are as below:

- 1-0 → One exposure not mapped to any mitigant
- 1-1 → One exposure mapped to one mitigant
- 1-N → One exposure mapped to multiple mitigants
- N-1 → Multiple exposures mapped to a single mitigant
- N-N → Multiple exposures mapped to Multiple mitigants

7.5.9.1.1 Optimizer

The optimizer is the process of allocation of the mitigants to the exposures, based on the different logic applicable for the various granularity. For more information, see [Annexure](#).

Both Pooling and Optimizer is handled under the process **CRM Sub Exposure Pooling and Optimizer Processing**.

7.5.9.1.2 Post CRM RWA Computation

The application computes the covered amount and the uncovered amount for the exposures. The covered amount is computed by multiplying the covered factor with the exposure amount. To this covered amount, the application assigns the mitigant risk weight. The product of the covered amount and the mitigant risk weight is the covered RWA. The uncovered amount is computed by multiplying the uncovered factor (which is 1 – sum of all covered factors for that exposure) with the exposure amount. This uncovered amount is multiplied by the exposure risk weight to get the uncovered RWA. The sum of the covered RWA and the uncovered RWA is the Post CRM RWA of the exposure.

7.6 Market Risk RWA

The Basel Committee has introduced Market Risk Capital Charge calculation in 1996 as an amendment to the earlier Basel accord by considering the risk borne by a financial institution having exposures in the Trading Book. BIS defines Market Risk as “the risk of losses in the on and off-balance-sheet positions arising from movements in market prices”. It is the risk that arises out of the adverse movements of the market factors. Market risk consists of the risk borne by the bank due to the positions in its trading book.

Basel outlines two basic approaches for calculating the capital charge for Market Risk:

- Standardized Approach
- Internal Model Method Approach

7.6.1 Standardized Approach

In standardized approach (STD Approach), the Market Risk Capital Charge is calculated for the following instrument types:

- Interest Rate related Instruments (IR Instruments)
- Equity Position Risk
- Foreign Exchange Risk
- Commodities
- Options

Prerequisite for MR Processing

Execution of the Run, Staging Data Population - Market Risk - BIS Standardized Approach is usually a onetime activity. This must be executed once before actual Market Risk Run is executed. This Run is expected to execute in following circumstances. The following tasks are performed when the Run is executed.

- Interest Rate Curve Data
- Market prices of the instruments
- Bank positions

This Run populates the instrument level data that is required by the actual Run for further processing. The instrument level data such as number of units of the instruments on that particular MIS date is downloaded in bank instrument position (**STG_BANK_POSITIONS**) table. This data flows into the fact table for further processing. The OTC instrument price is expected as a download. For non-OTC instruments the data for instruments' price is captured in Market Instrument Contract (**STG_MKT_INSTRUMENT_CONTRACT**) table. This data further flows into the fact table.

For IR instruments, the interest rate required is captured in IRC Rate History (**STG_IRC_RATE_HIST**) table. This data further flows into the fact table. This data is required for term structure that is used in Modified Duration and Greeks Parameter calculation for options.

Process Flow for Market Risk - Standardized Approach

The following pre-defined Run can be executed to compute Market RWA using the Standardized Approach.

Run: Risk-weighted Asset Calculation - Market Risk - BIS Standardized Approach.

Figure 40: Standardized Approach process

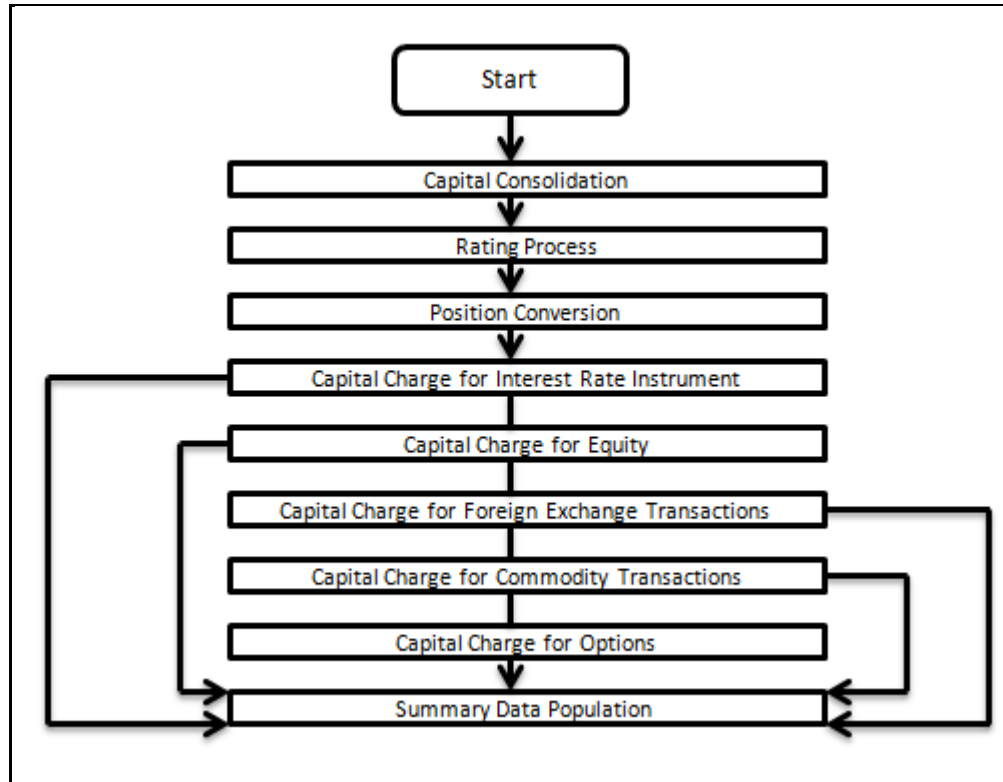

For more information on the computation of Market Risk using the Standardized and IMM approaches, see [Standardized Approach](#).

7.6.2 Data Population

The application populates Market Risk Exposures (FCT_MARKET_RISK_EXPOSURES) table with the details provided by the bank in Stage Bank Positions (STG_BANK_POSITIONS) table and Stage Instrument Contract Master (STG_INSTRUMENT_CONTRACT_MASTER) table. Forex exposures of the bank are populated into Market Risk Forex (FCT_MARKET_RISK_FOREX). This exercise is done for all the Trading Book exposures.

For more information on processes and sub processes that compute this:

- Process: MKT_RISK_POSITION_CONVERSION
- Sub-process: Market Risk Data Population

7.6.3 Shareholding Percent Multiplication

For consolidated runs, exposures of the child entities are multiplied by the entity shareholding percentage to arrive at the consolidated exposure at the parent level.

For more information on processes and sub processes that compute this, see the following:

- Process: MKT_RISK_POSITION_CONVERSION
- Sub-process: Shareholding Percent Multiplication

7.6.4 Currency Conversion

All the positions in other currencies are converted into the reporting currency of the bank, based on the currency conversion rate between the exposure currency and reporting currency.

For more information on processes and sub processes that compute this, see the following:

- Process: MKT_RISK_POSITION_CONVERSION
- Sub-process: Currency Conversion

7.6.5 Common Reclassification Rules

The application reclassifies all bank instruments into standard instrument types based on contract type, contract position, market risk position, and so on. A fixed bond forward with a long position in the contract is reclassified into fixed rate bond for the long leg and zero risk security for the short leg created by position conversion. The reclassifications are then used for notional value calculation.

For more information on processes and sub processes that compute this, see the following:

Process: MKT_RISK_POSITION_CONVERSION

Sub-process:

- Position Conversion Exotic Options
- Position Conversion Options
- Position Conversion Basket Futures - Interest Rate
- Position Conversion Swaps
- Position Conversion Forwards and Futures
- Position Conversion Hybrid Instruments
- Position Conversion Credit Derivatives

7.6.6 Position Conversion

Position conversion is processed before Capital Charge calculation under Market Risk. In Position Conversion, different instruments are broken into long and short positions and carried forward for specific and general risk charge calculation. All derivative instruments undergo position conversion so that the instrument is broken down into simplified positions for further processing. For derivative positions in equities, commodities, gold, currencies, and so on, only one leg is exposed to interest rate and other leg is exposed to the respective asset (equity, Forex) as the case may be. The following information is required for position conversion: long or short position, Value of Notional Position, Coupon Rate, and Maturity.

Methodology for Position Conversion

While calculating interest rate risk, each instrument is converted into multiple positions. The notional value of each position is derived based on the following methodology:

Notional positions in actual debt securities are valued as the nominal amount underlying the contract at the current market price of the debt security.

Positions in zero-specific-risk securities is valued using one of the following two methods:

- The present value approach, under which the zero specific-risk security is assigned a value equal to the present value of all the future cash flows that it represents or
- The alternative approach, under which the zero specific-risk security is assigned a value equal to the market value of the underlying notional equity position in the case of an equity derivative; the notional principal amount in the case of an interest rate or foreign currency swap; or the notional amount in the case of any other financial instrument

For options, the delta weighted values go into the general risk charge calculation. Delta is computed by the application based on the instrument type, coupon, residual maturity, strike price, spread, option premium value, and so on.

For an Interest Rate (IR) Swap, the parent instrument is identified as a Receiver or Payer swap based on whether the bank is receiving fixed or paying fixed, respectively. After Position Conversion, the parent swap is converted to two child positions which is in zero specific risk securities. The exposure amount for each of these positions is computed based on the coupon rate of receiving leg for the long child position and the coupon rate of the paying leg for short child position. Currently the notional amount for both the child positions is being computed using the current market price column of the parent.

- Instrument Coverage
- Interest Rate Derivatives
 - Bond Forward
 - Forward Rate Agreement
 - Bond Future
 - Future on a Basket/Index of bonds
 - Interest Rate Futures
 - Receiver Swap (without deferred start)
 - Payer Swap (without deferred start)
 - Basis Swap (without deferred start)
 - Forward Basis Swap
 - Forward Receiver Swap
 - Forward Payer Swap
 - Dual Currency Bond
- Equity Derivatives
 - Equity Forward
 - Equity Future
 - Equity Swap
- Currency Derivatives

- Currency Forward
- Currency Future
- Currency Swap
- Commodity Derivatives
 - Commodity Forward
 - Commodity Future
 - Commodity Swap
 - Gold Forward
- Credit Derivatives
 - Credit Default Swap
 - Total Rate of Return Swap
 - Cash Funded Credit Linked Notes
 - First and Second-to-Default Basket Credit Derivatives
- Options / Structured Products
 - Option on Equity
 - Option on Currency
 - Option on Commodity
 - Option on Currency Future
 - Option on Currency Forward
 - Currency Swaption
 - Option on a bond
 - Option on a bond future
 - Option on a Forward Rate Agreement
 - Option on an Interest Rate Future
 - Caps
 - Floors
 - Collars
 - Swaptions
 - Bonds with Embedded Swaptions
 - Callable Bonds
 - Puttable Bonds
 - Floating Rate Notes with Caps
 - Floating Rate Notes with Floors

- Reverse Floaters
- Leveraged Floaters

Position Conversion - Process Flow

The process flow of Market Risk Position Conversion is as follows:

Figure 41: Process flow of Market Risk Position

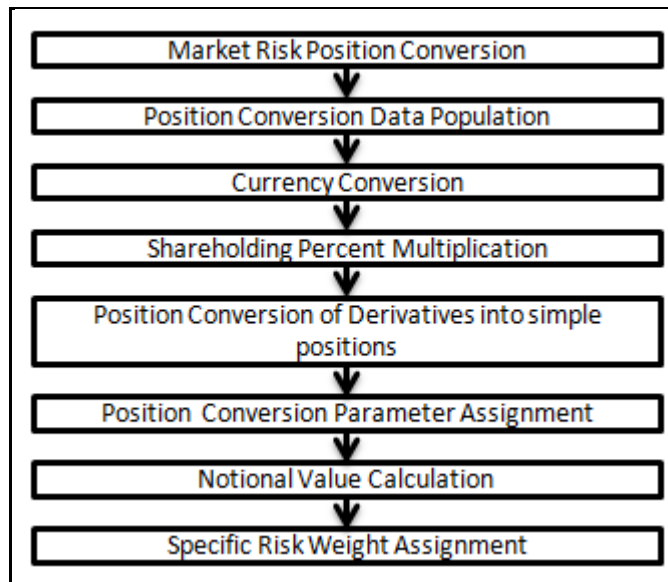

Position Conversion Data Population

The application populates Market Risk Exposures (**FCT_MARKET_RISK_EXPOSURES**) table with the details provided by the bank in Stage Bank Positions (**STG_BANK_POSITIONS**) table and Stage Instrument Contract Master (**STG_INSTRUMENT_CONTRACT_MASTER**) table. FOREX exposures of the bank are populated into Market Risk FOREX (**FCT_MARKET_RISK_FOREX**). This exercise is done for all the trading book exposures.

For more information on processes and sub processes that compute this:

Process: MKT_RISK_POSITION_CONVERSION (PMFIND0032)

Sub-process: Market Risk Data Population

Position Conversion of Derivatives into Simple Positions

The application takes the contract details from instrument table and breaks each contract into multiple positions into market risk exposures (FCT_MARKET_RISK_EXPOSURES) table. The application splits instruments, which are derivatives in nature, into multiple positions based on the instrument position mapping available in the mapping table. For example: A bank having a plain long position in a derivative instrument is split into one long and one short position. Hence for each position and nature of contract type, the application creates the required number of positions in the processing table. The download information used for position conversion is contract details, instrument type, contract position, position mapping, and so on.

Certain exotic instruments are split into more than two positions. For example: A long position in a reverse floater is converted into the following positions.

- A long position in two straight bonds (double the notional amount and half the fixed interest rate);
- A short position in a floating rate bond (a position in floating rate bond with notional amount and floating reference rate);
- A long position in a cap (which is further broken down into its underlying positions).

The application reclassifies all bank instruments into standard instrument types based on contract type, contract position, market risk position, and so on. A fixed bond forward with a long position in the contract is reclassified into fixed rate bond for the long leg and zero risk security for the short leg created by position conversion. The reclassifications are then used for notional value calculation.

For more information on processes and sub processes that compute this, see the following:

Process: MKT_RISK_POSITION_CONVERSION

Sub-process:

- Position Conversion Exotic Options
- Position Conversion Options
- Position Conversion Basket Futures - Interest Rate
- Position Conversion Swaps
- Position Conversion Forwards and Futures
- Position Conversion Hybrid Instruments
- Position Conversion Credit Derivatives

Position Conversion Parameter Assignment

After position conversion, that is, breaking each derivative instrument into long and short leg, the application assigns instrument parameters for each position leg created under position conversion logic. For each leg, relevant information like: coupon rate, coupon frequency, maturity, strike price for options, option premium value, and so on are updated from parent information. This information is used in identifying instruments to be grouped under maturity ladder based on coupon rate (less than or greater than equal to 3%), duration calculation for duration ladder approach, calculation of Greeks for option charge, and so on.

For more information on processes and sub processes that compute this, see the following:

Process: MKT_RISK_POSITION_CONVERSION

Sub-process:

- Position Conversion Exotic Options
- Position Conversion Options
- Position Conversion Basket Futures - Interest Rate
- Position Conversion Swaps
- Position Conversion Forwards and Futures
- Position Conversion Hybrid Instruments

- Position Conversion Credit Derivatives

Notional Value Calculation

Notional value of each leg created by position conversion for each instrument is calculated based on the contract characteristics (market price, number of units). For options it is the delta weighted position which is carried forward for market risk charge calculation.

For more information on processes and sub processes that compute this, see the following:

Process: MKT_RISK_POSITION_CONVERSION

Sub-process:

- Position Conversion Exotic Options
- Position Conversion Options
- Position Conversion Basket Futures - Interest Rate
- Position Conversion Swaps
- Position Conversion Forwards and Futures
- Position Conversion Hybrid Instruments
- Position Conversion Credit Derivatives

7.6.7 General Market Risk Charge Calculation

General Risk charge is calculated for each interest rate risk exposure for a reporting bank. General Risk charge is calculated based on two methods:

- **Maturity Ladder Approach**
- **Duration Ladder Approach**

Under both the methods, the application creates time bands and based on Residual Maturity or Modified Duration, places each instrument in the respective time bands for offsetting. The matched and unmatched positions across time bands and across three zones attracts general risk charge as per the definition stated in guidelines for market risk.

Residual Maturity Ladder

Under the Maturity Ladder approach, the general risk charge is calculated for each currency. For multiple currencies, the horizontal and vertical disallowance is calculated by creating separate residual maturity ladder for each currency unless the interest rate risk exposures are insignificant for the reporting bank. In the case of insignificant exposures in multiple currencies, exposures are grouped into a single residual maturity ladder for general risk charge calculation.

Under Residual Maturity Method, the application initially creates around 15 residual maturity time bands. The time band definitions, provided in the Basel II guidelines, are based on the coupon being less than 3% or equal to and greater than 3%. All the 15-time bands are grouped to 3 zones for horizontal disallowance as per the zone definition given in Basel II Market Risk guidelines. This is computed under the process '**MR Time Band Reclassification – Maturity Approach**'. Based on the time bands, positions are assigned general risk weights. The delta-weighted positions of IR options are considered for the slotting into time bands and zones.

The entire end to end processing of general risk charge is calculated in a separate table (**FCT_MARKET_RISK_CAPITAL**) meant specifically for it and can be selected and analyzed in the form of reports. All the processing steps and related data are stored in the table starting from weighted long and short positions, matched and unmatched positions following horizontal and vertical disallowance, and net open position by each currency.

For more information on processes and sub processes that compute this, see the following:

Process: MKT_RISK_STD_APPROACH

Sub-process: Time Band Reclassification - Maturity Approach

Duration Ladder

Under the Duration Ladder approach, the application creates Duration Ladder based on the modified duration calculated for each instrument. Similar to Maturity Ladder, the general risk charge under Duration Ladder is also calculated for each currency and insignificant positions across multiple currencies are put into a single modified duration ladder for horizontal and vertical disallowance calculation.

The duration ladder time band created in the application is based on the definition provided in the Basel II guidelines on Market Risk. Like Residual Maturity, for Duration Based Ladder approach the application creates three time zones for each modified duration time band. This is computed in the process 'MR Time Band Reclassification - Duration Approach'. Based on the time bands, positions are assigned an 'assumed rate'. The delta-weighted positions of IR options are considered for the slotting into time bands and zones.

All the processing attributes used under the Duration Ladder Approach are stored in a separate table (**FCT_MARKET_RISK_CAPITAL**) starting from weighted long and short positions, matched and unmatched positions following horizontal and vertical disallowance, and net open position by each currency.

For more information on processes and sub processes that compute this, see the following:

Process: MKT_RISK_STD_APPROACH (PMFMR0030)

Sub-process: Time Band Reclassification - Duration Approach

Horizontal/Vertical Disallowance

In the application, vertical and horizontal disallowance for IR instruments under Maturity and Duration Approach is computed by using a Data Transformation function 'Mkt_Risk_GenRsk_IR' under 'Market Risk General Risk Charge Calculation – IR and Equity'. This computes the matching of the positions within time bands, zones, across adjacent zones, and across non-adjacent zones to finally arrive at the general risk charge for interest rate instruments.

The capital charge is applied at each state for the matched and unmatched position as per the capital charge stated in Basel II guidelines for Market Risk. The procedure followed by the application which handles the horizontal and vertical disallowance is provided in the following section. This process remains same across the Maturity Ladder and Duration Ladder Approaches.

1. The application initially populates weighted long and weighted short position amounts for each time band.
2. The application offsets the matched positions and populates them as 'offset matched position within the time band'. The unmatched positions are populated as 'offset unmatched position within the time band'.

Offset unmatched positions arrived at from the previous step are then considered for offsetting within a time zone. All the 'offset unmatched positions within time band' falling under the same zone are offset with each other and 'offset match same zone' and 'offset unmatched same zone are computed'.

Offset unmatched positions within same zone are then carried forward for calculating 'offset matched between zone' and 'offset unmatched between zones'. This is first processed for zones 1 and 2, further for zones 2 and 3, and lastly for zones 1 and 3.

All the unmatched positions (within time band, same zone, between zones and net unmatched position) are multiplied by the factors listed in the Basel accord for Maturity and Duration approach as applicable.

For more information on processes and sub processes that compute this, see the following:

- Process: MKT_RISK_STD_APPROACH
- Sub-process: Market Risk Generic Risk Charge Calculation - IR and Equity
- Procedure: Mkt_Risk_GenRsk_IR

Summary Output

For reporting purposes, the application moves data from market risk capital (**FCT_MARKET_RISK_CAPITAL**) table to market risk reporting (**FCT_MARKET_RISK_REPORTING**) table.

Finally, RWA is calculated in Market Risk Summary (**FCT_MARKET_RISK_SUMMARY**) table by multiplying capital charge with 12.5. The interest risk charge gets reported out of market risk summary (**FCT_MARKET_RISK_SUMMARY**) table under Interest Risk charge reporting line. Specific and general risk charge for interest rate is also reported separately from the summary table.

For more information on processes and sub processes that compute this, see the following:

- Process: MKT_RISK_STD_APPROACH
- Sub-process:
 - Market Risk Capital Risk Charge Calculation
 - Market Risk IR Reporting Data Population
 - Market RWA Calculation

7.6.8 Specific Market Risk Charge Calculation

Specific risk charge is calculated based on the categories and investment grade. The application first identifies the categories based on the conditions laid by the accord. After the category is identified the specific charge risk weight is assigned based on combination of category, Basel equivalent rating, and residual maturity.

The specific risk weight is assigned under the Market Risk position conversion process. These specific risk weights are then multiplied by the exposure amount arrived at after position offset to eventually compute specific risk charge for Interest Rate instruments.

For more information on processes and sub processes that compute this, see the following:

- Process: MKT_RISK_STD_APPROACH
- Sub-process: Market Risk Specific Risk Charge Calculation - IR and Equity

The application assigns specific risk charge as 8% on gross equity positions. For an index equity which is well diversified, a 4% specific risk charge is applied. In the case of equity derivative, the application takes into account either any future related arbitrage or deliberate arbitrage strategy created on equity. If equity arbitrage is created out of futures, then the application considers the arbitrage information as a mapping in the equity arbitrage mapping (EQ_ARBITRAGE_STRGY_MAPPING) table where any opposite future derivative created as hedge for the underlying equity exposures is expected. The application applies a 2% specific charge on lower of opposite index position created or equity underlying.

For more information on processes and sub processes that compute this, see the following:

Process: MKT_RISK_STD_APPROACH

Sub-process:

- Market Risk Specific Risk Equity
- Market Risk Specific Risk Charge Calculation - IR and Equity

7.7 Process Flow for Credit Valuation Adjustments

Figure 42: Process flow for credit valuation

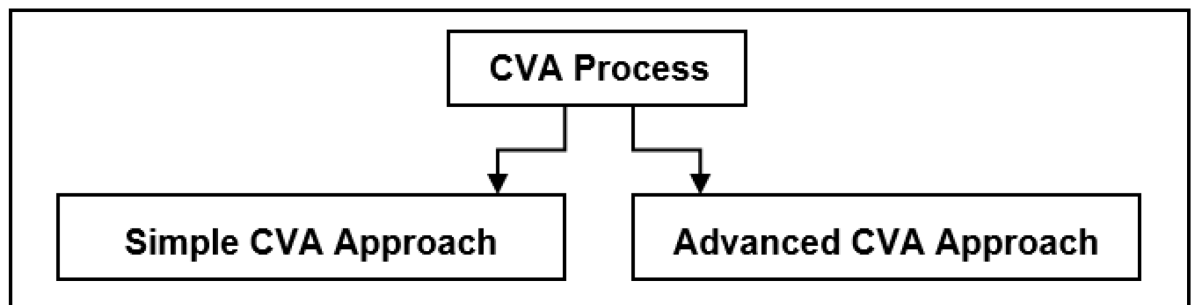

Basel committee has introduced a new Credit Valuation Adjustment (CVA) capital charge, which is added to default risk capital charge to arrive at the new Counterparty Credit Risk (CCR) capital charge. The mark to market counterparty credit losses or the spread migration risk is captured with CVA, which were not directly capitalized before. CVA is the difference between the risk-free portfolio value and the true portfolio value that takes into account the possibility of the counterparty's default. In other words, CVA is the market value of counterparty credit risk.

This process flow is divided into two sections: Simple Approach and Advanced Approach.

For more information on the sub processes as detailed in the process flow, see [Credit Valuation Adjustments](#).

7.8 Credit Valuation Adjustments

Basel committee has introduced a new Credit Valuation Adjustment (CVA) capital charge, which is added to default risk capital charge to arrive at the new Counterparty Credit Risk (CCR) capital charge. The mark to market counterparty credit losses or the spread migration risk is captured with CVA, which were not directly capitalized before. CVA is the difference between the risk-free portfolio value and the true portfolio value that takes into account the possibility of the counterparty's default. In other words, CVA is the market value of counterparty credit risk.

The application calculates CVA Charge for OTC portfolio of a bank. **When using the standardized approach, it is calculated at portfolio level and for advanced approach it is calculated at counterparty level.**

Exclusions for CVA Charge:

Trades with Central Counterparty

Structured Financial Transactions.

Structured financial transactions are applicable only if the supervisor specifically mentions the same. You can include or exclude structured financial transactions in CVA calculation from the Run Management window. Portfolio level considers all the trades in different OTC products with all counterparties. The charge is calculated for the entire exposure of OTC products.

Counterparty level calculations consider all trades in different OTC products with counterparty for calculation of CVA Charge. Charge is calculated for all counterparties with which banks have OTC exposures. The CVA charge for all the counterparties is summed up to ascertain the Portfolio Level Charge. The manner of consolidation is dependent on the IMM approval status and Specific Interest Rate (SIR) Value at Risk (VaR) model approval status of the bank. The following section describes two ways of consolidating default risk charge and CVA capital charge:

If the bank does not have IMM approval and Specified Interest Rate Risk as a part of approved VaR model for bonds,

CCR Capital Charge = Default Risk Capital Charge (Current Exposure Method or Standardized Method based, whichever the bank is using for CCR) + Standardized CVA Capital Charge

If the bank has IMM approval Specified Interest Rate Risk as a part of approved VaR model for bonds,

CCR Capital Charge = Default Risk Capital Charge + Advanced CVA Capital Charge

All the OTC Derivatives products are part of CVA calculations. SFTs are included if you select the option from Run Management Window. Also, trades with Central Counterparty (CCP) are excluded from CVA Charge calculations.

7.8.1 Assumptions

CVA hedge should be identified by the clients separately. Only single name CDS and Index Hedge are eligible for CVA. The Basel III Accord does not clearly mention whether index hedge position should be marked to the counterparty or not. The Basel Regulatory Capital application handles the index position in the following manner:

Both index position marked to the level of counterparty or not marked to the level of counterparty is handled by the application.

Effective index hedge amount is considered in the CVA charge calculation at portfolio level without considering whether it is marked to the counterparty or not.

If the index position is marked to the counterparty, then index hedge amount is considered while allocating total CVA charge to the counterparty CVA Charge, while using Standardized Approach.

7.8.2 Process Flow for Credit Valuation Adjustments

This process flow is divided into two sections, for Simple Approach and Advanced Approach.

Simple Approach

The application calculates CVA capital charge at portfolio level using the following formulae as specified by Basel guidelines:

$$K = 2.33 \cdot \sqrt{h} \cdot \sqrt{\left(\sum_i 0.5 \cdot w_i \cdot (M_i \cdot EAD_i^{total} - M_i^{hedge} B_i) - \sum_{ind} w_{ind} \cdot M_{ind} \cdot B_{ind} \right)^2 + \sum_i 0.75 \cdot w_i^2 \cdot (M_i \cdot EAD_i^{total} - M_i^{hedge} B_i)^2}$$

Figure 43: Process flow for credit valuation

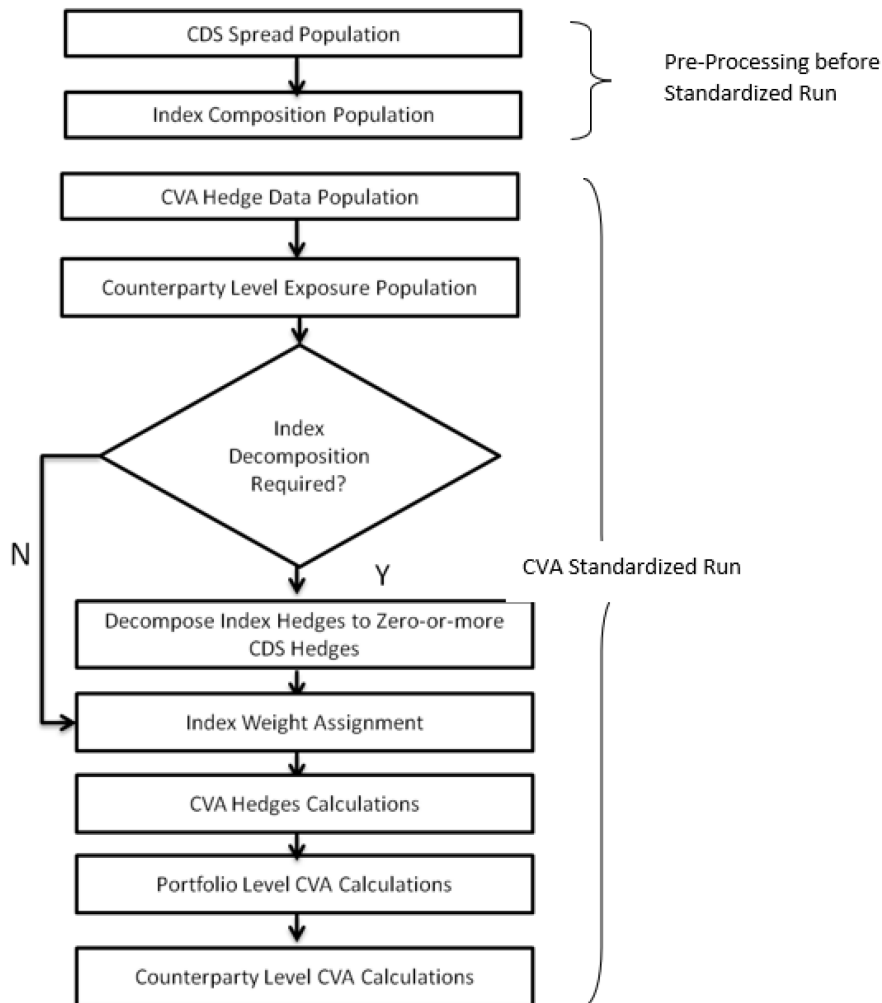

CDS Spread Population and Index Composition Population

Pre-processed data for CVA is required to be populated only once for a particular execution date. The process CVA_DATA_POPULATION in the Run Staging Data Population - BIS Credit Value Adjustment is responsible for populating pre-processed data for CVA.

CVA Hedge Data Population

Mitigants data marked as CVA Hedge is populated as a part of the CVA Hedge Data Population. The application loads all the single name CDS hedge and index hedge data. The hedge data marked as CVA does not flow in the application during the CCR process. New tables are not added for hedge records;

however, a few columns are added to the existing table to capture CVA specific data. CVA specific data is present in the following tables:

F_CVA_HEDGE: Identifier for CVA Hedge records by which the application identifies it as CVA Hedge.

N_CDS_INDEX_AVG_SPREAD: Average traded CDS Index Spread which is required for assignment of weight to the index.

V_REF_ENTITY_PARTY_ID: This field captures the counterparty of the hedge transaction.

Counterparty Level Exposure Population

The application expects the uncovered EAD at netting agreement level or at trade level. This is available as an output of Current Exposure Method (CEM). If more than one netting agreement is available, then the exposures are summed at counterparty level. These aggregated data is stored in FCT_REG_COUNTERPARTY_CVA table using COUNTERPARTY_EXPOSURE_POPULATION T2T.

Maturity adjustment discount factor is computed at netting agreement level or for each netting agreement using the formula $1 - \exp(-0.05 * Mi) / (0.05 * Mi)$.

Maturity is the notional weighted maturity at netting agreement level. The application sums the data for exposure at counterparty level. If more than one netting agreement is available, the exposures are discounted and then summed at counterparty level. Weight assignment is done based on the counterparty rating as specified in the following table. Data is aggregated at counterparty level and stored in separate counterparty table.

Table 44: Weight Risk Weight assignment based on counterparty rating

Rating	Weight
AAA	0.7%
AA	0.7%
A	0.8%
BBB	1.0%
BB	2.0%
B	3.0%
Lower Than B	10.0%
Unrated	1.0%

Index Decomposition Required

You can select index decomposition which is executed in the Run Management window. Index decomposition option creates single name CDS hedge positions for the counterparties which are part of the CDS Index and also have exposures. Index hedge amount is adjusted by the same amount for which single name CDS hedge is created, so as to get maximum benefit from hedging. Maturity of the single name CDS hedge is considered same as the maturity of index.

Index Weight Assignment

The application derives the weight for each index by assigning rating. Rating is assigned by comparing the historical average spread of index with spread corresponding to the tenor, which is equal to the maturity of index. After acquiring the rating, assign the weights to the index as per the reference table (weights table). Average index spread and credit spread data for different ratings are the inputs. Index spread is populated as a part of mitigants data. Credit spread data for respective ratings and tenors are required as inputs.

CVA Hedge Calculations

After population of hedge data and creation of single name CDS hedge from the index, the application sums the notional to counterparty level and populates in CVA Specific table. Maturity Adjustment discount factor is computed using the formula $(1 - \exp(-0.05 * M_i^{\text{hedge}})) / (0.05 * M_i^{\text{hedge}})$. If more than one CDS Contract is available for the counterparty, the amount is summed at counterparty level. The Index Hedge amount is calculated separately. Maturity Adjustment discount factor for index position is computed using the formula $(1 - \exp(-0.05 * M_{\text{ind}})) / (0.05 * M_{\text{ind}})$. If more than one index hedge is available, then index hedge amount is summed. All the data required for CVA calculation is populated from Mitigants data to CVA specific table. The data is summed for every counterparty and stored.

Portfolio Level CVA Calculation

Portfolio Level CVA Charge is calculated as per the following formula:

$$K = 2.33 \cdot \sqrt{h} \cdot \sqrt{\left(\sum_i 0.5 \cdot w_i \cdot (M_i \cdot EAD_i^{\text{total}} - M_i^{\text{hedge}} \cdot B_i) - \sum_{\text{ind}} w_{\text{ind}} \cdot M_{\text{ind}} \cdot B_{\text{ind}} \right)^2 + \sum_i 0.75 \cdot w_i^2 \cdot (M_i \cdot EAD_i^{\text{total}} - M_i^{\text{hedge}} \cdot B_i)^2}$$

The CVA charge calculated at portfolio level is populated in the FCT_REG_CVA_SUMMARY table. Single Name CDS Hedge component for CVA at portfolio level is calculated and the summary table is populated using CVA_SUMMARY_POPULATION T2T.

Counterparty Level CVA Calculation

CVA Capital Charge at counterparty level is allocated using the following formula:

CVA at Counterparty = Total CVA at Portfolio *WCVAi

Where,

WCVAi = Absolute [0.5*Wi *(Mi * EADitotal - Mi^{hedge} * Bi) - Σ_{indi}(W_{ind} * M_{ind} * B_{ind})]/

ΣniAbsolute[0.5*Wi * (Mi * EADitotal - Mi^{hedge} * Bi) - Σ_{indi}(W_{ind} * M_{ind} * B_{ind})]

Advanced Approach:

Figure 45: Expected exposure data population

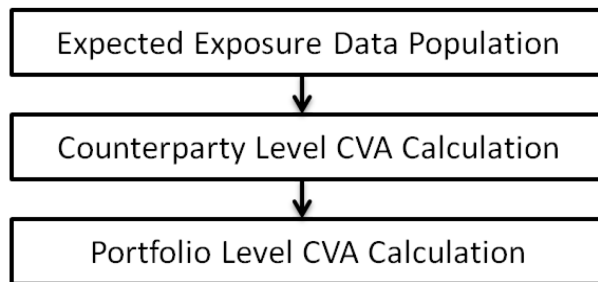

Expected Exposure Data Population

The data requirement which is required as input for calculation of CVA Charge using Advance Approach is as follows:

$$CVA = (LGD_{MKT}) \cdot \sum_{i=1}^T \text{Max} \left(0; \exp \left(-\frac{s_{i-1} \cdot t_{i-1}}{LGD_{MKT}} \right) - \exp \left(-\frac{s_i \cdot t_i}{LGD_{MKT}} \right) \right) \cdot \left(\frac{EE_{i-1} \cdot D_{i-1} + EE_i \cdot D_i}{2} \right)$$

LGD_{MKT} : This is the LGD of the counterparty based on the spread of a market instrument of the counterparty. It should be based on market assessment and not an internal estimate. LGD Market should be an input for every counterparty.

S_i : This is the credit spread of the counterparty at each tenor T_i , which is used to calculate CVA of the counterparty. Spread data is an input for each counterparty and tenor level.

T_i : This is the tenor at which the Expected Exposure (EE) and spread are provided. Tenor is an input for each EE and spread.

EE_i : This is the expected exposure (EE) of the counterparty at revaluation time t_i where exposures of different netting agreements of counterparties is added. Expected exposure is an input at each counterparty and tenor level.

D_i : This is the default risk free discount factor for each revaluation time bucket. Default risk free rate is an input for each counterparty and tenor t_i .

Counterparty Level CVA Calculation

CVA RWA calculation at counterparty level is computed by the following formula:

$$CVARWA = 12.5 \cdot K$$

Where K = CVA capital charge calculated as per formula specified in Standardized or Advanced method for each counterparty.

The application calculates the CVA Charge at counterparty level using the below formula for two different scenarios:

Expected Exposure calculated with Current Market Data.

Expected Exposure calculated with Stressed Market Data.

$$K = 3 \cdot (CVA_{Unstressed} \text{ VAR} + CVA_{Stressed} \text{ VAR})$$

The application calculates the CVA Charge at counterparty level using this formula, for every counterparty, and sums the CVA charge for all counterparties to compute portfolio level capital charge.

The CVA charge calculated at portfolio level is populated in the FCT_REG_CVA_SUMMARY table.

These aggregated data is stored in FCT_REG_COUNTERPARTY_CVA table using COUNTERPARTY_EXPOSURE_POPULATION T2T.

Portfolio Level CVA Calculation

CVA RWA calculation at portfolio level is computed using the following formula:

$$\text{CVARWA} = 12.5 * K$$

Where K= CVA capital charge calculated as per formula specified in standardized or advanced method at portfolio level.

CVA RWA is added to Credit RWA and is not multiplied by the factor 1.06.

7.8.2.1 Key Data Elements

Key data elements are provided in this section for computation for Credit Valuation Adjustment. For a complete list of tables and columns to be updated, see the Download Specifications document.

CDS Index Composition data requirement.

CDS Spread data for Rating and Tenor.

Average Index Spread for all the Index Hedge Position.

7.8.2.2 Out of Scope

The following is not covered by the application in the computation of Credit Valuation Adjustment:

Treatment of specific wrong way risk.

Treatment of incurred CVA loss

7.9 Operational Risk Portfolio

Operational risk is a risk of loss resulting from inadequate or failed internal processes, people and systems, or external events". External Losses can occur due to Misappropriation of Assets, Tax Evasion, Theft of information, hacking damage or Third-party theft or forgery. The Capital Adequacy guidelines prescribed by BIS has prescribed three methods for calculating Operational Risk capital charges and banks can use any of these methods to calculate capital charge:

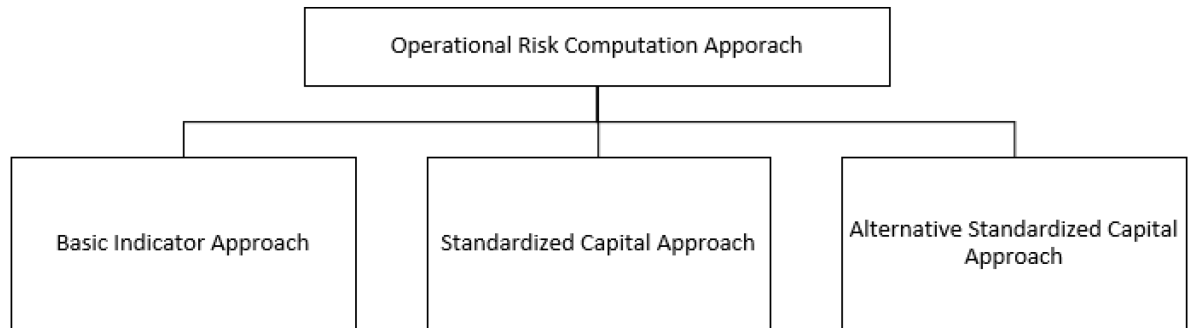
Figure 46: Operational Risk Computation Approach

When executing Solo Run for computing Operational Risk, the parent entity data is processed. However, for a Consolidated Run the parent entity and the subsidiary data are processed.

Process Flow for Operation Risk RWA

Figure 47: Process Flow for Operation Risk RWA

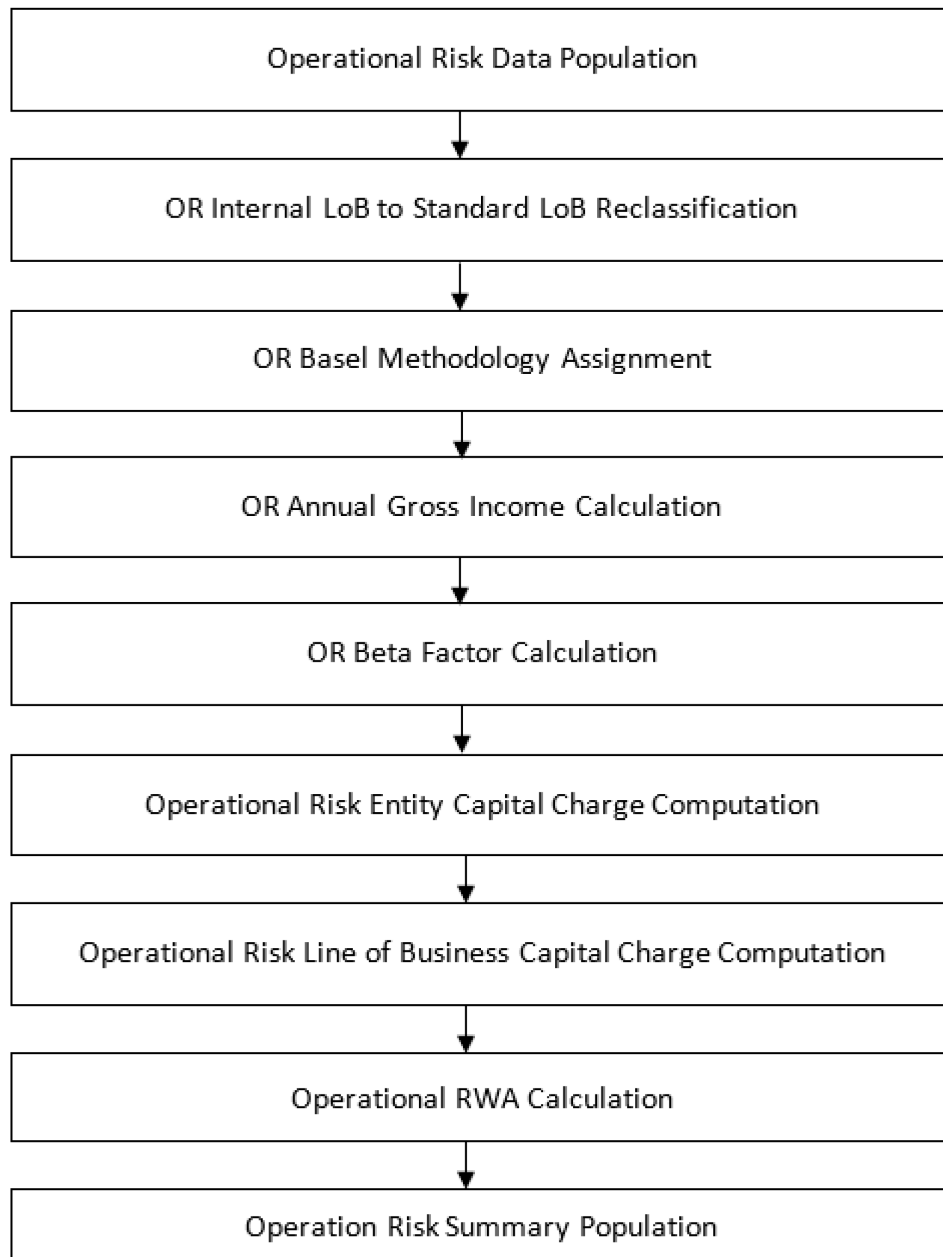

7.9.1 Data Population

The data required for the Operational Risk RWA calculations are part of the Stage Operational Risk Data (STG_OPS_RISK_DATA). This is the entity level information for various operational attributes related to the entities and the Lines of business.

All the other data related to entities, as detailed in the Capital Structure and Common section will have to be provided, to help in the identification of whether the entities are part of consolidation or not.

This is handled in the rule **OPS_RISK_DATA_POPULATION**

7.9.2 Shareholding Percent Multiplication

For all the entities, which are part of regulatory consolidation and parent shareholding percentage is required is getting updates the shareholding percentage against each entity data. These details are captured in the Stage Entity Shareholding Details (STG_ENTITY_SHR_HLD_PERCENT) table. And using the shareholding percentage applicable for the entity, based on the solo or consolidation level, all the amount columns are multiplied by the corresponding shareholding percent.

This is handled in the Rules:

- a. OR Operating Income and Expense shareholding Percent Multiplication
- b. Shareholding Percent Multiplication of Balance sheet Attribute for Operational Risk
- c. OR Non-Operating Income and Expense shareholding Percent Multiplication
- d. OR Other Income and Expense shareholding Percent Multiplication
- e. OR Other Income and Expense shareholding Percent Multiplication

7.9.3 Reclassification Rules

In the case of Operational Risk, the key reclassification rules are with respect to the entity type, which is based on the party type reclassification as detailed in the Credit risk section. The other relevant reclassification rules are the ones for the LOB Reclassification.

7.9.3.1 Line of Business Reclassification

- The internal lines of business, as maintained by the bank, are reclassified into Basel standard lines of business, as provided by the regulator for calculation of the operational risk.
- This is handled in the rule OR Internal LoB to Standard LoB Reclassification

7.9.4 Capital Charge Approaches

As part of the approaches suggested by the regulator for Operational Risk, the bank can follow one of the approaches, based on the supervisory approval, and bank meeting the operational requirements to comply with these guidelines:

- **Basic Indicator Approach**
- **Standardized Approach**
- **Alternative Standardized Approach**

7.9.4.1 Basic Indicator Approach

7.9.4.1.1 Capital Charge Calculation

Capital charge is calculated by multiplying the alpha value with the annual gross income of each year across each standard line of business. The average of 3 years is considered by the application, in sync with

the regulatory ask. If the values of all the 3 years are not positive, then zero or the negative value from numerator and denominator is excluded.

In this approach, the alpha value is a fixed value set by the regulator.

This is handled in the rules `Opr_Risk_Capital_Charge`

7.9.4.1.2 Risk-Weight Asset Calculation

The capital charge value obtained is converted to the equivalent RWA value by multiplying with the factor of 12.5.

Operational Risk-Basic Indicator Approach - Data Population

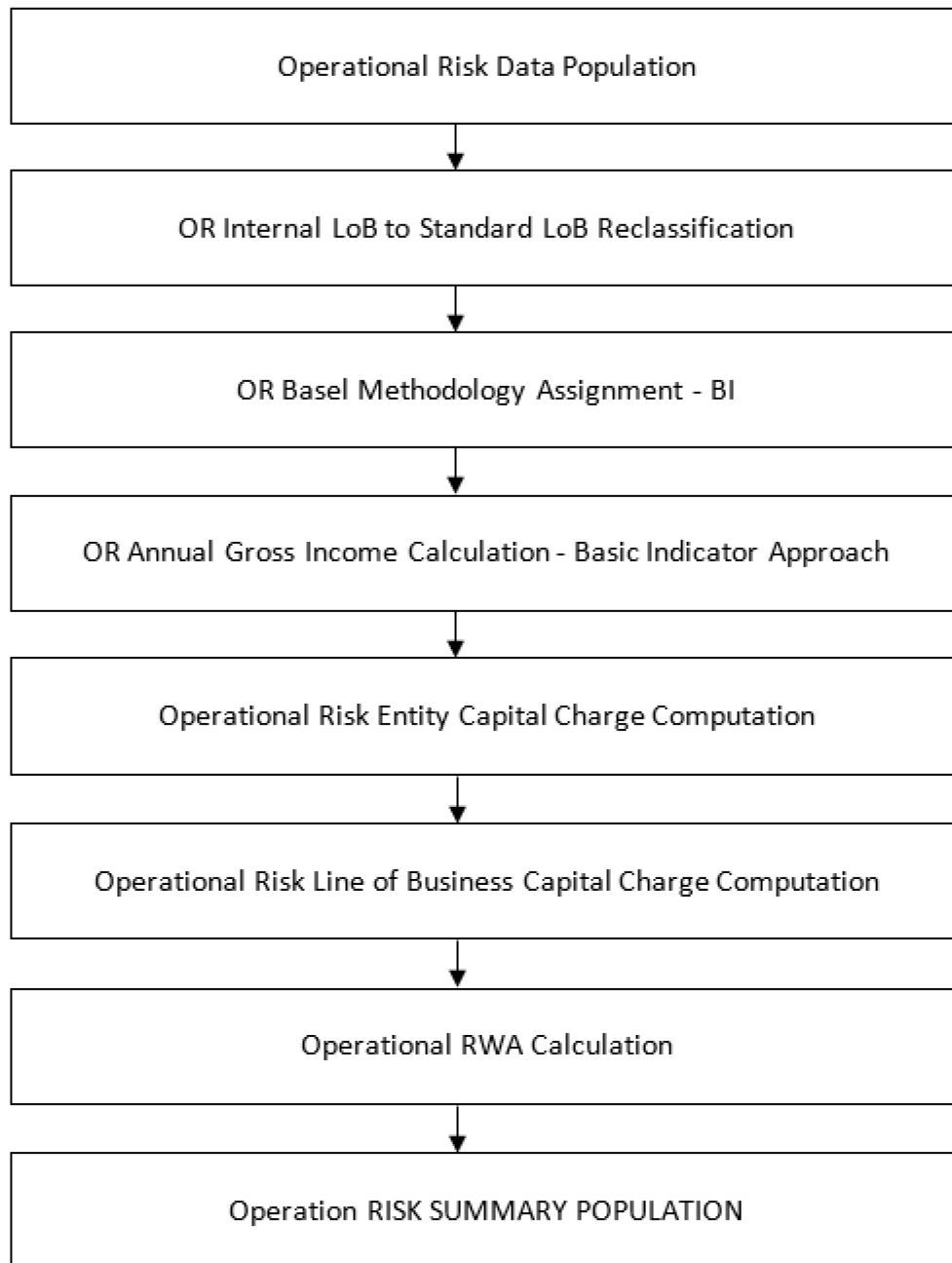
Figure 48: Operational Risk Data Population**7.9.4.2 Standardized Approach**

In this approach, the LOB reclassification is expected to reflect the relevant LOB provided by the regulator.

7.9.4.2.1 Capital Charge Calculation

Capital charge is calculated by multiplying the beta value with the annual gross income of each year across each standard line of business. The average of 3 years is considered by the application, in sync with the regulatory ask. If the values of all the 3 years are not positive, then zero or the negative value from numerator and denominator is excluded.

In this approach, the beta value is a fixed value set by the regulator, for each of the individual Lines of business.

This is handled in the in rule

Operational Risk Entity Capital Charge Computation

Operational Risk Line of Business Capital Charge Computation

7.9.4.2.2 Risk-Weight Asset Calculation

The capital charge value obtained is converted to the equivalent RWA value by multiplying with the factor of 12.5.

Operational Risk-Standardized Approach - Data Population

Figure 49: Operational Risk Data Population

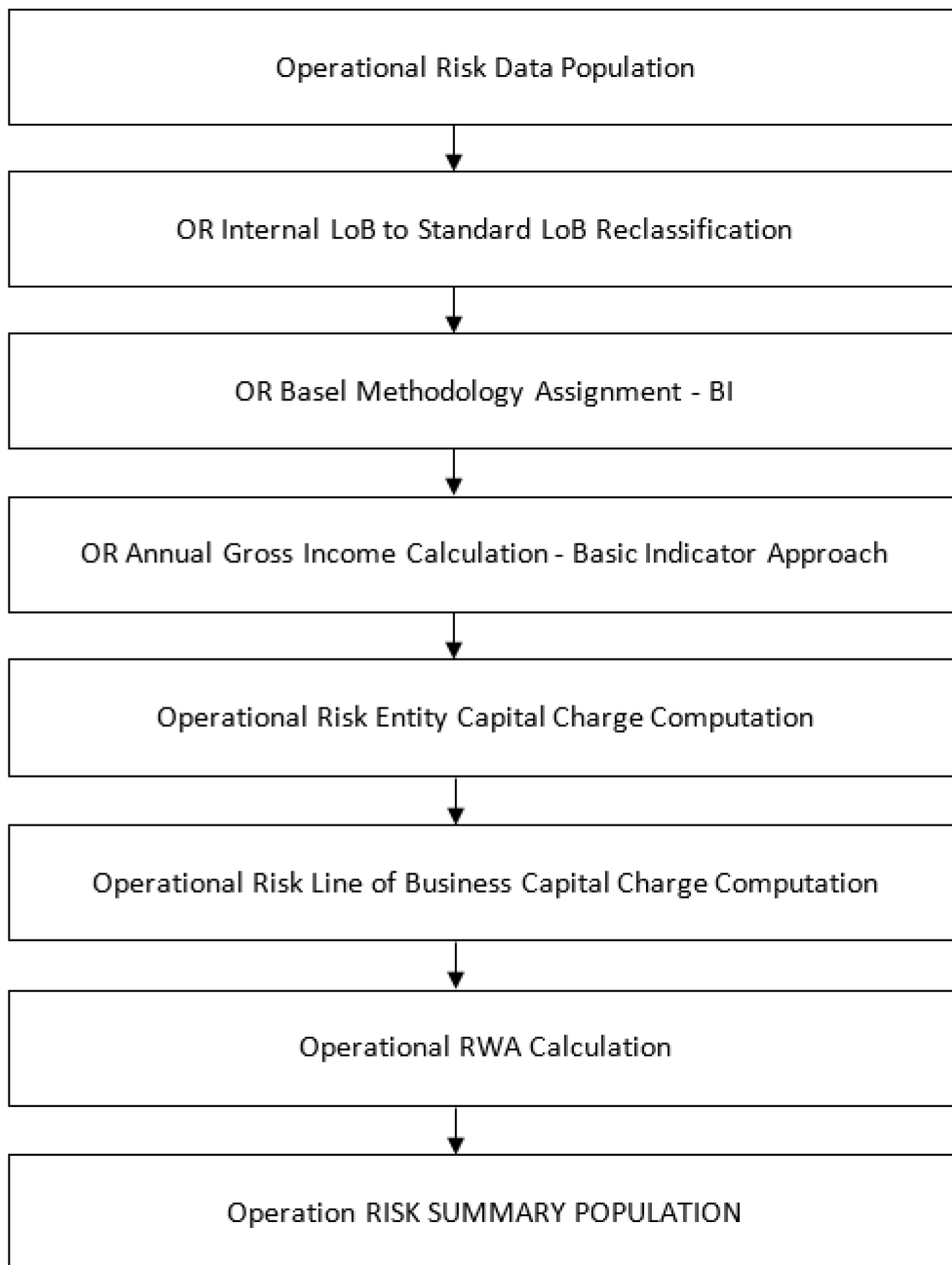

7.9.4.3 Alternative Standardized Approach

This approach is an extension of the standardized approach. In this approach for two lines of business: Retail Banking and Commercial Banking, the loan and advance amount is used (rather than annual gross income) which is multiplied by the fixed factor “m” and the beta factor.

7.9.4.3.1 Capital Charge Calculation

Capital charge is calculated by multiplying the beta value with the gross income specified for each of the LOB, for each year across each standard line of business. The average of 3 years is considered by the application, in sync with the regulatory ask. If the values of all the 3 years are not positive, then zero or the negative value from numerator and denominator is excluded.

In this approach, the beta value is a fixed value set by the regulator, for each of the individual Lines of business, and they are also being multiplied by the fixed factor of m.

This is handled in the rule OR_Capital_Std_App.

7.9.4.3.2 Risk-Weight Asset Calculation

The capital charge value obtained is converted to the equivalent RWA value by multiplying with the factor of 12.5.

Figure 50: Operational Risk – Alternative Standardized Approach - Data Population

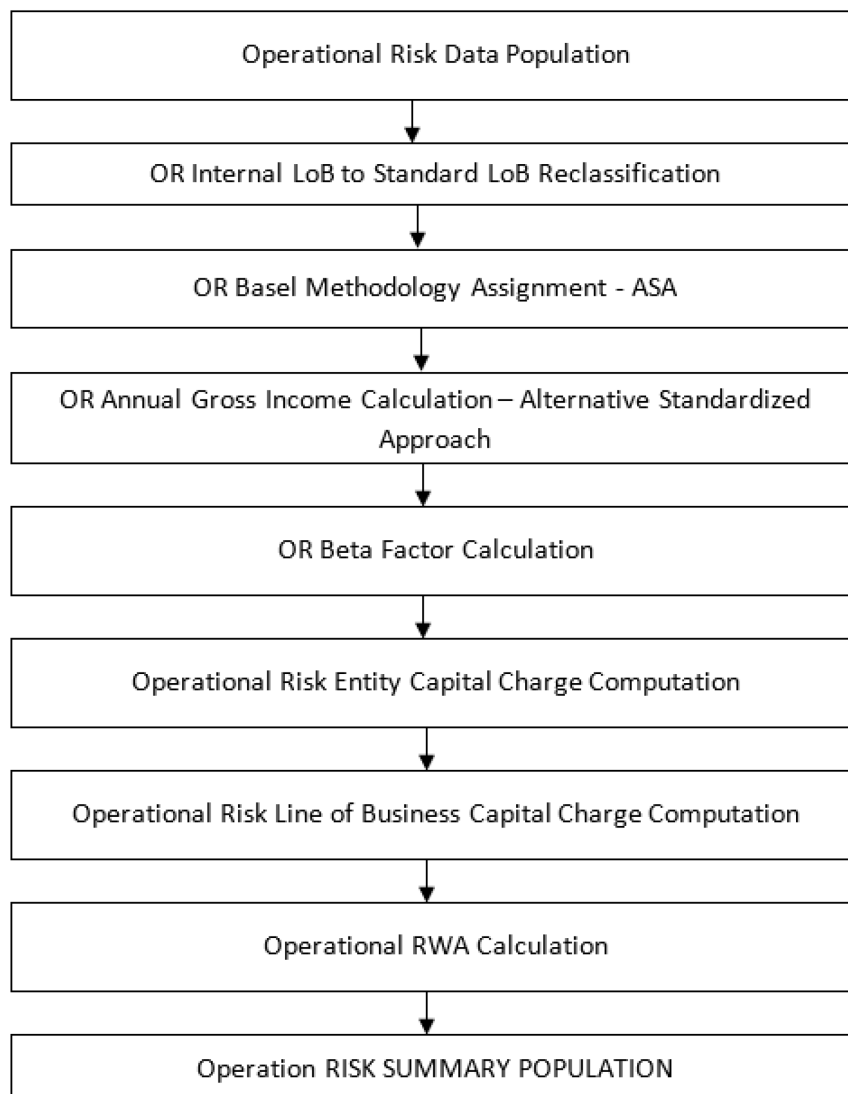

7.9.5 Key Data Elements

Key data elements that noted while calculating the capital charge for OR for the consolidated entity.

To view the complete list of tables used for Operational Risk computation, see the Download Specification document.

Entity details, which are part of regulatory consolidation and parent entity shareholding percent is required. These details are captured in the Stage Entity Shareholding Details (STG_ENTITY_SHR_HLD_PERCENT) table.

Net Interest Income, Net Provision Amount, Net Non-Interest Income, Operating Expenses, Security Sale Gain or Loss from HTM, Insurance Irregular Loss, Security Sale Gain or Loss from AFS, and Insurance Irregular Gain for each line of business and for each financial year is required.

7.10 Capital Structure

Figure 51: Process flow of capital structure

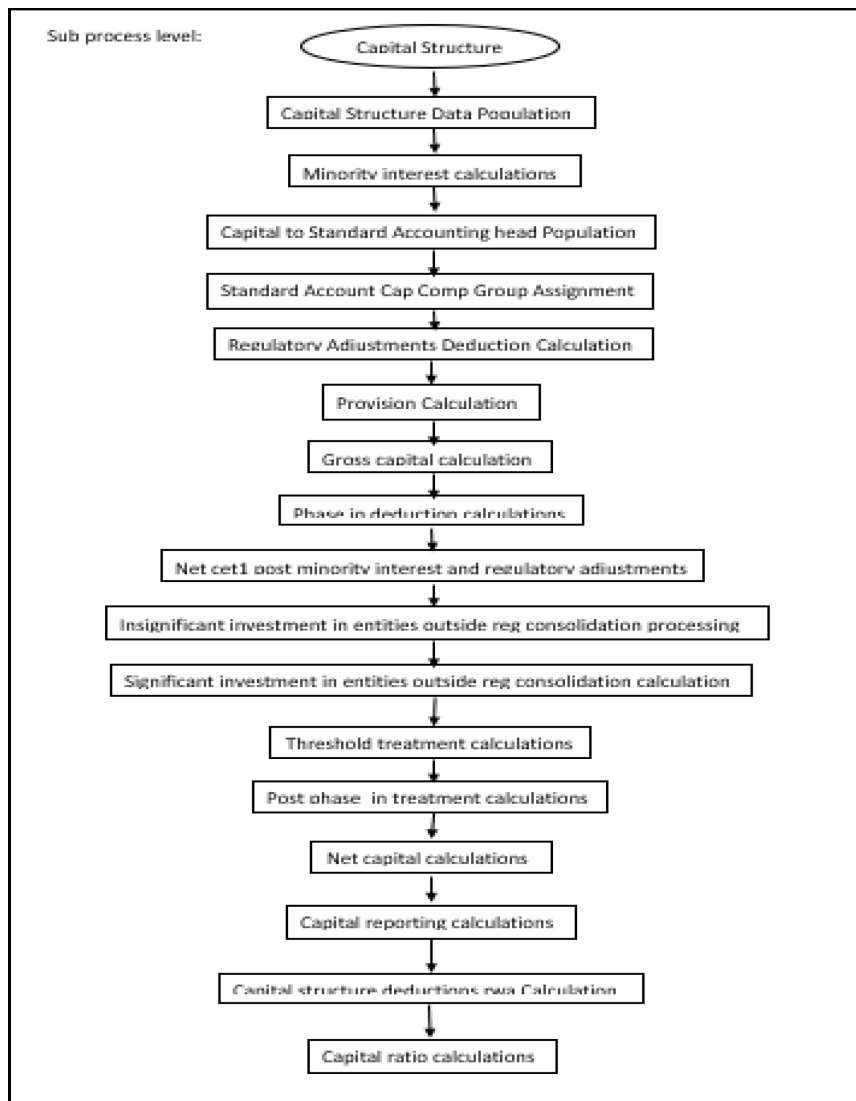

As per the new definition in the Basel III accord, total capital consists of sum of the following elements:

1. Tier1 Capital, which comprises of the following components,
 - Common Equity Tier 1
 - Additional Tier 1
2. Tier 2 Capital

Each component of capital is subject to restrictions where CET1 must be at least 4.5% of total risk-weighted asset. Tier 1 capital must be at least 6.0% of total risk-weighted asset. Total capital must be 8.0% of total risk-weighted asset. Each component of capital undergoes minority interest and regulatory adjustments. The minority interest is applicable for a consolidated entity only, during the consolidation run. Most of the regulatory adjustment line items are to be deducted from CET1.

All the regulatory adjustment line items follow a phase-in arrangement from the beginning of 2014 till 2017.

In particular, the regulatory adjustments begin at 20% of the required adjustments to Common Equity Tier 1 on 1 January 2014, 40% on 1 January 2015, 60% on 1 January 2016, 80% on 1 January 2017, and reaches 100% on 1 January 2018. The same transition approach applies for all deductions from additional Tier 1 and Tier 2 capital.

While executing Solo Run the parent entity data is processed. Investment into the subsidiary data is processed as per Credit Risk and Market Risk rule. Capital line item pertaining to parent entity is only processed.

While executing Consolidation Run, the parent entity and the subsidiary data is considered.

7.10.1 Assumption

Investments in accounting entities (which are outside the scope of regulatory consolidation) by parent bank are long-term investments and mostly equity related instruments, hence these investments are not processed for Credit Risk Mitigation.

The GL codes are expected to be unique across entities in Stage General Ledger Data (STG_GL_DATA) and Capital Accounting Head Dimension (DIM_CAPITAL_ACCT_HEAD).

7.10.2 Data Population

Exposure level input for capital structure will flow from different stage portfolio tables.

Along with the portfolio level stage tables, application uses these below table,

Stage GL DATA (STG_GL_DATA), Stage GI master (STG_GL_MASTER), Stage Party Share Holding Percentage (STG_PARTY_SHR_HLD_PERCENT), Stage Entity Share Holding Percentage (STG_ENTITY_SHR_HLD_PERCENT), Dim Organization Structure (DIM_ORG_STRUCTURE), Stage Standard Accounting Head (STG_STANDARD_ACCT_HEAD), Stage Legal Entity Details (STG_LEGAL_ENTITY_DETAILS), FSI_SETUP_CAPITAL_SOURCE (In this table application stores the CAPID details for example the capital component group or if it is eligible for transition), FSI_SETUP_CAPITAL_HEAD (In this table application stores all the seeded ratios as per regulatory guidelines).

7.10.3 Shareholding Percent Multiplication

Based on the share-holding percentage of the parent bank in the subsidiary and the consolidation approach to be followed for each of the entity, the Basel approach is selected.

For example: if the shareholding for an entity is 35% and is part of the consolidation process, then the approach selected for this entity is pro-rata consolidation. The reclassification is performed in task – ‘Basel III Capital Consolidation Basel Approach Type Reclassification for an Entity’ in the process **‘CAPITAL_CONSOLIDATION AND PARAMETER ASSIGNMENT’**.

The entity level population is part of BIS Common Data Processing (PMFCOM020) process. The application updates the shareholding percentage against each entity common data in the fact capital accounting head from the fact entity shareholding percent table and update the capital accounting head amount multiplying with the shareholding percent of that particular entity. The parent data in the processing table of fact capital accounting head is updated with the value 1 and for each child entity, the data is based on the parent’s holding percentage specified for each child in fact entity shareholding percent table.

7.10.4 Common Reclassification Rules

There is certain reclassification which are specific to the capital structure process – standard accounting head reclassification, and entity type reclassification.

- **Capital to Standard Accounting Head Reclassification:**

This is the reclassification of the Capital accounting head to standard accounting head. In this, all the Capital accounting heads of the bank need to be reclassified into the Standard Accounting Head, as that is the one which is being consumed in the application. This happens in the COMMON_RECLASSIFICATION (PMFCOM005) sub-process process in Common Data Processing (PMFCOM006).

- **Entity Type Reclassification:**

The entity type reclassification is also handled as part of the Party Type reclassification since there cannot be difference in the party type and entity type.

This happens in the BIS Other Reclassification (PMFCOM010) process.

- **Product to Capital Component Group Reclassification:**

This reclassification of the product to the capital component group is based on the Basel Product type, and this is handled at the individual portfolio tables of Investments and Derivatives. For investments this happens in the process INV_CAPITAL_STRUCTURE_RECLASSIFICATION_STD (PMFINV005) and for derivatives this happens in the DRV_RECLASSIFICATION_STD (PMFDRV012) in the process.

7.10.5 Gross Capital Calculations

For Gross Capital calculation all the components are classified into their respective tiers (CET1, AT1, and T2) based on the standard accounting head, and the specifications as mentioned by the regulator. The total gross capital for each tier of capital (CET1, AT1, and T2) is calculated as per the definition of CET1, AT1, and T2 by adding the relevant financial instrument in each tier of capital. This is processed using

GROSS_CAPITAL_CALCULATIONS (PMFBISCS006) sub processes in Capital Structure Data Processing (PMFBISCS021) process.

7.10.6 Minority Interest Calculations

Surplus of Minority Interest

Minority Interests are calculated and the surplus amount in each tier of capital, which is attributed to third parties, are deducted from the gross capital of each tier of capital.

Minority interest is the amount that is attributable to any other party, which is not part of the bank's entities, and have shareholding in the entity. The surplus of minority interest is calculated as the third party's interest (shareholding percent) in the surplus capital (available capital – minimum required capital).

- All the values required for processing are populated into Minority Interest Capital (**FSI_MINORITY_INTEREST**) table which is the processing table for minority interest calculations.
- The sub process – MINORITY_INTEREST_CALCULATIONS (PMFBISCS001) in Capital Structure Data Processing (PMFBISCS021) process covers this processing.
- The minority interest is deducted from the gross capital of each tier of the capital.

7.10.7 Internal Transactions Deduction

The deduction also includes internal transactions in each tier of capital among the various entities which are part of the regulatory consolidation. This is to ensure that there is no double counting of exposures. This is handled in the process CAPITAL_STANDARD_ACCOUNTING_POPULATION (PMFBISCS002).

7.10.8 Regulatory Adjustments & Deductions from Each Tier of Capital

All the regulatory adjustment line items are expected as download in the Stage General Ledger Data table (STG_GL_DATA). Some of these line items are good will, Other Intangibles, Deferred Tax Assets, Cash flow hedge reserve and so on. The related deferred tax liabilities are also expected to be provided as a download. The application calculates the values net of DTL and then processes it for the Regulatory Adjustments. The detailed list of these line items is part of the FSI Setup Capital Source (FSI_SETUP_CAPITAL_SOURCE) table.

The sub process – REGULATORY_ADJUSTMENTS_DEDUCTION_CALCULATION (PMFBISCS004) and PROVISION_CALCULATION (PMFBISCS005) in Capital Structure Data Processing (PMFBISCS021) process handle this requirement.

7.10.9 Certain Deductions part of Corresponding Deduction Approach

There are certain deductions which are expected to be part of each of the tier of capital. And they follow the corresponding deduction approach, wherein the deduction of the line item happens in the same tier of capital to which the exposure belongs to. This is being mostly pulled from the relevant

7.10.9.1 Investment in Own Shares

The investment in own shares is calculated as the sum of the pre-mitigation EAD (EAD Pre-mitigation Measure Value (**N_EAD_PRE_MITIGATION**)). The source for investment in own share is the individual portfolio table.

The source for non-Sec exposures is FSI Cap Investment Exposures (FSI_CAP_INVESTMENT_EXPOSURES), and FSI Cap Derivative Exposures (FSI_CAP_DERIVATIVES). The process where this is being handled is Capita Structure Data Processing (PMFBISCS021).

This populates into the Fact Calc accounting head (fct_calc_acct_head). This is being populated for each of the respective tier of capital.

The Investment in own shares is being calculated in the task INV_DRV_DEDUCTION_CALC_ACCT_HEAD_DATA_POP in Capital Structure Data Population (PMFBISCS019) process.

This also goes for phase in calculations, which is being handled in the PHASE_IN_DEDUCTION_CALCULATIONS (PMFBISCS007) process.

7.10.9.2 Reciprocal Crossholdings

The Investment in reciprocal crossholdings are calculated as the sum of the pre-mitigation EAD (EAD Pre-mitigation Measure Value) (N_EAD_PRE_MITIGATION) in FSI Cap Investment Exposures (FSI_CAP_INVESTMENT_EXPOSURES), and FSI Cap Derivative Exposures (FSI_CAP_DERIVATIVE) of the exposures which have the flag of reciprocal cross-holding indicator (F_RECIPROCAL_CROSS_HLDG_IND) as “Y”.

For this processing, the reciprocal amount is expected as a download in the Stage Capital Investments Position Table (STG_CAP_INVESTMENTS_POSITIONS) at an instrument level. The instrument code provided in this table is the instrument in which the reporting bank has invested, and for which there is a reciprocal crossholding by the reporting bank. The reciprocal cross-holding amount is also captured in this table. The application expects the staging data of the exposures to have the reciprocal cross-holding indicator (F_RECIPROCAL_CROSS_HLDG_IND) as ‘Y’.

The application uses this INV_DRV_DEDUCTION_CALC_ACCT_HEAD_DATA_POP task in Capital Structure Data Population (PMFBISCS019) process to populate into the Fact Calc accounting head (FCT_CALC_ACCT_HEAD). This is being populated for each of the respective tier of capital.

This also goes for phase in calculations, which is being handled in the PHASE_IN_DEDUCTION_CALCULATIONS (PMFBISCS007) process.

And finally, the adjusted amount after deductions it goes back to the exposure level,

which is being handled in the CAPITAL_STRUCTURE_DEDUCTIONS_RWA_EXPOSURES (PMFBISCS022) from the process Capital Structure Data Processing (PMFBISCS021).

The exposure that meets the reciprocal cross-holding amount is stamped with the reciprocal cross-holding indicator (F_RECIPROCAL_CROSS_HLDG_IND) as ‘Y’. This will be reduced in all the amount columns in FSI Cap Investment Exposures (FSI_CAP_INVESTMENT_EXPOSURES), and FSI Cap Derivative Exposures (FSI_CAP_DERIVATIVES) as per the reciprocal cross-holding ratio and store the actual amounts in FSI CAP DEDUCTION EXPOSURE table (FSI_CAP_DEDUCTION_EXPOSURES).

The portion of the exposure, which is above the reciprocal cross-holding amount is treated as a regular exposure and is risk-weighted as per the Basel asset class for that instrument.

7.10.9.3 Insignificant Investment

Investment in all financial entities, which are outside the scope of regulatory consolidation, is identified for significant and insignificant investments.

The shareholding percent for these parties are expected as download in Stage Party Shareholding Percent table (**STG_PARTY_SHR_HLD_PERCENT**). Any party which part of the Org Structure is, but is not part of the regulatory consolidation, can also qualify for this treatment, if it is financial entity. If the entity is part of the Org structure, the shareholding percent is expected in the Stage Entity Shareholding percent table (**STG_ENTITY_SHR_HLD_PERCENT**).

The parties are identified as significant when the shareholding percentage is greater than or equal to 10%. And the others are identified as insignificant investment. This processing happens in the **PARTY_SHAREHOLDING_PERCENT** process.

The total investment amount in insignificant entities is computed by summing up the Pre-mitigation EAD (EAD Pre-mitigation Measure Value (N_EAD_PRE_MITIGATION)) from the portfolio tables FSI Cap Investment Exposures (FSI_CAP_INVESTMENT_EXPOSURES), and FSI Cap Derivative Exposures (FSI_CAP_DERIVATIVES). And, the tier wise computation of investment amount happens. The total amount is compared with the 10% of the CET1 amount of the parent bank amount post regulatory adjustments. The amount above 10% limit is processed for deduction.

This summing up includes the direct, indirect, and synthetic investments. The Indirect investments are investments in Investment funds, and which are invested in capital instruments. The synthetic investments are the investments in synthetic transactions on capital instruments. For all these exposures, the net long position amount, updated in **N_EAD_PRE_MITIGATION** is considered.

This is expected for all capital positions, and not for specific capital position.

The total deduction amount is pro-rated among each tier of capital based on the percentage of investment in each tier of capital. The amount arrived is deducted from each tier of Capital.

The investment amount below the 10% limit is treated as per banking book rule for the instrument.

The application computes as follows:

Parties are marked as insignificant investment parties by updating the flag: Significant Entity Indicator (**F_SIGNIFICANT_INVESTMENT_IND**) in Fact Party Shareholding Percent (**FCT_PARTY_SHR_HLD_PCT**) with value N, and **F_SIGNIFICANT_INVESTMENT_IND** in Fact Entity Info (**FCT_ENTITY_INFO**) with value N.

- The exposure amount of banking book and trading book exposures (any counterparty credit risk exposures) to these entities are summed by grouping their component of capital and compared against 10% of parent bank's CET1 capital. The portion of amount which exceeds the 10% limit is deducted.
- This is computed by calculating tier wise deduction percentage and multiplying this percentage with the exposure amount to arrive at the amount to be deducted from each tier of capital.
- The total investment values are populated into Non-Regulatory Consolidation Entity Investment (**FSI_NON_REG_CONSL_ENTITY_INVST**) table which is the processing table for insignificant and significant investment deductions.
- The sub process –
INSIGNIFICANT_INVESTMENT_IN_ENTITIES_OUTSIDE_REG_CONSOLIDATION_PROCESSING (PMFBISCS010) in Capital Structure Data Processing (PMFBISCS021) covers the processing.
- After the application of this treatment, the Insignificant Investments line item also follow phase-in arrangement which is similar to the phase-in arrangement for Regulatory Adjustments.

7.10.9.4 Significant Investment

The total investment amount is checked against the set limit of 10% of CET1 amount of the parent bank, post insignificant investment amount adjustment. The CET1 amount above 10% is deducted from the CET1 post insignificant investment amount deduction. The CET1 amount below 10% follows threshold deduction. The investment amount in AT1 and T2 is fully deducted from its respective AT1 and T2 tier of capital. The application computes as follows:

Entities are marked as significant investment entities by updating the flag – Significant Entity Indicator (**F_SIGNIFICANT_INVESTMENT_IND**) in Fact Party Shareholding Percent (**FCT_PARTY_SHR_HLD_PCT**) with value Y and Significant Entity Indicator (**F_SIGNIFICANT_INVESTMENT_IND**) in Fact Entity Information (**FCT_ENTITY_INFO**) with value 'Y'.

The exposure amount of banking book and trading book exposures (any counterparty credit risk exposures) to these entities are summed by grouping their component of capital and compared against 10% of parent bank's CET1 capital. The portion of amount which exceeds the 10% limit is deducted from CET1. The exposures of AT1 and T2 are fully deducted from respective tier of capital. This is done by calculating deduction percentage for CET1 and by multiplying this percentage with the CET1 exposure's exposure amount to arrive at the amount to be deducted from CET1 capital.

The sub process –

SIGNIFICANT_INVESTMENT_IN_ENTITIES_OUTSIDE_REG_CONSOLIDATION_PROCESSING (PMFBISCS011) in Capital Structure Data Processing (PMFBISCS021) covers the processing.

After the application of this treatment, the Significant Investments line item also follow phase-in arrangement which is similar to the phase-in arrangement for Regulatory Adjustments.

7.10.10 Threshold Deduction Treatment

Threshold Deduction is populated in the **FSI_THRESHOLD_TREATMENT** table and the threshold calculations are processed in this table

The line items, (Significant and insignificant Investment in the Common Shares of Accounting entities are populated from the FSI NON REGULATORY CONSOL ENTITY INVESTMENT table (**FSI_NON_REG_CONSL_ENTITY_INVST**), Mortgage Servicing Rights net of Deferred Tax Liabilities are populated from the Fact Standard Accounting head (**FCT_STANDARD_ACCT_HEAD**) table, and DTAs that arises from temporary differences are populated from the Fact Capital Accounting Head (**FCT_CAPITAL_ACCT_HEAD**).

The three-line items' significant investment in the common shares of BFSI where the bank owns more than 10%, Mortgage Servicing Rights (MSR), and DTAs that arises from temporary differences is processed for threshold deduction are populated in the Capital Threshold Treatment

(**FSI_THRESHOLD_TREATMENT**) table and the threshold calculations are processed in this table. These three-line items are individually compared with the 10% of CET1 calculated Post Regulatory Adjustments, Insignificant Investments, and Significant Investment. The amounts which are above 10% CET1 limit are deducted from CET1 following the phase-in arrangements. During the transition period, any amount of these three-line items, which is not deducted as per the 10% mentioned earlier, is summed up for the aggregate 15% limit check. During the transition period, the check of 15% is against the CET1 post all regulatory adjustments and adjustments to insignificant investments and significant investments and the individual threshold deduction. In the post transition period, instead of 15%, the aggregate check is 17.65% of CET1, post all regulatory adjustments and adjustments to insignificant investments, less 100% of the sum of the line items which goes for threshold deduction.

The amount which is not deducted due to this 10% and 15% check is risk-weighted 250% during the transition period and is risk-weighted 250% post the transition period. The entire processing is done in the sub process – 'THRESHOLD_TREATMENT_CALCULATIONS (PMFBISCS012) in Capital Structure Data Processing (PMFBISCS021).

7.10.11 Net Capital Calculations

The net CET1, net AT1, and net T2 capital amount are calculated post all regulatory adjustments. Any shortfall in T2 capital amount is adjusted against Net AT1 amount and any shortfall of AT1 capital amount is adjusted against Net CET1 amount.

This is done in sub process – NET_CAPITAL_CALCULATIONS (PMFBISCS014) in Capital Structure Data Processing (PMFBISCS023)

For RWA, RWA_POPULATIONS (PMFBISCS016) in Capital Structure Data Processing (PMFBISCS023).

For net capital it is NET_CAPITAL_CALCULATIONS (PMFBISCS014) in Capital Structure Data Processing (PMFBISCS023).

7.10.11.1 Total RWA Calculations

The RWA amount for Credit Risk - Non-Securitization, Counterparty Credit Risk, Credit Valuation Adjustment Risk Weighted Asset, Credit Risk - Securitization, Market Risk, and Operational Risk and Regulatory Capital Phase in Related RWA are calculated by summing up the RWA amount.

The Phase-In RWA captures the capital instrument investments that goes for deduction from Capital but because of Phase-In arrangement are to be risk-weighted such as – Reciprocal Cross-holding, Treasury Stock, Insignificant Investment amount, Significant Investment amount and Threshold deduction amount.

These are reported under different Capital accounting heads such as 'Risk-weighted Asset amount for Standardized Portfolios/IRB portfolio' for Non-Securitization, "Sec Std RWA" for Securitization portfolio, "Market RWA" for Market Risk and "Operational RWA" for Operational Risk.

This is part of the RWA_POPULATIONS (PMFBISCS016) in Capital Structure Data Processing (PMFBISCS023).

7.10.11.2 Capital Ratio Calculations

Tier 1 capital ratio and capital adequacy ratio are calculated using the total RWA amount, net Tier 1 capital, and Total capital amount.

For capital ratio, the process is CAPITAL_RATIO_CALCULATIONS (PMFBISCS017) in Capital Structure Data Processing (PMFBISCS023).

7.10.11.3 Required Capital ratio

This process is handled in CAPITAL_RATIO_CALCULATIONS (PMFBISCS017).

In this the application calculates CET1 capital ratio, T1 capital ratio, T2 capital ratio and a total capital ratio summing all of them.

And the same is being compared with the required capital ratio provided as an input for the specific regulator. The required capital ratio is being provided as an input in the FSI Setup Capital Accounting Head (FSI_SETUP_CAPITAL_HEAD).

7.10.11.4 Deficit or Excess Capital

The shortfall is handled in the sub process Net capital calculations (PMFBISCS014),

Here the application calculates CET1, AT1 and T2 capital shortfall amounts.

7.10.11.5 Key Data Elements

Key data elements to process the Capital Structure for the consolidated entity is as follows. For a complete list of tables and columns to be updated, see the Download Specifications document.

Entity details which are part of regulatory consolidation and parent entity shareholding percent. This data is captured in Stage Entity Shareholding Details (STG_ENTITY_SHR_HLD_PERCENT) table.

The capital structure component for each tier of capital for all entities involved in regulatory consolidation.

The total RWA, total CET1, AT1, and T2 amount and third-party percentage of holdings in each tier of capital for minority interest calculation.

The regulatory adjustment amount like goodwill, DTA, other intangible assets, cash flow hedge reserve, and defined pension fund asset, MSR, and so on.

The transaction of the investment amount for accounting entity which is outside the scope of regulatory consolidation.

The CET1, AT1, and T2 capital of the entity which has third party minority holdings in it are expected as a download in legal entity details (STG_LEGAL_ENTITY_DETAILS) table. Similarly, the third-party investment in each tier of capital is also expected as a download in legal entity details table.

The minimum required capital for each tier for each capital adequacy regulator (for the entity that has third party minority holding in it) is expected in the setup table - Setup Capital Heads (FSI_SETUP_CAPITAL_HEAD).

The Total RWA (CAP838) for the entity that has third party minority holding in it is a download value in Stage Standard Accounting Head (STG_STANDARD_ACCT_HEAD).

7.11 Capital Buffers

Capital Buffer is calculated after the calculation of Capital Ratios, as they go as an input to Buffer calculation. Each sub-process is explained in detail under Capital Buffer section of the user guide.

For example, Required Capital Conservation Buffer and Required Countercyclical Buffer calculation are detailed in the '[Required Total Buffer](#)' sub-section of the Capital Buffer section in this document. Similarly, Minimum Capital Conservation ratio is detailed in the '[Capital Conservation Ratio](#)' sub section of Capital Buffer section in this document.

Figure 52: Capital buffers process flow

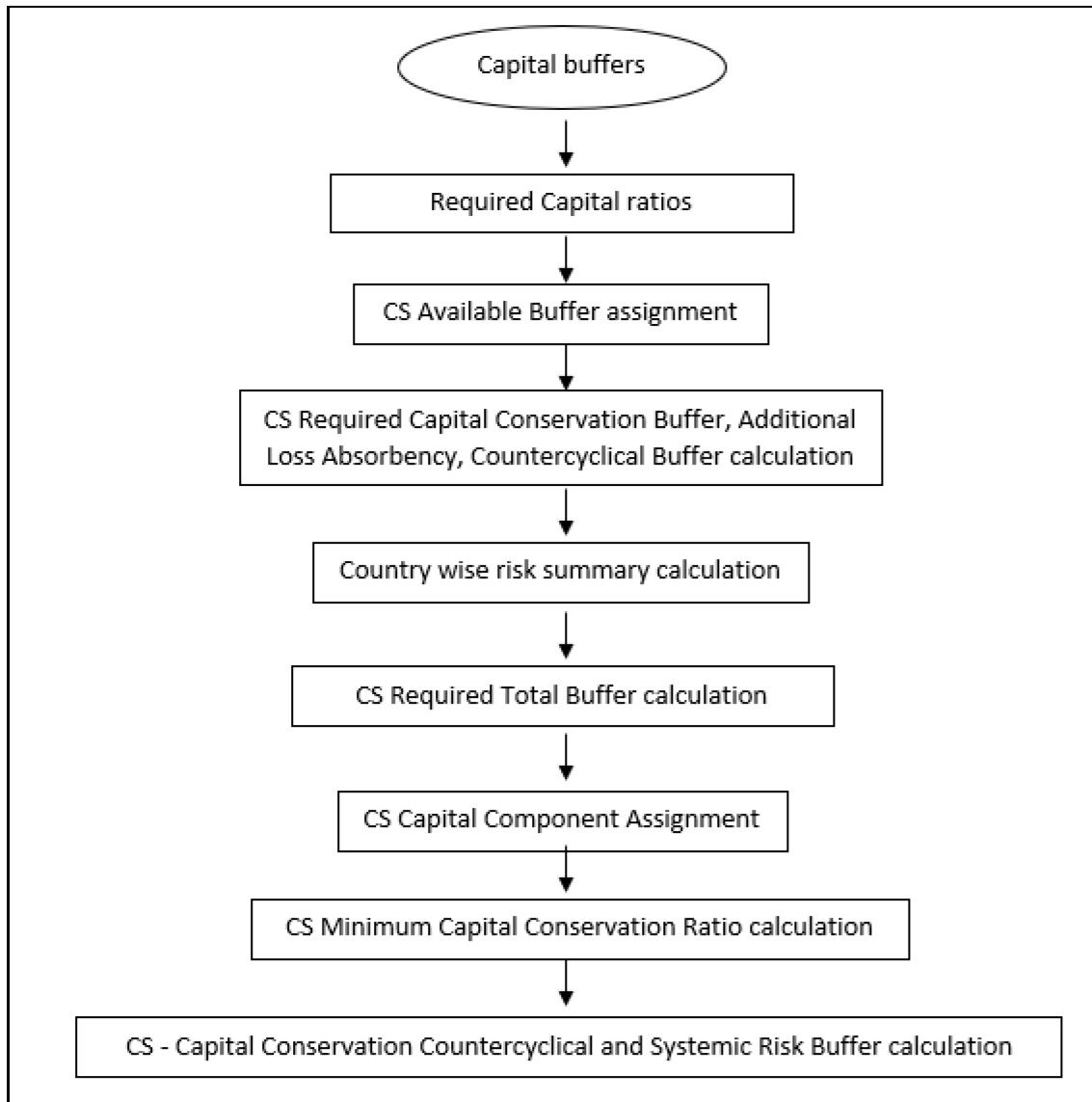

7.11.1 Data Population

The major input for capital buffers is the total capital ratio and the Net Common Equity Tier 1 Capital Ratio which gets computed as part of the capital structure process. This is consumed from the fact standard accounting head.

Along with that, the application consumes additional data related to buffers from the Stage Countrywide Risk Summary (STG_COUNTRYWISE_RISK_SUMMARY) which is used to populate country wise risk summary.

FSI Benchmark Capital Conservation Ratio (FSI_BENCHMARK_CAP_CONS_RATIO) and FSI Benchmark Countercyclical Buffer (FSI_BENCHMARK_CNTR_CYC_BUFFER).

7.11.2 Buffer Requirements

There are different types of Capital which the banks are expected to maintain:

- Capital Conservation Buffer
- Countercyclical Buffer
- Additional Loss Absorbency Capital (for G-SIB)

A detailed description of each of these buffers is provided in the following sections.

7.11.2.1 Capital Conservation buffer

As part of the Basel III compliance, Banks are required to maintain Capital Conservation Buffer (CCB) out of Common Equity Tier 1 Capital (CET1).

This buffer is used to ensure that any loss should not erode the bank's capital, and hence it is expected to be met over and above the Required CET1 Capital. The actual required ratio for the jurisdiction is being specified in the FSI Setup Capital Head (FSI_SETUP_CAPITAL_HEAD).

7.11.2.2 Countercyclical Buffer

As part of the Basel III compliance, Banks are required to maintain Countercyclical Buffer that is prescribed by the respective jurisdiction's regulator through an extension of Capital Conservation buffer.

The application calculates the buffer requirement for internationally active banks as the weighted average of the buffers required across all the jurisdictions to which the bank has exposures, weighted on basis of the exposure amount to different countries of the counterparty of their exposures.

If the guarantor and credit default swap is present for an exposure, then the application considers the domicile country of these mitigants for the covered portion and country of the exposure counterparty for uncovered portion. After calculating the weighted average, the application then computes a single value for Countercyclical Buffer benchmark which is applicable on all exposures of all jurisdictions.

7.11.2.3 Additional Loss Absorbency Buffer (GSIB Buffer)

If a banking organization is categorized a Globally–Systematically Important Banks (G-SIB), then the application identifies all subsidiaries in various jurisdictions as G-SIB as well. Based on this assessment, banks are assigned a GSIB score, and the applicable bucket is decided. Identification of this bucket is based on the score as per the guidelines. Loss absorbency is required to be met as an extension of Capital Conservation and Countercyclical for computational buffer for computational purposes.

7.11.3 Required Buffers

Required Total Buffer (CAP825) is the sum of the three required buffers: (CAP829) Required Buffer from CET1 Capital, (CAP830) Required Buffer from Tier 1 Capital, (CAP831) Required Buffer from Capital Adequacy Ratio.

The calculated values (only positive values are considered) are stored against the corresponding Cap IDs as two separate line items of which one is 0.

The Required buffers as a percentage are provided as a download in the FSI Setup Capital Account Head (FSI_SETUP_CAPITAL_HEAD), as per the specific regulatory need. This is being multiplied by the Total RWA to arrive at the Required Buffer as an amount.

7.11.4 Assumptions

Countercyclical Buffer requirement for each country must be provided by the client or the bank as the final percentage applicable for each country and this is dependent on the home regulator. G-SIB status and applicable bucket information for each entity must also be provided by the client/bank.

For Required Weighted Average Countercyclical Buffer calculation, the exposures used in the bank are all accounts exposed to credit risk (Securitized and Non-Securitized) and those exposed to Market Risk. However, the application can be restructured to consider only those exposed to Credit Risk.

In Capital Conservation Ratio, for the computation of the quartiles that are used to arrive at Minimum Capital Conservation Ratio, the application is dependent on the required CCB ratio. At the same time, the application has the flexibility to have the required CCB constant at 2.5% throughout. Also, the minimum required CET1 Ratio considered for the purpose of building these quartiles is 4.5%

7.11.5 Key Data Elements

Key data elements are elaborated in this section. For a complete list of tables to be updated, see the Download Specifications document.

Countercyclical Buffer requirement for each country must be provided by the client or the bank as the percentage applicable for each country which is dependent on the home regulator's jurisdiction. The home regulator's jurisdiction can prescribe Countercyclical Buffer percentage that is higher than the percentage prescribed by the regulator of exposure country. Hence, the required Countercyclical Buffer percentage for each exposure country provided as input must be the one that the home regulator agrees to.

G-SIB status and applicable bucket information for each entity must be provided by the client or the bank. In case of a Consolidated Run, loss absorbency charges applicable to the parent, as required by the regulator of parent, is applicable to the complete Run. This Run output is supposed to be reported to the jurisdictional regulator of the parent. For a Solo Run, loss absorbency charges as required by regulator for a subsidiary entity are applicable. Hence, for Solo and Consolidated Runs, G-SIB status of the reporting bank, and the applicable bucket, is provided by the bank itself.

As the required Capital Conservation Buffer (CCB) must be met as per the transitional arrangement, therefore the required buffer value must be setup in Setup Capital Heads (**FSI_SETUP_CAPITAL_HEAD**) table for different periods against the standard account head ID CAP823. Different CCB requirements specified by the different regulators can be setup by specifying the regulator codes against the same standard account head ID. This regulator code must be the same as the jurisdiction code assigned by the Rule Jurisdiction Code Assignment.

The required benchmark of Countercyclical Buffer for different countries as set by different regulators is expected as download in Stage Benchmark Counter Cyclical Buffer (**STG_BENCHMARK_CNTR_CYC_BUFFER**). This data is populated to Benchmark Counter Cyclical Buffer Ratio (**FSI_BENCHMARK_CNTR_CYC_BUFFER**) using a Slowly Changing Dimension (SCD) process. Buffer requirement given on a date is valid till the next buffer is specified. For a solo Run, the regulator of subsidiary specified buffer requirements is considered and for consolidation Run, the consolidating entity's regulator specified buffer requirements are considered.

The Additional Loss Absorbency requirement specified by different regulators for different buckets must be setup in the table Benchmark Loss Absorbency Ratio (**FSI_SETUP_BENCHMARK_LOSS_ABS**). For the solo Run, loss absorbency requirement set by the local regulator is considered. For consolidation Run, the consolidating entity's regulator specified loss absorbency requirement is considered.

There is an option to directly input the applicable loss absorbency percentage. This is also useful when the percentage applied is different from the corresponding bucket percentage. This must be provided in the column **N_LOSS_ABS_OVERRIDE** of the table Stage Legal Entity Details (**STG_LEGAL_ENTITY_DETAILS**). If this column has a value, it is given priority over loss absorbency percentage corresponding to the bucket.

The minimum Capital Conservation Ratios requirement for different quartiles (1, 0.8, 0.6, 0.4, 0) is expected as a download in Stage Benchmark Capital Conservation Ratio (**STG_BENCHMARK_CAP_CONS_RATIO**). This data is populated to the semi-static table Benchmark Capital Conservation Ratio (**FSI_BENCHMARK_CAP_CONS_RATIO**) using a SCD process. Conservation ratios specified once are valid till the next revision.

In the **FSI_REQUIRED_CNTR_CYC_BUFFER** table the post-mitigation exposure amount is updated against each country code. This is applicable for Credit Risk (for Non-Securitization and Securitization exposures) and Market Risk.

7.12 Large Exposures

The large exposure framework is a framework detailing on how the banks have to manage its exposures to various parties both at individual level, as well as to the group of connected clients' level.

The large exposure framework has to be complied with the bank at both solo and consolidated level. As part of the solo execution, the bank has to identify its large exposures, and comply within the required threshold limit.

As part of the consolidation execution, the bank has to identify the total large exposures at the consolidated level and comply within the required threshold limit.

The solo and consolidation are as per the regulatory definitions and same as the one which is being used for the regular capital adequacy.

The large exposures are identified based on the comparison of the total individual party's exposures to the Tier 1 Capital, which changes based on whether it is a solo execution or consolidation execution.

7.12.1 Data Population

The large exposure computations require data pertaining to the various portfolio – banking, investment, derivatives, securities and financing transactions, and trading book exposures.

Non-Securitization Data Population

Data must be loaded in the application for all the product types and is same as Capital Adequacy related data expectation.

See the individual portfolio for the data elements:

- [Banking](#)
- [Investment](#)
- [Derivatives](#)
- [Securities Financing transactions](#)

Mitigant Data Population

The data related to the mitigants associated to the exposures are captured in this process. This is also the same as the regular capital adequacy run related data.

For more information about Mitigant Data Population, see [Mitigant Processing](#) section.

Securitization Data Population

Data must be loaded in the application for all the relevant Securitization tables and is same as Capital Adequacy related data expectation.

For more information about securitization data population, see [Securitization Data Population](#) section

Trading book Data Population

Data must be loaded in the application for all the trading book exposures and is same as Capital Adequacy related data expectation.

For more details, please refer [Market Risk Data Population](#).

All these data are populated into the processing table of FSI_LARGE_EXPOSURE_ACCT_DETAIL.

Large exposure data population is handled in the sub-process LARGE_EXPOSURE_DATA_POPULATION

7.12.2 Reclassification

The reclassification rules are same as the ones already detailed in the individual portfolio – [banking](#), [investment](#), [derivatives](#), [securities and financing transactions](#), [securitization](#), and [trading book exposures](#).

In addition to the above, the reclassification which is specific to large exposures are the one mentioned below.

7.12.2.1 Party Relationship reclassification

All the relationships at party level are expected in the stage party –party relationship table (STG_PARTY_PARTY_RELATIONSHIP)

The Large Exposures computation require the details of the party's relationship to one another, since there is different limitation to the group exposure (which will be a group of connected counterparties based on various relationship types), and to individual counterparties (without considering any other related counterparties).

From a definition perspective, connected counterparties are individual entities that are considered as a group due to the direct or indirect control established between entities. This direct or indirect control is being identified based on the party-party relationship table, wherein each and every related party's information are provided, and the relationship type is also defined.

This is reclassified into the standard relationship type, to be used for further processing and reporting.

7.12.3 Computation of the Direct Exposures

The direct exposures are the actual exposures that are in the bank's portfolio in the form of banking, derivatives and SFT exposures. In the case of investment portfolio, the direct exposures are the ones which are investment in the form of debt securities or equity, and which do not have any underlying dependencies. This is handled for individual counterparties.

This gets handled as part of the sub process BIS_LARGE_EXPOSURE_EAD_ASSIGNMENT under the process LARGE_EXPOSURE_DATA_PROCESSING.

7.12.4 Computation of Indirect Exposures

The indirect exposures are the mitigants that have been provided to the exposures in the bank's portfolio in the form of banking, derivatives, investment and SFT exposures. This is handled for individual counterparties.

This gets handled as part of the sub process BIS_LARGE_EXPOSURE_EAD_ASSIGNMENT under the process LARGE_EXPOSURE_DATA_PROCESSING.

7.12.5 Computation of Synthetic Exposures

The synthetic exposures are the ones pertaining to Securitization and CIU, wherein there are synthetic exposures to the underlying of these transactions.

In this scenario, these exposures are computed by assigning them to the unknown clients or the actual counterparty to whom the underlying belongs to, depending on data availability.

This is handled for individual counterparties.

The computation of gross credit exposure for CIU/SPV is handled in the process LARGE_EXP_SPV_UNDERLYING_PROCESSING

7.12.6 Exempted Exposures

There are certain exposures which are being exempted from the large exposure calculations. These are mostly as specified by the regulator, and include the cleared transactions, and other exposures that are deducted from capital, since it does not make sense to consider them in the large exposure calculations.

This is handled for individual counterparties.

The computations with respect to this are handled in the subprocess BIS_LARGE_EXPOSURE_EXEMPTIONS of the process LARGE_EXPOSURE_DATA_PROCESSING.

7.12.7 Calculation of Total Exposure to a counterparty

Calculation of gross credit exposure depends on the specific product category of on-balance sheet, off-balance sheet exposure, derivative products, secured lending and borrowings, exposures arising from CIU, exposures arising from SPVs along with the exposures to third parties of the SPVs and trade exposures. Calculation also covers indirect exposures of the counterparty arising out of the mitigant exposures of the bank.

This is applicable for all the counterparties for which the bank has exposures in the form of either direct, indirect or synthetic exposures. This is handled in the sub-process LARGE_EXPOSURE_COUNTERPARTY_POPULATION and BIS_LARGE_EXPOSURE_COUNTERPARTY_PROCESSING in the process LARGE_EXPOSURE_DATA_PROCESSING (PMFBISLE015).

7.12.8 Identification of Related Parties

It is expected that the party ID is the one for which it is considered as a related party. For example, if Bank A is related to party B, and party B is related to party C, it is expected that the data is provided for Bank A to party B, and Bank A to party C, to ensure that every mapping is being considered.

The solution sums up the exposures for all the counterparties belonging to the same parent, along with the parent, and populates the FSI Large Exposure Account Detail Table (**FSI_LARGE_EXPOSURE_ACCT_DETAIL**).

The expectation is that all the parties which are related to each other, have the Parent ID of the Party table as the same, or are part of the related party. Based on these related parties identified, and the parent id in the DIM_PARTY, the related parties are identified, and these are also considered as belonging to the same group.

This is handled in the sub-processes LARGE_EXP_PARTY_GROUP_MEMBER_MAPPING and LARGE_EXP_PARTY_GROUP_EXP_POPULATION in the process LARGE_EXPOSURE_DATA_PROCESSING.

On the party group, the threshold limit check is applied, and the large exposures are identified.

7.12.9 Calculation of Total Exposure to a group of related counterparties

All the total exposures of the parties will be clubbed together to calculate the total party group exposures. This will be based on the related parties identified. This is the total exposure based on which the large exposure identification happens, and also the breach condition check happens.

This is handled in the sub-process BIS_PARTY_GROUP_LARGE_EXP_PROCESSING in the process LARGE_EXPOSURE_DATA_PROCESSING.

7.12.10 Total Capital of the Bank

This is used to calculate the total capital of the bank. This is computed as per the [Capital Structure](#) related calculations.

This is handled in the sub-process LARGE_EXPOSURE_CAPITAL AMOUNTS_POPULATION in the process LARGE_EXPOSURE_DATA_PROCESSING.

7.12.11 Identification of Large Exposure Counterparties

The large exposures are identified based on whether the group exposure of the counterparties exceed the required threshold using the pre mitigation value.

This is handled in the sub-process BIS_PARTY_GROUP_LARGE_EXP_PROCESSING in the process LARGE_EXPOSURE_DATA_PROCESSING.

7.12.12 Threshold criteria for Large Exposure Counterparties

The regulator indicates the threshold criterion below which the large exposures can be maintained by the bank. This threshold percent is assigned based on the standard party type of the counterparty, as specified by the regulator.

This is handled in the sub-process Large Exposures Counterparty Threshold Amount Calculation in the process BIS_LARGE_EXPOSURE_COUNTERPARTY_PROCESSING.

7.12.13 Large Exposure Breach Calculations

The application identifies whether there has been any breach to the large exposure threshold as specified by the regulator and are stamped a flag indicating that the counterparty as a group have breached it.

This is handled in the sub-process Large Exposures Counterparty Threshold Limit Breach Indicator Assignment in the process BIS_LARGE_EXPOSURE_COUNTERPARTY_PROCESSING.

7.13 Leverage Ratio

During the financial crisis, banking institutions built-up excessive on-balance sheet and off-balance sheet leverage which forced the banking sector to reduce its leverage. To prevent building of excessive leverage on the institutions' balance sheet, the BIS has introduced a non-risk-based leverage ratio which is a new regulatory tool supplementing risk-based capital requirement. The leverage ratio guidelines were revised and published on 10th October 2014. The guidelines are mostly in sync with the revised leverage ratio guidelines issued in 2014 by BIS.

The solution supports this revised approach in the calculation. The application calculates the leverage ratio for a reporting bank. The minimum required leverage ratio is 3%.

The leverage ratio is calculated by dividing an institution's Tier 1 capital measure by the total leverage exposure measure.

$$\text{Leverage Ratio} = \frac{\text{Tier 1 Capital}}{\text{Leverage Exposure Measure}}$$

The Run Basel III Revised Leverage Ratio Calculation is used for computing the leverage ratio, as per the revised guidelines.

Net Tier 1 capital is the summation of Net CET1, and Net AT1 capital amount post regulatory adjustment. Exposure measure is the summation of on-balance sheet items, off-balance sheet items, Derivative Exposures and Structured Financial Transactions (SFT). The on-balance sheet items include the non-Securitization exposures' amount and the Securitization exposures' amount. The off-balance sheet items include the non-Securitization exposures' amount and the Securitization exposures' amount. Mitigation is not considered when calculating exposure amount.

The leverage calculation happens at the consolidated parent entity level. This is expected in FSI Standard Account Head (**FSI_STANDARD_ACCT_HEAD**).

The leverage ratio calculations are a separate run, and not part of the regular capital calculation run. This is because of the changes in the Credit conversion factor assigned to the exposures, and also exemption of few exposures from the calculation which are part of the capital charge calculations. Also, the mitigation is not required for these exposures, and the exposure measure calculations are different from the regular EAD calculations.

The accord is not explicit on the inclusion of Securitization and market related transactions in the exposure measure calculations. However, the application has considered Securitization and the market related transactions in the calculation of total leverage exposure measure.

Figure 53: Capital calculation process flow

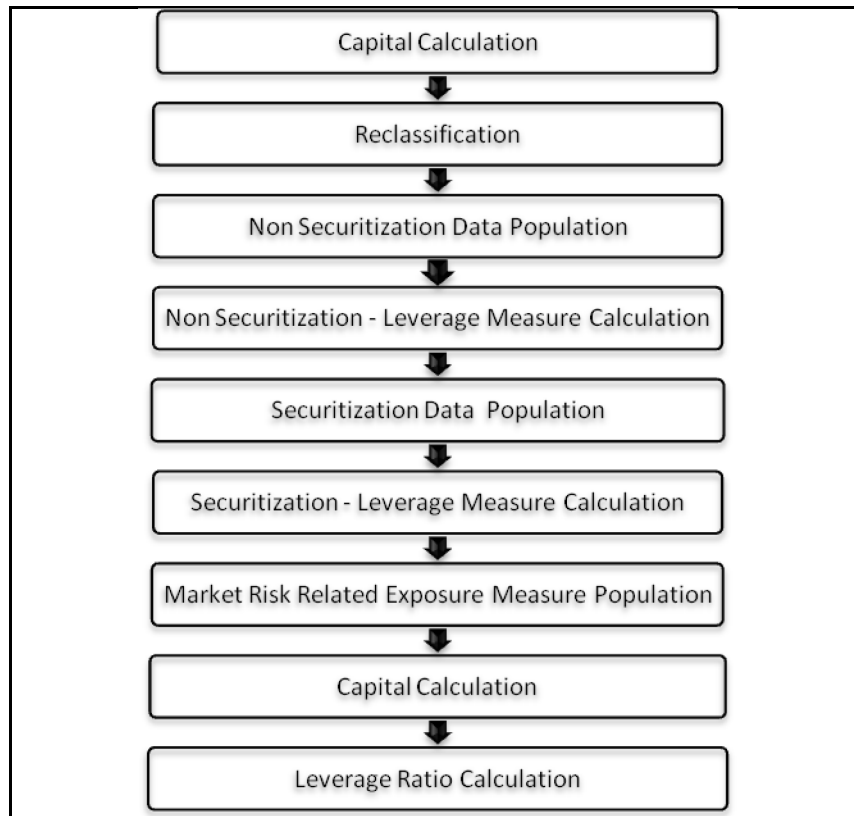

7.13.1 Data Population

Non-Securitization Exposure Data Population

Data from the Product Processors are populated to FCT_NON_SEC_EXPOSURES table in the process NON_SEC_DATA_POPULATION. This data population also remains the same as existing in the capital calculation run.

Collateral of Derivative

Collateral for the derivatives, which is already considered in the MTM calculation, are provided in the STG_MITIGANTS table with the eligibility flag as 'N' and the corresponding entry is added into the STG_EXP_MITIGANT_MAPPINGS table.

The MTM provided for the derivatives' instruments, must be after following the corresponding operational accounting framework.

Securitization Data Population

Securitization exposure data is populated to securitization processing table in the process SEC_DATA_POPULATION. The population remains the same as in the capital calculation run.

Key Data Elements

Key data elements are elaborated in this section. For a complete list of tables and columns to be populated, see the Download Specifications document.

To calculate the leverage ratio, exposure amount for all product types and the total capital are required.

The key data elements for exposure measure calculation of the various product types are as follows:

- On-Balance Sheet Exposures: For on-balance sheet items, End of Period (EOP) balance amount, write-off, and accrued interest amount is required.
- SFT Exposures: For repo products, exposure amount, and instrument rating are required.
- Derivative Exposures: For derivative products, exposure mark to market value, notional principal amount, and underlying instrument types are required.
- Off-Balance Sheet Exposures: For off-balance sheet items, undrawn amount is required.
- Securitization Transaction: For securitization transactions, exposure amount is required.
- Capital Calculation: See the Capital Structure for more details.
- Cash Variation Margin: The collateral segregated flag, exchange traded flag, and netting agreement code are required.
- Netting Agreement: The margin threshold and the minimum transfer amount are required, which are captured in the Stage Net Exposures table (STG_NET_EXPOSURES).

7.13.2 Exposure Measure Calculations

- After data is populated in non-Sec processing table, the exposure measure is calculated in the process **BASELIII_LEV_RATIO_EXPOSURE_MEASURE_CALCULATION**.
- The Exposure measure is the sum of the Pre-mitigation EAD amount of the following exposure types:
 - On-Balance Sheet Exposures
 - Off-Balance Sheet Exposures
 - SFT Exposures
 - Derivative Exposures
- Details on the calculation of these exposure measures are mentioned in the following sections. All the exposure measures are computed and populated into the Leverage Exposure amount (**N_LEVERAGE_EXPOSURE_AMOUNT**) column. And any exempted exposures are identified by the solution in the Regulatory Capital Exemption Criteria in the Non-Sec Exposures processing table. These exempted criteria are part of the dimension table of Regulatory Capital Exemption Criteria Dimension (**DIM_REG_CAP_EXEMPTION_CRITERIA**).

7.13.2.1 On Balance Sheet Exposures

- The accounting value of the on-balance sheet exposures net of specific provisions and valuation adjustments are considered for the exposure measure. The valuation adjustments are captured at an instrument level, in the FSI setup table for Instrument Valuation Details (FSI_SETUP_INSTR_VALUATION_DTLS).
- The exposure measure considered is the Pre-Mitigation amount and does not consider the benefit of the mitigation.
- Some of the exempted exposures are detailed as follows.

- **Fiduciary Assets**

- If the bank considers the assets of the fiduciary assets, as the bank's own assets, then, these assets are exempted from the calculation. The fiduciary assets are identified based on the exposures having the Parent Fiduciary Account Number (V_PARENT_FIDUCIARY_ACCT_NUMBER) in the product processor (PP) staging tables.
- The bank has to select the run management option to select whether the exposures are derecognized in the balance sheet or not.

If the run management option of Y is selected, all the fiduciary assets with the parent fiduciary account is exempted from the Leverage Exposure Measure calculations.

If the run management option of N is selected, specific fiduciary assets can be exempted from the Leverage Exposure Measure calculations.

These specific fiduciary assets are expected to be provided in the FSI Fiduciary Assets setup table (FSI_SETUP_DEREC_FIDUCIARY_ASST).

- This is handled in the Fiduciary Assets Exemption sub-process of the IND BASELIII_LEV_RATIO_EXPOSURE_MEASURE_CALCULATION process.

7.13.2.2 Off Balance sheet exposures

The exposure amount for off-balance sheet exposures is the undrawn amount of the exposure multiplied by the CCF. The CCF of the exposures remain the same as in the Capital Calculation Run, except that the CCF is floored at 10%. The flooring of the CCF to 10% is handled by the rule Non-Sec Off Balance Sheet Exposures CCF Percent Flooring in the Non-Sec CCF Assignment sub process. This exposure measure does not consider the mitigation effect.

7.13.2.3 Derivative Exposures

Derivative transactions (OTC Derivatives) exposure measure is calculated using the Mark to Market Method. The add-on assignment is same as what is mentioned in the Capital Calculation Run. The exposure measure is the sum of market value, and the notional amount multiplied by the add-on percent.

The derivative exposure measure has few specific treatments, in terms of the Leverage Exposure Measure calculations. They are as detailed as follows.

Collateral of Derivative

The collateral received with reference to the derivatives, cannot be used in netting, and reducing the exposure amount of the derivatives. Based on whether the operative accounting framework allows for netting of the collateral or not, the solution updates the exposure measure. The solution expects a run management selection to identify whether the bank considers netting of the collateral outside the application and provides the netted amount as input to the product processor staging tables.

The collateral of derivative is given in the mitigant table. There is a run management option to capture whether the operative accounting framework allows for netting of the collateral as per the master netting agreement or not.

If 'Yes' is selected, assuming that the bank has provided the MTM value based on already considering the collateral amount, the collateral amount is added to the MTM of the exposure. And if 'No' is selected, there is no change to the MTM value.

7.13.2.4 SFT Exposures

The exposure amount of the SFT Exposures to be considered for the leverage measure is post the effect of the collateral. The SFT Exposures data provided in the staging must not consider the accounting netting.

The data capture for the SFT exposures remain the same as in the Capital calculation run. The bank role in the SFT transaction is also captured in the staging table.

The Gross amount and the Add-on amount, as expected in the accord are computed by the application. The Gross amount is the actual transaction amount of the SFT exposures, as provided in the Repo contracts staging table. And the Add-on amount is the difference between the fair value of the repo exposures and the fair value of the collateral placed or received.

- The fair value of the exposures, including the placed collateral are captured at an instrument level, in the FSI setup table for Exposure Fair Value Details (**FSI_SETUP_INSTR_VALUATION_DTLS**), and the fair value of the mitigants are captured in the FSI setup table for Mitigant Fair Value (**FSI_SETUP_MTGNT_VALUATION_DTLS**).

The mitigants which are used to offset the fair value of the repo exposures, are stamped accounting heads, to ensure that they can be tracked.

The exposure amount calculations are different for the bank acting as a principal in the SFT transactions, and an agent in the SFT transactions. The solution supports both the treatments.

For bank acting as an agent, the solution handles all the treatment mentioned in the accord. The data expectation for them are as follows:

- Case 1: Bank is an agent, and does not get involved in any other role with the SFT Exposure
In this case, the data is not expected in the Repo contracts staging table.

- Case 2: Bank is an agent, and provides a guarantee equal to the difference between the SFT Exposure and the collateral amount

In this case, the data is expected in the Repo contracts staging table, with the bank role as an agent, and the indemnity indicator (**F_INDEMNITY_IND**) as 'Y'.

The application computes only the Add-on amount for this SFT transaction, in line with the guidelines. And this Add-on amount is populated into the Add-on column of the processing table. This Add-on amount is calculated in the data transformation `Lev_Ratio_SFT_Addon_amt`.

This is handled in the sub process (Leverage Ratio Computations) of the process (**BASELIII_LEV_RATIO_EXPOSURE_MEASURE_CALCULATION**).

- Case 3: Bank is an agent, and provides a guarantee more than the difference between the SFT Exposure and the collateral amount

In this case, the data is expected in the Repo contracts staging table, with the bank role as an agent, and the indemnity indicator (**F_INDEMNITY_IND**) as Y. And a separate guaranteed transaction is expected to be recorded in the guarantee staging table. This guaranteed transaction is also provided as a mitigant with the mitigant table also storing the guarantee contract ID (**V_GUARANTEE_CONTRACT_ID**). And the exposure and the mitigant must be mapped to each other in the exposure mitigant mapping table `STG_ACCOUNT_MITIGANT_MAP`.

This guarantee is not for a mitigant treatment, and hence, this is expected with the mitigant eligibility flag as 'N'. This identified guarantee is populated in `FNSE.n_repo_contract_skey`.

The application computes both the gross exposure amount and the add-on amount for this SFT transaction, in line with the guidelines. This Add-on amount is calculated in the data transformation Lev_Ratio_SFT_Addon_amt.

This is handled in the sub process (Leverage Ratio Computations) of the process **(BASELIII_LEV_RATIO_EXPOSURE_MEASURE_CALCULATION)**.

7.13.2.5 Total Capital Calculations

Capital measure is calculated in BIS_CAPITAL_STRUCTURE(PMFBISCS023) process. Capital Measure used in the leverage ratio is equal to Net Tier 1 which is post all regulatory adjustments. The capital structure is the same as the capital calculation run.

7.13.2.6 Leverage Ratio Calculations

The leverage ratio is calculated as follows.

Leverage Ratio = Tier 1 Capital / Total Leverage Exposure Measure

This is computed in the process – BASELIII_LEV_RATIO_LEVERAGE_RATIO_CALCULATION.

8 Basel III IRB Approach

Capital Adequacy guidelines as issued in the following regulations are incorporated in OFS Financial Services Basel Regulatory Capital:

BIS Jurisdiction: International Convergence of Capital Measurement and Capital Standards, June 2006.

Basel III: A global regulatory framework for more resilient banks and banking systems, Dec 2010 (rev June 2011).

This approach covers the following topics:

- Credit RWA
- Counterparty Credit RWA
- Default Fund Contributions Related Capital Charge
- Credit Valuation Adjustments
- Credit RWA for Securitization
- Market Risk RWA
- Operational Risk RWA
- Capital Structure
- Capital Buffers
- Large Exposures
- Leverage Ratio

8.1 Credit RWA

The application supports the computation of Credit RWA, as per the guidelines laid out in the Basel Accord. Credit RWA computation is divided into Credit Risk for Non-Securitized exposures process and Credit Risk for Securitized exposures process.

For Credit Risk of Non-Securitized and Securitized exposures, the Foundation IRB Approach (FIRB) and Advanced IRB Approach (AIRB) is as follows.

Figure 54: Credit Risk of Non-Securitized and Securitized exposures

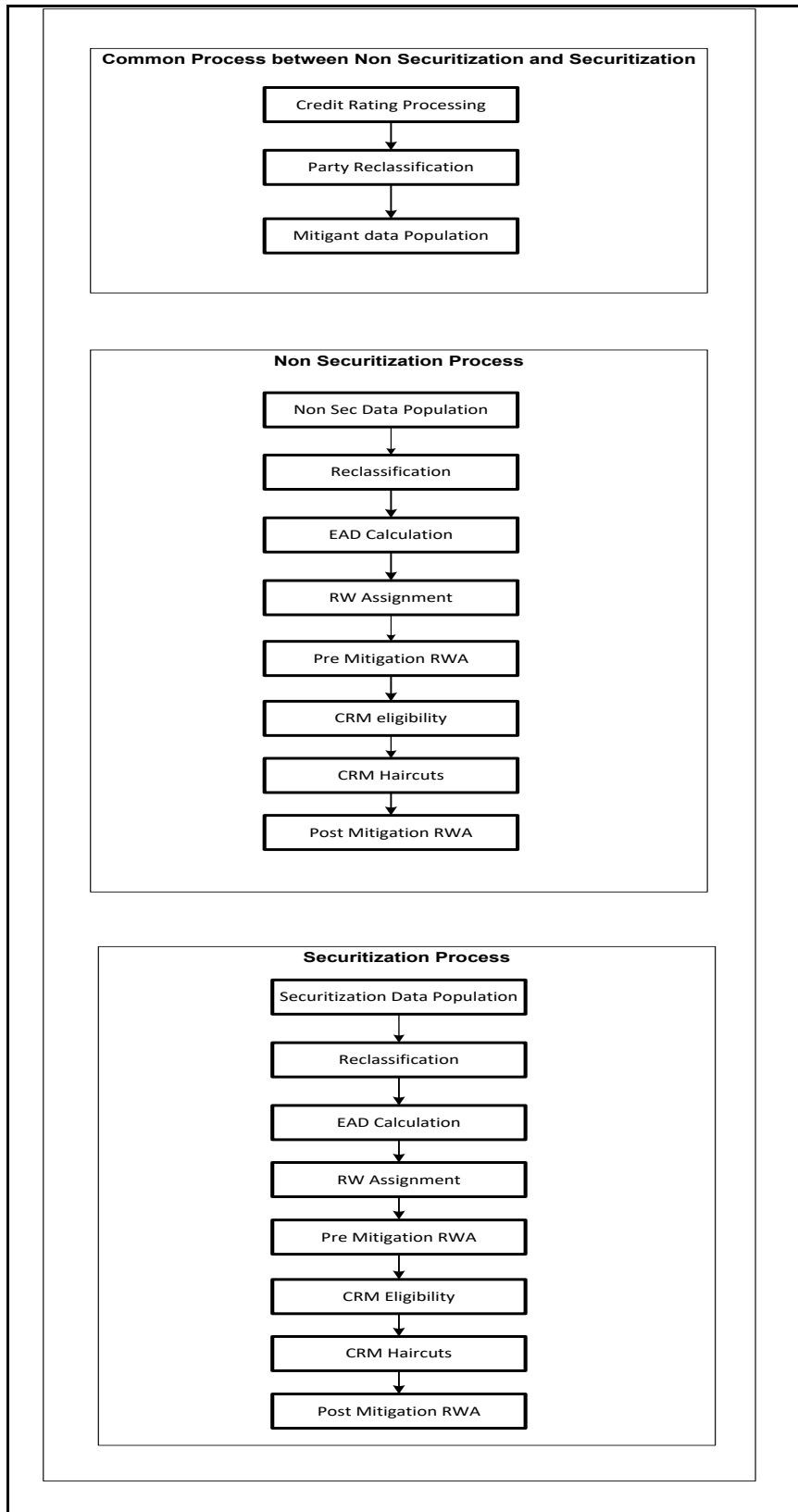

A Credit RWA Run is a combination of the Non-Securitization RWA process and Securitization RWA process. A few processes like Credit Rating, Party Type Reclassification, and Mitigant Data Population are common between Non-Securitization and Securitization process. Though these sub processes are explained separately under Non-Securitization and Securitization section of this document, it is executed only once under the Credit RWA run

Certain sub processes under non-Securitization process like Reclassification, RW assignment, and so on are common across all types of exposures for example: banking book, over the counter derivative transactions, and securities financing transactions, and are executed only once in the Run. The details of these sub processes are explained under Reclassification and Risk Weight Assignment sub process of the Basel II Non-Securitization exposures section of this document. Likewise, details of Credit Risk Mitigation for Non-Securitization process are detailed under the Basel II Non Securitization section of this document and details of Credit Risk Mitigation for Securitization process is detailed under the Basel II Securitization section of this document.

For example: Non-Sec Data Population is detailed under data population and currency conversion of Credit RWA (Non-Securitization - Standardized approach) section of this document.

8.1.1 Banking Portfolio

8.1.1.1 Rating Population

The rating population in the case of IRB Approach is not relevant, and is only used for the mitigants, as they are used for the mitigant eligibility rules.

In addition, it is also applicable for the specialized lending exposures wherein data is expected in the Stage Account Rating Details (STG_ACCOUNT_RATING_DETAILS), for processing related to it.

8.1.1.2 Data Population

The data population remains the same as in Standardized Approach

8.1.1.3 Shareholding Percent Multiplication

The shareholding percent multiplication for the various amounts associated with the exposure remains the same as in [Standardized Approach](#).

8.1.1.4 Common Reclassification Rules

The reclassification rules are consistently the same across all the approaches of the calculations. This is same as in [Standardized Approach](#).

8.1.1.5 Asset Reclassification Rules

The asset reclassification is based on the various combinations of the Basel product type and the standard counterparty type and any other filters as relevant. This remains functionally the same as in [Standardized Approach](#).

For AIRB, Process Name: BNK_RECLASSIFICATION_AIRB

For FIRB Process Name: BNK_RECLASSIFICATION_FIRB

The sub-processes in both are as follows:

BIS - Banking Basel Asset Reclassification based on Party Type – IRB

BIS - Banking Basel Asset Reclassification based on Product Type – IRB

8.1.1.6 Pre-mitigation Calculations

Some exposures can be hedged against credit risk through various mitigants like guarantors, collaterals, credit derivatives, and so on. These provide mitigation to credit risk and must be considered while computing Credit RWA as per Basel norms. Hence, the application calculates pre-mitigation risk-weighted assets amount and post-mitigation risk-weighted assets amount.

The application calculates the correlation factor using the formula specified for each asset class. Using Correlation factor, PD, and LGD, the application calculates the pre-mitigation capital charge for each exposure. This value signifies the capital charge the bank has to maintain for each exposure, prior to considering any mitigation effects.

The application calculates pre-mitigation exposure at default amount and risk weight for each exposure. Further, it computes pre-mitigation risk-weighted assets (Pre-CRM RWA) by multiplying the EAD by risk weight. The risk weight is arrived at by multiplying pre-mitigation capital charge with 12.5.

8.1.1.6.1 Credit Conversion Factor (CCF Assignment)

This is an input required for converting the off-balance sheet component of the exposure (undrawn portion associated with an on-balance sheet or off-balance sheet product, or the exposure amount of an off-balance sheet product). This is based on the supervisory provided values and is determined based on the product type and the maturity associated with the exposure in the case of FIRB Approach. In the case of AIRB Approach, the CCF can be either based on the supervisory estimate or own estimate.

This will populate the Drawn CCF (for the CCF to be assigned to the exposure amount of the off-balance sheet product) and the Undrawn CCF (for the CCF to be assigned to the undrawn portion of the on-balance sheet and off-balance sheet exposures).

This happens in the sub-process CCF_ASSIGNMENT_IRB in Banking Data Processing – FIRB and Banking Data Processing –AIRB processes.

8.1.1.6.2 Exposure at Default Amount Calculation

Exposure at Default (EAD) is calculated for all the products. This is being computed using the Exposure Amount (EOP Balance of the Exposure), Undrawn Amount of the Exposure (Undrawn Amount) and also the Credit Conversion Factor for the Off-Balance sheet Amount (CCF). This is computed for the on-balance sheet products separately, and the off-balance sheet products separately.

In the case of FIRB as well as AIRB Approach, it can either be the formulae specified above, or bank can model and directly provide the EAD as a download.

This happens in the sub-process BNK_PRE_CRM_EAD_COMPUTATION_IRB in Banking Data Processing – FIRB and Banking Data Processing –AIRB processes.

8.1.1.6.3 Post CRM EAD

Through the CRM process, the bank takes into account the effect of the mitigation and calculates the post-mitigation exposure at the default amount. This signifies the maximum loss that the bank can suffer in case of default on this exposure, after considering the effects of the mitigation. This will be the EAD of the Exposure Pre-Mitigation less the covered portion of the mitigant.

8.1.1.6.4 Capital Charge Rules

In the case of IRB Approach, the Capital charge is being computed for both unexpected loss as well as Expected loss.

1. Unexpected Loss Calculations

Unexpected Loss is calculated as using the Probability of Default (PD), Loss Given Default (LGD), Effective Maturity (M) and Correlation Factor.

This is handled in the sub-process Banking Pre-Mitigation Capital Required for UL

For FIRB - in the process CAPITAL_CALCULATION_FIRB

For AIRB - in the process CAPITAL_CALCULATION_AIRB.

a. PD Calculations

Probability of Default (PD) signifies the likelihood of a borrower failing to meet his/her financial obligations. In both FIRB and AIRB, PD values are expected as input/download from the bank. This gets captured as part of the data population process.

There are certain flooring requirements and capping requirements that are specified for each of the asset class.

This is handled in the sub process as below:

For FIRB - In the sub-process PD_LGD_ASSIGNMENT_FIRB in the process Banking Data Processing – FIRB.

For AIRB - In the sub-process PD_LGD_ASSIGNMENT_AIRB in the process Banking Data Processing – AIRB.

b. LGD Calculations

Loss Given Default (LGD) signifies the portion of the exposure that is likely to be lost in case the borrower defaults. In FIRB, LGD is computed by the application, as per the regulatory ask for each of the asset class. In addition, in the case of AIRB, LGD is also expected as a download.

All PD and LGD calculations are handled in the process as below:

For FIRB - In the sub-process PD_LGD_ASSIGNMENT_FIRB in the process Banking Data Processing – FIRB.

For AIRB - In the sub-process PD_LGD_ASSIGNMENT_AIRB in the process Banking Data Processing – AIRB.

c. Effective Maturity Calculations

Effective maturity (M) will be 2.5 years for exposures to which the bank applies the foundation approach, except for repo-style transactions where the effective maturity is 6 months (i.e.,

M=0.5). In addition, in the case of AIRB, this is also expected to be provided by the bank using the modeling requirement.

The effective maturity (M) is subject to a floor of one year and a cap of 5 years

All maturity calculation is handled in the process as below:

For FIRB - In the sub-process MATURITY_CALCULATION_AND_ASSIGNMENT_FIRB in the process Banking Data Processing – FIRB.

For AIRB - In the sub-process MATURITY_CALCULATION_AND_ASSIGNMENT_AIRB in the process Banking Data Processing – AIRB.

d. Correlation Calculations

The correlation is being computed as per the requirement provided by the regulator by using all the inputs of PD, LGD, EAD and Effective Maturity.

As per the regulatory ask, the application assigns the multiplier of 1.25 to the Asset Value Correlation (AVC) of exposures wherever relevant. These exposures relate to regulated financial firms with assets of at least 100 billion USD and to exposures of unregulated financial firms (regardless of size). This gets consumed in the correlation formulae applicable for the asset classes' specific calculation, as specified by the regulator.

This is calculated in the sub-process Basel III Banking Correlation Factor

For FIRB - in the process CAPITAL_CALCULATION_FIRB

For AIRB - in the process CAPITAL_CALCULATION_AIRB

e. Capital Charge Calculations

The capital charge for the unexpected loss is computed using the regulatory provided calculation specific for the asset classes. This gets handled in the process as below:

For FIRB - in the process CAPITAL_CALCULATION_FIRB

For AIRB - in the process CAPITAL_CALCULATION_AIRB

f. Purchased Receivables – Default Risk Charge Calculations.

In the case of Purchased receivables, the capital charge is computed for both the dilution risk as well as the default risk.

Under Internal Ratings Based approach, banks have the option of selecting Top-Down approach or Bottom-Up approach for calculating default risk capital charge for Purchase Receivables

In Top-Down approach, the risk weight calculation happens at a pool of receivables as a whole level instead of at individual obligor level. On the other hand, Bottom Down approach uses individual receivables making up the pool to arrive at the capital charge. Banks have the option to decide which approach to use. (For more information, see Run Management)

This is handled in the sub-process Banking Capital Required for UL - Defaulted Exposures IRB

For FIRB - in the process CAPITAL_CALCULATION_FIRB

For AIRB - in the process CAPITAL_CALCULATION_AIRB.

g. Purchased Receivables – Dilution Risk Charge Calculations.

In the case of Purchased receivables, the capital charge is computed for both the dilution risk as well as the default risk.

Purchase receivables always have an inherent risk of diluting future cash flows because of cash and non-cash credits such as discounts and guarantees. This risk needs to be quantified in case the bank feels Dilution Risk is material. Banks can decide whether Dilution Risk capital charge is required or not. (For more information, see Run Management)

This is handled in the sub-process Banking Pre-Mitigation Capital Required for Dilution Risk

For FIRB - in the process CAPITAL_CALCULATION_FIRB

For AIRB - in the process CAPITAL_CALCULATION_AIRB.

2. Expected Loss calculation

Expected loss is the loss which the bank expects it will incur during the course of holding the exposure. This is mostly computed by using the attributes of PD, LGD and EAD.

This is calculated as the product of PD, LGD and EAD. This is applicable for most of the asset classes.

This is handled in the sub-process Banking Pre-Mitigation – EL

For FIRB - In the process PRE_CRM_RISK_WEIGHTED_ASSET_CALCULATION_FIRB

For AIRB - In the process PRE_CRM_RISK_WEIGHTED_ASSET_CALCULATION_AIRB

8.1.1.6.5 RWA Calculations

IRB approaches calculate RWA for dilution risk (Banking RWA For Dilution Risk), pre mitigation RWA unexpected loss (Banking Pre-Mitigation RWA – UL) as well as pre mitigation RWA expected loss (Banking Pre-Mitigation RWA – EL).

All these sub-processes can be found in the below process:

For FIRB - In the process PRE_CRM_RISK_WEIGHTED_ASSET_CALCULATION_FIRB

For AIRB - In the process PRE_CRM_RISK_WEIGHTED_ASSET_CALCULATION_AIRB

8.1.1.7 Credit Risk Mitigation Process

Credit Risk Mitigation is the same as in the Standardized approach of the calculations.

8.1.1.7.1 Mitigant Eligibility

The mitigant eligibility remains the same as in [Standardized Approach](#), except for the scenario wherein the bank can only follow Comprehensive Approach for collateral recognition, and not simple Approach.

8.1.1.7.2 Mitigant Approaches and their Risk Weighting Rules

The mitigant approaches applicable for IRB are only the Comprehensive Approach for Collateral recognition. This is same as in [Standardized Approach](#).

And in the case of unfunded mitigant in the form of guarantee and credit derivatives, the risk weights are calculated by using the PD of the mitigant provider, and the LGD of the covered exposure, and using the risk weight function as applicable for the mitigant asset class.

This is handled in the sub-process CAP Collateral Eligibility for IRB Mitigants in the process Mitigant Collateral Eligibility – Comprehensive Approach – BIS.

8.1.1.7.3 Mitigant Haircut Assignment

Under IRB approach, the bank can follow either supervisory estimates (in the case of FIRB/ AIRB) or bank's own estimate (in the case of AIRB) for Mitigant Haircut assignment. This is based on the various categories like mitigant type, residual maturity, rating, issuer type etc.

All the other part of the haircut assignment is same as in [Standardized Approach](#).

8.1.2 Investment Portfolio

8.1.2.1 Data Population

Data Population is explained in detail under the Investment Portfolio sub section of the Credit RWA section in this document

In addition to the Product Processor tables, FSI Setup Account Modeling Information (FSI_SETUP_ACCT_MODELING_INFO) is used for providing the input required for the Capital charge calculation, and which is based on the bank's specific models. Some of the attributes picked up from this table are PD, LGD in the case of AIRB approach, Effective Maturity, CCF Own Estimate (in the case of AIRB approach) etc.

This is handled in the process Investment Data Population.

8.1.2.2 Shareholding Percent Multiplication

Shareholding Percent Multiplication is explained in detail under the Investment Portfolio sub section of the Credit RWA section in this document.

8.1.2.3 Common Reclassification Rules

Common Reclassification Rules is explained in detail under the Investment Portfolio sub section of the Credit RWA section in this document.

8.1.2.4 Asset Reclassification Rules (different from STD)

The asset reclassification is based on the various combinations of the Basel product type and the standard counterparty type and any other filters as relevant. This remains functionally the same as in [Standardized Approach](#).

For both FIRB and AIRB, Process Name: INV_DATA_RECLASSIFICATION_IRB

For FIRB Process Name: BNK_RECLASSIFICATION_FIRB

The sub-processes in both are as follows:

BIS - Investment Basel Asset Reclassification based on Party Type – IRB

BIS - Investment Basel Asset Reclassification based on Product Type - IRB

8.1.2.5 Pre-mitigation Calculations

Some exposures can be hedged against credit risk through various mitigants like guarantors, collaterals, credit derivatives, and so on. These provide mitigation to credit risk and must be considered while computing Credit RWA as per Basel norms. Hence, the application calculates pre-mitigation risk-weighted assets amount and post-mitigation risk-weighted assets amount.

The application calculates the correlation factor using the formula specified for each asset class. Using Correlation factor, PD, and LGD, the application calculates the pre-mitigation capital charge for each exposure. This value signifies the capital charge the bank has to maintain for each exposure, prior to considering any mitigation effects.

The application calculates pre-mitigation exposure at default amount and risk weight for each exposure. Further, it computes pre-mitigation risk-weighted assets (Pre-CRM RWA) by multiplying the EAD by risk weight. The risk weight is arrived at by multiplying pre-mitigation capital charge with 12.5.

8.1.2.5.1 Exposure at Default Amount Calculation (different from STD)

Exposure at Default (EAD) is calculated for all the products. This is being computed using the Exposure Amount (EOP Balance of the Exposure)

This happens in the sub-process INV_EAD_CALCULATION_IRB in Investment Data Processing – FIRB and Investment Data Processing –AIRB processes

Post CRM EAD

Through the CRM process, the bank considers the effect of the mitigation and calculates the post-mitigation exposure at the default amount. This signifies the maximum loss that the bank can suffer in case of default on this exposure, after considering the effects of the mitigation. This will be the EAD of the Exposure Pre-Mitigation less the covered portion of the mitigant

8.1.2.5.2 Capital Charge Rules (different from STD)

Two primary capital charge measures that differentiate IRB run from STD run are expected loss and unexpected loss calculations.

1. Unexpected Loss Calculations

Unexpected Loss is calculated as using the Probability of Default (PD), Loss Given Default (LGD), Effective Maturity (M) and Correlation Factor.

This is handled in the sub-process Non-Sec Inv Pre-Mitigation Capital Required for UL in the process INV_CAPITAL_CALCULATION_IRB

a. PD Calculations

Probability of Default (PD) signifies the likelihood of a borrower failing to meet his/her financial obligations. In both FIRB and AIRB, PD values are expected as input/download from the bank. This is captured as part of the data population process.

There are certain flooring requirements and capping requirements, which are specified for each of the asset class.

This is handled in the sub process as below:

For FIRB - In the sub-process INV_PD_LGD_ASSIGNMENT_FIRB in the process Investment Data Processing – FIRB.

For AIRB - In the sub-process INV_PD_LGD_ASSIGNMENT_AIRB in the process Investment Data Processing – AIRB.

b. LGD Calculations

Loss Given Default (LGD) signifies the portion of the exposure that is likely to be lost in case the borrower defaults. In FIRB, LGD is computed by the application, as per the regulatory ask for each of the asset class. Moreover, in the case of AIRB, LGD is also expected as a download.

All PD and LGD calculations are handled in the process as below:

For FIRB - In the sub-process INV_PD_LGD_ASSIGNMENT_FIRB in the process Investment Data Processing – FIRB.

For AIRB - In the sub-process INV_PD_LGD_ASSIGNMENT_AIRB in the process Investment Data Processing – AIRB.

c. Effective Maturity Calculations

Effective maturity (M) will be 2.5 years for exposures to which the bank applies the foundation approach, except for repo-style transactions where the effective maturity is 6 months (ie $M=0.5$). Moreover, in the case of AIRB, this is expected to be provided by the bank using the modeling requirement.

The effective maturity (M) is subject to a floor of one year and a cap of 5 years

All maturity calculation is handled in the process as below:

For FIRB - In the sub-process INV_MATURITY_CALCULATION_AND_ASSIGNMENT_FIRB in the process Investment Data Processing – FIRB.

For AIRB - In the sub-process INV_MATURITY_CALCULATION_AND_ASSIGNMENT_AIRB in the process Investment Data Processing – AIRB.

d. Correlation Calculations

The correlation is being computed as per the requirement provided by the regulator by using all the inputs of PD, LGD, EAD and Effective Maturity.

As per the regulatory ask, the application assigns the multiplier of 1.25 to the Asset Value Correlation (AVC) of exposures wherever relevant. These exposures relate to regulated financial firms with assets of at least 100 billion USD and to exposures of unregulated financial firms (regardless of size). This is consumed in the correlation formulae applicable for the asset classes' specific calculation, as specified by the regulator.

This is calculated in the sub-process Basel III Non-Sec Inv Correlation Factor in the process INV_CAPITAL_CALCULATION_IRB.

2. Expected Loss calculation

Expected loss is the loss, which the bank expects it will incur during the course of holding the exposure. This is mostly computed by using the attributes of PD, LGD and EAD.

This is calculated as the product of PD, LGD and EAD. This is applicable for most of the asset classes.

This is handled in the sub-process Non-Sec Inv Pre-Mitigation – EL in the process INV_RWA_CALCULATION_IRB.

8.1.2.5.3 RWA Calculations

IRB approaches calculate RWA for pre mitigation RWA unexpected loss (Non-Sec Inv Pre-Mitigation RWA – UL) as well as pre mitigation RWA expected loss (Non Sec Inv Pre-Mitigation RWA - EL).

These sub-processes are part of the process INV_RWA_CALCULATION_IRB.

8.1.2.6 Credit Risk Mitigation Process

8.1.2.6.1 Mitigant Approaches and their Risk weighting rules (different from STD)

The mitigant approaches applicable for IRB are only the Comprehensive Approach for Collateral recognition. This is same as in [Standardized Approach](#).

And in the case of unfunded mitigant in the form of guarantee and credit derivatives, the risk weights are calculated by using the PD of the mitigant provider, and the LGD of the covered exposure, and using the risk weight function as applicable for the mitigant asset class.

This is handled in the sub-process CAP Collateral Eligibility for IRB Mitigants in the process Mitigant Collateral Eligibility – Comprehensive Approach – BIS.

8.1.2.6.2 Mitigant Haircut Assignment

Under IRB approach, the bank can follow either supervisory estimates or banks estimate for Mitigant Haircut assignment. This is based on the various categories like mitigant type, residual maturity, rating, issuer type etc. This is applicable only if the bank follows comprehensive approach for collateral.

Only eligible mitigants are considered for haircut assignment and for further processing. Post haircut assignment, the eligible mitigants are moved from mitigants table (FSI_CAP_MITIGANTS) to sub exposures table (FSI_CAP_SUB_EXPOSURES).

The application does computations for three kinds of mitigant haircuts, which are volatility haircut, Forex haircut, and maturity mismatch haircut.

Volatility Haircut

Volatility haircuts are assigned to the collateral to account for any future fluctuations in the market value of the financial collateral. The application assign haircuts for various type of financial collateral like debt securities, equity, mutual funds, and so on. In the supervisory haircut method, the application assigns volatility haircut based on issues, issuer's ratings, mitigant's residual maturity, and type of mitigant.

This is handled in CAP CRM Mitigant Volatility Haircut - Supervisory Haircut under CRM Sub Exposure Data Haircut Assignment process.

Forex Haircut

If the exposure and collateral are in different currencies, then the application makes an adjustment by applying the FOREX haircut.

This is handled in CAP CRM Forex Haircut Sub Exposures under CRM Sub Exposure Data Haircut Assignment process.

Maturity Mismatch Haircut

If the residual maturity of the Credit Risk Mitigant is less than that of the underlying credit exposure, then a maturity mismatch haircut is applied to adjust the value.

This is handled under CAP CRM Maturity Mismatch Haircut under CRM Sub Exposure Data Haircut Assignment process.

There are two methods for assigning volatility haircut:

- Supervisory Haircut
- Own Estimate

This is handled in the sub-process CRM Sub Exposure Data Haircut Assignment in the process CRM Processing – Non-Sec.

Supervisory Estimate

For supervisory haircut method, the application assigns volatility haircut based on issuers, issuer's ratings, mitigants residual maturity, and type of mitigant, as recommended by the regulator

Own Estimate (different from STD)

For Own Estimate method, the application considers the banks own estimate values for haircut instead of using the supervisor's values.

8.1.3 Pooling and Optimizer

8.1.3.1 Pooling

Pooling is one of the pre-requisites for the optimized allocation of the exposures.

Pooling pulls out an exposure, and identifies all the relevant mitigants mapped to it, and the corresponding exposures mapped to these mitigants, and again the corresponding newer mitigants mapped to these exposures. This pooling assigns the cardinality to the exposures based on the mitigant combination.

This happens in the FSI Cap Sub Exposures (FSI_CAP_SUB_EXPOSURES), and the pooling is part of the sub process.

The relevant cardinalities that are assigned to the exposures, as part of this pooling process are as below:

- 1-0 → One exposure not mapped to any mitigant
- 1-1 → One exposure mapped to one mitigant
- 1-N → One exposure mapped to multiple mitigants
- N-1 → Multiple exposures mapped to a single mitigant
- N-N → Multiple exposures mapped to multiple mitigants

8.1.3.2 Optimizer

The optimizer is the process of allocation of the mitigants to the exposures, based on the different logic applicable for the various granularity. The details of this is available in the [Annexure](#).

Both Pooling and Optimizer is handled under the process **CRM Sub Exposure Pooling and Optimizer Processing**.

8.1.3.2.1 Post CRM RWA

The application computes the covered amount and the uncovered amount for the exposures. The covered amount is computed by multiplying the covered factor with the exposure amount. To this covered amount, the application assigns the mitigant risk weight. The product of the covered amount and the mitigant risk weight is the covered RWA. The uncovered amount is computed by multiplying the uncovered factor (which is 1 – sum of all covered factors for that exposure) with the exposure amount. This uncovered amount is multiplied by the exposure risk weight to get the uncovered RWA. The sum of the covered RWA and the uncovered RWA is the Post CRM RWA of the Exposure.

$$\text{Post-CRM RWA} = \text{Covered Amount} * \text{Risk Weight of the Mitigant} \\ + \text{Uncovered Amount} * \text{Risk Weight of the Exposure}$$

8.2 Counterparty Credit RWA

Counterparty Credit RWA is explained in detail under the Counterparty Credit RWA section in this document

8.2.1 Derivatives Portfolio

8.2.1.1 Rating Population

The rating population in the case of IRB Approach is not relevant, and is used only for the mitigants, as they are used for the mitigant eligibility and supervisory haircut rules. This is explained in the [Standardized Approach](#) section.

8.2.1.2 Data Population

Data Population is explained in detail under the **Derivatives** Portfolio sub section of the Counterparty Credit RWA section in this document

The process name for data population is

- DERIVATIVE_SWAPS_EXPOSURE_DATA_POPULATION,
- DERIVATIVE_FUT_EXPOSURE_DATA_POPULATION,
- DERIVATIVE_OPT_EXPOSURE_DATA_POPULATION,
- DERIVATIVE_FORWARDS_EXPOSURE_DATA_POPULATION and
- DERIVATIVE_CREDIT_DERIVATIVE_DATA_POPULATION

8.2.1.3 Shareholding Percent Multiplication

The shareholding percent multiplication for the various amounts associated with the exposure remains the same as in Standardized approach.

8.2.1.4 Common Reclassification Rules

The reclassification rules are consistently the same across all the approaches of the calculations. See [Standardized Approach](#) for more details on the same. This is happening in the process DRV_RECLASSIFICATION_IRB (process)

8.2.1.5 Asset Reclassification Rules

The asset reclassification is based on the various combinations of the Basel product type and the standard counterparty type and any other filters as relevant. This remains functionally the same as Standardized Approach.

For AIRB, Process Name: DRV_RECLASSIFICATION_AIRB

For FIRB Process Name: DRV_RECLASSIFICATION_FIRB

The sub-processes in both as follows:

BIS - Derivative Basel Asset Reclassification based on Party Type - STD

8.2.1.6 Pre-mitigation Calculations

Some exposures can be hedged against credit risk through various mitigants like guarantors, collaterals, credit derivatives, and so on. These provide mitigation to credit risk and must be considered while computing Credit RWA as per Basel norms. Hence, the application calculates pre-mitigation risk-weighted assets amount and post-mitigation risk-weighted assets amount.

The application calculates the correlation factor using the formula specified for each asset class. Using Correlation factor, PD, and LGD, the application calculates the pre-mitigation capital charge for each exposure. This value signifies the capital charge the bank has to maintain for each exposure, prior to considering any mitigation effects.

The application calculates pre-mitigation exposure at default amount and risk weight for each exposure. Further, it computes pre-mitigation risk-weighted assets (DRV_PRE_CRM_RISK-WEIGHTED_ASSET_CALC) by multiplying the EAD by risk weight. The risk weight is arrived at by multiplying pre-mitigation capital charge with 12.5.

8.2.1.6.1 Exposure at Default Amount Calculation

The Exposure at Default amount for derivatives can be computed using either the approach of standardized Approach (SA CCR) or the Internal Model Method (IMM), based on the supervisory approval received by the bank.

This happens in the sub-process **DRV_EAD_CALCULATION_IRB** in **Derivative Data Processing**,

FIRB - DRV_EAD_CALCULATION_FIRB

AIRB - DRV_EAD_CALCULATION_AIRB

8.2.1.6.2 Methods for calculating EAD

There are two methods of computing EAD for banks following IRB Approach – Standardized Approach (SA CCR) and Internal Model Method (IMM).

1. Standardized Approach (SA CCR)

This is same as detailed in the [Standardized Approach](#). This is applicable for all derivative exposures in the form of OTC derivatives, Cleared Transactions, Exchange Traded Derivatives and Long Settlement Transactions.

This is handled in the process DERIVATIVE_SACCR_EAD_CALCULATION.

2. Internal Model Method (IMM)

In the case of IMM Approach, the Exposure amount gets computed outside the application, by using the various cross product netting and other related calculation mechanism at a counterparty's portfolio level. And this is being provided as an input.

This is handled in the process Derivative Pool EAD Calculation - OTC - Internal Model Method

8.2.1.6.3 Post CRM EAD

Through the CRM process, the bank considers the effect of the mitigation and calculates the post-mitigation exposure at the default amount. This signifies the maximum loss that the bank can suffer in case of default on this exposure, after considering the effects of the mitigation. This will be the EAD of the Exposure Pre-Mitigation less the covered portion of the mitigant

8.2.1.6.4 Capital Charge Rules

In the case of IRB Approach, the Capital charge is being computed for both unexpected loss as well as Expected loss.

1. Unexpected Loss Calculations

Unexpected Loss is calculated as using the Probability of Default (PD), Loss Given Default (LGD), Effective Maturity (M) and Correlation Factor.

This is handled in the sub-process Derivative Pre-Mitigation Capital Required for UL

For FIRB - in the process DRV_CAPITAL_CALCULATION_FIRB

For AIRB - in the process DRV_CAPITAL_CALCULATION_AIRB.

a. PD Calculations

Probability of Default (PD) signifies the likelihood of a borrower failing to meet his/her financial obligations. In both FIRB and AIRB, PD values are expected as input/download from the bank. This gets captured as part of the data population process.

There are certain flooring requirements and capping requirements which are specified for each of the asset class.

This gets handled in the sub process as below:

For FIRB - In the sub-process PD_LGD_ASSIGNMENT_FIRB in the process Derivative Data Processing – FIRB.

For AIRB - In the sub-process PD_LGD_ASSIGNMENT_AIRB in the process Derivative Data Processing – AIRB.

b. LGD Calculations

Loss Given Default (LGD) signifies the portion of the exposure that is likely to be lost in case the borrower defaults. In FIRB, LGD is computed by the application, as per the regulatory ask for each of the asset class. And in the case of AIRB, LGD is also expected as a download.

All PD and LGD calculations are handled in the process as below:

For FIRB - In the sub-process DRV_PD_LGD_ASSIGNMENT_FIRB in the process Derivative Data Processing – FIRB.

For AIRB - In the sub-process PD_LGD_ASSIGNMENT_AIRB in the process Derivative Data Processing – AIRB.

c. Effective Maturity Calculations

Effective maturity (M) will be 2.5 years for exposures to which the bank applies the foundation approach, except for repo-style transactions where the effective maturity is 6 months (i.e. $M=0.5$). And in the case of AIRB, this is also expected to be provided by the bank using the modeling requirement.

The effective maturity (M) is subject to a floor of one year and a cap of 5 years

All maturity calculation is handled in the process as below:

For FIRB - In the sub-process MATURITY_CALCULATION_AND_ASSIGNMENT_FIRB in the process Derivative Data Processing – FIRB.

For AIRB - In the sub-process MATURITY_CALCULATION_AND_ASSIGNMENT_AIRB in the process Derivative Data Processing – AIRB.

d. Correlation Calculations

The correlation is being computed as per the requirement provided by the regulator by using all the inputs of PD, LGD, EAD and Effective Maturity.

As per the regulatory ask, the application assigns the multiplier of 1.25 to the Asset Value Correlation (AVC) of exposures wherever relevant. These exposures relate to regulated financial firms with assets of at least 100 billion USD and to exposures of unregulated financial firms (regardless of size). This gets consumed in the correlation formulae applicable for the asset class specific calculation, as specified by the regulator.

e. Capital Charge Calculations

The capital charge for the unexpected loss is computed using the regulatory provided calculation specific for the asset classes. This gets handled in the process as below:

For FIRB - in the process CAPITAL_CALCULATION_FIRB

For AIRB - in the process CAPITAL_CALCULATION_AIRB

2. Expected Loss calculation

Expected loss is the loss which the bank expects it will incur during holding the exposure. This is mostly computed by using the attributes of PD, LGD and EAD.

This is calculated as the product of PD, LGD and EAD. This is applicable for most of the asset classes.

This is handled in the sub-process Derivative Pre-Mitigation

For FIRB - In the process PRE_CRM_RISK_WEIGHTED_ASSET_CALCULATION_FIRB

For AIRB - In the process PRE_CRM_RISK_WEIGHTED_ASSET_CALCULATION_AIRB

8.2.1.6.5 RWA Calculations

IRB approaches calculate RWA for dilution risk, Pre mitigation RWA unexpected loss (Derivative Pre-Mitigation RWA – UL) as well as pre mitigation RWA expected loss (Derivative Pre-Mitigation RWA – EL).

All these sub-processes can be found in the below process:

For FIRB - In the process PRE_CRM_RISK_WEIGHTED_ASSET_CALCULATION_FIRB

For AIRB - In the process PRE_CRM_RISK_WEIGHTED_ASSET_CALCULATION_AIRB

8.2.1.6.6 Post CRM RWA

Pre mitigation EAD is divided into Post Mitigation EAD for the covered portion and Post Mitigation EAD for the uncovered portion. Covered portion is the portion of the exposure covered by the mitigant and uncovered portion is portion of the exposure not covered by the mitigant. There will be more than one record for the covered portion of that exposure. Post mitigation RWA UL (Post CRM RWA UL) is calculated by multiplying post mitigation EAD and its Capital Required UL. Post mitigation RWA Expected Loss is calculated by multiplying the PD, LGD, and post mitigation EAD amount.

The application computes the covered amount and the uncovered amount for the derivative exposures at the nettable pool and mitigant level combination. The same is being carried back to the nettable pool level, and hence to the exposure level.

The covered amount is computed by multiplying the covered factor with the exposure amount. To this covered amount, the application assigns the mitigant risk weight. The product of the covered amount and the mitigant risk weight is the covered RWA. The uncovered amount is computed by multiplying the uncovered factor (which is 1 – sum of all covered factors for that exposure) with the exposure amount. This uncovered amount is multiplied by the exposure risk weight to get the uncovered RWA. The sum of the covered RWA and the uncovered RWA is the Post CRM RWA of the exposure.

Post CRM EAD + Post CRM EL Amount + Post CRM Capital UL

See [Post CRM RWA Calculations](#) for more information.

8.2.2 Securities Financing Transactions Portfolio

Securities Financing Transactions (SFT) include Repo Style transactions, Margin Lending, Security Financing Borrowing, and so on. Under IRB method we have two approaches:

1. VaR approach – This is the approach wherein the EAD will be the effective exposure amount and there won't be a need of EAD calculation
2. Comprehensive approach – This is the approach wherein the collateral undergoes haircut treatment, and the exposure value gets reduced from this portion

For all SFT contracts which have a placed collateral or mitigant mapped to it, the application computes CRM based on the RWA approach undertaken by the bank.

Process Flow for Credit Risk Securities Financing Transactions

Figure 55: Process Flow for Credit Risk Securities Financing Transactions

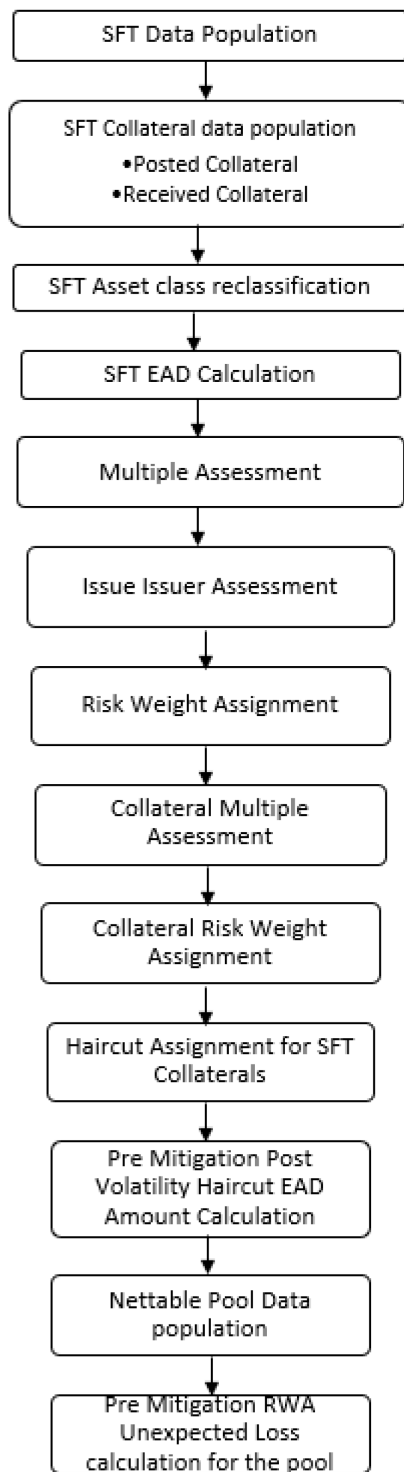

8.2.2.1 Rating Population

The rating population in the case of IRB Approach is not relevant and is used only for the mitigants and placed collateral, as they are used for the mitigant eligibility rules.

Rating population is handled as part of the BIS Common Data Processing in the sub process Credit Rating Data Population. See [Standardized Approach](#) for the details.

8.2.2.2 Data Population

Data Population is handled as part of the sub process SFT_DATA_POPULATION under the process SFT Data Processing.

The data population remains the same as in [Standardized Approach](#).

In addition to the Product Processor tables, FSI Setup Account Modeling Information (FSI_SETUP_ACCT_MODELING_INFO) is used for providing the input required for the Capital charge calculation, and which are based on the bank's specific models. Some of the attributes picked up from this table are PD, LGD in the case of AIRB approach, Effective Maturity, CCF Own Estimate (in the case of AIRB approach) etc.

8.2.2.3 Shareholding Percent Multiplication

The shareholding percent multiplication for the various amounts associated with the exposure remains the same as in [Standardized Approach](#).

This is handled as part of the sub process Common Data Processing under BIS Common Data Processing

8.2.2.4 Common Reclassification Rules

The reclassification rules are consistently the same across all the approaches of the calculations. This is same as in [Standardized Approach](#).

This is handled as part of the sub process COMMON_RECLASSIFICATION under Common Data Processing process.

8.2.2.5 Asset Reclassification Rules

The asset reclassification is based on the various combinations of the Basel product type and the standard counterparty type and any other filters as relevant. This remains functionally the same as in [Standardized Approach](#).

This is handled in sub process SEC_RECLASSIFICATION_IRB under the process SFT_DATA_PROCESSING_FIRB or SFT_DATA_PROCESSING_AIRB

8.2.2.6 Pre-mitigation Calculations

8.2.2.6.1 Exposure at Default Amount Calculation

Pre-mitigation Exposure at Default can be calculated using one of the two approaches of EAD – VaR Approach and Comprehensive Approach. This is based on run management selection.

8.2.2.6.2 Calculation of EAD – Comprehensive Approach

This is same as detailed in the [Standardized Approach](#). This is applicable for all SFT exposures.

This is handled in the process SFT_DATA_PROCESSING_FIRB for FIRB or SFT_DATA_PROCESSING_AIRB for AIRB and the sub process is SFT_EAD_CALC_IRB.

8.2.2.6.3 Calculation of EAD - VaR Method

For the Calculation of EAD under VaR Method, if the exposure is part of the netting set level then the EAD will be based on the effective exposure amount of the netted pool i.e. aggregated at the counterparty level.

This is handled as part of the SFT_NETTING_CALCULATION and if the exposure is other than the netting set the EAD will be on the effective exposure amount of each exposure level.

This is part of the process_SFT_EXP_AND_PLACED_COLLATERAL_PROCESSING_STD if the exposures are not part of netting agreement.

8.2.2.6.4 Capital Charge Rules

In the case of IRB Approach, the Capital charge is being computed for both unexpected loss as well as Expected loss.

1. Unexpected Loss Calculations

Unexpected Loss is calculated as using the Probability of Default (PD), Loss Given Default (LGD), Effective Maturity (M) and Correlation Factor.

This is handled in the sub-process

For FIRB - in the process SFT_CAPITAL_CALCULATION_FIRB

For AIRB - in the process SFT_CAPITAL_CALCULATION_AIRB.

The capital charge rules are applicable if the comprehensive approach is selected and the same is handled in the sub process SFT_DATA_PROCESSING_FIRB or SFT_DATA_PROCESSING_AIRB and in case of the VaR approach the application handles in different way under the sub process SFT_PROCESSING_INTERNAL_MODEL_METHOD.

The LGD calculation will be applicable for the both the Comprehensive and VaR approaches.

But the PD, Effective Maturity calculations and Asset value correlation calculations are applicable only under Comprehensive approach.

a. PD Calculations

Probability of Default (PD) signifies the likelihood of a borrower failing to meet his/her financial obligations. In both FIRB and AIRB, PD values are expected as input/download from the bank. This gets captured as part of the data population process.

There are certain flooring requirements and capping requirements which are specified for each of the asset class.

This gets handled in the sub process as below:

For FIRB - In the sub-process PD_LGD_ASSIGNMENT_FIRB in the process SFT Data Processing – FIRB.

For AIRB - In the sub-process PD_LGD_ASSIGNMENT_AIRB in the process SFT Data Processing – AIRB.

b. LGD Calculations

Loss Given Default (LGD) signifies the portion of the exposure that is likely to be lost in case the borrower defaults. In FIRB, LGD is computed by the application, as per the regulatory ask for each of the asset class. And in the case of AIRB, LGD is also expected as a download.

All PD and LGD calculations are handled in the process as below:

For FIRB - In the sub-process PD_LGD_ASSIGNMENT_FIRB in the process SFT Data Processing – FIRB.

For AIRB - In the sub-process PD_LGD_ASSIGNMENT_AIRB in the process SFT Data Processing – AIRB.

In case if the VaR approach is selected under the run management selection the LGD assignment is handled as part of the sub process SFT_PROCESSING_INTERNAL_MODEL_METHOD.

c. Effective Maturity Calculations

Effective maturity (M) will be 2.5 years for exposures to which the bank applies the foundation approach, except for repo-style transactions where the effective maturity is 6 months (i.e. $M=0.5$). And in the case of AIRB, this is also expected to be provided by the bank using the modeling requirement.

The effective maturity (M) is subject to a floor of one year and a cap of 5 years

All maturity calculation is handled

For FIRB - In the sub-process SFT_MATURITY_ASSIGNMENT_FIRB in the process SFT Data Processing – FIRB.

For AIRB - In the sub-process SFT_MATURITY_ASSIGNMENT_FARB in the process SFT Data Processing – AIRB.

d. Correlation Calculations

The correlation is being computed as per the requirement provided by the regulator by using all the inputs of PD, LGD, EAD and Effective Maturity.

As per the regulatory ask, the application assigns the multiplier of 1.25 to the Asset Value Correlation (AVC) of exposures wherever relevant. These exposures relate to regulated financial firms with assets of at least 100 billion USD and to exposures of unregulated financial firms (regardless of size). This gets consumed in the correlation formulae applicable for the asset classes specific calculation, as specified by the regulator.

For FIRB - In the sub-process SFT_CAPITAL_CALCULATION_FIRB in the process SFT Data Processing – FIRB.

For AIRB - In the sub-process SFT_CAPITAL_CALCULATION_AIRB in the process SFT Data Processing – AIRB.

e. Capital Charge Calculations

The capital charge for the unexpected loss is computed using the regulatory provided calculation specific for the asset classes. This gets handled in the process as below:

For FIRB - In the sub-process SFT_CAPITAL_CALCULATION_FIRB in the process SFT Data Processing – FIRB.

For AIRB - In the sub-process SFT_CAPITAL_CALCULATION_AIRB in the process SFT Data Processing – AIRB.

2. Expected Loss calculation

Expected loss is the loss which the bank expects it will incur during holding the exposure. This is mostly computed by using the attributes of PD, LGD and EAD

This is calculated as the product of PD, LGD and EAD. This is applicable for most of the asset classes.

This is handled in the sub-process SFT_RISK_WEIGHT_ASSET_CALCULATION_FIRB or SFT_RISK_WEIGHT_ASSET_CALCULATION_AIRB.

8.2.2.6.5 RWA Calculations

IRB approaches calculate RWA for unexpected loss (SFT Pre-Mitigation RWA – UL) as well as pre mitigation RWA expected loss (SFT Pre-Mitigation RWA – EL).

All these sub-processes can be found in the below process:

- For FIRB - In the process PRE_CRM_RISK_WEIGHTED_ASSET_CALCULATION_FIRB
- For AIRB - In the process PRE_CRM_RISK_WEIGHTED_ASSET_CALCULATION_AIRB

8.2.3 Pooling and Optimizer

8.2.3.1 Pooling

Pooling is one of the pre-requisites for the optimized allocation of the exposures.

Pooling pulls out an exposure, and identifies all the relevant mitigants mapped to it, and the corresponding exposures mapped to these mitigants, and again the corresponding newer mitigants mapped to these exposures. This pooling assigns the cardinality to the exposures based on the mitigant combination.

This happens in the FSI Cap Sub Exposures (FSI_CAP_SUB_EXPOSURES), and the pooling is part of the sub process

The relevant cardinalities that get assigned to the exposures, as part of this pooling process are as below:

- 1-0 → One exposure not mapped to any mitigant
- 1-1 → One exposure mapped to one mitigant
- 1-N → One exposure mapped to multiple mitigants
- N-1 → Multiple exposures mapped to a single mitigant
- N-N → Multiple exposures mapped to Multiple mitigants

8.2.3.2 Optimizer

The optimizer is the process of allocation of the mitigants to the exposures, based on the different logic applicable for the various granularity. The details of this are available in the [Annexure](#).

Both Pooling and Optimizer is handled under the process CRM Sub Exposure Pooling and Optimizer Processing.

8.2.3.3 Post CRM RWA

The application computes the covered amount and the uncovered amount for the exposures. The covered amount is computed by multiplying the covered factor with the exposure amount. To this covered amount, the application assigns the mitigant risk weight. The product of the covered amount and the mitigant risk weight is the covered RWA. The uncovered amount is computed by multiplying the uncovered factor (which is 1 – sum of all covered factors for that exposure) with the exposure amount. This uncovered amount is multiplied by the exposure risk weight to get the uncovered RWA.

The sum of the covered RWA and the uncovered RWA is the Post CRM RWA of the Exposure.

$$\text{Post-CRM RWA} = \text{Covered Amount} * \text{Risk Weight of the Mitigant} \\ + \text{Uncovered Amount} * \text{Risk Weight of the Exposure}$$

8.3 Default Fund Contributions Related Capital Charge

A default fund contribution refers to the funds contributed, or commitments made by a clearing member to a Central Counterparty's (CCP) equalized loss sharing agreement. The purpose of such default funds is to provide capital, in addition to the collateral posted by participants and in addition to capital provided by the clearinghouse, as a safeguard against extraordinary losses that might occur in connection with.

For example, a financial crisis in the market or the simultaneous defaults of several large members. The clearing members contribute to such default funds kept with the central counterparty (clearing house) in the proportion of their exposure to the central counterparty.

The default fund contributions by the clearing members contribute toward the central counterparty's regulatory capital along with CCP's own contributions to the default fund. These contributions act as collaterals to mutually share in the losses incurred by the clearing members due to counterparty defaults.

For each clearing member, a contribution is made to the central counterparty's default fund.

This contribution acts as a relief against the defaults by any clearing member of the central counterparty.

The application handles the treatment of exposures to a QCCP and a Non-QCCP. This qualified CCP flag is expected to be provided as a download in the Party Master (**STG_PARTY_MASTER**) table.

8.3.1 Capital Charge for Non-QCCP

If the CCP is not a qualified CCP (Non-QCCP), then the risk-weighted asset amount for the banking organization's default fund contribution is calculated using the Own funds requirements for pre-funded contributions to the default fund of a non-qualifying CCP approach, as suggested in the accord.

8.3.2 Capital Charge for QCCP

If the CCP is a qualified CCP (QCCP), then the RWA amount is computed using one of the following two approaches stated below. Both are handled in the same Sub process - RWA For Default Fund Contribution With QCCP. This is based on the run management option selected.

- Own funds requirements for pre-funded contributions to the default fund of a QCCP.
- Alternative calculation of own funds requirement for exposures to a QCCP.

The approach to use of either the own fund requirements for QCCP or the alternative approach of the own fund requirements for QCCP is based on the run management option.

Approach 1

For the purpose of computing the clearing member's capital requirement, which is the reporting bank's capital requirement for the contributions made to the CCP's default fund, the hypothetical capital requirement of the central counterparty for the default fund must be known. This must be computed by the central counterparty based on the exposures of all the clearing members to the default fund. After this figure is calculated by the CCP, it is shared with all the clearing members to enable them and to compute their respective capital requirements against the default fund.

When the reporting bank gets the hypothetical capital requirement from the QCCP, next step is to compute the capital requirement of the reporting bank by finding out the proportion of the reporting bank's contribution in the total default fund contribution.

- The parameters considered for this purpose include the following QCCPs:
- Net potential exposure to the two largest clearing members,
- The total net potential exposure to all the clearing members,
- Total default fund contribution by all the clearing members,
- QCCP's own contribution to the default fund, and
- The total number of clearing members for the default fund.

The last step is to compute the risk-weighted assets of the reporting bank corresponding to the default fund contribution to the QCCP by using the capital computed in the previous step.

These steps and the calculation involved are the following:

Step 1:

It requires the QCCP to calculate its hypothetical capital requirement (KCCP) for the default fund. This is done by the QCCP and is published to the clearing members for them to use for their respective capital calculations.

Step 2:

Compare KCCP with the funded portion of the default fund of a QCCP and calculate the capital requirement of the bank (KCM) by using the total of all the clearing members' capital requirements (K*CM). This capital requirement is considered on the contribution that the clearing members make to the default fund of the QCCP.

Approach 2

Capital Charge for the default fund contribution is calculated as follows:

Capital charge (Ki) = 8% * minimum (2% of Trade exposures to the QCCP + 1250% * default fund contribution to the QCCP, 20% * Trade Exposure Amount to the QCCP).

The solution also supports the treatment of a CCP stopping to calculate its own fund requirement to the CCP. The flag to indicate that the CCP has stopped calculating the own fund requirement is captured in the party table (**STG_PARTY_MASTER**). And based on the supervisory approval provided, in the run management option, the capital will be calculated using the Alternative approach. Else, it is treated as a normal Credit Risk Exposure, part of the Corporate Asset class.

The flag to indicate that the CCP has stopped calculating the capital requirement is expected as part of the Party Master Table (**STG_PARTY_MASTER**). In the case of this flag being null, it is expected that the CCP is calculating the Total Capital and normal processing of QCCP or Non-QCCP happens.

Key Data Elements

Key data elements to be noted are listed in this section. To view the complete list of tables used, see the Download Specification document in [MOS](#).

- Default fund contributions and related data are expected at Default fund – Central Counterparty level in the entity Stage Central Counterparty Details (STG_CCP_DETAILS).
- Hypothetical Capital Requirement of CCP, Maximum Net Potential Exposure of clearing member of CCP, 2nd Maximum Net Potential Exposure of clearing member of CCP, Total Net Potential Exposure of clearing member of CCP, Number of Clearing Members to the CCP, Total funded Default Fund Contribution of all clearing members to the CCP, Total unfunded Default Fund Contribution of all clearing members to the CCP and Default fund contribution of CCP from its own funds for each central counterparty level required.
- Application supports only the capital requirement of the bank (KCM) based on Funded/Unfunded default contributions from all clearing members not by Initial Margin. But data model supports place holders to capture Total Initial Margin by all clearing members to CCP and Bank's initial margin posted to CCP.

8.4 Credit RWA for Securitization

As per the revised guidelines for securitization framework, which is focused on addressing the short comes of the existing guidelines, a revised hierarchy of approaches that replaces the existing approaches have been introduced.

The application assigns the appropriate approach to the exposures, based on the criteria specified in the Revised guidelines. The application assigns any of the below approaches under securitization standardized approach:

- Sec- Internal Ratings Based Approach (SEC-IRBA) - SSFA
- Sec- External Ratings Based Approach (SEC-ERBA)
- Sec -IAA Approach
- Sec 1250% RW

Process Flows for Securitization – Revised Framework

The procedure by which the application handles the advanced approach of securitization exposures is as follows:

Figure 56: Process Flows for Securitization – Revised Framework

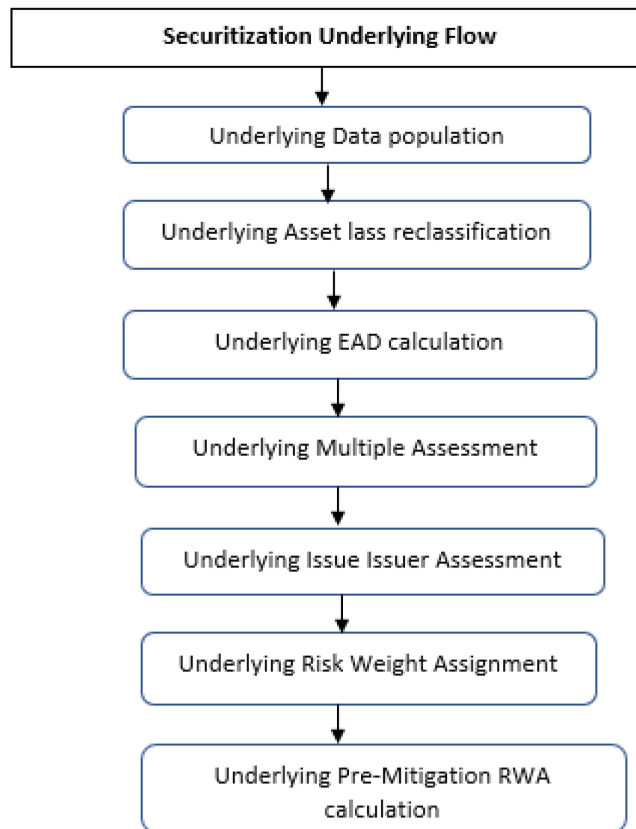

8.4.1 Data Population

Data Population is explained in detail under the [Data Population](#) of the Credit RWA for Securitization section in this document.

8.4.2 Shareholding Percent Multiplication

Shareholding Percent Multiplication is explained in detail under the [Shareholding Percent Multiplication](#) of the Credit RWA for Securitization section in this document.

8.4.3 Common Reclassification Rules

Common Reclassification Rules is explained in detail under the [Common Reclassification Rules](#) of the Credit RWA for Securitization section in this document.

8.4.4 Exposure at Default Amount Calculation

Exposure at Default process is explained in detail under the [Exposure at Default Calculation](#) of the Credit RWA for Securitization in this document.

8.4.5 Risk Weight Assignment Rules

8.4.5.1 Hierarchy of Approaches

As per the revised guidelines for securitization framework, which is focused on addressing the short comes of the existing guidelines, a revised hierarchy of approaches that replaces the existing approaches have been introduced.

The application assigns the appropriate approach to the exposures, based on the criteria specified in the Revised guidelines. The application assigns any of the three approaches under securitization:

- Sec-Internal Rating Based Approach (SEC-IRBA) – This is applicable for the exposures only if the underlying information is completely available.
- Sec-External Ratings Based Approach (SEC-ERBA) – This is based on supervisory approval and SEC 1250% is applicable.
- SEC – Internal Assessment Approach (SEC- IAA)
- SEC 1250% is applicable.

This is handled as part of the sub process SEC_APPROACH_IDENTIFICATION_AND_ASSIGNMENT under the process SEC_DATA_PROCESSING_IRB.

All the calculations happen as per the approaches are given below and they are part of the process SEC_DATA_PROCESSING_IRB

8.4.5.1.1 SEC – IRB

SEC-IRBA is the first approach to be calculated. The model that is used to calculate capital charge (KIRB) for underlying exposures using IRB is Simplified Supervisory Formula Approach (SSFA). For exposures which follow the sec-internal ratings-based approach, the application calculates the underlying weighted average capital of the securitization pool (KIRB).

The below sub process handles the KIRB calculation

SEC_KIRB_AVAILABLE_PCT_CALCULATION under the process SEC_DATA_PROCESSING_IRB

Further, the application calculates the required parameters based on the pool and tranche details. The application calculates these, using the logic specified by the accord. It also checks the exposure to identify whether the exposure must be straddled or not.

This check is based on the credit enhancement level of the tranche to which the exposure belongs to, the thickness of the tranche to which the exposure belongs to, and the underlying capital of the securitization pool. After all the parameters are calculated application computes SSFA capital and uses below mentioned logic for risk weight computation. The exposures for which are detachment point less than that of the KIRB, the exposures are risk-weighted at 1250%. The exposures for which the credit enhancement level is more than that of the KIRB, the exposures have the SSFA capital charge computed as per the formulae suggested in the accord. The exposures for which the credit enhancement level is less than that of the KIRB, but the sum of the credit enhancement level and the tranche thickness are more than the KIRB, the

exposures are straddled, and that is, the tranche to which the exposure belongs is split into a position below KIRB and a position above KIRB. All the exposures mapped to the straddled tranche are also split by the application in the same proportion as the split tranche. Post straddling risk weight is computed using the computation logic mentioned by the accord.

Once after the risk weights are assignment based on the above-mentioned process the application calculates the SEC_RISK_WEIGHT_CALCULATION under the process SEC_DATA_PROCESSING_IRB.

8.4.5.1.2 SEC – ERBA

SEC - ERBA is explained in detail under the [SEC - ERBA](#) of the Credit RWA for Securitization section in this document.

8.4.5.1.3 SEC – IAA

SEC - IAA is explained in detail under the [SEC - IAA](#) of the Credit RWA for Securitization section in this document.

8.4.5.1.4 SEC – STD

SEC - STD is explained in detail under the [SEC - STD](#) of the Credit RWA for Securitization section in this document.

8.4.5.1.5 Re-securitization Exposures

Re-securitization Exposures is explained in detail under the [Re-securitization Exposures](#) of the Credit RWA for Securitization section in this document.

This happens in the sub process RESEC_POOL_RW_CALCULATIONS under the process SEC_DATA_PROCESSING_IRB

8.4.6 Sec Pre-CRM RWA Computation

RWA Calculations is explained in detail under the [RWA Calculations](#) of the Credit RWA for Securitization section in this document.

This is handled in application under SEC_PRE_CRM_CAPITAL_CHARGE_IRB

8.4.7 Credit Risk Mitigation Process

8.4.7.1 Mitigant Eligibility

Mitigant Eligibility is explained in detail under the [Mitigant Eligibility](#) of the Credit RWA for Securitization section in this document.

8.4.7.2 Mitigant Approaches and their Risk Weighting Rules

Mitigant Approaches and their Risk weighting Rules is explained in detail under the [Mitigant Approaches and their Risk weighting Rules](#) of the Credit RWA for Securitization section in this document.

8.4.7.3 Mitigant Haircut Assignment

Mitigant Haircut Assignment is explained in detail under the [Mitigant Haircut Assignment Rules](#) of the Credit RWA for Securitization section in this document.

8.4.8 Pooling and Optimizer

8.4.8.1 Pooling

Pooling is one of the pre-requisites for the optimized allocation of the exposures.

Pooling pulls out an exposure, and identifies all the relevant mitigants mapped to it, and the corresponding exposures mapped to these mitigants, and again the corresponding newer mitigants mapped to these exposures. This pooling assigns the cardinality to the exposures based on the mitigant combination.

This happens in the FSI Cap Sub Exposures (FSI_CAP_SUB_EXPOSURES), and the pooling is part of the sub process

The relevant cardinalities that get assigned to the exposures, as part of this pooling process are as below:

- a. 1-0 → One exposure not mapped to any mitigant
- b. 1-1 → One exposure mapped to one mitigant
- c. 1-N → One exposure mapped to multiple mitigants
- d. N-1 → Multiple exposures mapped to a single mitigant
- e. N-N → Multiple exposures mapped to Multiple mitigants

8.4.8.2 Optimizer

The optimizer is the process of allocation of the mitigants to the exposures, based on the different logic applicable for the various granularity. The details of this is available in the [Annexure](#).

Both Pooling and Optimizer is handled under the process CRM Sub Exposure Pooling and Optimizer Processing.

8.4.8.3 Post CRM RWA

The application computes the covered amount and the uncovered amount for the exposures. The covered amount is computed by multiplying the covered factor with the exposure amount. To this covered amount, the application assigns the mitigant risk weight.

Post-CRM RWA = Covered Amount * Risk Weight of the Mitigant + Uncovered Amount * Risk Weight of the Exposure.

The product of the covered amount and the mitigant risk weight is the covered RWA. The uncovered amount is computed by multiplying the uncovered factor (which is 1 – sum of all covered factors for that exposure) with the exposure amount. This uncovered amount is multiplied by the exposure risk weight to get the uncovered RWA. The sum of the covered RWA and the uncovered RWA is the Post CRM RWA of the Exposure. This logic is handled in Sec Post CRM RWA calculation sub process.

8.5 Market Risk RWA

For information on Market Risk RWA, see section [Market Risk RWA](#).

8.6 Operational Risk RWA

For information on Operational Risk RWA, see section [Operational Risk Portfolio](#).

8.7 Capital Structure

For information on Capital Structure, see section [Capital Structure](#).

8.7.1 Provision calculation changes specific for IRB

For IRB, the application also computes General provision, total provision, Estimated loss greater than provisions specific to IRB and excess of total eligible provision which will be part of gross T2.

And this is handled inside the sub process PROVISION_CALCULATION (PMFBISCS005) in Capital Structure Data Processing (PMFBISCS021) process.

8.8 Capital Buffer

For information on Capital Buffer, see section [Capital Buffers](#).

8.9 Large Exposures

For information on Large Exposures, see section [Large Exposures](#).

8.10 Leverage Ratio

For information on Leverage Ratio, see section [Leverage Ratio](#).

9 Basel III: Finalizing Post Crisis Reforms - Standardized Approach

Capital Adequacy guidelines as issued in the following regulations are incorporated in OFS Financial Services Basel Regulatory Capital:

- Basel III: Finalizing post-crisis reforms – December 2017
- Minimum capital requirements for market risk – January 2019

The OFS Basel Regulatory Capital complies with the below functionality:

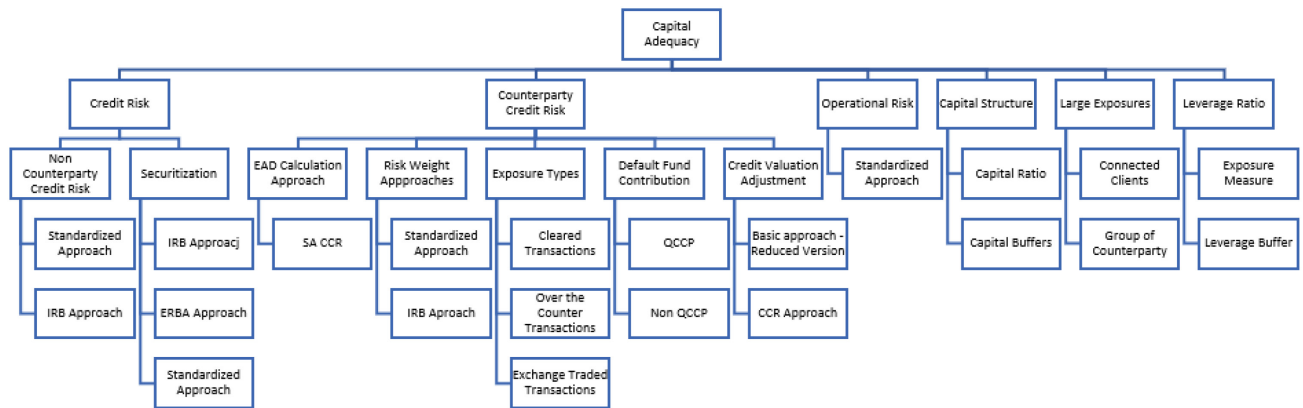

9.1 Credit RWA

Credit RWA is the calculation of Non-securitization RWA.

This includes the portfolio of banking and investment for the non-securitized exposures and the securitization portfolio for the securitization positions. The application complies with the standardized approach and IRB approach of the credit risk calculations.

A few processes such as Credit Rating, Party Type Reclassification, and Mitigant Data Population are common between Credit RWA and Counterparty Credit RWA. This also includes the settlement risk calculation about the unsettled transactions depending on the number of days they are unsettled.

9.1.1 Banking Portfolio

9.1.1.1 Rating Population

The data on ratings is captured in the following rating specific tables:

- Account Rating Table (**STG_ACCOUNT_RATING_DETAILS**)
 - Ratings of all Credit Risk Banking Exposures are captured in this table.
- Party Rating Table (**STG_PARTY_RATING_DETAILS**)
 - Credit Rating for all customers and issuers are captured in this table.
- Sovereign Rating Table (**STG_SOVEREIGN_RATING_DETAILS**)

- Credit Rating for all countries is captured in this table.

9.1.1.1.1 Processing Steps

Banks obtain credit ratings from different sources, and these are provided as input in the application through the rating tables mentioned in the preceding list.

This is handled in the sub-process RATING_RECLASSIFICATION_POPULATION in the BIS III Post Crisis Banking Reclassifications process.

The application re-classifies the rating information to BIS Specific standard ratings. The out-of-box application supports the Fitch / Moodys / S&P and DBRS credit rating reclassification for Long Term and Short-Term ratings.

This is handled in the sub-process Credit Rating Reclassification in BIS III Post Crisis Banking Reclassifications process.

The rating reclassification lookup table FSI Rating Classification (**FSI_RATING_CLASSIFICATION**) is used to lookup reclassified standard ratings so that the reclassification rule is not repeated for each of the rating processing tables.

Ratings are populated from the stage tables (for example, **STG_PARTY_RATING_DETAILS**) to FSI tables (for example, **FSI_PARTY_RATING_DETAILS**) using the lookup table (**FSI_RATING_CLASSIFICATION**) to obtain a reclassified rating.

Ensure that all the columns as indicated in the DL Specs are mandatorily populated with data. For example, in the Stage Party Rating Details (**STG_PARTY_RATING_DETAILS**) table: Rating source code (**V_RATING_SRC_CODE**), Party Code (**V_PARTY_CD**), Purpose (**V_PURPOSE**) are required to be populated. The purpose code is to indicate whether the rating is a domestic rating or a foreign rating. If any other rating is provided, then the exposure is considered unrated.

9.1.1.2 Data Population

Credit Risk exposures are updated in the application for all the product types through their respective input tables known as Product Processors. Main categories of Credit Risk Banking exposures, along with their respective table names that are used as an input, are as follows:

Table 57: Data Population for Credit Risk Banking Exposures

Product	Source Product Processor
Assets Sold	STG_ASSETS_SOLD
Bills	STG_BILLS_CONTRACTS
Credit Cards	STG_CARDS
Guarantees	STG_GUARANTEES
Lease Contracts	STG_LEASE_CONTRACTS
Letters of Credit	STG_LC_CONTRACTS
Line of Credit	STG_CREDIT_LINE_DETAILS
Commitment Contracts	STG_COMMITMENT_CONTRACTS
Loans	STG_LOAN_CONTRACTS
Overdraft	STG_OD_ACCOUNTS

There is a data population for the mitigants that cater to all the types of mitigants like collateral, guarantee, and credit derivatives. There is a data population also for counter-guarantee provided for a mitigant.

Table 58: Data Population for Mitigants

Product	Source Product Processor
Mitigants – Financial Collateral, Non-Financial Collateral, Pledged Instruments, Guarantee, Credit Derivatives	STG_MITIGANTS
Counter Guarantee	STG_MITIGANT_COUNTER_GUARANTEE

There is a data population for the mapping between the exposures and the mitigants, as well as a mitigant to counter-guarantee mapping

Table 59: Data Population for Mapping between Exposures and Mitigants

Product	Source Table
Mapping for Exposures and Mitigants	STG_ACCOUNT_MITIGANT_MAP
Mapping for Guarantee and Counter Guarantee	STG_MITIGANT_CNTR_GUAR_MAPPING

Processing table details

All Credit Risk Banking exposures are loaded into the table, **FSI Cap Banking Exposures (FSI_CAP_BANKING_EXPOSURES)** where further processing happens for this portfolio of exposures till the computation for Pre-Credit Risk Mitigation process. This is handled in the process Banking Data Population.

9.1.1.3 Shareholding Percent Multiplication

Shareholding percent multiplication for common entity-level data is a part of the BIS Common Data Processing (PMFCOM020) process. In this, the application updates the shareholding percentage against each entity is updated with the value of 1 as the shareholding percent and for each child entity, the percentage is based on the parent’s holding percentage as specified for each child in Fact Entity Shareholding Percent table (FCT_ENTITY_SHR_HLD_PERCENT).

Shareholding percent multiplication for exposure level is part of each portfolio as well. In this process, the application multiplies the entity shareholding percentage for that entity for parent entity against exposure amount, undrawn amount, provision amount, and any other amount relevant for calculation related to that exposure and updates the same.

This is handled in the sub-process BNK_SHAREHOLDING_CALCULATION_STD in the process Banking Data Processing – STD.

9.1.1.4 Common Reclassification Rules

The application reclassifies the bank’s product types and party types to standard product and party types. Based on the standard product and party type, the asset class for each exposure is arrived at. Similarly, the application does reclassification for mitigant based on its mitigant types and reclassifies it to standard mitigant types.

Ensure that all products and party type and mitigants which are bank-specific are reclassified, as part of the setup activity. If they are not reclassified, the treatment might not happen as expected by the regulator.

Product Type Reclassification

Product types used by the reporting bank as input data are reclassified to standard product types as recommended in the Accord. The product types after reclassification are stored as Basel product types. For Example, Housing Loan is reclassified as Residential Mortgage Exposure.

This is handled in the Basel Product Type Reclassification which is part of the COMMON_RECLASSIFICATION process.

Party Type Reclassification

Similar to the product type, the customer type (which is stored as counterparty type) is also reclassified as the standard counterparty type. The customer information is expected in the Stage Party Master (STG_PARTY_MASTER), and this also includes the Party Type based on the Stage Party Type Master (STG_PARTY_TYPE_MASTER).

Party type reclassification Rules handle reclassification for customer types. For Example, an Individual is reclassified as Retail.

This is handled in the Party Type Reclassification which is part of the PARTY_TYPE_RECLASSIFICATION_POPULATION_STD process.

Other Reclassification

As part of the reclassification rules, any other data which is being brought inside the application like seniority, transaction type, and so on also get reclassified into OFSAA specific values. This is also mandatory to be done, as otherwise, data is not available for processing as required by the regulator. This happens as part of the process COMMON_RECLASSIFICATION.

9.1.1.5 Asset Reclassification Rules

Based on Basel product type and standard counterparty type, an asset class is formed by the application. This asset class is used for data processing. The asset class is the same as specified in the accord.

For example, Standard counterparty is Corporate non-SME and Corporate SME, the asset class is corporate. For Basel product type Residential Mortgage Exposure, the asset class is Claims Secured by Residential Real Estate.

The asset class for all mitigants is reclassified based on their standard mitigant types and standard issuer type. This happens in the BNK_RECLASSIFICATION_STD sub-process of the process BIS III Post Crisis Banking Data Processing.

9.1.1.6 Pre-mitigation Calculations

Based on the asset class, the application calculates the Pre-Credit Risk Mitigation (CRM) Exposure at Default (EAD) for each exposure. This value signifies the maximum loss that the bank can suffer, in case of default on this exposure, before considering any mitigation effects.

Some exposures can be hedged against credit risk through various mitigants such as guarantees, collaterals, credit derivatives, and so on. These provide mitigation to credit risk and must be considered while computing Credit RWA, as per the Accord. Hence, the application calculates the pre-mitigation exposure amount and post-mitigation exposure amount.

The application also computes pre-mitigation risk-weighted assets (Pre CRM RWA) and post-mitigation risk-weighted assets (Post CRM RWA) by multiplying the respective EAD by risk weight. The risk weight is arrived at, by considering the credit rating of the exposures and mitigants as per the guidelines.

9.1.1.6.1 Exposure at Default Amount Calculation

Credit Conversion Factor (CCF Assignment)

This is an input required for converting the off-balance sheet component of the exposure (undrawn portion associated with an on-balance sheet or off-balance sheet product, or the exposure amount of an off-balance sheet product). This is based on the supervisory provided values and is determined based on the product type and the maturity associated with the exposure.

This populates the Drawn CCF (for the CCF to be assigned to the exposure amount of the off-balance sheet product) and the Undrawn CCF (for the CCF to be assigned to the undrawn portion of the on balance sheet and off-balance sheet exposures).

This happens in the process **PCR CCF Assignment Based on Supervisory Estimates** in Banking Data Processing – STD process.

Pre CRM EAD

Exposure at Default (EAD) is calculated for all the products. This is being computed using the Exposure Amount (EOP Balance of the Exposure), Undrawn Amount of the Exposure (Undrawn Amount), and the

Credit Conversion Factor for the Off-Balance sheet Amount (CCF). This is computed for the on-balance sheet products separately, and the off-balance sheet products separately.

This happens in the sub-process **BNK_PRE_CRM_EAD_COMPUTATION_STD** in Banking Data Processing – STD process.

Post CRM EAD

Through the CRM process, the bank considers the effect of the mitigation and calculates the post-mitigation exposure at the default amount. This signifies the maximum loss that the bank can suffer in case of default on this exposure, after considering the effects of the mitigation. This will be the EAD of the Exposure Pre-Mitigation less the covered portion of the mitigant

9.1.1.6.2 Multiple Assessment

For exposures with multiple ratings, risk weight assignment is based on multiple assessment processes. For each exposure, the final rating is the worst of the best two ratings assigned to the exposure. In case of exposure having multiple ratings associated with the same risk weight and belonging to an equivalent rating, the same will be assigned to the exposure. In the case of exposure having only a single rating, the single rating and corresponding risk weight will be considered for the exposure.

The risk weight corresponding to this rating is then assigned to the exposure.

Exposures for multiple rating assessments are first moved into the table FSI Multiple Rating Processing (**FSI_MULTIPLE_RATING_PROCESSING**) wherein the ranking and final selection of which rating to use takes place.

This happens in the sub-process of **BNK_MULTIPLE_RATING_ASSESSMENT_DATA_POPULATION**, wherein the data for the multiple assessment processing gets populated into the FSI table.

In the task **BNK_MULTIPLE_RATING_ASSESSMENT**, the identification of the multiple rating for the exposure happens, and the **BNK_RISK_WEIGHT_METHODODOLOGY_ASSIGNMENT** assigns the actual risk weight, and the final rating assignment happens for the exposures.

All the above fall is a part of the **Banking Data Processing – STD** process.

9.1.1.6.3 Issue Issuer Assessment

For all the exposures that remain unrated after the multiple assessment processes, the issue issuer process is performed. This happens in the Issue Issuer Assessment sub-process (**BNK_BNK_ISSUE_ISSUER_ASSESSMENT**). In this case, the unrated exposures are assigned a reference rating based on the reference issue available or the rating of the party, whichever is applicable. These unrated exposures are assigned a risk weight based on the reference rating.

The reference rating is expected to be provided by the bank for the corresponding counterparty that is unrated in the Stage Issue Details (**STG_ISSUE_DETAILS**). The reference issue must have the seniority also provided as that will be used for identifying whether the reference is an eligible issue for this assessment. For unrated Banking exposures, the application does an issue-issuer assessment to infer a rating of the unrated exposures, based on the rating of a similar instrument (referred to as reference issue hereafter) issued by the same issuer. The reference issue is used only when it is of the same currency as the exposure and the exposure is senior or equivalent to the same. For the unavailable reference issue, the party rating is used. In the case of the party also being unrated, the exposure remains unrated. The application also considers the Domestic and Foreign Ratings and Long term and short-term ratings to be used for the sake of issue issuer assessment.

Also, the application populates whether the exposure is LT rated or ST rated, based on the rating assigned to the exposure.

9.1.1.6.4 Risk Weight Assignment Rules

Banking Exposures Risk Weight

Risk Weight is assigned based on asset class and the credit rating as per Basel guidelines. The risk weight rules operate on the risk weight table (FSI_RW_MAP_MASTER). Highly rated exposures are allocated low-risk weight and poorly rated exposures are allocated high-risk weights. If exposure has more than one rating (rated by more than one agency), then the final rating is assigned based on multiple assessments. The application updates the risk weights against the exposures directly, when ratings are not considered.

Options for risk-weighting are selected during Regulatory definition to update the required calculations as allowed by the specific jurisdiction. This is handled in Banking Post Crisis Risk Weight Assignment- ECRA and Banking Post Crisis Risk Weight Assignment- SCRA. If the jurisdiction allows the usage of External Ratings, it will be ECRA and if not, it will be SCRA.

For more details on the options, see the [Regulatory](#) Definition section.

Figure 60: Process flow for Risk Weight Assignment Rules

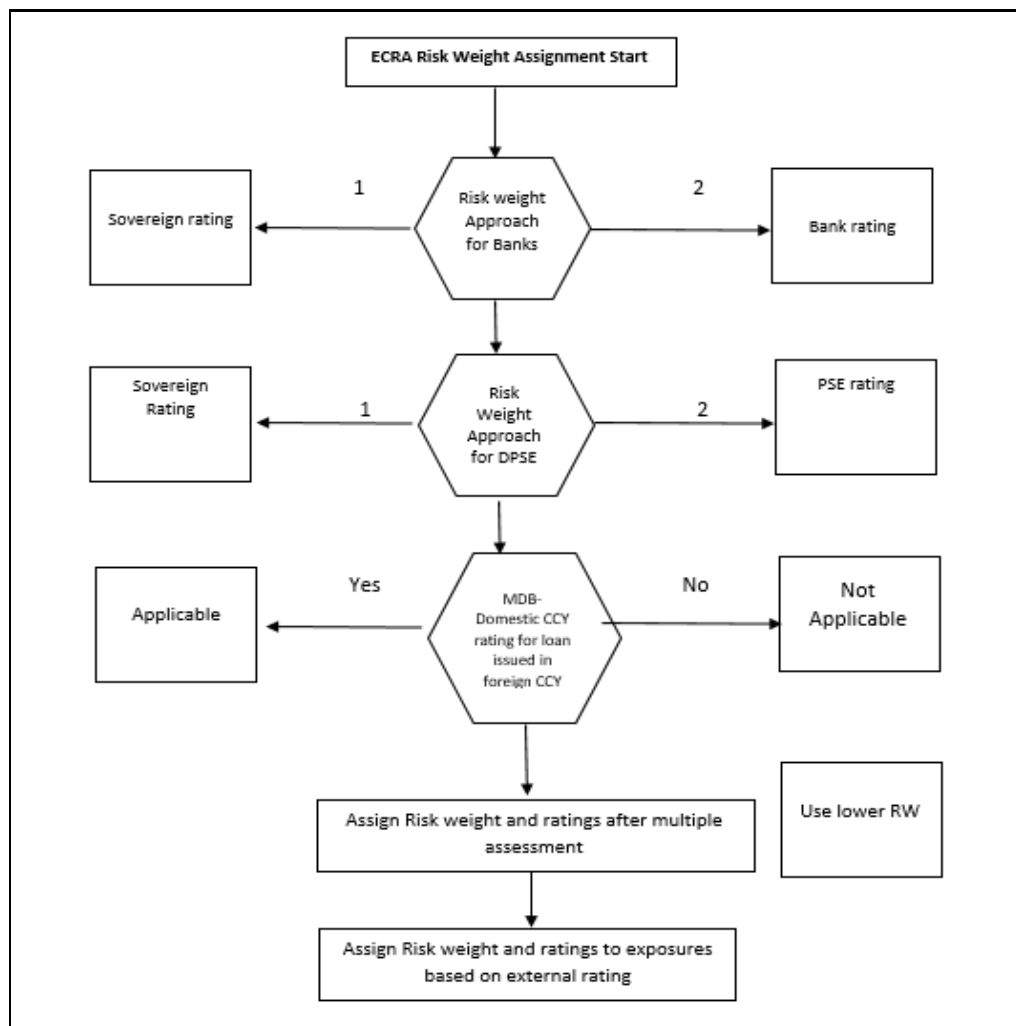

Risk weight assignment takes place in the sub-process Post Crisis Banking Data Processing – STD process.

This handles the risk weight assignment for all the risk classes. There are regulatory definitions that help in determining the actual risk weight to be used – like based on Sovereign Rating or Party Rating for the asset classes like Public Sector Entity, or options like whether the ECA scores can be considered for the risk weighting or not.

Risk Weight for Retail Exposures

There is a data population for Retail exposures which picks up relevant exposures from the Product tables and populates the same into the FSI cap bank retail exposures table (FSI_CAP_BANK_RETAIL_EXP). This is handled in the Banking Retail Related Data Population sub-process within the Banking Post Crisis for Data Population.

The Retail Exposures undergo the check to see whether they satisfy the different criterion specified – like the product criterion, granularity criterion, low value of threshold criterion, and based on the satisfaction of all the criterion the risk weight gets assigned.

Risk Weight for Residential Real Estate Exposures

Any residential real estate is risk-weighted, provided the repayment of the mortgage does not depend on the cash flows generated by the property and repayment is dependent on the credit worthiness of repayment capacity of the borrower instead of the property. The Risk weight treatment is stored in the FSI cap bank retail exposures table (FSI_CAP_BANK_RETAIL_EXP) and Fsi cap bank exposures table (FSI_CAP_BANKING EXPOSURES) handled in sub process PCR Retail Repayment Materially Dependent based Risk Weight Assignment in Post Crisis Banking Data Processing

Based on the regulatory definition options, the user can choose to Allow Residential Property under construction to be treated under a completed property or not.

Risk Weight for Commercial Real Estate Exposures

Commercial real estate exposures are exposures secured by any immovable property which do not qualify for residential real estate treatment. FSI cap bank retail exposures table (FSI_CAP_BANK_RETAIL_EXP) and FSI cap bank exposures table (FSI_CAP_BANKING EXPOSURES) handled in sub process PCR Retail Repayment Materially Dependent based Risk Weight Assignment in Post Crisis Banking Data Processing.

Risk Weight for Past Due Exposures

The application identifies the past due exposures on the basis of the defaulted flag. In certain jurisdictions, wherein there is an option to consider even 150% RW exposures as defaulted exposures, the same also gets considered for the past due treatment. The risk weight for the past due exposures are assigned based on the portion of the exposure that is unsecured and the provision coverage ratio for the same, This gets handled in the sub process BNK_PAST_DUE_TREATMENT_STD in Banking Data Processing – STD process, and also in the sub process **Specific Credit Risk Adjustment Ratio and RW Assignment for Defaulted Exposures** part of the process **BIS Post Crisis CRM Data Processing**

Unhedged Exposure Data Population

The unhedged foreign currency exposures are affected by the volatility in exchange rate movements. These impact the capacity of the holders to fulfill their credit obligations towards the banks and hence result in default losses and thereby affects the complete financial system.

The Unhedged fund data population picks up relevant exposures based on the unhedged indicator assignment. The unhedged fund split is handled in BANKING_EXPOSURE_SPLIT_RW_POP and BANKING_ADDITIONAL_SPLIT_RW_POP.

Unhedged fund data is input in stage hedge portfolio master table (STG_HEDGE_PORTFOLIO_SET_MASTER) which is populated to dim hedge portfolio table (DIM_HEDGE_PORTFOLIO_SET). The stage hedge portfolio master table (STG_HEDGE_PORTFL_SET_ACCT_MAP) maps the exposures with the hedging sets.

This is handled in the Additional Banking Exposure Population sub-process within the Banking Post Crisis for Data Population.

9.1.1.6.5 RWA Calculations

The RWA is calculated as the Pre-mitigation EAD multiplied by the Pre-Mitigation Risk Weight.

This is handled under the sub-process BNK_PRE_CRM_RISK_WEIGHTED_ASSET_CALCULATION_STD in Banking Data Processing – STD process.

9.1.1.7 Credit Risk Mitigation Process

In order to calculate the post CRM RWA, application needs to account for mitigants which may be in the form of collaterals, guarantees, credit derivatives. Not all mitigants are eligible for RWA computation. All the mitigants which get populated into the system are being made ineligible, and then the regulatory approved mitigant types and the issuer type combination are made eligible.

9.1.1.7.1 Mitigant Processing

Mitigant Data population

Mitigant data is loaded from the Stage Mitigant table (STG_MITIGANTS) into the FSI CAP Mitigants table (FSI_CAP_MITIGANTS) where further processing takes place. This is takes place under the sub-process Mitigant Data Population under the process Mitigant Data Processing.

Mitigant Multiple assessment

Similar to exposures with multiple ratings, mitigants with multiple ratings are also subject to Multiple rating Assessment. This is handled under the sub-process Mitigant Multiple Rating Assignment – BIS under the process Mitigant Data Processing. In the case of mitigants, the data is expected only for Instruments and Party.

This is performed by the Data Transformation **CAP_MITIGANT_MULTIPLE_ASSESSMENT_DATA_POP**.

9.1.1.7.2 Mitigant Approaches and their Risk Weighting Rules

Mitigant Risk Weight

For the Simple approach, the application assigns risk weight to mitigants based on credit rating (CAP Mitigant Basel Rating and Risk Weight Assignment), original maturity (CAP Mitigant RW Assignment based on Original Maturity), and for Nettable Liabilities (CAP Mitigant RW Assignment for Nettable Liabilities). These fall under the process Mitigant RW Assignment – Simple –BIS.

Similarly, for the Comprehensive approach, mitigant risk weights are assigned based on credit rating (CAP Mitigant Basel Rating and Risk Weight Assignment), for financial collaterals (CAP Mitigant RW Assignment for Financial Collaterals - Comprehensive Approach), and for nettable liabilities (CAP Mitigant RW Assignment for Nettable Liabilities). These fall under the process Mitigant RW Assignment – BIS – Comprehensive Appr.

Mitigant Eligibility

The application identifies the eligible mitigants based on the criteria as mentioned by the Regulator. The application identifies the following standard mitigants– collateral, guarantees, and credit derivatives.

The application is capable of using the Simple Approach and the Comprehensive Approach for the mitigants which are part of the collateral. The application identifies the eligibility of the financial collateral separately for the simple approach and the comprehensive approach. The eligibility of the collateral mitigants is based on the party type of the mitigant, mitigant types, the credit rating assigned to the mitigant or the party (as applicable), and the classification of collateral as senior or not. For equity, the eligibility is based on the main index equity and the equity trading status. This is handled in CAP Mitigant Eligibility for Equity - Simple approach under the process Mitigant Collateral Eligibility Simple Approach - BIS.

For mutual funds, the eligibility is based on the eligible mutual fund indicator. This is handled in CAP Mitigant Eligibility for Mutual Fund - Simple approach under the process Mitigant Collateral Eligibility Simple Approach -BIS

The application also identifies whether the mitigant is a Re-securitized exposure and if yes, makes it ineligible.

This is handled in CAP Collateral Eligibility - Simple Approach under the process Mitigant Collateral Eligibility Simple Approach -BIS

The application identifies the eligibility of the guarantees and credit derivatives based on the party type of the mitigant and the credit rating assigned to the issuer of the mitigant. This is handled in CAP Non-Sec Mitigant Eligibility under the process Mitigant Collateral Eligibility Simple Approach –BIS.

Similar mitigant eligibility rules for Comprehensive Rule can be found in the process Mitigant Collateral Eligibility – Comprehensive Approach –BIS

The option for the bank to select Collateral Simple Approach or Comprehensive Approach is based on the Run Management option as selected in the UI.

9.1.1.7.3 Mitigant Haircut Assignment

Under Standardized approach, the bank has to follow supervisory estimates for Mitigant Haircut assignment. This is based on the various categories like mitigant type, residual maturity, rating, issuer type and so on. This is applicable only if the bank follows comprehensive approach for collateral.

Only eligible mitigants are considered for haircut assignment and for further processing. Post haircut assignment, the eligible mitigants are moved from mitigants table (FSI_CAP_MITIGANTS) to sub-exposures table (FSI_CAP_SUB_EXPOSURES).

The application does computations for three kinds of mitigant haircuts which are volatility haircut, FOREX haircut, and maturity mismatch haircut.

Volatility Haircut

Volatility haircuts are assigned to the collateral to account for any future fluctuations in the market value of the financial collateral. The application assigns haircuts for various types of financial collateral like debt securities, equity, mutual funds, and so on. In the supervisory haircut method, the application assigns volatility haircut based on issues, issuer's ratings, mitigant's residual maturity, and type of mitigant.

This is handled in CAP CRM Mitigant Volatility Haircut - Supervisory Haircut under CRM Sub Exposure Data Haircut Assignment process.

Forex Haircut

If the exposure and collateral are in different currencies, then the application adjusts by applying the FOREX haircut.

This is handled in CAP CRM Forex Haircut Sub Exposures under the CRM Sub Exposure Data Haircut Assignment process.

Maturity Mismatch Haircut

If the residual maturity of the Credit Risk Mitigant is less than that of the underlying credit exposure, then a maturity mismatch haircut is applied to adjust the value.

This is handled under CAP CRM Maturity Mismatch Haircut under CRM Sub Exposure Data Haircut Assignment process.

9.1.2 Investment Portfolio

9.1.2.1 Rating Population

The data on ratings is captured in the following rating specific tables:

- Instrument Rating Table (**STG_INSTRUMENT_RATING_DETAILS**)
 - Ratings for investment exposures subject to credit risk (one that is in **STG_INVESTMENTS**) and mitigants are captured in this table.
- Party Rating Table (**STG_PARTY_RATING_DETAILS**)
 - Ratings for the customer are captured in this table.
- Sovereign Rating Table (**STG_SOVEREIGN_RATING_DETAILS**)
 - Credit Rating for all countries is captured in this table.
- External Underlying Exposures Rating Table (**STG_EXT_ULY_ACCT_RATING_DTL**)
 - Credit Rating for all external underlying exposures is captured in this table. In the case of underlying exposures of CIU transactions, it is expected that the value of Exposure ID is that of the instrument ID to which the underlying exposures belong to. For example: If the Underlying Exposure ID EXP001, which belongs to the instrument INSTR001, and has the parent ID as PARENT001; in this case, the data expected in this table is of the instrument INSTR001, with the Exposure ID as INSTR001.

9.1.2.2 Processing Steps

Banks obtain credit ratings from different sources, and these are provided as input in the application through the rating tables mentioned in the preceding list.

This is handled in the sub-process Multiple Rating Assessment in BIS Other Reclassifications process.

The application re-classifies the rating information to BIS Specific standard ratings. The out-of-box application supports the Fitch / Moodys / S&P and DBRS credit rating reclassification for Long Term and Short-Term ratings.

This is handled in the sub-process Credit Rating Reclassification in Investment Data processing.

The rating reclassification lookup table (**FSI_RATING_CLASSIFICATION**) is used to lookup reclassified standard ratings so that the reclassification rule is not repeated for each of the rating processing tables. Ratings are populated from the stage tables (for example, **STG_PARTY_RATING_DETAILS**) to FSI tables (for example, **FSI_PARTY_RATING_DETAILS**) using the lookup table (**FSI_RATING_CLASSIFICATION**) to obtain a reclassified rating.

Ensure that the following columns are mandatorily populated with data in the **STG_PARTY_RATING_DETAILS** table: Rating source code (**V_RATING_SRC_CODE**), Party Code (**V_PARTY_CD**), Purpose (**V_PURPOSE**): In this field whether the rating is a domestic rating or foreign rating must be indicated. If any other rating is provided, then the exposure is considered as unrated. Data Population.

Preprocessing Steps

Credit Risk exposures are updated in the application for all the product types through their respective input tables known as Product Processors. Main categories of Credit Risk Investment exposures, along with their respective table names that are used as an input, are as follows:

Table 61: Data Population for Credit Risk Investment Exposures

Product	Source Product Processor
Investment Products:	STG_INVESTMENTS
Money Market Instruments	STG_MM_CONTRACTS
Spot Forex Transactions	STG_FX_CONTRACTS
Fixed Assets	STG_FIXED_ASSETS

9.1.2.3 Data Population

There is a data population about the mitigants, which cater to all the types of mitigants like collateral, guarantee, and credit derivatives. There is one data population about the counter-guarantee for the guarantor.

Table 62: Data Population for Mitigants

Product	Source Product Processor
Mitigants – Collateral, Guarantee, Credit Derivatives	STG_MITIGANTS
Mitigant Master Table	STG_MITIGANT_MASTER

There is a data population about the mapping between the exposures and the mitigants.

Table 63: Data Population for Mapping between Exposures and Mitigants

Product	Source Table
Mapping for Exposures and Mitigants	STG_ACCOUNT_MITIGANT_MAP

In the case of investments in funds (CIUs), the underlying of the CIU is captured in either of the below tables, depending on the data availability

Table 64: Data Population for Underlying of the CIU

Product Type	Source Product Processor
Underlying composition Details of CIU	STG_FUND_CIS_COMPOSITION
Underlying Exposures of CIU	STG_FUND_UNDERLYNG_COMPOSITION

Processing table details

All Credit Risk Investment exposures are loaded into the table, FSI CAP Investment Exposures, **FSI_CAP_INVESTMENT_EXPOSURES** where further processing happens for this portfolio of exposures till the computation of Pre-Credit Risk Mitigation process

This is handled in the process Investment Data Population.

9.1.2.4 Shareholding Percent Multiplication

Shareholding percent multiplication for common entity-level data is a part of BIS Common Data Processing (PMFCOM020) process. In this, the application updates the shareholding percentage against each entity. The parent entity is updated with the value of 1 as the shareholding percent and for each child entity, the percentage is based on the parent’s holding percentage as specified for each child in fact entity shareholding percent table (FCT_ENTITY_SHR_HLD_PERCENT).

Shareholding percent multiplication for exposure level is part of each portfolio as well. In this process, the application multiplies the entity shareholding percentage for that entity for parent entity against exposure amount, undrawn amount, and provision amount for that exposure and updates the same.

This is handled in the sub-process INV_SHAREHOLDING_CALCULATION_STD of the process Investment Data Processing – STD.

9.1.2.5 Common Reclassification Rules

The application reclassifies the bank’s product types and party types to standard product and party types. Based on the standard product and party type, the asset class for each exposure is arrived at. Similarly, the application does reclassification for mitigant based on its mitigant types and reclassifies it to standard mitigant types.

Ensure that all products and party type and mitigants which are bank-specific are reclassified, as part of the setup activity. If they are not reclassified, the treatment might not happen as expected by the regulator.

Product Type Reclassification

Product types used by the reporting bank as input data are reclassified to standard product types as recommended in the Accord. The product types after reclassification are stored as Basel product types. For Example, Fixed Rate Bond is reclassified as Debt Securities

This is handled in the Basel Product Type Reclassification which is part of the COMMON_RECLASSIFICATION process.

Party Type Reclassification

Similar to the product type, the customer type (which is stored as counterparty type) is also reclassified as the standard counterparty type. The customer information is expected in the Stage Party Master (STG_PARTY_MASTER), and this also includes the Party Type based on the Stage Party Type Master (STG_PARTY_TYPE_MASTER).

Party type reclassification Rules handle reclassification for customer types. For Example, a housing finance company is reclassified as Corporate

This is handled in the Party Type Reclassification which is part of the Investment Data Population

Other Reclassification

As part of the reclassification rules, any other data which is being brought inside the application like seniority, transaction type, and so on also get reclassified into OFSAA specific values. It is mandate, otherwise, data will not be available for processing as required by the regulator.

This happens as part of the process COMMON_RECLASSIFICATION.

9.1.2.6 Asset Reclassification Rules

Based on Basel product type and standard counterparty type, an asset class is formed by the application. This asset class is used for data processing. The asset class is the same as specified in the accord.

For example, Standard counterparty is Corporate non-SME and Corporate SME, the asset class is corporate. For Basel product type gold, the asset class is Gold.

The asset class for all mitigants is reclassified based on their standard mitigant types and standard issuer type.

This happens in the sub-process INV_RECLASSIFICATION_STD of the process Post Crisis Investment Data Processing - STD.

9.1.2.7 Pre-mitigation Calculations

Based on the asset class, the application calculates the Pre-Credit Risk Mitigation (CRM) Exposure at Default (EAD) for each exposure. This value signifies the maximum loss that the bank can suffer, in case of default on this exposure, before considering any mitigation effects.

Some exposures can be hedged against credit risk through various mitigants such as guarantees, collaterals, credit derivatives, and so on. These provide mitigation to credit risk and must be considered while computing Credit RWA, as per the Accord. Hence, the application calculates the pre-mitigation exposure amount and post-mitigation exposure amount.

The application also computes pre-mitigation risk-weighted assets (Pre CRM RWA) and post-mitigation risk-weighted assets (Post CRM RWA) by multiplying the respective EAD by risk weight. The risk weight is arrived at, by considering the credit rating of the exposures and mitigants as per the guidelines.

9.1.2.7.1 Exposure at Default Amount Calculation

Pre CRM EAD

Exposure at Default (EAD) is calculated for all the products. This is being computed using the Exposure Amount (EOP Balance of the Exposure)

This happens in the process INV_PRE_CRM_EAD_COMPUTATION_STD of the process Investment Data Processing - STD.

Post CRM EAD

Through the CRM process, the bank considers the effect of the mitigation and calculates the post-mitigation exposure at the default amount. This signifies the maximum loss that the bank can suffer in case of default on this exposure, after considering the effects of the mitigation. This will be the EAD of the Exposure Pre-Mitigation less the covered portion of the mitigant

9.1.2.7.2 Multiple Assessment

For exposures with multiple ratings, risk weight assignment is based on multiple assessment processes. For each exposure, the final rating is the worst of the best two ratings assigned to the exposure.

The risk weight corresponding to this rating is then assigned to the exposure.

Exposures for multiple rating assessments are first moved into the table FSI Multiple Rating Processing (**FSI_MULTIPLE_RATING_PROCESSING**) wherein the ranking and final selection of which rating to use takes place.

This happens in the sub-process of **INV_MULTIPLE_RATING_ASSESSMENT_DATA_POPULATION**, wherein the data for the multiple assessment processing gets populated into the FSI table.

MULTIPLE_RATING_ASSESSMENT, wherein the identification of the multiple rating for the exposure happens, and the

INV_MULTIPLE_ASSESSMENT_BASED_RISK_WEIGHT_ASSIGNMENT wherein the actual risk weight and final rating assignment happen for the exposures.

All the above fall under Investment Data Processing – STD.

9.1.2.7.3 Issue Issuer Assessment

For all exposures which remain unrated after the multiple assessment processes, the issue issuer process is performed. This happens in the Issue Issuer Assessment sub-process (INV_INV_ISSUE_ISSUER_ASSESSMENT). In this case, the unrated exposures are assigned a reference rating based on the reference issue available or the rating of the party, whichever is applicable. These unrated exposures are assigned a risk weight based on the reference rating.

For unrated non-Securitized exposures, the application does an issue-issuer assessment to infer a rating of the unrated exposures, based on the rating of a similar instrument (referred to as reference issue hereafter) issued by the same issuer. The reference issue is used only when it is of the same currency as the exposure and the exposure is senior or equivalent to the same. For the unavailable reference issue, the party rating is used. In the case of the party also being unrated, the exposure remains unrated. Also, the application populates whether the exposure is LT rated or ST rated, based on the rating assigned to the exposure.

9.1.2.7.4 Risk Weight Assignment Rules

ECRA Approach and SCRA Approach

The ECRA SCRA Approach options for risk-weighting are selected during Run definition to update the required calculations as allowed by the specific jurisdiction. Based on the run definition selected the Investment process passes through the Risk Weighting Approach. This is handled in Investment Post Crisis Risk Weight Assignment- ECRA and Banking Post Crisis Risk Weight Assignment- SCRA. For more details on the options, see the [Run Management](#) section.

Figure 65: Process Flow for Risk Weight Assignment Rules - ECRA Approach

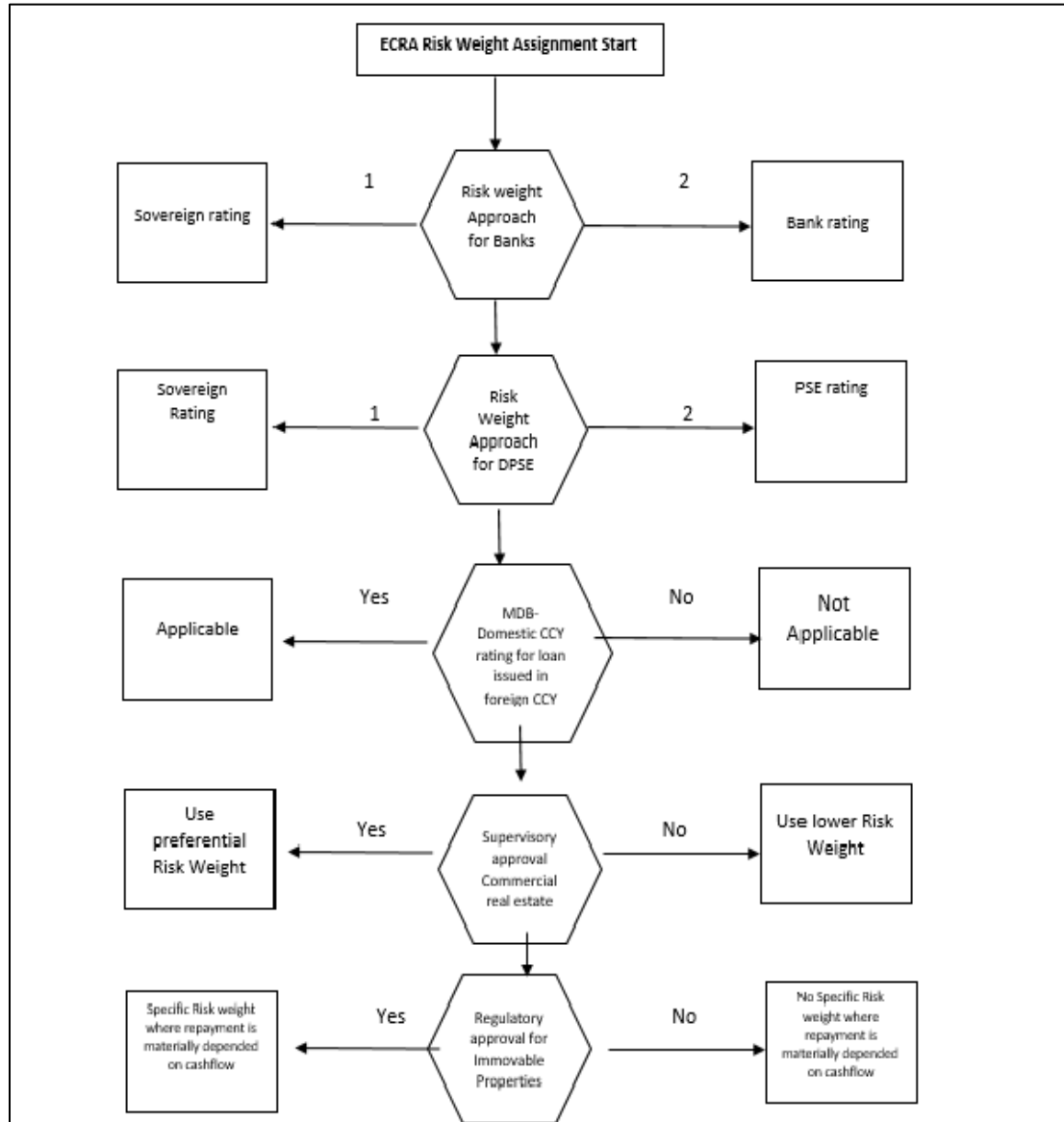
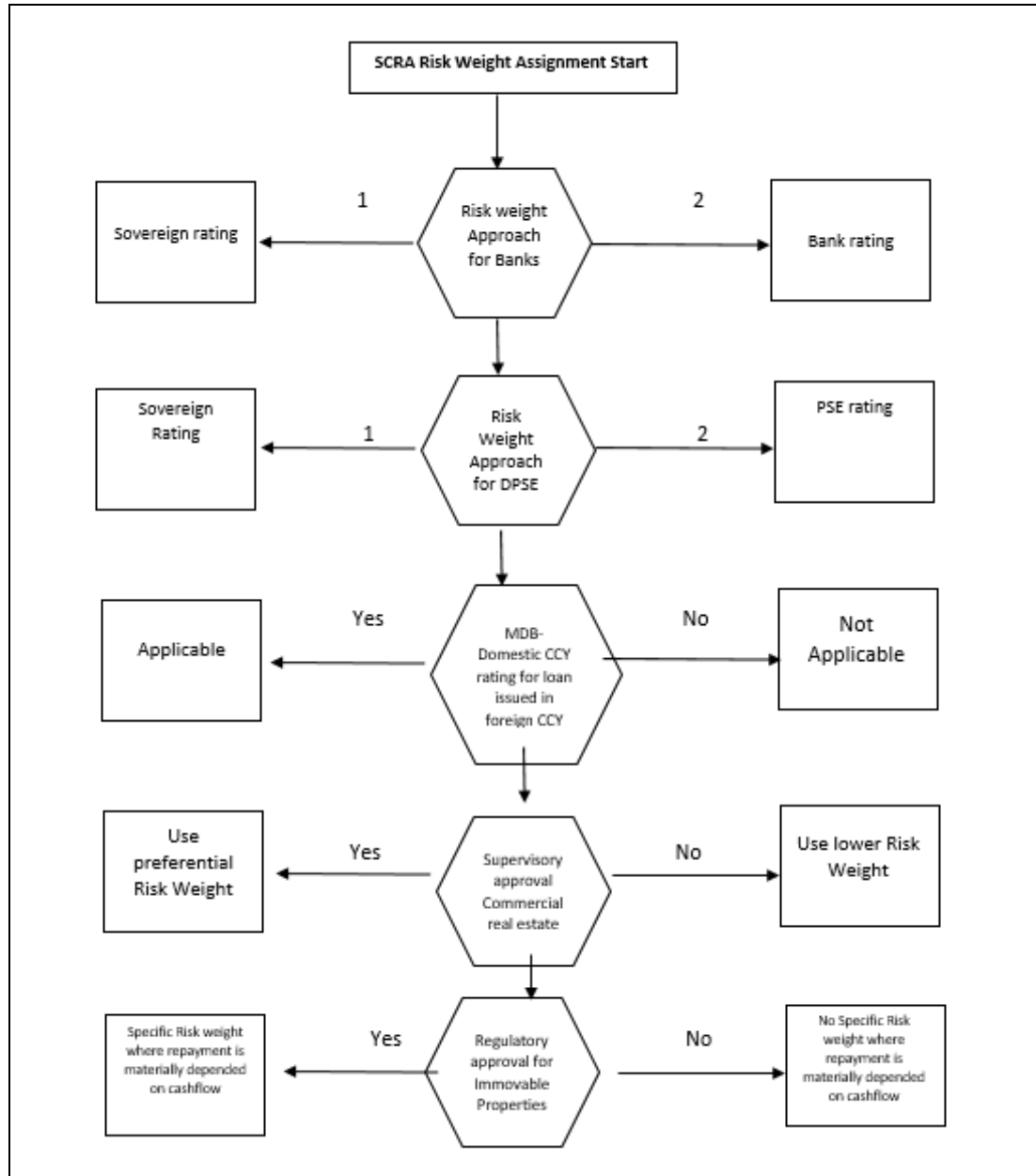

Figure 66: Process Flow for Risk Weight Assignment Rules - SCRA Approach



Non-Sec Exposures Risk Weight

Risk Weight is assigned based on asset class and the credit rating as per Basel guidelines. The risk weight rules operate on the risk weight table (FSI_RW_MAP_MASTER). Highly rated exposures are allocated low-risk weight and poorly rated exposures are allocated high-risk weights.

If exposure has more than one rating (rated by more than one agency), then the final rating is assigned based on multiple assessments. The application updates the risk weights against the exposures directly, when ratings are not considered.

Options for risk-weighting are selected during Run definition if the Run Management UI is used, to update the required calculations as allowed by the specific jurisdiction. For more details on the options, see the [Run Management](#) section.

This is handled under the sub-process: **INV_RISK_WEIGHT_ASSIGNMENT_STD** in Investment Data Processing – STD process.

Funds/ Collective Investment Units

Equity Investments in Funds – (Collective Investment Units (CIU) Processing)

The CIU is funds that have invested in various exposures. The accord has specified various criteria for risk weighting CIU exposures. The application supports all the approaches. In the case of CIU, the application follows a hierarchy of approaches:

- Look Through Approach
- Mandate Based Approach
- Fall Back Approach

Figure 67: Process Flow of Equity Investments in Funds

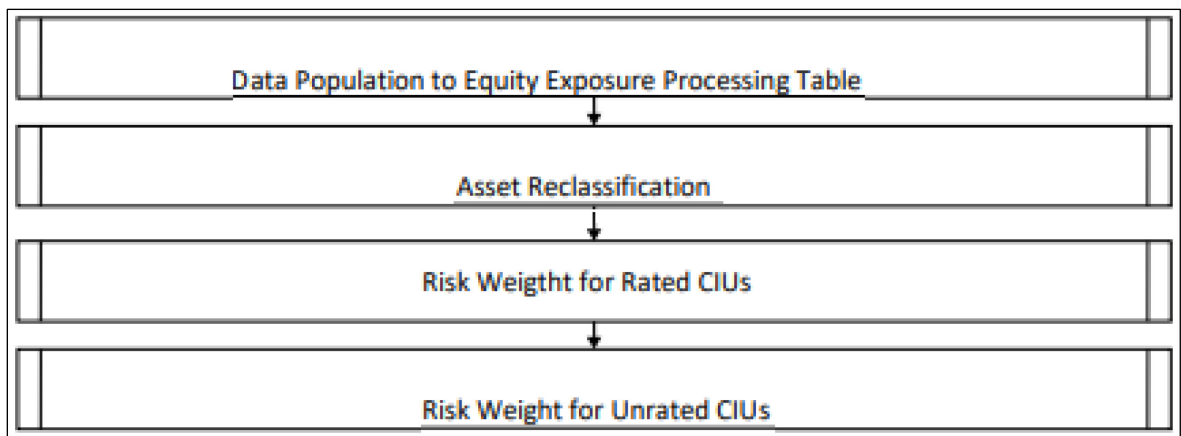

The exposures to CIU are expected in the table Stage Investments (STG_INVESTMENTS), and the instrument code is expected to be populated for these exposures. The static information related to the instruments is expected in the Instrument contract dimension table (DIM_INSTRUMENT_CONTRACT), and the information about the instruments, which change periodically like the current outstanding issue amount, is expected in the Stage Instrument Contract Detail table (STG_INSTRUMENT_CONTRACT_DTL).

The underlying exposures of CIU are expected in STG_FUND_CIS_COMPOSITION with the fund code (instrument code) populated also into Parent Instrument Code.

The underlying composition of the CIU is expected in the table Stage Fund Underlying Composition (STG_FUND_UNDERLYNG_COMPOSITION). This has the underlying composition details of the fund, across various products, and the maximum permissible limit of investment in each of the product types, with the fund code as the Instrument ID.

NOTE:

The fund underlying composition or the underlying exposures are required for processing, only when the underlying of the fund is not available and when there is mandate information available for the fund.

When the derivatives products are underlying for a CIU, then the MTM value of the derivative is expected to be given as Asset MTM Value (N_ASSET_MTM_VALUE) in Stage Fund CIS Composition (STG_FUND_CIS_COMPOSITION). MTM value of the derivative must also be populated to Composition Value (N_COMPOSITION_VALUE).

NOTE:

Unless operational criteria are met, the look-through approach is not applicable.

Look Through Approach

The first approach in the hierarchy that the application assigns based on the operational criteria given in the accord is LTA. To validate the operational criteria or conditions given, data is expected as input. Along with the suggested conditions, the application also checks for the availability of the underlying information. If all the sufficient information is available, the application assigns the Look Through Approach (LTA) and computation will be followed as given in the accord. If operational criteria are not met, the application checks for the immediate next approach.

The look-through approach is handled in the sub-process CIU - INV – Risk Weight Method Assignment – Look Through Approach in the process INV_CIU_RISK_WEIGHT_METHOD_CALCULATION.

Mandate Based Approach

This approach is applied when the information of the underlying and the third-party risk weights that can be used under the look-through approach are not available. To continue with this approach banks, need to have the mandate information required. Once the application checks for the information and assigns the approach, computations for MBA under the Standardized approach are in line with the Basel Accord.

This is handled in the sub-process CIU - INV – Risk Weight Method Assignment – Mandate Based Approach in the process INV_CIU_RISK_WEIGHT_METHOD_CALCULATION.

Fall Back Approach

If no approach from the hierarchy is applicable based on the checks performed, the application assigns Fall Back Approach. In this approach, all the exposures will be risk-weighted at 1250%.

This is handled in the sub-process CIU - INV – Risk Weight Method Assignment – Fall Back Approach in the process INV_CIU_RISK_WEIGHT_METHOD_CALCULATION.

Partial use of an approach

A bank may use a combination of the three approaches when determining the capital requirements for an equity investment in an individual fund, provided that the conditions for all the approaches are met.

This will be applicable only in the case of the treatment of funds in other funds, as within a fund the method cannot be different.

Treatment of funds invested in other funds

If the underlying information is available, then application checks for the approach that is used by the funds. If the approach is not same across then FBA will be assigned i.e. if the approach used for determining the RW of a fund and the same approach is also where it is invested. Further, if same then application carry on with the same approach (Look through or Mandate based approach respectively), if not then we will assign 1250% under Fall Back Approach.

Risk Weight assignment of Covered Bonds

Covered bonds are debt securities issued by credit institutions and secured by a pool of mortgage loans or credit towards the public sector. These covered bonds qualify for a preferential treatment only if they qualify for the treatment based on the criteria for the underlying exposures. If they do not qualify for the preferential treatment, they will be treated based on the issuer asset class, as any other bond instrument.

The covered bonds issued on or before 31 Dec 2007 will be eligible for this preferential treatment, without any additional criteria.

In the case of covered bonds issued after 31 Dec 2007, they will be eligible for the preferential treatment only if the bank is able to exhibit that they receive the portfolio information periodically, and the underlying of these covered bonds, satisfy all the criteria required by the regulator.

If any of the criteria are not met, then they will not qualify for the preferential treatment.

For example, below is a criterion based on party of the underlying exposure

The underlying of the covered bonds belonging to the below category are eligible for preferential treatment, provided they have a credit quality step of 1 and do not exceed 15% of the nominal amount of the outstanding covered bonds of the issuing institution.

Exposures to Institutions

Below is another criterion based on the product to which the underlying exposure has invested

The underlying of the covered bonds belonging to the below category are eligible for preferential treatment

Loans secured by maritime lien on ships with the threshold value for eligibility equivalent to 60% of the value of the pledged ship less the value of any prior liens on the same ship.

All covered bond exposures for which Preferential Treatment criteria are met will get Asset Class stamping of CB (Covered Bond).

Rated CB exposures will assign risk weight based on the rating while unrated CB exposures will use the rating of the issuer of the financial instrument.

Covered Bonds related tasks are found in the sub-process EU Investment RW Assignment Covered Bonds – STD in the process EU Investment Data Processing – Standardized.

9.1.2.7.5 RWA Calculations

The RWA is calculated as the Pre-mitigation EAD multiplied by the Pre-Mitigation Risk Weight.

This is handled under the sub-process **INV_PRE_CRM_RISK_WEIGHTED_ASSET_CALCULATION_STD** under the process Investment Data Processing – STD.

9.1.2.8 Credit Risk Mitigation Process

In order to calculate the post CRM RWA, application needs to account for mitigants which may be in the form of collaterals, guarantees, credit derivatives. Not all mitigants are eligible for RWA computation. All the mitigants which get populated into the system are being made ineligible, and then the regulatory approved mitigant types and the issuer type combination are made eligible.

9.1.2.8.1 Mitigant Processing

Mitigant Data population

Mitigant data is loaded from the Stage Mitigant table (STG_MITIGANTS) into the FSI CAP Mitigants table (FSI_CAP_MITIGANTS) where further processing takes place. This is takes place under the sub-process Mitigant Data Population in the process Mitigant Data Processing.

Mitigant Multiple assessment

Similar to exposures with multiple ratings, mitigants with multiple ratings are also subject to Multiple rating Assessment. This is handled under the sub-process Mitigant Multiple Rating Assignment – BIS in the process Mitigant Data Processing -STD.

The Data Transformation “CAP_MITIGANT_MULTIPLE_ASSESSMENT_DATA_POP” performs this.

9.1.2.8.2 Mitigant Eligibility Approaches and their Risk Weighting Rules

Mitigant Risk Weight

The Post Crisis Mitigant Risk Weight is a common sub process in Post Crisis Mitigant Data Processing from which its handles into.

- Simple Approach
 - ECRA Approach
 - SCRA Approach
- Comprehensive Approach
 - ECRA Approach
 - SCRA Approach

Simple Approach

the Simple Approach is selected via Run definition. The application assigns risk weight to mitigants on the basis of credit rating of SCRA Rating Approach or ECRA Rating Approach which is also based on the run definition selected. The risk weight is based on credit rating (CAP Mitigant Basel Rating and Risk Weight Assignment), original maturity (CAP Mitigant RW Assignment based on Original Maturity) and for Nettable Liabilities (CAP Mitigant RW Assignment for Nettable Liabilities). These fall under the process Mitigant RW Assignment – Simple – BIS.

ECRA Approach and SCRA Approach

The ECRA SCRA Approach options for risk-weighting are selected during Run definition to update the required calculations as allowed by the specific jurisdiction. Based on the run definition selected the Mitigant process passes through the Risk Weighting Approach handled in Mitigant RW Assignment – Simple –BIS.

Comprehensive approach

The Comprehensive approach is selected via Run definition. The Application assigns risk weight to mitigants on the basis the selection of SCRA Rating Approach or ECRA Rating Approach which is also based on the run definition selected. The mitigant risk weights are assigned on the basis of credit rating (CAP Mitigant Basel Rating and Risk Weight Assignment), for financial collaterals (CAP Mitigant RW

Assignment for Financial Collaterals - Comprehensive Approach) and for nettable liabilities (CAP Mitigant RW Assignment for Nettable Liabilities). These fall under the process Mitigant RW Assignment – BIS – Comprehensive Approach.

ECRA Approach and SCRA Approach

The ECRA SCRA Approach options for risk-weighting are selected during Run definition to update the required calculations as allowed by the specific jurisdiction. Based on the run definition selected the Mitigant process passes through the Risk Weighting Approach handled in Mitigant RW Assignment – BIS – Comprehensive Approach.

Mitigant Eligibility

The application identifies the eligible mitigants based on the criteria as mentioned by the Regulator. The application identifies the following standard mitigants– collateral, guarantees, and credit derivatives.

The application is capable of using the Simple Approach and the Comprehensive Approach for the mitigants which are part of the collateral. The application identifies the eligibility of the financial collateral separately for the simple approach and the comprehensive approach. The eligibility of the collateral mitigants is based on the party type of the mitigant, mitigant types, the credit rating assigned to the mitigant or the party (as applicable), and the classification of collateral as senior or not. Also, application enables the selection of ECRA Approach and SCRA Approach.

For equity, the eligibility is based on the main index equity and the equity trading status. This is handled in CAP Collateral Eligibility - Simple Approach - Equity under the process Post Crisis Mitigant Eligibility Simple Approach.

For mutual funds, the eligibility is based on the eligible mutual fund indicator. This is handled CAP Collateral Eligibility - Simple Approach - Equity under the process Post Crisis Mitigant Eligibility Simple Approach. The application also identifies whether the mitigant is a Re-securitized exposure and if yes, makes it ineligible which is also handled in Post Crisis Mitigant Eligibility Simple Approach.

The application identifies the eligibility of the guarantees and credit derivatives based on the party type of the mitigant and the credit rating assigned to the issuer of the mitigant. This is handled in CAP Non-Sec Mitigant Eligibility under the process Post Crisis Mitigant Eligibility Simple Approach. Similarly mitigant eligibility rules for Comprehensive Approach can be found in the process Post Crisis Mitigant Eligibility – Comprehensive Approach. This is also based on the run definition for ECRA Approach and SCRA Approach.

The option for the bank to select Collateral Simple Approach or Comprehensive Approach is based on the Run Management option as selected in the UI.

Mitigant Haircut Assignment

Under Standardized approach, the bank has to follow supervisory estimates for Mitigant Haircut assignment. This is based on the various categories like mitigant type, residual maturity, rating, issuer type and so on. This is applicable only if the bank follows comprehensive approach for collateral.

Only eligible mitigants are considered for haircut assignment and for further processing. Post haircut assignment, the eligible mitigants are moved from mitigants table (FSI_CAP_MITIGANTS) to sub exposures table (FSI_CAP_SUB_EXPOSURES).

The application does computations for three kinds of mitigant haircuts which are volatility haircut, FOREX haircut, and maturity mismatch haircut.

The mitigant haircut rules are handled in the Post Crisis Mitigant Haircut Comprehensive Approach for ECRA and SCRA Approach.

Volatility Haircut

Volatility haircuts are assigned to the collateral to account for any future fluctuations in the market value of the financial collateral. The application assign haircuts for various type of financial collateral like debt securities, equity, mutual funds, and so on. In the supervisory haircut method, the application assigns volatility haircut based on issues, issuer's ratings, mitigant's residual maturity, and type of mitigant.

This is handled in PCR Mitigant Volatility haircut - Comprehensive Approach – ECRA and SCRA Forex Haircut

If the exposure and collateral are in different currencies, then the application makes an adjustment by applying the FOREX haircut.

This is handled in CAP CRM Forex Haircut Sub Exposures under CRM Sub Exposure Data Haircut Assignment process.

Maturity Mismatch Haircut

If the residual maturity of the Credit Risk Mitigant is less than that of the underlying credit exposure, then a maturity mismatch haircut is applied to adjust the value.

This is handled under CAP CRM Maturity Mismatch Haircut under CRM Sub Exposure Data Haircut Assignment process.

9.2 Counterparty Credit RWA

Counterparty Credit RWA is the calculation of the counterparty credit risk exposures. This includes the derivative portfolio and the Securities and Financing transaction portfolio. This also includes the exposures in both banking book and trading book.

The counterparty credit exposures also undergo additional RWA calculation in the form of Credit Valuation Adjustment (CVA). The mark to market counterparty credit losses or the spread migration risk is captured with CVA, which was not directly capitalized before. CVA is the difference between the risk-free portfolio value and the true portfolio value that considers the possibility of the counterparty's default. In other words, CVA is the market value of counterparty credit risk.

9.2.1 Derivatives Portfolio

9.2.1.1 Rating Population

The Data on ratings is captured in the following rating specific tables:

- Party Rating Table (**STG_PARTY_RATING_DETAILS**)
 - Credit ratings for all are captured in this table.
- Sovereign Rating Table (**STG_SOVEREIGN_RATING_DETAILS**)
 - Credit Rating for all countries is captured in this table.
 - Instrument Rating Table (**STG_INSTRUMENT_RATING_DETAILS**)

Ratings for all instruments are captured in this table. Even the posted collateral (Placed Collateral) and received collateral (Mitigants) related ratings are captured in this table and this is handled in the process `DRV_INSTRUMENT_RATING_POPULATION`.

9.2.1.2 Processing Steps

Banks obtain credit ratings from different sources, and these are provided as an input in the application through the rating tables mentioned in the preceding list.

This is handled in the process `RATING_RECLASSIFICATION_POPULATION`.

The application re-classifies the rating information to BIS Specific standard ratings. The out-of-box application supports the Fitch / Moodys / S&P and DBRS credit rating reclassification for Long Term and Short-Term ratings.

This is handled in the process `Credit Rating Reclassification`.

The rating reclassification lookup table (`FSI_RATING_CLASSIFICATION`) is used to lookup reclassified standard ratings so that the reclassification rule is not repeated for each of the rating processing tables.

Ratings are populated from the stage tables (for example, `STG_PARTY_RATING_DETAILS`) to FSI tables (for example, `FSI_PARTY_RATING_DETAILS`) using the lookup table (`FSI_RATING_CLASSIFICATION`) to obtain a reclassified rating.

Ensure that all the relevant columns as indicated in the DL Specs are mandatorily populated with data. For example, in the Stage Party Rating Details (`STG_PARTY_RATING_DETAILS`) table: Rating source code (`V_RATING_SRC_CODE`), Party Code (`V_PARTY_CD`), Purpose (`V_PURPOSE`) are required to be populated. The purpose code is to indicate whether the rating is a domestic rating or a foreign rating. If any other rating is provided, then the exposure is considered unrated.

9.2.1.3 Data Population

Pre-processing Steps

Credit Risk exposures are updated in the application for all the product types through their respective input tables known as Product Processors. Main categories of Counterparty Credit Risk exposures, along with their respective table names that are used as an input, are as follows:

Table 68: Data Population for Credit Risk Exposures

Product	Source Product Processor
Swaps	STG_SWAPS_CONTRACTS
Futures	STG_FUTURES
Options	STG_OPTION_CONTRACTS
Credit Derivatives	STG_CREDIT_DERIVATIVES
Forwards	STG_FORWARDS

There is a data population about the placed collateral and central counterparty details, which are required for the cleared transaction and default fund contribution treatment.

Table 69: Data Population for Placed Collateral and Central Counterparty Details

Product	Source Product Processor
Placed Collateral	STG_PLACED_COLLATERAL
Default Fund Contribution	STG_CCP_DETAILS

There is a data population about the mitigants that adheres to the applicable mitigant type like collateral received for the derivatives

Table 70: Data Population for Mitigants

Product	Source Product Processor
Mitigants – Collateral received	STG_MITIGANTS

There is a data population about the mapping between the exposures and the mitigants. And one data population about the mapping between the exposures and the placed collateral

Table 71: Data Population for Mapping between Exposures and Mitigants

Product	Source Table
Mapping for Exposures and Mitigants	STG_ACCOUNT_MITIGANT_MAP
Mapping for Exposures and Placed Collateral	STG_ACCT_PLACED_COLL_MAP

Processing table details

All Counterparty credit Risk related derivative exposures are loaded into the table, FSI Cap Derivative (FSI_CAP_DERIVATIVES) where further processing happens for this portfolio of exposures till they are moved to the Netting set granularity. This is handled in the process Derivative Data Population process, under sub-processes:

- DERIVATIVE_SWAPS_EXPOSURE_DATA_POPULATION
- DERIVATIVE_FUT_EXPOSURE_DATA_POPULATION
- DERIVATIVE_OPT_EXPOSURE_DATA_POPULATION
- DERIVATIVE_CREDIT_DERIVATIVES_DATA_POPULATION

All placed collateral that the bank has placed that are not specific to Securities Financing Transactions exposures are loaded into the table, FSI_PLACED_COLLATERAL

All the collateral that the bank has received, as part of the Derivative transactions, are loaded into the table, FSI_CAP_MITIGANTS.

9.2.1.4 Shareholding Percent Multiplication

Shareholding percent multiplication for common entity-level data is a part of BIS Common Data Processing (PMFCOM020) process. In this, the application updates the shareholding percentage against each entity. The parent entity is updated with the value of 1 as the shareholding percent and for each child entity, the percentage is based on the parent's holding percentage as specified for each child in fact entity shareholding percent table (FCT_ENTITY_SHR_HLD_PERCENT).

Shareholding percent multiplication for exposure level is part of each portfolio as well. In this process, the application multiplies the entity shareholding percentage for that entity for parent entity against exposure amount, undrawn amount, and provision amount for that exposure and update the same.

This is handled in the sub-process DRV_SHAREHOLDING_CALCULATION_STD of the Derivatives Data Processing.

9.2.1.5 Common Reclassification Rules

The application reclassifies the bank's product types and party types to standard product and party types. Based on the standard product and party type, the asset class for each exposure is arrived at. Similarly, the application does reclassification for mitigant based on its mitigant types and reclassifies it to standard mitigant types.

Ensure that all products and party type and mitigants which are bank-specific are reclassified, as part of the setup activity. If they are not reclassified, the treatment might not happen as expected by the regulator.

Product Type Reclassification

Product types used by the reporting bank as input data are reclassified to standard product types as recommended in the Accord. The product types after reclassification are stored as Basel product types. For Example, Interest Rate Futures is reclassified as Futures

This is handled in the Basel Product Type Reclassification which is part of the Derivatives Multiple Assessment Risk Weight Assignment.

Party Type Reclassification

Similar to the product type, the customer type (which are stored as counterparty type) are also reclassified as standard counterparty type. The customer information is expected in the Stage Party Master (STG_PARTY_MASTER), and this also includes the Party Type based on the Stage Party Type Master (STG_PARTY_TYPE_MASTER).

Party type reclassification Rules handle reclassification for customer types. For Example, a small business entity is reclassified as Corporate SME

This is handled in the Party Type Reclassification which is part COMMON_RECLASSIFICATION process.

Instrument Type Reclassification

Bank Instrument types used by the reporting bank as input data are reclassified to Instrument types. The instrument types after reclassification are stored as Instrument types. For Example, Interest Rate Future Contract is reclassified as Interest Rate Futures. This happens as part of the process COMMON_RECLASSIFICATION process.

Mitigant Reclassification

For mitigants the application reclassifies the mitigant type to the standard mitigant type like the debt securities.

The reclassification tasks are present in the MITIGANT_TYPE_RECLASSIFICATION.

9.2.1.6 Pre-mitigation Calculations - Exposure at Default Amount Calculation

Pre-mitigation Exposure at Default can be calculated as per Standardized Approach of calculations (SA CCR)

The Standardized Approach for Counterparty Credit Risk (SA-CCR) is an alternative for Standardized Method (SM) and Current Exposure Method (CEM) for Counterparty Credit Risk (CCR) in Credit Risk.

Banks can use the SA-CCR approach while they follow Standardized or IRB approaches for credit risk. The SA-CCR approach is applicable for Over the Counter (OTC) Derivatives, Exchange Traded Derivatives, and Long Settlement Transactions.

9.2.1.6.1 SA-CCR Method of EAD Computation

The exposures under the SA-CCR consist of two components: replacement cost (RC) and potential future exposure (PFE). The replacement cost is mostly related to the mark to market of the derivative contract, by considering the collateral and margin agreement as relevant. The potential future exposure consists of a multiplier that allows for the partial recognition of excess collateral and an aggregate add-on which is inside the sub-process: DERIVATIVES_SACCR_EAD_CALCULATION which is part of the Derivatives Multiple Assessment Risk Weight Assignment.

The following flowchart depicts the process flow of SA-CCR:

Figure 53: Process Flow of SA-CCR

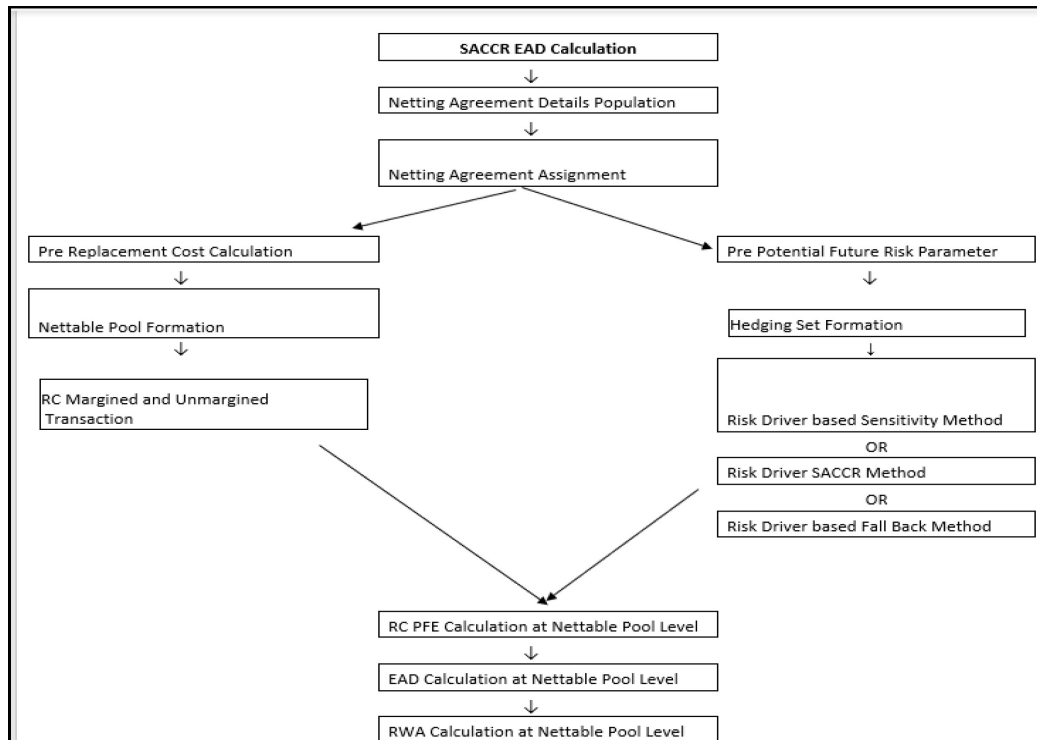

Netting Agreement

For instruments participating in netting set, the notability flag should be set as 'Y'. Instruments with the same agreement code are netted in the same netting set.

The application creates new records for the netting agreement and then populates them into the FSI Netting Agreement Details (FSI_NETTING_AGREEMENT_DETAILS) table. The netting agreements will be populated in the process NETTING_AGREEMENT_DETAILS_DATA_POP.

In the case of the contracts not being part of any netting agreement, the application considers them as part of their netting agreement or netting set, for the calculations of the different parameters.

Margin Agreement

For both RC and PFE, if one of the netting agreements has multiple margin agreements, then this netting agreement should be divided into sub-netting agreements to align with the margin agreements. This is captured in RC_MARGINED_UNMARGINED_TRANSACTION process Placed Collateral & Mitigant – Eligibility Condition.

Placed Collateral & Mitigant - Eligibility

The placed collateral is captured in FSI Cap Placed Collateral (FSI_CAP_PLACED_COLLATERAL) and this also moves to FSI Cap Mitigants (FSI_CAP_MITIGANTS), wherein the placed collateral and the mitigants both undergo the same treatment. This is part of the process FSI_PLACED_COLLATERAL_DATA_POPULATION and FSI_CAP_MITIGANT_DATA_POPULATION.

The mitigant is identified as eligible are not based on the eligibility rules for CRM as mentioned in the Basel III accord. Credit rating of the collateral is considered for all mitigants types issued by all party types while deciding whether a mitigant is eligible for a particular exposure or not. Separate eligibility Rules exist for mitigants types like equity, mutual funds, or debt security, to perform these checks. For the remaining, a mitigant is marked as eligible only if its credit rating is better than the exposure to which it is providing protection and also if it is classified as senior in position. This is handled in the sub-process Mitigant Data Processing – STD Approach (FSI_CAP_MITIGANTS). Mitigant eligibility is also checked based on the original and residual maturity of the collateral. Collateral is classified as eligible only if its original maturity is more than a year and residual maturity is more than 3 months.

Placed Collateral & Mitigant – Haircut Assignment

The application assigns three kinds of mitigant haircuts, which are volatility haircut, FOREX haircut, and maturity mismatch haircut. Volatility haircuts are assigned to the collateral to account for any future fluctuations in the market value of the financial collateral. Separate Rules exist in the application for various types of financial collaterals like debt securities, equity, mutual funds, and so on. When the exposure and collateral are in different currencies, the application adjusts by applying FOREX haircut. If the residual maturity of CRM is less than the underlying credit exposure, then a maturity mismatch is applied. If there is a maturity mismatch and CRM has an original maturity of more than a year, the maturity mismatch haircut is applied to adjust the value. The application assigns a volatility haircut using the Supervisory Haircut method when the standardized approach is selected.

This is part of the process **FSI_PLACED_COLLATERAL_DATA_POPULATION** and **FSI_CAP_MITIGANT_DATA_POPULATION**.

Replacement Cost

The Replacement Cost (RC) is computed differently for margined and unmargined netting agreements.

All the required attributes for replacement cost are populated from the FSI Cap Derivative Exposures (FSI_CAP_DERIVATIVES) Cap Mitigants (FSI_CAP_MITIGANTS) and FSI Placed Collateral (FSI_PLACED_COLLATERAL) to the table FSI_CAP_NETTABLE_POOL wherein the replacement cost (N_REPLACEMENT_COST) calculation happens. Since there are different calculations required for the replacement cost, depending on whether it is a margined transaction or not, and depending on whether the netting set contains only a single margin agreement or multiple margin agreements, it happens in the table FSI_MARGINED_EAD_CALC. This is handled in the RC_MARGINED_UNMARGINED_TRANSACTION process.

In the case of contracts covered by margin agreement, the Initial margin and the Variation margin are expected at the netting agreement level. The minimum transfer amount and threshold amount are also expected at the netting agreement level and expected to be provided as an input in the Stage Net Exposures tables (STG_NET_EXPOSURES).

Methods of identifying various risk categories and risk drivers

For each exposure, the banks must identify the primary risk driver of the risk factors such as interest rate, foreign exchange, credit, equity, or commodity. This is crucial because the Add-on formula for each risk category is different, and it depends on the nature of the risk factors. The risk categories can be identified by defining the primary risk factors of underlying exposures in the derivative contracts.

This is selected by the bank based on the Regulatory Definition Sensitivities Based Method

- SA-CCR Based Method
 - All the Add-ons are computed for the instrument, concerning all material risk drivers are as per the SA CCR calculation. Using this, the material risk categories are identified, as the ones with the maximum absolute value of sensitivity multiplied by the risk weight. This gets handled in the process and the table.
- Fall Back Approach
 - All the Add-ons are computed for the instrument, concerning all risk drivers. Also, all the risk categories will be considered as the material risk driver. This gets handled in the process and the table.

Essentially, it will be one instrument that can be mapped to multiple risk categories, with one material risk driver identified for each risk category. And the resultant replacement cost will be a summation of the add-on across all the material risk categories.

The data for Risk Drivers and Categories are from the following tables

FSI Cap Risk Category Master (FSI_CAP_RISK_CATEGORY_MASTER)

FSI Cap Risk Driver Master (FSI_CAP_RISK_DRIVER_MASTER)

FSI Cap Risk Driver Map Master (FSI_CAP_RISK_DRIVER_MAP_MASTER)

Parameter Calculations for Potential Future Exposure

The parameters to be considered for the Calculation of Potential Future Exposure, which is treated under the process PRE_POTENTIAL_FUTURE_RISK_PARAMETERS,

Multiplier

The multiplier in the PFE formula serves to reduce the add-on for over collateralization as in practice many banks hold excess collateral precisely to offset potential increases in exposure represented by the add-on.

Aggregate Add-on

The asset classes: interest rate, foreign exchange, credit, equity or commodity and a derivatives transaction is assigned to an asset class based on its primary risk driver. The add-ons for each asset class are simply aggregated.

Most derivative transactions have one primary risk driver, defined by its reference to underlying instrument.

Adjusted Notional

For interest-rate and credit derivatives, the trade-level adjusted notional is the product of the trade notional amount, converted to the domestic currency, and the supervisory duration (SD).

Supervisory delta adjustments

These parameters are also defined at the trade level and are applied to the adjusted notional amounts to reflect the direction of the transaction. For derivatives that are not options, the value of this parameter is +1 for long (MTM increases when the value of the primary risk factor increases) or -1 for short (MTM decreases when the value of the primary risk factor increases).

Supervisory correlation parameters

These parameters only apply to the PFE add-on calculation for equity, credit, and commodity derivatives. For these asset classes, the supervisory correlation parameters are derived from a single-factor model and specify the weight between systematic and idiosyncratic components.

Potential Future Exposure (PFE)

The Potential Future Exposure (PFE) is computed differently for each of the risk categories, and the final value is assigned to the netting set (stored at the FSI Cap Nettable Pool (FSI_CAP_NETTABLE_POOL)).

PFE add-ons are calculated for each asset class within a netting set and then aggregated. Add-ons for an asset class require the use of hedging sets, which are transactions within a single netting set within which partial or full offsetting is recognized in the methodology.

For Interest rate derivatives hedging set consists of all derivatives, hedging sets are further divided into maturity categories. Long and short positions in the same hedging set are permitted to fully offset each other within maturity categories; across maturity categories, the partial offset is recognized.

For the calculation of PFE, it is required to adopt the unmargined methodology. This is because a single margin agreement applies to multiple netting agreements and collaterals are based on the netted MTM values of the derivative contracts.

This is handled in FSI_POTENTIAL_FUTURE_EXP_CALC.

Exposure at Default Calculations (EAD)

Through the CRM process, the bank takes into account the mitigation effect and calculates the post-mitigation exposure at default amount. This signifies the maximum loss that the bank can suffer in case of default on this exposure, after considering all the mitigation effects. The application also computes pre-mitigation risk-weighted assets in the process DRV_PRE_CRM_RISK_WEIGHTED_ASSET_CALCULATION and post-mitigation risk-weighted assets in the process DRV_POST_CRM_RISK_WEIGHTED_ASSET_CALCULATION by multiplying the respective EAD by risk weight. In this scenario, the risk weight is arrived at by analyzing the credit rating of the exposures or mitigants.

The risk weight is arrived at by multiplying the pre-mitigation capital charge by 12.5. Through Credit Risk Mitigation, the bank considers the effects of mitigation. The application checks mitigant eligibility based on the Basel specifications and assigns a haircut to each mitigant based on their currency, residual maturity, and expected volatility in their market value.

9.2.1.7 Multiple Assessment

For exposures with multiple ratings, risk weight assignment is based on multiple assessment processes. For each exposure, the final rating is the worst of the best two ratings assigned to the exposure.

The risk weight corresponding to this rating is then assigned to the exposure.

Exposures for multiple rating assessments are first moved into the table FSI Multiple Rating Processing (FSI_MULTIPLE_RATING_PROCESSING) wherein the ranking and final selection of which rating to use takes place.

This happens in the sub-process of DRV_MULTIPLE_ASSESSMENT_PROCESSING_DATA_POP Derivatives Data Processing, wherein the data for the multiple assessment processing gets populated into the FSI table. MULTIPLE_RATING_ASSESSMENT, wherein the identification of the multiple rating for the exposure happens, and the DRV_MULTIPLE_ASSESSMENT_BASED_RISK_WEIGHT_ASSIGNMENT for Derivatives Data processing wherein the actual risk weight and final rating assignment happens for the exposures.

9.2.1.8 Issue Issuer Assessment

For all the exposures which remain unrated after the multiple assessment processes, the issue issuer process is performed. This happens in the Issue Issuer Assessment sub-process (DRV_ISSUE_ISSUER_ASSIGNMET). In this case, the unrated exposures are assigned a reference rating based on the reference issue available or the rating of the party, whichever is applicable. These unrated exposures are assigned a risk weight based on the reference rating.

For Derivatives, the application does an issue-issuer assessment to infer a rating of the unrated exposures, based on the rating of a similar instrument (referred to as reference issue hereafter) issued by the same issuer. The reference issue is used only when it is of the same currency as the exposure and the exposure is senior or equivalent to the same. For the unavailable reference issue, the party rating is used. In the case of the party also being unrated, the exposure remains unrated. Also, the application populates whether the exposure is LT rated or ST rated, based on the rating assigned to the exposure.

9.2.1.9 Risk Weight Assignment Rules

ECRA- SCRA Approach

The ECRA SCRA Approach options for risk-weighting are selected during Run definition to update the required calculations as allowed by the specific jurisdiction. Based on the run definition selected the Derivatives process passes through the Risk Weighting Approach. This is handled in Derivatives Post Crisis Risk Weight Assignment- ECRA and Banking Post Crisis Risk Weight Assignment- SCRA. For more details on the options, see the [Run Management](#) section.

The Risk weight assignment rules in Derivatives Post Crisis for Data Processing are divided into ECRA and SCRA which are selected through the run definition.

Risk Weight Assignment to all Exposures

Risk Weight is assigned based on asset class and the credit rating as per Basel guidelines. The risk weight rules operate on the risk weight table (FSI_RW_MAP_MASTER). Highly rated exposures are allocated low-risk weight and poorly rated exposures are allocated high-risk weights. If exposure has more than one rating (rated by more than one agency), then the final rating is assigned based on multiple assessments. The application updates the risk weights against the exposures directly, when ratings are not considered.

Options for risk-weighting are selected during Run definition if the Run Management UI is used, to update the required calculations as allowed by the specific jurisdiction. For more details on the options, see [Run Management](#).

Figure 72: Process Flow for SCRA Risk Weight Assignment

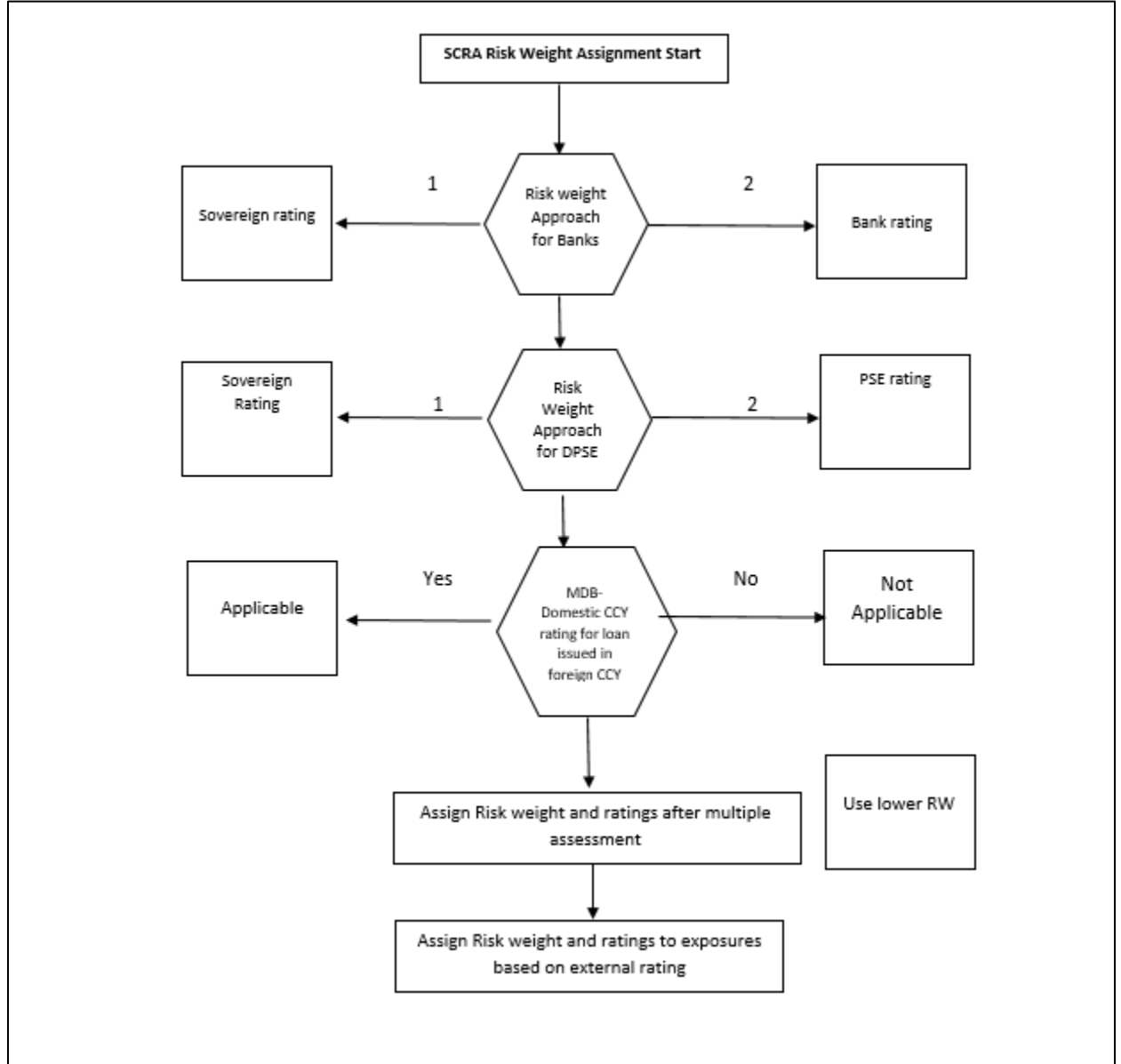

Risk weight assignment takes place in the sub-process **DRV_RISK_WEIGHT_ASSIGNMENT_STD**.

Risk Weight Assignment to Sold Credit Protection Exposures

The sold credit protection data is specific to sold credit derivatives. This data is available in the product processor table STG_CREDIT_DERIVATIVES. The sold credit protection data is processed under SOLID_PROTECTION_CREDIT_DATA_PROCESSING. The underlying data are required for all the sold credit protection.

The risk weight assignment for the sold credit protection is based on the asset type of the underlying exposure captured in Non-Sec Pre-Mitigation RW Assignment for Rated SCP – STD.

- The risk weight for the underlying exposure is calculated and this is updated to the sold credit protection exposure under the sub process Derivative Pre-Mitigation RW UL for SCP based on Revised Sec Framework
- The RWA is calculated as the Pre-mitigation EAD multiplied by the Pre-Mitigation Risk Weight
- In the case of sold credit protection exposures, the Pre-Mitigation EAD and the Post Mitigation EAD are the same since there are no mitigants for these exposures.

The underlying data for sold credit protection data is provided in the STG_UNDERLYING_EXPOSURES table. The underlying for the sold credit protection has V_UNDERLYING_DATA_IDENTIFIER where the underlying of the sold credit protection have the “V_UNDERLYING_DATA_IDENTIFIER” as “SCP”, to recognize this for the Sold credit protection treatment captured in sub process Derivative_SCP_underlying.

1. Risk Weight Assignment to Cleared Transaction Exposures

Where a bank acts as a clearing member of a CCP for its own purposes, a risk weight of 2% must be applied to the bank's trade exposure to the CCP in respect of OTC derivatives, exchange traded derivative transactions and SFTs.

Where the clearing member offers clearing services to clients, the 2% risk weight also applies to the clearing member's trade exposure to the CCP that arises when the clearing member is obligated to reimburse the client for any losses suffered due to changes in the value of its transactions in the event that the CCP defaults.

This captured in process DRV_RISK_WEIGHT_ASSIGNMENT in sub process Derivative Basel III - RW Assignment for Cleared Transactions - Exposures - Revised Approach.

2. Risk Weight Assignment to Specific Wrong Way Risk Exposures

Specific Wrong Way Risk: Wrong-way risk is defined as the risk that occurs when exposure to counterparty is adversely correlated with the credit quality of that counterparty. It arises when default risk and credit exposure increase together.

For all the transactions which are identified as Specific wrong way risk, Risk weight is assigned in process DRV_RISK_WEIGHT_ASSIGNMENT.

9.2.1.9.1 RWA Calculations

The RWA is calculated as the Pre-mitigation EAD multiplied by the Pre-Mitigation Risk Weight.

In the case of sold credit protection exposures, the Pre-Mitigation EAD and the Post-mitigation EAD is the same since there are no mitigants for these exposures.

9.2.1.9.2 Post CRM RWA Calculations

In the case of derivatives, there are no additional mitigants, and hence both pre-CRM RWA calculations and post CRM RWA calculations are one and the same which is stored in FSI_CAP_DERIVATIVES.N_EAD_POST_MITIGATION.

9.2.1.9.3 Allocation of RWA at Exposures

CCR RWA calculated at the netting set level is allocated to the exposures of the nettable pool using the following formula:

RWA at Exposure Level = Total CCR RWA at netting set level * Pre-Mitigation EAD for Exposure / Sum of Pre-Mitigation EAD for all Exposures part of CCR RWA at netting set level

9.2.2 Securities Financing Transactions Portfolio

Securities Financing Transactions (SFT) include Repo Style transactions, Margin Lending, Security Financing Borrowing, and so on.

Under Standardized method we have two approaches –

Simple Approach

In this approach, the collateral is being substituted for the covered portion of the exposure, and the risk weights as applicable for the standard mitigant type and issuer type are assigned to the collateral.

Comprehensive Approach

This is the approach wherein the collateral undergoes haircut treatment, and the exposure value gets reduced from this portion

For all SFT contracts which have a placed collateral or mitigant mapped to it, the application computes CRM based on the EAD approach undertaken by the bank.

Process Flow for Credit Risk Securities Financing Transactions

Figure 73: Process Flow for Credit Risk Securities Financing Transactions

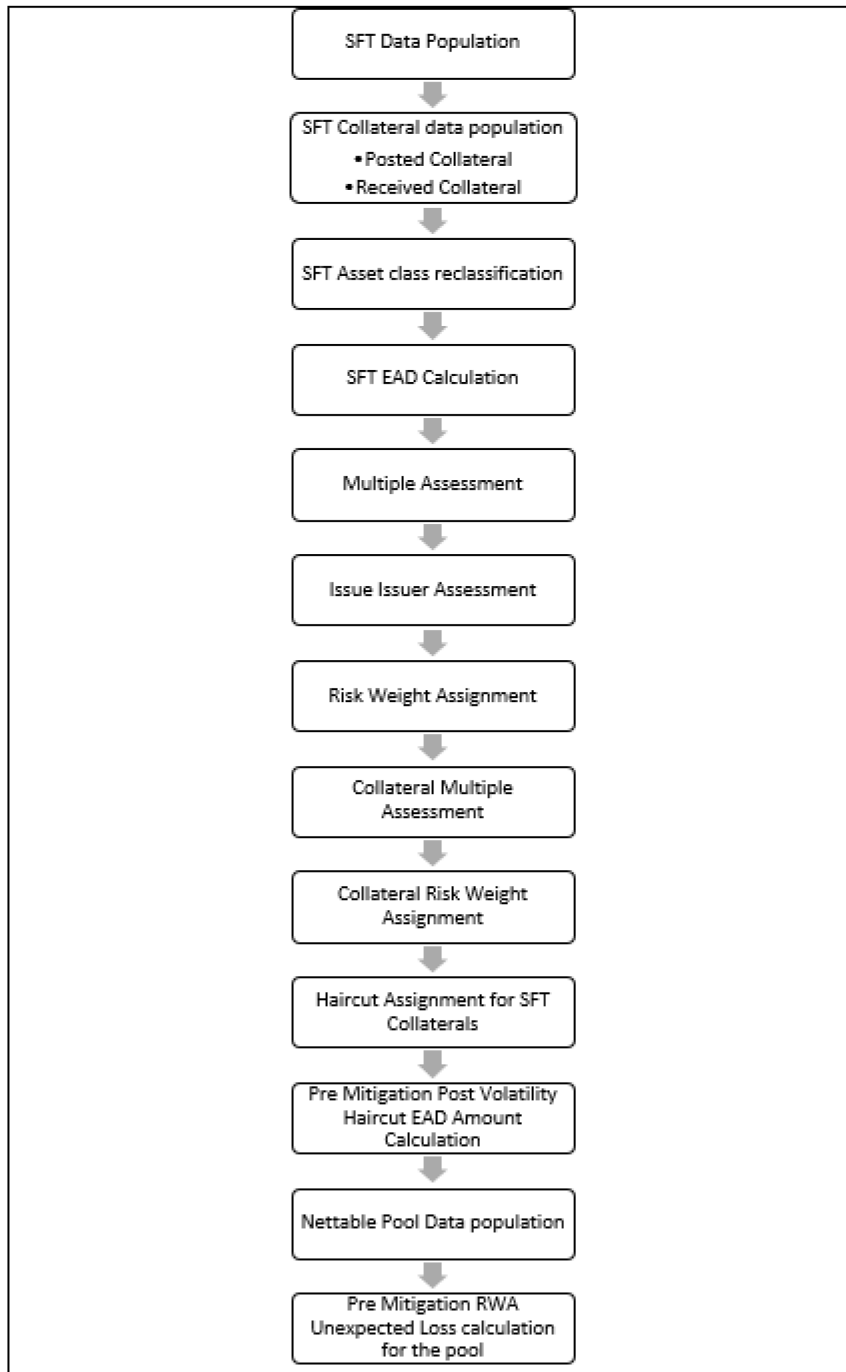

9.2.2.1 Rating Population

The data on ratings is captured in the following rating specific tables:

- Party Rating Table (**STG_PARTY_RATING_DETAILS**)

- Credit Ratings for all customers and issuers are captured in this table.
- Instrument Rating Table (**STG_INSTRUMENT_RATING_DETAILS**)
 - Credit Ratings for all instruments which are in the form of collateral either placed or received are captured in this table
- Sovereign Rating Table (**STG_SOVEREIGN_RATING_DETAILS**)
 - Credit Rating for all countries is captured in this table.

9.2.2.2 Processing Steps

Banks obtain credit ratings from different sources, and these are provided as input in the application through the rating tables mentioned in the preceding list.

This is handled in the process Credit Rating Data Population.

The application re-classifies the rating information to BIS Specific standard ratings. The out-of-box application supports the Fitch / Moodys / S&P and DBRS credit rating reclassification for Long Term and Short-Term ratings.

This is handled in the process Credit Rating Reclassification.

The rating reclassification lookup table (**FSI_RATING_CLASSIFICATION**) is used to lookup reclassified standard ratings so that the reclassification rule is not repeated for each of the rating processing tables.

Ratings are populated from the stage tables (for example, **STG_PARTY_RATING_DETAILS**) to FSI tables (for example, **FSI_PARTY_RATING_DETAILS**) using the lookup table (**FSI_RATING_CLASSIFICATION**) to obtain a reclassified rating.

Ensure that all the relevant columns as indicated in the DL Specs are mandatorily populated with data. For example, in the Stage Party Rating Details (**STG_PARTY_RATING_DETAILS**) table: Rating source code (**V_RATING_SRC_CODE**), Party Code (**V_PARTY_CD**), Purpose (**V_PURPOSE**) are required to be populated. The purpose code is to indicate whether the rating is a domestic rating or a foreign rating. If any other rating is provided, then the exposure is considered unrated.

9.2.2.3 Data Population

Credit Risk exposures are updated in the application for all the product types through their respective input tables known as Product Processors. Main categories of Counterparty Credit Risk exposures, along with their respective table names that are used as an input, are as follows:

Table 74: Data Population for Credit Risk Exposures

Product	Source Product Processor
Margin Lending Transactions	STG_LOAN_CONTRACTS
Re purchase contracts / Reverse Repurchase contracts / Security Lending & Borrowing	STG_REPO_CONTRACTS

There is a data population about the placed collateral that have been placed with respect to the SFT transaction.

Table 75: Data Population for Placed Collateral

Product	Source Product Processor
Placed Collateral	STG_PLACED_COLLATERAL

There is a data population about the mitigants, which cater to the mitigants that have been received for the SFT transaction.

Table 76: Data Population for Mitigants

Product	Source Product Processor
Mitigants – Collateral Received	STG_MITIGANTS

There is a data population about the mapping between the exposures and the mitigants. And one data population about the mapping between the exposures and the placed collateral.

Table 77: Data Population for Mapping between the Exposures and the Mitigants

Product	Source Table
Mapping for Exposures and Mitigants	STG_ACCOUNT_MITIGANT_MAP
Mapping for Exposures and Placed Collateral	STG_ACCT_PLACED_COLL_MAP

Processing table details

All Counterparty Credit Risk SFT exposures are loaded into the table, FSI Cap SFT Exposures (FSI_CAP_SFT_EXPOSURES) where further processing happens for this portfolio of exposures.

This is handled in the process SFT_Data_Population.

9.2.2.4 Shareholding Percent Multiplication

Shareholding percent multiplication for common entity level data is a part of BIS Common Data Processing (PMFCOM020) process. In this the application updates the shareholding percentage against each entity. The parent entity is updated with the value of 1 as the shareholding percent and for each child entity, the percentage is based on the parent's holding percentage as specified for each child in fact entity shareholding percent table (FCT_ENTITY_SHR_HLD_PCT).

Shareholding percent multiplication for exposure level is part of each portfolio as well. In this process, the application multiplies the entity shareholding percentage for that entity for parent entity against exposure amount, undrawn amount, and provision amount for that exposure and updates the same.

This process is handled in the sub-process SFT_SHAREHOLDING_CALCULATION_STD of the process POST_CRISIS_SFT_DATA_PROCESSING.

9.2.2.5 Common Reclassification Rules

The application reclassifies the bank's product types and party types to standard product and party types. Based on the standard product and party type, the asset class for each exposure is arrived at. Similarly, the application does reclassification for mitigant based on its mitigant types and reclassifies it to standard mitigant types.

Ensure that all products and party type and mitigants which are bank-specific are reclassified, as part of the setup activity. If they are not reclassified, the treatment might not happen as expected by the regulator.

Product Type Reclassification

Product types used by the reporting bank as input data are reclassified to standard product types as recommended in the Accord. The product types after reclassification are stored as Basel product types. For Example, any security lending product is reclassified as Security lending and borrowing product type.

This is handled in the Basel Product Type Reclassification which is part of the COMMON_RECLASSIFICATION process.

Party Type Reclassification

Similar to the product type, the customer type (which are stored as counterparty type) are also reclassified as standard counterparty type. The customer information is expected in the Stage Party Master (STG_PARTY_MASTER), and this also includes the Party Type based on the Stage Party Type Master (STG_PARTY_TYPE_MASTER).

Party type reclassification Rules handle reclassification for customer types. For Example, any Country is reclassified as Sovereign.

This is handled in the Party Type Reclassification which is part of BIS Other Reclassification process.

Mitigant Reclassification

For mitigants, the application reclassifies the mitigant type to the standard mitigant type like the debt securities, cash, and so on.

The reclassification tasks are present in the MITIGANT_TYPE_RECLASSIFICATION.

Other Reclassification

As part of the reclassification rules, any other data which is being brought inside the application like seniority, transaction type, and so on also get reclassified into OFSAA specific values. This is also mandatory to be done, otherwise data is not available for processing as required by the regulator.

This happens as part of the process COMMON_RECLASSIFICATION.

9.2.2.6 Asset Reclassification Rules

Based on Basel product type and standard counterparty type, an asset class is formed by the application. This asset class is used for data processing. The asset class is the same as specified in the accord.

For example, Standard counterparty is Corporate non-SME and Corporate SME, the asset class is corporate.

The asset class for all mitigants is reclassified based on their standard mitigant types and standard issuer type.

This happens in the sub-process SFT_RECLASSIFICATION_STD and the process POST_CRISIS_SFT_DATA_PROCESSING.

9.2.2.7 Pre-mitigation Calculations

Based on the asset class, the application calculates the Pre-Credit Risk Mitigation (CRM) Exposure at Default (EAD) for each exposure. This value signifies the maximum loss that the bank can suffer, in case of default on this exposure, before considering any mitigation effects.

In the case of SFT Exposures, the exposures are hedged against credit risk through various collateral. These collaterals provide mitigation to credit risk and must be considered while computing Credit RWA, as per the Accord. Hence, the application calculates the pre-mitigation exposure amount and post-mitigation exposure amount.

The application also computes pre-mitigation risk-weighted assets (Pre CRM RWA) and post-mitigation risk-weighted assets (Post CRM RWA) by multiplying the respective EAD by risk weight. The risk weight is arrived at, by considering the credit rating of the exposures and mitigants as per the guidelines.

9.2.2.7.1 Exposure at Default Amount Calculation

Pre-mitigation Exposure at Default can be calculated using one of the two approaches of EAD – Simple Approach and Comprehensive Approach. This is based on regulatory definition selection.

Calculation of EAD – Comprehensive Approach

As per the Comprehensive Approach, the EAD is computed by considering the Exposure amount post haircut, and the collateral amount post haircut.

Exposure Amount Calculations for the Exposures

The exposure amount from the product processor tables STG_REPO_CONTRACTS and STG_LOAN_CONTRACTS for the respective products are based on their EOP balance i.e. nothing but the End of period balance, which will be populated into the processing table (FSI_CAP_SFT_EXPOSURES) for further calculations.

This is part of the process SFT DATA POPULATION.

a. Placed Collateral & Mitigant – Eligibility

The mitigant is identified as eligible are not based on the eligibility rules for CRM as mentioned in the Basel III accord. Credit rating of the collateral is considered for all mitigants types issued by all party types, while deciding whether a mitigant is eligible for a particular exposure or not. Separate eligibility Rules exist for mitigants types like equity, mutual funds, or debt security, to perform these checks. For the remaining, a mitigant is marked as eligible only if its credit rating is better than the exposure to which it is providing protection and also if it is classified as senior in position.

The received collateral is captured in FSI Cap Mitigants (FSI_CAP_MITIGANTS). Mitigant eligibility is also checked based on the original and residual maturity of the collateral. Collateral is classified as eligible only if its original maturity is more than a year and residual maturity is more than 3 months.

The placed collateral is captured in FSI Cap Placed Collateral (FSI_CAP_PLACED_COLLATERAL) and this also moves to FSI Cap Mitigants (FSI_CAP_MITIGANTS), wherein the placed collateral and the mitigants both undergo the same treatment.

This is part of the sub process PCR - Mitigant Processing in the process BIS Post Crisis SFT Placed Collateral Data Processing - STD.

b. Placed Collateral & Mitigant – Haircut Assignment

The application assigns three kinds of mitigant haircut, which are volatility haircut, FOREX haircut, and maturity mismatch haircut.

Volatility haircuts are assigned to the collateral to account for any future fluctuations in the market value of the financial collateral. Separate Rules exist in the application for various types of financial collaterals like debt securities, equity, mutual funds, and so on. The application assigns a volatility haircut using Supervisory Haircut method when standardized approach is selected.

When the exposure and collateral are in different currencies, the application makes an adjustment by applying FOREX haircut.

If the residual maturity of CRM is less than the underlying credit exposure, then a maturity mismatch is applied. If there is a maturity mismatch and CRM have an original maturity of more than a year, the maturity mismatch haircut is applied to adjust the value.

This is part of the sub process SFT_COMPREHENSIVE_APPROACH_HAIRCUT_in the process BIS Post Crisis SFT Placed Collateral Data Processing - STD

a. EAD Calculation for Exposures that are not part of netting agreement

For SFT transaction, the application calculates EAD for the parent exposure, based on the underlying information. The underlying exposures (which are the mitigants received and the collateral placed) are moved to **FSI_SFT_UNDERLYING** table from **FSI_CAP_MITIGANTS**. **FOREX** haircut is applied if the underlying and the parent contract are in a different currency. Each SFT underlying exposure adjusted for a haircut (EAD + haircut value) is added as EAD to the parent contract.

This is part of the process BIS Post Crisis SFT Placed Collateral Data Processing - STD.

b. EAD Calculation for Exposures that are part of netting agreement

The application nets SFT contracts based on the same customer, common netting agreement identifier, the transaction of Repo, Re-Repo or Margin Lending, Trading or Banking book, and so on. Margin lending transaction being SFT also follows the same EAD calculation methodology, however Repo or Reverse Repo and margin lending are not netted together.

The calculation happens in the table FSI Cap Nettable pool (FSI_CAP_NETTABLE_POOL). This is handled in the process SFT_NETTING_CALCULATION.

Calculation of EAD – Simple Approach

As per the Simple Approach, the EAD is computed by considering the Exposure amount and the mitigants assigned being sent under Credit Risk Mitigation process and assigning based on the Risk Weight of the Mitigants and the Exposures.

a. Exposure Amount Calculations for the Exposures

The exposure amount from the product processor tables STG_REPO_CONTRACTS and STG_LOAN_CONTRACTS for the respective products are based on their EOP balance i.e., nothing but the End of period balance which will be populated into the processing table

(FSI_CAP_SFT_EXPOSURES) for further calculations. This is part of the process SFT DATA POPULATION.

b. Placed Collateral & Mitigant – Eligibility

The mitigant is identified as eligible are not based on the eligibility rules for CRM as mentioned in Basel III accord. Credit rating of the collateral is considered for all mitigants types issued by all party types, while deciding whether a mitigant is eligible for a particular exposure or not. Separate eligibility Rules exist for mitigants types like equity, mutual funds, or debt security, to perform these checks. For the remaining, a mitigant is marked as eligible only if its credit rating is better than the exposure to which it is providing protection and also if it is classified as senior in position.

The received collateral is captured in FSI Cap Mitigants (FSI_CAP_MITIGANTS). Mitigant eligibility is also checked based on the original and residual maturity of the collateral. Collateral is classified as eligible only if its original maturity is more than a year and residual maturity is more than 3 months.

The placed collateral is captured in FSI Cap Placed Collateral (FSI_CAP_PLACED_COLLATERAL) and this also moves to FSI Cap Mitigants (FSI_CAP_MITIGANTS), wherein the placed collateral and the mitigants both undergo the same treatment. This is part of the sub process PCR - Mitigant Processing in the process BIS Post Crisis SFT Placed Collateral Data Processing - STD.

c. Placed Collateral & Mitigant – Risk Weight Assignment

For Simple approach, the application assigns risk weight to mitigants on the basis of credit rating (CAP Mitigant Basel Rating and Risk Weight Assignment), and original maturity (CAP Mitigant RW Assignment based on Original Maturity). These fall under the process Mitigant RW Assignment – Simple –BIS.

This is part of the sub process PCR - Mitigant Processing in the process BIS Post Crisis SFT Placed Collateral Data Processing – STD

d. EAD Calculation for Exposures that are not part of netting agreement

For SFT transaction, the application calculates EAD for the parent exposure, based on the underlying information.

The underlying exposures (which are the mitigants received and the collateral placed) are moved to FSI_SFT_UNDERLYING table from FSI_CAP_MITIGANTS.

This is part of the process BIS Post Crisis SFT Placed Collateral Data Processing - STD The SFT exposures EAD by considering the collateral placed and received are handled as part of the credit risk mitigation process. This is in the PMF process CRM Data Processing.

e. EAD Calculation for Exposures that are part of netting agreement

The application nets SFT contracts based on the same customer, common netting agreement identifier, the transaction of Repo, Re-Repo or Margin Lending, Trading or Banking book, and so on. Margin lending transaction being SFT also follows the same EAD calculation methodology, however, Repo or Reverse Repo and margin lending are not netted together.

The netted exposure of the SFT gets computed without the effects of the collateral received and placed in the FSI Cap Nettable Pool (FSI_CAP_NETTABLE_POOL). This gets handled in the process SFT_NETTING_CALCULATION.

The SFT exposures EAD by considering the collateral placed and received are handled as part of the credit risk mitigation process. This is in the PMF process CRM Data Processing.

9.2.2.7.2 Risk Weight Assignment

Multiple Assessment

For exposures with multiple ratings, risk weight assignment is based on multiple assessment processes. For each exposure, the final rating is the worst of the best two ratings assigned to the exposure.

The risk weight corresponding to this rating is then assigned to the exposure.

Exposures for multiple rating assessments are first moved into the table FSI Multiple Rating Processing (FSI_MULTIPLE_RATING_PROCESSING) wherein the ranking and final selection of which rating to use takes place.

Below are the related sub-processes:

SFT_MULTIPLE_RATING_ASSESSMENT_POPULATION_STD, wherein the data for the multiple assessment processing gets populated into the FSI table.

MULTIPLE_RATING_ASSESSMENT, wherein the identification of the multiple rating for the exposure happens, and the

SFT Post Crisis Multiple Assessment Based Risk Weight Assignment, wherein the actual risk weight and final rating assignment happen for the exposures.

Issue Issuer Assessment

For all the exposures which remain unrated after the multiple assessment processes, the issue issuer process is performed. This happens in the Issue Issuer Assessment sub-process

(SFT_ISSUE_ISSUER_ASSESSMENT)

In this case, the unrated exposures are assigned a reference rating based on the reference issue available or the rating of the party, whichever is applicable. These unrated exposures are assigned a risk weight based on the reference rating.

For unrated exposures, the application does an issue-issuer assessment to infer a rating of the unrated exposures, based on the rating of a similar instrument (referred to as reference issue hereafter) issued by the same issuer. The reference issue is used only when it is of the same currency as the exposure and the exposure is senior or equivalent to the same. For the unavailable reference issue, the party rating is used. In the case of the party also being unrated, the exposure remains unrated. Also, the application populates whether the exposure is LT rated or ST rated, based on the rating assigned to the exposure.

Risk Weight Assignment

Risk Weight is assigned based on asset class and the credit rating as per Basel guidelines. The risk weight rules operate on the risk weight table (FSI_RW_MAP_MASTER). Highly rated exposures are allocated low-risk weight and poorly rated exposures are allocated high-risk weights. If exposure has more than one rating (rated by more than one agency), then the final rating is assigned based on multiple assessments. The application updates the risk weights against the exposures directly, when ratings are not considered.

Options for risk-weighting are selected during Run definition if the Run Management UI is used, to update the required calculations as allowed by the specific jurisdiction. For more details on the options, see [Run Management](#).

Figure 78: Process Flow for ECRA Risk Weight Assignment

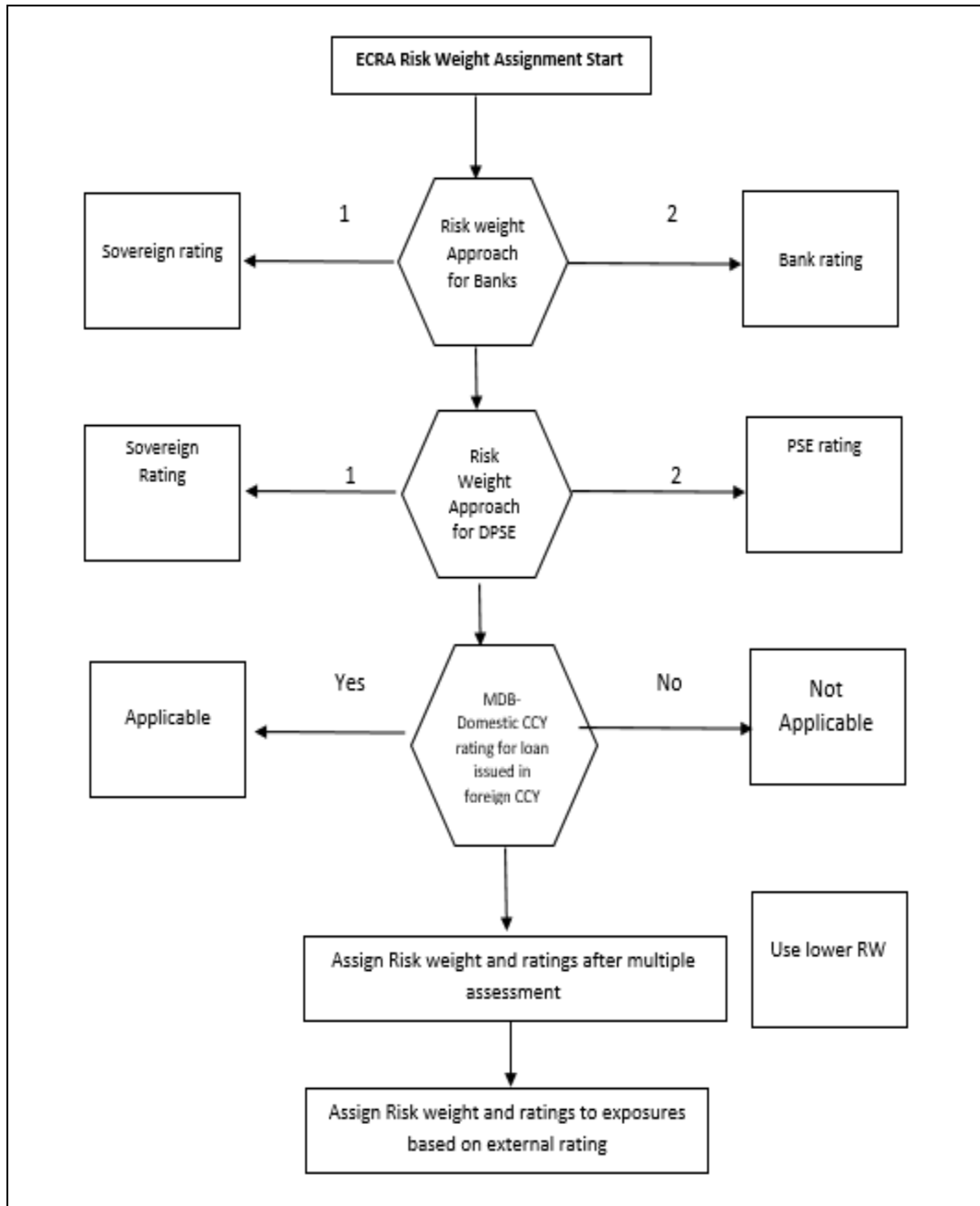
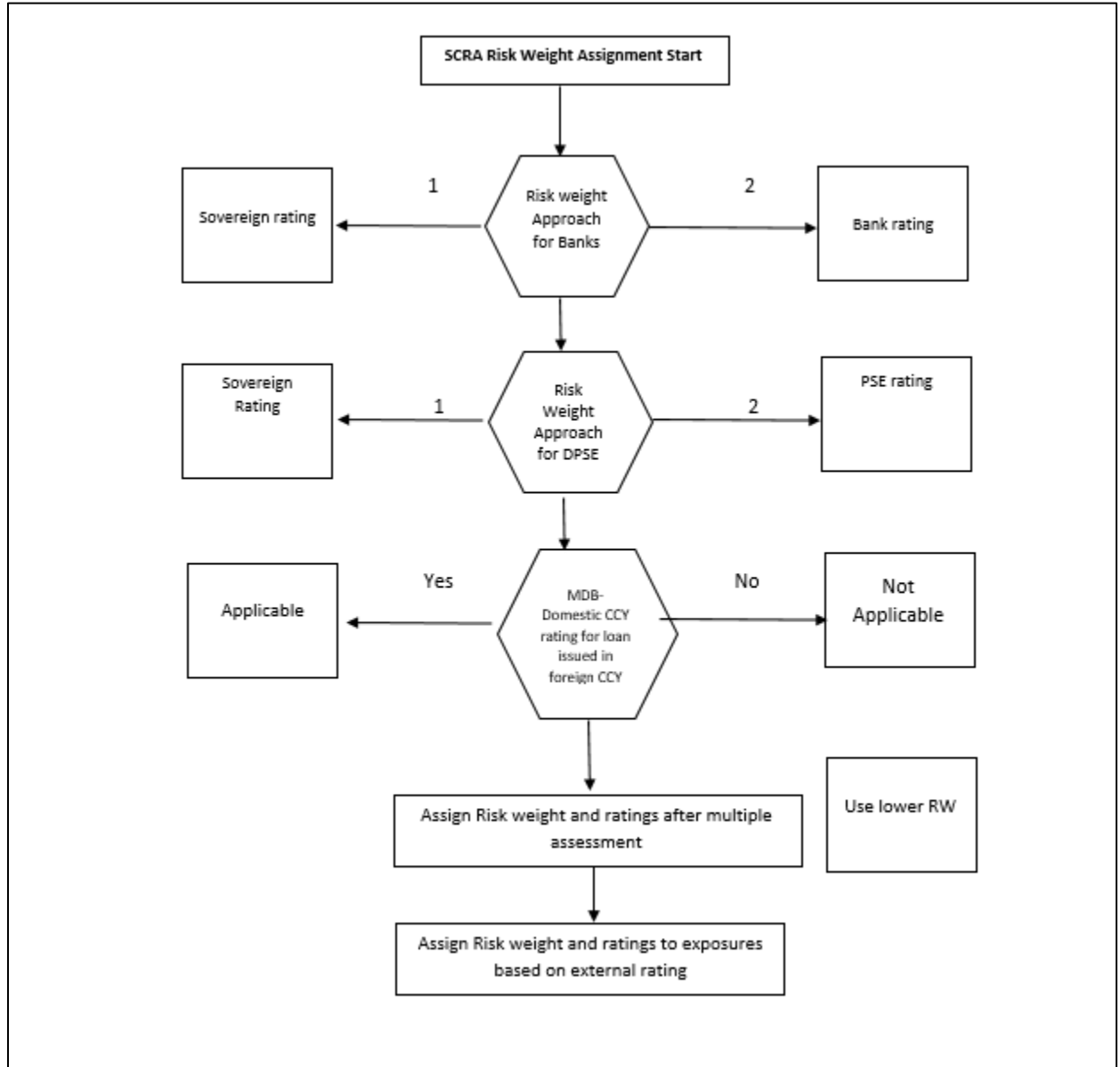

Figure 79: Process Flow for SCRA Risk Weight Assignment



Risk Weight Assignment happens in the process “SFT_RISK_WEIGHT_ASSIGNMENT STD” for the SFT Exposures.

9.2.2.7.3 RWA Calculations

The RWA is calculated as the Pre-mitigation EAD multiplied by the Pre-Mitigation Risk Weight.

9.2.2.7.4 Credit Risk Mitigation Process

In order to calculate the post CRM RWA, application needs to account for mitigants which may be in the form of collaterals (for simple approach) or guarantees that are being provided by the bank. All the mitigants which get populated into the system are being made ineligible, and then the regulatory approved mitigant types and the issuer type combination are made eligible.

9.2.3 Pooling and Optimizer

9.2.3.1 Pooling

Pooling is one of the pre-requisites for the optimized allocation of the exposures.

Pooling pulls out an exposure, and identifies all the relevant mitigants mapped to it, and the corresponding exposures mapped to these mitigants, and again the corresponding newer mitigants mapped to these exposures. This pooling assigns the cardinality to the exposures based on the mitigant combination.

This happens in the FSI Cap Sub Exposures (FSI_CAP_SUB_EXPOSURES), and the pooling is part of the sub process

The relevant cardinalities that get assigned to the exposures, as part of this pooling process are as follows:

- 1-0 → One exposure not mapped to any mitigant
- 1-1 → One exposure mapped to one mitigant
- 1-N → One exposure mapped to multiple mitigants
- N-1 → Multiple exposures mapped to a single mitigant
- N-N → Multiple exposures mapped to Multiple mitigants

9.2.3.2 Optimizer

The optimizer is the process of allocation of the mitigants to the exposures, based on the different logic applicable for the various granularity. The details of this is available in the Annexure.

Both Pooling and Optimizer is handled under the process CRM Sub Exposure Pooling and Optimizer Processing.

9.2.3.3 Post CRM RWA

The application computes the covered amount and the uncovered amount for the exposures. The covered amount is computed by multiplying the covered factor with the exposure amount. To this covered amount, the application assigns the mitigant risk weight. The product of the covered amount and the mitigant risk weight is the covered RWA. The uncovered amount is computed by multiplying the uncovered factor (which is 1 – the sum of all covered factors for that exposure) with the exposure amount. This uncovered amount is multiplied by the exposure risk weight to get the uncovered RWA. The sum of the covered RWA and the uncovered RWA is the Post CRM RWA of the Exposure.

$$\text{Post-CRM RWA} = \text{Covered Amount} * \text{Risk Weight of the Mitigant} \\ + \text{Uncovered Amount} * \text{Risk Weight of the Exposure}$$

This is handled in the process Post CRM Expected and Unexpected Loss RWA Assignment.

9.3 Credit valuation Adjustment

Banks incurred significant CVA losses during the global financial crisis. It is therefore important that the regulatory framework mitigates this risk in a prudent and robust manner. The CVA risk framework was

revised in December 2017 in part to align its design with the market risk framework published in January 2016.

Credit Valuation Adjustment is calculated at a counterparty level. CVA reflects the adjustment of default free risk prices of derivatives and SFT, due to potential default of the counterparty. Regulatory CVA can differ from Accounting CVA due to following reasons:

- Regulatory CVA excludes the default due to bank's own default
- Best practices of accounting CVA are imposed in Regulatory CVA.

CVA calculation will include all derivative transactions except those with a Qualified central counterparty (QCCP).

There are certain approaches for calculating CVA capital

- Based on CCR Capital Charge
- Basic Approach
 - Reduced Version (without considering hedges)
 - Full Version (by considering eligible hedges)
- Standardized Approach

CVA hedging instruments can be external or internal

- All external hedge that are covered transactions must be included in CVA calculation for the counterparty to hedge
- An internal CVA hedge involves two perfectly offsetting positions: one of the CVA desk and the opposite position of the trading desk.

Basic Approach CVA is used by banks unless it receives approval to use Standardized Approach CVA.

Banks require supervisory approval to use Standardized Approach CVA.

9.3.1 Rating Population

The data on ratings is captured in the following rating specific tables:

- Account Rating Table (STG_ACCOUNT_RATING_DETAILS)
 - Ratings of all Credit Risk Banking Exposures are captured in this table.
- Party Rating Table (STG_PARTY_RATING_DETAILS)
 - Credit Rating for all customers and issuers are captured in this table.
- Sovereign Rating Table (STG_SOVEREIGN_RATING_DETAILS)
 - Credit Rating for all countries is captured in this table.

9.3.2 CVA Based on CCR Capital Charge

Any bank whose aggregate notional amount of non-centrally cleared derivatives is less than or equal to 100 billion euro can follow this approach of CVA capital, based on supervisory approval.

In this approach, the CVA capital is equal to 100% of the CCR capital charge.

For all CVA calculations, there must be a run management condition to check whether the supervisor allows SFT transactions also for the CVA calculations or not. Based on this, SFT will be considered for CVA or not. And the default option will be not to consider SFT.

There must be a run management to indicate whether the bank has supervisory approval to follow the CCR Capital charge.

If the option is selected, there must be a check to consider whether the total derivative exposures, excluding the cleared transactions, is less than or equal to 100 billion euro.

In case SFT exposures are considered, the Pre mitigation EAD should be included in the aggregation, excluding the cleared transactions to be checked against the Materiality Threshold value.

9.3.3 CVA Basic Approach Reduced Version

This is the default approach to be applied for all banks following CVA calculations. This is generally applicable for all the banks who have less sophisticated practice, and do not have hedges. This is also used to restrict hedging efficiency. The reduced version eliminates the element of hedging recognition from the full version.

9.3.3.1 Process Flow of CVA Basic Approach Reduced Version

The process flow of Basic Approach reduced Version CVA is explained below:

Figure 80: Process Flow for Basic Approach Reduced Version CVA

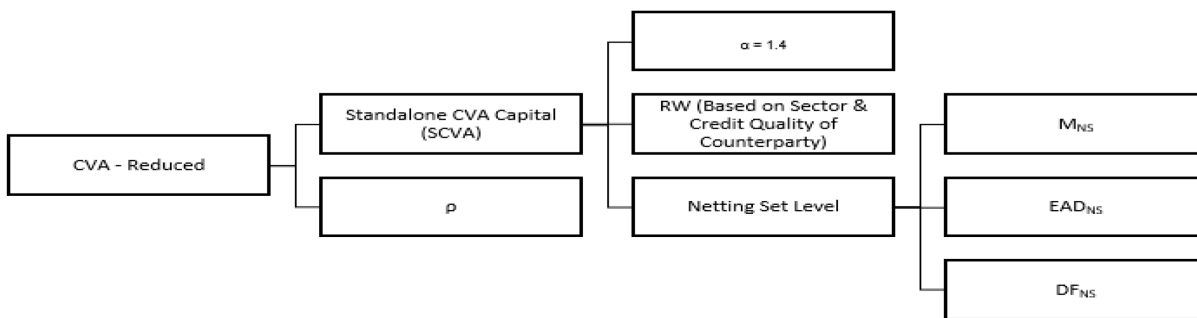

The capital requirements for CVA risk under the reduced version of the BA-CVA (DSBA-CVA × K reduced, where the discount scalar DSBA-CVA = 0.65) are calculated as follows (where the summations are taken over all counterparties that are within scope of the CVA charge)

- SCVA_c is the CVA capital requirement that counterparty *c* would receive if considered on a stand-alone basis
- It is the supervisory correlation parameter. Its square, $\rho=25\%$, represents the correlation between credit spreads of any two counterparties. In the formula below, the effect of ρ is to recognize the fact that the CVA risk to which a bank is exposed is less than the sum of the CVA risk for each counterparty, given that the credit spreads of counterparties are typically not perfectly correlated.
- The first term under the square root in the formula below aggregates the systematic components of CVA risk, and the second term under the square root aggregates the idiosyncratic components of CVA risk

$$K_{reduced} = \sqrt{\left(\rho \cdot \sum_c SCVA_c\right)^2 + (1 - \rho^2) \cdot \sum_c SCVA_c^2}$$

The stand-alone CVA capital requirements for counterparty *c* that are used in the formula is calculated as follows

- RW_c is the risk weight for counterparty *c* that reflects the volatility of its credit spread. These risk weights are based on a combination of sector and credit quality of the counterparty

Sector of counterparty	Credit quality of counterparty	
	IG	HY and NR
Sovereigns including central banks and multilateral development banks	0.5%	2.0%
Local government, government-backed non-financials, education and public administration	1.0%	4.0%
Financials including government-backed financials	5.0%	12.0%
Basic materials, energy, industrials, agriculture, manufacturing, mining and quarrying	3.0%	7.0%
Consumer goods and services, transportation and storage, administrative and support service activities	3.0%	8.5%
Technology, telecommunications	2.0%	5.5%
Health care, utilities, professional and technical activities	1.5%	5.0%
Other sector	5.0%	12.0%

The risk weight used for the calculation of the standalone CVA capital charge is based on the sector of the counterparty, and the rating of the party. For sector, we need to check on usage in FRTB. If not, the below mentioned method to identify sector is fine.

Sector of the counterparty will be given as V_INDUSTRY_CODE in STG_PARTY_MASTER.

This will get reclassified to Regulatory Industry Code (DIM_REG_INDUSTRY). CVA risk weighting will be based on Regulatory Industry Code.

The sector of the counterparty will be based on either the industry code or the standard party type

In the case of jurisdictions following ECRA, the Investment grade will be assigned to any rating which is greater than or equal to BBB-. And any rating below that, will be considered as high yield, and unrated will be treated as unrated. This has to be updated using Rating categories, instead of Ratings.

In the case of jurisdictions following SCRA, based on supervisory approval, the bank can map its internal rating to the investment grade and high yield/ unrated. Else, the risk weighting will consider only the parties as unrated, and accordingly assign the risk weight.

In the case of identifying the sectors, the party's industry code, and from that, the industry type can be used. This will be the basis on which the risk weighting will happen.

- The effective maturity will be taken as the max (1 year, calculated effective maturity). Effective Maturity will come as a download.
 - The effective maturity is taken as the weighted average effective maturity, based on the notional amount of derivatives
 - The effective maturity is taken as the weighted average effective maturity, based on the notional amount of SFT
- EAD_{NS} is the exposure at default (EAD) of the netting set NS, calculated in the same way as the bank calculates it for minimum capital requirements for CCR. Here EAD calculated as part of SAACR will be consumed.
- The supervisory discount factor is 1 for banks following IMM approach, and the below formulae when it is using SA-CCR approach. Effective Maturity is consumed in the Discount factor calculation.

$$DF_{NS} = \frac{1 - e^{(-0.05 * M_{NS})}}{0.05 * M_{NS}}$$

- Stand-alone CVA is calculated as follows:

$$SCVA_c = \frac{1}{\alpha} * RW_c * \sum_{NS} (M_{NS} * EAD_{NS} * DF_{NS})$$

Alpha=1.4

The final calculations are given below:

$$K_{BA-CVA} = DS_{BA-CVA} * K_{reduced}$$

$$DS_{BA-CVA} = \text{Discount Scalar for Reduced Version of BA CVA} = 0.65$$

$$K_{reduced} = \sqrt{(\text{Systemic Component}) + (\text{Idiosyncratic Component})}$$

$$K_{reduced} = \sqrt{[\rho * \sum_c SCVA_c]^2 + (1 - \rho^2) * \sum_c (SCVA_c)^2}$$

$$SCVA_c = \text{CVA Capital Requirement of Counterparty C}$$

$$\rho = \text{Supervisory Correlation Parameter} = 50\%$$

The risk-weighted assets for credit value adjustment risk are determined by multiplying the

capital requirements calculated by 12.5.

$$RWA_{BA-CVA} = 12.5 * K_{BA-CVA}$$

9.3.3.2 Key Data Elements

Key data elements are provided in this section for computation for Credit Valuation Adjustment

- Effective Maturity
- EAD at netting set Level
- RW of counterparty eligible for CVA

9.3.3.3 Out of Scope

The following is not covered by the application in the computation of Credit Valuation Adjustment:

- Treatment of specific wrong way risk.
- Treatment of incurred CVA loss

9.4 Default Fund Contributions Related Capital Charge

A default fund contribution refers to the funds contributed, or commitments made by a clearing member to a Central Counterparty's (CCP) equalized loss-sharing agreement. The purpose of such default funds is to provide capital, in addition to the collateral posted by participants and in addition to capital provided by the clearinghouse, as a safeguard against extraordinary losses that might occur in connection with.

For example, a financial crisis in the market or the simultaneous defaults of several large members. The clearing members contribute to such default funds kept with the central counterparty (clearing house) in the proportion of their exposure to the central counterparty.

The default fund contributions by the clearing members contribute toward the central counterparty's regulatory capital along with CCP's contributions to the default fund. These contributions act as collaterals to mutually share in the losses incurred by the clearing members due to counterparty defaults.

For each clearing member, a contribution is made to the central counterparty's default fund.

This contribution acts as a relief against the defaults by any clearing member of the central counterparty.

CRR IV explains the methods that the banking organization playing the part of a clearing member of the CCP, must adopt and compute risk-weighted assets (RWA) for a non-qualifying and a qualifying CCP.

The application handles the treatment of exposures to a QCCP and a Non-QCCP. This qualified CCP flag is expected to be provided as a download in the Party Master (**STG_PARTY_MASTER**) table.

9.4.1 Capital Charge for Non-QCCP

If the CCP is not qualified (non-QCCP), then the risk-weighted asset amount for the banking organization's default fund contribution is calculated using the Own fund's requirements for pre-funded contributions to the default fund of a non-qualifying CCP approach, as suggested in the accord.

9.4.2 Capital Charge for QCCP

If the CCP is a qualified CCP (QCCP), then the RWA amount is computed using one of the following two approaches stated below. Both are handled in the same Sub-process - RWA For Default Fund Contribution With QCCP. This is based on the run management option selected.

- Own funds requirements for pre-funded contributions to the default fund of a QCCP.
- An alternative calculation of own funds requirement for exposures to a QCCP.

The approach to the use of either the own fund requirements for QCCP or the alternative approach of the own fund requirements for QCCP is based on the run management option.

Approach 1

To compute the clearing member's capital requirement, which is the reporting bank's capital requirement for the contributions made to the CCP's default fund, the hypothetical capital requirement of the central counterparty for the default fund must be known. This must be computed by the central counterparty based on the exposures of all the clearing members to the default fund. After this figure is calculated by the CCP, it is shared with all the clearing members to enable them and to compute their respective capital requirements against the default fund.

When the reporting bank gets the hypothetical capital requirement from the QCCP, the next step is to compute the capital requirement of the reporting bank by finding out the proportion of the reporting bank's contribution in the total default fund contribution.

- The parameters considered for this purpose include the following QCCPs:
- Net potential exposure to the two largest clearing members,
- The total net potential exposure to all the clearing members,
- Total default fund contribution by all the clearing members,
- QCCP's contribution to the default fund, and
- The total number of clearing members for the default fund.

The last step is to compute the risk-weighted assets of the reporting bank corresponding to the default fund contribution to the QCCP by using the capital computed in the previous step.

These steps and the calculation involved are the following:

Step 1

It requires the QCCP to calculate its hypothetical capital requirement (KCCP) for the default fund. This is done by the QCCP and is published to the clearing members for them to use for their respective capital calculations.

Step 2

Compare KCCP with the funded portion of the default fund of a QCCP and calculate the capital requirement of the bank (KCM) by using the total of all the clearing members' capital requirements (K*CM). This capital requirement is considered on the contribution that the clearing members make to the default fund of the QCCP.

Approach 2

Capital Charge for the default fund contribution is calculated as follows:

Capital charge (Ki) = 8% * minimum (2% of Trade exposures to the QCCP + 1250% * default fund contribution to the QCCP, 20% * Trade Exposure Amount to the QCCP).

The application also supports the treatment of a CCP stopping to calculate its fund requirement to the CCP. The flag to indicate that the CCP has stopped calculating the own fund requirement is captured in the party table (**STG_PARTY_MASTER**). And based on the supervisory approval provided, in the run management option, the capital will be calculated using the Alternative approach. Else, it is treated as a normal Credit Risk Exposure, part of the Corporate Asset class.

The flag to indicate that the CCP has stopped calculating the capital requirement is expected as part of the Party Master Table (**STG_PARTY_MASTER**). In the case of this flag being null, it is expected that the CCP is calculating the Total Capital and normal processing of QCCP or Non-QCCP happens.

Key Data Elements

Key data elements to be noted are listed in this section. To view the complete list of tables used, see the Download Specification document in [MOS](#).

- Default fund contributions and related data are expected at the Default fund – Central Counterparty level in the entity Stage Central Counterparty Details (STG_CCP_DETAILS).
- Hypothetical Capital Requirement of CCP, Maximum Net Potential Exposure of clearing member of CCP, 2nd Maximum Net Potential Exposure of clearing member of CCP, Total Net Potential Exposure of clearing member of CCP, Number of Clearing Members to the CCP, Total funded Default Fund Contribution of all clearing members to the CCP, Total unfunded Default Fund Contribution of all clearing members to the CCP and Default fund contribution of CCP from its funds for each central counterparty level required.
- The application supports only the capital requirement of the bank (KCM) based on Funded/Unfunded default contributions from all clearing members not by Initial Margin. But the data model supports placeholders to capture Total Initial Margin by all clearing members to CCP and Bank's initial margin posted to CCP.

9.5 Underlying Exposures Treatment

9.5.1 Underlying Flow

Underlying Flow Related to Securitization

The application also supports Underlying exposures that are received as input through Stage Underlying Exposures table (STG_UNDERLYING_EXPOSURES). This is relevant for the securitization exposures,

Banking Underlying Exposures

For these exposures, the parent exposures are securitization exposures, mapped via the securitization pool, but the underlying are Banking exposures.

In such cases, exposures will have a record type as INV_NON_SEC_ULY (Investment Underlying) and will be populated and processed in the Banking table FSI_CAP_BANKING_EXPOSURES. This is handled in the process Bank Underlying Data Processing –STD.

Investment Underlying Exposures

For these exposures, the parent exposures as well as the underlying exposures are both investment exposures. Such exposures will have record type as INV_NON_SEC_ULY (Investment Underlying) and will be populated and processed in the Investments table, FSI_CAP_INVESTMENT_EXPOSURES.

This is handled in the similar way as a normal investment exposure in the process Investment Data Processing – STD.

Underlying Flow Related to CIU

The application also supports Underlying exposures that are received as input through Stage Fund Underlying Composition table (STG_FUND_UNDERLYNG_COMPOSITION). This is relevant for the CIU exposures, the application also supports the underlying composition received as input through the Stage Fund CIS Composition table (STG_FUND_CIS_COMPOSITION)

Investment Underlying Exposures

For these exposures, the parent exposures as well as the underlying exposures are both investment exposures. Such exposures will have record type as INV_NON_SEC_ULY (Investment Underlying) and will be populated and processed in the Investments table, FSI_CAP_INVESTMENT_EXPOSURES.

Derivatives Underlying Exposures

For these exposures, the parent exposures are investment exposures, but the underlying are Derivatives exposures. Such exposures will have record type as INV_NON_SEC_ULY (Investment Underlying) and will be populated and processed in the Derivatives table FSI_CAP_DERIVATIVES.

This is handled in the process Derivatives Underlying Data Processing -STD.

Underlying Exposures Treatment

Underlying Exposures Data Flow and Treatment Related to Covered Bond

The application also supports Underlying exposures that are received as input through Stage Underlying Exposures table (STG_UNDERLYING_EXPOSURES). This is relevant for the covered bond exposures,

Banking Underlying Exposures

For these exposures, the parent exposures are covered bond exposures, mapped via the parent instrument code, but the underlying are Banking exposures.

In such cases, exposures will have a record type as INV_NON_SEC_ULY (Investment Underlying) and will be populated and processed in the Banking table FSI_CAP_BANKING_EXPOSURES. This is handled in the process Bank Underlying Data Processing –STD.

9.6 Credit RWA for Securitization

As per the revised guidelines for securitization framework, which is focused on addressing the short comes of the existing guidelines, a revised hierarchy of approaches that replaces the existing approaches have been introduced.

The application assigns the appropriate approach to the exposures, based on the criteria specified in the Revised guidelines. The application assigns any of the below approaches under securitization standardized approach:

- Sec-External Ratings Based Approach (SEC-ERBA)
- Sec – IAA Approach

- Sec-Standardized Approach (SEC-STD)- SSFA
- Sec 1250% RW

9.6.1 Securitization – Revised Framework

The procedure by which the application handles the advanced approach of securitization exposures is as follows:

Figure 81: Securitization – Revised Framework

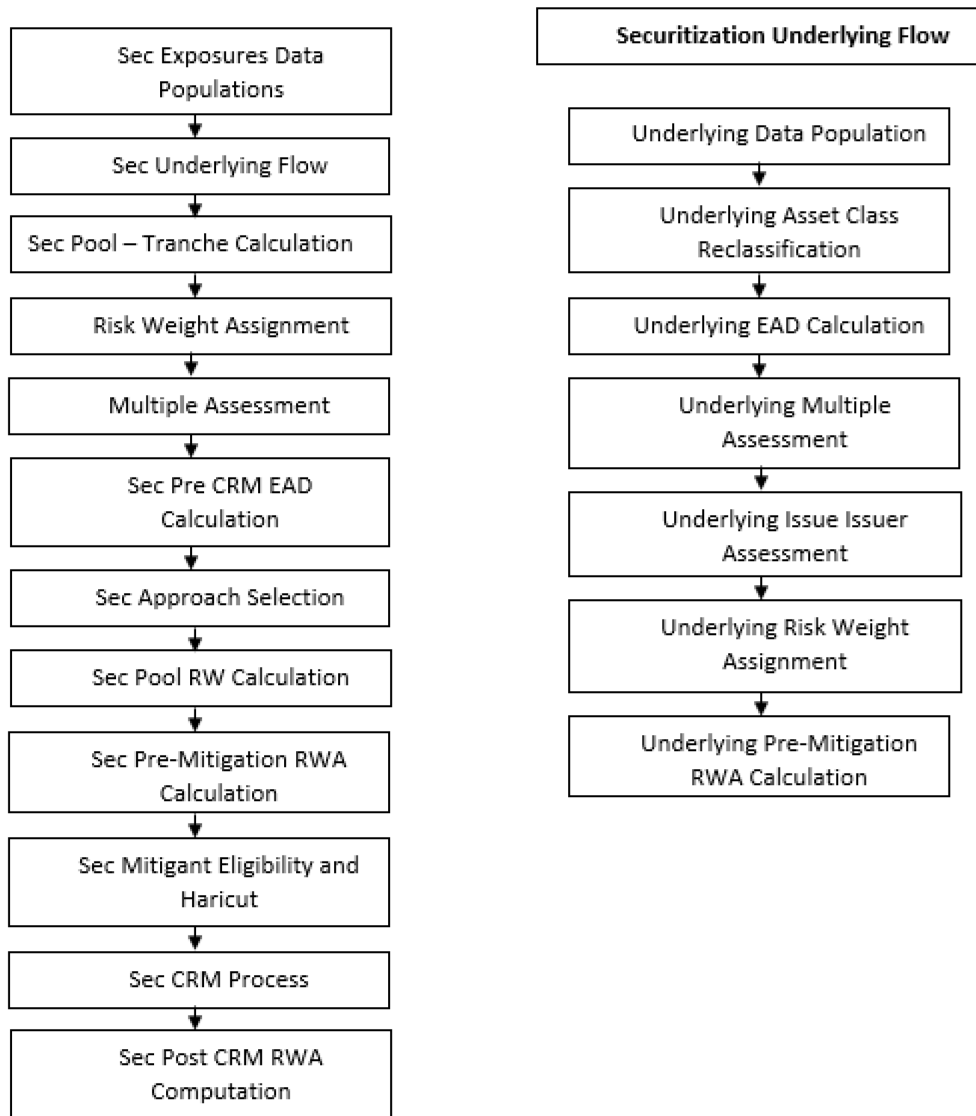

9.6.2 Rating Population

Credit Rating Process

The entire rating information of the exposures and the mitigants are populated from the staging tables to the processing tables. The exposure and the tranche rating information are captured in the account rating (**STG_ACCOUNT_RATING_DETAILS**) and the instrument rating (**STG_INSTRUMENT_RATING_DETAILS**) tables respectively and the mitigant rating information is captured in the instrument rating details (**STG_INSTRUMENT_RATING_DETAILS**) table.

- Account Rating Table (**STG_ACCOUNT_RATING_DETAILS**)
 - Credit Rating for all exposures
- Instrument Rating Table (**STG_INSTRUMENT_RATING_DETAILS**)
 - Credit Rating for all tranche and mitigants
- Party Rating Table (**STG_PARTY_RATING_DETAILS**)
 - Credit Rating for all issuers are captured in this table.
- Sovereign Rating Table (**STG_SOVEREIGN_RATING_DETAILS**)
 - Credit Rating for all countries is captured in this table.

The Processing Steps are as follows:

Banks obtain credit ratings from different sources, and these are provided as an input in the application through the rating tables mentioned in the preceding list.

This is handled in the process Credit Rating Data Population.

The application re-classifies the rating information to BIS Specific standard ratings. The out-of-box application supports the Fitch / Moodys / S&P and DBRS credit rating reclassification for Long Term and Short-Term ratings.

This is handled in the process Credit Rating Reclassification.

The rating reclassification lookup table (**FSI_RATING_CLASSIFICATION**) is used to lookup reclassified standard ratings so that the reclassification rule is not repeated for each of the rating processing tables.

Ratings are populated from the stage tables (for example, **STG_PARTY_RATING_DETAILS**) to FSI tables (for example, **FSI_PARTY_RATING_DETAILS**) using the lookup table (**FSI_RATING_CLASSIFICATION**) to obtain a reclassified rating.

Ensure that all the relevant columns as indicated in the DL Specs are mandatorily populated with data. For example, in the Stage Party Rating Details (**STG_PARTY_RATING_DETAILS**) table: Rating source code (**V_RATING_SRC_CODE**), Party Code (**V_PARTY_CD**), Purpose (**V_PURPOSE**) are required to be populated. The purpose code is to indicate whether the rating is a domestic rating or foreign rating. If any other rating is provided, then the exposure is considered as unrated.

9.6.3 Data Population

9.6.3.1 Pre-Processing Steps

Securitization and Mitigant Data Population with Mitigant Mapping

For an investing bank, the data is expected in the Stage Underlying Exposures (**STG_UNDERLYING_EXPOSURES**) for the underlying of the pool, Total Pool Level attributes in the Stage Pool table (**STG_SECURITIZATION_POOL**), Tranche Level attributes in the Stage Tranche table (**STG_SECURITIZATION_TRANCHE**), and the Exposure Level Attributes in the respective PP tables.

For an originator, the data is expected in the same manner as the Investor.

For a credit protection exposure in the form of guarantee, it is expected in the Stage Guarantees table (**STG_GUARANTEES**); and if it is a credit derivative, it is expected in the Stage Credit Derivatives table (**STG_CREDIT_DERIVATIVES**). If it is a regular investment in the Tranches by an investing bank, or it is part of the mandate for retention in the pool or tranche for an originating bank, the data is expected in the Stage Investments table (**STG_INVESTMENTS**).

For a liquidity facility exposure, or servicer cash advance, the exposures are expected in the Stage Commitment Contracts table (**STG_COMMITMENT_CONTRACTS**).

For the securitization hedges done through swaps the exposures are expected in the stage swaps contracts table (**STG_SWAPS_CONTRACTS**).

This is handled in the process Sec Data Population

With respect to the securitization, the underlying exposures, which are not securitization exposures, follow the process pertaining to the non-securitization exposures. The underlying exposures, which are securitization exposures, follow the process pertaining to the securitization exposures.

The mitigants data are populated from the staging table to the processing table. The exposures which are mapped to the mitigants are captured and populated from the staging table to the processing table.

Mitigant data population is handled by the process **CAP_MITIGANT_DATA_POPULATION** in BIS Standard run.

Exposure mitigant mapping population is handled in the process **ACCT_MITIGANT_MAPPING_POP**

9.6.4 Shareholding Percent Multiplication

Shareholding percent multiplication for common entity level data is a part of BIS Common Data Processing (PMFCOM020) process. In this the application updates the shareholding percentage against each entity. The parent entity is updated with the value of 1 as the shareholding percent and for each child entity, the percentage is based on the parent's holding percentage as specified for each child in fact entity shareholding percent table (**FCT_ENTITY_SHR_HLD_PCT**).

Shareholding percent multiplication for exposure level is part of each portfolio as well. In this process, the application multiplies the entity shareholding percentage for that entity with respect to parent entity against exposure amount, undrawn amount and provision amount for that exposure and update the same.

This is handled in the process **SEC_DATA_PROCESSING_STD**

9.6.5 Common Reclassification Rules

The application reclassifies the bank's product types and party types to standard product and party types. Based on the standard product and party type, it forms an asset class for each exposure is arrived at. Similarly, the application does reclassification for mitigant based on its mitigant types and reclassifies it to standard mitigant types.

Ensure that all products and party type and mitigants which are bank-specific are reclassified, as part of the setup activity. If they are not reclassified, the treatment might not happen as expected by the regulator.

1. Product Type Reclassification

Product types used by the reporting bank as input data are reclassified to standard product types as recommended in the Accord. The product types after reclassification are stored as Basel product types. For Example, Housing Loan is reclassified as Residential Mortgage Exposure.

This is handled in the Basel Product Type Reclassification which is part of the COMMON_RECLASSIFICATION.

2. Party Type Reclassification

Similar to the product type, the customer type (which is stored as counterparty type) are also reclassified as the standard counterparty type. The Basel application is designed to include customer type, and legal entity type in a single table (STG_PARTY_MASTER). This is applicable for staging and the dimension model. These are reclassified together as well. Party type reclassification Rules handle reclassification for customer, and entity types. For Example, an Individual is reclassified as Retail.

This is handled in the Party Type Reclassification which is part of BIS Other Reclassification process.

3. Mitigant Reclassification

For mitigants, the application reclassifies the mitigant type to the standard mitigant type like the debt securities, cash, and so on.

The reclassification tasks are present in the COMMON_RECLASSIFICATION sub-process.

4. Other Reclassification

As part of the reclassification rules, any other data which is being brought inside the application like Pool Type, seniority, transaction type, and so on also get reclassified into OFSAA specific values.

This is also mandatory to be done, as otherwise, data will not be available for processing as required by the regulator. This happens as part of the process COMMON_RECLASSIFICATION.

9.6.6 Asset Reclassification Rules

This is applicable only for the underlying exposures. See the banking and investment process.

9.6.7 Due Diligence Requirement for Securitization Exposures

If a banking organization can meet due diligence requirements, a Bank can follow any risk weight approach under securitization, to all its securitized exposures, as per the revised hierarchy of approaches. If the bank is not able to meet the due diligence requirements, then all the exposures will be risk-weighted at 1250%.

The application assigns the appropriate approach to the exposures, based on the criteria specified in the Revised Accord.

This happens in the process SEC_DATA_PROCESSING_STD.

9.6.8 Sec Approach Selection

In the case of banks which follow the standardized approach for their credit risk of non-securitization approaches, the hierarchy is SEC-ERBA, SEC-IAA, SEC-STD and 1250% Risk Weight,

SEC-ERBA (Sec – External Ratings Based Approach) subject to supervisory approval is based on the external ratings assigned to the exposures or the instruments, and also depends on other attributes like the maturity and the tranche thickness.

In case of absence of external rating, the exposures will undergo SEC-IAA (Internal Assessment Approach), based on supervisory approval.

And, if these approaches are not applicable, then the exposures will be assigned a risk weight using SEC-STD Approach.

And if none of the approaches are applicable then the exposures will be assigned a risk weight of 1250%.

This happens as part of the sub-process Securitization Risk Weight Methodology Assignment under the process SEC_DATA_PROCESSING_STD

9.6.8.1 Pre-mitigation Calculations

The application calculates the Pre-Credit Risk Mitigation (CRM) Exposure at Default (EAD) for each exposure. This value signifies the maximum loss that the bank can suffer, in case of default on this exposure, before considering any mitigation effects.

The application also computes pre-mitigation risk-weighted assets (Pre CRM RWA) and post-mitigation risk-weighted assets (Post CRM RWA) by multiplying the respective EAD by risk weight. The risk weight is arrived by using the hierarchy of approaches as suggested.

9.6.8.2 Exposure at Default Amount Calculation

Exposure at Default (EAD) is calculated using the Exposure Amount (EOP Balance of the Exposure), Undrawn Amount of the Exposure (Undrawn Amount), and also the Credit Conversion Factor for the Off-Balance sheet Amount (CCF). This is computed for the on-balance sheet products separately, and the off-balance sheet products separately.

This is handled in the sub-process Sec Pre CRM EAD-Calculation under the process SEC_DATA_PROCESSING_STD.

9.6.8.3 Multiple Assessment

For exposures with multiple ratings, risk weight assignment is based on multiple assessment processes. For each exposure, the final rating is the worst of the best two ratings assigned to the exposure.

The risk weight corresponding to this rating is then assigned to the exposure.

Exposures for multiple rating assessments are first moved into the table FSI Multiple Rating Processing (FSI_MULTIPLE_RATING_PROCESSING) wherein the ranking and final selection of which rating to use takes place.

This happens in the process of **SEC_MULTIPLE_ASSESSMENT**, under that sub-process the application has data transformation separately for exposures and its tranches.

9.6.8.4 Risk Weight Assignment

Sec-External Ratings Based Approach (SEC-ERBA)

If there is a supervisory approval, the application continues with the computations else it will look for the next approach.

For exposures that follow the external ratings-based approach, the risk weight assignment is based on the criteria used for risk weighting. This is handled as part of the sub-process Securitization Risk Weight Assignment for Rated Exposures.

The application uses the seniority position of the exposure, maturity, thickness of the exposure and the credit rating to assign the risk weight to the exposure.

To ensure that the exposures have the risk weight assigned based on their maturity term, the application supports interpolation of the risk weight to accommodate the varying maturity of the exposures.

The DT which is used for interpolation is "Sec_Interpolated_RW" which updates interpolated risk weights for each exposure in the FCT_SEC_EXPOSURES table. Exposures updated include both "STC condition met" exposures and "STC condition not met" exposures.

This happens in the sub-process SEC_INTERPOLATED_RISK_WEIGHT_AND_AVG_EXS_SPRD under SEC_DATA_PROCESSING_STD

Once the risk weights are assigned based on the above-mentioned process the application calculates the Sec Risk Weight Calculation under the process SEC_DATA_PROCESSING_STD.

SEC-IAA

Sec IAA is followed in the application based on Internal assessment on the exposures also based on the ABCP indicator. The exposures with that flag enabled F_ABCP_IND will undergo the SEC_IAA approach. The Sec IAA is also to be followed based on the supervisory approval. This SEC-IAA methodology is assigned on the sub-process Securitization Risk Weight Methodology Assignment.

Once after the approach assignment, the application calculates the Risk weight as part of the sub-process Securitization Risk Weight Assignment for Rated Exposures under the process SEC_DATA_PROCESSING_STD, and the risk weight calculations are handled in the sub-process Sec Risk Weight Calculation under the process SEC_DATA_PROCESSING_STD.

Sec-Standardized Approach (SEC-STD)

For exposures following the sec-standardized approach, the application calculates the underlying weighted average capital requirement of the securitization pool (KSA). This is handled at sub-process Securitization Pool Capital Charge Calculation using STD Approach.

Other parameters needed for SEC-STD are calculated by the application based on underlying data. This is handled as part of the sub-process Securitization Pool Capital Charge Calculation using STD Approach and the pool level data calculation happens as part of the sub-process SEC_POOL_DELIQUENT_BALANCE_CALCULATION.

After all the parameters are calculated, the application computes SSFA (Simplified Supervisory formula approach) capital and uses the below-mentioned logic for risk weight computation. The exposures for which are detachment point (D) less than that of the KA, the exposures are deducted (it is risk-weighted at 1250%). The exposures for which the credit enhancement level is more than that of the KA, the exposures

have the KSSFA (SSFA capital charge) computed. The exposures for which the credit enhancement level is less than that of the KA, but the sum of the credit enhancement level and the tranche thickness are more than the KA, the exposures are straddled, and that is, the tranche to which the exposure belongs to is split into a position below KA and a position above KA. All the exposures mapped to the straddled tranche are also split by the application in the same proportion as the split tranche. Post-straddling risk weight is computed using the computation logic mentioned by the accord.

This happens as part of the sub-process SEC_TRANCHE_PARAMETER_CALCULATIONS.

For the calculation of Risk weight under standardized approach (SEC_STD) the below sub-process in the application calculates the respective values mentioned above in the processing table for each exposures. This happens part of the sub process Sec SA Pre CRM Capital-Calculation under the process SEC_DATA_PROCESSING_STD

Maximum RW for Exposures

Maximum risk weight requirements for senior exposures for all the pools is handled by the application as per the logic given in the accord.

For Maximum capital requirement, in order to apply a maximum capital charge to a bank's securitization exposure, the following inputs are required: The largest proportion of interest that the bank holds for each tranche of a given pool (P). In particular: – For a bank that has one or more securitization exposure(s) that reside in a single tranche of a given pool, P equals the proportion (expressed as a percentage) of securitization exposure(s) that the bank holds in that given tranche (calculated as the total nominal amount of the bank's securitization exposure(s) in the tranche) divided by the nominal amount of the tranche. For a bank that has securitization exposures that reside in different tranches of a given securitization, P equals the maximum proportion of interest across tranches, where the proportion of interest for each of the different tranches must be calculated as described above.

This happens in the sub process SEC_POOL_TRANCHE_PARAMETERS_UPDATE_EXPOSURES under the process SEC_DATA_PROCESSING_STD

If none of the approach is applicable for the exposures, then 1250% Risk Weight will be applicable. This approach assignment happens part of the sub process Securitization Risk Weight Methodology Assignment under the process SEC_DATA_PROCESSING_STD. Once after the above sub process the risk weight calculation will happen based on the Sec 1250% risk weight in the sub process Sec Risk Weight Calculation under the process SEC_DATA_PROCESSING_STD.

Re-securitized exposures

Re-securitized exposures are the exposures which are issued out of a pool of underlying exposures which constitutes non-securitized exposures and some portion of securitized exposures. Application is capable of handling both securitized exposures and re-securitized exposures.

The securitized underlying of the re-securitization pool will be captured in the Stage underlying Exposures (STG_UNDERLYING_EXPOSURES). As per the revised framework, the approach that should be used for risk weight calculation is standardized approach only, no other approaches are applicable. The application assigns the same approach based on the re-securitization flag. For these exposures parameters that are used in standardized approach are calculated for both non-securitized and securitized exposures using the logic mentioned in the revised accord.

This happens in the sub process RESEC_POOL_RW_CALCULATIONS under the process SEC_DATA_PROCESSING_STD.

STC Transactions (STC Transaction)

As per the revised Basel guidelines the transaction with simplicity means the homogeneity of the underlying assets belong to same products / characteristics and simple in nature which have the transparency of the underlying assets, the details of the transactions are with sufficient information also they are easily comparable against the equivalent transactions. The eligibility of these conditions is checked for the transactions and these transactions are handled separately by the application

This is in the sub process SEC_ELIGIBILITY_FOR_STC_TRANSACTIONS under the process **SEC_DATA_PROCESSING_STD.**

Once the Eligibility conditions are checked for the exposures based on the above sub process the respective exposures are handled in the downstream sub process in the application which are stated above under various approaches.

Sec Pre-CRM RWA Computation

The application calculates the Pre-CRM RWA for the exposures by multiplying the Pre-CRM EAD with the risk weight of the exposures. Pre-CRM RWA is computed in the Sec Pre-CRM RWA Computation sub process.

This is handled in application under Sec Pre CRM RWA-Computation.

9.6.8.5 Credit Risk Mitigation Process

In order to calculate the post CRM RWA, application needs to account for mitigants which may be in the form of collaterals, guarantees, credit derivatives. Not all mitigants are eligible for RWA computation. All the mitigants which get populated into the system are being made ineligible, and then the regulatory approved mitigant types and the issuer type combination are made eligible in Mitigant Processing.

Mitigant Data population

Mitigant data is loaded from the Stage Mitigant table (STG_MITIGANTS) into the FSI CAP Mitigants table (FSI_CAP_MITIGANTS) where further processing takes place. This is takes place under the process Mitigant Data Population.

Mitigant Multiple assessment

Similar to exposures with multiple ratings, mitigants with multiple ratings are also subject to Multiple rating Assessment. This is handled under the sub-process Mitigant Multiple Rating Assignment – BIS.

All the guarantees and credit derivatives issued by issuers that are reclassified as Other Entities are treated as eligible for Securitization exposures if they satisfy the current rating and the original rating criteria specified by the Basel accord. For processing the original rating of these issuers, the application performs the multiple assessments of the initial ratings.

The Data Transformation “CAP_MITIGANT_MULTIPLE_ASSESSMENT_DATA_POP” performs this.

Mitigant Eligibility Approaches and their Risk Weighting Rules

Mitigant Risk Weight

For Simple approach, the application assigns risk weight to mitigants on the basis of credit rating (CAP Mitigant Basel Rating and Risk Weight Assignment), original maturity (CAP Mitigant RW Assignment based on Original Maturity). These fall under the process Mitigant RW Assignment – Simple –BIS.

Similarly, for Comprehensive approach, mitigant risk weights are assigned on the basis of credit rating (CAP Mitigant Basel Rating and Risk Weight Assignment), for financial collaterals (CAP Mitigant RW

Assignment for Financial Collaterals - Comprehensive Approach). These fall under the process Mitigant RW Assignment – BIS –Comprehensive Approach.

Mitigant Eligibility

The application identifies the eligible mitigants based on the criteria as mentioned by the Regulator. The application identifies the following standard mitigants– collateral, guarantees, and credit derivatives.

The application is capable of using the Simple Approach and the Comprehensive Approach for the mitigants which are part of the collateral. The application identifies the eligibility of the financial collateral separately for the simple approach and the comprehensive approach. The eligibility of the collateral mitigants is based on the party type of the mitigant, mitigant types, the credit rating assigned to the mitigant or the party (as applicable), and the classification of collateral as senior or not.

This is handled in CAP Mitigant Eligibility for Equity - Simple approach under the process Mitigant Collateral Eligibility Simple Approach -BIS

For mutual funds, the eligibility is based on the eligible mutual fund indicator. This is handled in CAP Mitigant Eligibility for Mutual Fund - Simple approach under the process Mitigant Collateral Eligibility Simple Approach -BIS

The application also identifies whether the mitigant is a Re-securitized exposure and if yes, makes it ineligible. This is handled in CAP Collateral Eligibility - Simple Approach under the process Mitigant Collateral Eligibility Simple Approach -BIS

The application identifies the eligibility of the guarantees and credit derivatives based on the party type of the mitigant and the credit rating assigned to the issuer of the mitigant. This is handled in the process Mitigant Collateral Eligibility Simple Approach –BIS.

Similar mitigant eligibility rules for Comprehensive Rule can be found in the process Mitigant Collateral Eligibility – Comprehensive Approach –BIS.

The option for the bank to select Collateral Simple Approach or Comprehensive Approach is based on the Run Management option as selected in the UI.

Mitigant Haircut Assignment

Under Standardized approach, the bank has to follow supervisory estimates for Mitigant Haircut assignment. This is based on the various categories like mitigant type, residual maturity, rating, issuer type and so on. This is applicable only if the bank follows comprehensive approach for collateral.

Only eligible mitigants are considered for haircut assignment and for further processing. Post haircut assignment, the eligible mitigants are moved from mitigants table (FSI_CAP_MITIGANTS) to sub exposures table (FSI_CAP_SUB_EXPOSURES).

The application does computations for three kinds of mitigant haircuts which are volatility haircut, FOREX haircut, and maturity mismatch haircut.

Volatility Haircut

Volatility haircuts are assigned to the collateral to account for any future fluctuations in the market value of the financial collateral. The application assign haircuts for various type of financial collateral like debt securities, equity, mutual funds, and so on. In the supervisory haircut method, the application assigns volatility haircut based on issues, issuer's ratings, mitigant's residual maturity, and type of mitigant.

This is handled in CAP CRM Mitigant Volatility Haircut - Supervisory Haircut under CRM Sub Exposure Data Haircut Assignment process.

Forex Haircut

If the exposure and collateral are in different currencies, then the application makes an adjustment by applying the FOREX haircut.

This is handled in CAP CRM Forex Haircut Sub Exposures under CRM Sub Exposure Data Haircut Assignment process.

Maturity Mismatch Haircut

If the residual maturity of the Credit Risk Mitigant is less than that of the underlying credit exposure, then a maturity mismatch haircut is applied to adjust the value.

This is handled under CAP CRM Maturity Mismatch Haircut under CRM Sub Exposure Data Haircut Assignment process.

9.6.9 Pooling and Optimizer**9.6.9.1 Pooling**

Pooling is one of the pre-requisites for the optimized allocation of the exposures.

Pooling pulls out an exposure and identifies all the relevant mitigants mapped to it, and the corresponding exposures mapped to these mitigants, and again the corresponding newer mitigants mapped to these exposures. This pooling assigns the cardinality to the exposures based on the mitigant combination.

This happens in the FSI Cap Sub Exposures (FSI_CAP_SUB_EXPOSURES), and the pooling is part of the sub-process.

The relevant cardinalities that get assigned to the exposures, as part of this pooling process are as below:

- 1-0 → One exposure not mapped to any mitigant
- 1-1 → One exposure mapped to one mitigant
- 1-N → One exposure mapped to multiple mitigants
- N-1 → Multiple exposures mapped to a single mitigant
- N-N → Multiple exposures mapped to Multiple mitigants

9.6.9.2 Optimizer

The optimizer is the process of allocation of the mitigants to the exposures, based on the different logic applicable for the various granularity. For more information, see [Annexure](#).

Both Pooling and Optimizer are handled under the process CRM Sub Exposure Pooling and Optimizer Processing.

9.6.9.3 Post CRM RWA Computation

The application computes the covered amount and the uncovered amount for the exposures. The covered amount is computed by multiplying the covered factor with the exposure amount. To this covered amount, the application assigns the mitigant risk weight. The product of the covered amount and the mitigant risk weight is the covered RWA. The uncovered amount is computed by multiplying the uncovered factor (which is 1 – sum of all covered factors for that exposure) with the exposure amount.

This uncovered amount is multiplied by the exposure risk weight to get the uncovered RWA. The sum of the covered RWA and the uncovered RWA is the Post CRM RWA of the exposure.

9.7 Operational Risk (OR) – The Standardized Approach

Operational risk is defined as the risk of loss resulting from inadequate or failed internal processes, people and systems or from external events. The Basel committee after reviewing the existing approaches of Operational risk capital calculation it has come up with revised standardized approach for calculating the operational risk capital.

The Standardized Approach methodology is based on the following components:

- (i) the Business Indicator (BI) which is a financial-statement-based proxy for operational risk
- (ii) the Business Indicator Component (BIC), which is calculated by multiplying the BI by a set of regulatory determined marginal coefficients (α_i)
- (iii) the Internal Loss Multiplier (ILM), which is a scaling factor that is based on a bank's average historical losses and the BIC.

Minimum operational risk capital (ORC) is calculated by multiplying the BIC and the ILM

$$\text{ORC} = \text{BIC} * \text{ILM}$$

9.7.1 Data Population

The Business Indicator component information for any bank will be available in their general ledger. So, the GL level information for these business components which is required to calculate the Business Indicator is sourced from the STG_GL_DATA stage table.

The respective GL information should be from the STG_GL_MASTER Stage GL Master table.

This is handled in the process of FSI_OR_BUSINESS_INDICATOR_DTL_DATA_POP.

The loss data based on the Banks discretion whether they want to consider the Internal Loss data or the Internal Loss data from the regulatory definition the information is sourced from STG_INT_OPERATIONAL_RISK_LOSS or from the STG_EXT_OPERATIONAL_RISK_LOSS.

The loss from the internal entities is captured as the information in the LV Code similarly for the loss due to external factors the entity information is considered as a party which has created the loss.

This is handled in the process of FSI_CAP_HIST_OPERATIONAL_LOSS_POP.

The information of the Financial Year is taken from the Stage Financial year master and the same is consumed in identifying the Jurisdictions Financial year. This financial year plays the important role in identifying the number years data considered for the Business Indicator Calculation and similarly in the Historical Loss data calculation for Loss Component.

9.7.1.1 The Business Indicator

The Business Indicator (BI) comprises three components:

1. the interest, leases and dividend component (ILDC)
2. the services component (SC)
3. the financial component (FC).

The BI is defined as $BI = ILDC + SC + FC$

The information sourced from the Stage GL Data will be reclassified as the Business Indicator Values using the sub process OR – GL Account to Business Indicator Reclassification and they stored in the FSI_OR_BUSINESS_INDICATOR_DTL table. The reclassification helps the application in identifying and using in further calculation.

Figure 82: Business indicator components

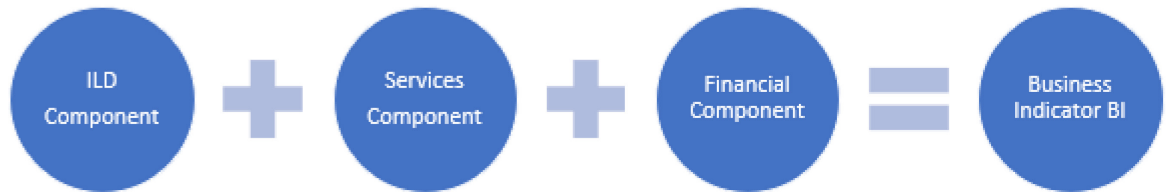

9.7.1.1.1 Calculation of Relevant Components

Interest, Leases and Dividend component:

$$ILDC = \text{Min} \left[\overline{\text{Abs}(\text{Interest Income} - \text{Interest Expense})}; 2.25\% \cdot \overline{\text{Interest Earning Assets}} \right] + \overline{\text{Dividend Income}}$$

NOTE:

In the formula above, a bar above a term indicates that it is calculated as the average over three years: t, t-1 and t-2.

The absolute value of net items (e.g., interest income – interest expense) should be calculated first year by year. Only after this year-by-year calculation should the average of the three years be calculated.

Services Component:

$$SC = \text{Max} \left[\overline{\text{Other Operating Income}}; \overline{\text{Other Operating Expense}} \right] + \text{Max} \left[\overline{\text{Fee Income}}; \overline{\text{Fee Expense}} \right]$$

NOTE:

In the formula above, a bar above a term indicates that it is calculated as the average over three years: t, t-1 and t-2.

Financial Component:

$$FC = \overline{\text{Abs}(\text{Net P \& L Trading Book})} + \overline{\text{Abs}(\text{Net P \& L Banking Book})}$$

NOTE:

In the formula above, a bar above a term indicates that it is calculated as the average over three years: t, t-1 and t-2.

The absolute value of net items (e.g., interest income – interest expense) should be calculated first year by year. Only after this year-by-year calculation should the average of the three years be calculated.

The Business Indicator respective components like the Net values for the 3 years are calculated and stored in the FSI_CAP_OR_NET_BI_COMPONENTS table. Banks would have obtained certain regulatory approvals as per the revised standardized approach to exclude some of the business components from the calculation of BI value. Business values from their Divested Entities or the business values from the Mergers and Acquisitions. Based on the regulatory approval and the application allow the banks to exclude or include these business values from the calculation.

In the above table FSI_CAP_OR_NET_BI_COMPONENTS, the Net values calculated are stored under Net values along with the V_BI_COMPONENT_IDENTIFIER to identify them , similarly the divested values and the mergers and acquisitions values are identified under DIV and MA respectively. Before calculating the business values, the same are identified under the GROSS business identifier.

9.7.1.2 The Business Indicator Component

To calculate the BIC, the BI is multiplied by the marginal coefficients (αi). The marginal coefficients increase with the size of the BI as shown in below table.

For banks in the first bucket (i.e. with a BI less than or equal to €1bn) the BIC is equal to BI x 12%. The marginal increase in the BIC resulting from a one unit increase in the BI is 12% in bucket 1, 15% in bucket 2 and 18% in bucket 3.

For example, given a BI = €35bn, the BIC = (1 x 12%) + (30-1) x 15% + (35-30) x 18% = €5.37bn.

BI Ranges and marginal coefficients

Table 83: BI Ranges and coefficients

Bucket	BI Range (in Euro Bn)	BI Marginal Coefficients (αi)
1	<= 1 Bn	12%
2	1 Bn < BI <= 30 Bn	15%
3	> 30 Bn	18%

These calculations are done in the FSI_CAP_OR_CAPITAL_SUMMARY table.

9.7.2 Internal Loss Multiplier

The ILM is defined as

$$ILM = Ln \left(\exp(1) - 1 + \left(\frac{LC}{BIC} \right)^{0.8} \right)$$

The Loss Component (LC) is equal to 15 times average annual operational risk losses incurred over the previous 10 years.

NOTE:

The loss data to be there for 10 years of high-quality data and in case of unavailability of the data for 10 years based on 5 years of data the LC can be calculated and banks do not have 5 years of data then the calculation of capital requirement will be based on BIC solely with supervisory approval.

$LC = 15 * \text{average of previous 10 years (Annual operational risk loss)}$.

For Loss Component calculation, based on regulatory definition option the bank can choose either Internal Loss , External Loss or both for their Calculation based on the regulatory approvals they have. Similarly, number of quality loss data considered for their loss calculation also selected through Regulatory definition.

If the Bank is not having the quality loss data as recommended by the regulatory then they have the option for selecting the Internal Loss Multiplier directly based on the approval and the multiplier suggested by the regulator.

Also, if the bank have taken regulatory approval in the Threshold of the loss data consideration for their Bank and accordingly they can select the Eur 20000 or the Eur 100000.

These calculations are done in the FSI_CAP_OR_CAPITAL_SUMMARY table.

Once the BIC and ILM are calculated then the Minimum Operation Risk Capital is calculated, post this the Risk Weighted Asset calculation is done by multiplying the 12.5 times of the Minimum operational Risk Capital.

The Flow chart for the Operational Risk based on the standardized approach calculation handled in the application is as follows.

Figure 84: Flow chart for Operational Risk

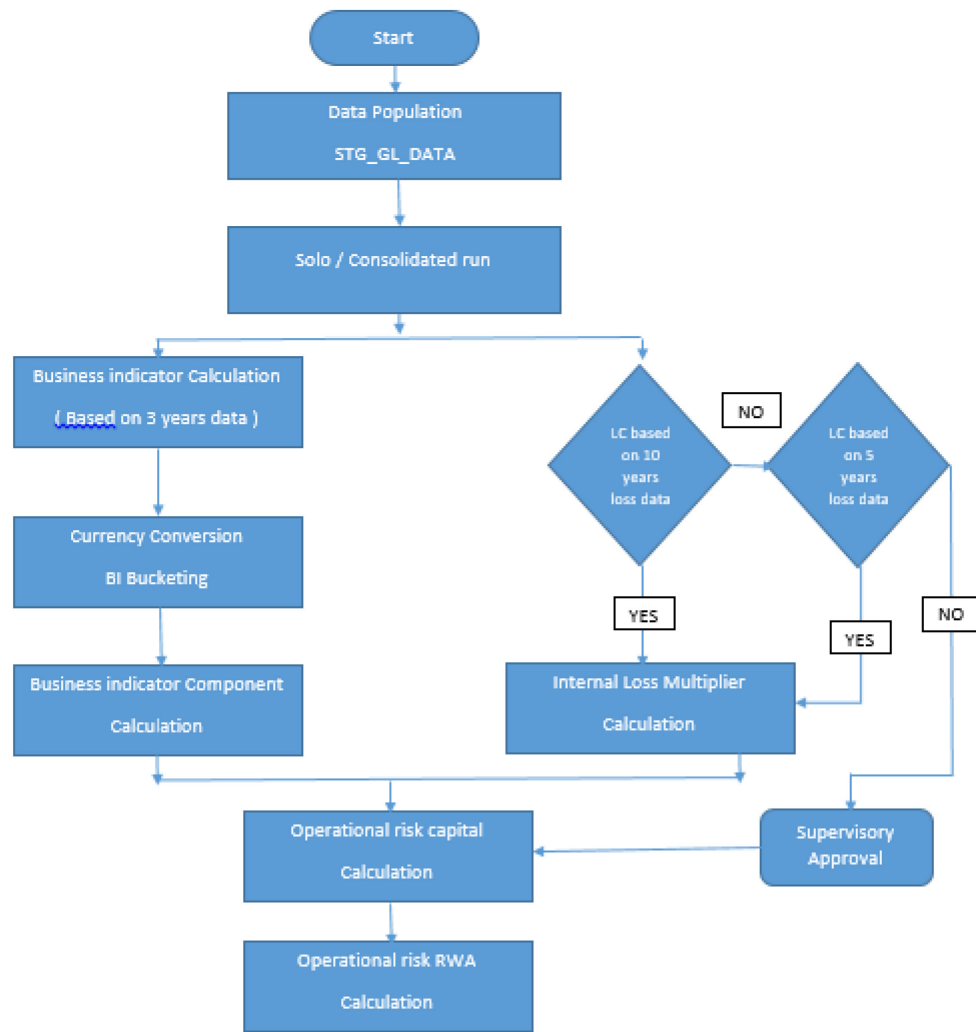

9.8 Capital Structure

During the economic crisis, the global banking system had an insufficient level of high-level quality capital. During the crisis, it was identified that there was inconsistency in the definition of capital across jurisdictions and a lack of disclosure. To address this issue of inconsistency, the Basel committee has prescribed a new definition of capital to strengthen the global capital framework under Basel III.

Figure 85: Process Flow for Capital Structure

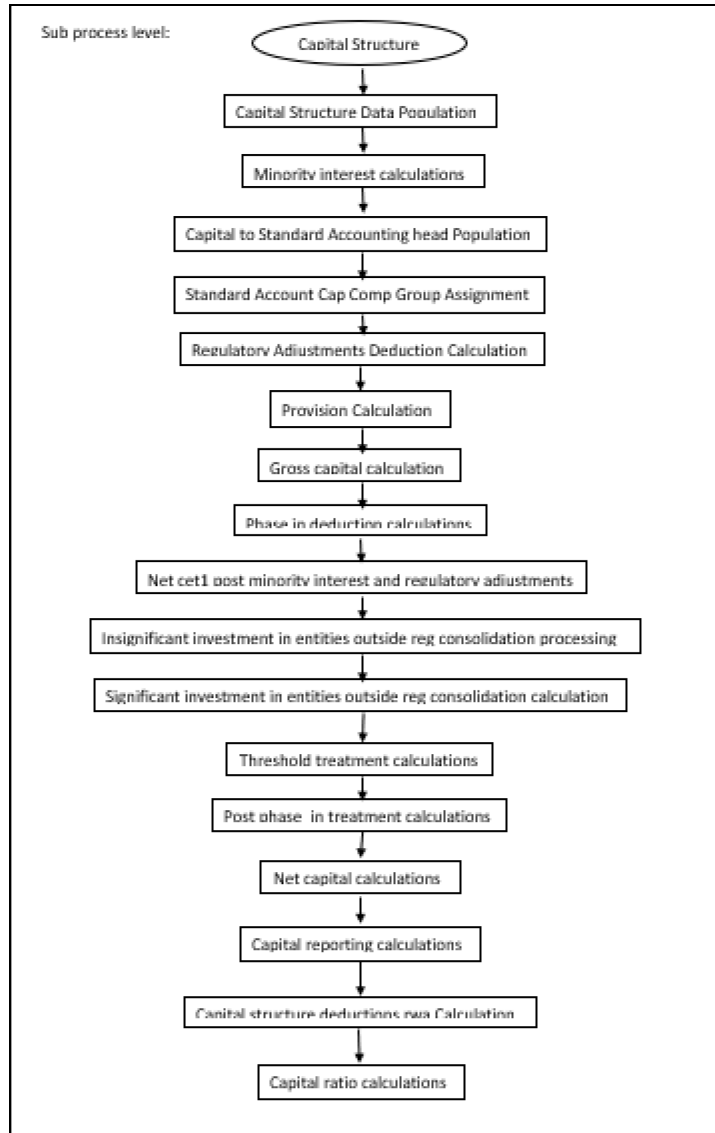

As per the new definition in the Basel III accord, total capital consists of the sum of the following elements:

- Tier1 Capital, which comprises of the following components,
 - Common Equity Tier 1
 - Additional Tier 1
- Tier 2 Capital

Each component of capital is subject to restrictions where CET1 must be at least 4.5% of the total risk-weighted asset. Tier 1 capital must be at least 6.0% of total risk-weighted asset. The total capital must be 8.0% of total risk-weighted asset. Each component of capital undergoes minority interest and regulatory adjustments. The minority interest is applicable for a consolidated entity only, during the consolidation run. Most of the regulatory adjustment line items are to be deducted from CET1.

All the regulatory adjustment line items follow a phase-in arrangement from the beginning of 2014 till 2017.

In particular, the regulatory adjustments begin at 20% of the required adjustments to Common Equity Tier 1 on 1 January 2014, 40% on 1 January 2015, 60% on 1 January 2016, 80% on 1 January 2017, and reach 100% on 1 January 2018. The same transition approach applies for all deductions from additional Tier 1 and Tier 2 capital.

While executing Solo Run the parent entity data is processed. Investment into the subsidiary data is processed as per Credit Risk and Market Risk rule. Capital line item for parent entity is only processed.

While executing Consolidation Run, the parent entity and the subsidiary data is considered.

9.8.1 Assumption

Investments in accounting entities (which are outside the scope of regulatory consolidation) by parent banks are long-term investments and mostly equity-related instruments, hence these investments are not processed for Credit Risk Mitigation.

The GL codes are expected to be unique across entities in Stage General Ledger Data (STG_GL_DATA) and Capital Accounting Head Dimension (DIM_CAPITAL_ACCT_HEAD).

9.8.2 Data Population

Exposure level input for capital structure will flow from different stage portfolio tables.

Along with the portfolio level stage tables, application uses these below table,

Stage GL DATA (STG_GL_DATA), Stage GI master (STG_GL_MASTER), Stage Party Share Holding Percentage (STG_PARTY_SHR_HLD_PERCENT), Stage Entity Share Holding Percentage (STG_ENTITY_SHR_HLD_PERCENT), Dim Organization Structure (DIM_ORG_STRUCTURE), Stage Standard Accounting Head (STG_STANDARD_ACCT_HEAD), Stage Legal Entity Details (STG_LEGAL_ENTITY_DETAILS), FSI_SETUP_CAPITAL_SOURCE (In this table application stores the CAPID details for example the capital component group or if it is eligible for transition), FSI_SETUP_CAPITAL_HEAD (In this table application stores all the seeded ratios as per regulatory guidelines).

9.8.3 Shareholding Percent Multiplication

Based on the share-holding percentage of the parent bank in the subsidiary and the consolidation approach to be followed for each of the entity, the Basel approach is selected.

For example: if the shareholding for an entity is 35% and is part of the consolidation process, then the approach selected for this entity is pro-rata consolidation. The reclassification is performed in task – 'Basel III Capital Consolidation Basel Approach Type Reclassification for an Entity' in the process '**CAPITAL_CONSOLIDATION AND PARAMETER ASSIGNMENT**'.

The entity-level population is part of BIS Common Data Processing (PMFCOM020) process. The application updates the shareholding percentage against each entity common data in the fact capital accounting head from the fact entity shareholding percent table and update the capital accounting head amount multiplying with the shareholding percentage of that particular entity. The parent data in the processing table of fact capital accounting head is updated with the value 1 and for each child entity, the

data is based on the parent's holding percentage specified for each child in fact entity shareholding percent table.

9.8.4 Common Reclassification Rules

There are certain reclassifications that are specific to the capital structure process – standard accounting head reclassification, and entity type reclassification.

1. Capital to Standard Accounting Head Reclassification

This is the reclassification of the Capital accounting head to standard accounting head. In this, all the Capital accounting heads of the bank need to be reclassified into the Standard Accounting Head, as that is the one which is being consumed in the application. This happens in the COMMON_RECLASSIFICATION (PMFCOM005) sub-process process in Common Data Processing (PMFCOM006).

2. Entity Type Reclassification

The entity type reclassification is also handled as part of the Party Type reclassification since there cannot be a difference in the party type and entity type.

This happens in the BIS Other Reclassification (PMFCOM010) process.

3. Product to Capital Component Group Reclassification

This reclassification of the product to the capital component group is based on the Basel Product type, and this is handled at the individual portfolio tables of Investments and Derivatives. For investments, this happens in the process INV_CAPITAL_STRUCTURE_RECLASSIFICATION_STD (PMFINV005) and for derivatives, this happens in the DRV_RECLASSIFICATION_STD (PMFDRV012) in the process.

9.8.5 Gross Capital Calculations

For Gross Capital calculation all the components are classified into their respective tiers (CET1, AT1, and T2) based on the standard accounting head, and the specifications as mentioned by the regulator. The total gross capital for each tier of capital (CET1, AT1, and T2) is calculated as per the definition of CET1, AT1, and T2 by adding the relevant financial instrument in each tier of capital. This is processed using GROSS_CAPITAL_CALCULATIONS (PMFBISCS006) sub-processes in Capital Structure Data Processing (PMFBISCS021) process.

9.8.6 Minority Interest Calculations

Surplus of Minority Interest

Minority Interests are calculated and the surplus amount in each tier of capital, which is attributed to third parties, is deducted from the gross capital of each tier of capital.

Minority interest is the amount that is attributable to any other party, which is not part of the bank's entities and has a shareholding in the entity. The surplus of minority interest is calculated as the third party's interest (shareholding percent) in the surplus capital (available capital – minimum required capital).

- All the values required for processing are populated into Minority Interest Capital (FSI_MINORITY_INTEREST) table which is the processing table for minority interest calculations.

- The sub-process – MINORITY_INTEREST_CALCULATIONS (PMFBISCS001) in Capital Structure Data Processing (PMFBISCS021) process covers this processing.
- The minority interest is deducted from the gross capital of each tier of the capital.

9.8.7 Internal Transactions Deduction

The deduction also includes internal transactions in each tier of capital among the various entities which are part of the regulatory consolidation. This is to ensure that there is no double-counting of exposures. This is handled in the process CAPITAL_STANDARD_ACCOUNTING_POPULATION (PMFBISCS002).

9.8.8 Regulatory Adjustments & Deductions from Each Tier of Capital

All the regulatory adjustment line items are expected as a download in the Stage General Ledger Data table (STG_GL_DATA). Some of these line items are Goodwill, Other Intangibles, Deferred Tax Assets, Cash flow hedge reserve, and so on. The related deferred tax liabilities are also expected to be provided as a download. The application calculates the values net of DTL and then processes it for the Regulatory Adjustments. The detailed list of these line items is part of the FSI Setup Capital Source (FSI_SETUP_CAPITAL_SOURCE) table.

The sub-process – REGULATORY_ADJUSTMENTS_DEDUCTION_CALCULATION (PMFBISCS004) and PROVISION_CALCULATION (PMFBISCS005) in Capital Structure Data Processing (PMFBISCS021) process handle this requirement.

9.8.9 Certain Deductions part of Corresponding Deduction Approach

There are certain deductions which are expected to be part of each of the tier of capital. And they follow the corresponding deduction approach, wherein the deduction of the line item happens in the same tier of capital to which the exposure belongs. This is being mostly pulled from the relevant

9.8.9.1 Investment in Own Shares

The investment in own shares is calculated as the sum of the pre-mitigation EAD (EAD Pre-mitigation Measure Value (**N_EAD_PRE_MITIGATION**)). The source for investment in own share is the individual portfolio table.

The source for non-Sec exposures is FSI Cap Investment Exposures (FSI_CAP_INVESTMENT_EXPOSURES), and FSI Cap Derivative Exposures (FSI_CAP_DERIVATIVES). The process where this is being handled is Capital Structure Data Processing (PMFBISCS021).

This populates into the Fact Calc accounting head (fct_calc_acct_head). This is being populated for each of the respective tier of capital.

The Investment in own shares is being calculated in the task INV_DRV_DEDUCTION_CALC_ACCT_HEAD_DATA_POP in Capital Structure Data Population (PMFBISCS019) process.

This also goes for a phase in calculations, which is being handled in the PHASE_IN_DEDUCTION_CALCULATIONS (PMFBISCS007) process.

9.8.9.2 Reciprocal Cross-holdings

The Investment in reciprocal cross-holdings are calculated as the sum of the pre-mitigation EAD (EAD Pre-mitigation Measure Value) (N_EAD_PRE_MITIGATION) in FSI Cap Investment Exposures (FSI_CAP_INVESTMENT_EXPOSURES), and FSI Cap Derivative Exposures (FSI_CAP_DERIVATIVE) of the exposures which have the flag of reciprocal cross-holding indicator (F_RECIPROCAL_CROSS_HLDG_IND) as "Y".

For this processing, the reciprocal amount is expected as a download in the Stage Capital Investments Position Table (STG_CAP_INVESTMENTS_POSITIONS) at an instrument level. The instrument code provided in this table is the instrument in which the reporting bank has invested, and for which there is a reciprocal crossholding by the reporting bank. The reciprocal cross-holding amount is also captured in this table. The application expects the staging data of the exposures to have the reciprocal cross-holding indicator (F_RECIPROCAL_CROSS_HLDG_IND) as "Y".

The application uses this INV_DRV_DEDUCTION_CALC_ACCT_HEAD_DATA_POP task in the Capital Structure Data Population (PMFBISCS019) process to populate into the Fact Calc accounting head (FCT_CALC_ACCT_HEAD). This is being populated for each of the respective tier of capital.

This also goes for phase in calculations which is being handled in the PHASE_IN_DEDUCTION_CALCULATIONS (PMFBISCS007) process.

And finally, the adjusted amount after deductions goes back to the exposure level,

which is being handled in CAPITAL_STRUCTURE_DEDUCTIONS_RWA_EXPOSURES (PMFBISCS022) from the process Capital Structure Data Processing (PMFBISCS021).

The exposure that meets the reciprocal cross-holding amount is stamped with the reciprocal cross-holding indicator (F_RECIPROCAL_CROSS_HLDG_IND) as 'Y'. This will be reduced in all the amount columns in FSI Cap Investment Exposures (FSI_CAP_INVESTMENT_EXPOSURES), and FSI Cap Derivative Exposures (FSI_CAP_DERIVATIVES) as per the reciprocal cross-holding ratio and store the actual amounts in FSI CAP DEDUCTION EXPOSURE table (FSI_CAP_DEDUCTION_EXPOSURES).

The portion of the exposure, which is above the reciprocal cross-holding amount is treated as a regular exposure and is risk-weighted as per the Basel asset class for that instrument.

9.8.9.3 Insignificant Investment

Investment in all financial entities, which are outside the scope of regulatory consolidation, is identified as significant and insignificant investments.

The shareholding percent for these parties are expected as a download in Stage Party Shareholding Percent table (**STG_PARTY_SHR_HLD_PERCENT**). Any party that is a part of the Org Structure but is not part of the regulatory consolidation, can also qualify for this treatment if it is a financial entity. If the entity is part of the Org structure, the shareholding percent is expected in the Stage Entity Shareholding percent table (**STG_ENTITY_SHR_HLD_PERCENT**).

The parties are identified as significant when the shareholding percentage is greater than or equal to 10%. And the others are identified as an insignificant investment. This processing happens in the **PARTY_SHAREHOLDING_PERCENT** process.

The total investment amount in insignificant entities is computed by summing up the Pre-mitigation EAD (EAD Pre-mitigation Measure Value (N_EAD_PRE_MITIGATION)) from the portfolio tables FSI Cap Investment Exposures (FSI_CAP_INVESTMENT_EXPOSURES), and FSI Cap Derivative Exposures (FSI_CAP_DERIVATIVES). And also, the tier-wise computation of investment amount happens. The total

amount is compared with the 10% of the CET1 amount of the parent bank amount post regulatory adjustments. The amount above the 10% limit is processed for deduction.

This summing up includes the direct, indirect, and synthetic investments. Indirect investments are investments in Investment funds, and which are invested in capital instruments. Synthetic investments are those investments in synthetic transactions on capital instruments. For all these exposures, the net long position amount that is updated in **N_EAD_PRE_MITIGATION** is considered.

This is expected for all capital positions, and not for specific capital positions.

The total deduction amount is pro-rated among each tier of capital based on the percentage of investment in each tier of capital. The amount arrived is deducted from each tier of Capital.

The investment amount below the 10% limit is treated as per the banking book rule for the instrument.

The application computes as follows:

Parties are marked as insignificant investment parties by updating the flag: Significant Entity Indicator (**F_SIGNIFICANT_INVESTMENT_IND**) in Fact Party Shareholding Percent (**FCT_PARTY_SHR_HLD_PCT**) with value N, and **F_SIGNIFICANT_INVESTMENT_IND** in Fact Entity Info (**FCT_ENTITY_INFO**) with value N.

- The exposure amount of banking book and trading book exposures (any counterparty credit risk exposures) to these entities are summed by grouping their component of capital and compared against 10% of the parent bank's CET1 capital. The portion of the amount that exceeds the 10% limit is deducted.
- This is computed by calculating tier-wise deduction percentage and multiplying this percentage with the exposure amount to arrive at the amount to be deducted from each tier of capital.
- The total investment values are populated into the Non-Regulatory Consolidation Entity Investment (**FSI_NON_REG_CONSL_ENTITY_INVST**) table which is the processing table for insignificant and significant investment deductions.
- The sub process – **INSIGNIFICANT_INVESTMENT_IN_ENTITIES_OUTSIDE_REG_CONSOLIDATION_PROCESSING** (PMFBISCS010) in Capital Structure Data Processing (PMFBISCS021) covers the processing.
- After the application of this treatment, the Insignificant Investments line item also follows phase-in arrangement which is similar to the phase-in arrangement for Regulatory Adjustments.

9.8.9.4 Significant Investment

The total investment amount is checked against the set limit of 10% of the CET1 amount of the parent bank, post insignificant investment amount adjustment. The CET1 amount above 10% is deducted from the CET1 post insignificant investment amount deduction. The CET1 amount below 10% follows the threshold deduction. The investment amount in AT1 and T2 is fully deducted from its respective AT1 and T2 tier of capital. The application computes as follows:

Entities are marked as significant investment entities by updating the flag – Significant Entity Indicator (**F_SIGNIFICANT_INVESTMENT_IND**) in Fact Party Shareholding Percent (**FCT_PARTY_SHR_HLD_PCT**) with value Y and Significant Entity Indicator (**F_SIGNIFICANT_INVESTMENT_IND**) in Fact Entity Information (**FCT_ENTITY_INFO**) with value 'Y'.

The exposure amount of banking book and trading book exposures (any counterparty credit risk exposures) to these entities are summed by grouping their component of capital and compared against

10% of the parent bank's CET1 capital. The portion of the amount that exceeds the 10% limit is deducted from CET1. The exposures of AT1 and T2 are fully deducted from the respective tier of the capital. This is performed by calculating the deduction percentage for CET1 and by multiplying this percentage with the CET1 exposure's exposure amount to arrive at the amount to be deducted from CET1 capital.

The sub process –

SIGNIFICANT_INVESTMENT_IN_ENTITIES_OUTSIDE_REG_CONSOLIDATION_PROCESSING (PMFBISCS011) in Capital Structure Data Processing (PMFBISCS021) covers the processing.

After the application of this treatment, the Significant Investments line item also follows phase-in arrangement which is similar to the phase-in arrangement for Regulatory Adjustments.

9.8.10 Threshold Deduction Treatment

Threshold Deduction is populated in the **FSI_THRESHOLD_TREATMENT** table and the threshold calculations are processed in this table.

The line items, (Significant and insignificant Investment in the Common Shares of Accounting entities are populated from the FSI NON REGULATORY CONSOL ENTITY INVESTMENT table (FSI_NON_REG_CONSL_ENTITY_INVST), Mortgage Servicing Rights net of Deferred Tax Liabilities are populated from the Fact Standard Accounting head (FCT_STANDARD_ACCT_HEAD) table, and DTAs that arises from temporary differences are populated from the Fact Capital Accounting Head (FCT_CAPITAL_ACCT_HEAD).

The three-line items' significant investment in the common shares of BFSI where the bank owns more than 10%, Mortgage Servicing Rights (MSR), and DTAs that arises from temporary differences is processed for threshold deduction are populated in the Capital Threshold Treatment (**FSI_THRESHOLD_TREATMENT**) table and the threshold calculations are processed in this table. These three-line items are individually compared with the 10% of CET1 calculated Post Regulatory Adjustments, Insignificant Investments, and Significant Investment. The amounts which are above 10% CET1 limit are deducted from CET1 following the phase-in arrangements. During the transition period, any amount of these three-line items, which is not deducted as per the 10% mentioned earlier, is summed up for the aggregate 15% limit check. During the transition period, the check of 15% is against the CET1 post all regulatory adjustments and adjustments to insignificant investments and significant investments and the individual threshold deduction. In the post-transition period, instead of 15%, the aggregate check is 17.65% of CET1, post all regulatory adjustments and adjustments to insignificant investments, less 100% of the sum of the line items which goes for threshold deduction.

The amount which is not deducted due to this 10% and 15% check is risk-weighted 250% during the transition period and is risk-weighted 250% post the transition period. The entire processing is done in the sub-process – 'THRESHOLD_TREATMENT_CALCULATIONS (PMFBISCS012) in Capital Structure Data Processing (PMFBISCS021).

9.8.11 Net Capital Calculations

The net CET1, net AT1, and net T2 capital amount are calculated post all regulatory adjustments. Any shortfall in T2 capital amount is adjusted against Net AT1 amount and any shortfall of AT1 capital amount is adjusted against Net CET1 amount.

This is performed in the sub-process – NET_CAPITAL_CALCULATIONS (PMFBISCS014) in Capital Structure Data Processing (PMFBISCS023)

For RWA, RWA_POPULATIONS (PMFBISCS016) in Capital Structure Data Processing (PMFBISCS023).

For net capital, it is NET_CAPITAL_CALCULATIONS (PMFBISCS014) in Capital Structure Data Processing (PMFBISCS023).

9.8.11.1 Total RWA Calculations

The RWA amount for Credit Risk - Non-Securitization, Counterparty Credit Risk, Credit Valuation Adjustment Risk-Weighted Asset, Credit Risk - Securitization, Market Risk, and Operational Risk and Regulatory Capital Phase in Related RWA are calculated by summing up the RWA amount.

The Phase-In RWA captures the capital instrument investments that go for deduction from Capital but because of Phase-In arrangement are to be risk-weighted such as – Reciprocal Cross-holding, Treasury Stock, Insignificant Investment amount, Significant Investment amount, and Threshold deduction amount.

These are reported under different Capital accounting heads such as ‘Risk-weighted Asset amount for Standardized Portfolios/IRB portfolio’ for Non-Securitization, “Sec Std RWA” for Securitization portfolio, “Market RWA” for Market Risk and “Operational RWA” for Operational Risk.

This is part of the RWA_POPULATIONS (PMFBISCS016) in Capital Structure Data Processing (PMFBISCS023).

9.8.11.2 Capital Ratio Calculations

Tier 1 capital ratio and capital adequacy ratio are calculated using the total RWA amount, net Tier 1 capital, and Total capital amount.

For capital ratio, the process is CAPITAL_RATIO_CALCULATIONS (PMFBISCS017) in Capital Structure Data Processing (PMFBISCS023).

9.8.11.3 Required Capital ratio

This process is handled in CAPITAL_RATIO_CALCULATIONS (PMFBISCS017).

In this, the application calculates the CET1 capital ratio, T1 capital ratio, T2 capital ratio, and a total capital ratio summing all of them. This is compared with the required capital ratio provided as an input for the specific regulator. The required capital ratio is being provided as an input in the FSI Setup Capital Accounting Head (FSI_SETUP_CAPITAL_HEAD).

9.8.11.4 Deficit or Excess Capital

The shortfall is handled in the sub-process Net capital calculations (PMFBISCS014),

Here the application calculates CET1, AT1, and T2 capital shortfall amounts.

9.8.11.5 Key Data Elements

Key data elements to process the Capital Structure for the consolidated entity is as follows. For a complete list of tables and columns to be updated, see the Download Specifications document.

Entity details are part of regulatory consolidation and parent entity shareholding percent. This data is captured in Stage Entity Shareholding Details (STG_ENTITY_SHR_HLD_PERCENT) table.

The capital structure component for each tier of capital for all entities involved in regulatory consolidation.

The total RWA, total CET1, AT1, and T2 amount, and third-party percentage of holdings in each tier of capital for minority interest calculation.

The regulatory adjustment amount like goodwill, DTA, other intangible assets, cash flow hedge reserve, and defined pension fund asset, MSR, and so on.

The transaction of the investment amount for an accounting entity that is outside the scope of regulatory consolidation.

The CET1, AT1, and T2 capital of the entity which has third-party minority holdings in it are expected as a download in the legal entity details (STG_LEGAL_ENTITY_DETAILS) table. Similarly, the third-party investment in each tier of capital is also expected as a download in the legal entity details table.

The minimum required capital for each tier for each capital adequacy regulator (for the entity that has a third-party minority holding in it) is expected in the setup table - Setup Capital Heads (FSI_SETUP_CAPITAL_HEAD).

The Total RWA (CAP838) for the entity that has a third-party minority holding in it is a download value in Stage Standard Accounting Head (STG_STANDARD_ACCT_HEAD).

9.9 Capital Buffers

Capital Buffer is calculated after the calculation of Capital Ratios, as they go as an input to Buffer calculation. Each sub-process is explained in detail under the Capital Buffer section of the user guide.

For example, the Required Capital Conservation Buffer and Required Countercyclical Buffer calculation are detailed in the 'Required Total Buffer' sub-section of the Capital Buffer section in this document. Similarly, the Minimum Capital Conservation ratio is detailed in the 'Capital Conservation Ratio' sub-section of the Capital Buffer section in this document.

Figure 86: Process Flow for Capital Buffers

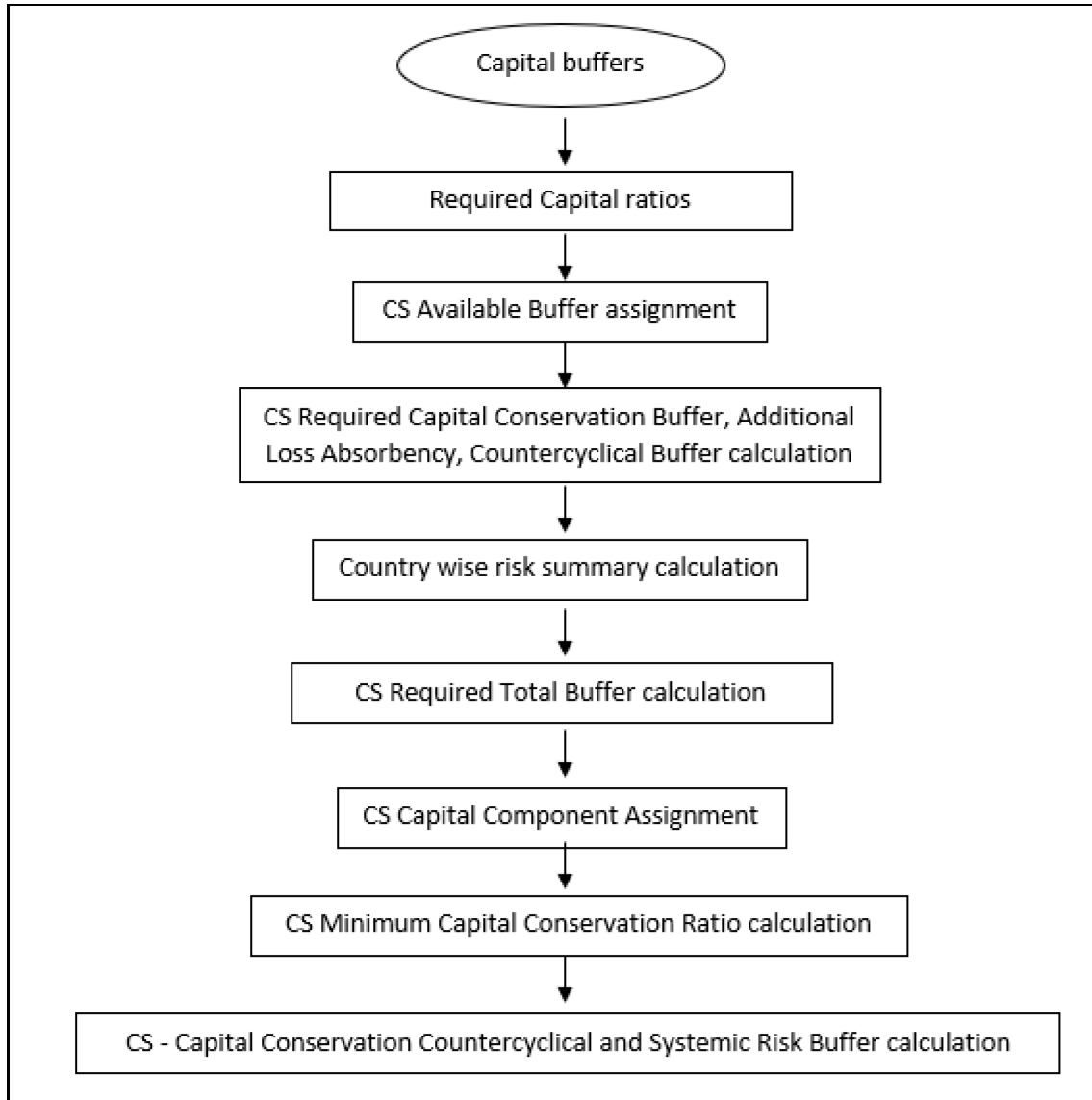

9.9.1 Data Population

The major input for capital buffers is the total capital ratio and the Net Common Equity Tier 1 Capital Ratio s which gets computed as part of the capital structure process. This is consumed from the fact standard accounting head.

Along with that, the application consumes additional data related to buffers from the Stage Countrywide Risk Summary (STG_COUNTRYWISE_RISK_SUMMARY) which is used to populate country-wise risk summary.

FSI Benchmark Capital Conservation Ratio (FSI_BENCHMARK_CAP_CONS_RATIO) and FSI Benchmark Countercyclical Buffer (FSI_BENCHMARK_CNTR_CYC_BUFFER).

9.9.2 Buffer Requirements

There are different types of Capital that the banks are expected to maintain:

- Capital Conservation Buffer
- Countercyclical Buffer
- Additional Loss Absorbency Capital (for G-SIB)

A detailed description of each of these buffers is provided in the following sections.

9.9.2.1 Capital Conservation buffer

As part of the Basel III compliance, requires banks are required to maintain Capital Conservation Buffer (CCB) out of Common Equity Tier 1 Capital (CET1).

This buffer is used to ensure that any loss should not erode the bank's capital, and hence it is expected to be met over and above the Required CET1 Capital. The actual required ratio for the jurisdiction is being specified in the FSI Setup Capital Head (FSI_SETUP_CAPITAL_HEAD).

9.9.2.2 Countercyclical Buffer

As part of the Basel III compliance, banks are required to maintain a Countercyclical Buffer that is prescribed by the respective jurisdiction's regulator through an extension of the Capital Conservation buffer.

The application calculates the buffer requirement for internationally active banks as the weighted average of the buffers required across all the jurisdictions to which the bank has exposures, weighted on basis of the exposure amount to different countries of the counterparty of their exposures.

If the guarantor and credit default swap is present for exposure, then the application considers the domicile country of these mitigants for the covered portion and the country of the exposure counterparty for the uncovered portion. After calculating the weighted average, the application then computes a single value for the Countercyclical Buffer benchmark which is applicable on all exposures of all jurisdictions.

9.9.2.3 Additional Loss Absorbency Buffer (GSIB Buffer)

If a banking organization is categorized as a Globally–Systematically Important Banks (G-SIB), then the application identifies all subsidiaries in various jurisdictions as G-SIB as well. Based on this assessment, banks are assigned a GSIB score and the applicable bucket is decided. Identification of this bucket is based on the score as per the guidelines. Loss absorbency is required to be met as an extension of Capital Conservation and Countercyclical for a computational buffer for computational purposes.

9.9.3 Required Buffers

Required Total Buffer (CAP825) is the sum of the three required buffers: (CAP829) Required Buffer from CET1 Capital, (CAP830) Required Buffer from Tier 1 Capital, (CAP831) Required Buffer from Capital Adequacy Ratio.

The calculated values (only positive values are considered) are stored against the corresponding Cap IDs as two separate line items of which one is 0.

The Required buffers as a percentage are provided as a download in the FSI Setup Capital Account Head (FSI_SETUP_CAPITAL_HEAD), as per the specific regulatory need. This is being multiplied by the Total RWA to arrive at the Required Buffer as an amount.

9.9.4 Assumptions

Countercyclical Buffer requirement for each country must be provided by the client or the bank as the final percentage applicable for each country and this is dependent on the home regulator. G-SIB status and applicable bucket information for each entity must also be provided by the client/bank.

For Required Weighted Average Countercyclical Buffer calculation, the exposures used in the bank are all accounts exposed to credit risk (Securitized and Non-Securitized) and those exposed to Market Risk. However, the application can be restructured to consider only those exposed to Credit Risk.

In Capital Conservation Ratio, for the computation of the quartiles that are used to arrive at Minimum Capital Conservation Ratio, the application is dependent on the required CCB ratio. From 2013 till 2016, CCB requirements keep changing every year as per the transitional arrangement to calculate the quartiles range, the application considers it as per the transitional arrangement. At the same time, the application has the flexibility to have the required CCB constant at 2.5% throughout. Also, the minimum required CET1 Ratio considered for building these quartiles is 4.5%

9.9.5 Key Data Elements

Key data elements are elaborated in this section. For a complete list of tables to be updated, see the Download Specifications document.

Countercyclical Buffer requirements for each country must be provided by the client or the bank as the percentage applicable for each country is dependent on the home regulator's jurisdiction. The home regulator's jurisdiction can prescribe a Countercyclical Buffer percentage that is higher than the percentage prescribed by the regulator of exposure country. Hence, the required Countercyclical Buffer percentage for each exposure country provided as input must be the one that the home regulator agrees to.

G-SIB status and applicable bucket information for each entity must be provided by the client or the bank. In the case of a consolidated Run, loss absorbency charges applicable to the parent, as required by the regulator of the parent applies to the complete Run. This Run output is supposed to be reported to the jurisdictional regulator of the parent. For a Solo Run, loss absorbency charges as required by the regulator for a subsidiary entity are applicable. Hence, for Solo and Consolidated Runs, the G-SIB status of the reporting bank, and the applicable bucket, is provided by the bank itself.

As the required Capital Conservation Buffer (CCB) must be met as per the transitional arrangement, therefore the required buffer value must be set up in Setup Capital Heads (**FSI_SETUP_CAPITAL_HEAD**) table for different periods against the standard account head ID CAP823. Different CCB requirements specified by the different regulators can be set up by specifying the regulator codes against the same standard account head ID. This regulator code must be the same as the jurisdiction code assigned by the Rule Jurisdiction Code Assignment.

The required benchmark of Countercyclical Buffer for different countries as set by different regulators is expected as a download in Stage Benchmark Counter-Cyclical Buffer (**STG_BENCHMARK_CNTR_CYC_BUFFER**). This data is populated to Benchmark Counter-Cyclical Buffer Ratio (**FSI_BENCHMARK_CNTR_CYC_BUFFER**) using a Slowly Changing Dimension (SCD) process. Buffer requirement given on a date is valid till the next buffer is specified. For a solo Run, the regulator of

subsidiary specified buffer requirements are considered and for a consolidation Run, the consolidating entity's regulator specified buffer requirements are considered.

The Additional Loss Absorbency requirement specified by different regulators for different buckets must be set up in the table Benchmark Loss Absorbency Ratio (**FSI_SETUP_BENCHMARK_LOSS_ABS**). For the solo Run, the loss absorbency requirement set by the local regulator is considered. For consolidation Run, the consolidating entity's regulator specified loss absorbency requirement is considered.

There is an option to directly input the applicable loss absorbency percentage. This is also useful when the percentage applied is different from the corresponding bucket percentage. This must be provided in the column **N_LOSS_ABS_OVERRIDE** of the table Stage Legal Entity Details (**STG_LEGAL_ENTITY_DETAILS**). If this column has a value, it is given priority over the loss absorbency percentage corresponding to the bucket.

The minimum Capital Conservation Ratios requirement for different quartiles (1, 0.8, 0.6, 0.4, 0) is expected as a download in Stage Benchmark Capital Conservation Ratio (**STG_BENCHMARK_CAP_CONS_RATIO**). This data is populated to the semi-static table Benchmark Capital Conservation Ratio (**FSI_BENCHMARK_CAP_CONS_RATIO**) using an SCD process. Conservation ratios specified once are valid till the next revision.

In the **FSI_REQUIRED_CNTR_CYC_BUFFER** table, the post-mitigation exposure amount is updated against each country code. This is applicable for Credit Risk (for Non-Securitization and Securitization exposures) and Market Risk.

9.10 Large Exposures

The large exposure framework is a framework detailing how the banks have to manage their exposures to various parties both at the individual level, as well as to the group of connected clients' level.

The large exposure framework has to comply with the bank at both a solo and consolidated level. As part of the solo execution, the bank has to identify its large exposures and comply with the required threshold limit.

As part of the consolidation execution, the bank has to identify the total large exposures at the consolidated level and comply with the required threshold limit.

The solo and consolidation are as per the regulatory definitions and same as the one which is being used for the regular capital adequacy.

The large exposures are identified based on the comparison of the total individual party's exposures to the Tier 1 Capital, which changes based on whether it is a solo execution or consolidation execution.

9.10.1 Data Population

The large exposure computations require data for the various portfolio such as banking, investment, derivatives, securities and financing transactions, and trading book exposures.

Non-Securitization Data Population

Data must be loaded in the application for all the product types and is the same as Capital Adequacy-related data expectation.

See the individual portfolio for the data elements:

- [Banking](#)
- [Investment](#)
- [Derivatives](#)
- [Securities Financing transactions](#)

Mitigant Data Population

The data relating to the mitigants associated with the exposures are captured in this process. This is also the same as the regular capital adequacy run-related data.

For more information about Mitigant Data Population, see [Mitigant Processing](#) section.

Securitization Data Population

Data must be loaded in the application for all the relevant Securitization tables and is the same as Capital Adequacy related data expectation.

For more information about the securitization data population, see [Securitization Data Population](#) section

Trading book Data Population

Data must be loaded in the application for all the trading book exposures and is the same as Capital Adequacy related data expectation.

For more details, please refer [Market Risk Data Population](#).

All these data are populated into the processing table of FSI_LARGE_EXPOSURE_ACCT_DETAIL.

Large exposure data population is handled in the sub-process LARGE_EXPOSURE_DATA_POPULATION

9.10.2 Reclassification

The reclassification rules are the same as the ones already detailed in the individual portfolio – [banking](#), [investment](#), [derivatives](#), [securities and financing transactions](#), [securitization](#), and [trading book exposures](#).

In addition to the above, the reclassification which is specific to large exposures is the one mentioned below.

9.10.2.1 Party Relationship reclassification

All the relationships at the party level are expected in the stage party–party relationship table (STG_PARTY_PARTY_RELATIONSHIP)

The Large Exposures computation require the details of the party's relationship to one another, since there is different limitation to the group exposure (which will be a group of connected counterparties based on various relationship types), and to individual counterparties (without considering any other related counterparties).

From a definition perspective, connected counterparties are individual entities that are considered as a group due to the direct or indirect control established between entities. This direct or indirect control is being identified based on the party-party relationship table, wherein every related party's information is provided, and the relationship type is also defined.

This is reclassified into the standard relationship type, to be used for further processing and reporting.

9.10.3 Computation of the Direct Exposures

The direct exposures are the actual exposures that are in the bank's portfolio in the form of banking, derivatives, and SFT exposures. In the case of an investment portfolio, the direct exposures are the ones that are an investment in the form of debt securities or equity, and which do not have any underlying dependencies. This is handled for individual counterparties.

This gets handled as part of the sub-process BIS_LARGE_EXPOSURE_EAD_ASSIGNMENT under the process LARGE_EXPOSURE_DATA_PROCESSING.

9.10.4 Computation of Indirect Exposures

The indirect exposures are the mitigants that have been provided to the exposures in the bank's portfolio in the form of banking, derivatives, investment and SFT exposures. This is handled for individual counterparties.

This gets handled as part of the sub-process BIS_LARGE_EXPOSURE_EAD_ASSIGNMENT under the process LARGE_EXPOSURE_DATA_PROCESSING.

9.10.5 Computation of Synthetic Exposures

The synthetic exposures are the ones for Securitization and CIU, wherein there are synthetic exposures to the underlying of these transactions.

In this scenario, these exposures are computed by assigning them to the unknown clients or the actual counterparty to whom the underlying belongs, depending on data availability.

This is handled for individual counterparties.

The computation of gross credit exposure for CIU/SPV is handled in the process LARGE_EXP_SPV_UNDERLYING_PROCESSING

9.10.6 Exempted Exposures

Certain exposures are being exempted from the large exposure calculations. These are mostly as specified by the regulator, and include the cleared transactions, and other exposures that are deducted from capital, since it does not make sense to consider them in the large exposure calculations.

This is handled for individual counterparties.

The computations for this are handled in the subprocess BIS_LARGE_EXPOSURE_EXEMPTIONS of the process LARGE_EXPOSURE_DATA_PROCESSING.

9.10.7 Calculation of Total Exposure to a counterparty

Calculation of gross credit exposure depends on the specific product category of the on-balance sheet, off-balance sheet exposure, derivative products, secured lending and borrowings, exposures arising from CIU, exposures arising from SPVs along with the exposures to third parties of the SPVs, and trade exposures. The calculation also covers indirect exposures of the counterparty arising out of the mitigant exposures of the bank.

This is applicable for all the counterparties for which the bank has exposures in the form of either direct, indirect, or synthetic exposures. This is handled in the sub-process

LARGE_EXPOSURE_COUNTERPARTY_POPULATION and
BIS_LARGE_EXPOSURE_COUNTERPARTY_PROCESSING in the process
LARGE_EXPOSURE_DATA_PROCESSING.

9.10.8 Identification of Related Parties

It is expected that the party ID is the one for which it is considered as a related party. For example, if Bank A is related to party B, and party B is related to party C, it is expected that the data is provided for Bank A to party B, and Bank A to party C, to ensure that every mapping is being considered.

The solution sums up the exposures for all the counterparties belonging to the same parent, along with the parent, and populates the FSI Large Exposure Account Detail Table
(FSI_LARGE_EXPOSURE_ACCT_DETAIL).

The expectation is that all the parties which are related to each other, have the Parent ID of the Party table as the same, or are part of the related party. Based on these related parties identified, and the parent id in the DIM_PARTY, the related parties are identified, and these are also considered as belonging to the same group.

This is handled in the sub-processes LARGE_EXP_PARTY_GROUP_MEMBER_MAPPING and
LARGE_EXP_PARTY_GROUP_EXP_POPULATION in the process LARGE_EXPOSURE_DATA_PROCESSING.

On the party group, the threshold limit check is applied, and large exposures are identified.

9.10.9 Calculation of Total Exposure to a group of related counterparties

All the total exposures of the parties will be clubbed together to calculate the total party group exposures. This will be based on the related parties identified. This is the total exposure based on which the large exposure identification happens, and the breach condition check happens.

This is handled in the sub-process BIS_PARTY_GROUP_LARGE_EXP_PROCESSING in the process
LARGE_EXPOSURE_DATA_PROCESSING.

9.10.10 Total Capital of the Bank

This is used to calculate the total capital of the bank. This is computed as per the [Capital Structure](#) related calculations.

This is handled in the sub-process LARGE_EXPOSURE_CAPITAL AMOUNTS_POPULATION in the process
LARGE_EXPOSURE_DATA_PROCESSING.

9.10.11 Identification of Large Exposure Counterparties

The large exposures are identified based on whether the group exposure of the counterparties exceeds the required threshold using the pre mitigation value.

This is handled in the sub-process BIS_PARTY_GROUP_LARGE_EXP_PROCESSING in the process LARGE_EXPOSURE_DATA_PROCESSING.

9.10.12 Threshold criteria for Large Exposure Counterparties

The regulator indicates the threshold criterion below which the large exposures can be maintained by the bank. This threshold percent is assigned based on the standard party type of the counterparty, as specified by the regulator.

This is handled in the sub-process Large Exposures Counterparty Threshold Amount Calculation in the process BIS_LARGE_EXPOSURE_COUNTERPARTY_PROCESSING.

9.10.13 Large Exposure Breach Calculations

The application identifies whether there has been any breach to the large exposure threshold as specified by the regulator and is stamped a flag indicating that the counterparty as a group has breached it.

This is handled in the sub-process Large Exposures Counterparty Threshold Limit Breach Indicator Assignment in the process BIS_LARGE_EXPOSURE_COUNTERPARTY_PROCESSING.

9.11 Leverage Ratio

During the financial crisis, banking institutions built up excessive on-balance sheet and off-balance sheet leverage which forced the banking sector to reduce its leverage. To prevent the building of excessive leverage on the institutions' balance sheet, the BIS has introduced a non-risk-based leverage ratio which is a new regulatory tool supplementing risk-based capital requirement. The leverage ratio guidelines were revised and published on 10th October 2014. The guidelines are mostly in sync with the revised leverage ratio guidelines issued in 2014 by BIS.

The solution supports this revised approach in the calculation. The application calculates the leverage ratio for a reporting bank. The minimum required leverage ratio is 3%.

The leverage ratio is calculated by dividing an institution's Tier 1 capital measure by the total leverage exposure measure.

$$\text{Leverage Ratio} = \frac{\text{Tier 1 Capital}}{\text{Leverage Exposure Measure}}$$

The Run Basel III Revised Leverage Ratio Calculation is used for computing the leverage ratio, as per the revised guidelines.

Net Tier 1 capital is the summation of Net CET1, and Net AT1 capital amount post regulatory adjustment. Exposure measure is the summation of on-balance sheet items, off-balance sheet items, Derivative Exposures, and Structured Financial Transactions (SFT). The on-balance sheet items include the non-Securitization exposures' amount and the Securitization exposures' amount. The off-balance sheet items include the non-Securitization exposures' amount and the Securitization exposures' amount. Mitigation is not considered when calculating exposure amount.

The leverage calculation happens at the consolidated parent entity level. The market risk data are not captured for the EU Jurisdiction, and hence that is expected as a download. This is expected in Stage Standard Account Head (**STG_STANDARD_ACCT_HEAD**) for the CAP843 (Leverage Ratio).

The leverage ratio calculations are a separate run and not part of the regular capital calculation run. This is because of the changes in the Credit conversion factor assigned to the exposures, and also the exemption of few exposures from the calculation which are part of the capital charge calculations. Also, mitigation is not required for these exposures, and the exposure measure calculations are different from the regular EAD calculations.

The accord is not explicit on the inclusion of Securitization and market-related transactions in the exposure measure calculations. However, the application has considered Securitization and the market-related transactions in the calculation of total leverage exposure measure.

As the application does not support market-related capital calculations for the BIS jurisdiction, the application expects the MR-related Exposure measure as a download.

Figure 87: Capital calculation process flow

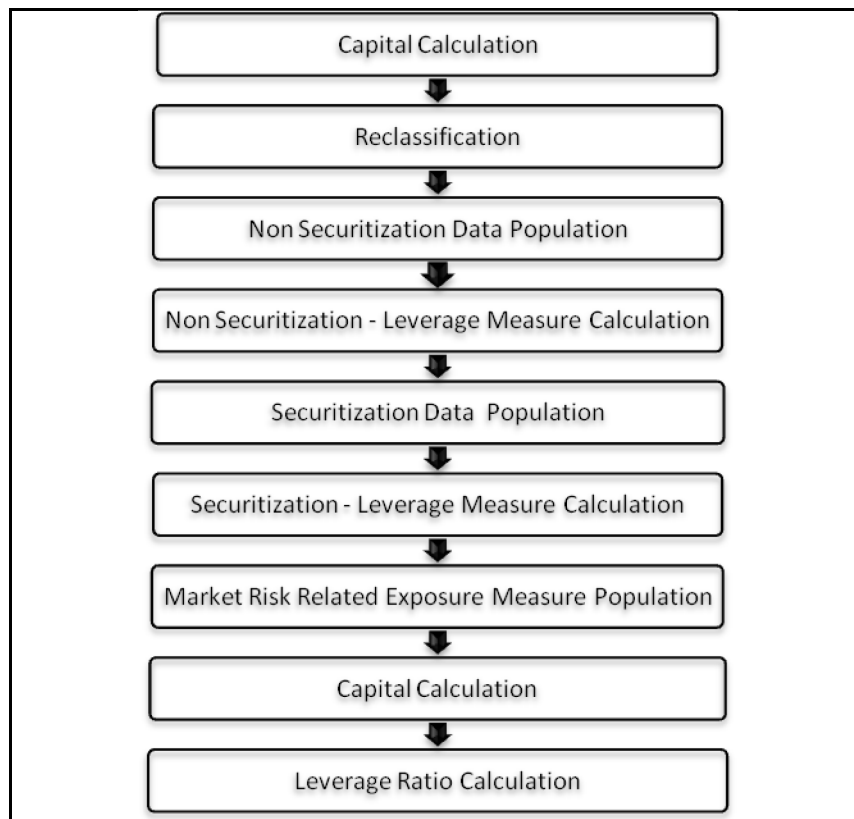

9.11.1 Data Population

Non-Securitization Exposure Data Population

Data from the Product Processors are populated to FCT_NON_SEC_EXPOSURES table in the process NON_SEC_DATA_POPULATION. This data population also remains the same as existing in the capital calculation run.

Collateral of Derivative

Collateral for the derivatives, which is already considered in the MTM calculation, are provided in the STG_MITIGANTS table with the eligibility flag as 'N' and the corresponding entry is added into the STG_EXP_MITIGANT_MAPPINGS table.

The MTM provided for the derivatives' instruments, must be after following the corresponding operational accounting framework.

Securitization Data Population

Securitization exposure data is populated to the securitization processing table in the process SEC_DATA_POPULATION. The population remains the same as in the capital calculation run.

Key Data Elements

Key data elements are elaborated in this section. For a complete list of tables and columns to be populated, see the Download Specifications document.

To calculate the leverage ratio, the exposure amount for all product types and the total capital is required.

The key data elements for exposure measure calculation of the various product types are as follows:

- On-Balance Sheet Exposures: For on-balance sheet items, End of Period (EOP) balance amount, write-off, and accrued interest amount are required.
- SFT Exposures: For repo products, exposure amount, and instrument rating are required.
- Derivative Exposures: For derivative products, exposure mark to market value, notional principal amount, and underlying instrument types are required.
- Off-Balance Sheet Exposures: For off-balance sheet items, an undrawn amount is required.
- Securitization Transaction: For securitization transactions, an exposure amount is required.
- Capital Calculation: See the Capital Structure for more details.
- Cash Variation Margin: The collateral segregated flag, exchange-traded flag, and netting agreement code is required.
- Netting Agreement: The margin threshold and the minimum transfer amount are required, which are captured in the Stage Net Exposures table (STG_NET_EXPOSURES).

9.11.2 Exposure Measure Calculations

- After data is populated in the non-Sec processing table, the exposure measure is calculated in the process **BASELIII_LEV_RATIO_EXPOSURE_MEASURE_CALCULATION**.
- The Exposure measure is the sum of the Pre-mitigation EAD amount of the following exposure types:
 - On-Balance Sheet Exposures
 - Off-Balance Sheet Exposures
 - SFT Exposures
 - Derivative Exposures

- Details on the calculation of these exposure measures are mentioned in the following sections. All the exposure measures are computed and populated into the Leverage Exposure amount (**N_LEVERAGE_EXPOSURE_AMOUNT**) column. And any exempted exposures are identified by the solution in the Regulatory Capital Exemption Criteria in the Non-Sec Exposures processing table. These exempted criteria are part of the dimension table of Regulatory Capital Exemption Criteria Dimension (**DIM_REG_CAP_EXEMPTION_CRITERIA**).

9.11.2.1 On Balance Sheet Exposures

- The accounting value of the on-balance sheet exposures net of specific provisions and valuation adjustments are considered for the exposure measure. The valuation adjustments are captured at an instrument level, in the FSI setup table for Instrument Valuation Details (**FSI_SETUP_INSTR_VALUATION_DTLS**).
- The exposure measure considered is the Pre-Mitigation amount and does not consider the benefit of the mitigation.
- Some of the exempted exposures are detailed as follows.
- **Fiduciary Assets**
- If the bank considers the assets of the fiduciary assets, as the bank's assets, then these assets are exempted from the calculation. The fiduciary assets are identified based on the exposures having the Parent Fiduciary Account Number (**V_PARENT_FIDUCIARY_ACCT_NUMBER**) in the product processor (PP) staging tables.
- The bank has to select the run management option to select whether the exposures are derecognized in the balance sheet or not. If the run management option of Y is selected, all the fiduciary assets with the parent fiduciary account are exempted from the Leverage Exposure Measure calculations. If the run management option of N is selected, specific fiduciary assets can be exempted from the Leverage Exposure Measure calculations. These specific fiduciary assets are expected to be provided in the FSI Fiduciary Assets setup table (**FSI_SETUP_DEREC_FIDUCIARY_ASST**).
- This is handled in the Fiduciary Assets Exemption sub-process of the **BASELIII_LEV_RATIO_EXPOSURE_MEASURE_CALCULATION** process.

9.11.2.2 Off-Balance sheet exposures

The exposure amount for off-balance sheet exposures is the undrawn amount of the exposure multiplied by the CCF. The CCF of the exposures remain the same as in the Capital Calculation Run, except that the CCF is floored at 10%. The flooring of the CCF to 10% is handled by the rule Non-Sec Off-Balance Sheet Exposures CCF Percent Flooring in the Non-Sec CCF Assignment sub-process. This exposure measure does not consider the mitigation effect.

9.11.2.3 Derivative Exposures

Derivative transactions (OTC Derivatives) exposure measures are calculated using the Mark to Market Method. The add-on assignment is the same as mentioned in the Capital Calculation Run. The exposure measure is the sum of market value, and the notional amount multiplied by the add-on percent.

The derivative exposure measure has few specific treatments, in terms of the Leverage Exposure Measure calculations. They are as detailed as follows.

Collateral of Derivative

The collateral received concerning the derivatives, cannot be used in netting and reducing the exposure amount of the derivatives. Based on whether the operative accounting framework allows for the netting of the collateral or not, the solution updates the exposure measure. The solution expects a run management selection to identify whether the bank considers netting of the collateral outside the application, and provides the netted amount as input to the product processor staging tables.

The collateral of the derivative is given in the mitigant table. There is a run management option to capture whether the operative accounting framework allows for the netting of the collateral as per the master netting agreement or not.

If 'Yes' is selected, assuming that the bank has provided the MTM value based on already considering the collateral amount, the collateral amount is added to the MTM of the exposure. And if 'No' is selected, there is no change to the MTM value.

9.11.2.4 SFT Exposures

The exposure amount of the SFT Exposures to be considered for the leverage measure is post the effect of the collateral. The SFT Exposures data provided in the staging must not consider the accounting netting.

The data capture for the SFT exposures remains the same as in the Capital calculation run. The bank role in the SFT transaction is also captured in the staging table.

The Gross amount and the Add-on amount, as expected in the accord are computed by the application. The Gross amount is the actual transaction amount of the SFT exposures, as provided in the Repo contracts staging table. And the Add-on amount is the difference between the fair value of the repo exposures and the fair value of the collateral placed or received.

- The fair value of the exposures, including the placed collateral are captured at an instrument level, in the FSI setup table for Exposure Fair Value Details (**FSI_SETUP_INSTR_VALUATION_DTLS**), and the fair value of the mitigants are captured in the FSI setup table for Mitigant Fair Value (**FSI_SETUP_MTGNT_VALUATION_DTLS**).

The mitigants which are used to offset the fair value of the repo exposures, are stamped accounting heads, to ensure that they can be tracked.

The exposure amount calculations are different for the bank acting as a principal in the SFT transactions, and an agent in the SFT transactions. The solution supports both treatments.

For bank acting as an agent, the solution handles all the treatment mentioned in the accord. The data expectation for them are as follows:

- Case 1: Bank is an agent, and does not get involved in any other role with the SFT Exposure
In this case, the data is not expected in the Repo contracts staging table.
- Case 2: Bank is an agent, and provides a guarantee equal to the difference between the SFT Exposure and the collateral amount

In this case, the data is expected in the Repo contracts staging table, with the bank role as an agent, and the indemnity indicator (**F_INDEMNITY_IND**) as 'Y'.

The application computes only the Add-on amount for this SFT transaction, in line with the guidelines. And this Add-on amount is populated into the Add-on column of the processing table. This Add-on amount is calculated in the data transformation Lev_Ratio_SFT_Addon_amt.

This is handled in the sub-process (Leverage Ratio Computations) of the process **(BASELIII_LEV_RATIO_EXPOSURE_MEASURE_CALCULATION)**.

- Case 3: Bank is an agent, and provides a guarantee more than the difference between the SFT Exposure and the collateral amount

In this case, the data is expected in the Repo contracts staging table, with the bank role as an agent, and the indemnity indicator (F_INDEMNITY_IND) as Y. And a separate guaranteed transaction is expected to be recorded in the guarantee staging table. This guaranteed transaction is also provided as a mitigant with the mitigant table storing the guarantee contract ID **(V_GUARANTEE_CONTRACT_ID)**. And the exposure and the mitigant must be mapped to each other in the exposure mitigant mapping table STG_ACCOUNT_MITIGANT_MAP).

This guarantee is not for a mitigant treatment, and hence, this is expected with the mitigant eligibility flag as 'N'. This identified guarantee is populated in FNSE.n_repo_contract_skey.

The application computes both the gross exposure amount and the add-on amount for this SFT transaction, in line with the guidelines. This Add-on amount is calculated in the data transformation Lev_Ratio_SFT_Addon_amt.

This is handled in the sub-process (Leverage Ratio Computations) of the process **(BASELIII_LEV_RATIO_EXPOSURE_MEASURE_CALCULATION)**.

9.11.2.5 Total Capital Calculations

The capital measure is calculated in the EU_CAPITAL_STRUCTURE process. Capital Measure used in the leverage ratio is equal to Net Tier 1 which is post all regulatory adjustments. The capital structure is the same as the capital calculation run.

9.11.2.6 Leverage Ratio Calculations

The leverage ratio is calculated as follows.

Leverage Ratio = Tier 1 Capital / Total Leverage Exposure Measure

This is computed in the process – BASELIII_LEV_RATIO_LEVERAGE_RATIO_CALCULATION.

10 **Basel III: Finalizing Post Crisis-IRB Approach**

Capital Adequacy guidelines as issued in the following regulations are incorporated in OFS Financial Services Basel Regulatory Capital:

BIS Jurisdiction: International Convergence of Capital Measurement and Capital Standards, June 2006.

Basel III: A global regulatory framework for more resilient banks and banking systems, Dec 2010 (rev June 2011).

This approach covers the following topics:

- Credit RWA
- Counterparty Credit RWA
- Default Fund Contributions Related Capital Charge
- Credit Valuation Adjustments
- Credit RWA for Securitization
- Market Risk RWA
- Operational Risk RWA
- Capital Structure
- Capital Buffers
- Large Exposures
- Leverage Ratio

10.1 **Credit RWA**

The application supports the computation of Credit RWA, as per the guidelines laid out in the Basel Accord. Credit RWA computation is divided into Credit Risk for Non-Securitized exposures process and Credit Risk for Securitized exposures process.

For Credit Risk of Non-Securitized and Securitized exposures, the Foundation IRB Approach (FIRB) and Advanced IRB Approach (AIRB) is as follows.

Figure 88: Credit RWA

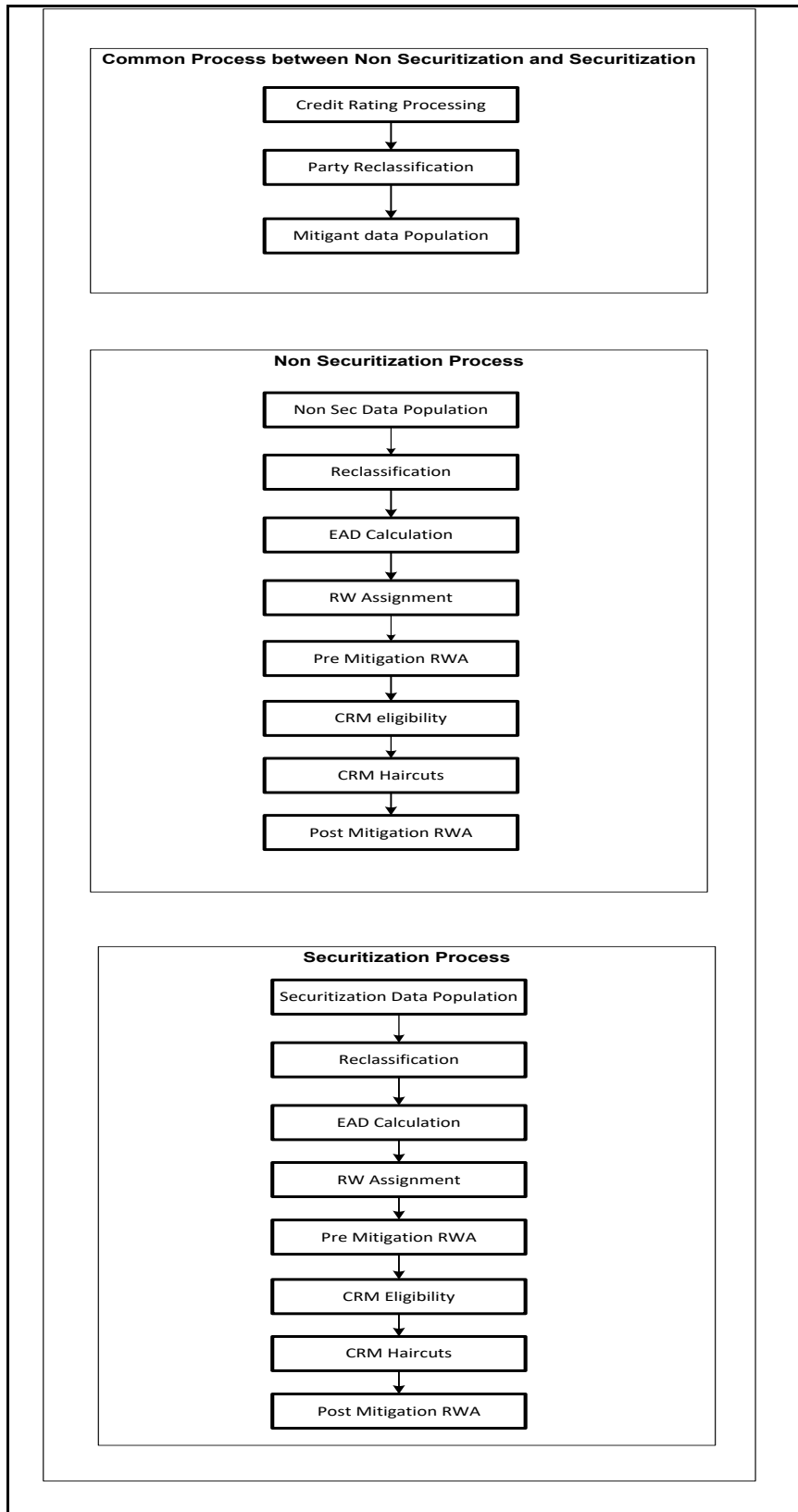

A Credit RWA Run is a combination of the Non-Securitization RWA process and Securitization RWA process. A few processes like Credit Rating, Party Type Reclassification, and Mitigant Data Population are common between Non-Securitization and Securitization process. Though these sub processes are explained separately under Non-Securitization and Securitization section of this document, it is executed only once under the Credit RWA run

Certain sub processes under non-Securitization process like Reclassification, RW assignment, and so on are common across all types of exposures for example: banking book, over the counter derivative transactions, and securities financing transactions, and are executed only once in the Run. The details of these sub processes are explained under Reclassification and Risk Weight Assignment sub process of the Basel II Non-Securitization exposures section of this document. Likewise, details of Credit Risk Mitigation for Non-Securitization process is detailed under the Basel II Non Securitization section of this document and details of Credit Risk Mitigation for Securitization process is detailed under the Basel II Securitization section of this document.

For more information on the sub processes as detailed in the preceding process flow for the non-Securitization process and Securitization process, see Error! Reference source not found..

For example: Non-Sec Data Population is detailed under data population and currency conversion of Credit RWA (Non-Securitization - Standardized approach) section of this document.

10.1.1 Banking Portfolio

The banking portfolio BIS 3 P CIRB flow is explained below:

Figure 89: Banking data population work flow

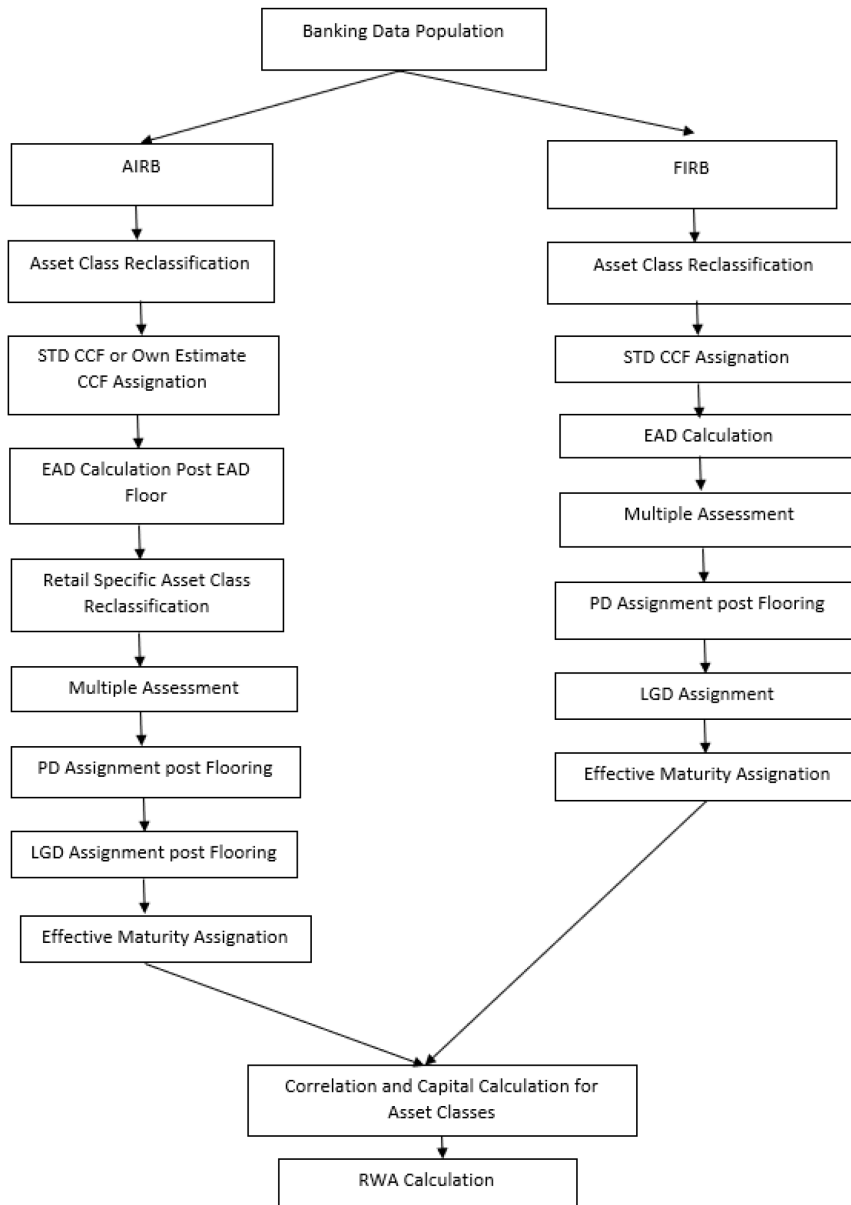

Rating Population

The data on ratings is captured in the following rating specific tables:

- Account Rating Table (STG_ACCOUNT_RATING_DETAILS)
 - Ratings of all Credit Risk Banking Exposures are captured in this table.
- Party Rating Table (STG_PARTY_RATING_DETAILS)
 - Credit Rating for all customers and issuers are captured in this table.

- Sovereign Rating Table (STG_SOVEREIGN_RATING_DETAILS)

Credit Rating for all countries is captured in this table.

10.1.1.1 Data Population

The data population remains the same as in BIS PC Standardized Approach

10.1.1.2 Shareholding Percent Multiplication

The shareholding percent multiplication for the various amounts associated with the exposure remains the same as in BIS PC Standardized Approach.

10.1.1.3 Common Reclassification Rules

The reclassification rules are consistently the same across all the approaches of the calculations. This is same as in BIS PC Standardized Approach.

10.1.1.4 Asset Reclassification Rules

The asset reclassification is based on the various combinations of the Basel product type and the standard counterparty type and any other filters as relevant.

For AIRB, Process Name: Post Crisis Banking Reclassification - AIRB

For FIRB Process Name: Post Crisis Banking Reclassification - FIRB

The sub-processes in both are as follows:

Banking Basel Asset Reclassification - Other Asset Class

BIS - Banking Basel Post Crisis Reforms Asset Reclassification based on Party Type – IRB

BIS - Post Crisis Banking Basel Asset Reclassification based on Product Type – IRB

BIS - Banking Basel Post Crisis Reforms Asset Reclassification Specialized Lending Exposures – IRB

BIS - Banking Basel Post Crisis Reforms Asset Reclassification based on Standard Party – IRB

Banking - Large Corporate Asset Class Reclassification

BIS - Post Crisis Banking Asset Reclassification for Corporate specific Purchase Receivable – IRB

CR - Post Crisis Banking Asset Reclassification for SME – IRB

CR - Post Crisis Banking Asset Reclassification for Retail QRRE

10.1.1.5 Pre-mitigation Calculations

Some exposures can be hedged against credit risk through various mitigants like guarantors, collaterals, credit derivatives, and so on. These provide mitigation to credit risk and must be considered while computing Credit RWA as per Basel norms. Hence, the application calculates pre-mitigation risk-weighted assets amount and post-mitigation risk-weighted assets amount.

The application calculates the correlation factor using the formula specified for each asset class. Using Correlation factor, PD, and LGD, the application calculates the pre-mitigation capital charge for each exposure. This value signifies the capital charge the bank has to maintain for each exposure, prior to considering any mitigation effects.

The application calculates pre-mitigation exposure at default amount and risk weight for each exposure. Further, it computes pre-mitigation risk-weighted assets (Pre-CRM RWA) by multiplying the EAD by risk weight. The risk weight is arrived at by multiplying pre-mitigation capital charge with 12.5.

10.1.1.5.1 Credit Conversion Factor (CCF Assignment)

This is an input required for converting the off-balance sheet component of the exposure (undrawn portion associated with an on-balance sheet or off-balance sheet product, or the exposure amount of an off-balance sheet product). This is based on the supervisory provided values and is determined based on the product type and the maturity associated with the exposure in the case of FIRB Approach. In the case of AIRB Approach, the CCF can be either based on the supervisory estimate or own estimate.

This will populate the Drawn CCF (for the CCF to be assigned to the exposure amount of the off-balance sheet product) and the Undrawn CCF (for the CCF to be assigned to the undrawn portion of the on-balance sheet and off-balance sheet exposures).

This happens in the sub-process PCR CCF Assignment Based on Supervisory Estimates - FIRB and PCR CCF Assignment based On Supervisory Estimates - AIRB.

10.1.1.5.2 Exposure at Default Amount Calculation

Exposure at Default (EAD) is calculated for all the products. This is being computed using the Exposure Amount (EOP Balance of the Exposure), Undrawn Amount of the Exposure (Undrawn Amount) and also the Credit Conversion Factor for the Off-Balance sheet Amount (CCF). This is computed for the on-balance sheet products separately, and the off-balance sheet products separately.

In the case of FIRB as well as AIRB Approach, it can either be the formulae specified above, or bank can model and directly provide the EAD as a download.

This happens in the sub-process Post Crisis Banking Pre-CRM EAD Computation and Post Crisis Banking Pre-CRM EAD Computation – FIRB.

10.1.1.5.3 Post CRM EAD

Through the CRM process, the bank takes into account the effect of the mitigation and calculates the post-mitigation exposure at the default amount. This signifies the maximum loss that the bank can suffer in case of default on this exposure, after considering the effects of the mitigation. This will be the EAD of the Exposure Pre-Mitigation less the covered portion of the mitigant.

10.1.1.5.4 Capital Charge Rules

In the case of IRB Approach, the Capital charge is being computed for both unexpected loss as well as Expected loss.

1. Unexpected Loss Calculations

Unexpected Loss is calculated as using the Probability of Default (PD), Loss Given Default (LGD), Effective Maturity (M) and Correlation Factor.

For FIRB - in the process Post Crisis Banking Capital Calculation - FIRB

For AIRB - in the process Post Crisis Banking Capital Calculation - AIRB.

a. PD Calculations

Probability of Default (PD) signifies the likelihood of a borrower failing to meet his/her financial obligations. In both FIRB and AIRB, PD values are expected as input/download from the bank. This gets captured as part of the data population process.

There are certain flooring requirements and capping requirements that are specified for each of the asset class.

This is handled in the sub process as below:

For FIRB - In the sub-process Post Crisis Banking PD LGD Assignment - FIRB in the process Post Crisis Banking Data Processing – FIRB.

For AIRB - In the sub-process Post Crisis PD LGD Assignment - AIRB in the process Post Crisis Banking Data Processing – AIRB.

b. LGD Calculations

Loss Given Default (LGD) signifies the portion of the exposure that is likely to be lost in case the borrower defaults. In FIRB, LGD is computed by the application, as per the regulatory ask for each of the asset class. In addition, in the case of AIRB, LGD is also expected as a download.

All PD and LGD calculations are handled in the process as below:

For FIRB - In the sub-process Post Crisis Banking PD LGD Assignment - FIRB in the process Post Crisis Banking Data Processing – FIRB.

For AIRB - In the sub-process Post Crisis PD LGD Assignment - AIRB in the process Post Crisis Banking Data Processing – AIRB.

c. Effective Maturity Calculations

Effective maturity (M) will be 2.5 years for exposures to which the bank applies the foundation approach, except for repo-style transactions where the effective maturity is 6 months (i.e., $M=0.5$). In addition, in the case of AIRB, this is also expected to be provided by the bank using the modeling requirement.

The effective maturity (M) is subject to a floor of one year and a cap of 5 years

All maturity calculation is handled in the process as below:

For FIRB - In the sub-process MATURITY_CALCULATION_AND_ASSIGNMENT_FIRB in the process Banking Data Processing – FIRB.

For AIRB - In the sub-process MATURITY_CALCULATION_AND_ASSIGNMENT_AIRB in the process Banking Data Processing – AIRB.

d. Correlation Calculations

The correlation is being computed as per the requirement provided by the regulator by using all the inputs of PD, LGD, EAD and Effective Maturity.

As per the regulatory ask, the application assigns the multiplier of 1.25 to the Asset Value Correlation (AVC) of exposures wherever relevant. These exposures relate to regulated financial firms with assets of at least 100 billion USD and to exposures of unregulated financial firms (regardless of size). This gets consumed in the correlation formulae applicable for the asset classes' specific calculation, as specified by the regulator.

This is calculated in the sub-process Basel III Banking Correlation Factor

For FIRB - in the process Post Crisis Banking Capital Calculation - FIRB

For AIRB - in the process Post Crisis Banking Capital Calculation - AIRB

e. Capital Charge Calculations

The capital charge for the unexpected loss is computed using the regulatory provided calculation specific for the asset classes. This gets handled in the process as below:

For FIRB - in the process Post Crisis Banking Capital Calculation - FIRB

For AIRB - in the process Post Crisis Banking Capital Calculation - AIRB

f. Purchased Receivables – Default Risk Charge Calculations.

In the case of Purchased receivables, the capital charge is computed for both the dilution risk as well as the default risk.

Under Internal Ratings Based approach, banks have the option of selecting Top-Down approach or Bottom-Up approach for calculating default risk capital charge for Purchase Receivables

In Top-Down approach, the risk weight calculation happens at a pool of receivables as a whole level instead of at individual obligor level. On the other hand, Bottom Down approach uses individual receivables making up the pool to arrive at the capital charge. Banks have the option to decide which approach to use. (For more information, see Run Management)

For FIRB - in the process Post Crisis Banking Capital Calculation - FIRB

For AIRB - in the process CA Post Crisis Banking Capital Calculation - AIRB.

g. Purchased Receivables – Dilution Risk Charge Calculations.

In the case of Purchased receivables, the capital charge is computed for both the dilution risk as well as the default risk.

Purchase receivables always have an inherent risk of diluting future cash flows because of cash and non-cash credits such as discounts and guarantees. This risk needs to be quantified in case the bank feels Dilution Risk is material. Banks can decide whether Dilution Risk capital charge is required or not. (For more information, see Run Management)

This is handled in the sub-process Banking Pre-Mitigation Capital Required for Dilution Risk - Retail Receivables and Banking Pre-Mitigation Capital Required for Dilution Risk - Corporate Receivables

For FIRB - in the process Post Crisis Banking Capital Calculation - FIRB

For AIRB - in the process Post Crisis Banking Capital Calculation - AIRB.

2. Expected Loss calculation

Expected loss is the loss which the bank expects it will incur during the course of holding the exposure. This is mostly computed by using the attributes of PD, LGD and EAD.

This is calculated as the product of PD, LGD and EAD. This is applicable for most of the asset classes.

For FIRB - In the process Post Crisis Banking Pre CRM-Risk Weighted Asset Calculation - FIRB

For AIRB - In the process Post Crisis Banking Pre CRM-Risk Weighted Asset Calculation - AIRB

10.1.1.5.5 RWA Calculations

IRB approaches calculate RWA for dilution risk (Banking RWA For Dilution Risk), pre mitigation RWA unexpected loss (Banking Pre-Mitigation RWA – UL) as well as pre mitigation RWA expected loss (Banking Pre-Mitigation RWA – EL).

All these sub-processes can be found in the below process:

- For FIRB - In the process Post Crisis Banking Pre CRM-Risk Weighted Asset Calculation - FIRB
- For AIRB - In the process Post Crisis Banking Pre CRM-Risk Weighted Asset Calculation - FIRB

10.1.1.6 Credit Risk Mitigation Process

Credit Risk Mitigation is the same as in the Standardized approach of the calculations.

10.1.1.6.1 Mitigant Eligibility

The mitigant eligibility remains the same as in BIS 3 PC STD, except for the scenario wherein the bank can only follow Comprehensive Approach for collateral recognition, and not simple Approach. Only ECRA is applicable for BIS 3 PC IRB.

10.1.1.6.2 Mitigant Approaches and their Risk Weighting Rules

The mitigant approaches applicable for IRB are only the Comprehensive Approach for Collateral recognition. This is similar to BIS 3 PC STD. The RW of Guarantee, Credit Derivatives as part of the substitution approach are handled in Post Crisis CRM Sub Exposure Data Processing - Non Sec.

And in the case of unfunded mitigant in the form of guarantee and credit derivatives, the risk weights are calculated by using the PD of the mitigant provider, and the LGD of the covered exposure, and using the risk weight function as applicable for the mitigant asset class.

This is handled in the sub-process CAP Collateral Eligibility for IRB Mitigants in the process Mitigant Collateral Eligibility – Comprehensive Approach – BIS.

10.1.1.6.3 Mitigant Haircut Assignment

Under IRB approach, the bank can follow either supervisory estimates (in the case of FIRB/ AIRB) or bank's own estimate (in the case of AIRB) for Mitigant Haircut assignment. This is based on the various categories like mitigant type, residual maturity, rating, issuer type etc.

All the other part of the haircut assignment is same as in BIS 3 PC STD.

10.1.2 Investment Portfolio

10.1.2.1 Data Population

Data Population is explained in detail under the Investment Portfolio sub section of the Credit RWA section in this document

In addition to the Product Processor tables, FSI Setup Account Modeling Information (FSI_SETUP_ACCT_MODELING_INFO) is used for providing the input required for the Capital charge calculation, and which is based on the bank's specific models. Some of the attributes picked up from this

table are PD, LGD in the case of AIRB approach, Effective Maturity, CCF Own Estimate (in the case of AIRB approach) etc.

This is handled in the process Investment Data Population.

10.1.2.2 Shareholding Percent Multiplication

Shareholding Percent Multiplication is explained in detail under the Investment Portfolio sub section of the Credit RWA section in this document.

10.1.2.3 Common Reclassification Rules

Common Reclassification Rules is explained in detail under the Investment Portfolio sub section of the Credit RWA section in this document.

10.1.2.4 Asset Reclassification Rules (different from STD)

The asset reclassification is based on the various combinations of the Basel product type and the standard counterparty type and any other filters as relevant. This remains functionally the same as in [Standardized Approach](#).

For both FIRB and AIRB, Process Name: INV_DATA_RECLASSIFICATION_IRB

For FIRB Process Name: BNK_RECLASSIFICATION_FIRB

The sub-processes in both are as follows:

BIS - Investment Basel Asset Reclassification based on Party Type – IRB

BIS - Investment Basel Asset Reclassification based on Product Type - IRB

10.1.2.5 Pre-mitigation Calculations

Some exposures can be hedged against credit risk through various mitigants like guarantors, collaterals, credit derivatives, and so on. These provide mitigation to credit risk and must be considered while computing Credit RWA as per Basel norms. Hence, the application calculates pre-mitigation risk-weighted assets amount and post-mitigation risk-weighted assets amount.

The application calculates the correlation factor using the formula specified for each asset class. Using Correlation factor, PD, and LGD, the application calculates the pre-mitigation capital charge for each exposure. This value signifies the capital charge the bank has to maintain for each exposure, prior to considering any mitigation effects.

The application calculates pre-mitigation exposure at default amount and risk weight for each exposure. Further, it computes pre-mitigation risk-weighted assets (Pre-CRM RWA) by multiplying the EAD by risk weight. The risk weight is arrived at by multiplying pre-mitigation capital charge with 12.5.

10.1.2.5.1 Exposure at Default Amount Calculation (different from STD)

Exposure at Default (EAD) is calculated for all the products. This is being computed using the Exposure Amount (EOP Balance of the Exposure)

This happens in the sub-process INV_EAD_CALCULATION_IRB in Investment Data Processing – FIRB and Investment Data Processing –AIRB processes

Post CRM EAD

Through the CRM process, the bank takes into account the effect of the mitigation and calculates the post-mitigation exposure at the default amount. This signifies the maximum loss that the bank can suffer in case of default on this exposure, after considering the effects of the mitigation. This will be the EAD of the Exposure Pre-Mitigation less the covered portion of the mitigant

10.1.2.5.2 Capital Charge Rules (different from STD)

Two primary capital charge measures that differentiate IRB run from STD run are expected loss and unexpected loss calculations.

1. Unexpected Loss Calculations

Unexpected Loss is calculated as using the Probability of Default (PD), Loss Given Default (LGD), Effective Maturity (M) and Correlation Factor.

This is handled in the sub-process Non-Sec Inv Pre-Mitigation Capital Required for UL in the process INV_CAPITAL_CALCULATION_IRB

a. PD Calculations

Probability of Default (PD) signifies the likelihood of a borrower failing to meet his/her financial obligations. In both FIRB and AIRB, PD values are expected as input/download from the bank. This is captured as part of the data population process.

There are certain flooring requirements and capping requirements, which are specified for each of the asset class.

This is handled in the sub process as below:

For FIRB - In the sub-process INV_PD_LGD_ASSIGNMENT_FIRB in the process Investment Data Processing – FIRB.

For AIRB - In the sub-process INV_PD_LGD_ASSIGNMENT_AIRB in the process Investment Data Processing – AIRB.

b. LGD Calculations

Loss Given Default (LGD) signifies the portion of the exposure that is likely to be lost in case the borrower defaults. In FIRB, LGD is computed by the application, as per the regulatory ask for each of the asset class. Moreover, in the case of AIRB, LGD is also expected as a download.

All PD and LGD calculations are handled in the process as below:

For FIRB - In the sub-process INV_PD_LGD_ASSIGNMENT_FIRB in the process Investment Data Processing – FIRB.

For AIRB - In the sub-process INV_PD_LGD_ASSIGNMENT_AIRB in the process Investment Data Processing – AIRB.

c. Effective Maturity Calculations

Effective maturity (M) will be 2.5 years for exposures to which the bank applies the foundation approach, except for repo-style transactions where the effective maturity is 6 months (ie M=0.5). Moreover, in the case of AIRB, this is expected to be provided by the bank using the modeling requirement.

The effective maturity (M) is subject to a floor of one year and a cap of 5 years

All maturity calculation is handled in the process as below:

For FIRB - In the sub-process INV_MATURITY_CALCULATION_AND_ASSIGNMENT_FIRB in the process Investment Data Processing – FIRB.

For AIRB - In the sub-process INV_MATURITY_CALCULATION_AND_ASSIGNMENT_AIRB in the process Investment Data Processing – AIRB.

d. Correlation Calculations

The correlation is being computed as per the requirement provided by the regulator by using all the inputs of PD, LGD, EAD and Effective Maturity.

As per the regulatory ask, the application assigns the multiplier of 1.25 to the Asset Value Correlation (AVC) of exposures wherever relevant. These exposures relate to regulated financial firms with assets of at least 100 billion USD and to exposures of unregulated financial firms (regardless of size). This is consumed in the correlation formulae applicable for the asset classes' specific calculation, as specified by the regulator.

This is calculated in the sub-process Basel III Non-Sec Inv Correlation Factor in the process INV_CAPITAL_CALCULATION_IRB.

2. Expected Loss calculation

Expected loss is the loss, which the bank expects it will incur during holding the exposure. This is mostly computed by using the attributes of PD, LGD and EAD.

This is calculated as the product of PD, LGD and EAD. This is applicable for most of the asset classes.

This is handled in the sub-process Non-Sec Inv Pre-Mitigation – EL in the process INV_RWA_CALCULATION_IRB.

10.1.2.5.3 RWA Calculations

IRB approaches calculate RWA for pre mitigation RWA unexpected loss (Non-Sec Inv Pre-Mitigation RWA – UL) as well as pre mitigation RWA expected loss (Non Sec Inv Pre-Mitigation RWA - EL).

These sub-processes are part of the process INV_RWA_CALCULATION_IRB.

10.1.2.6 Credit Risk Mitigation Process

10.1.2.6.1 Mitigant Approaches and their Risk weighting rules (different from STD)

The mitigant approaches applicable for IRB are only the Comprehensive Approach for Collateral recognition. This is same as in [Standardized Approach](#).

And in the case of unfunded mitigant in the form of guarantee and credit derivatives, the risk weights are calculated by using the PD of the mitigant provider, and the LGD of the covered exposure, and using the risk weight function as applicable for the mitigant asset class.

This is handled in the sub-process CAP Collateral Eligibility for IRB Mitigants in the process Mitigant Collateral Eligibility – Comprehensive Approach – BIS.

10.1.2.6.2 Mitigant Haircut Assignment

Under IRB approach, the bank can follow either supervisory estimates or banks estimate for Mitigant Haircut assignment. This is based on the various categories like mitigant type, residual maturity, rating, issuer type etc. This is applicable only if the bank follows comprehensive approach for collateral.

Only eligible mitigants are considered for haircut assignment and for further processing. Post haircut assignment, the eligible mitigants are moved from mitigants table (FSI_CAP_MITIGANTS) to sub exposures table (FSI_CAP_SUB_EXPOSURES).

The application does computations for three kinds of mitigant haircuts, which are volatility haircut, FOREX haircut, and maturity mismatch haircut.

Volatility Haircut

Volatility haircuts are assigned to the collateral to account for any future fluctuations in the market value of the financial collateral. The application assign haircuts for various type of financial collateral like debt securities, equity, mutual funds, and so on. In the supervisory haircut method, the application assigns volatility haircut based on issues, issuer's ratings, mitigant's residual maturity, and type of mitigant.

This is handled in CAP CRM Mitigant Volatility Haircut - Supervisory Haircut under CRM Sub Exposure Data Haircut Assignment process.

Forex Haircut

If the exposure and collateral are in different currencies, then the application makes an adjustment by applying the FOREX haircut.

This is handled in CAP CRM Forex Haircut Sub Exposures under CRM Sub Exposure Data Haircut Assignment process.

Maturity Mismatch Haircut

If the residual maturity of the Credit Risk Mitigant is less than that of the underlying credit exposure, then a maturity mismatch haircut is applied to adjust the value.

This is handled under CAP CRM Maturity Mismatch Haircut under CRM Sub Exposure Data Haircut Assignment process.

There are two methods for assigning volatility haircut:

- Supervisory Haircut
- Own Estimate

This is handled in the sub-process CRM Sub Exposure Data Haircut Assignment in the process CRM Processing – Non-Sec.

Supervisory Estimate

For supervisory haircut method, the application assigns volatility haircut based on issuers, issuer's ratings, mitigants residual maturity, and type of mitigant, as recommended by the regulator

Own Estimate (different from STD)

For Own Estimate method, the application considers the banks own estimate values for haircut instead of using the supervisor's values.

10.1.3 Pooling and Optimizer

10.1.3.1 Pooling

Pooling is one of the pre-requisites for the optimized allocation of the exposures.

Pooling pulls out an exposure, and identifies all the relevant mitigants mapped to it, and the corresponding exposures mapped to these mitigants, and again the corresponding newer mitigants mapped to these exposures. This pooling assigns the cardinality to the exposures based on the mitigant combination.

This happens in the FSI Cap Sub Exposures (FSI_CAP_SUB_EXPOSURES), and the pooling is part of the sub process.

The relevant cardinalities that are assigned to the exposures, as part of this pooling process are as below:

- 1-0 → One exposure not mapped to any mitigant
- 1-1 → One exposure mapped to one mitigant
- 1-N → One exposure mapped to multiple mitigants
- N-1 → Multiple exposures mapped to a single mitigant
- N-N → Multiple exposures mapped to multiple mitigants

10.1.3.2 Optimizer

The optimizer is the process of allocation of the mitigants to the exposures, based on the different logic applicable for the various granularity. The details of this is available in the [Annexure](#).

Both Pooling and Optimizer is handled under the process **CRM Sub Exposure Pooling and Optimizer Processing**.

10.1.3.2.1 Post CRM RWA

The application computes the covered amount and the uncovered amount for the exposures. The covered amount is computed by multiplying the covered factor with the exposure amount. To this covered amount, the application assigns the mitigant risk weight. The product of the covered amount and the mitigant risk weight is the covered RWA. The uncovered amount is computed by multiplying the uncovered factor (which is 1 – sum of all covered factors for that exposure) with the exposure amount. This uncovered amount is multiplied by the exposure risk weight to get the uncovered RWA. The sum of the covered RWA and the uncovered RWA is the Post CRM RWA of the Exposure.

$$\text{Post-CRM RWA} = \text{Covered Amount} * \text{Risk Weight of the Mitigant} \\ + \text{Uncovered Amount} * \text{Risk Weight of the Exposure}$$

10.2 Counterparty Credit RWA

Counterparty Credit RWA is explained in detail under the Counterparty Credit RWA section in this document

10.2.1 Derivatives Portfolio

Figure 90: Processing Derivative portfolio

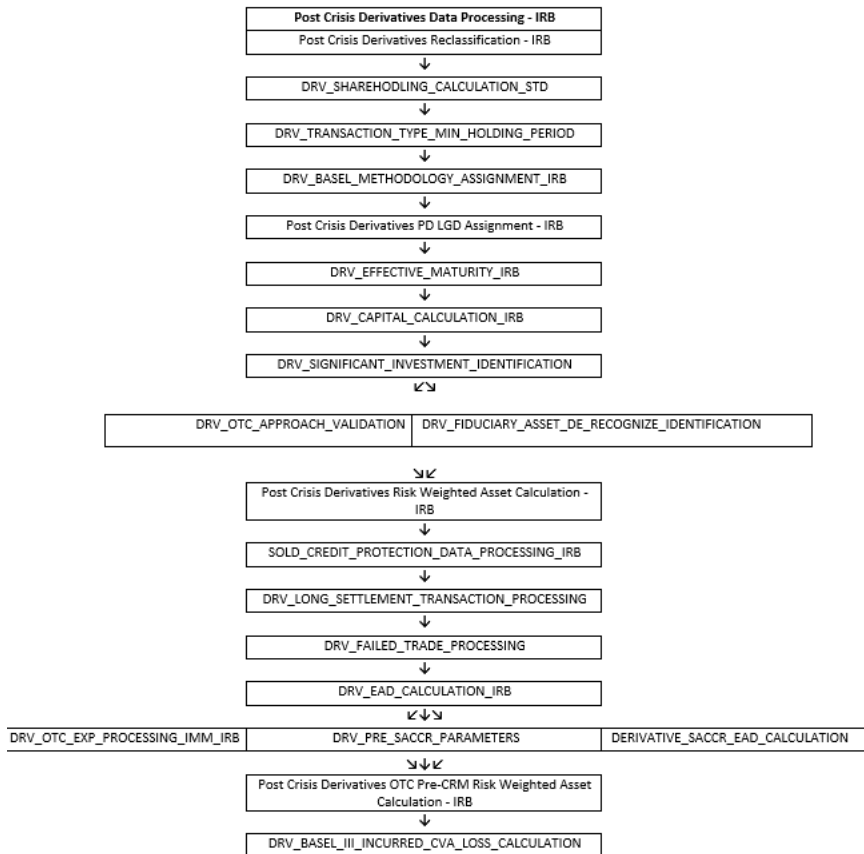

10.2.1.1 Rating Population

The rating population in the case of IRB Approach is not relevant, and is used only for the mitigants, as they are used for the mitigant eligibility and supervisory haircut rules. This is explained in the [Standardized Approach](#) section.

10.2.1.2 Data Population

Data Population is explained in detail under the **Derivatives** Portfolio sub section of the Counterparty Credit RWA section in this document

The process name for data population is

- DERIVATIVE_SWAPS_EXPOSURE_DATA_POPULATION,
- DERIVATIVE_FUT_EXPOSURE_DATA_POPULATION,
- DERIVATIVE_OPT_EXPOSURE_DATA_POPULATION,
- DERIVATIVE_FORWARDS_EXPOSURE_DATA_POPULATION and

- DERIVATIVE_CREDIT_DERIVATIVE_DATA_POPULATION

10.2.1.3 Shareholding Percent Multiplication

The shareholding percent multiplication for the various amounts associated with the exposure remains the same as in Standardized approach.

10.2.1.4 Common Reclassification Rules

The reclassification rules are consistently the same across all the approaches of the calculations. See [Standardized Approach](#) for more details on the same. This is happening in the process DRV_RECLASSIFICATION_IRB (process)

10.2.1.5 Asset Reclassification Rules

The asset reclassification is based on the various combinations of the Basel product type and the standard counterparty type and any other filters as relevant. This remains functionally the same as Standardized Approach.

For AIRB, Process Name: DRV_RECLASSIFICATION_AIRB

For FIRB Process Name: DRV_RECLASSIFICATION_FIRB

The sub-processes in both as follows:

BIS - Derivative Basel Asset Reclassification based on Party Type - IRB

BIS - Derivative Basel Asset Reclassification based on Other Asset Class - IRB

BIS - Derivative Basel Asset Reclassification based on Product Type - IRB

BIS - Derivative Basel Asset Reclassification based on Standard Party Type – IRB

10.2.1.6 Pre-mitigation Calculations

Some exposures can be hedged against credit risk through various mitigants like guarantors, collaterals, credit derivatives, and so on. These provide mitigation to credit risk and must be considered while computing Credit RWA as per Basel norms. Hence, the application calculates pre-mitigation risk-weighted assets amount and post-mitigation risk-weighted assets amount.

The application calculates the correlation factor using the formula specified for each asset class. Using Correlation factor, PD, and LGD, the application calculates the pre-mitigation capital charge for each exposure. This value signifies the capital charge the bank has to maintain for each exposure, prior to considering any mitigation effects.

The application calculates pre-mitigation exposure at default amount and risk weight for each exposure. Further, it computes pre-mitigation risk-weighted assets (DRV_PRE_CRM_RISK-_WEIGHTED_ASSET_CALC) by multiplying the EAD by risk weight. The risk weight is arrived at by multiplying pre-mitigation capital charge with 12.5.

The Exposure at Default amount for derivatives can be computed using either the approach of standardized Approach (SA CCR) or the Internal Model Method (IMM), based on the supervisory approval received by the bank.

Banks can use the SA-CCR approach or IMM Approach while they follow IRB approaches for credit risk. The SA-CCR approach is applicable for Over the Counter (OTC) Derivatives, Exchange Traded Derivatives, and Long Settlement Transactions.

This happens in the sub-process **DRV_EAD_CALCULATION_IRB** in **Derivative Data Processing**,

FIRB - DRV_EAD_CALCULATION_FIRB

AIRB - DRV_EAD_CALCULATION_AIRB

10.2.1.6.1 Exposure at Default Amount Calculation

The Exposure at Default amount for derivatives can be computed using either the approach of standardized Approach (SA CCR) or the Internal Model Method (IMM), based on the supervisory approval received by the bank.

This happens in the sub-process **DRV_EAD_CALCULATION_IRB** in **Derivative Data Processing**,

FIRB - DRV_EAD_CALCULATION_FIRB

AIRB - DRV_EAD_CALCULATION_AIRB

10.2.1.6.2 Methods for calculating EAD

There are two methods of computing EAD for banks following IRB Approach – Standardized Approach (SA CCR) and Internal Model Method (IMM).

1. Standardized Approach (SA CCR)

This is same as detailed in the [Standardized Approach](#). This is applicable for all derivative exposures in the form of OTC derivatives, Cleared Transactions, Exchange Traded Derivatives and Long Settlement Transactions.

The exposures under the SA-CCR consist of two components: replacement cost (RC) and potential future exposure (PFE). The replacement cost is mostly related to the mark to market of the derivative contract, by considering the collateral and margin agreement as relevant. The potential future exposure consists of a multiplier that allows for the partial recognition of excess collateral and an aggregate add-on which is inside the sub-process: **DERIVATIVES_SACCR_EAD_CALCULATION** which is part of the Derivatives Multiple Assessment Risk Weight Assignment.

The following flowchart depicts the process flow of SA-CCR:

Figure 91: Process Flow of SA-CCR

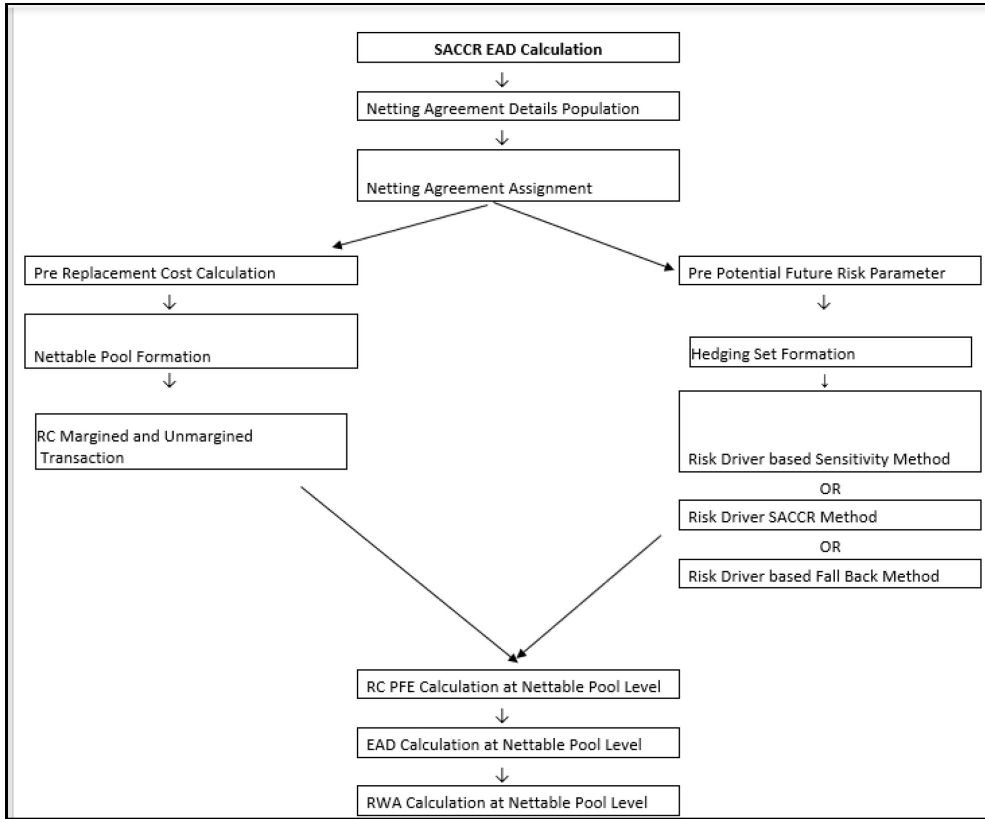

2. Internal Model Method (IMM)

In the case of IMM Approach, the Exposure amount gets computed outside the application, by using the various cross product netting and other related calculation mechanism at a counterparty’s portfolio level. And this is being provided as an input.

This is handled in the process Derivative Pool EAD Calculation - OTC - Internal Model Method

Figure 92: Process Derivative Pool EAD

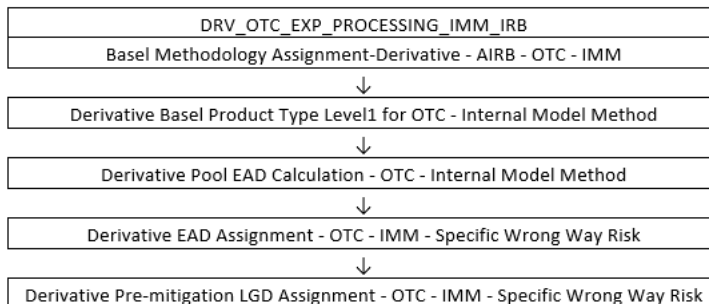

10.2.1.6.3 Post CRM EAD

Through the CRM process, the bank considers the effect of the mitigation and calculates the post-mitigation exposure at the default amount. This signifies the maximum loss that the bank can suffer in case of default on this exposure, after considering the effects of the mitigation. This will be the EAD of the Exposure Pre-Mitigation less the covered portion of the mitigant

10.2.1.6.4 Capital Charge Rules

In the case of IRB Approach, the Capital charge is being computed for both unexpected loss as well as Expected loss.

1. Unexpected Loss Calculations

Unexpected Loss is calculated as using the Probability of Default (PD), Loss Given Default (LGD), Effective Maturity (M) and Correlation Factor.

This is handled in the sub-process Derivative Pre-Mitigation Capital Required for UL

For FIRB - in the process DRV_CAPITAL_CALCULATION_FIRB

For AIRB - in the process DRV_CAPITAL_CALCULATION_AIRB.

a. PD Calculations

Probability of Default (PD) signifies the likelihood of a borrower failing to meet his/her financial obligations. In both FIRB and AIRB, PD values are expected as input/download from the bank. This gets captured as part of the data population process.

There are certain flooring requirements and capping requirements which are specified for each of the asset class.

This gets handled in the sub process as below:

For FIRB - In the sub-process PD_LGD_ASSIGNMENT_FIRB in the process Derivative Data Processing – FIRB.

For AIRB - In the sub-process PD_LGD_ASSIGNMENT_AIRB in the process Derivative Data Processing – AIRB.

b. LGD Calculations

Loss Given Default (LGD) signifies the portion of the exposure that is likely to be lost in case the borrower defaults. In FIRB, LGD is computed by the application, as per the regulatory ask for each of the asset class. And in the case of AIRB, LGD is also expected as a download.

All PD and LGD calculations are handled in the process as below:

For FIRB - In the sub-process DRV_PD_LGD_ASSIGNMENT_FIRB in the process Derivative Data Processing – FIRB.

For AIRB - In the sub-process PD_LGD_ASSIGNMENT_AIRB in the process Derivative Data Processing – AIRB.

c. Effective Maturity Calculations

Effective maturity (M) will be 2.5 years for exposures to which the bank applies the foundation approach, except for repo-style transactions where the effective maturity is 6 months (i.e.

M=0.5). And in the case of AIRB, this is also expected to be provided by the bank using the modeling requirement.

The effective maturity (M) is subject to a floor of one year and a cap of 5 years

All maturity calculation are handled in the process as below:

For FIRB - In the sub-process MATURITY_CALCULATION_AND_ASSIGNMENT_FIRB in the process Derivative Data Processing – FIRB.

For AIRB - In the sub-process MATURITY_CALCULATION_AND_ASSIGNMENT_AIRB in the process Derivative Data Processing – AIRB.

d. Correlation Calculations

The correlation is being computed as per the requirement provided by the regulator by using all the inputs of PD, LGD, EAD and Effective Maturity.

As per the regulatory ask, the application assigns the multiplier of 1.25 to the Asset Value Correlation (AVC) of exposures wherever relevant. These exposures relate to regulated financial firms with assets of at least 100 billion USD and to exposures of unregulated financial firms (regardless of size). This gets consumed in the correlation formulae applicable for the asset class specific calculation, as specified by the regulator.

e. Capital Charge Calculations

The capital charge for the unexpected loss is computed using the regulatory provided calculation specific for the asset classes. This gets handled in the process as below:

For FIRB - in the process CAPITAL_CALCULATION_FIRB

For AIRB - in the process CAPITAL_CALCULATION_AIRB

2. Expected Loss calculation

Expected loss is the loss which the bank expects it will incur during the course of holding the exposure. This is mostly computed by using the attributes of PD, LGD and EAD.

This is calculated as the product of PD, LGD and EAD. This is applicable for most of the asset classes.

This is handled in the sub-process Derivative Pre-Mitigation

For FIRB - In the process PRE_CRM_RISK_WEIGHTED_ASSET_CALCULATION_FIRB

For AIRB - In the process PRE_CRM_RISK_WEIGHTED_ASSET_CALCULATION_AIRB

10.2.1.6.5 RWA Calculations

IRB approaches calculate RWA for dilution risk, Pre mitigation RWA unexpected loss (Derivative Pre-Mitigation RWA – UL) as well as pre mitigation RWA expected loss (Derivative Pre-Mitigation RWA – EL).

All these sub-processes can be found in the below process:

For FIRB - In the process PRE_CRM_RISK_WEIGHTED_ASSET_CALCULATION_FIRB

For AIRB - In the process PRE_CRM_RISK_WEIGHTED_ASSET_CALCULATION_AIRB

10.2.1.6.6 Post CRM RWA

Pre mitigation EAD is divided into Post Mitigation EAD for the covered portion and Post Mitigation EAD for uncovered portion. Covered portion is the portion of the exposure covered by the mitigant and uncovered portion is portion of the exposure not covered by the mitigant. There will be more than one record for the covered portion of that exposure. Post mitigation RWA UL (Post CRM RWA UL) is calculated by multiplying post mitigation EAD and its Capital Required UL. Post mitigation RWA Expected Loss is calculated by multiplying the PD, LGD, and post mitigation EAD amount.

The application computes the covered amount and the uncovered amount for the derivative exposures at the nettable pool and mitigant level combination. The same is being carried back to the nettable pool level, and hence to the exposure level.

The covered amount is computed by multiplying the covered factor with the exposure amount. To this covered amount, the application assigns the mitigant risk weight. The product of the covered amount and the mitigant risk weight is the covered RWA. The uncovered amount is computed by multiplying the uncovered factor (which is 1 – sum of all covered factors for that exposure) with the exposure amount. This uncovered amount is multiplied by the exposure risk weight to get the uncovered RWA. The sum of the covered RWA and the uncovered RWA is the Post CRM RWA of the exposure.

Post CRM EAD + Post CRM EL Amount + Post CRM Capital UL

See [Post CRM RWA Calculations](#) for more information.

10.2.2 Securities Financing Transactions Portfolio

Securities Financing Transactions (SFT) include Repo Style transactions, Margin Lending, Security Financing Borrowing, and so on. Under IRB method we have two approaches:

1. VaR approach – this is the approach wherein the EAD will be the effective exposure amount and there won't be a need of EAD calculation.
2. Comprehensive approach – this is the approach wherein the collateral undergoes haircut treatment, and the exposure value gets reduced from this portion.

For all SFT contracts which have a placed collateral or mitigant mapped to it, the application computes CRM based on the RWA approach undertaken by the bank.

Figure 93: Process Flow for Credit Risk Securities Financing Transactions

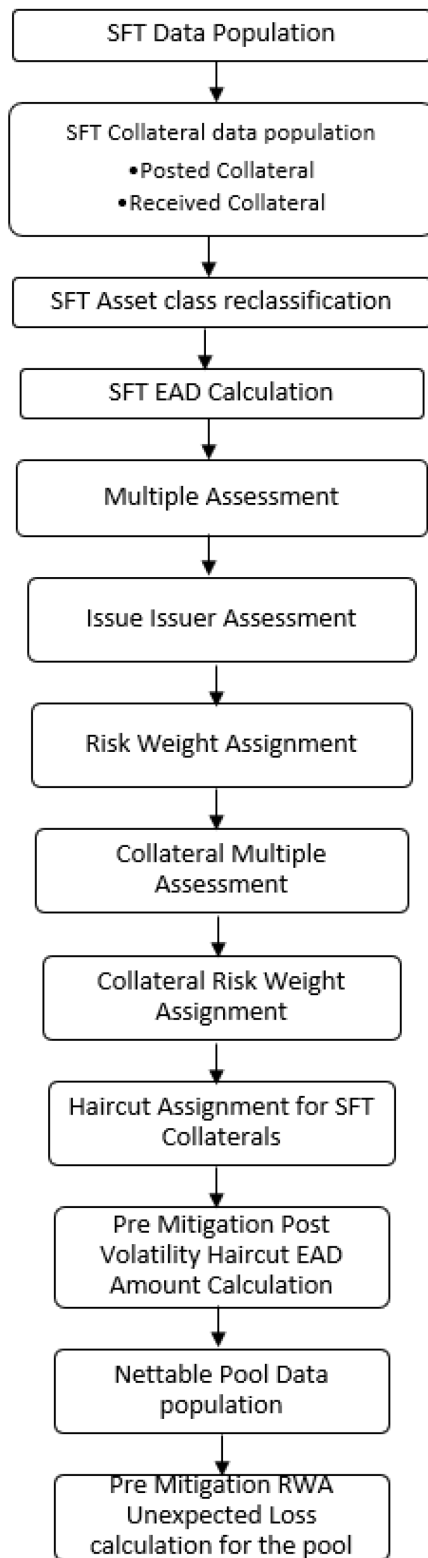

10.2.2.1 Rating Population

The rating population in the case of IRB Approach is not relevant and is used only for the mitigants and placed collateral, as they are used for the mitigant eligibility rules.

Rating population is handled as part of the BIS Common Data Processing in the sub process Credit Rating Data Population. See [Standardized Approach](#) for the details.

10.2.2.2 Data Population

Data Population is handled as part of the sub process SFT_DATA_POPULATION under the process Post Crisis BIS SFT Data Processing.

The data population remains the same as in [Standardized Approach](#).

In addition to the Product Processor tables, FSI Setup Account Modeling Information (FSI_SETUP_ACCT_MODELING_INFO) is used for providing the input required for the Capital charge calculation, and which are based on the bank's specific models. Some of the attributes picked up from this table are PD, LGD in the case of AIRB approach, Effective Maturity, CCF Own Estimate (in the case of AIRB approach) etc.

10.2.2.3 Shareholding Percent Multiplication

The shareholding percent multiplication for the various amounts associated with the exposure remains the same as in [Standardized Approach](#).

This is handled as part of the sub process Common Data Processing under BIS Common Data Processing

10.2.2.4 Common Reclassification Rules

The reclassification rules are consistently the same across all the approaches of the calculations. This is same as in [Standardized Approach](#).

This is handled as part of the sub process COMMON_RECLASSIFICATION under Common Data Processing process.

10.2.2.5 Asset Reclassification Rules

The asset reclassification is based on the various combinations of the Basel product type and the standard counterparty type and any other filters as relevant. This remains functionally the same as in [Standardized Approach](#).

This is handled in sub process Post Crisis SFT Reclassification - IRB under the process Post Crisis SFT Data Processing - FIRBor Post Crisis SFT Data Processing - AIRB

10.2.2.6 Pre-mitigation Calculations

10.2.2.6.1 Exposure at Default Amount Calculation

Pre-mitigation Exposure at Default can be calculated using one of the two approaches of EAD – VaR Approach and Comprehensive Approach. This is based on run management selection.

10.2.2.6.2 Calculation of EAD – Comprehensive Approach

This is same as detailed in the [Standardized Approach](#). This is applicable for all SFT exposures.

This is handled in the process Post Crisis SFT Exposure and Placed Collateral Processing - FIRB for FIRB or Post Crisis SFT Exposure and Placed Collateral Processing - AIRB for AIRB.

10.2.2.6.3 Calculation of EAD - VaR Method

For the Calculation of EAD under VaR Method, if the exposure is part of the netting set level, then the EAD will be based on the effective exposure amount of the netted pool i.e. aggregated at the counterparty level.

This is handled as part of the SFT_NETTING_CALCULATION and if the exposure is other than the netting set the EAD will be on the effective exposure amount of each exposure level.

This is part of the process Post Crisis SFT Exposure and Placed Collateral Processing – FIRB or Post Crisis SFT Exposure and Placed Collateral Processing - AIRB if the exposures are not part of netting agreement.

10.2.2.6.4 Capital Charge Rules

In the case of IRB Approach, the Capital charge is being computed for both unexpected loss as well as Expected loss.

1. Unexpected Loss Calculations

Unexpected Loss is calculated as using the Probability of Default (PD), Loss Given Default (LGD), Effective Maturity (M) and Correlation Factor.

This is handled in the sub-process

For FIRB - in the process SFT_CAPITAL_CALCULATION_FIRB

For AIRB - in the process SFT_CAPITAL_CALCULATION_AIRB.

The capital charge rules are applicable if the comprehensive approach is selected and the same is handled in the sub process Post Crisis SFT Exposure and Placed Collateral Processing - FIRB or Post Crisis SFT Exposure and Placed Collateral Processing - AIRB and in case of the VaR approach the application handles in different way under the sub process SFT_PROCESSING_INTERNAL_MODEL_METHOD.

The LGD calculation will be applicable for the both the Comprehensive and VaR approaches.

But the PD, Effective Maturity calculations and Asset value co relation calculations are applicable only under Comprehensive approach.

a. PD Calculations

Probability of Default (PD) signifies the likelihood of a borrower failing to meet his/her financial obligations. In both FIRB and AIRB, PD values are expected as input/download from the bank. This gets captured as part of the data population process.

There are certain flooring requirements and capping requirements which are specified for each of the asset class.

This gets handled in the sub process as below:

For FIRB - In the sub-process Post Crisis SFT PD LGD Assignment - FIRB in the process Post Crisis SFT Data Processing - FIRB.

For AIRB - In the sub-process Post Crisis SFT PD LGD Assignment - AIRB in the process Post Crisis SFT Data Processing - AIRB.

b. LGD Calculations

Loss Given Default (LGD) signifies the portion of the exposure that is likely to be lost in case the borrower defaults. In FIRB, LGD is computed by the application, as per the regulatory ask for each of the asset class. And in the case of AIRB, LGD is also expected as a download.

All PD and LGD calculations are handled in the process as below:

For FIRB - In the sub-process Post Crisis SFT PD LGD Assignment - FIRB in the process Post Crisis SFT Data Processing - FIRB.

For AIRB - In the sub-process Post Crisis SFT PD LGD Assignment - AIRB in the process Post Crisis SFT Data Processing - AIRB.

In case if the VaR approach is selected under the run management selection the LGD assignment is handled as part of the sub process SFT_PROCESSING_INTERNAL_MODEL_METHOD.

c. Effective Maturity Calculations

Effective maturity (M) will be 2.5 years for exposures to which the bank applies the foundation approach, except for repo-style transactions where the effective maturity is 6 months (ie M=0.5). And in the case of AIRB, this is also expected to be provided by the bank using the modeling requirement.

The effective maturity (M) is subject to a floor of one year and a cap of 5 years

All maturity calculation are handled

For FIRB - In the sub-process SFT_MATURITY_ASSIGNMENT_FIRB in the process Post Crisis SFT Data Processing - FIRB.

For AIRB - In the sub-process SFT_MATURITY_ASSIGNMENT_AIRB in the process Post Crisis SFT Data Processing - AIRB.

d. Correlation Calculations

The correlation is being computed as per the requirement provided by the regulator by using all the inputs of PD, LGD, EAD and Effective Maturity.

As per the regulatory ask, the application assigns the multiplier of 1.25 to the Asset Value Correlation (AVC) of exposures wherever relevant. These exposures relate to regulated financial firms with assets of at least 100 billion USD and to exposures of unregulated financial firms (regardless of size). This gets consumed in the correlation formulae applicable for the asset classes specific calculation, as specified by the regulator.

For FIRB - In the sub-process SFT_CAPITAL_CALCULATION_FIRB in the process Post Crisis SFT Data Processing - FIRB.

For AIRB - In the sub-process SFT_CAPITAL_CALCULATION_AIRB in the process Post Crisis SFT Data Processing - AIRB.

e. Capital Charge Calculations

The capital charge for the unexpected loss is computed using the regulatory provided calculation specific for the asset classes. This gets handled in the process as below:

For FIRB - In the sub-process SFT_CAPITAL_CALCULATION_FIRB in the process Post Crisis SFT Data Processing - FIRB.

For AIRB - In the sub-process SFT_CAPITAL_CALCULATION_AIRB in the process Post Crisis SFT Data Processing - AIRB.

2. Expected Loss calculation

Expected loss is the loss which the bank expects it will incur during the course of holding the exposure. This is mostly computed by using the attributes of PD, LGD and EAD

This is calculated as the product of PD, LGD and EAD. This is applicable for most of the asset classes.

This is handled in the sub-process Post Crisis SFT Risk Weighted Asset Calculation - IRB.

10.2.2.6.5 RWA Calculations

IRB approaches calculate RWA for unexpected loss (SFT Pre-Mitigation RWA – UL) as well as pre mitigation RWA expected loss (SFT Pre-Mitigation RWA – EL).

All these sub-processes can be found in the below process:

- For FIRB - In the process Post Crisis SFT Risk Weighted Asset Calculation – IRB.
- For AIRB - In the process Post Crisis SFT Risk Weighted Asset Calculation – IRB.

10.2.3 Pooling and Optimizer

10.2.3.1 Pooling

Pooling is one of the pre-requisites for the optimized allocation of the exposures.

Pooling pulls out an exposure, and identifies all the relevant mitigants mapped to it, and the corresponding exposures mapped to these mitigants, and again the corresponding newer mitigants mapped to these exposures. This pooling assigns the cardinality to the exposures based on the mitigant combination.

This happens in the FSI Cap Sub Exposures (FSI_CAP_SUB_EXPOSURES), and the pooling is part of the sub process

The relevant cardinalities that get assigned to the exposures, as part of this pooling process are as below:

- 1-0 → One exposure not mapped to any mitigant
- 1-1 → One exposure mapped to one mitigant
- 1-N → One exposure mapped to multiple mitigants
- N-1 → Multiple exposures mapped to a single mitigant
- N-N → Multiple exposures mapped to Multiple mitigants

10.2.3.2 Optimizer

The optimizer is the process of allocation of the mitigants to the exposures, based on the different logic applicable for the various granularity. The details of this is available in the [Annexure](#).

Both Pooling and Optimizer is handled under the process CRM Sub Exposure Pooling and Optimizer Processing.

10.2.3.3 Post CRM RWA

The application computes the covered amount and the uncovered amount for the exposures. The covered amount is computed by multiplying the covered factor with the exposure amount. To this covered amount, the application assigns the mitigant risk weight. The product of the covered amount and the mitigant risk weight is the covered RWA. The uncovered amount is computed by multiplying the uncovered factor (which is 1 – sum of all covered factors for that exposure) with the exposure amount. This uncovered amount is multiplied by the exposure risk weight to get the uncovered RWA.

The sum of the covered RWA and the uncovered RWA is the Post CRM RWA of the Exposure.

$$\text{Post-CRM RWA} = \text{Covered Amount} * \text{Risk Weight of the Mitigant} \\ + \text{Uncovered Amount} * \text{Risk Weight of the Exposure}$$

10.3 Credit valuation Adjustment

Banks incurred significant CVA losses during the global financial crisis. It is therefore important that the regulatory framework mitigates this risk in a prudent and robust manner. The CVA risk framework was revised in December 2017 in part to align its design with the market risk framework published in January 2016.

Credit Valuation Adjustment is calculated at a counterparty level. CVA reflects the adjustment of default free risk prices of derivatives and SFT, due to potential default of the counterparty. Regulatory CVA can differ from Accounting CVA due to following reasons:

- Regulatory CVA excludes the default due to bank's own default
- Best practices of accounting CVA are imposed in Regulatory CVA.

CVA calculation will include all derivative transactions except those with a Qualified central counterparty (QCCP).

There are certain approaches for calculating CVA capital

- Based on CCR Capital Charge
- Basic Approach
 - Reduced Version (without considering hedges)
 - Full Version (by considering eligible hedges)
- Standardized Approach

CVA hedging instruments can be external or internal

- All external hedge that are covered transactions must be included in CVA calculation for the counterparty to hedge
- An internal CVA hedge involves two perfectly offsetting positions: one of the CVA desk and the opposite position of the trading desk.

Basic Approach CVA is used by banks unless it receives approval to use Standardized Approach CVA. Banks require supervisory approval to use Standardized Approach CVA.

10.3.1 Rating Population

The data on ratings is captured in the following rating specific tables:

- Account Rating Table (STG_ACCOUNT_RATING_DETAILS)
 - Ratings of all Credit Risk Banking Exposures are captured in this table.
- Party Rating Table (STG_PARTY_RATING_DETAILS)
 - Credit Rating for all customers and issuers are captured in this table.
- Sovereign Rating Table (STG_SOVEREIGN_RATING_DETAILS)
 - Credit Rating for all countries is captured in this table.

10.3.2 CVA Based on CCR Capital Charge

Any bank whose aggregate notional amount of non-centrally cleared derivatives is less than or equal to 100 billion euro can follow this approach of CVA capital, based on supervisory approval.

In this approach, the CVA capital is equal to 100% of the CCR capital charge.

For all CVA calculations, there must be a run management condition to check whether the supervisor allows SFT transactions also for the CVA calculations or not. Based on this, SFT will be considered for CVA or not. And the default option will be not to consider SFT.

There must be a run management to indicate whether the bank has supervisory approval to follow the CCR Capital charge.

If the option is selected, there must be a check to consider whether the total derivative exposures, excluding the cleared transactions, is less than or equal to 100 billion euro.

In case SFT exposures are considered, the Pre mitigation EAD should be included in the aggregation, excluding the cleared transactions to be checked against the Materiality Threshold value.

10.3.3 CVA Basic Approach Reduced Version

This is the default approach to be applied for all banks following CVA calculations. This is generally applicable for all the banks who have less sophisticated practice, and do not have hedges. This is also used to restrict hedging efficiency. The reduced version eliminates the element of hedging recognition from the full version.

10.3.3.1 Process Flow of CVA Basic Approach Reduced Version

The process flow of Basic Approach reduced Version CVA is explained below:

Figure 94: Process Flow for Basic Approach Reduced Version CVA

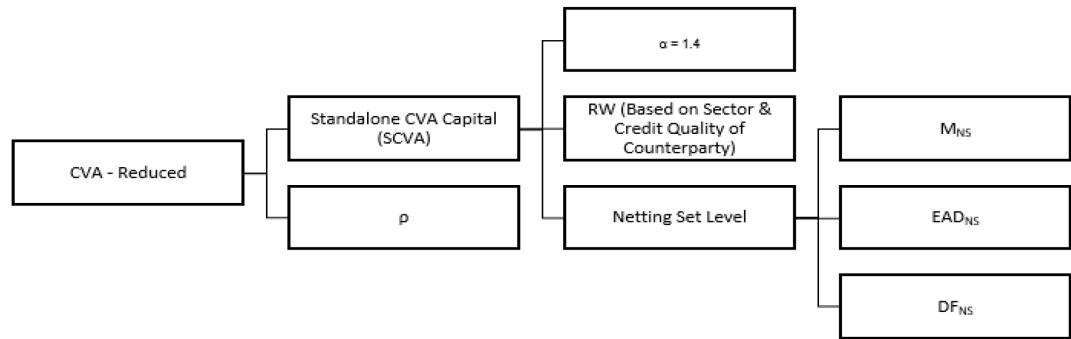

The capital requirements for CVA risk under the reduced version of the BA-CVA (DSBA-CVA × K reduced, where the discount scalar DSBA-CVA = 0.65) are calculated as follows (where the summations are taken over all counterparties that are within scope of the CVA charge)

- SCVA_c is the CVA capital requirement that counterparty c would receive if considered on a stand-alone basis
- It is the supervisory correlation parameter. Its square, ρ=25%, represents the correlation between credit spreads of any two counterparties. In the formula below, the effect of ρ is to recognize the fact that the CVA risk to which a bank is exposed is less than the sum of the CVA risk for each counterparty, given that the credit spreads of counterparties are typically not perfectly correlated.
- The first term under the square root in the formula below aggregates the systematic components of CVA risk, and the second term under the square root aggregates the idiosyncratic components of CVA risk

$$K_{reduced} = \sqrt{\left(\rho \cdot \sum_c SCVA_c\right)^2 + (1 - \rho^2) \cdot \sum_c SCVA_c^2}$$

The stand-alone CVA capital requirements for counterparty c that are used in the formula is calculated as follows

- RW_c is the risk weight for counterparty c that reflects the volatility of its credit spread. These risk weights are based on a combination of sector and credit quality of the counterparty

Sector of counterparty	Credit quality of counterparty	
	IG	HY and NR
Sovereigns including central banks and multilateral development banks	0.5%	2.0%
Local government, government-backed non-financials, education and public administration	1.0%	4.0%
Financials including government-backed financials	5.0%	12.0%
Basic materials, energy, industrials, agriculture, manufacturing, mining and quarrying	3.0%	7.0%
Consumer goods and services, transportation and storage, administrative and support service activities	3.0%	8.5%
Technology, telecommunications	2.0%	5.5%
Health care, utilities, professional and technical activities	1.5%	5.0%
Other sector	5.0%	12.0%

The risk weight used for the calculation of the standalone CVA capital charge is based on the sector of the counterparty, and the rating of the party. For sector, we need to check on usage in FRTB. If not, the below mentioned method to identify sector is fine.

Sector of the counterparty will be given as V_INDUSTRY_CODE in STG_PARTY_MASTER.

This will get reclassified to Regulatory Industry Code (DIM_REG_INDUSTRY). CVA risk weighting will be based on Regulatory Industry Code.

The sector of the counterparty will be based on either the industry code or the standard party type

In the case of jurisdictions following ECRA, the Investment grade will be assigned to any rating which is greater than or equal to BBB-. And any rating below that, will be considered as high yield, and unrated will be treated as unrated. This has to be updated using Rating categories, instead of Ratings.

In the case of jurisdictions following SCRA, based on supervisory approval, the bank can map its internal rating to the investment grade and high yield/ unrated. Else, the risk weighting will consider only the parties as unrated, and accordingly assign the risk weight.

In the case of identifying the sectors, the party's industry code, and from that, the industry type can be used. This will be the basis on which the risk weighting will happen.

- The effective maturity will be taken as the max (1 year, calculated effective maturity). Effective Maturity will come as a download.
 - The effective maturity is taken as the weighted average effective maturity, based on the notional amount of derivatives
 - The effective maturity is taken as the weighted average effective maturity, based on the notional amount of SFT
- EAD_{NS} is the exposure at default (EAD) of the netting set NS, calculated in the same way as the bank calculates it for minimum capital requirements for CCR. Here EAD calculated as part of SAACR will be consumed.
- The supervisory discount factor is 1 for banks following IMM approach, and the below formulae when it is using SA-CCR approach. Effective Maturity is consumed in the Discount factor calculation.

$$DF_{NS} = \frac{1 - e^{(-0.05 * M_{NS})}}{0.05 * M_{NS}}$$

- Stand-alone CVA is calculated as follows:

$$SCVA_c = \frac{1}{\alpha} * RW_c * \sum_{NS} (M_{NS} * EAD_{NS} * DF_{NS})$$

Alpha=1.4

The final calculations are given below:

$$K_{BA-CVA} = DS_{BA-CVA} * K_{reduced}$$

DS_{BA-CVA} = Discount Scalar for Reduced Version of BA CVA = 0.65

$$K_{reduced} = \sqrt{(\text{Systemic Component}) + (\text{Idiosyncratic Component})}$$

$$K_{reduced} = \sqrt{[\rho * \sum_c SCVA_c]^2 + (1 - \rho^2) * \sum_c (SCVA_c)^2}$$

$SCVA_c$ = CVA Capital Requirement of Counterparty C

ρ = Supervisory Correlation Parameter = 50%

The risk-weighted assets for credit value adjustment risk are determined by multiplying the capital requirements calculated by 12.5.

$$RWA_{BA-CVA} = 12.5 * K_{BA-CVA}$$

10.3.3.2 Key Data Elements

Key data elements are provided in this section for computation for Credit Valuation Adjustment

- Effective Maturity
- EAD at netting set Level
- RW of counterparty eligible for CVA

10.3.3.3 Out of Scope

The following is not covered by the application in the computation of Credit Valuation Adjustment:

- Treatment of specific wrong way risk.
- Treatment of incurred CVA loss

10.4 Default Fund Contributions Related Capital Charge

A default fund contribution refers to the funds contributed, or commitments made by a clearing member to a Central Counterparty's (CCP) equalized loss sharing agreement. The purpose of such default funds is to provide capital, in addition to the collateral posted by participants and in addition to capital provided by the clearinghouse, as a safeguard against extraordinary losses that might occur in connection with.

For example, a financial crisis in the market or the simultaneous defaults of several large members. The clearing members contribute to such default funds kept with the central counterparty (clearing house) in the proportion of their exposure to the central counterparty.

The default fund contributions by the clearing members contribute toward the central counterparty's regulatory capital along with CCP's own contributions to the default fund. These contributions act as collaterals to mutually share in the losses incurred by the clearing members due to counterparty defaults.

For each clearing member, a contribution is made to the central counterparty's default fund.

This contribution acts as a relief against the defaults by any clearing member of the central counterparty.

CRR IV explains the methods that the banking organization playing the part of a clearing member of the CCP, must adopt and compute risk-weighted assets (RWA) for a non-qualifying and a qualifying CCP.

The application handles the treatment of exposures to a QCCP and a Non-QCCP. This qualified CCP flag is expected to be provided as a download in the Party Master (**STG_PARTY_MASTER**) table.

10.4.1 Capital Charge for Non-QCCP

If the CCP is not a qualified CCP (Non-QCCP), then the risk-weighted asset amount for the banking organization's default fund contribution is calculated using the Own funds requirements for pre-funded contributions to the default fund of a non-qualifying CCP approach, as suggested in the accord.

10.4.2 Capital Charge for QCCP

If the CCP is a qualified CCP (QCCP), then the RWA amount is computed using one of the following two approaches stated below. Both are handled in the same Sub process - RWA For Default Fund Contribution With QCCP. This is based on the run management option selected.

- Own funds requirements for pre-funded contributions to the default fund of a QCCP.
- Alternative calculation of own funds requirement for exposures to a QCCP.

The approach to use of either the own fund requirements for QCCP or the alternative approach of the own fund requirements for QCCP is based on the run management option.

Approach 1

For the purpose of computing the clearing member's capital requirement, which is the reporting bank's capital requirement for the contributions made to the CCP's default fund, the hypothetical capital requirement of the central counterparty for the default fund must be known. This must be computed by the central counterparty based on the exposures of all the clearing members to the default fund. After this figure is calculated by the CCP, it is shared with all the clearing members to enable them and to compute their respective capital requirements against the default fund.

When the reporting bank gets the hypothetical capital requirement from the QCCP, next step is to compute the capital requirement of the reporting bank by finding out the proportion of the reporting bank's contribution in the total default fund contribution.

- The parameters considered for this purpose include the following QCCPs:
- Net potential exposure to the two largest clearing members,
- The total net potential exposure to all the clearing members,
- Total default fund contribution by all the clearing members,
- QCCP's own contribution to the default fund, and
- The total number of clearing members for the default fund.

The last step is to compute the risk-weighted assets of the reporting bank corresponding to the default fund contribution to the QCCP by using the capital computed in the previous step.

These steps and the calculation involved are the following:

Step 1:

It requires the QCCP to calculate its hypothetical capital requirement (KCCP) for the default fund. This is done by the QCCP and is published to the clearing members for them to use for their respective capital calculations.

Step 2:

Compare KCCP with the funded portion of the default fund of a QCCP and calculate the capital requirement of the bank (KCM) by using the total of all the clearing members' capital requirements (K*CM). This capital requirement is considered on the contribution that the clearing members make to the default fund of the QCCP.

Approach 2

Capital Charge for the default fund contribution is calculated as follows:

Capital charge (Ki) = 8% * minimum (2% of Trade exposures to the QCCP + 1250% * default fund contribution to the QCCP, 20% * Trade Exposure Amount to the QCCP).

The solution also supports the treatment of a CCP stopping to calculate its own fund requirement to the CCP. The flag to indicate that the CCP has stopped calculating the own fund requirement is captured in the party table (**STG_PARTY_MASTER**). And based on the supervisory approval provided, in the run management option, the capital will be calculated using the Alternative approach. Else, it is treated as a normal Credit Risk Exposure, part of the Corporate Asset class.

The flag to indicate that the CCP has stopped calculating the capital requirement is expected as part of the Party Master Table (**STG_PARTY_MASTER**). In the case of this flag being null, it is expected that the CCP is calculating the Total Capital and normal processing of QCCP or Non-QCCP happens.

Key Data Elements

Key data elements to be noted are listed in this section. To view the complete list of tables used, see the Download Specification document in [MOS](#).

- Default fund contributions and related data are expected at Default fund – Central Counterparty level in the entity Stage Central Counterparty Details (STG_CCP_DETAILS).
- Hypothetical Capital Requirement of CCP, Maximum Net Potential Exposure of clearing member of CCP, 2nd Maximum Net Potential Exposure of clearing member of CCP, Total Net Potential Exposure of clearing member of CCP, Number of Clearing Members to the CCP, Total funded Default Fund Contribution of all clearing members to the CCP, Total unfunded Default Fund Contribution of all clearing members to the CCP and Default fund contribution of CCP from its own funds for each central counterparty level required.
- Application supports only the capital requirement of the bank (KCM) based on Funded/Unfunded default contributions from all clearing members not by Initial Margin. But data model supports place holders to capture Total Initial Margin by all clearing members to CCP and Bank's initial margin posted to CCP.

10.5 Credit RWA for Securitization

As per the revised guidelines for securitization framework, which is focused on addressing the short comes of the existing guidelines, a revised hierarchy of approaches that replaces the existing approaches have been introduced.

The application assigns the appropriate approach to the exposures, based on the criteria specified in the Revised guidelines. The application assigns any of the below approaches under securitization standardized approach:

- Sec- Internal Ratings Based Approach (SEC-IRBA) - SSFA
- Sec- External Ratings Based Approach (SEC-ERBA)
- Sec -IAA Approach
- Sec 1250% RW

Process Flows for Securitization – Revised Framework

The procedure by which the application handles the advanced approach of securitization exposures is as follows:

Figure 95: Securitization Underlying Flow

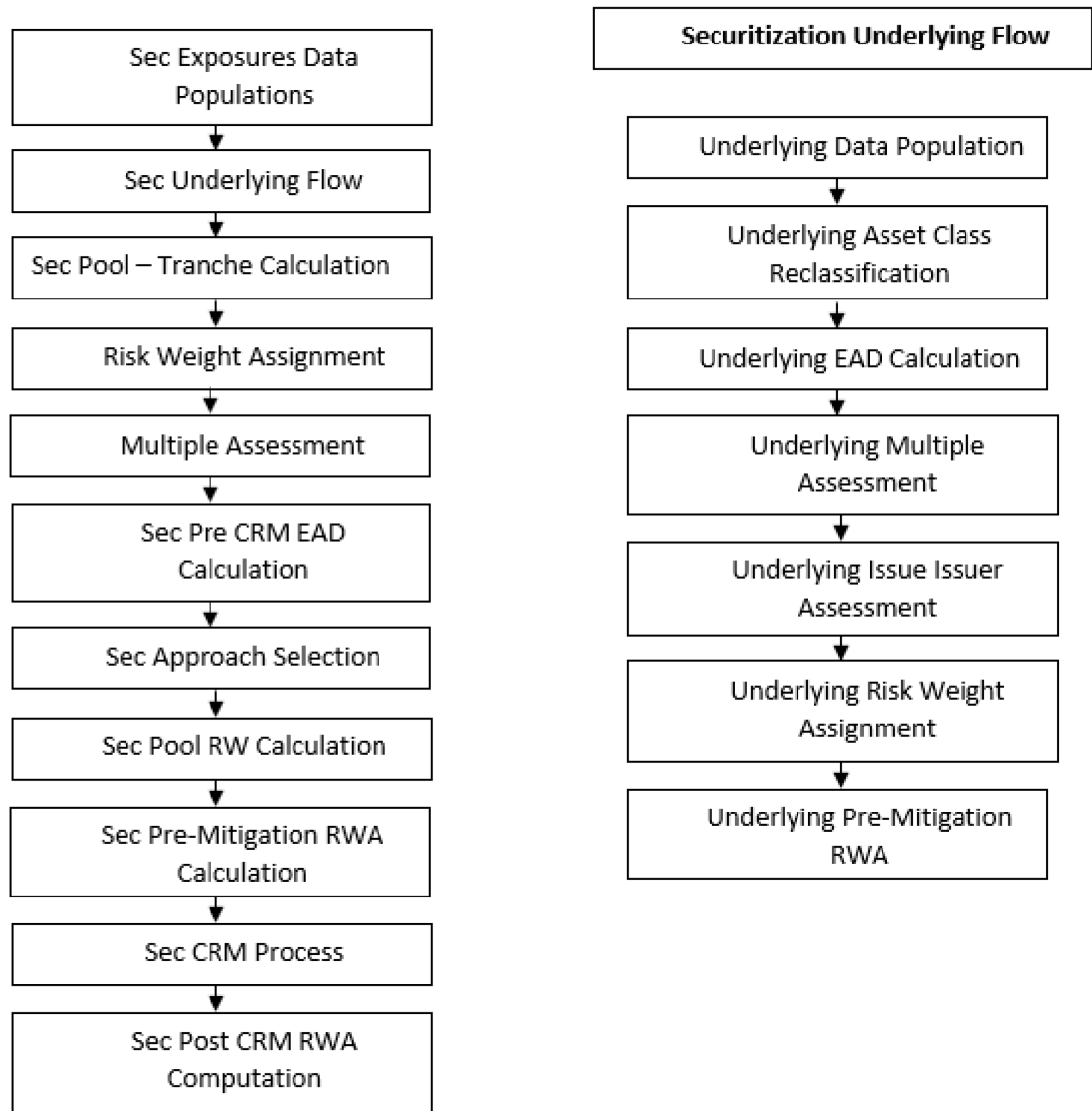

10.5.1 Data Population

Data Population is explained in detail under the [Data Population](#) of the Credit RWA for Securitization section in this document.

10.5.2 Shareholding Percent Multiplication

Shareholding Percent Multiplication is explained in detail under the [Shareholding Percent Multiplication](#) of the Credit RWA for Securitization section in this document.

10.5.3 Common Reclassification Rules

Common Reclassification Rules is explained in detail under the [Common Reclassification Rules](#) of the Credit RWA for Securitization section in this document.

10.5.4 Exposure at Default Amount Calculation

Exposure at Default process is explained in detail under the [Exposure at Default Calculation](#) of the Credit RWA for Securitization in this document.

10.5.5 Risk Weight Assignment Rules

10.5.5.1 Hierarchy of Approaches

As per the revised guidelines for securitization framework, which is focused on addressing the short comes of the existing guidelines, a revised hierarchy of approaches that replaces the existing approaches have been introduced.

The application assigns the appropriate approach to the exposures, based on the criteria specified in the Revised guidelines. The application assigns any of the three approaches under securitization:

- Sec-Internal Rating Based Approach (SEC-IRBA) – This is applicable for the exposures only if the underlying information is completely available.
- Sec-External Ratings Based Approach (SEC-ERBA) – This is based on supervisory approval and SEC 1250% is applicable.
- SEC – Internal Assessment Approach (SEC- IAA)
- SEC 1250% is applicable.

This is handled as part of the sub process SEC_APPROACH_IDENTIFICATION_AND_ASSIGNMENT under the process SEC_DATA_PROCESSING_IRB.

All the calculations happen as per the approaches are given below and they are part of the process SEC_DATA_PROCESSING_IRB

10.5.5.1.1 SEC – IRB

SEC-IRBA is the first approach to be calculated. The model that is used to calculate capital charge (KIRB) for underlying exposures using IRB is Simplified Supervisory Formula Approach (SSFA). For exposures which follow the sec-internal ratings-based approach, the application calculates the underlying weighted average capital of the securitization pool (KIRB).

The below sub process handles the KIRB calculation

SEC_KIRB_AVAILABLE_PCT_CALCULATION under the process SEC_DATA_PROCESSING_IRB

Further, the application calculates the required parameters based on the pool and tranche details. The application calculates these, using the logic specified by the accord. It also checks the exposure to identify whether the exposure must be straddled or not.

This check is based on the credit enhancement level of the tranche to which the exposure belongs to, the thickness of the tranche to which the exposure belongs to, and the underlying capital of the securitization pool. After all the parameters are calculated application computes SSFA capital and uses below mentioned

logic for risk weight computation. The exposures for which are detachment point less than that of the KIRB, the exposures are risk-weighted at 1250%. The exposures for which the credit enhancement level is more than that of the KIRB, the exposures have the SSFA capital charge computed as per the formulae suggested in the accord. The exposures for which the credit enhancement level is less than that of the KIRB, but the sum of the credit enhancement level and the tranche thickness are more than the KIRB, the exposures are straddled, and that is, the tranche to which the exposure belongs is split into a position below KIRB and a position above KIRB. All the exposures mapped to the straddled tranche are also split by the application in the same proportion as the split tranche. Post straddling risk weight is computed using the computation logic mentioned by the accord.

Once after the risk weights are assignment based on the above-mentioned process the application calculates the SEC_RISK_WEIGHT_CALCULATION under the process SEC_DATA_PROCESSING_IRB.

10.5.5.1.2 SEC – ERBA

SEC - ERBA is explained in detail under the [SEC - ERBA](#) of the Credit RWA for Securitization section in this document.

10.5.5.1.3 SEC – IAA

SEC - IAA is explained in detail under the [SEC - IAA](#) of the Credit RWA for Securitization section in this document.

10.5.5.1.4 SEC – STD

SEC - STD is explained in detail under the [SEC - STD](#) of the Credit RWA for Securitization section in this document.

10.5.5.1.5 Re-securitization Exposures

Re-securitization Exposures is explained in detail under the [Re-securitization Exposures](#) of the Credit RWA for Securitization section in this document.

This happens in the sub process RESEC_POOL_RW_CALCULATIONS under the process SEC_DATA_PROCESSING_IRB

10.5.6 Sec Pre-CRM RWA Computation

RWA Calculations is explained in detail under the [RWA Calculations](#) of the Credit RWA for Securitization section in this document.

This is handled in application under SEC_PRE_CRM_CAPITAL_CHARGE_IRB

10.5.7 Credit Risk Mitigation Process

10.5.7.1 Mitigant Eligibility

Mitigant Eligibility is explained in detail under the [Mitigant Eligibility](#) of the Credit RWA for Securitization section in this document.

10.5.7.2 Mitigant Approaches and their Risk Weighting Rules

Mitigant Approaches and their Risk weighting Rules is explained in detail under the [Mitigant Approaches and their Risk weighting Rules](#) of the Credit RWA for Securitization section in this document.

10.5.7.3 Mitigant Haircut Assignment

Mitigant Haircut Assignment is explained in detail under the [Mitigant Haircut Assignment Rules](#) of the Credit RWA for Securitization section in this document.

10.5.8 Pooling and Optimizer

10.5.8.1 Pooling

Pooling is one of the pre-requisites for the optimized allocation of the exposures.

Pooling pulls out an exposure, and identifies all the relevant mitigants mapped to it, and the corresponding exposures mapped to these mitigants, and again the corresponding newer mitigants mapped to these exposures. This pooling assigns the cardinality to the exposures based on the mitigant combination.

This happens in the FSI Cap Sub Exposures (FSI_CAP_SUB_EXPOSURES), and the pooling is part of the sub process

The relevant cardinalities that get assigned to the exposures, as part of this pooling process are as below:

- a. 1-0 → One exposure not mapped to any mitigant
- b. 1-1 → One exposure mapped to one mitigant
- c. 1-N → One exposure mapped to multiple mitigants
- d. N-1 → Multiple exposures mapped to a single mitigant
- e. N-N → Multiple exposures mapped to Multiple mitigants

10.5.8.2 Optimizer

The optimizer is the process of allocation of the mitigants to the exposures, based on the different logic applicable for the various granularity. The details of this is available in the [Annexure](#).

Both Pooling and Optimizer is handled under the process CRM Sub Exposure Pooling and Optimizer Processing.

10.5.8.3 Post CRM RWA

The application computes the covered amount and the uncovered amount for the exposures. The covered amount is computed by multiplying the covered factor with the exposure amount. To this covered amount, the application assigns the mitigant risk weight.

Post-CRM RWA = Covered Amount * Risk Weight of the Mitigant + Uncovered Amount * Risk Weight of the Exposure.

The product of the covered amount and the mitigant risk weight is the covered RWA. The uncovered amount is computed by multiplying the uncovered factor (which is 1 – sum of all covered factors for that exposure) with the exposure amount. This uncovered amount is multiplied by the exposure risk weight to get the uncovered RWA. The sum of the covered RWA and the uncovered RWA is the Post CRM RWA of the Exposure. This logic is handled in Sec Post CRM RWA calculation sub process.

10.6 Market Risk RWA

For information on Market Risk RWA, see section [Market Risk RWA](#).

10.7 Capital Structure

For information on Capital Structure, see section [Capital Structure](#).

10.7.1 Provision calculation changes specific for IRB

For IRB, the application also computes General provision, total provision, Estimated loss greater than provisions specific to IRB and excess of total eligible provision which will be part of gross T2.

And this is handled inside the sub process PROVISION_CALCULATION (PMFBISCS005) in Capital Structure Data Processing (PMFBISCS021) process.

10.8 Capital Buffer

For information on Capital Buffer, see section [Capital Buffers](#).

10.9 Large Exposures

For information on Large Exposures, see section [Large Exposures](#).

10.10 Leverage Ratio

For information on Leverage Ratio, see section [Leverage Ratio](#).

11 Account Clustering

11.1 Introduction

Banks manage different portfolios at different granularity levels. While they manage corporate portfolios at an individual account level, retail portfolios are managed at a pool or cohort level. Since the number of accounts is too high for retail portfolios, it is challenging to manage each account individually. Hence, retail loans such as education loans, auto loans, personal unsecured loans, credit cards, and mortgage loans are managed at a portfolio level. The bank further segments each portfolio into pools or cohorts. These pools are based on the risk characteristics of the customers. For example, 'safe' customers that show a low default risk behavior are categorized into a single pool or cohort, whereas 'high risk' customers that exhibit frequent payment delays are categorized into another pool or cohort. The risk management applied by the bank to these two categories of customers is different concerning account monitoring, capital calculation, and so on. The Risk-Weighted Assets (RWA) and other relevant parameters such as PD, LGD, and EAD are also calculated for each pool separately. Many banks also utilize the exposures pool to calculate the collective Expected Credit Loss (ECL) for the performing portfolio. Retail pooling allows you to create risk behavior-based pools for the effective management of customer accounts based on their risk characteristic.

Rating systems for retail exposures must be aligned to both borrower and transaction risk. It must also capture all the relevant borrowers and transaction characteristics. Banks must assign each exposure that falls within the definition of retail for IRB purposes into a particular pool. Banks must also demonstrate that the process of pooling provides the following:

- Meaningful differentiation of risk
- Grouping of sufficiently homogenous exposures
- Accurate and consistent estimation of loss characteristics at pool level

A bank must review the loss characteristics and delinquency status of each identified risk pool on an annual basis at a minimum. They must also review the status of individual borrowers within each pool to ensure that the exposures continue to be assigned to the correct pool.

11.1.1 Summary

Oracle Financial Services Retail Portfolio Risk Models and Pooling utilizes modeling techniques available in the OFSAAI Modeling framework. The product restricts itself to the following operations:

- Account Clustering Variable Management
- Variable Reduction
 - Correlation
 - Factor Analysis
- Clustering Model for Pool Creation
- Hierarchical Clustering
 - K Means Clustering
- Report Generation

- Pool Stability Report

OFSAAI Modeling Framework provides Model Fitting (Sandbox Infodom) and Model Deployment (Production Infodom). Model Fitting Logic will be deployed in Production Infodom, and the Pool Stability report is generated from Production Infodom.

11.1.2 Approaches Followed in the Product

11.1.2.1 Account Clustering Variable Management

For modeling purposes, you need to select the variables required for modeling. You can select and treat these variables in the Variable Management screen. You can select variables in the form of Measures, Hierarchy, or Business Processors. Also, as pooling cannot be done using character attributes, therefore all attributes have to be converted to numeric values.

A measure refers to the underlying column value in data and you may consider this as the direct value available for modeling. You may select hierarchy for modeling purposes. For modeling purposes, qualitative variables need to be converted to dummy variables and such dummy variables need to be used in the Model definition. Dummy variables can be created on a hierarchy.

Business Processors are used to derive any variable value. You can include such derived variables in model creation. Pooling is very sensitive to extreme values and hence extreme values could be excluded or treated. This is achieved by capping the extreme values by using the outlier detection technique. Missing raw attributes gets imputed by statistically determined value or manually given value. It is recommended to use imputed values only when the missing rate is not exceeding 10-15%.

Binning is a method of variable discretization or grouping records into 'n' groups. Continuous variables contain more information than discrete variables. However, discretization could help obtain the set of clusters faster, and hence it is easier to implement a cluster solution obtained from discrete variables. For example, Month on Books, Age of the customer, Income, Utilization, Balance, Credit Line, Fees, Payments, Delinquency, and so on, are some examples of variables that are generally treated as discrete and discontinuous.

11.1.2.2 Factor Analysis Model for Variable Reduction

Correlation

We cannot build the pooling product if there is any co-linearity between the variables used. This can be overcome by computing the co-relation matrix, and if there exists a perfect or almost perfect co-relation between any two variables, one among them needs to be dropped for factor analysis.

Factor Analysis

Factor Analysis is a widely used technique of reducing data. Factor Analysis is a statistical technique used to explain variability among observed random variables in terms of fewer unobserved random variables called factors. The observed variables are modeled as linear combinations of the factors, plus error terms. Factor Analysis using the principal components method helps in selecting variables having higher explanatory relationships.

Based on Factor Analysis output, the business user may eliminate variables from the dataset which has communalities far from 1. The choice of which variables will be dropped is subjective and is left to you. In addition to this, OFSAAI Modeling Framework also allows you to define and execute the Linear or Logistic Regression technique.

Clustering Model for Pool Creation

There could be various approaches to pool creation. Some could approach the problem by using supervised learning techniques such as Decision Tree methods to split, grow and understand homogeneity in terms of known objectives.

However, Basel mentions that pools of exposures should be homogenous in terms of their risk characteristics (determinants of underlying loss behavior or predicting loss behavior), and therefore instead of an objective method it would be better to use a non-objective approach which is the method of the natural grouping of data using risk characteristics alone.

For the natural grouping of data, clustering is done using two of the prominent techniques. Final clusters are typically arrived at after testing several models and examining their results. The variations could be based on the number of clusters, variables, and so on.

There are two methods of clustering, Hierarchical and K means. Each one of these methods has its pros and cons given the enormity of the problem. For a larger number of variables and bigger sample sizes or presence of continuous variables, K means is a superior method over Hierarchical. Further, the Hierarchical method can run into days without generating any dendrogram and hence may become unsolvable. Since the hierarchical method gives a better exploratory view of the clusters formed; it is used only to determine the initial number of clusters that you would start with to build the K means clustering solution. Nevertheless, if hierarchical does not generate any dendrogram at all, then you are left to grow K means method only.

In hierarchical cluster analysis, dendrogram graphs are used to visualize how clusters are formed. Since each observation is displayed, dendrograms are impractical when the data set is large. Also, dendrograms are too time-consuming for larger data sets. For non-hierarchical cluster algorithms a graph like a dendrogram does not exist. Here for Retail Pooling, K means modeling technique is used for account clustering. This technique is used for retail pooling as it is more efficient in comparison to Hierarchical clustering which is computation wise resource intensive.

K Means Cluster Analysis

The number of clusters is a random or manual input or based on the results of hierarchical clustering. This kind of clustering method is also called a K-means Model since the cluster centers are the means of the observations assigned to each cluster when the algorithm is Run to complete convergence. Again we will use the Euclidean distance criterion. The cluster centers are based on least-squares estimation. Iteration reduces the least-squares criterion until convergence is achieved.

Pool Stability Report

Pool Stability Report contains pool level information across all MIS dates since the pool building. It indicates the number of exposures, exposure amount, and default rate for the pool.

11.1.3 Modeling Framework Tools or Techniques used in Account Clustering

Oracle Financial Services Retail Portfolio Risk Models and Pooling, Release 8.0.0.0.0, uses modeling features available in the OFSAAI Modeling Framework. Major tools or techniques that are required for Retail Pooling are briefly described in this section. Please refer OFSAAI Modeling Framework User Manual for usage in detail.

Outlier Detection

Pooling is very sensitive to Extreme Values and hence extreme values could be excluded or treated. Records having extreme values can be excluded by applying a dataset filter. Extreme values can be treated by capping the extreme values which are beyond a certain bound. This kind of bounds can be determined statistically (using inter-quartile range) or given manually.

Outliers need to be dealt with in the data. Outliers pertain only to continuous variables and hence the outlier treatment should be done only on such variables. Outlier values cause skewness in the data and can influence the result of clustering since k-means clustering uses a distance based approach. Generally the data is capped and floored at certain values. Below is the methodology for treatment of extreme values in the variables.

Calculate Inter Quantile Range (IQR) = 75th Percentile – 25th Percentile

Upper Boundary = 75th Percentile + (IQR * 1.5)

Lower Boundary = 25th Percentile — (IQR * 1.5)

IF Variable Value > Upper Boundary THEN Variable Value = Upper Boundary

ELSE IF Variable Value < Lower Boundary THEN Variable Value = Lower Boundary

ELSE Variable Value

Missing Value

Missing value in a variable need to be impute with suitable values depending on other data values in the variable. Imputation can be done by manually specifying the value with which it needs to be imputed or by using the mean for the variables created from numeric attributes or Mode for variables created from qualitative attributes. If it gets replaced by mean or mode, it is recommended to use outlier treatment before applying missing value. Also, it is recommended that Imputation should only be done when the missing rate does not exceed 10-15%.

Outliers need to be dealt with in the data. Outliers pertain only to continuous variables and hence the outlier treatment should be done only on such variables. Outlier values cause skewness in the data and can influence the result of clustering since k-means clustering uses a distance-based approach.

Generally, the data is capped and floored at certain values. Below is the methodology for treatment of extreme values in the variables.

Calculate Inter Quantile Range (IQR) = 75th Percentile – 25th Percentile

Upper Boundary = 75th Percentile + (IQR * 1.5)

Lower Boundary = 25th Percentile — (IQR * 1.5)

IF Variable Value > Upper Boundary THEN Variable Value = Upper Boundary

ELSE IF Variable Value < Lower Boundary THEN Variable Value = Lower Boundary

ELSE Variable Value

Binning

Binning is the method of variable discretization whereby continuous variable can be discredited and each group contains a set of values falling under specified bracket. Binning could be Equi-width, Equi-

frequency or manual binning. The number of bins required for each variable can be decided by the business user. For each group created above, you could consider the mean value for that group and call them as bins or the bin values.

Correlation

Correlation technique helps identify the correlated variable. Perfect or almost perfect correlated variables can be identified, and the business user can remove either of such variables for factor analysis to effectively run on remaining set of variables

Factor Analysis

Factor analysis is a statistical technique used to explain variability among observed random variables in terms of fewer unobserved random variables called factors. The observed variables are modeled as linear combinations of the factors, plus error terms. From the output of factor analysis, business user can determine the variables that may yield the same result and need not be retained for further techniques.

K Means Cluster Analysis

The number of clusters is a random or manual input based on the results of hierarchical clustering. In K-Means model, the cluster centers are the means of the observations assigned to each cluster when the algorithm is run to complete convergence. The cluster centers are based on least-squares estimation and the Euclidean distance criterion is used. Iteration reduces the least-squares criterion until convergence is achieved.

11.1.4 Data Requirements

11.1.4.1 T2T Specific to Account Clustering

Table 96: T2T Specific to Account Clustering

Source Stage Tables	Target Tables
STG_CARDS	FSI_CAP_RETAIL_EXPOSURES
STG_LOAN_CONTRACT	FSI_CAP_RETAIL_EXPOSURES
STG_OD_ACCOUNTS	FSI_CAP_RETAIL_EXPOSURES

NOTE:

Detailed data requirements are described in detailed run charts of Account Clustering.

11.1.4.2 Existing Basel Data load and PMF Run Configuration

The Account Clustering data population pipeline can be search in PMF Process Modeler by entering text 'Account Clustering Data Population Run' or Process ID '**RNPMFRP001**'

Figure 97: Data Pipeline in PMF

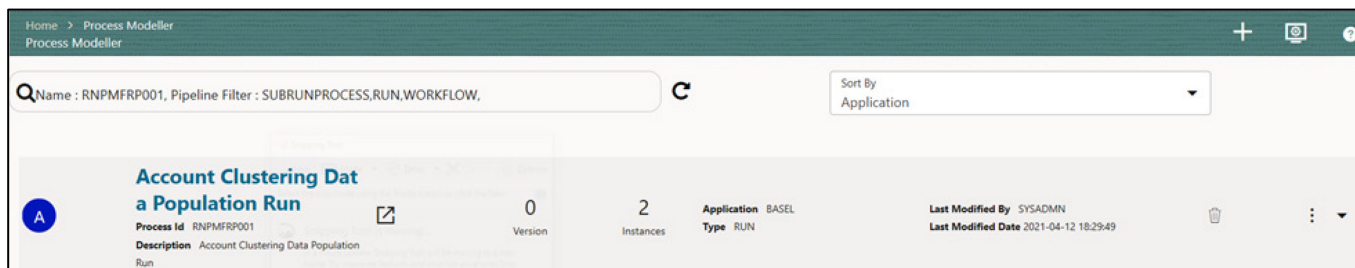

On double-clicking the above process Id, the entire data pipeline components of Account Clustering are displayed.

Figure 98: Data Pipeline Components

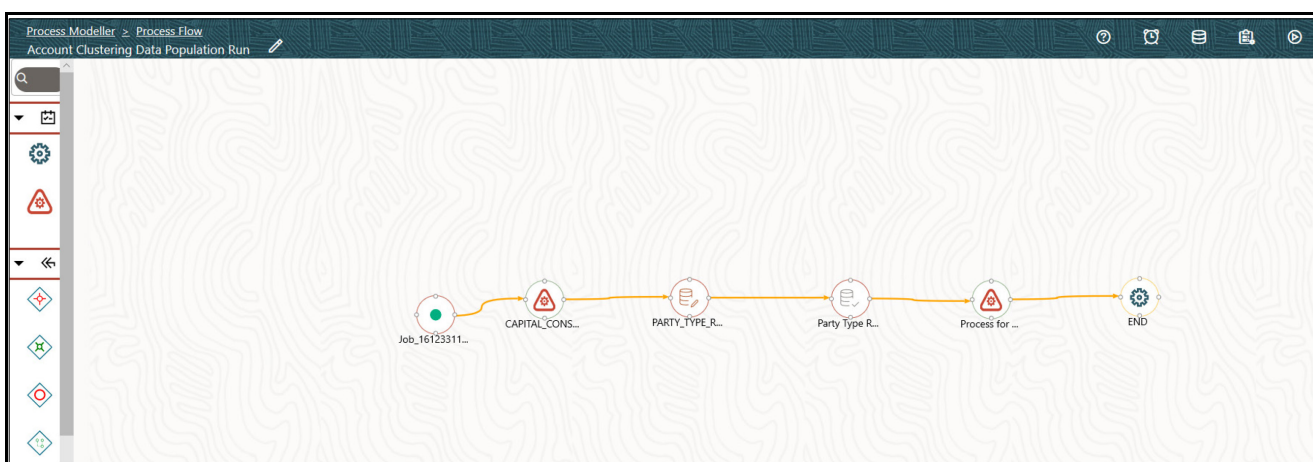
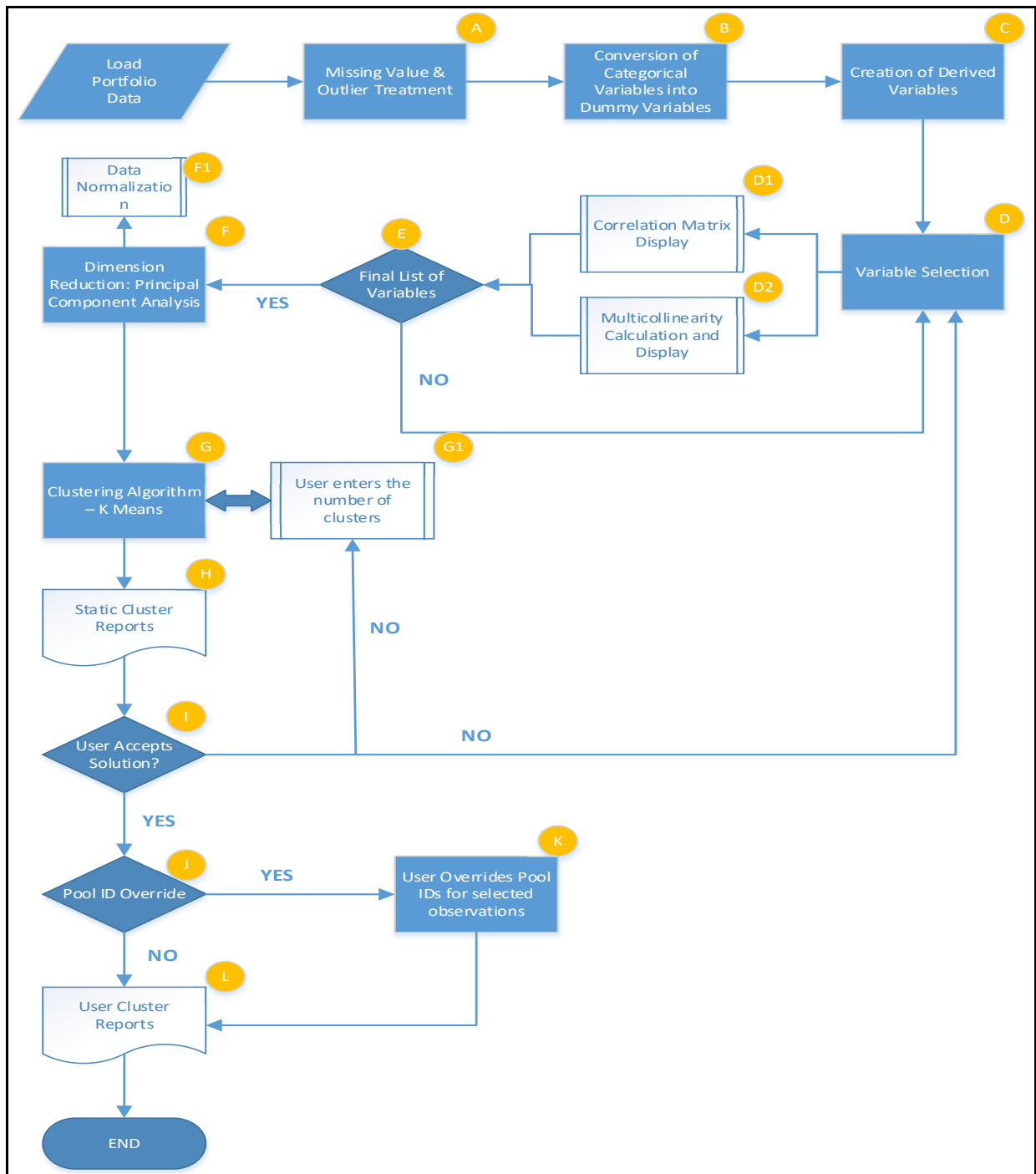

Table 99: Components of Account Clustering pipeline.

Process ID	Process Name	Pipe Line Type
RNPMFRP001	Account Clustering Data Population Run	Main Pipe Line
PMFCOM001	CAPITAL_CONSOLIDATION_AND_PARAMETER_ASSIGNMENT	Sub Pipe Line
PMFIND0249	PARTY_TYPE_RECLASSIFICATION_POPULATION_STD	Sub Pipe Line
PMFRP001	Process for Historical Data Population	Sub Pipe Line

11.1.5 Account Clustering Process Flow

Figure 100: Process Flow for Account Clustering



11.1.6 Account Clustering UI navigation for model training and execution

11.1.6.1 Creating and Training Models for Account Clustering

When you populate the historical data for retail pooling, you must first create the ML model definition for retail pooling model training.

You must perform the following steps to create a model definition:

1. Click **Financial Services Basel Regulatory Capital Internal Ratings** from your CAP application.
The **Navigation List** is displayed.
2. Click **Basel Regulatory Capital Internal Ratings Based Approach, Basel Configurations**, and then **Account Clustering**.

The **Account Clustering** summary page is displayed.

Figure 101: Account Clustering - Summary of Models

Model ID	Status	Model Name	Silhouette Co-efficient	Cluster Size	Training Date	Created By
73	Submitted	New Retail Pool Model ^{v1} New Retail Pool Model	0.76	5	2021-04-18 12:13:40.0	Yesterday by CAPUSER
12	Correlation Complete	ROSHNI TEST ^{v2}		8	2021-04-18 11:59:20.0	Yesterday by CAPUSER
72	Approved	Retail Pooling New ^{v1} Retail Pooling New	0.76	5	2021-04-18 11:33:48.0	Yesterday by CAPUSER
64	Draft	TEST_RP_4 ^{v1} TEST_RP_4		5	2021-04-18 09:46:07.0	Yesterday by CAPUSER
63	Draft	TEST_RP_3 ^{v1} TEST_RP_3		5	2021-04-18 09:36:46.0	Yesterday by CAPUSER

NOTE:

Account Clustering and Retail Pooling are the same.

3. Click **Create**.

The **New Model Definition** window is displayed which allows you to create new model definitions.

Figure 102: Retail Account Clustering Page

4. Enter a name for the account clustering model definition in the **Name** field.
5. Select the dataset from the **Dataset** field.
6. Enter values for the fields **Cluster Size**, **Co-relation Lower Bound**, and **Co-relation Upper Bound** in the **Parameters** pane.
7. Select the required variables from the **Available** list in the **Variables** pane.
The variables that you select is displayed in the **Selected** list.
8. Click **Save** and then click **Next** →.
9. Select the date for the training data selection from the **Mis Date** field and click **Calculate Correlation**.

The correlation and multi-collinearity metrics are displayed. Based on your analysis of these metrics, you can select and unselect variables on the **Variables Management** window. When you analyze the metrics, you must consider the following scenarios:

- The variables are significant only if the p value is less than 0.05.
- If the Variance Inflation Factor (VIF) is greater than 10, it indicates multicollinearity according to most research papers. But some research papers choose a more conservative threshold value of five or 2.5.

NOTE:

Ensure that you evaluate the p value and then the VIF value to decide the significance of the variables.

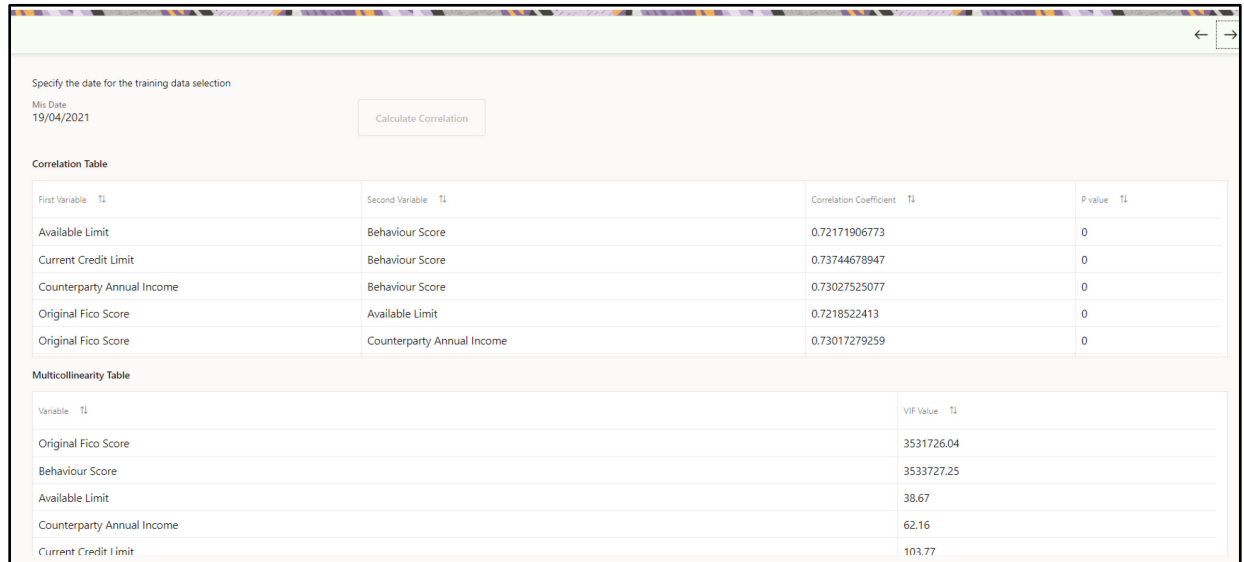
Figure 103: Training Data Selection for Account Clustering Model Definition

10. Save the metrics after you analyze the collinearity and multi-collinearity values of all the variables and their significance.

The **Variables Correlation and Multi-collinearity metrics** page is displayed.

11. Check the list of variables and click **Generate Risk Pools** to train the model.

The account clustering model is now created. The trained model metrics are generated and are displayed on the **Model Evaluation Metrics** page.

Figure 104: Model Evaluation Metrics

Figure 105: Model Evaluation Metrics

Calinski-Harabasz (CH Index)					
3502.69					
Pool Characteristics Reports					
Pool ID	Count	Percentage	Average PD	Average LGD	Average Delinquency in Days
0	100	0.4	1.54	0	11.69
1	19	0.08	0.2	0	0
2	50	0.2	4.37	0	15.78
3	50	0.2	0.16	0	0
4	31	0.12	0.18	0	0

The following model evaluation metrics is generated:

- Silhouette Coefficient
- Calinski-Harabasz (CH Index)
- Pool Characteristics Reports

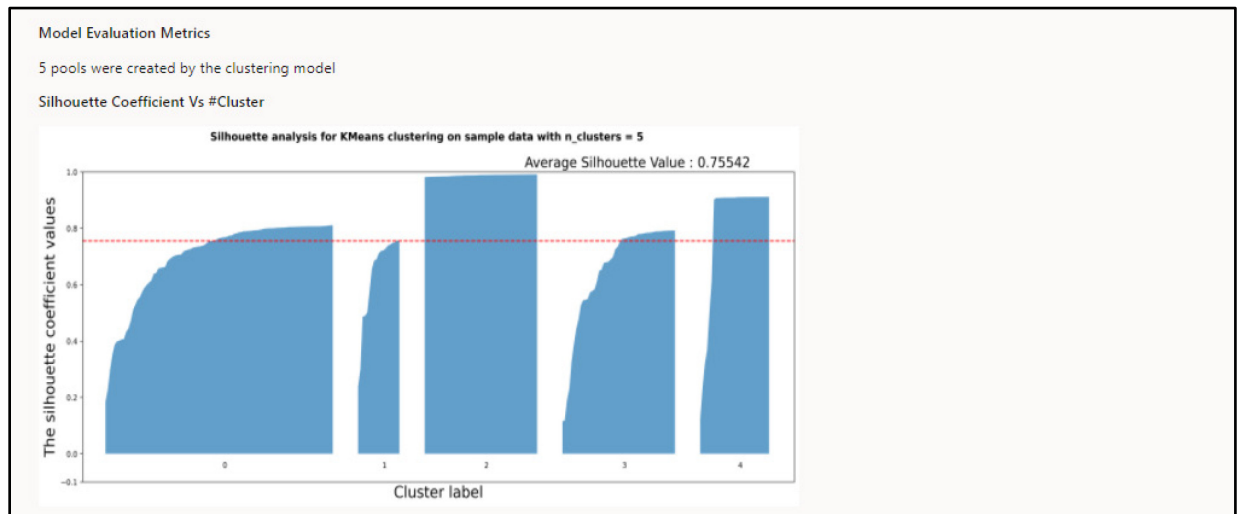
The trained model is displayed in the Account Clustering summary window and is ready for approval now.

12. Click **Menu button**  and then click **Approve** to approve the model.

An approved model appears as displayed in the following image:

Figure 106: Approved Account Clustering Model

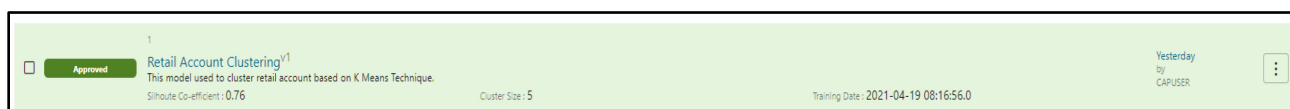

11.1.6.2 Executing the Model using PMF Framework

To execute a trained Account Clustering model, a PMF process template is available in the **Process Modeler** window.

To execute the model, you must perform the following steps:

1. Click **Basel Regulatory Capital Internal Ratings Based Approach, Process Modelling** and then **Process Modeler** from the **Navigation List**.
2. Search for **Account Clustering Model execution** by using the **Search Criteria** field and select it.

NOTE:

The process ID for **Account Clustering Model execution** is RNPMFRP002.

The process flow window for account clustering model definition is displayed.

Figure 107: Components of Account Clustering Model Definition

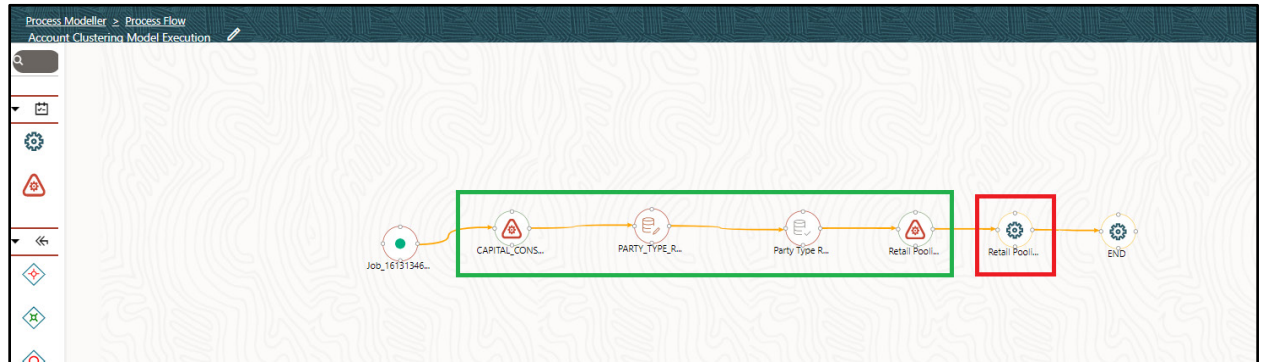

The first four service components in Account Clustering ML pipeline are data populations. These data populations are the following:

- Capital Consolidation and parameter assignment (existing Basel run)
 - Party type data population (existing Basel run)
 - Party type reclassification (existing Basel run)
 - Retail Pooling data population (specific to Account clustering run)
3. Double-click the **Retail Pooling Model Execution** service component.
The **Retail Pooling Model Execution** pop-up is displayed.

Figure 108: Retail Pooling Model Execution Pop-Up

Retail Pooling Model Execution

☑

Rule

Infodom
ECABRDINF34
▼

Execution Rule
Basel ML Model Execution Engine
🔍

Parameters +

SEL_ML_MODEL_ID	Datafield BASEL_ML_MODEL_ID Type STATIC	Value 1	🗑
SEL_ML_MODEL_VERSION	Datafield BASEL_ML_MODEL_VERSION Type STATIC	Value 1	🗑
SEL_ML_MODEL_CALCULATION_T	Datafield BASEL_ML_MODEL_CALCULATION_TYPE Type STATIC	Value ac	🗑
SEL_ML_REST_API_NAME	Datafield BASEL_ML_REST_API_NAME Type STATIC	Value execute_model_service	🗑
SEL_ML_MODEL_OPERATION	Datafield BASEL_ML_MODEL_OPERATION Type STATIC	Value PREDICT	🗑

Pre/Post Processing

Pre Rule
🔍

Post Rule
🔍

4. Configure the details of the model that you trained for Account Clustering. For more information, see [Executing an Optimizer](#).
5. Click **OK**.

The configured account-clustering model execution process is now available for execution on the **Process Modeler** window.

Figure 109: Configured Account-Clustering Model execution Process Available for Execution

Process Id	Version	Instances	Application	Type	Last Modified By	Last Modified Date
RNUPR001	0	5	Basel Retail Pooling	SUBRUNPROCESS	CAPUSER	2021-04-19 17:22:01
RNUPR002	0	3	Basel Retail Pooling	RUN	CAPUSER	2021-04-19 16:12:30
RNUPR001	0	5	Basel Retail Pooling	RUN	CAPUSER	2021-04-19 14:14:17
RNUPRCA001	0	6122	Economic Capital Advanced	SUBRUNPROCESS	CAPUSER	2021-04-15 15:04:34
RNUPRCA002	0	5	Economic Capital Advanced	RUN	SISADMIN	2021-04-12 18:48:30

6. Click **Menu Button**  and click **Execute Run**.

The **Execution** pop-up is displayed.

7. Select **With Parameters** from the **Execution Type** drop-down list.
8. Select the MIS date for which data is available in the data lake from the **Execution Date** field.
9. Click **OK** .

The model is executed, and target column **N_K_MEANS_CLUST_ID** is populated for the selected MIS DATE (**N_MIS_DATE_SKEY**) and run (**n_run_skey**).

```
SELECT * FROM FSI_CAP_RETAIL_EXPOSURES WHERE N_MIS_DATE_SKEY = <GIVEN> AND
n_run_skey in <GIVEN>;
```

12 User Interface for Reclassification And Regulatory Predefined Values

12.1 Introduction

Banks use different terminologies based on their source systems, and bank’s policies for products, or party type or any other value. This gets reclassified into Regulatory defined values and consumed by the application for meeting the regulatory compliance. This happens in the reclassification processes that are mentioned in the relevant sections, of the different approaches and portfolios. And this can also be seen in the below mentioned UI, along with a workflow to manage the changes.

Also, there are certain predefined parameters based on regulatory defined values, such as the loss threshold in the case of Operational Risk. This can also be viewed in the corresponding UI.

12.2 Regulatory Reclassification User Interface

This is a user-interface which enables the user to define the reclassification mapping between any Bank Types to its corresponding Regulatory Type. And this also allows the user to view the defined mappings. There is a summary view which gives the list of all the regulatory reclassification and the user has the option to view or edit the reclassification based on the user group access rights.

12.2.1 Summary View of the Regulatory Reclassification

This displays the list of all the regulatory reclassifications that are available in the product.

Figure 110: List of Regulatory Reclassifications

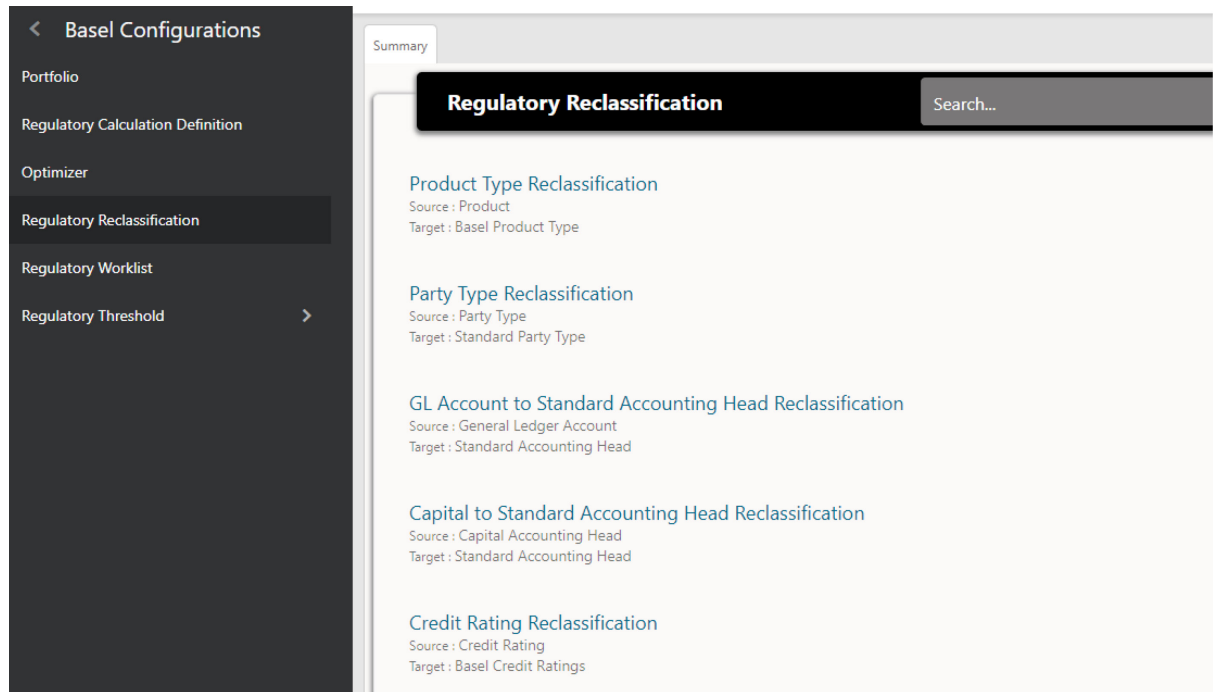

12.2.2 Reclassification View

This displays the reclassification applicable for each definition, based on what has been selected. For example, Product Type Reclassification shows the reclassification from Product Dimension to Basel Product Type Dimension, and the existing mappings can be seen.

Figure 111: List of product type reclassification

The screenshot shows the 'Product Type Reclassification' interface. On the left, there are input fields for 'Source' (Product), 'Target' (Basel Product Type), 'Jurisdiction' (Commo...), and 'Date' (04/04/2022). There are 'View' and 'Download' buttons below these fields. An 'Add' button is located above the table. The table has columns: 'Remove', 'Product', 'Basel Product Type', 'Effective From', and 'Effective Till'. The table contains the following data:

Remove	Product	Basel Product Type	Effective From	Effective Till
<input type="checkbox"/>	[PERF]Performance bond	[PERBND]Performance Bond	02/01/2022	12/31/9999
<input type="checkbox"/>	[LGS]Loan Against Gold and Silver	[LGS]Loan Against Gold and Silver	02/01/2022	12/31/9999
<input type="checkbox"/>	[LNCOM]Loan Commitment	[LNCOM]Loan Commitment	02/01/2022	12/31/9999
<input type="checkbox"/>	[DLN]Loans	[DLN]Other Loans	02/01/2022	12/31/9999
<input type="checkbox"/>	[OTHFIX]Other Fixed Assets	[OTHFIX]Other Fixed Assets	02/01/2022	12/31/9999
<input type="checkbox"/>	[BLDG]Buildings	[OTH]Others	02/01/2022	12/31/9999
<input type="checkbox"/>	[CASH]CASH	[CAB]Cash balances	02/01/2022	12/31/9999
<input type="checkbox"/>	[CCYFUT]Currency Futures	[CCYFUT]Currency Futures	02/01/2022	12/31/9999
<input type="checkbox"/>	[CCYOPT]Currency Options	[CCYOPT]Currency Options	02/01/2022	12/31/9999

At the bottom left, there are 'Edit' options: 'File Upload' and 'On-Screen Grid'. At the top right, there are 'Validate' and 'Reset' buttons. A 'Submit' button is also visible in the top right corner of the main content area.

There are different options – View the Reclassification Mappings or Edit the Reclassification Mappings.

12.2.2.1 View Reclassification Mappings

The below set of steps indicate how the user can view the reclassification mappings, that have been defined in the system.

1. Go to the Regulatory Reclassification dashboard, scroll through the list of available reclassification types and click on the desired type to open it. User can also search the type using the “Search...” box.
2. On the LHS, select the Jurisdiction and Date, and click on View button.
3. The mapping for the selected jurisdiction as effective on the selected date will be displayed on the data grid on the RHS.
4. To download the mapping displayed on the RHS data-grid, click on “Download”.

12.2.2.2 EDIT RECLASSIFICATION MAPPINGS

The below set of steps indicate how the user can edit the reclassification mappings, that have been defined in the system, or need to be newly created. This can be done by two options – using the on-screen grid, wherein the entire entries and details can be entered manually, or by using the file upload option. The on-screen grid is helpful in case of minor edits, whereas for other changes, the file upload option is helpful.

Using On-screen Grid:

1. In the “Edit” section on LHS, click on the “On-screen Grid” button.

Figure 112: On-Screen grid

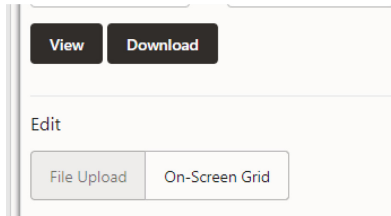

2. To add a new row in the data grid for mapping, click on the “Add” button.
3. To modify the target mapping with a new Effective Start Date for the mapping, double-click on any existing mapping.
4. To remove an existing mapping, mark the checkbox against the row.

Figure 113: Removal of existing mapping

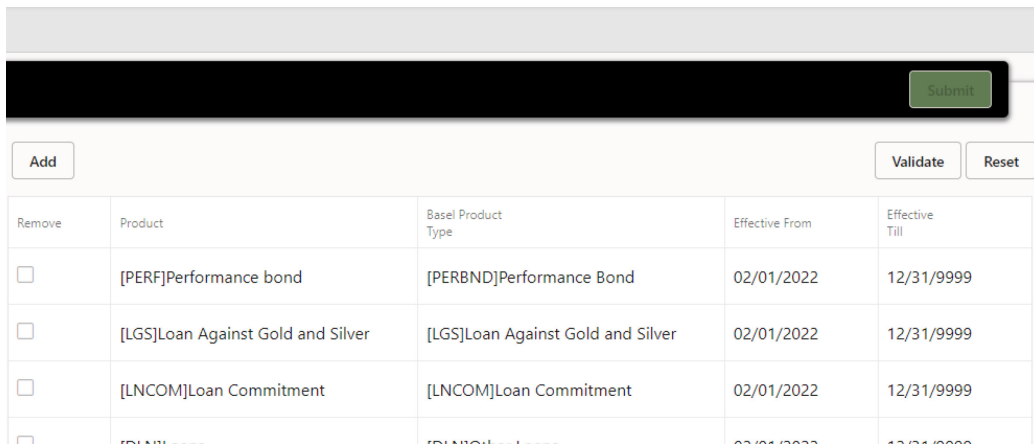

5. Click on the “Validate” button to check for any errors in the mapping after submitting the changes.
6. To clear all data modifications in the data grid, click on the “Reset” button.
7. Click on the “Submit” button on top-right corner to submit the new mapping request for approval.

Using File Upload:

1. In the “Edit” section on LHS, click on the “File Upload” button

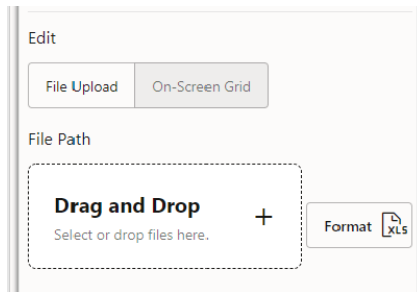
Figure 114: Using File Upload

1. Download the format and provide the Source-to-Target mapping as per the instructions in the file
2. Upload the file containing the mapping by browsing to the file location or drag-n-drop on the section.
3. Click on the “Validate” button to check for any errors once the mappings are loaded on the RHS grid.
4. To clear all data modifications in the data grid, click on the “Reset” button.
5. Click on the “Submit” button on top-right corner to submit the new mapping request for approval.

If any request for the same jurisdiction and reclassification type is pending for approval, the UI will not allow modification for the same and display the below error message.

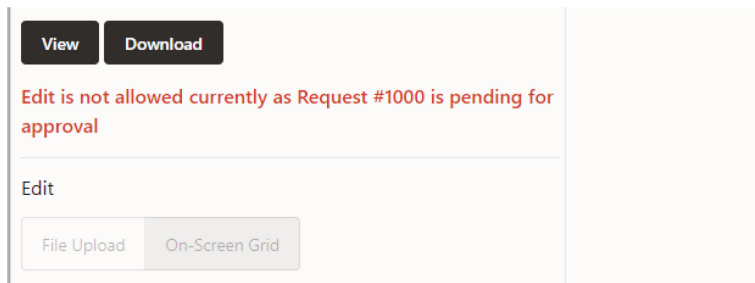
Figure 115: Error message**NOTE:**

The new reclassification is currently not integrated with any run. However, a new process BANK_TO_BASEL_RECLASSIFICATION (PMFCOM039) is provided out-of-box and can be used in the runs by replacing the existing COMMON_RECLASSIFICATION process across jurisdictions with the new process.

12.3 Regulatory Worklist User Interface

The Regulatory Worklist is a centralized location to view and approve the requests submitted for data modification via UI screens. The worklist also enables users to view the history of all data modifications.

Figure 116: Regulatory Reclassification worklist

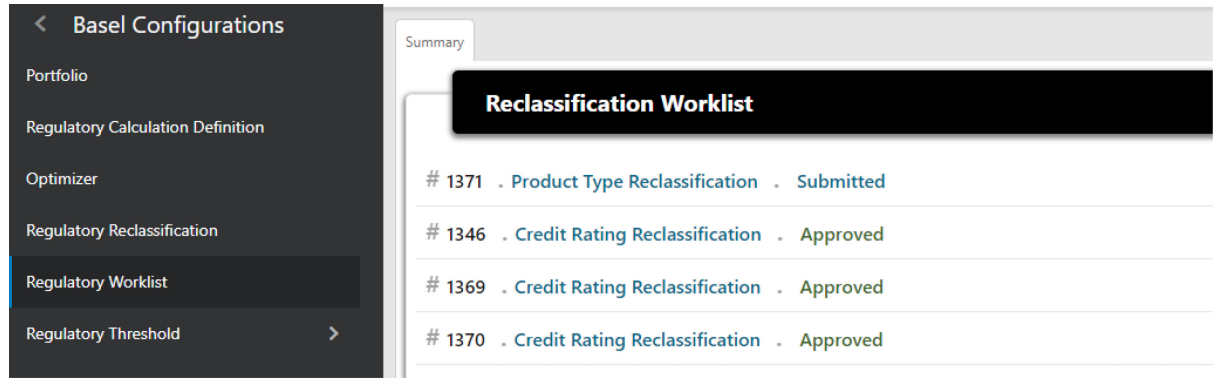

12.3.1 Review Requests

The below are the set of steps to review the list of requests that have been submitted for any of the reclassification changes.

1. Go to Regulatory Worklist and scroll through the list of requests and click on any request to open it. User can also search requests based on the below search dropdown.

Figure 117: Regulatory worklist

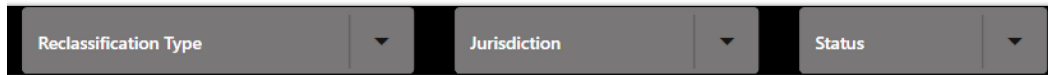

2. To view the details of any request, click on the request link.
3. To review a request with submitted status, enter appropriate comments in the “Reviewer Comments” box and click on “Approve” to approve the request or “Reject” to reject the request.

Figure 118: Comments to review request

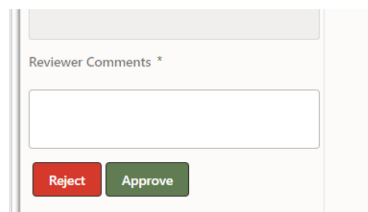

NOTE:

Only users with appropriate access can approve/reject a request. All other users can only view the details of any request.

12.4 Regulatory Threshold for Operational Risk

The threshold values for Operational Risks can be viewed and modified by using the Operational Risk UI screen under Basel Configurations. The regulator specified threshold values are predefined in the application, and the same can be viewed in the UI.

12.4.1 Summary View of the Regulatory Threshold

This displays the loss threshold values that are based on the jurisdiction to cater for the different buckets.

Figure 119: Loss threshold based on jurisdictions

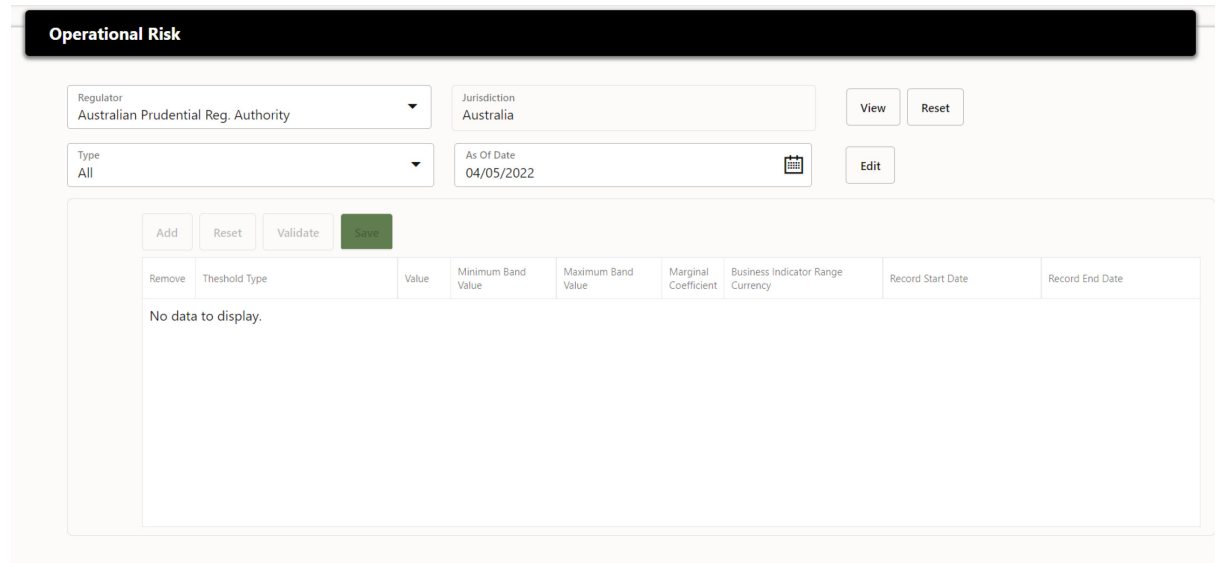

Remove	Threshold Type	Value	Minimum Band Value	Maximum Band Value	Marginal Coefficient	Business Indicator Range Currency	Record Start Date	Record End Date
No data to display.								

12.4.2 VIEW THRESHOLD VALUES

The below are the steps to view the predefined values.

1. Go to the UI: Basel Configurations → Regulatory Threshold → Operational Risk.
2. Select the desired regulator name from “Regulator” dropdown. The jurisdiction will auto-populate based on the pre-defined mapping in the application, that is based on the regulator specified values.

Figure 120: Regulator name from Regulator drop-down

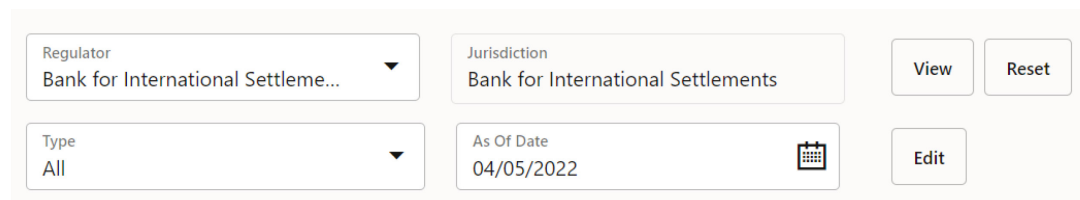

Regulator Bank for International Settlements...	Jurisdiction Bank for International Settlements	View	Reset
Type All	As Of Date 04/05/2022	Edit	

3. Click on “View” button to display the threshold values in the data-grid as effective on the “As of Date” for the Regulator/Jurisdiction.

4. To display only the specific threshold type, select the type from the “Type” dropdown and click on “View”.
5. To display the threshold values effective on any other date-period, change the date in “As of Date” field and click on “View”.
6. To reset all selections, click on the “Reset” button outside the data-grid.

12.4.3 Modify Threshold Values

The below are the steps to update the predefined values, due to regulatory changes.

1. Select the desired regulator name from “Regulator” dropdown and click on “Edit”. All the threshold values irrespective of the effective date will be displayed for the Regulator.

Figure 121: Options available for modifying threshold values

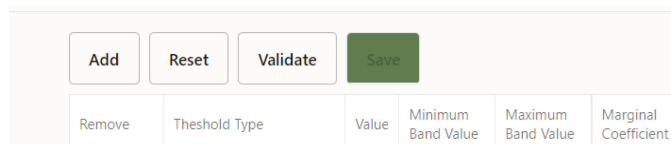

2. To add a new threshold value, click on “Add” button and enter the details.
3. To delete an existing threshold value, mark the “Remove” checkbox against the row.
4. To modify an existing threshold value,
 - a. Mark the “Remove” checkbox against the row to be modified.
 - b. Click on “Add” button and add the modified details in new row(s).

NOTE:

The screen does not allow modification of an existing row directly. Instead, the user has to mark the record for deletion and add new row(s).

5. Click on “Validate” button to check for any errors once the mappings are loaded on the RHS grid.
6. To reset all modifications, click on the “Reset” button inside the data-grid next to “Add” button.
7. After successful validation, click on the “Save” button to save the changes.

12.5 Capital Threshold Setup

View and modify the threshold values for Capital Threshold Setup using the Capital Threshold Setup UI screen under the Basel Configurations. The regulator specified threshold values are predefined in the application, and you can view the same in the UI.

12.5.1 Summary View of Capital Threshold Setup

This displays the loss threshold values that are based on the jurisdiction to cater for the different buckets.

Figure 122: Summary view of threshold based on jurisdictions

12.5.2 View Capital Threshold Setup

Perform the following steps to view the predefined values:

1. Login to the application and select Financial Services Basel Regulatory Capital Basic tile.
2. On the left pane, click Basel Regulatory Capital Basic, Basel Configurations, Regulatory Threshold, and then click Capital Threshold Setup.
3. Select the required regulator name from the **Regulator** drop-down list. The jurisdiction is auto-populated based on the pre-defined mapping in the application, that is based on the regulator specified values.

Figure 123: Regulator name from Regulator drop-down

4. Click **Standard Account Head** drop-down list to display the threshold values in the data-grid as effective on the As of Date for the Regulator/Jurisdiction.
5. To display only the specific Standard Account Head, select the type from the **Standard Account Head** drop-down list and click **View**.
6. To display the threshold values effective on any other date-period, change the date in **As of Date** field and click View.
7. To reset all selections, click the **Reset** button outside the data-grid.

12.5.3 Modify Capital Threshold Setup

Perform the following steps to update the predefined values, due to regulatory changes:

1. Select the desired regulator name from the **Regulator** drop-down list and click **Edit**. All the threshold values irrespective of the effective date is displayed for the Regulator.

Figure 124: Options available for modifying threshold values

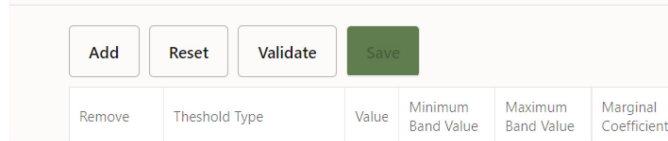

2. To add a new threshold value, click the **Add** button and enter the details.
3. To delete an existing threshold value, select the checkbox against the row in the **Remove** column.
4. To modify an existing threshold value:

- a. Select the checkbox against the row required for modification in the **Remove** column.
- b. Click **Add** button and add the modified details in new row(s).

NOTE:

The UI does not allow modification of an existing row directly. Instead, you have to mark the record for deletion and add new row(s).

5. Click **Validate** button to check for any errors once the mappings are loaded on the RHS grid.
6. To reset all modifications, click the **Reset** button inside the data-grid.
7. After successful validation, click the **Save** button to save the changes.

12.6 User Roles and Functions

The below are some of the user roles and the functions relevant for each of the above mentioned UI. This will have to be specifically added for the user group, so that the users can be given view / edit / approve permission based on their rights in the system.

Reclassification Functions:

FUNCTION	DESCRIPTION
RECLASVIEW	View Regulatory Reclassification
RECLASEDIT	Edit Regulatory Reclassification
RECLASAUTH	Authorize Regulatory Reclassification

OR Threshold Functions:

FUNCTION	DESCRIPTION
THRORVIEW	View Operational Risk Threshold
THROREDIT	Edit Operational Risk Threshold

THRORAUTH	Authorize Operational Risk Threshold
-----------	--------------------------------------

Common UI Roles:

ROLE	DESCRIPTION
CAPUIDEF	Default Role for Cap UI
CAPUISUP	Super Role for Cap UI
CAPUIADM	Admin Role for Cap UI

Function-Role Mapping:

	CAPUIDEF	CAPUISUP	CAPUIADM
RECLASVIEW	Yes	Yes	Yes
RECLASEDIT		Yes	
RECLASAUTH			Yes
THRORVIEW	Yes	Yes	Yes
THROREDIT		Yes	
THRORAUTH			Yes

13 Multiple data load for a particular date

13.1 Introduction

Banks can have a centralized system that can be populated with data points at different point of time, or the same data can be overwritten due to different needs. To cater to this requirement of the bank's needs, the product allows bank to choose the final set of data that needs to be considered for a particular calculation on a MIS Date.

This functionality allows the user to define the load id that has to be used for a single MIS Date – in essence, if there has been multiple exposures loaded at different points of time, for the same MIS Date, this allows the user to indicate which load run id to be considered for the particular exposures.

13.2 Functionality for the multiple data load

The Stage PP tables may be loaded with multiple versions of data for a date. The versioning of data within a date is maintained by Load Run ID (N_LOAD_RUN_ID) in the PP tables.

For Capital Adequacy Processing, the load run details that have to be considered for the particular MIS Date with respect to the Accounts and Credit Line is expected in the below tables.

- FSI Account Load Run Map (FSI_ACCOUNT_LOAD_RUN_MAP)
- FSI Credit Line Load Run Map (FSI_CREDIT_LINE_LOAD_RUN_MAP)

Table 125: DATA EXPECTATION for the Corresponding Tables

COLUMN	REMARKS
FIC_MIS_DATE	Snapshot Date
V_GAAP_CODE	GAAP Code associated with the Account
V_ACCOUNT_NUMBER / V_CREDIT_LINE_CODE	Unique Identifier of the Account/Exposure/Credit-Line
N_LOAD_RUN_ID	Load Run ID. The table can store multiple load run IDs of an Exposure for the same snapshot date
F_LATEST_LOAD_RUN_FLAG	Only those records which are set to Y will be processed by Basel. Only 1 Load Run ID per Exposure per Snapshot Date should be set to Y

The application will process only those records which have Latest Load Run Flag set to Y for the Snapshot Date.

For more details, please refer to “Section 13 Loading Multiple Load Runs in OFSAA” in “OFSDF Application Pack User Guide” for more details.

14 Incremental Exposure Processing

14.1 Introduction

The incremental exposure processing indicates that few additional exposures are being processed for a particular computation on a particular MIS Date.

This feature provides a faster way to process any new or modified accounts without the need of reprocessing the accounts which have not undergone any changes after the previous execution date. The incremental processing is carried out in 3 steps.

1. Delta Account Identification
2. Delta Account Processing
3. Snapshot Creation by merging with previous results

NOTE:

This feature is available for all applications. For Basel, all the configurations and results are maintained against the Basel APP ID (i.e. V_APP_ID = 'BASEL').

IDENTIFY DELTA EXPOSURES/ACCOUNTS

The Delta Accounts are identified for each unique combination of the below.

- APP ID: BASEL, this is constant for Basel application.
- FIC_MIS_DATE: The date for which Incremental processing is to be executed.
- RUN ID: PMF Run Code for which Incremental processing is to be executed. Default is -1.

The delta identification is carried out by comparing the exposure snapshot data of PP tables between two dates.

Below is the list of configuration tables for identifying delta accounts.

Table 126: Configuration table for delta accounts

TABLE NAME	REMARKS
FSI_INCR_REC_TABLE_APP_MAP	Stores the APP ID and Stage PP table name used for comparison
FSI_INCR_REC_TAB_COL_MASTER	Stores the mapping between the Source PP column and Target column for Delta Accounts
FSI_INCR_REC_ATTR_APP_MAP	Stores the APP ID and Stage PP attributes details for comparison and identification of Delta Accounts

NOTE:

The configuration details in FSI_INCR_REC_ATTR_APP_MAP table can be modified to include/exclude any attribute to be used for Delta identification. However, please note that only the attributes of the tables listed in FSI_INCR_REC_TABLE_APP_MAP can be configured.

Steps to identify delta accounts:

1. Delete the records in the below tables for the FIC_MIS_DATE, APP ID and RUN ID.
 - a. FSI_INCR_ACCOUNT_POOL_MAP
 - b. FSI_INCR_ACCOUNT_MAP
2. Trigger the “Basel Delta Account Identifier (RNDELTAEXP)” run with the below execution parameters.

Figure 127: Basel Delta Account Identifier run

Execution	
Execution Type With Parameters ▼	Reporting Date: The current reporting date for which Incremental processing is to be executed.
Application ID BASEL ▼	
Reporting Date 📅 <small>Required</small>	
Previous Reporting Date 📅 <small>Required</small>	
Run Identifier ▼ <div style="border: 1px solid #ccc; padding: 5px; margin-top: 5px;"> Default RNBISPMF002 </div>	
	Previous Reporting Date: The previous snapshot date with which the current snapshot is to be compared.
	Run Identifier: Select specific Run Code for which Incremental processing is to be executed. Select DEFAULT if the delta accounts are to be used for all Incremental runs by default.

3. The delta accounts will be stored in the FSI_INCR_ACCOUNT_MAP for the APP, RUN and DATE with the following record type indicators (F_REC_TYPE_IND)
 - a. N: New Accounts with respect to previous reporting date
 - b. M: Accounts with modified attributes with respect to previous reporting date
 - c. C: Closed Accounts with respect to previous reporting date
 - d. R: Related Accounts of the New or Modified Accounts
 - e. P: Accounts belonging to the same mitigants/collaterals pool of the New or Modified Accounts.

For any errors or information related to the run execution of the incremental processing, refer to the log file ([IncrementalEngine.log](#)) on the server path `<tomcat>/webapps/OFSCAP/logs`

INCREMENTAL RUN EXECUTION

To execute a run in incremental mode, trigger the Run with “Exposure Data” parameter as “Incremental”

Figure 128: Run with Exposure Data

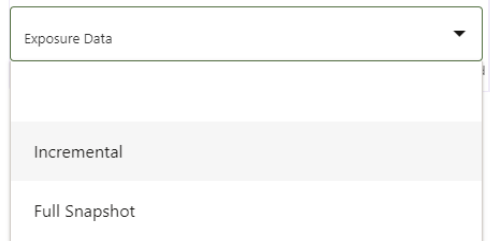

Once the incremental exposures are processed in CRM, the results will be merged with that of the latest run of the previous reporting date to create a new results snapshot.

15 Annexure A: Key Concepts

15.1 Slow Changing Dimensions

This component details how to load data from the stage tables into the slowly changing dimension tables. SCD batches are run usually at fixed intervals, for example at the end of each month. There are certain SCDs which have to be run whenever any new data is required to be added for the bank.

When the SCD batch is executed for the first time it loads all the data in the stage tables for that extraction date and it also inserts two records – Missing and Others.

When the batch is run for the next extraction date, then the new records are inserted. The end dates of the modified records are updated with the extraction date and new records with start date as the extraction records are inserted. The records that are the same for both extraction dates are left untouched.

The SCD component is delivered through an executable.

Type 1 SCD Methodology

The Type 1 methodology overwrites old data with new data, and therefore does not track changes to the data across time. For Example, consider a dimension table, DIM_PRODUCT.

Table 129: Values in the DIM_Product table

N_Product_Skey	V_Product_Name	D_Start_Date	D_End_Date	F_Latest_Record_Indicator
1	PL	5/31/2010	12/31/9999	Y

The following is a description of the column names in this table:

- N_Product_Skey is the surrogate key column which is a unique key for each record in the dimension table.
- V_Product_Name is the product name.
- D_Start_Date indicates the date from which this product record is valid.
- D_End_Date indicates the date to which this product record is valid.
- F_Latest_Record_Indicator: A value Y indicates this is the latest record in the dimension table for this product and N indicates it is not.

If the V_Product_Name column is set as a Type 1 and if there is a change in the product name from PL to Personal Loan in the earlier example in the next processing period then, when SCD is executed then the record in the earlier example is changed to:

Table 130: Values in the DIM_Product table

N_Product_Skey	V_Product_Name	D_Start_Date	D_End_Date	F_Latest_Record_Indicator
1	Personal Loan	6/30/2010	12/31/9999	Y

Type 2 SCD Methodology

The Type 2 method tracks historical data by creating multiple records for a given natural key in the dimensional tables with separate surrogate keys. With Type 2, the historical changes in dimensional data are preserved. In the earlier example, for the change in product name from 'PL' to 'Personal Loan' if history is preserved, then the V_Product_Name column is set as Type 2, that is, when SCD is processed for the processing period, it inserts a new record as shown in the following example.

Table 131: Values in the DIM_Product table

N_Product_Skey	V_Product_Name	D_Start_Date	D_End_Date	F_Latest_Record_Indicator
1	PL	5/31/2010	12/31/9999	Y
1	Personal Loan	6/30/2010	12/31/9999	Y

A new record is inserted to the product dimension table with the new product name and the latest record indicator for this is set as 'Y' indicating this is the latest record for the personal loan product and the same flag for the earlier record is set to 'N'.

Prerequisites

The setup tables accessed by the SCD component, including **SYS_TBL_MASTER**, **SYS_STG_JOIN_MASTER** have the required entries. The tables **SYS_TBL_MASTER** and **SYS_STG_JOIN_MASTER** is seeded. You must only add entries in these tables if you add user defined dimensions.

Tables used by SCD Component

The [Basel 8.1 Seeded Tables](#) Excel lists out the Stage tables and the corresponding Dimension tables that are used in the BASEL application.

No changes are needed in this table if the standard key dimensions are being used within the Basel Application. If any new dimensions are added, the related column details are to be inserted to this table manually.

STG_<dimensionname>_MASTER - is the database table which SCD uses as the source. This table comes as a part of the Data model.

DIM_<dimensionname> - is the output table to which SCD writes the dimension data.

A sequence is added for every user-defined dimension.

Example:

```
create sequence SEQ_DIM_<DIM> minvalue 1
max value 999999999999999999999999999999
increment by 1
```

Executing SCD Components

For information on the configuration and execution of SCD components, see the Operations section in the [Oracle Financial Services Analytical Applications Infrastructure 8.1 User Guide](#).

The Basel batch created for SCDs is the <infodom>_SCD. Infodom refers to the Information Domain name.

When the file is being executed you have the choice to either wait till the execution is complete or proceed with the next task. Click the list box of the field provided for Wait in the Value field and select Yes or No. Clicking Yes confirms that you wish to wait for the execution to be completed. Clicking No indicates that you wish to proceed.

Stage Data

In this section, the stage data can be populated in either the Product Processors or Other Stage tables:

- **Product Processor:** An entity in the Basel Regulatory Capital application that stores data from the Operational Systems of the Bank. This entity is created based on the various financial products that the bank caters to. Stage tables for Product Processors are categorized as exposures data of Product Processors. The Product Processors of all the jurisdictions are the same, except for the Islamic Banking Jurisdiction.
- **Others:** Data can be populated into Stage tables, besides using Product Processors, as per the respective jurisdiction.

For more information on the list of columns to be populated within each table, see the Download Specifications document.

The set of sample data to be populated for the following tables are listed in the worksheet available in the following location: [Sample Data](#).

- STG_PRODUCT_MASTER
- STG_LOB_MASTER
- STG_MITIGANT_TYPE_MASTER
- STG_PARTY_TYPE_MASTER

Seeded Data

The tables are seeded in the installation as per worksheet available in the following location: Seeded Data.

15.2 Exhibit 1 - Mitigant Allocation Optimizer

The application calculates the RWA based on the allocation of Credit Risk Mitigants (CRM) mapped to each exposure using a linear programming technique to arrive at the least capital. The optimizer engine, also known as the allocation engine, built within the application allocates Credit Risk Mitigants (CRM) to each exposure. The optimizer engine takes into consideration the following functionalities while allocating Credit Risk Mitigants (CRM) to each exposure:

There are certain checks which are specific to IRB, and the others are applicable for both Standardized approach and IRB approach.

15.2.1 FIRB Minimum Collateralization Check (IRB Approach)

As per the Basel Accord, Para 296: To apply LGD, bank has to perform Minimum Collateralization check, which includes sum of the value of CRE/RRE and Other Collaterals, to the reduced exposure (after recognizing the effect of eligible financial collateral and receivables collateral). The calculated ratio must be checked for a threshold level. If it falls below the threshold level, then the collateral becomes ineligible, and the entire exposure is assigned the unsecured LGD.

The following tasks are performed as part of Minimum Collateralization Check:

- Identification of mitigants for Minimum Collateralization Check
- Mitigant Minimum Collateralization Level assignment
- Identification of mitigants for EAD deduction for Minimum Collateralization Check

After these tasks are computed, the allocation engine allocates the CRM to each exposure. If any CRM mapped to an exposure is below the minimum threshold, allocation does not take place for that particular CRM to that exposure.

15.2.2 FIRB Over Collateralization Amount Adjustment (IRB Approach)

As per the Basel Accord, Para 296: Mitigants forming part of Receivables, CRE/RRE and Other Collateral are adjusted for the overcollateralization level, for the LGD assignment. For Over Collateralization amount adjustment, the following information is required:

Over Collateralization Adjustment Percentage

For each of the CRMs, forming a part of Receivables CRE/RRE and Other IRB Collateral, the CRM Value is adjusted by dividing the CRM Value by the Over Collateralization Adjustment percentage. The adjusted amount of collateral then participates in the allocation for computation of RWA.

15.2.3 Double Default Treatment (IRB Approach)

As per paragraph 284(i) & 284(ii): For hedged exposures to be treated within the scope of the double default framework, capital requirements can be calculated for a hedged exposure subject to the double default treatment (KDD).

Double default information is expected as an input from the institution at an Exposure Mitigants Mapping level. Generally, the identifier is at a mapping level for a mitigant types, for a Credit Derivative or a Guarantee mapped to an Exposure.

The Basel application calculates the double default capital based on the requirement specified in paragraph 284(i) & 284(ii).

The allocation engine allocates based on the double default capital as input.

15.2.4 Double Mitigant Treatment (Standardized Approach and IRB Approach)

You also have a choice to perform a Double Mitigant treatment where an exposure is covered by Collateral, a Guarantee, or a Credit derivative. The requirement in the form of a pre-configured rule at a Basel asset class level is to be specified by the institution. If you choose to perform a Double Mitigant treatment, then for a common portion of the exposure covered by both the mitigants, LGD of the Collateral, and PD of the Guarantee or Credit derivative is used. For the remainder, either the exposure is uncovered or any other mitigant if mapped to that exposure gets allocated. For Basel calculations, if use of Double Mitigant treatment results in a lesser RWA for an exposure, than use of a single mitigant, the allocation logic allocates the mitigant based on Double Mitigant treatment or else the allocation continues as a case for normal mitigants.

15.2.5 Allocation of Mitigants (IRB Approach and Standardized Approach)

The following are the steps for credit risk mitigation irrespective of the approach prescribed in the Basel Accord.

- The mitigant is identified as eligible or not based on the eligibility rules for CRM under simple and comprehensive approach mentioned in Basel accord. This mitigant eligibility is handled in the FCT_MITIGANTS, and EXP_MITIGANT_MAPPING table.
- All mitigants which are eligible and mapped to an exposure are then populated to the processing table where each exposure is broken down by mitigant types, which includes an additional row treating the exposure as uncovered. This is handled in the FCT_SUB_EXPOSURES table.
- Further, RW assignment or Capital computation is performed for each Collateral or Mitigant. For financial collateral, under the BIS Standardized Approach, the RW used is 0. For FIRB approach the LGD used is the LGD* computed as per the Basel guideline. For any other mitigants in the form of Guarantees or Credit Derivative, the RW or PD corresponding to Basel rating or the modeling, as applicable, is used. For Advanced Approach, institutions must give the PD or LGD data either at a mitigant level or at an exposure level, if they are able to model the PD or LGD of the exposure.
- The Pooling is performed to identify the below cases.
 - One or Many Exposures to One Mitigant
 - One Exposures to Many Mitigants
 - Many Exposures to Many Mitigants
 - One Exposure with No Mitigant

The pooling of the exposures and the mitigants are based on the exposures mapped to the mitigants, and the same mitigant mapped to other exposures. For example, in the below exposure ID and the mitigant ID mapped to each other, all of them belong to the same pool ID, as they have the mitigants shared.

Table 132: Pooling of exposure to mitigant ID

Exposure ID	Mitigant ID
EXP01	MIT01
EXP01	MIT02
EXP01	MIT03
EXP02	MIT01
EXP03	MIT04
EXO04	MIT04
EXP05	MIT05

The treatment of each of the pooled cases in the optimizer engine is detailed in the following section.

One or Many Exposures to One Mitigant

The case, one or many exposures to one mitigant is treated as follows by the optimizer engine:

- First, the exposures are sorted from highest risk weight to lowest. For advanced approach the sorting is based on the capital.
- EAD amount of each exposure (post credit conversion) is determined.
- The credit risk mitigant is allocated to the exposure with the highest risk weight.
- If there is more than one exposure with the same risk weight, then the exposure with the lowest currency mismatch haircut or maturity mismatch haircut is selected for allocation. In the case of Simple Approach, these haircuts will not be applicable, and hence, the volatility haircut and the currency mismatch haircut will be considered as 0, and the maturity mismatch haircut will be considered as 1.
- Currency haircut (Hfx) is applied to the collateral if there is a currency mismatch between the exposure and collateral. Likewise, for mitigants residual maturity falling short of exposure residual maturity a maturity mismatch haircut (Hm) is applied. These haircuts are assigned based on the Basel guideline.
- The post-haircut mitigant amount is applied to the exposure based on the previous logic. The allocation engine updates the covered factor against each row for all the exposures in a pool. For any exposure the sum of covered factor across rows is equal to 1.
- Finally, the pre-mitigation EAD is broken into post-mitigation EAD net of all haircuts
- Basel rules then calculate the RWA for each row by multiplying the post-mitigation EAD by the RW or capital * 12.5 (in case of advanced approach).

Any remaining collateral amount is applied to the next transaction with the next highest risk weight and so on.

One Exposure to Many Mitigants

The case, one exposure to many mitigants is treated as follows by the optimizer engine:

- First, the EAD amount of each exposure (post credit conversion) is determined.
- The mitigant is sorted from lowest to the highest risk weight for each exposure mapped to it.
- Each mitigant forming a part of Receivables, CRE/RRE, and Other IRB Collateral is adjusted for over collateralization amount while executing foundation IRB.
- In the Foundation IRB approach, Minimum collateralization check is performed for mitigants in the form of CRE/RRE and other eligible IRB Collateral by grouping the mitigant data in the numerator divided by the available EAD amount, minus any allocated mitigant amount.
 - Financial collaterals are allocated first, and then the minimum collateralization check is performed for the other type of mitigants.
 - The result checks whether it is greater than the percentages specified in the Basel Accord.
 - If the result value is less than the check value, none of the CRE or RRE or Other eligible IRB Collaterals mapped to the exposure is eligible for allocation.
 - This check is done only once for the mitigant mapped to each exposure.
- After all the checks are done then the computation starts by calculating the covered factor for the first row which is as follows:

$$f1 = (\text{Mitigant_value} * \text{Haircut}) / \text{EAD}$$

Where:

$$\text{Haircut} = (1 - \text{volatilityHaircut} - \text{FOREXHaircut}) * \text{MaturityMismatchHaircut}$$

The haircut related to volatility, currency mismatch and maturity mismatch are as mentioned in the One or Many Exposures to One Mitigant section.

- Then, the allocation logic works out the covered factor for the subsequent rows as follows:

$$f(n) = \text{Min} ((1 - \text{Already allocated covered factor}), \text{Max} (fn-1, 0))$$

- Total covered factor for an exposure = Covered Factor for the 1st Row + Covered Factor for all the subsequent rows.
- Covered Factor is Sum of all Covered amount + Uncovered amount of the mitigant upon its total EAD. For any exposure the sum of covered factor across rows is equal to 1.

Many Exposures to Many Mitigants

In the case, many exposures to many mitigants the Optimizer uses a linear programming technique for which you must define the objective functions and a set of constraints for the variables. The objective function and the constraints in the Optimizer are defined as follows:

- Objective Function: Objective Function for CRM is to Minimize RWA
- Bounds for the output:
 - Lower Bound of Covered factor is 0
 - Upper Bound of Covered factor is 1
- Exposure Constraint: Exposure Constraint checks the sum of all the allocated exposure amounts must be equal to the total exposure amount available for allocation:

$$(E1 * x1) + (E1 * x2) + (E1 * x3) + (E1 * x4) = E1$$

Where,

E1= Exposure amount

X(n)=Allocation percentages (sum of x1.....xn = 1, meaning 100%)

- Mitigant Constraint: Mitigant constraint has two objectives as follows:
 - This Constraint checks whether the total amount of mitigant is used is less than or equal to the total amount of mitigant available
 - All the mitigant haircuts are applied in this Constraint.

The formula is as follows:

$$[\{ E1 * x1 \} / \{ (1 - V - Fx1) * (Mm1) \}] + [\{ E2 * x2 \} / \{ (1 - V - Fx2) * (Mm2) \}] + [\{ E3 * x3 \} / \{ (1 - V - Fx3) * (Mm3) \}] \leq M1$$

The Mitigant Constraint Formula table is provided below:

Table 133: Mitigant Constraint

Exposure Amount	E1	E2	E3
Mitigant Amount	M1	M1	M1
Volatility Haircut	V	V	V
FOREX Haircut	Fx1	Fx2	Fx3
Maturity Mismatch	Mm1	Mm2	Mm3
Covered Factor	x1	x2	x3

- Minimum Collateralization Constraints are as follows:
 - Mitigants grouped for Deduction for Minimum Collateralization Check > 0
 - Mitigants grouped for Minimum Collateralization Check < 0
- Double Mitigant Constraint: Double Mitigant Constraint is similar to Mitigant Constraint the only difference being that Mitigant Constraint is performed across one Mitigant ID however Double Mitigant Constraint is performed across the second Mitigant ID that of the Guarantee.
- Allocation engine updates the covered factor for each exposure based on the previous objective function and the constraints defined by you.
- Total covered factor for an exposure = Covered Factor for all the exposure mitigant combination pertaining to that exposure.
- Covered Factor is Sum of all Covered amount + Uncovered amount of the mitigant upon its total EAD. For any exposure the sum of covered factor across rows is equal to 1.

In case of exposure and mitigant having the same risk weight, the covered factor might get allocated to either the uncovered standard mitigant type, or the eligible mitigant, based on the highest mitigant value post haircut.

15.3 Exhibit 3: Currency Conversion

SETUP_MASTER table is a setup table, used to provide the setup information of a Run. It can be used to set the default values of Rate Data Source Code or Standard Currency Code. For currency conversion the rate data source and standard currency are important values. If the rate data source value is missing, then BLOOMBERG is by default considered to determine the Rate Data Source Code from DIM_ORG_STRUCTURE table during currency conversion. If the Standard Currency code values are not provided or are missing, then USD is used as the destination currency code from DIM_ORG_STRUCTURE table during currency conversion. This is column under DIM_ORG_STRUCTURE table mapped to these default values are as follows:

Table 134: SETUP MASTER table run

V_COMPONENT_CODE	V_COMPONENT_DESC	V_COMPONENT_VALUE
DEFAULT_FX_RATE_SRC	Default Rate Data Source Code	BLOOMBERG
STD_CCY_CD	Standard Currency Code	USD

Rule Reporting Currency Code Assignment is set to 'USD' out of box but can be modified to any other currency. The reporting currency selection can be done in the Run execution windows if the Run is executed from the Run Execution Window.

Currency conversion is performed on multiple tables to convert the values from its natural currency to reporting currency. The steps which are performed for the currency conversion are as follows:

- The table Stage Forward Exchange Rates (STG_FORWARD_EXCHG_RATES) stores the details about the pair of currencies and the corresponding exchange rate to perform the same with the extraction date for which the forward exchange rate is provided. This table also contains the information about the data source from which the exchange rates are quoted and the tenor which is used to identify the period for which the forward exchange rate is applicable for.
- The data from this table is populated to Exchange Rates fact table through the common batch which is executed in the beginning. The initial data populated hereby contains the default run Skey which is set to minus 1. Only the records with tenor 0 are used for the purpose of currency conversion for which the spot exchange rate is required.
- After populating the data in the table, in each Run, all the exchange rates are updated based on the conditions at the time of execution to account for the increase or decrease in the exchange rates. A Rule is used which updates the exchange rates and populates the corresponding run Skey which is then used for currency conversion in that particular Run. The exchange rates are then moved into the table wherever currency conversion is required. This is performed in the Product Processor data population step.
- Different legal entities can use the exchange rates quoted by different data sources. Hence, the column which contains the information about the data source in the table Exchange Rates is compared with the required data source for a legal entity stored in the Org Structure Dimension (DIM_ORG_STRUCTURE) table.
- After the exchange rate population into the required fact tables, the currency conversion rules are executed which take the values stored in amount columns in natural currency, multiply them with the exchange rate and populate to the reporting currency amount columns.

For mitigants table, the exchange rate that is used for currency conversion is the exchange rate for the entity of the exposure which the mitigant belongs to. The list of tables and corresponding columns where currency conversion is carried out is available in the following OTN Documentation Library location:

[Currency Conversion Tables and Columns](#)

15.4 Exhibit 4: FSI_CAPITAL_STANDARD_MAPPING Table Mapping

As a part of Basel Capital Structure, information stored in Capital Standard Mapping (FSI_CAPITAL_STANDARD_MAPPING) table is a mapping of GL capital line items with seeded data in

Standard Accounting Head Dimension table (DIM_STD_ACCT_HEAD). This is also required for all the computed fields, so that the computation happens in the application for those standard accounting heads.

For all jurisdictions this mapping must be present which is elaborated in the following worksheet, available in the following OTN Documentation Library location:

[FSI CAPITAL STANDARD MAPPING](#)

15.5 Exhibit 5: Data Expectations for few of the Basel Products

15.5.1 Equity Exposures Data Expectations

The Equity Exposures and any other exposures which were expected to be treated under Equity Asset Class of the particular jurisdiction were expected in Stage Equity Exposures (STG_EQUITY_EXPOSURES) till 8.0.3 release of Basel application.

Starting from 8.0.4 release, any exposure which must be treated under Equity Asset Class is expected to be provided in Stage Investments (STG_INVESTMENTS).

For mandate-based approach in equity Investment in funds when there are no entries in STG_FUND_UNDERLYING_COMPOSITION, application assigns Fall Back Approach to the remaining exposures.

All the required attributes pertaining to Equity Exposures are expected to be provided in Stage Investments (STG_INVESTMENTS) and any Instrument Specific attributes in Instrument Contract Dimension table (DIM_INSTRUMENT_CONTRACT).

15.5.2 Securitization Exposures Data Expectations

The Securitization Exposures and any other exposures which were expected to be treated under Securitization framework of the particular jurisdiction were expected in Stage Securitization Exposures (STG_SEC_EXPOSURES) till 8.0.3 release of Basel application.

Starting from 8.0.4 release, any exposure which must be treated under Securitization Framework is expected to be provided in different product processors depending on the product type.

- If the exposure is to a securitization tranche, retained tranche or retained portion of the pool, it is expected in Stage Investments (STG_INVESTMENTS), with details of the pool ID and the tranche ID to which the exposure belongs to.
- If the exposure is a facility like liquidity facility or servicer cash advance facility, it is expected in Stage Commitment Contracts (STG_COMMITMENT_CONTRACTS), with the pool ID to which the facility is provided to. For any particular tranche level calculations required for SFA/ SSFA process, this must be created as a dummy tranche, and provided with details based on the seniority in the cash flows. In case of the commitment contract, which is issued under a credit line facility, the corresponding entry in Credit Line Dimension table (DIM_CREDIT_LINE) is required, with the mapping of the commitment contract to the credit line.
- If the exposure is a credit protection in the form of guarantee, it is expected in Stage Guarantees (STG_GUARANTEES), with the pool ID and the tranche ID to which the credit protection is provided to.

- If the exposure is a credit protection in the form of credit derivatives, it is expected in Stage Credit Derivatives (STG_CREDIT_DERIVATIVES), with the pool ID to which the credit protection is being provided to. For any particular tranche level calculations required for SFA/ SSFA process, this must be created as a dummy tranche, and provided with details based on the seniority in the cash flows.

The pool level aggregate information data capture (Securitization Pool table - STG_SECURITIZATION_POOL)) and the tranche level information data capture (Securitization Tranche table – STG_SECURITIZATION_TRANCHE)) remain the same as in previous releases. The pool's detailed underlying information are captured in the Stage Underlying Exposures table (STG_UNDERLYING_EXPOSURES) for an investor.

In the case of underlying exposures data capture (STG_UNDERLYING_EXPOSURES), it is currently expected that for each exposure, the pool underlying has to be provided by creating a dummy exposure in the Underlying Exposures table with the Pool ID as the Exposure ID, and the Parent Account ID as the Exposure ID to which this pool detail belongs to. And further pool underlying exposures is created by having the Parent Account ID as the Dummy Pool Exposure ID.

Any Instrument Specific attributes are expected in Instrument Contract Dimension table (DIM_INSTRUMENT_CONTRACT).

15.5.3 Securities Financing Transaction Related Exposures Data Expectations

The Securities Financing Transaction (SFT) related exposures were expected in Stage Repo Contracts (STG_REPO_CONTRACTS), and all their related collateral were expected in Stage Underlying Exposures (STG_UNDERLYING_EXPOSURES) till 8.0.3 release of Basel application.

Starting from 8.0.4 release, there are changes to the capture of the collateral related to the SFT.

- The collateral which the bank has received with respect to the SFT transactions are captured in the Stage Mitigants (STG_MITIGANTS) table, with the SFT Exposure mapped to the collateral received using the Stage Account Mitigant Map (STG_ACCOUNT_MITIGANT_MAP) table.
- The collateral which the bank has placed with respect to the SFT transactions are captured in the Stage Placed collateral (STG_PLACED_COLLATERAL) with the SFT Exposure mapped to the collateral placed using the Stage Account Placed Collateral Map (STG_ACCT_PLACED_COLL_MAP) table.

Any Instrument Specific attributes are expected in Instrument Contract Dimension table (DIM_INSTRUMENT_CONTRACT)

15.5.4 Account Mitigant Mapping Data Expectations

Any account in the product processors, mapped to the various mitigants received were captured in the Stage Exposure Mitigant Mapping (STG_EXP_MITIGANT_MAPPINGS) till 8.0.4 release of Basel application.

Starting from 8.0.5 release, this is expected to be provided in the Stage Account Mitigant Map (STG_ACCOUNT_MITIGANT_MAP) table

15.5.5 Commitment Contract Data Expectations

Any commitment contracts issued by the bank were initially expected in Stage LC Contracts (STG_LC_CONTRACTS) till 8.0.4 release of Basel application.

Starting from 8.0.5 release, any exposure which a commitment contract is issued by the bank, is expected to be provided in the Stage Commitment Contracts (STG_COMMITMENT_CONTRACTS).

In the case of the commitment contracts issued under a credit line facility, then, the linkage of the credit line to the contract is required to be provided. The credit line is expected to be populated into the Dimension Credit Line (DIM_CREDIT_LINE) table.

15.5.6 Credit Line Issued Data Expectations

Any credit line, issued by the bank were initially expected in Stage LC Contracts (STG_LC_CONTRACTS) till 8.0.4 release of Basel application.

Starting from 8.0.5 release, any exposure which is a line of credit issued by the bank, is expected to be provided in the Stage Credit Line Details (STG_CREDIT_LINE_DETAILS) along with entries in the Dimension Credit Line (DIM_CREDIT_LINE) table.

The credit line table will hold information with respect to all the lines of credit issued by the bank. The lines of credit can be drawn for various products like Credit Card (corporate credit card issued to various employees under a credit line for that corporate), Loan commitments (loan issued to the customer as part of a credit line issued to that customer) and so on. This table will hold all the information related to the credit line, and any undrawn portion related to that credit line.

The drawn portion of the credit line, or the portion which has been earmarked for a specific product like credit card, will be part of the corresponding product processor (STG_CARDS, in this example), with the credit line code populated. And under that particular product, there can be both the drawn and undrawn portion, which will be captured in the same product processor (STG_CARDS, in this example).

The undrawn portion of the credit line will be the one which will be treated as line of credit, and will receive the corresponding Basel guideline specific treatment.,

15.5.7 Forward Contract Data Expectations

Any forward agreement or contract were initially expected in Stage Futures (STG_FUTURES) till 8.0.4 release of Basel application.

Starting from 8.0.5 release, any exposure which is a forward agreement, is expected to be provided in the Stage Forwards (STG_FORWARDS).

15.5.8 Asset Sold Data Expectations

Any assets sold with recourse were initially expected in Stage Loan contracts (STG_LOAN_CONTRACTS) till 8.0.4 release of Basel application.

Starting from 8.0.5 release, any exposure which is an asset sold, is expected to be provided in the Stage Assets sold (STG_ASSETS_SOLD). This will include all the assets sold by the bank. And the assets sold, for which the bank is retaining recourse will be part of the regulatory capital calculations, and that will be taken up for the Basel related processing.

15.5.9 Spot Forex Data Expectations

Any forex transaction, which is a spot were initially expected in Stage Investments (STG_INVESTMENTS) till 8.0.4 release of Basel application.

Starting from 8.0.5 release, any forex transaction which is a spot contract, is expected to be provided in the Stage Forex Contracts (STG_FX_CONTRACTS).

Note: All other forex transactions are expected to be populated in their respective derivative tables (Currency Swap in STG_SWAPS_CONTRACTS and so on).

15.5.10 Underlying Exposures for Derivatives

The underlying exposures for derivatives are now being captured through STG_UNDERLYING_MASTER.

The Data expectation for the underlying relationship for the derivatives is as follows:

- Case 1 – Both Parent derivative contract and underlying of the derivative are instruments:
 - This will involve usage of the two tables for capture of the underlying information – STG_UNDERLYING_MASTER/ DIM_UNDERLYING and STG_UNDERLYING_DTL
 - The parent account will be in one of the derivative contracts, and the relationship between the parent and the underlying will be captured in the derivative tables as Underlying Instrument Code or the Underlying code
 - DIM_UNDERLYING will be used to store the static information about the underlying instruments, and STG_UNDERLYING_DTL will be used to store any variable information about the underlying instruments.
 - Data for STG_UNDERLYING_DTL
 - The STG_UNDERLYING_DTL can support the relationship reference of 1 parent to 1 underlying or multiple underlying instruments.
 - In this, the underlying instrument code will be provided as v_instrument_code and the parent's instrument code will be provided as v_contract_instrument_code
 - Both these instrument codes will have reference in dim_instrument_contract.
- Case 2 – If Parent derivative contract or underlying of the derivative are not instruments but instead are accounts or exposure:
 - This will involve usage of a single table for capture of the underlying information – STG_UNDERLYING_EXPOSURES.
 - The parent account will be in one of the derivative contracts, and the relationship between the parent and the underlying will be captured in the underlying table as the parent exposure ID.
 - Data for STG_UNDERLYING_EXPOSURES.
 - The STG_UNDERLYING_EXPOSURES can support the relationship reference of 1 parent to 1 underlying or multiple underlying instruments.
 - In this, the underlying exposure will be provided as v_exposure_id and parent's exposure ID in v_parent_exposure_ID.
 - Both these exposure ID's will have reference in dim_exposure.

15.5.11 Underlying Exposures for CIU

The underlying exposures for CIU are now being captured through STG_UNDERLYING_MASTER.

The following is the data flow of underlying exposure of CIU:

- Case of Invested Mutual Fund
 - Invested portion will be in STG_INVESTMENTS
 - Any Fund related information which do not change will be in STG_INSTRUMENT_CONTRACT_MASTER
 - Any Fund related information which changes frequently will be in STG_INTRUMENT_CONTRACT_DTL
 - The composition of the fund will be in STG_FUND_UNDERLYNG_COMPOSITION
 - The assets of the fund will be in STG_FUND_CIS_COMPOSITION

15.6 Exhibit 6: Design Changes

15.6.1 Design Changes for Handling Organization Structure

DIM ORG STRUCTURE flattening

From Release 8.1.0.0 onwards, for a selected Org Entity and the mode of execution either Solo or Consolidation, the application flattens the Org entries from DIM_ORG_STRUCTURE into a structure as follows.

Table 135: Example for Dim Org Structure Data

Dim Org Account	Dim Org Parent
A1	A2
A2	A3
A3	A4

If you select, A3 as the Entity and Consolidation as execution type, the following data is populated in the flattened table:

Table 136: Example for Dim Org Structure Data in flattened table

Entity	Parent Entity	Consolidation Parent	Heir Level
A3	A3	A3	0
A3	A2	A3	1
A2	A1	A3	2

All the entities from Entity column from Consolidation Parent = A3 is picked up and populated into FCT_ENTITY_INFO table.

This step is done to avoid population of all unnecessary org structure data into FCT_ENTITY_INFO and later it is deleted once they are unused.

16 Annexure B: Technical Details

16.1 Download Specifications

For information, see [Download Specifications](#).

16.2 Regulatory Definition Setup for Creating a Run

The run definitions created through Regulatory Calculation Definition UI, methods, parameters and options selected here, will be populated in FSI_RUN_PARAMETER table during execution. In this table, selected options are updated against the column names. The column names and values that are updated for the selected option are given in the following tables:

Regulation: Basel III Post Crisis Reforms

Jurisdiction: BIS

Table 137: The values for BASEL III Post Crisis Reforms with jurisdiction as BIS and Non-Securitization Approach

FSI_RUN_PARAMETER column name	Item Description	Options Available	FSI_RUN_PARAMETER column value	Applicable Approaches
V_ALLOW MATERIALLY NOT DPND	Does the Regulator allow specific risk weighting for property exposures whose repayment are materially dependent on cashflow generated by the property?	No	OPT-NO	Standardized Approach
		Yes	OPT-YES	
V_BANK_CCF_APPR	Bank CCF Approach	Own Estimated Parameters	OPT0057	Advanced IRB Approach
		Supervisory Parameters	OPT0056	
V_COLL_LGD_MODEL	Collateral for LGD Modelling	Full	OPTLGD03	Advanced IRB Approach
		None	OPTLGD01	
		Partial	OPTLGD02	
V_CRM_METHOD	Credit Risk Mitigation Approach	Comprehensive Approach for Collateral Recognition	OPT0054	Advanced IRB Approach, Foundation IRB Approach, Standardized Approach
		Simple Approach for Collateral Recognition	OPT0053	Standardized Approach

V_CSRP_RW_APPROC H	Risk Weighting methodology for Immovable Assets	LTV Based Risk Weighting	OPTLTV02	Standardized Approach
		LTV and Party Risk Weight Based on Split of Exposure	OPTLTV01	
V_CVA_INCLUDE_SFT	Supervisory Approval to include SFTs for CVA calculation?	No	OPT0063	Advanced IRB Approach, Foundation IRB Approach, Standardized Approach
		Yes	OPT0062	
V_CVA_METHOD	Credit Valuation Adjustment - Capital Calculation Approach	Based on CCR Capital Charge	OPT9079	Advanced IRB Approach, Foundation IRB Approach, Standardized Approach
		Basic Approach - Reduced Version	OPT9080	
V_EXP_ADJ_PROVISIO NS	Consider Provision Amount for EAD Calculations?	No	OPTLE0004	Advanced IRB Approach, Foundation IRB Approach
		Yes	OPTLE0003	
V_FIDUCIARY_ASSET_ DERECOG_OPT	Do all the Fiduciary Assets meet the criteria for derecognition or deconsolidation as per the bank's accounting standards?	No	OPT0809	Standardized Approach
		Yes	OPT0808	
		No	OPT-NO	Advanced IRB Approach, Foundation IRB Approach
		Yes	OPT-YES	
V_NAT_DISC_LOWER_ RW_FOR_EQ	Does the Regulator allow Equity Exposures to National Legislated Programs, to be risk weighted lower than the other equity exposures?	No	OPT-NO	Standardized Approach
		Yes	OPT-YES	
V_NFIR_EXPLICIT_MA T_ADJ	Supervisory Approval to use explicit maturity adjustment for all smaller domestic firms, where the consolidated assets is lesser than the national threshold?	No	OPT0204	Foundation IRB Approach
		Yes	OPT0203	

V_NIR_1YR_MAT_CORP_PR	Dilution Risk - Supervisory Approval to apply one year maturity for Corporate Purchased Receivables?	No	OPT0214	Advanced IRB Approach, Foundation IRB Approach
		Yes	OPT0213	
V_NIR_DEFAULT_RISK_APP	Default Risk - Approach for Calculations	Bottom Up	OPT0208	Advanced IRB Approach, Foundation IRB Approach
		Top Down	OPT0207	
V_NIR_DIL_RISK_IMMATERIAL	Dilution Risk - Materiality Condition	Immaterial	OPT0210	Advanced IRB Approach, Foundation IRB Approach
		Material	OPT0211	
V_NIR_SL_PREF_RW	Supervisory Approval to assign preferential risk weights to specialized lending exposures, which fall into Strong and Good category?	No	OPT0242	Advanced IRB Approach, Foundation IRB Approach
		Yes	OPT0241	
V_NSS_BORROWER_CCY_RAT_MDB	Supervisory Approval to use Domestic Currency Rating for Loans issued in foreign currency?	No	OPT0031	Standardized Approach
		Yes	OPT0030	
V_NSS_ECA_FOR_SOVERIGN	Supervisory Approval to use ECA Scores for Risk Weighting?	For all exposures risk weighting	OPT0006	Standardized Approach
		Not applicable for risk weighting	OPT0005	
		Only for unrated exposures risk weighting	OPT0004	
V_NSS_LOWER_RW_CRE	Supervisory Approval to RW CRE Exposures using Preferential RW to a lower RW?	No	OPT0021	Standardized Approach
		Yes	OPT0020	
V_NSS_RW_OPTION_BANK	Risk Weighting Approach	Based on Bank Rating	OPT0013	Standardized Approach
		Based on Sovereign Rating	OPT0012	
V_NSS_RW_OPTION_DPSE	Risk Weighting Approach	Based on Domestic PSE Rating	OPT0009	Standardized Approach
		Based on Sovereign Rating	OPT0008	
V_NS_HAIRCUT_METHOD	Volatility and Forex Haircut Estimates	Own Estimated Parameters	OPT0057	Advanced IRB Approach

		Supervisory Parameters	OPT0056	Advanced IRB Approach, Foundation IRB Approach, Standardized Approach
V_NS_OTC_METHOD	Derivative Transactions - EAD Calculation Approach	Standardized Approach - CCR	OPT0048	Standardized Approach
		Internal Model Method	OPT0229	Foundation IRB Approach
		Standardized Approach - CCR	OPT0235	
		Internal Model Method	OPT0325	Advanced IRB Approach
		Standardized Approach - CCR	OPT0331	
V_NS_SFT_METHOD	Securities Financing Transactions - EAD Calculation Approach	Comprehensive Approach for Collateral Recognition	OPT9009	Advanced IRB Approach, Foundation IRB Approach, Standardized Approach
		Simple Approach	OPT0037	Standardized Approach
		VaR Approach for Collateral Recognition	OPT0226	Foundation IRB Approach
		VaR Approach for Collateral Recognition	OPT0322	Advanced IRB Approach
V_OPTIMIZER_ALLOCATION_BASIS	Optimization allocation based on	Exposure Amount Post CCF	OPTALLOC1	Standardized Approach
		Exposure Amount Without CCF	OPTALLOC2	

V_REG_ALLOW_LIEN_P ROP	Does the Regulator allow Junior Lien to be considered on par with First Lien of the property?	No	OPT-NO	Standardized Approach
		Yes	OPT-YES	
V_REG_ALLOW_UND_C ONST_PROP	Does the Regulator allow Residential Property under construction to be treated under a completed property?	No	OPT-NO	Standardized Approach
		Yes	OPT-YES	
V_RW_BASED_NAT_DIS CR	Does the Regulator Allow Exposures funded and denominated in same currency to be Risk Weighted at 0%	No	OPT-NO	Standardized Approach
		Yes	OPT-YES	
V_RW_OPTION_EXT_RA TING	Does Regulator Allow Usage of External Ratings for Risk Weighting?	No	OPT-NO	Standardized Approach
		Yes	OPT-YES	
V_SACCR_MULTI_RISK_ APPROACH	Risk Category Identification Approach Selection for Instruments belonging to multiple risk categories	Fall-Back Approach	OPT0258	Advanced IRB Approach, Foundation IRB Approach, Standardized Approach
		SA-CCR Method and Fall-Back Approach	OPT0257	
		Sensitivity-based Method and Fall-Back Approach	OPT0256	
V_SLOT_CRITERIA_APP R	Specialized Lending using Slotting Criteria Approach?	No	OPT-NO	Advanced IRB Approach, Foundation IRB Approach
		Yes	OPT-YES	

Table 138: The values for BASEL III Post Crisis Reforms with jurisdiction as BIS and Securitization Approach

FSI_RUN_PARAMETER column name	Item Description	Options Available	FSI_RUN_PARAMETER column value	Applicable Approaches
V_IAA_APPROVAL	Does the bank have supervisory approval for using IAA?	No	OPT-NO	Standardized Approach
		Yes	OPT-YES	

V_SEC_ERBA_APPROACH_SUP_APRV	Supervisory Approval to use External Ratings Based Approach or Internal Assessment Approach, in case bank is unable to compute using SEC IRB approach?	No	OPT0621	IRB Approach
		Yes	OPT0620	
V_SEC_UNCOND_CF_PMT_DATE_AVAIL	Are Contractual Payment Dates of Cash flow available to calculate Tranche Maturity?	No	OPT0618	IRB Approach, Standardized Approach
		Yes	OPT0617	
V_SSF_SIMPLE_N_LGD	Supervisory Approval to use Simplified Method for calculating N (Pool Granularity) and LGD (Pool LGD)?	No	OPT0612	IRB Approach
		Yes	OPT0611	

Table 139: The values for BASEL III Post Crisis Reforms with jurisdiction as BIS and Operational Risk Approach

FSI_RUN_PARAMETER column name	Item Description	Options Available	FSI_RUN_PARAMETER column value	Applicable Approaches
V_BASEL_OR_CAP_CHRG_LEVEL	Basel Operational Risk Capital Charge Computation Level	Entity Level	OPTENTLVL	Standardized Approach
		LOB Level	OPTLOBLVL	

V_SUP_APPRV_EXCL_DIVSTD_ACT	Exclusion of Divested Activities in BI Calculation	No	OPT-NO	Standardized Approach
		Yes	OPT-YES	
V_SUP_APPRV_EXCL_MERG_ACQ_ACT	Exclusion of Mergers and Acquisitions In BI Calculation	No	OPT-NO	Standardized Approach
		Yes	OPT-YES	
V_SUP_APPRV_EXCL_OPR_LOSS	Supervisory approval for excluding the Operational losses from Loss Component	No	OPT-NO	Standardized Approach
		Yes	OPT-YES	
V_SUP_APPRV_HIST_LOSS_YEARS	Number of Years Considered for Historical Loss Calculation	1	OPTLT011	Standardized Approach
		10	OPTLT006	
		2	OPTLT010	
		3	OPTLT009	
		4	OPTLT008	
		5	OPTLT007	
V_SUP_APPRV_INT_LOSS_MULTPLR	ILM Value to Be Considered For Calculation	Calculated Value	OPTLT012	Standardized Approach
		Supervisory Defined ILM Value	OPTLT013	
V_SUP_APPRV_LOSS_EVNT_THRSHLD	Loss Event Threshold	100000	OPTLT005	Standardized Approach
		20000	OPTLT004	
V_SUP_APPRV_QUAL_STD_MET	Are the Qualitative Standards for ILM Value Calculation Met?	No	OPT-NO	Standardized Approach
		Yes	OPT-YES	
V_SUP_APPRV_HIST_LOSS_TYPE	Loss Type Considered for Historical Loss Calculation	Both External and Internal	OPTLT003	Standardized Approach
		Only External	OPTLT001	
		Only Internal	OPTLT002	

Table 140: The values for BASEL III Post Crisis Reforms with jurisdiction as BIS and Leverage Exposure Measure and Ratio Calculations

FSI_RUN_PARAMETER column name	Item Description	Options Available	FSI_RUN_PARAMETER column value
V_GAAP_OFFSET_OPTION	Does the operative accounting framework allow for recognizing the cash variation margin paid in cash to the counterparty as a receivable asset?	No	OPT-NO
		Yes	OPT-YES
V_PLACED_COLL_AS_RCV_ASSET	Does the operative accounting framework allow for offsetting the derivative exposure amount (or market value) by the collateral amount or cash variation amount?	No	OPT-NO
		Yes	OPT-YES

Table 141: The values for BASEL III Post Crisis Reforms with jurisdiction as BIS and Non Securitization Mixed approach

FSI_RUN_PARAMETER column name	Item Description	Options Available	FSI_RUN_PARAMETER column value	Applicable Approaches
V_CAP_OUTPUT_FLOOR	Does the bank want to apply output floors?	No	OPT-NO	Mixed Approach
		Yes	OPT-YES	
V_CAP_OUTPUT_FLOOR_PC	What capital floor does the bank want to use?	50%	OPT50PC	Mixed Approach
		55%	OPT55PC	
		60%	OPT60PC	
		65%	OPT65PC	
		70%	OPT70PC	
		72.50%	OPT725PC	
V_CIU_ULY_TREATMENT	CIU Underlying Treatment in Look Through Approach	Combination of STD and AIRB Treatment	OPTCIU03	Mixed Approach
		Combination of STD and FIRB Treatment	OPTCIU02	
		STD Treatment	OPTCIU01	

Regulation: Basel III**Jurisdiction: BIS****Table 142: The values for BASEL III with jurisdiction as BIS and Non-Securitization Approach**

FSI_RUN_PARAMET ER column name	Item Description	Options Available	FSI_RUN_PARAMET ER column value	Applicable Approaches
V_CRM_METHOD	Credit Risk Mitigation Approach	Comprehensive Approach for Collateral Recognition	OPT0054	Advanced IRB Approach, Foundation IRB Approach, Standardized Approach
		Simple Approach for Collateral Recognition	OPT0053	Standardized Approach
V_CVA_CDS_INDEX_DECOMPOSITION	CDS Index - Data provided has to be decomposed to individual components?	No	OPT0066	Standardized Approach
		Yes	OPT0065	
V_CVA_INCLUDE_SF T	Supervisory Approval to include SFTs for CVA calculation?	No	OPT0063	Standardized Approach
		Yes	OPT0062	
V_CVA_METHOD	Credit Valuation Adjustment - Capital Calculation Approach	Advanced Approach	OPT9031	Advanced IRB Approach, Foundation IRB Approach
		Standardized Approach	OPT0060	Advanced IRB Approach, Foundation IRB Approach, Standardized Approach
V_EXP_ADJ_PROVISO NS	Consider Provision Amount for EAD Calculations?	No	OPTLE0004	Advanced IRB Approach, Foundation IRB Approach, Standardized Approach
		Yes	OPTLE0003	
V_FIDUCIARY_ASSET _DERECOG_OPT	Do all the Fiduciary Assets meet the criteria for derecognition or deconsolidation as per the bank's accounting standards?	No	OPT0809	Advanced IRB Approach, Foundation IRB Approach, Standardized Approach
		Yes	OPT0808	
V_MTM_TO_ICVA_OP TION	Original Expected Exposure computation based on	Initial Margin Amount (IMA)	OPT0114	Standardized Approach
		Mark-to-Market (MTM) Value	OPT0113	
		No	OPT0204	

V_NFIR_EXPLICIT_MAT_ADJ	Supervisory Approval to use explicit maturity adjustment for all smaller domestic firms, where the consolidated assets is lesser than the national threshold?	Yes	OPT0203	Foundation IRB Approach
V_NIR_1YR_MAT_CORP_PR	Dilution Risk - Supervisory Approval to apply one year maturity for Corporate Purchased Receivables?	No	OPT0214	Foundation IRB Approach
		Yes	OPT0213	
		No	OPT0310	Advanced IRB Approach
		Yes	OPT0309	
V_NIR_DEFAULT_RISK_APP	Default Risk - Approach for Calculations	Bottom Up	OPT0208	Foundation IRB Approach
		Top Down	OPT0207	
		Bottom Up	OPT0304	Advanced IRB Approach
		Top Down	OPT0303	
V_NIR_DIL_RISK_IMMATERIAL	Dilution Risk - Materiality Condition	Immaterial	OPT0210	Foundation IRB Approach
		Material	OPT0211	
		Immaterial	OPT0306	Advanced IRB Approach
		Material	OPT0307	
V_NIR_EQUITY_APPROACH	Equity Exposures - Capital Calculation Approach	Internal Model Method	OPT0245	Foundation IRB Approach
		PD - LGD Approach	OPT0247	
		Simple Risk Weight Approach	OPT0246	
		Internal Model Method	OPT0341	Advanced IRB Approach
		PD - LGD Approach	OPT0343	
		Simple Risk Weight Approach	OPT0342	
V_NIR_SL_PREF_RW	Supervisory Approval to assign preferential risk weights to specialized lending exposures, which fall into Strong and Good category?	No	OPT0242	Foundation IRB Approach
		Yes	OPT0241	
		No	OPT0338	Advanced IRB Approach
		Yes	OPT0337	
V_NSS_0_RW_FOR_GOLD	Supervisory Approval to RW Gold held in own vaults, or on allocated basis, at 0%?	No	OPT0028	Standardized Approach
		Yes	OPT0027	
V_NSS_100PCT_RW_CORP	Supervisory Approval to RW all Corporate Exposures at 100%?	No	OPT0017	Standardized Approach
		Yes	OPT0016	

V_NSS_BORROWER_CCY_RAT_MDB	Supervisory Approval to use Domestic Currency Rating for Loans issued in foreign currency?	No	OPT0031	Standardized Approach
		Yes	OPT0030	
V_NSS_ECA_FOR_SOVERIGN	Supervisory Approval to use ECA Scores for Risk Weighting?	For all exposures risk weighting	OPT0006	Standardized Approach
		Not applicable for risk weighting	OPT0005	
		Only for unrated exposures risk weighting	OPT0004	
V_NSS_LOWER_RW_CRE	Supervisory Approval to RW CRE Exposures using Preferential RW to a lower RW?	No	OPT0021	Standardized Approach
		Yes	OPT0020	
V_NSS_PASTDUE_FOR_NONPASTDUE	Supervisory Approval to treat non-past due exposures that are risk weighted at 150% RW, on par with past due exposures?	No	OPT0025	Standardized Approach
		Yes	OPT0024	
V_NSS_RW_OPTION_BANK	Risk Weighting Approach	Based on Bank Rating	OPT0013	Standardized Approach
		Based on Sovereign Rating	OPT0012	
V_NSS_RW_OPTION_DPSE	Risk Weighting Approach	Based on Domestic PSE Rating	OPT0009	Standardized Approach
		Based on Sovereign Rating	OPT0008	
V_NS_HAIRCUT_METHOD	Volatility and Forex Haircut Estimates	Own Estimated Parameters	OPT0057	Advanced IRB Approach
		Supervisory Parameters	OPT0056	Advanced IRB Approach, Foundation IRB Approach, Standardized Approach
V_NS_OTC_METHOD	Derivative Transactions - EAD Calculation Approach	Standardized Approach - CCR	OPT0048	Standardized Approach
		Internal Model Method	OPT0229	Foundation IRB Approach
		Standardized Approach - CCR	OPT0235	
		Internal Model Method	OPT0325	Advanced IRB Approach

		Standardized Approach - CCR	OPT0331	
V_NS_SFT_METHOD	Securities Financing Transactions - EAD Calculation Approach	Comprehensive Approach for Collateral Recognition	OPT9009	Advanced IRB Approach, Foundation IRB Approach, Standardized Approach
		Simple Approach	OPT0037	Standardized Approach
		VaR Approach for Collateral Recognition	OPT0226	Foundation IRB Approach
		VaR Approach for Collateral Recognition	OPT0322	Advanced IRB Approach
V_OPTIMIZER_ALLLOCATION_BASIS	Optimization allocation based on	Exposure Amount Post CCF	OPTALLOC1	Standardized Approach
		Exposure Amount Without CCF	OPTALLOC2	
V_SACCR_MULTIRISK_APPROACH	Risk Category Identification Approach Selection for Instruments belonging to multiple risk categories	Fall-Back Approach	OPT0258	Advanced IRB Approach, Foundation IRB Approach, Standardized Approach
		SA-CCR Method and Fall-Back Approach	OPT0257	
		Sensitivity-based Method and Fall-Back Approach	OPT0256	

Table 143: The values for BASEL III with jurisdiction as BIS and Securitization Approach

FSI_RUN_PARAMETER column name	Item Description	Options Available	FSI_RUN_PARAMETER column value	Applicable Approaches
V_IAA_APPROVAL	Does the bank have supervisory approval for using IAA?	No	OPT-NO	Standardized Approach
		Yes	OPT-YES	
V_SEC_ERBA_APPROACH_SUP_APRV	Supervisory Approval to use External Ratings Based Approach or Internal Assessment Approach, in case bank is unable to	No	OPT0621	IRB Approach, Standardized Approach
		Yes	OPT0620	

	compute using SEC IRB approach?			
V_SEC_UNCOND_CF_PMT_DATE_AVAIL	Are Contractual Payment Dates of Cash flow available to calculate Tranche Maturity?	No	OPT0618	IRB Approach, Standardized Approach
		Yes	OPT0617	
V_SSF_SIMPLE_N_LGD	Supervisory Approval to use Simplified Method for calculating N (Pool Granularity) and LGD (Pool LGD)?	No	OPT0612	IRB Approach
		Yes	OPT0611	

Table 144: The values for BASEL III with jurisdiction as BIS and Operational Risk Approach

FSI_RUN_PARAMETER column name	Item Description	Options Available	FSI_RUN_PARAMETER column value	Applicable Approaches
V_BASEL_OR_CAP_CHRG_LEVEL	Basel Operational Risk Capital Charge Computation Level	Entity Level	OPTENTLVL	Alternative Standardized Approach, Basic Indicator Approach, Standardized Approach
		LOB Level	OPTLOBLVL	

Table 145: The values for BASEL III with jurisdiction as BIS and Market Risk Approach

FSI_RUN_PARAMETER column name	Item Description	Options Available	FSI_RUN_PARAMETER column value	Applicable Approaches
V_MRS_COMMODITY_RISK_METHOD	Commodity Risk	Maturity Ladder Approach	OPT1009	Standardized Approach
		Simplified Approach	OPT1008	
V_MRS_INTEREST_RATE_METHOD	Interest Rate Risk	General Market Risk-Duration Method	OPT1003	Standardized Approach
		General Market Risk-Maturity Method	OPT1004	
V_MRS_OPTIONS_METHOD	Options	Delta Plus Approach	OPT1014	Standardized Approach
		Simplified Approach	OPT1013	

Table 146: The values for BASEL III with jurisdiction as BIS and Leverage Exposure Measure and Ratio Calculations

FSI_RUN_PARAMETER column name	Item Description	Options Available	FSI_RUN_PARAMETER column value
V_GAAP_OFFSET_OPTION	Does the operative accounting framework allow for recognizing the cash variation margin paid in cash to the counterparty as a receivable asset?	No	OPT-NO
		Yes	OPT-YES
V_PLACED_COLL_AS_RCV_ASSET	Does the operative accounting framework allow for offsetting the derivative exposure amount (or market value) by the collateral amount or cash variation amount?	No	OPT-NO
		Yes	OPT-YES

16.2.1 Selecting Run Definition for Execution

The Run Definition can be selected by searching or scrolling in the “Regulatory Definition” field while triggering a Run Execution.

Figure 147: Run definition

The screenshot shows a web interface for configuring a run execution. At the top, there is a red header bar labeled "Execution". Below it, the "Execution Type" is set to "With Parameters". The "Reporting Date" is selected with a calendar icon. The "Regulatory Definition" field is active, showing a search input with "BIS" entered and a magnifying glass icon. A dropdown list of suggestions is visible below the search input, listing several "BIS" definitions with their respective compliance approaches. The first suggestion is "BIS - Basel III: Finalizing Post Crisis Reforms Compliance - Standardized Approach". The second is "BIS - Basel III: Finalizing Post Crisis Reforms Compliance - Mixed Approach with Output Floor". The third is "BIS - Basel III: Finalizing Post Crisis Reforms Compliance - Mixed Approach without Output Floor", which is highlighted. The fourth is "BIS - Capital Calculation - Standardized Approach".

16.2.2 Importing Run Definitions

To import the DMP file, perform the following steps:

1. Rename or delete the existing OOB definitions in the setup.
2. Navigate to the directory path `$FIC_HOME/utility/Migration/conf/`.
3. Create a copy of the file `OBJECTMIGRATION_template.xml` as `OBJECTMIGRATION.xml` and provide appropriate values for the parameters as per the following table:

Table 148: Parameters and their values

Parameter	Value
<code>\$USERID\$</code>	Application User ID
<code>\$LOCALE\$</code>	Locale Information
<code>\$INFODOM\$</code>	Information Domain
<code>\$FOLDER\$</code>	Folder or Segment where you wish to import the definition
<code>MODE</code>	IMPORT
<code>\$FILE_NAME\$</code>	Name of the file to be imported without the <code>.dmp</code> extension
<code>MIGRATION_CODE\$</code>	11

4. Place as many unique codes as per the number of definitions available in the dump.

For example: `<OBJECT Code="1000" Type="4003" />`

To find the object codes, you must perform the following steps:

- a. Execute the following query in the atomic schema to check the existing `N_RUN_PARAM_DEFN_ID` that are in use.
- b. `SELECT * FROM FSI_RUN_PARAM_DEFINITION_TL;`
- c. Use the Object Code in `OBJECTMIGRATION.xml` which does not exist in `N_RUN_PARAM_DEFN_ID` column.

NOTE:

The type must have the value 4003 which represents Regulatory Calculation Definitions

5. Create the following folder structure in the path `$FIC_HOME/utility/Migration`:

```
metadata/restore
```

6. Copy the dump file from the installer and place it in the directory path

```
$FIC_HOME/utility/Migration/metadata/restore
```

7. Execute the following script located in the directory path `$FIC_HOME/utility/Migration/bin/`:

```
./ObjectMigration.sh
```

Check the availability of definitions in the UI. Migration logs are available in the directory path

```
$FIC_HOME/utility/Migration/logs/migration.log.
```

16.2.3 Exporting Definitions

1. Navigate to the directory path `$FIC_HOME/utility/Migration/conf/`.
2. Create a copy of the file `OBJECTMIGRATION_template.xml` as `OBJECTMIGRATION.xml` and provide appropriate values for the parameters as per the following table:

Table 149: Parameters and their values

Parameter	Value
<code>\$USERID\$</code>	Application User ID
<code>\$LOCALE\$</code>	Locale Information
<code>\$INFODOM\$</code>	Information Domain
<code>\$FOLDER\$</code>	Folder or Segment of the existing definition
MODE	EXPORT
<code>\$FILE_NAME\$</code>	Name of the file to be exported without the <code>.dmp</code> extension
<code>MIGRATION_CODE\$</code>	11

3. Place as many unique codes as per the number of definitions you wish to export.

For example, `<OBJECT Code="1000" Type="4003" />`

To find the object codes, perform the following steps:

- a. Execute the following query in the atomic schema for run definitions:

```
SELECT * FROM FSI_RUN_PARAM_DEFINITION_TL;
```

`N_RUN_PARAM_DEFN_ID` is the object code and value of Type is 4003.

- b. Execute the following query in the atomic schema for portfolio definitions:

```
SELECT * FROM FSI_PORTFOLIO_MASTER;
```

`N_PPORTFOLIO_ID` is the object code and value of Type is 4002.

- c. Execute the following query in the atomic schema for optimizer definitions:

```
SELECT * FROM FSI_BASEL_OPTIMIZER_MODEL_TL;
```

`N_MODEL_ID` is the object code and the value of Type is 4001.

4. Execute the following script in the directory path `$FIC_HOME/utility/Migration/bin`:

```
./ObjectMigration.sh
```

The Dump is available in the directory path `$FIC_HOME/utility/Migration/metadata/archive`.

The migration logs are available in file `migration.log` in the directory path `$FIC_HOME/utility/Migration/logs`.

16.2.4 BackDated Execution - Run Execution Parameter

In the previous releases of the application, when you execute a Capital Calculation Run, the application considered only the dimensions that have the Latest Record Indicator (LRI) as Y.

You can use the BackDated Execution feature to provide BackDated reporting Date as a Run Execution Parameter. Then the application considers only those dimensions for execution that were active during that particular period. You can use backdated execution for Capital Calculation and Post Crisis Reforms Runs.

You must perform a set of configurations to enable the BackDated Execution feature. For more information, see [Oracle Financial Services Analytical Applications Infrastructure User Guide](#).

You must also update the SCD Mode in the DMT Configurations window to enable backdated execution for these Runs. For more information on the SCD Mode for DMT Configurations, refer to the [Oracle Financial Services Analytical Applications Infrastructure User Guide](#).

16.3 Using Process Modelling Framework

16.3.1 Basel CAP PACK Process Modelling Framework Filters and Decision Rules

PMF provides an option to apply filter hierarchies at the Run and/or Business Pipeline level. These filters are similar to the regular filter hierarchies used in rules. They get appended to each task in that business pipeline or Basel Run at run-time based on the applicability of the filter to that task.

In 8.1, CAP PACK makes use of two filter hierarchies, which apply through PMF. The filter hierarchies used are follows:

Figure 150: Filters in CAP Pack

16.3.1.1 Exposure Approach Type

This hierarchy is based on the underlying seeded table FSI_CAP_APPROACH_TYPE_MASTER.

Used mainly to filter data in processing based on the approach selected by the user in the Advanced Run. Approach types are Standardized, Foundation IRB and Advanced IRB. Further, the approach is broken into the following matrix:

Table 151: Approach type to description

V_APPROACH_TYPE	V_APPROACH_TYPE_DESC
OTH	Others
NSSTD	Non-Securitization Standardized

V_APPROACH_TYPE	V_APPROACH_TYPE_DESC
NSFIRB	Non-Securitization FIRB
NSAIRB	Non-Securitization AIRB
SECSTD	Securitization Standardized
SECIRB	Securitization - Internal Rating Based Approach
MRSA	Market Risk Standardized Approach
MRIMM	Internal Models Approach
ORBIA	Basic Indicator Approach (BIA)
ORSA	Standardized Approach (SA)
ORASA	Alternative Standardized Approach (ASA)

For a task, if this table is part of the used tables list, then the filter chosen in the calling business pipeline or run pipeline is applicable to it. Used tables can be either part of the Dataset (for Rules) or Mapped/Non-Mapped column (for T2Ts).

16.3.1.2 Exposure Record Type

This hierarchy is based on the underlying seeded table FSI_CAP_RECORD_TYPE_MASTER. Used mainly to filter data of each portfolio for processing within or across portfolios. Depending upon the portfolio(s) the user picks as part of the run, the record type decides the type of data to be processed by each task in each portfolio. Record types currently supported are follows:

Table 152: Record type and description

V_RECORD_TYPE	V_RECORD_TYPE_DESC
INV_NON_SEC_EXP	Investment Non-Sec Exposure
INV_NON_SEC_ULY	Investment Non-Sec Underlying
INV_SEC_ULY	Investment Sec Underlying
BNK_NON_SEC_EXP	Banking Non-Sec Exposure
BNK_NON_SEC_ULY	Banking Non-Sec Underlying
BNK_SEC_ULY	Banking Sec Underlying
DRV_NON_SEC_EXP	Derivatives Non-Sec Exposure
DRV_NON_SEC_ULY	Derivatives Non-Sec Underlying
DRV_SEC_ULY	Derivatives Sec Underlying
SFT_NON_SEC_EXP	SFT Non-Sec Exposure
SFT_NON_SEC_ULY	SFT Non-Sec Underlying
SFT_SEC_ULY	SFT Sec Underlying

V_RECORD_TYPE	V_RECORD_TYPE_DESC
OTH_PLACED_COLL_EXP	Other Placed Collateral Exposure
SFT_PLACED_COLL_EXP	SFT Placed Collateral Exposure
MITIGANT	Mitigant
SFT_MITIGANT	SFT Mitigant
OTH	Others

A simplified example of such a case can be Investment portfolio and Banking Portfolio for which data sources, besides other sources, are as follows:

- Securitization:
 - Product Processor Tables [main exposures]
 - From PP tables to FSI_CAP_INVESTMENT_EXPOSURES.
 - STG_UNDERLYING_EXPOSURES [Investment underlying exposures which are banking products and investment products]
 - From STG_UNDERLYING_EXPOSURES to FSI_CAP_BANKING_EXPOSURES.
- Banking Portfolio:
 - Product processor Tables [main exposures]
 - From PP tables to FSI_CAP_BANKING_EXPOSURES.

If the user chooses banking and investment portfolios together in a run, the data movement is as follows:

Table 153: Banking and investment portfolios

Banking				
MAIN EXPOSURE TYPE	SOURCE	ULY EXPSOURE TYPE	TARGET	V_RECOR
BANKING	PP TABLES		FSI_CAP_BANKING_EXPOSURES	BNK_NON
Investments				
MAIN EXPOSURE TYPE	SOURCE	ULY EXPSOURE TYPE	TARGET	V_RECOR
INVESTMENT	PP TABLES		FSI_CAP_INVESTMENT_EXPOSURES	INV_NON
INVESTMENT	STG_UNDERLYING_EXPOSURES	BANKING	FSI_CAP_BANKING_EXPOSURES	INV_NON
INVESTMENT	STG_UNDERLYING_EXPOSURES	INVESTMENT	FSI_CAP_INVESTMENT_EXPOSURES	INV_NON

When banking and investments both execute, the record type filter helps processing exposures as follows:

- **Banking Portfolio:**

Only those exposures, which have record type as BNK_NON_SEC_EXP in FSI_CAP_BANKING_EXPOSURES.

- Investment Portfolio:

- Exposures, which have record type as INV_NON_SEC_EXP and INV_NON_SEC_ULTY in FSI_CAP_INVESTMENT_EXPOSURES.
- Exposures, which have record type as INV_NON_SEC_ULTY in FSI_CAP_BANKING_EXPOSURES.

The steps to apply filters at Run and Business Pipeline levels are detailed in [OFS Analytical Applications Infrastructure User Guide](#).

16.3.1.3 Execution and Decision Rules

PMF has a capability to allow the flow of execution to follow a certain path while running a batch. The decision to include/exclude components in a user-defined run is based upon the Run Management Options. This allows the user to manage and report data for only those components, which the user has opted through the Basel Configuration > Run Management screen.

Based upon the selections made in the configuration screen, a table FSI_CAP_RUN_EXE_PARAMETERS is updated with the answers to the questionnaire.

A simple example can be of which portfolios the user has opted. If the user wishes to execute banking and investments only, then a Basel configuration is created through run management with this questionnaire. This configuration is selected during run execution.

16.3.1.4 Evaluation of Execution Rule

The questionnaire data is captured and pushed into the table FSI_CAP_RUN_EXE_PARAMETERS.

The execution rule 'Basel Execution Approach Assignment' reads the data from this table and assigns the values to respective PMF variables.

Figure 154: Basel execution approach

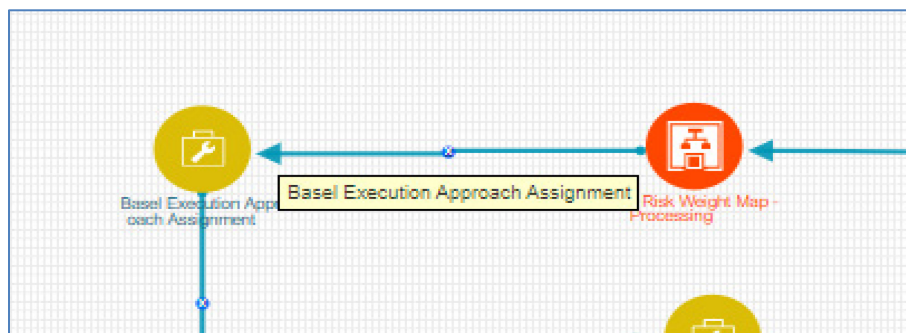

Figure 155: Editing API details

Edit API Details
✕

Name ?

RuleType ?

ExecutionType ?

Table Name ?

Column List ?

Where Condition ?

Return JSON Type ?

Output Datafield ?

Scope ?

16.3.1.5 Evaluation of Decision Rule

The variables, values for which are assigned in the execution rule, are evaluated in the respective transition lines for each applicable component. If the value matches with expected value in the transition line, then that path is taken.

Figure 156: Evaluation of Decision Rule

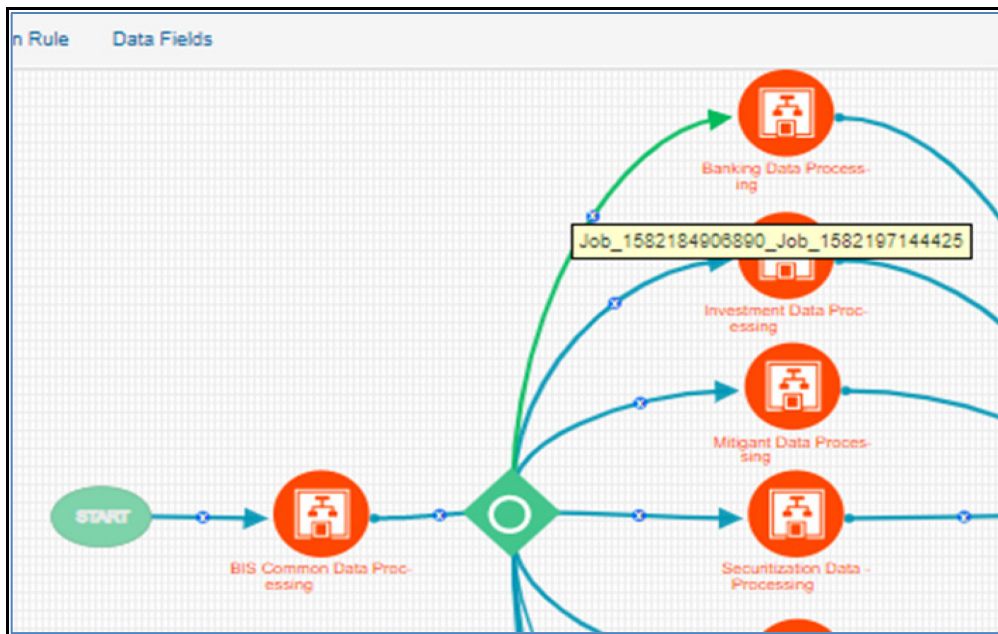

Figure 157: Editing the transition

The 'Edit Transition' dialog box contains the following fields:

- Transition Name: Job_15821849068890_Job_158219714442
- Connected To: Banking Data Processing
- Decision Rule: Basel Banking Portfolio Selection
- Order: 1
- Stroke: Default

An 'Ok' button is located at the bottom right of the dialog.

Figure 158: Editing the transition

The transition configuration form contains the following fields:

- Name: Basel Banking Portfolio Selection
- RuleType: DecisionRule
- ExecutionType: JSON Path Expression
- JSON input: BASEL_EXEC_APPROACH
- JSON Path Expression: \$.F_IS_BANK_APPLICABLE
- Operator: =
- RHS Expression: Y
- Scope: Package

16.3.1.6 Deprecation of Uncovered Record Creation DT and New Logic

The DT, Pop_Uncovered_Mitigant that creates uncovered exposure records in FCT_SUB_EXPOSURE table is deprecated and is replaced with three T2Ts as mentioned as follows:

For the effective optimization of the mitigants, the application used to create a replica of the exposures, with the standard mitigant type as Uncovered. This used to happen with the DT POP_UNCOVERED_MITIGANT.

To handle the revised data flow of processing, this is replaced by three T2Ts as follows:

1. T2T_FSI_CAP_NET_POOL_UNCOV_SUB_EXPOSURES

This T2T creates and inserts one uncovered exposure in FSI_CAP_SUB_EXPOSURES for each nettable pool account from FSI_CAP_NETTABLE_POOL.

2. SUB_EXPOSURES_BANKING_UNCOV_DATA_POP

This T2T creates and inserts one uncovered exposure in FSI_CAP_SUB_EXPOSURES for each exposure from FSI_CAP_BANKING_EXPOSURES.

3. SUB_EXPOSURES_INVESTMENT_UNCOV_DATA_POP

This T2T creates and inserts one uncovered exposure in FSI_CAP_SUB_EXPOSURES for each exposure from FSI_CAP_INVESTMENT_EXPOSURES.

16.3.1.7 Reuse of PMF Process for Underlying or Placed Collateral Data Processing

Investment portfolio requires banking and derivative underlying for its processing and calculations apart from investment exposures.

The banking and derivative underlying exposures must get the respective portfolio treatment (Risk weighting, AD and so on) while being processed under investment portfolio.

To achieve the above, investment portfolio pipeline calls banking portfolio and derivative portfolio pipeline to process the respective underlying and then use the processed or calculated attributes of these underlying to complete investment processing.

Hence investment portfolio reuses the complete Banking and Derivative pipeline (PMF process).

These pipelines are called only for the respective underlying by applying proper process filter on record type for underlying. The record type values can be found in FSI_CAP_RECORD_TYPE_MASTER. The process filter will allow only underlying records to be processed when called from the investment pipeline.

The record type process filter used are as follows:

- BNK_NON_SEC_ULY in Banking pipeline.
- DRV_NON_SEC_ULY in Derivative pipeline

Securitization Portfolio calls Banking portfolio pipeline from within to process non securitized banking underlying exposures which are part of securitized pool and are required for overall processing of the securitization portfolio. The banking pipeline is called with appropriate record type process filter to process only banking underlying exposures.

The record type process filter used is BNK_SEC_ULY in Banking pipeline.

Derivative portfolio and SFT portfolio pipelines call Mitigant pipeline from within to provide mitigant treatment (eligibility, mitigant risk weight and haircut) to their placed collaterals. The mitigant pipeline is called with appropriate record type process filter to process only placed collaterals.

The record type process filter used are follows:

- OTH_PLACED_COLL_EXP in Mitigant pipeline called in Derivative portfolio pipeline.
- SFT_PLACED_COLL_EXP in Mitigant pipeline called in SFT portfolio pipeline.

16.4 Regulatory Definition Setup for Creating a Run

The run definitions created through Regulatory Calculation Definition UI, methods, parameters and options selected here, will be populated in FSI_RUN_PARAMETER table during execution. In this table, selected options are updated against the column names. The column names and values that are updated for the selected option are given in the following tables:

Regulation: Basel III

Table 159: Segment: BIS

FSI_RUN_PARAMETER column name	Securitization item description	Options available	FSI_RUN_PARAMETER column value	Applicable approaches
V_IAA_APPROVAL	Does the bank have supervisory approval for using IAA?	Yes	OPT-YES	Standardized Approach
		No	OPT-NO	
V_SEC_UNCOND_CF_PMT_DATE_AVAIL	Are Contractual Payment Dates of Cash flow available to calculate Tranche Maturity?	Yes	OPT0617	Standardized Approach, IRB Approach
		No	OPT0618	
V_SEC_ERBA_APPROACH_SUP_APRV	Supervisory Approval to use External Ratings Based Approach or Internal Assessment Approach, in case bank is unable to compute using SEC IRB approach?	Yes	OPT0620	Standardized Approach, IRB Approach
		No	OPT0621	
V_SSF_SIMPLE_N_LGD	Supervisory Approval to use Simplified Method for calculating N (Pool Granularity) and LGD (Pool LGD)?	Yes	OPT0611	IRB Approach
		No	OPT0612	

Table 160: The values for the BASEL III regulation with segment as BIS and approach as Market Risk Standardized

FSI_RUN_PARAMETER column name	Market Risk Standardized item description	Options available	FSI_RUN_PARAMETER column value
V_MRS_OPTIONS_METHOD	Options	Simplified Approach	OPT1013
		Delta Plus Approach	OPT1014
V_MRS_INTEREST_RATE_METHOD	Interest Rate Risk	General Market Risk-Duration Method	OPT1003
		General Market Risk-Maturity Method	OPT1004
V_MRS_COMMODITY_RISK_METHOD	Commodity Risk	Simplified Approach	OPT1008
		Maturity Ladder Approach	OPT1009

Table 161: The values for the BASEL III regulation with segment as BIS and approach as non-Securitization

FSI_RUN_PARAMETER column name	Non-Securitization item description	Options available	FSI_RUN_PARAMETER column value	Applicable Approaches
V_NSS_ECA_FOR_SOVERIGN	Supervisory Approval to use ECA Scores for Risk Weighting?	Only for unrated exposures risk weighting	OPT0004	Standardized Approach
		Not applicable for risk weighting	OPT0005	
		For all exposures risk weighting	OPT0006	
V_NSS_RW_OPTION_DPSE	Risk Weighting Approach	Based on Sovereign Rating	OPT0008	Standardized Approach
		Based on Domestic PSE Rating	OPT0009	
V_NSS_RW_OPTION_BANK	Risk Weighting Approach	Based on Sovereign Rating	OPT0012	Standardized Approach
		Based on Bank Rating	OPT0013	
V_NSS_100PCT_RW_CORP	Supervisory Approval to RW all Corporate Exposures at 100%?	Yes	OPT0016	Standardized Approach
		No	OPT0017	
V_NSS_LOWER_RW_CRE	Supervisory Approval to RW CRE Exposures using Preferential RW to a lower RW?	Yes	OPT0020	Standardized Approach
		No	OPT0021	
V_NSS_PASTDUE_FOR_NONPASTDUE	Supervisory Approval to treat non-past due exposures that are risk weighted at 150% RW, on par with past due exposures?	Yes	OPT0024	Standardized Approach
		No	OPT0025	
V_NSS_0_RW_FOR_GOLD	Supervisory Approval to RW Gold held in own vaults, or on allocated basis, at 0%?	Yes	OPT0027	Standardized Approach
		No	OPT0028	
V_NSS_BORROWER_CURRENCY_RAT_MDB	Supervisory Approval to use Domestic Currency Rating for Loans issued in foreign currency?	Yes	OPT0030	Standardized Approach
		No	OPT0031	
V_NS_SFT_METHOD	Securities Financing Transactions - EAD Calculation Approach	Simple Approach	OPT0037	Standardized Approach
		Comprehensive Approach for Collateral Recognition	OPT9009	

V_NS_SFT_METHOD	Securities Financing Transactions - EAD Calculation Approach	VaR Approach for Collateral Recognition	OPT0226	Foundation IRB Approach
		Comprehensive Approach for Collateral Recognition	OPT9009	
V_NS_SFT_METHOD	Securities Financing Transactions - EAD Calculation Approach	VaR Approach for Collateral Recognition	OPT0322	Advanced IRB Approach
		Comprehensive Approach for Collateral Recognition	OPT9009	
V_NS_OTC_METHOD	Derivative Transactions - EAD Calculation Approach	Standardized Approach - CCR	OPT0048	Standardized Approach
V_NS_OTC_METHOD	Derivative Transactions - EAD Calculation Approach	Internal Model Method	OPT0229	Foundation IRB Approach
		Standardized Approach - CCR	OPT0235	
V_NS_OTC_METHOD	Derivative Transactions - EAD Calculation Approach	Internal Model Method	OPT0325	Advanced IRB Approach
		Standardized Approach - CCR	OPT0331	
V_CRM_METHOD	Credit Risk Mitigation Approach	Simple Approach for Collateral Recognition	OPT0053	Standardized Approach
		Comprehensive Approach for Collateral Recognition	OPT0054	
V_NS_HAIRCUT_MET HOD	Volatility and Forex Haircut Estimates	Supervisory Parameters	OPT0056	Standardized Approach
V_NS_HAIRCUT_MET HOD	Volatility and Forex Haircut Estimates	Supervisory Parameters	OPT0056	Foundation IRB Approach , Advanced IRB Approach
		Own Estimated Parameters	OPT0057	
V_NFIR_EXPLICIT_MA T_ADJ	Supervisory Approval to use explicit maturity adjustment for all smaller domestic firms, where the consolidated assets is lesser than the national threshold?	Yes	OPT0203	Foundation IRB Approach
		No	OPT0204	
V_CVA_METHOD	Credit Valuation Adjustment - Capital Calculation Approach	Standardized Approach	OPT0060	Standardized Approach

V_CVA_METHOD	Credit Valuation Adjustment - Capital Calculation Approach	Standardized Approach	OPT0060	Foundation IRB Approach , Advanced IRB Approach
		Advanced Approach	OPT9031	
V_CVA_INCLUDE_SFT	Supervisory Approval to include SFTs for CVA calculation?	Yes	OPT0062	Standardized Approach
		No	OPT0063	
V_CVA_CDS_INDEX_DECOMPOSITION	CDS Index - Data provided has to be decomposed to individual components?	Yes	OPT0065	Standardized Approach
		No	OPT0066	
V_FIDUCIARY_ASSET_DERECOG_OPT	Do all the Fiduciary Assets meet the criteria for derecognition or deconsolidation as per the bank's accounting standards?	Yes	OPT0808	Standardized Approach, Foundation IRB Approach , Advanced IRB Approach
		No	OPT0809	
V_MTM_TO_ICVA_OPTION	Original Expected Exposure computation based on	Mark-to-Market (MTM) Value	OPT0113	Standardized Approach
		Initial Margin Amount (IMA)	OPT0114	
V_SACCR_MULTI_RISK_APPROACH	Risk Category Identification Approach Selection for Instruments belonging to multiple risk categories	Sensitivity-based Method and Fall-Back Approach	OPT0256	Standardized Approach, Foundation IRB Approach , Advanced IRB Approach
		SA-CCR Method and Fall-Back Approach	OPT0257	
		Fall-Back Approach	OPT0258	
V_NIR_SL_PREF_RW	Supervisory Approval to assign preferential risk weights to specialized lending exposures, which fall into Strong and Good category?	Yes	OPT0241	Foundation IRB Approach
		No	OPT0242	
V_NIR_SL_PREF_RW	Supervisory Approval to assign preferential risk weights to specialized lending exposures, which fall into Strong and Good category?	Yes	OPT0337	Advanced IRB Approach
		No	OPT0338	
V_NIR_DEFAULT_RISK_APP	Default Risk - Approach for Calculations	Top Down	OPT0207	Foundation IRB Approach
		Bottom Up	OPT0208	
V_NIR_DEFAULT_RISK_APP	Default Risk - Approach for Calculations	Top Down	OPT0303	Advanced IRB Approach
		Bottom Up	OPT0304	
		Immaterial	OPT0210	

V_NIR_DIL_RISK_IMM ATERIAL	Dilution Risk - Materiality Condition	Material	OPT0211	Foundation IRB Approach
V_NIR_DIL_RISK_IMM ATERIAL	Dilution Risk - Materiality Condition	Immaterial	OPT0306	Advanced IRB Approach
		Material	OPT0307	
V_NIR_1YR_MAT_COR P_PR	Dilution Risk - Supervisory Approval to apply one year maturity for Corporate Purchased Receivables?	Yes	OPT0213	Foundation IRB Approach
		No	OPT0214	
V_NIR_1YR_MAT_COR P_PR	Dilution Risk - Supervisory Approval to apply one year maturity for Corporate Purchased Receivables?	Yes	OPT0309	Advanced IRB Approach
		No	OPT0310	
V_NIR_EQUITY_APPR OACH	Equity Exposures - Capital Calculation Approach	Internal Model Method	OPT0245	Foundation IRB Approach
		Simple Risk Weight Approach	OPT0246	
		PD - LGD Approach	OPT0247	
V_NIR_EQUITY_APPR OACH	Equity Exposures - Capital Calculation Approach	Internal Model Method	OPT0341	Advanced IRB Approach
		Simple Risk Weight Approach	OPT0342	
		PD - LGD Approach	OPT0343	
V_OPTIMIZER_ALLOC ATION_BASIS	Optimization allocation based on	Exposure Amount Post CCF	OPTALLOC1	Standardized Approach
		Exposure Amount Without CCF	OPTALLOC2	
V_EXP_ADJ_PROVISIO NS	Consider Provision Amount for EAD Calculations?	Yes	OPTLE0003	Standardized Approach, Foundation IRB Approach, Advanced IRB Approach
		No	OPTLE0004	

Table 162: The values for the BASEL III regulation with segment as BIS and approach as Operational Risk

FSI_RUN_PARAMETER column name	Operational Risk item description	Options available	FSI_RUN_PARAMETER column value	Applicable Approaches
V_BASEL_OR_CAP_CHRG_LEVEL	Basel Operational Risk Capital Charge Computation Level	Entity Level	OPTENTLVL	Basic Indicator Approach, Standardized Approach , Alternative Standardized Approach
		LOB Level	OPTLOBLVL	

Regulation: Basel III Post Crisis Reforms**Segment: BIS****Table 163: The Values for BASEL III Post Crisis Reforms Regulation with Segment BIS and Approach Securitization Standardized**

FSI_RUN_PARAMETER column name	Securitization item description	Options available	FSI_RUN_PARAMETER column value
V_IAA_APPROVAL	Does the bank have supervisory approval for using IAA?	Yes	OPT-YES
		No	OPT-NO
V_SEC_UNCOND_CF_PMT_DATE_AVAIL	Are Contractual Payment Dates of Cash flow available to calculate Tranche Maturity?	Yes	OPT0617
		No	OPT0618

Table 164: The Values for BASEL III Post Crisis Reforms Regulation with Segment BIS and Approach Non-Securitization Standardized

FSI_RUN_PARAMETER column name	Non-Securitization item description	Options available	FSI_RUN_PARAMETER column value
V_NSS_ECA_FOR_SOVERIGN	Supervisory Approval to use ECA Scores for Risk Weighting?	Only for unrated exposures risk weighting	OPT0004
		Not applicable for risk weighting	OPT0005
		For all exposures risk weighting	OPT0006
V_NSS_RW_OPTION_DPSE	Risk Weighting Approach	Based on Sovereign Rating	OPT0008
		Based on Domestic PSE Rating	OPT0009
V_NSS_RW_OPTION_BANK	Risk Weighting Approach	Based on Sovereign Rating	OPT0012
		Based on Bank Rating	OPT0013

V_NSS_LOWER_RW_CRE	Supervisory Approval to RW CRE Exposures using Preferential RW to a lower RW?	Yes	OPT0020
		No	OPT0021
V_NSS_BORROWER_CY_RAT_MDB	Supervisory Approval to use Domestic Currency Rating for Loans issued in foreign currency?	Yes	OPT0030
		No	OPT0031
V_NS_SFT_METHOD	Securities Financing Transactions - EAD Calculation Approach	Simple Approach	OPT0037
		Comprehensive Approach for Collateral Recognition	OPT9009
V_NS_OTC_METHOD	Derivative Transactions - EAD Calculation Approach	Standardized Approach - CCR	OPT0048
V_CRM_METHOD	Credit Risk Mitigation Approach	Simple Approach for Collateral Recognition	OPT0053
		Comprehensive Approach for Collateral Recognition	OPT0054
V_FIDUCIARY_ASSET_DERECOG_OPT	Do all the Fiduciary Assets meet the criteria for derecognition or deconsolidation as per the bank's accounting standards?	Yes	OPT0808
		No	OPT0809
V_SACCR_MULTI_RISK_APPROACH	Risk Category Identification Approach Selection for Instruments belonging to multiple risk categories	Sensitivity-based Method and Fall-Back Approach	OPT0256
		SA-CCR Method and Fall-Back Approach	OPT0257
		Fall-Back Approach	OPT0258
V_OPTIMIZER_ALLOCATION_BASIS	Optimization allocation based on	Exposure Amount Post CCF	OPTALLOC1
		Exposure Amount Without CCF	OPTALLOC2
V_RW_BASED_NAT_DISCR	Does the Regulator Allow Exposures funded and denominated in same currency to be Risk Weighted at 0%	Yes	OPT-YES
		No	OPT-NO
V_ALLOW_MATERIALY_NOT_DPND	Does the Regulator allow specific risk weighting for property exposures whose repayment are materially dependent on cashflow generated by the property?	Yes	OPT-YES
		No	OPT-NO

V_CSRP_RW_APPROC H	Risk Weighting methodology for Immovable Assets	LTV and Party Risk Weight Based on Split of Exposure	OPTLTV01
		LTV Based Risk Weighting	OPTLTV02
V_RW_OPTION_EXT_ RATING	Does Regulator Allow Usage of External Ratings for Risk Weighting?	Yes	OPT-YES
		No	OPT-NO

16.4.1 Selecting Run Definition for Execution

The Run Definition can be selected by searching or scrolling in the “Regulatory Definition” field while triggering a Run Execution.

Figure 165: Run definitions

The screenshot shows a 'Select Run Params' dialog box with the following fields and values:

- Reporting Date: 02/03/21
- Legal Entity: [Empty]
- Consolidation Type: Please Select
- Reporting Currency: [Empty]
- Significant Currency: Please Select
- Regulatory Definition: Please Select

The 'Regulatory Definition' dropdown is open, showing a search for 'BIS'. The search results list several options:

- BIS - Capital Calculation - Foundation
- IRB Approach
- BIS - Capital Calculation - Advanced
- IRB Approach
- BIS - Capital Calculation -
- Standardized Approach

An 'OK' button is visible next to the search results.

16.4.2 Importing Run Definitions

To import the DMP file, perform the following steps:

1. Rename or delete the existing OOB definitions in the setup.
2. Navigate to the directory path `$FIC_HOME/utility/Migration/conf/`.
3. Create a copy of the file `OBJECTMIGRATION_template.xml` as `OBJECTMIGRATION.xml` and provide appropriate values for the parameters as per the following table:

Table 166: Parameters and their values

Parameter	Value
\$USERID\$	Application User ID
\$LOCALE\$	Locale Information
\$INFODOM\$	Information Domain
\$FOLDER\$	Folder or Segment where you wish to import the definition
MODE	IMPORT
\$FILE_NAME\$	Name of the file to be imported without the .dmp extension
MIGRATION_CODE\$	11

- Place as many unique codes as per the number of definitions available in the dump.

For example: `<OBJECT Code="1000" Type="4003" />`

To find the object codes, you must perform the following steps:

- Execute the following query in the atomic schema to check the existing `N_RUN_PARAM_DEFN_ID` that are in use.

```
SELECT * FROM FSI_RUN_PARAM_DEFINITION_TL;
```
- Use the Object Code in `OBJECTMIGRATION.xml` which does not exist in `N_RUN_PARAM_DEFN_ID` column.

NOTE:

The type must have the value 4003 which represents Regulatory Calculation Definitions.

- Create the following folder structure in the path `$FIC_HOME/utility/Migration:`

```
metadata/restore
```

- Copy the dump file from the installer and place it in the directory path

```
$FIC_HOME/utility/Migration/metadata/restore
```

- Execute the following script located in the directory path

```
$FIC_HOME/utility/Migration/bin/:
```

```
./ObjectMigration.sh
```

Check the availability of definitions in the UI. Migration logs are available in the directory path

```
$FIC_HOME/utility/Migration/logs/migration.log.
```

16.4.3 Exporting Optimizer Definitions

- Navigate to the directory path `$FIC_HOME/utility/Migration/conf/`.
- Create a copy of the file `OBJECTMIGRATION_template.xml` as `OBJECTMIGRATION.xml` and provide appropriate values for the parameters as per the following table:

Table 167: Exporting optimizer definition

Parameter	Value
\$USERID\$	Application User ID
\$LOCALE\$	Locale Information
\$INFODOM\$	Information Domain
\$FOLDER\$	Folder or Segment of the existing definition
MODE	EXPORT
\$FILE_NAME\$	Name of the file to be exported without the .dmp extension
MIGRATION_CODE\$	11

3. Place as many unique codes as per the number of definitions available in the dump.

For example, `<OBJECT Code="1000" Type="4003" />`

To find the object codes, perform the following steps:

- i. Execute the following query in the atomic schema for run definitions:

```
SELECT * FROM FSI_RUN_PARAM_DEFINITION_TL;
N_RUN_PARAM_DEFN_ID is the object code and value of Type is 4003.
```
- ii. Execute the following query in the atomic schema for portfolio definitions:

```
SELECT * FROM FSI_PORTFOLIO_MASTER;
N_PPORTFOLIO_ID is the object code and value of Type is 4002.
```
- iii. Execute the following query in the atomic schema for optimizer definitions:

```
SELECT * FROM FSI_BASEL_OPTIMIZER_MODEL_TL;
N_MODEL_ID is the object code and the value of Type is 4001.
```

4. Execute the following script in the directory path `$FIC_HOME/utility/Migration/bin:`

```
./ObjectMigration.sh
```

The Dump is available in the directory path

```
$FIC_HOME/utility/Migration/metadata/archive.
```

The migration logs are available in file `migration.log` in the directory path

```
$FIC_HOME/utility/Migration/logs.
```

16.4.4 BackDated Execution - Run Execution Parameter

In the previous releases of the application, when you execute a Capital Calculation Run, the application considered only the dimensions that have the Latest Record Indicator (LRI) as Y.

You can use the BackDated Execution feature to provide BackDated reporting Date as a Run Execution Parameter. Then the application considers only those dimensions for execution that were active during that particular period. You can use backdated execution for Capital Calculation and Post Crisis Reforms Runs.

You must perform a set of configurations to enable the BackDated Execution feature. For more information, see [Oracle Financial Services Analytical Applications Infrastructure User Guide](#).

You must also update the SCD Mode in the DMT Configurations window to enable backdated execution for these Runs. For more information on the SCD Mode for DMT Configurations, refer to the [Oracle Financial Services Analytical Applications Infrastructure User Guide](#).

16.5 Data Transformation Details for Portfolio or Module

This section lists the Data Transformation (DT) details for each Portfolio or Module.

See [Oracle Financial Services Basel Data Transformation Details](#) document for more details.

16.5.1 DT Details – Banking

Table 168: DT task name and their process name

DT TASK NAME	PROCESS CODE	PROCESS NAME
Bnk_Map_Ret_Exp	PMFBNK006	BNK_REGULATORY_RETAIL_PORTFOLIO
Bnk_Unrated_Exp_RW_Rat_Asses	PMFBNK013	BNK_ISSUE_ISSUER_ASSESSMENT
Bnk_Issue_Issuer_Assessment	PMFBNK013	BNK_ISSUE_ISSUER_ASSESSMENT

16.5.2 DT Details - Investment

Table 169: DT investment details

DT TASK NAME	PROCESS CODE	PROCESS NAME
Inv_Ind_Mat_Chk_CE_CR_STD	PMFINV011	INV_PRE_CRM_EAD_COMPUTATION_STD
Inv_Unrated_Exp_RW_Rat_Asse	PMFINV017	INV_INV_ISSUE_ISSUER_ASSESSMENT
Inv_Issue_Issuer_Assessment	PMFINV017	INV_INV_ISSUE_ISSUER_ASSESSMENT

16.5.3 DT Details - Derivative

Table 170: DT derivative details

DT TASK NAME	PROCESS CODE	PROCESS NAME
Drv_Unrated_Exp_RW_Rat_Asses	PMFDRV021	DRV_ISSUE_ISSUER_ASSESSMENT
Drv_Issue_Issuer_Assessment	PMFDRV021	DRV_ISSUE_ISSUER_ASSESSMENT
Drv_Mult_Assessment_SCP	PMFDRV043	SOLD_CREDIT_PROTECTION_DATA_PROCESSING
Drv_Mult_Assessment_SCP	PMFDRV056	SOLD_CREDIT_PROTECTION_DATA_PROCESSING_IR

16.5.4 DT Details - Secured Financial Transactions (SFT)

Table 171: DT details SFT details

DT TASK NAME	PROCESS CODE	PROCESS NAME
Sft_Issue_Issuer_Assessment	PMFSFT013	SFT_ISSUE_ISSUER_ASSESSMENT
Sft_Unrated_Exp_RW_Rat_Asses	PMFSFT013	SFT_ISSUE_ISSUER_ASSESSMENT
LR_SFT_Add_On_Amount	PMFSFT055	SFT_LEVERAGE_RATIO_COMPUTATIONS

16.5.5 DT Details – Securitization

Table 172: DT details securitization

DT TASK NAME	PROCESS CODE	PROCESS NAME
Sec_Pool_Param_Assignmnt	PMFSEC002	SEC_POOL_PARAMETER_ASSIGNMENT
Sec_Exp_Cr_Enhs	PMFSEC005	SEC_TRANCHE_CREDIT_ENHANCEMENT_CALCULAT
Subrdntd_Fndd_Amt_Pop	PMFSEC005	SEC_TRANCHE_CREDIT_ENHANCEMENT_CALCULAT
Upd_Pool_Trnch_Param_Exp	PMFSEC008	SEC_POOL_TRANCHE_PARAMETERS_UPDATE_EXPO
Mult_Assessment_Tranche	PMFSEC012	SEC_MULTIPLE_ASSESSMENT
Multiple_Assessment_Sec	PMFSEC012	SEC_MULTIPLE_ASSESSMENT
Avg_Exs_Sprd	PMFSEC014	SEC_INTERPOLATED_RISK_WEIGHT_AND_AVG_EXS
Sec_Interpolated_RW	PMFSEC014	SEC_INTERPOLATED_RISK_WEIGHT_AND_AVG_EXS
Get_Net_Over_Lap_Amt	PMFSEC017	SEC_PRE_CRM_EAD_CALCULATIONS
Resecuritized_Straddling_Sfa	PMFSEC020	SEC_STRADDLING_TRANCHE_PROCESSING
Upd_Pool_Trnch_Param_Exp	PMFSEC025	RESEC_POOL_AND_TRANCHE_PARAMETER_CALCUL
Resecuritized_Straddling_Sfa	PMFSEC026	RESEC_STRADDLING_TRANCHE_PROCESSING
Securitized_Pool_Gran_Cal	PMFSEC051	SEC_POOL_GRANULAR_CALCULATION

16.5.6 DT Details - Market Risk

Table 173: DT details market risk

DT TASK NAME	PROCESS CODE	PROCESS NAME
PC_Cap_Floor	PMFMR0021	Position Conversion Exotic Options
Mkt_Risk_Exp_Creation	PMFMR0021	Position Conversion Exotic Options
Mkt_Risk_Exp_Creation	PMFMR0022	Position Conversion Options
Mkt_Risk_Exp_Creation	PMFMR0023	Position Conversion Basket Futures - Interest Rate
MR_IR_Pos_Offset	PMFMR0024	Market Risk Position Offset

DT TASK NAME	PROCESS CODE	PROCESS NAME
Ind_Mat_Lvl_Chk_CE_MR	PMFMR0024	Market Risk Position Offset
Mkt_Risk_Exp_Creation	PMFMR0025	Position Conversion Swaps
Mkt_Risk_Exp_Creation	PMFMR0027	Position Conversion Hybrid Instruments
Upd_Sp_RW_RM_Time_Band	PMFMR0028	Mkt Risk Specific Risk IR Assignment
Mkt_Risk_CD_Hedging	PMFMR002A	Market Risk Credit Derivatives Offsetting
Mkt_Risk_Exp_Creation	PMFMR002B	Position Conversion Credit Derivatives
PC_Bskt_CDS	PMFMR002B	Position Conversion Credit Derivatives
Mkt_Risk_Exp_Creation	PMFMR0031	Market Risk Depository Receipts
Equity_NonDrv_Offsetting	PMFMR0034	Market Risk Equity Offsetting
Multiple_Assessment_MR	PMFMR0036	Market Risk Sec Specific Risk Charge Calculation
Mr_Sec_IRB_Min_SRC	PMFMR0036	Market Risk Sec Specific Risk Charge Calculation
Mkt_Risk_GenRsk_Comdty	PMFMR003D	Market Risk Generic Risk Charge Calculation Commodity Maturity Approach
Mkt_Risk_GenRsk_IR	PMFMR003E	Market Risk Generic Risk Charge Calculation - IR and E
Mkt_Risk_Cap_Chrg_Forex	PMFMR003K	Market Risk Capital Risk Charge Calculation
MR_Var_sVar_IRC_CRM_Avg	PMFMR0045	Market Risk Var sVar IRC CRM Avg Calculation

16.5.7 DT Details - Operational Risk

Table 174: operation risk DT details

DT TASK NAME	PROCESS CODE	PROCESS NAME
Opr_Risk_Capital_Charge	PMFBISOR002	Operational Risk-Basic Indicator Approach
OR_Capital_Std_App	PMFBISOR003	Operational Risk Alternative Std Approach

16.5.8 DT Details - Capital Structure

Table 175: Capital structure DT details

DT TASK NAME	PROCESS CODE	PROCESS NAME
Deduction_RWA_Cap_Struct	PMFBISCS022	CAPITAL_STRUCTURE_DEDUCTIONS_RWA_EXPOSURE

16.6 Implementing Basel

16.6.1 Rules List for Configuration

The list of rules which customer needs to reconfigure at their site are as follows.

Table 176: Rule list for configuration

Functionality	Reclassification Rule Name
Common	Basel III Capital Consolidation Approach Type Reclassification for an Entity
Common	Credit Rating Reclassification
Common	Party Type Reclassification - STD
Common	Seniority Reclassification
Credit Risk - Non-Securitization	Basel III Equity Product Type Reclassification - STD
Credit Risk - Non-Securitization	Non-Sec Basel II Product Type Reclassification - STD
Counterparty Credit Risk	Netting Agreement Mitigant Type Reclassification - SA - CCR
Counterparty Credit Risk, Market Risk	Basel III Instrument Type Reclassification
Credit Risk - Securitization	Basel III Sec Product Type Reclassification - STD
Capital Structure	Cap Consl Basel Entity Type Reclassification
Market Risk	MR PC Instrument Type Reclassification - Convertible Bond
Market Risk	MR PC Instrument Type Reclassification - Credit Derivatives
Market Risk	MR PC Instrument Type Reclassification - Exotic Instruments
Market Risk	MR PC Instrument Type Reclassification - Forwards and Futures
Market Risk	MR PC Instrument Type Reclassification - Hybrid Instruments
Market Risk	MR PC Instrument Type Reclassification - Options
Market Risk	MR PC Instrument Type Reclassification - Swaps
Operational Risk	OR Internal LoB to Standard LoB Reclassification
Large Exposures	Party Relationship Type Reclassification

16.6.2 Custom Reclassification Rules

See [Configure Rule with Target Members](#) for more information on Custom Reclassification Rules.

16.6.3 Seeded Values Used

To view the seeded values for the following Seeded tables, see [Seeded Tables Data 1](#) and [Seeded Tables Data 2](#).

- DIM_BANDS

- DIM_BASEL_ASSET_CLASS
- DIM_BASEL_BANK_ROLE
- DIM_BASEL_CAP_CONSL_APPR
- DIM_BASEL_CONSL_OPTION_TYPE
- DIM_BASEL_CREDIT_RATING
- DIM_BASEL_EXPOSURE_CLASS
- DIM_BASEL_ISSUER_TYPE
- DIM_BASEL_METHODODOLOGY
- DIM_BASEL_POOL_TYPE
- DIM_BASEL_PRODUCT_TYPE
- DIM_BASEL_TRANSACTION_TYPE
- DIM_CAPITAL_COMP_GROUP
- DIM_CLEARED_TXN_BANK_ROLE
- DIM_COUNTRY
- DIM_CREDIT_RATING
- DIM_CREDIT_STATUS
- DIM_CURRENCY
- DIM_EXPOSURE_UNDERLYING_TYPE
- DIM_GAAP
- DIM_INSTRUMENT_TYPE
- DIM_INTEREST_TYPE
- DIM_MARKET_RISK_CHARGE_TYPE
- DIM_MARKET_RISK_POSITION
- DIM_MARKET_RISK_REP_LINE
- DIM_METHODODOLOGIES
- DIM_MITIGANT_TREATMENT_TYPE
- DIM_MR_ASSET_CLASS
- DIM_MR_COUNTER_PARTY
- DIM_MR_RISK_CLASS
- DIM_MR_TIME_VERTEX
- DIM_PRODUCT_BOOK

- DIM_REG_CAP_ACCT_PURPOSE
- DIM_REG_CAP_EXEMPTION_CRITERIA
- DIM_REG_CAP_GUARANTEE_SCHEME
- DIM_REG_PARTY_RELATIONSHIP_TYPE
- DIM_RISK_TYPE
- DIM_RUN_TYPE
- DIM_SEC_FACILITY_TYPE
- DIM_SECURITIZATION_TYPE
- DIM_STANDARD_ACCT_HEAD
- DIM_STANDARD_COMMODITY
- DIM_STANDARD_COMMODITY_GRADE
- DIM_STANDARD_EVENT_TYPE
- DIM_STANDARD_LOB
- DIM_STANDARD_PARTY_TYPE
- DIM_STANDARD_SENIORITY
- DIM_STD_MITIGANT_TYPE
- REVELEUS_PARAMETER_MASTER

16.7 Basel Analytics Table Population - Reporting T2T

This section provides information on the target and the granularity of tables.

16.7.1 Credit Risk and Counterparty Credit Risk – Non-Securitization

16.7.1.1 Exposure Level Granularity

Table 177: T2T table with details

T2T Name	Description
Account Level Information T2T	<p>These T2T take inputs from different portfolio table (FSI Cap Banking Exposures (FSI_CAP_BANKING_EXPOSURES), FSI Cap Investment Exposures (FSI_CAP_INVESTMENT_EXPOSURES), FSI Cap Derivative Exposures (FSI_CAP_DERIVATIVES), and FSI Cap Securities and Financing transactions (FSI_CAP_SFT_EXPOSURES) and populate Fact Regulatory Capital Account Summary (FCT_REG_CAP_ACCOUNT_SUMMARY)</p> <ul style="list-style-type: none"> • T2T_FRCAS_FSI_CAP_BANKING_EXPOSURES • T2T_FRCAS_FSI_CAP_INVESTMENT_EXPOSURES

T2T Name	Description
	<ul style="list-style-type: none"> T2T_FRCAS_FSI_CAP_DERIVATIVES T2T_FRCAS_FSI_CAP_SFT_EXPOSURES
Assets Sold Information T2T	<p>This T2T take inputs from FSI Cap Banking Exposures (FSI_CAP_BANKING_EXPOSURES) and populate Fact Regulatory Capital Assets Sold Summary (FCT_REG_CAP_ASSET_SOLD_SUMMARY)</p> <ul style="list-style-type: none"> T2T_FCT_REG_CAP_ASSET_SOLD_SUMMARY
Credit Line Information T2T	<p>This T2T populate from FSI Cap Banking Exposures (FSI_CAP_BANKING_EXPOSURES) to Fact Regulatory Capital Credit Line Summary (FCT_REG_CAP_CREDIT_LINE_SUMMARY).</p> <ul style="list-style-type: none"> T2T_FCT_REG_CAP_CREDIT_LINE_SUMMARY
Fixed Asset Level Information T2T	<p>This T2T populate from FSI Cap Investment Exposures (FSI_CAP_INVESTMENT_EXPOSURES) to Fact Regulatory Capital Fixed Asset Summary (FCT_REG_CAP_FIXED_ASST_SUMMARY).</p> <ul style="list-style-type: none"> T2T_FCT_REG_CAP_FIXED_ASST_SUMMARY

16.7.1.2 Placed Collateral Level Granularity

Table 178: Placed collateral level granularity

T2T Name	Description
Placed Collateral Information T2T	<p>This T2T populate Fact Regulatory Capital Placed Collateral Summary (FCT_REG_CAP_PLCD_COLL_SUMMARY) from FSI Placed Collateral (FSI_PLACED_COLLATERAL)</p> <ul style="list-style-type: none"> T2T_FCT_REG_CAP_PLCD_COLL_SUMMARY

16.7.1.3 Counterparty Level Granularity

Table 179: Counterparty T2T level granularity

T2T Name	Description
Counterparty Level Granularity	<p>These T2T take inputs from Fact Counterparty Details (FCT_CCP_DETAILS), and Fact Counterparty Exposure (FCT_COUNTERPARTY_EXPOSURE) and populate Fact Regulatory Counterparty Capital Summary (FCT_REG_CP_CAPITAL_SUMMARY).</p> <ul style="list-style-type: none"> T2T_FRCCS_FCT_CCP_DETAILS T2T_FCT_REG_CP_CAPITAL_SUMMARY
Large Exposure Limits T2T	<p>These T2T take inputs from Fact Party Group Large Exposure (FCT_PARTY_GROUP_LARGE_EXPOSURE) and populate Fact Regulatory Large Exposure Counterparty Limits (FCT_REG_LARGE_EXP_CP_LIMITS).</p> <ul style="list-style-type: none"> T2T_FCT_REG_LARGE_EXP_CP_LIMITS

16.7.1.4 Pool Level Granularity

Table 180: Pool level T2T level granularity

T2T Name	Description
Pool Level Granularity	<p>This T2T take inputs from FSI Cap Nettable Pool (FSI_CAP_NETTABLE_POOL) and populate Fact Regulatory Capital Pool Summary (FCT_REG_CAP_POOL_SUMMARY).</p> <ul style="list-style-type: none"> T2T_FCT_REG_CAP_POOL_SUMMARY

16.7.1.5 Pool and Mitigant Level Granularity

Table 181: Pool and mitigant T2T level granularity

T2T Name	Description
Account Mitigant Level Information T2T	<p>This T2T take inputs from FSI Cap Exposure Mitigant Mapping (FSI_CAP_EXP_MITIGANT_MAPPING) and populate Fact Regulatory Pool Mitigant Mapping (FCT_REG_POOL_MITIGANT_MAP)</p> <ul style="list-style-type: none"> T2T_FRPMM_FSI_CAP_SUB_EXPOSURES

16.7.2 Credit Risk – Securitization

16.7.2.1 Pool Level Granularity

Table 182: Pool level T2T granularity

T2T Name	Description
Securitization Pool Level Information T2T	<p>Below T2T take input from Fact Securitization Pool (FCT_SECURITIZATION_POOL) and populate Fact Regulatory Securitization Pool Summary (FCT_REG_SEC_POOL_SUMMARY)</p> <ul style="list-style-type: none"> T2T_FCT_REG_SEC_POOL_SUMMARY

16.7.2.2 Exposure Level Granularity

Table 183: Exposure level T2T level granularity

T2T Name	Description
Account Level Information T2T	<p>These T2T take inputs from FSI Sub Exposures (FSI_CAP_SUB_EXPOSURES) and populate FSI Basel Exposures Post Crm (FSI_CAP_EXPOSURES_POST_CRM)</p> <ul style="list-style-type: none"> T2T_FSI_CAP_EXPOSURES_POST_CRM

16.7.3 Common Mitigant Flow

16.7.3.1 Mitigant Level Granularity

Table 184: Mitigant T2T level granularity

T2T Name	Description
Mitigant Level Information T2T	Below T2T take input from FSI Cap Mitigants (FSI_CAP_MITIGANTS) and populate Fact Mitigant Regulatory Capital table (FCT_MITIGANT_REG_CAPITAL) <ul style="list-style-type: none"> T2T_FMRC_FSI_CAP_MITIGANTS

16.7.3.2 Mitigant and Account Granularity

Table 185: Mitigant and account T2T level granularity

T2T Name	Description
Account Mitigant Level Information T2T	These T2T populate Fact Regulatory Account Mitigant Mapping (FCT_REG_ACCT_MITIGANT_MAPPING) <ul style="list-style-type: none"> T2T_FRAMM_NET_POOL_EXP_MITIGANT_MAP T2T_FRAMM_FSI_CAP_SUB_EXPOSURES

16.7.4 Operational risk

Table 186: Operational risk T2T level granularity

T2T Name	Description
Operational Risk Level information T2T	Below T2T take input from Fact Operational Risk Data (FCT_OPS_RISK_DATA) and populate Fact Regulatory Operational Risk Capital Summary (FCT_REG_OR_CAPITAL_SUMMARY) <ul style="list-style-type: none"> T2T_FCT_REG_OR_CAPITAL_SUMMARY

16.7.5 Market Risk

16.7.5.1 General Risk Charge Granularity

Table 187: General risk granularity

Description
These T2T take inputs from different tables (Fact Market Risk Interest Rate Capital (FCT_MARKET_RISK_IR_CAPITAL), Fact Market Risk Foreign Exchange Risk Capital (FCT_MARKET_RISK_FOREX_CAPITAL), Fact Market Risk Equity Capital (FCT_MARKET_RISK_EQ_CAPITAL), Fact Market Risk Commodity Capital

Description
(FCT_MARKET_RISK_COM_CAPITAL) and populate Fact Market Risk Capital Summary (FCT_MR_CAPITAL_SUMMARY) <ul style="list-style-type: none"> T2T_FCT_MR_CAPITAL_SUMMARY_FMRIRC T2T_FCT_MR_CAPITAL_SUMMARY_FMRFRXC T2T_FCT_MR_CAPITAL_SUMMARY_FMREQC T2T_FCT_MR_CAPITAL_SUMMARY_FMRCC

16.7.5.2 VaR Granularity

Table 188: VaR granularity details

Description
These T2T take inputs from Fact Market Risk VaR Summary Data (FCT_MR_VAR_SUMMARY_DATA) and populate Fact Market Risk VaR Portfolio Summary (FCT_MR_VAR_PORTFOLIO_SUMMARY) and Fact Market Risk VaR Summary (FCT_MR_VAR_SUMMARY) <ul style="list-style-type: none"> T2T_FCT_MR_VAR_PORTFOLIO_SUMMARY T2T_FCT_MR_VAR_SUMMARY

16.7.5.3 Repline Granularity

Table 189: Description of Repline Granularity

Description
These T2T populate Fact Market Risk Reporting (FCT_MARKET_RISK_REPORTING) from Fact Market Risk Exposures (FCT_REG_MARKET_RISK_EXPOSURES) tables <ul style="list-style-type: none"> MKT_RISK_REPORTING_POP_IR T2T_FCT_REG_MARKET_RISK_EXPOSURES

16.7.6 Forecasted RWA Granularity

Table 190: Description for RWA granularity

T2T Name	Description
Balance Sheet Category Level Forecast Table Information T2T	This T2T take inputs from FSI Forecasted Risk Weighted Assets (FSI_FORECAST_RWA) and populate Fact Forecast Regulatory Capital Summary (FCT_FORECAST_REG_CAP_SUMMARY) <ul style="list-style-type: none"> T2T_FCT_FORECAST_REG_CAP_SUMMARY

16.7.7 Entity Level Capital Accounting Head Granularity

Table 191: Description of Entity Level Information T2T

T2T Name	Description
Entity Level Information T2T	<p>These T2T take inputs from Fact Standard Accounting Head (FCT_STANDARD_ACCT_HEAD) and populate Fact Regulatory Legal Entity(FCT_REG_LE_CAPITAL_SUMMARY)</p> <ul style="list-style-type: none"> T2T_FCT_REG_LE_CAPITAL_SUMMARY

16.8 Basel Analytics Table Population - Processing T2T

These T2T are used to populate tables used for dashboard reporting. This is to ensure data is being brought into the single processing layer, to ensure streamlined reporting, instead of individual portfolio level reporting tables.

Table 192: Processing T2T data

T2T Name	Description
Mitigant Level Information T2T	<p>This T2T take inputs from FSI Mitigants table (FSI_CAP_MITIGANTS) and populate FCT Mitigants table (FCT_MITIGANTS)</p> <ul style="list-style-type: none"> T2T_MITIGANTS_FSI_CAP_MITIGANT
Account Level Information T2T	<p>These T2T take inputs from different portfolio table (FSI Cap Banking Exposures (FSI_CAP_BANKING_EXPOSURES), FSI Cap Investment Exposures (FSI_CAP_INVESTMENT_EXPOSURES), FSI Cap Derivative Exposures (FSI_CAP_DERIVATIVES), and FSI Cap Securities and Financing transactions (FSI_CAP_SFT_EXPOSURES) and populate Fact Non-Sec Exposures (FCT_NON_SEC_EXPOSURES)</p> <ul style="list-style-type: none"> T2T_NON_SEC_FSI_CAP_BANKING_EXPOSURES T2T_NON_SEC_FSI_CAP_DERIVATIVES T2T_NON_SEC_FSI_CAP_INVESTMENT_EXPOSURES T2T_NON_SEC_FSI_CAP_SFT_EXPOSURES
Pool Level Information T2T	<p>This T2T take inputs from FSI Nettable Pool table (FSI_CAP_NETTABLE_POOL) and populate FCT Nettable Pool (FCT_NETTABLE_POOL)</p> <ul style="list-style-type: none"> T2T_NETTABLE_POOL_FCT_NETTABLE_POOL
Account and Mitigant Level Information T2T	<p>This T2T take inputs from FSI Sub Exposures table (FSI_CAP_SUB_EXPOSURES) and populate Fact Sub Exposures (FCT_SUB_EXPOSURES)</p> <ul style="list-style-type: none"> T2T_SUB_EXPOSURES_FCT_SUB_EXPOSURES

17 Annexure C: Frequently Asked Questions

This section addresses some of the frequently asked questions which are as follows:

17.1 Leverage Ratio

Does the application require a different set of input data to execute the Leverage Ratio?

No. Leverage Ratio can be executed on the same set of input data required for normal processing to execute the Basel III Run. The input for leverage ratio is the subset of the data provided for Basel III executions. However, an additional set of data is required (total consolidated asset) for accounting entity which is outside the scope of the consolidation process. As per the Basel III Accord, total consolidated asset value must add up to the Total Exposure Measure calculation for Leverage Ratio.

Can we execute Leverage Ratio if the bank has installed the application for the first time?

Yes, we can compute Leverage Ratio. The application calculates the current month Leverage Ratio and the Leverage Ratio of the previous two months, which is provided as a download by the client or the bank. This information is considered as an input to calculate Regulatory Leverage Ratio. If the previous month's data is not available, then the application considers the value as 0 and computes the Regulatory Leverage Ratio. Also, you have the flexibility to use the current month Leverage Ratio as input for previous two months' leverage ratio, if required.

Can Leverage ratio be calculated on any day during a particular month?

There is no restriction on the execution date for computing Leverage Ratio. Leverage Ratio can be calculated on any given day. However, Leverage Ratio is to be executed based on the month-end data.

As per Basel III requirement, the Leverage Ratio is to be calculated on Tier 1 capital. However, if a particular jurisdiction prescribes to calculate the Leverage Ratio based on Total capital, then can the application support such modifications?

Yes, the application has the flexibility to change the input criteria by adding or deleting the Rule related to capital. To achieve this, modify the Business Processor's BP-Leverage Ratio expression by modifying one of the used measures. Instead of measure CS Net Tier1 capital, add another measure created on Total capital by deleting the existing one. The data model is not affected by such changes.

17.2 Capital Buffers

As per the Basel III Accord, Capital Buffers are required to be maintained from 2016 only. However, if for internal purposes the bank wants to start computing it from 2013 itself, then does the application support such modifications? If yes, then will it consider the required capital ratios as per the transitional arrangement?

Yes, the application supports the calculation of capital buffers from 2013 and it considers the transitional arrangement for the calculations before 2016.

For Example: The application considers the required Tier 1 Ratio in 2013 as 4.5%. For this calculation, no changes are required in the input data as the calculation in the application begins from 2013.

Likewise, the application selects the required values for CET1, Tier 1, and CAR as per the transitional arrangements for years 2013, 2014 and 2015.

While building quartiles, how much Required CET1 is considered for computing Capital Conservation Ratio?

Required CET1 ratio is used for computing the four quartiles or intervals for Capital Conservation Ratio. Since Required CET1 is phased out through a transitional arrangement, the value used in the calculation of quartiles is a maximum of 4.5% or the CET1 required by that specific jurisdiction in that specific year.

The computed value for Available Buffer from CET1 capital is considered for all three buffers. Is there any priority of one buffer over the other?

As per the Basel III Accord, there is no priority given to one buffer over the other. Required Buffer from CET1 capital is compared against the Available Buffer from CET1 capital. Any shortfall or excess is reported at an aggregate level. It cannot be reported for one specific type of buffer. This approach in the application is built as per our interpretation of the Basel guidelines. As per the Basel III Accord, the other two buffers are met through an extension of Capital Conservation Buffer and the accord does not explicitly mention about its priority. The Capital Conservation Ratio for a shortfall is also calculated at an aggregate level and not at individual buffer level.

Can the regulator of the parent jurisdiction prescribe countercyclical buffer requirement different from the one prescribed by the home country's regulator to which the exposure relates to?

As per our interpretation of the Basel III accord, the countercyclical buffer requirements can be different. By default, the requirement that is prescribed by the parent regulator must be used as input data which in turn is used for further calculations.

If one of the exposure countries has not implemented Basel III and the country's regulator have not recommended any buffer, must countercyclical buffer requirement be taken as 0% for the exposures of that country?

No, the countercyclical buffer requirement cannot be taken as 0% as the parent company's regulator has exposure to this country. For a consolidated Run, it depends on the buffer requirement required for all the exposure countries by the parent regulator.

By default, the buffer requirement specified by the parent regulator for each exposure country is included in the input data. Therefore, data is not required to be modified.

As per Basel requirements, all three buffers are calculated from CET1. However, in the future as per guidelines of the Basel Committee on banking supervision, it may be required to be calculated from Tier 1 or CAR. Does the application have a provision for that?

Yes. The application is flexible to compute such changes. It can be modified to compute buffer from Tier 1 capital and CAR. The logic for computing this buffer is similar to the one used for buffer from CET1 capital. The application can calculate buffers from Tier 1 capital, by taking remainder of following:

Excess of Tier1 Capital Ratio over benchmark (6.0 %), after catering to the shortfall, if any, in Tier 2 capital to its respective benchmark level, which is 2%, minus Required Benchmark Buffer from CET1 capital. Hence, Capital Conservation Buffer excludes any additional CET1 needed to 8% Total Capital Ratio.

To calculate buffer from Total Capital, remainder of following is taken:

Excess of Total Capital Ratio over benchmark (8.0%), minus Required Benchmark Buffer from Tier 1 capital.

17.3 Credit Valuation Adjustment

How will the application handle Index Decomposition, if data for index is not provided and index decomposition is selected?

In this case, the application calculates CVA charge without decomposition. The Run can be successfully executed and Index Hedge position is treated without decomposition.

How does the application handle an Index Hedge position marked to the counterparty wherein multiple counterparties which are part of Index and Index decomposition are selected?

The application creates a single name CDS hedge for all the counterparties with which the bank has exposures and is a part of the index. Index position mapped to a counterparty is used only to allocate CVA charge to the counterparty while using Standardized Approach for CVA calculation.

Can IMM approach be selected for Capital Conservation Ratio calculation and standardized approach for CVA Calculation?

No, IMM approach cannot be selected for Capital Conservation Ratio. The application requires CEM method output for computing CVA Charge using Standardized approach.

Can the discount factor be changed which is currently proposed as 5% as per the Basel guideline?

Yes, risk free rate can be changed by modifying Rules. For more information on modifying Rules, see **Error! Reference source not found..**

How is CVA RWA used in the application?

The application calculates CVA RWA and sums it to Credit RWA. CVA RWA is not multiplied by the factor 1.06.

Will the application create a duplicate hedge record from Index Decomposition, if the Run is executed twice?

No, the application does not create a duplicate hedge record. The application checks whether the record already exists and it uses the same. If the record does not exist, then the application creates a hedge record.

17.4 Operational Risk

If the input parameter to calculate the Annual Gross Income is different for other jurisdictions, then can the input parameters be changed?

Yes, you can change the input parameters by adding or deleting the Rule related to Annual Gross Income. To achieve this, modify the BP expression - Ops Risk Annual Gross Income by adding the newly defined measure or deleting the used measure. The data model can undergo changes if the newly added parameter is not captured. The data model changes affect the staging table and the processing table.

Can reclassification rule for mapping of internal LOB to standard LOB be modified?

Yes, you can change Reclassification Rule as per jurisdiction requirement. You must add the mapping in the Rule OR Internal LOB to Standard LOB Reclassification and make an entry into DIM_LOB and DIM_STANDARD_LOB.

17.5 Capital Structure (Basel III)

Are the list of instruments provided for each component of capital that is, CET1, AT1, and T2 fixed or can the list of instrument be extended or reduced to accommodate as per the requirement?

The list of instruments mapped to different components of capital is a bare minimum list. You can add or delete as per their definition of capital by adding or deleting a mapping in the Rule – Non-Sec Standard Product type to capital Comp Group Reclassification for banking book (non securitization) exposures and in Rule – Mkt Risk Instrument type to Capital Comp Group Reclassification for trading book exposures. No data model changes are required.

The criteria to calculate the surplus capital in CET1 for Minority Interest is Minimum CET1 plus the Capital Conservation Buffer. If the criteria changes in the future to include the countercyclical buffer along with CET1 and CCB, then can the application handle such modifications?

The application has the flexibility to include any parameter or delete any parameters to calculate the Minority Interest. In such a case, the Rule can be modified to include additional parameters or delete if required.

Is there any flexibility in the Rule to add or delete any regulatory adjustment line item during the calculation of CET1?

Yes, the application has the capability to add or delete any regulatory adjustment line item. This is handled in the Rule by adding or deleting any regulatory adjustment line item.

Considering that the phase-in treatment criteria specified as per the accord changes in the future where the deduction values and risk-weighting values change, then can this scenario be handled by the application without affecting other sections?

The application is flexible to accommodate any scenario for phase-in treatment. For example: if in the future the phase-in criteria changes from 20%, 40%,60%,80% to 25%, 45%,65%, 85%, then the application has the capability to change the value as well during the phase-in. The deduction amount that is not deducted is to be risk-weighted with some different percentage.

The values in the capital component column of the Setup Capital Heads (FSI_SETUP_CAPITAL_HEAD) must be changed to accommodate this phase-in treatment.

What if the Bank doesn't calculate CR RWA, MR RWA, and OR RWA and directly provides a value against each of this line item?

The application supports such direct download values for RWA in table – STG_STANDARD_ACCT_HEAD against appropriate Standard Account Head identifiers (CAP169 for Credit RWA, CAP090 for Market RWA, and CAP170 for Operational RWA).

17.6 Securitization

The Reporting Bank wants to implement the Securitization aspect of the Credit Risk. The Bank currently does not have the Credit Risk module. How can the Reporting Bank implement only the Securitization module?

If the bank wants to implement Securitization Standardized approach, then data relevant to the exposures, tranche, pool, rating, and mitigant details are expected. If the IRB approach is implemented, then the complete underlying exposure details are expected apart from the previous mentioned details.

The reporting bank has the underlying data and has provided the pool, tranche, and exposures data. Additionally, the reporting bank has also provided the pool and tranche information in the exposures table. In this case, will the application use the data from the pool and tranche table or from the exposures table?

The application expects the data only in either of the following tables:

Pool, tranche, and exposures table with all the pool, tranche, and exposures attribute data only in their respective tables.

Exposures table with the entire exposures attribute and few of the attributes of the pool and tranche.

The application gives a preference to the pool and tranche attributes in the exposures table, compared to the attributes given in the pool and tranche table. In this case, all the computations is based out of the data given in the exposures table.

How does the bank select particular Securitization approach?

As per regulator's guidelines, banks are expected to follow the hierarchy of approaches while implementing IRB approach as follows:

Supervisory Formula Approach (SFA)

Simplified Supervisory Formula Approach (SSFA)

Risk Weight at 1250%

The application supports this hierarchy of approaches. As stated in the accord, the SFA/SSFA approaches are data driven approaches and availability of data drives the approach selection. In case the bank has relevant data of underlying exposures that is required for SFA calculations, it needs to follow SFA approach. Most of banks that are originators and sponsors of deal have this data and some of the investor banks may have it and hence they naturally follow SFA. However, in case the bank does not have this underlying data, it cannot follow SFA approach; such banks can follow SSFA approach by providing parameters that are applicable only to SSFA as direct input to the application.

The reporting bank, who is an investor in securitization transaction, has an unrated securitization exposure. How will this unrated exposure be treated by the application?

The application treats the unrated exposure based on the approach being followed for that exposure. The approach followed is the same for the originator and the investor.

Standardized Approach

In this case, the application calculates the weighted average risk weight of the underlying exposures and assigns this to the exposure.

If the details regarding the underlying exposures are not available, then the unrated exposures are deducted.

Ratings Based Approach

In this case, the application tries to infer the rating based on the presence of the rated subordinate tranche information, belonging to the same pool.

The application tries to identify whether there are any rated subordinate tranche belonging to the same pool, and which has the credit enhancement level less than that of the unrated exposure and which has the residual maturity more than that of the unrated exposure and which has the seniority less than that of

the unrated exposure. The seniority is a number denoting the seniority of the cash flows to that tranche and it starts from the value of 1 which is the senior most tranche.

If the ratings are inferred, then the application assigns the rating to the exposure and hence assigns the corresponding risk weight.

All other processing are the same as other rated exposures.

If the rating cannot be inferred, then the unrated exposures are deducted.

Supervisory Formula Approach

In this case, there is no dependency on the ratings. Hence, it proceeds without any difference in the treatment.

The reporting bank, which is an investor in Securitization Transaction, is provided protection on its securitization exposure with the help of an Nth to Default credit derivative mitigant. How will the application recognize the benefit for this exposure?

The application identifies the nth to default credit derivative protection based on the comparison of the tranche attachment point, initial pool amount, and the cumulative loss amount of the pool. Using this, the application calculates whether the tranche is in default or not. Further, the application counts the number of tranches in default and then compares this number with the defaulted position covered by the mitigant. Hence for this, the entire tranche information of the pool is required, regardless of whether the Bank has an exposure in all those tranches or not.

For example: the exposure held by the bank belongs to tranche T1 and this belongs to the pool P1. Assume that there are a total of 10 tranches being issued out of that pool. (T1 to T10). The mitigant provided is 7th to default credit derivative. Hence, the application recognizes this mitigant only if there are 6 defaults in the basket of exposures (T1 to T10) or else there is an eligible 6th to default credit derivative for the same pool. Assume that the following are the calculations:

The application takes the tranche attachment point and multiplies this with the initial pool amount. This amount is compared by the application with the cumulative loss of the pool. If the amount is less than or equal to the cumulative loss of the pool, then that tranche is in default. Further, the application takes the count of all the tranches which are in default. In the following case, there are 6 defaults in the exposures. This is compared with the defaulted position of the mitigant. Since there are n-1 defaults (7-1 = 6) in the exposure, the mitigant is recognized for this pool. The exposure with the least risk weight and highest seniority is allocated the mitigant and all other exposure combinations mapped to this mitigant iscome ineligible.

Table 193: Tranche details

Tranche ID	Tranche Attachment Point	Associated Pool ID	Initial Pool Amount	Attachment * Pool	Cumulative Loss of the Pool	Defaulted?
T1	0.75	P1	1,000,000.00	750,000.00	300,000.00	N
T2	0.58	P1	1,000,000.00	580,000.00	300,000.00	N
T3	0.45	P1	1,000,000.00	450,000.00	300,000.00	N
T4	0.34	P1	1,000,000.00	340,000.00	300,000.00	N
T5	0.29	P1	1,000,000.00	290,000.00	300,000.00	Y

Tranche ID	Tranche Attachment Point	Associated Pool ID	Initial Pool Amount	Attachment * Pool	Cumulative Loss of the Pool	Defaulted?
T6	0.22	P1	1,000,000.00	220,000.00	300,000.00	Y
T7	0.18	P1	1,000,000.00	180,000.00	300,000.00	Y
T8	0.15	P1	1,000,000.00	150,000.00	300,000.00	Y
T9	0.05	P1	1,000,000.00	50,000.00	300,000.00	Y
T10	0	P1	1,000,000.00	-	300,000.00	Y

The Reporting Bank has multiple exposures mapped to multiple mitigants. How will the application allocate the mitigants to the exposures?

The application uses the optimizer to allocate the mitigants to the exposures. The optimizer constraints in the case of securitization are dependent on the seniority of the exposures, risk weight of the exposures, and the mitigant value assigned to the exposure post the haircut. Assume the following case of exposures and mitigants mapped to each other along with the seniority, risk weight, and the haircut factor.

Table 194: Exposure details

Exposure ID	Exposure amount	Exposure Seniority	Exposure RW	Mitigant ID	Mitigant Amount	Mitigant RW	Haircut Factor
E1	5,000.00	1	0.5	M1	10,000.00	0.2	0.2
E2	3,000.00	2	0.5	M1	10,000.00	0.2	0.4
E3	2,000.00	2	0.5	M1	10,000.00	0.2	0.15
E4	1,500.00	3	1	M1	10,000.00	0.2	0.1
E1	5,000.00	1	0.5	M2	5,000.00	0	0.4
E2	3,000.00	2	0.5	M2	5,000.00	0	0.87
E3	2,000.00	2	0.5	M2	5,000.00	0	0.37
E4	1,500.00	3	1	M2	5,000.00	0	0.64
E1	5,000.00	1	0.5	M3	3,500.00	0.2	0.05
E2	3,000.00	2	0.5	M3	3,500.00	0.2	1
E3	2,000.00	2	0.5	M3	3,500.00	0.2	0.18
E4	1,500.00	3	1	M3	3,500.00	0.2	0.27

The mitigants are assigned to the exposures based on the seniority of the exposures. The mitigants with the least risk weight are assigned first to the exposures. The following is the order in which the mitigants are allocated.

Table 195: Exposure ID and mitigant mapping

Exposure ID	Mitigant ID
E1	M2
E2	M2
E3	M2
E4	M2
E1	M1
E2	M1
E3	M1
E4	M1
E1	M3
E2	M3
E3	M3
E4	M3

The application assigns the exposures to the mitigants based on this order and computes the Post-CRM RWA of the exposures.

Does optimizer work on pool-by-pool basis? Can the user explicitly mention how many pools can be processed at a time?

Yes, the optimizer works on pool-by-pool basis. However, you can specify the number of pools to be processed at a single fund so onh in Optimizer_Config.xml in <PROCESSEDPOOLSIZE> tag.

Is it possible that few of the exposure-mitigant combination can have no pool ids? If so, what happens to those records?

All the records are expected to have pool IDs based on the exposure mitigant combination. If few records do not satisfy the join/filter condition present in pooling definition, then the pool IDs are not assigned. Such records are not considered for optimizer and covered factor is not calculated for those exposures.

17.7 Capital Structure (Basel II)

Is the list of instruments provided for each component of capital that is, T1, T2, and T3 fixed or can the list of instrument be extended or reduced to accommodate as per the requirement?

The list of instrument mapping to different components of capital is a bare minimum list. You can add or delete as per their definition of capital in the Rules – ‘Bank capital Group Components Reclassification’ and ‘STD to Capital Group Components Reclassification’

Is there any flexibility in the Rule to add or delete any regulatory adjustment line item during the calculation of T1 and T2?

Yes, the application has the capability to add or delete any regulatory adjustment line item. This is handled in the rule by adding or deleting any regulatory adjustment line item.

What if the Bank does not calculate any of the CR RWA, MR RWA and OR RWA and directly provides a value against each of these line items?

The application supports and has taken into account for such direct download values for RWA in the table – STG_STANDARD_ACCT_HEAD against appropriate Standard Account Head identifiers (CAP169 for Credit RWA, CAP090 for Market RWA and CAP170 for Operational RWA) for entities for which the bank does not calculate RWA using our application.

17.8 Market Risk (Basel II)

Does the Greeks Engine calculate Greeks parameters for all kind of Options?

Currently, the Greeks Engine calculates parameters only for normal options. The exotic options are not covered by Greeks Engine.

17.9 Mitigant Eligibility (Basel III)

The Reporting Bank has a wholesale exposure and for that guarantee from an issuer is present which can be reclassified under the “Other Entities”. The current rating of the guarantor is B-. How does the application handle this in Basel II and Basel III runs?

The application handles the mitigant eligibility of Basel II and Basel III using separate rules. The application using the Basel III Rule, checks for the presence of a rating for this kind of issuer type and if there is a rating available, then this mitigant becomes eligible. The application under the Basel II rule checks for the rating to be A- or better and if the rating is below A-, then this mitigant becomes ineligible.

17.10 Haircut Assignment (Basel III)

The Reporting Bank has a securitized exposure and for that two financial collaterals are present - a debt instrument from an issuer which can be reclassified under the “Non-Sovereign” issuer type and a debt instrument which is part of a securitization transaction. For the first instrument, the current ratings of the instrument by 2 agencies are AAA and A+ and its residual maturity is 4.5 years. For the second instrument which is a securitized debt exposure, the current rating of the instrument by 2 agencies are A and BBB+, and its residual maturity is 8 years. What is the volatility haircut applied for this mitigant by the application under Basel II and Basel III rules?

The application handles the volatility haircut assignment for debt securities of Basel II and Basel III using separate rules. The application requires a single rating for the debt securities. Since there are multiple ratings, the application applies multiple assessment and calculates the final current rating. In this case, the first mitigant is rated A+ and second mitigant is rated BBB+, post multiple assessment. The application under the Basel III rule checks for the current rating of the debt instrument, its residual maturity, whether the debt security is a securitized exposure or not, and the issuer of the debt security.

For the first mitigant, the current final rating is A+ and it is a debt security issued by a non-sovereign with a residual maturity of 4.5 years. The haircut assigned is 6%.

For the second mitigant, the current final rating is BBB+ and it is a debt security which is a securitized exposure with a residual maturity of 8 years, the haircut assigned is 24%.

The application using the Basel II Rule, checks the current rating of the debt instrument, its residual maturity, and the issuer of the debt security.

For the first mitigant, the current final rating is A+ and it is a debt security issued by a non-sovereign with a residual maturity of 4.5 years. The haircut assigned is 6%.

For the second mitigant, the current final rating is BBB+ and it is a debt security issued by a non-sovereign with a residual maturity of 8 years, the haircut assigned is 12%.

17.11 Cleared Transactions

What is the treatment for the transaction between clearing member and client which arises due to clearing member acting as intermediary for the transaction and reporting bank act as clearing member?

Currently the treatment assigned in the accord is of bilateral trade and application expects user not to identify the previous trades as cleared transaction.

Will the netting agreement be changed for cleared transaction?

No. Trade marked for the Netting agreement is the trading input and risk calculation does not change previous logic.

Since each collateral is treated separately is there a chance that separate risk weight is assigned to different collateral?

No. Risk Weight assigns changes only when the reporting bank is clearing member client and have not posted the collateral and due diligence is not conducted. Application expects the previous condition to be uniform for all the collateral posted, that is, if collateral is cash and securities will either cover all losses or not cover all losses. Data consistency is expected from the user. Moreover the reporting bank to get the transaction cleared from CCP, previous two conditions are mandatory to meet, so the application expects very less trade to go with 4% risk weight.

Will the transaction with non-qualifying CCP have CVA Charge?

No. CVA charge is excluded for the transaction with CCP. Qualifying CCP transactions are given preferential treatment for RW and non-qualifying CCP is treated as bilateral trades. Both trades do not qualify for CVA Charge.

How does the application distinguish between qualifying and non qualifying CCP?

Application expects the user to identify the CCP as qualifying and non-qualifying. Application expects this information as counterparty information. For collateral posted with non-qualifying CCP the application expects other inputs for calculating RWA like, collateral type, pd, lgd, and maturity. Also counterparty type is assumed to be Central Counterparty for the calculation.

Why do application expect the role of the reporting bank with CCP for each transaction?

As per the example in BIS, a CCP also plays a role of Clearing Member for reporting bank transaction with another CCP. This case makes it difficult for the risk system to capture the role of reporting bank at party level and hence is required for each transaction.

18 Glossary

AIRB	Advanced Internal Rating Based
AMA	Advanced Measurement Approach
ASCII	American Standard Code for Information Interchange
BCBS	Basel Committee on Banking Supervision
Bankruptcy Remote	In case of liquidation of the company, if the collateral is bankruptcy remote then legal proceeding will not have the right to liquidate the collateral.
BIS	Bank of International Settlements
CAR	Capital Adequacy Ratio
Central Counterparty (CCP)	Central Counterparty (CCP) is a clearing house that interposes itself between counterparties to contracts traded in one or more financial markets, becoming the buyer to every seller and the seller to every buyer and thereby ensuring the future performance of open contracts.
CCB	Capital Conservation Buffer
CCF	Credit Conversion Factor
CCR	Counterparty Credit Risk
CET1 Ratio	Common Equity Tier 1 Ratio
Clearing Member (CM)	Clearing Member (CM) is a member of, or a direct participant in, a CCP that is entitled to enter into a transaction with the CCP, regardless of whether it enters into trades with a CCP for its own hedging, investment or Capitalization of exposures to central counterparties.
Clearing Member Client (CMC)	Clearing Member Client (CMC) is the client of the Clearing Member and trades are done through clearing member for the client.

CRE	Commercial Real Estate
CRM	Credit Risk Mitigants
CVA	Credit Valuation Adjustment
DeFQ	Data entry and Forms Queries
EAD	Exposure At Default
FFIEC	Federal Financial Institutions Examination Council
FIRB	Foundation Internal Rating Based
FTP	File Transfer Protocol
GL	General Ledger
GRC	General Risk Charge
GUI	Graphic User Interface
IAA	Internal Assessment Approach
IFSB	Islamic Financial Services Board
IMA	Internal Models Approach
IMM	Internal Model Method
IR	Interest Rate
IRB	Internal Rating Based
LGD	Loss Given Default
LIBOR	London Inter Bank Offered Rate
OBIEE	Oracle Business Intelligence Enterprise Edition
OFSAA	Oracle Financial Services Analytical Application
OFSAAI	Oracle Financial Services Analytical Application Infrastructure

OTC	Over the Counter
Non-Securitization Exposure	The exposures that are not securitized by the bank which include, loans, investments, Bonds, Facilities Purchase Receivables and so on are known as Non-Securitized Exposures.
PD	Probability of Default
Private Sector Credit Exposure	A private sector credit exposure is defined as an exposure to a company or an individual that is included in credit risk-weighted assets (excluding an exposure to a sovereign, the Bank for International Settlements, the European Central Bank, the European Commission, the International Monetary Fund, a multilateral development bank (MDB), a public sector entity (PSE), or a government sponsored entity (GSE). The geographic location of a private sector credit exposure is the national jurisdiction of the place the borrower is located in.
Qualifying Central Counterparty (QCCP)	A qualifying central counterparty (QCCP) is an entity that is licensed to operate as a CCP (including a license granted by way of confirming an exemption) and is permitted by the appropriate regulator/overseer to operate as such with respect to the products offered. This is subject to the provision that the CCP is based and prudentially supervised in a jurisdiction where the relevant regulator/overseer has established, and publicly indicated that it applies to the CCP on an ongoing basis, domestic rules and regulations that are consistent with the CPSS-IOSCO Principles for Financial Market Infrastructures.
RBA	Ratings Based Approach
RBI	Reserve Bank of India
RDBMS	Relational Database Management System

Regulatory Reporting	This is a jurisdiction specific requirement. These reporting requirements are over and above the Pillar III reporting requirements and to be submitted to respective regulators.
RRE	Residential Real Estate
RWA	Risk-weighted Assets
SCD	Slowly Changing Dimension
SFA	Supervisory Formula Approach
SFT	Securities Financing Transactions
SRWA	Simple Risk Weight Approach
TXN	Transaction
SLR	Statutory Liquidity Ratio
Stress Testing	Process of defining shocks, stress scenarios and specifying a standalone execution of stress scenarios to obtain the stress values of the variables or mapping a scenario to a Baseline Run
T2T	Table to Table
VaR	Value at Risk

OFSAA Support

Raise a Service Request (SR) in [My Oracle Support \(MOS\)](#) for queries related to the OFSAA applications.

Send Us Your Comments

Oracle welcomes your comments and suggestions on the quality and usefulness of this publication. Your input is an important part of the information used for revision.

- Did you find any errors?
- Is the information clearly presented?
- Do you need more information? If so, where?
- Are the examples correct? Do you need more examples?
- What features did you like most about this manual?

If you find any errors or have any other suggestions for improvement, indicate the title and part number of the documentation along with the chapter/section/page number (if available) and contact the My Oracle Support.

Before sending us your comments, you might like to ensure that you have the latest version of the document wherein any of your concerns have already been addressed. You can access My Oracle Support site that has all the revised or recently released documents.