

# Oracle® Database

## Database Net Services Administrator's Guide



20c  
F16378-01  
February 2020

The Oracle logo, consisting of a solid red square with the word "ORACLE" in white, uppercase, sans-serif font centered within it.

ORACLE®

Oracle Database Database Net Services Administrator's Guide, 20c

F16378-01

Copyright © 2002, 2020, Oracle and/or its affiliates.

Primary Authors: Bharathi Jayathirtha, Mark Bauer

Contributors: Robert Achacoso, Abhishek Dadhich, Santanu Datta, Steve Ding, Feroz Khan, Bhaskar Mathur, Scot McKinley, Srinivas Pamu, Kant Patel, Murali Purayathu, Saravanakumar Ramasubramanian, Sudeep Reguna, Norman Woo

This software and related documentation are provided under a license agreement containing restrictions on use and disclosure and are protected by intellectual property laws. Except as expressly permitted in your license agreement or allowed by law, you may not use, copy, reproduce, translate, broadcast, modify, license, transmit, distribute, exhibit, perform, publish, or display any part, in any form, or by any means. Reverse engineering, disassembly, or decompilation of this software, unless required by law for interoperability, is prohibited.

The information contained herein is subject to change without notice and is not warranted to be error-free. If you find any errors, please report them to us in writing.

If this is software or related documentation that is delivered to the U.S. Government or anyone licensing it on behalf of the U.S. Government, then the following notice is applicable:

U.S. GOVERNMENT END USERS: Oracle programs (including any operating system, integrated software, any programs embedded, installed or activated on delivered hardware, and modifications of such programs) and Oracle computer documentation or other Oracle data delivered to or accessed by U.S. Government end users are "commercial computer software" or "commercial computer software documentation" pursuant to the applicable Federal Acquisition Regulation and agency-specific supplemental regulations. As such, the use, reproduction, duplication, release, display, disclosure, modification, preparation of derivative works, and/or adaptation of i) Oracle programs (including any operating system, integrated software, any programs embedded, installed or activated on delivered hardware, and modifications of such programs), ii) Oracle computer documentation and/or iii) other Oracle data, is subject to the rights and limitations specified in the license contained in the applicable contract. The terms governing the U.S. Government's use of Oracle cloud services are defined by the applicable contract for such services. No other rights are granted to the U.S. Government.

This software or hardware is developed for general use in a variety of information management applications. It is not developed or intended for use in any inherently dangerous applications, including applications that may create a risk of personal injury. If you use this software or hardware in dangerous applications, then you shall be responsible to take all appropriate fail-safe, backup, redundancy, and other measures to ensure its safe use. Oracle Corporation and its affiliates disclaim any liability for any damages caused by use of this software or hardware in dangerous applications.

Oracle and Java are registered trademarks of Oracle and/or its affiliates. Other names may be trademarks of their respective owners.

Intel and Intel Inside are trademarks or registered trademarks of Intel Corporation. All SPARC trademarks are used under license and are trademarks or registered trademarks of SPARC International, Inc. AMD, Epyc, and the AMD logo are trademarks or registered trademarks of Advanced Micro Devices. UNIX is a registered trademark of The Open Group.

This software or hardware and documentation may provide access to or information about content, products, and services from third parties. Oracle Corporation and its affiliates are not responsible for and expressly disclaim all warranties of any kind with respect to third-party content, products, and services unless otherwise set forth in an applicable agreement between you and Oracle. Oracle Corporation and its affiliates will not be responsible for any loss, costs, or damages incurred due to your access to or use of third-party content, products, or services, except as set forth in an applicable agreement between you and Oracle.

# Contents

## Preface

---

Audience	xiv
Documentation Accessibility	xv
Related Documentation	xv
Conventions	xvi

## Part I Understanding Oracle Net Services

---

### 1 Introducing Oracle Net Services

---

1.1 About Oracle Net Services	1-1
1.1.1 Understanding Connectivity	1-1
1.1.1.1 About Client/Server Application Connections	1-2
1.1.1.2 About Web Client Application Connections	1-3
1.1.2 Understanding Manageability	1-5
1.1.2.1 About Location Transparency	1-5
1.1.2.2 About Centralized Configuration and Management	1-6
1.1.2.3 About Quick Installation and Configuration	1-7
1.1.3 Understanding Shared Server Architecture	1-7
1.1.4 Understanding Performance	1-10
1.1.4.1 Listener Queue Size	1-10
1.1.4.2 Session Data Unit Size for Data Transfer Optimization	1-10
1.1.4.3 Persistent Buffer Flushing for TCP/IP	1-11
1.1.4.4 Sockets Direct Protocol	1-11
1.1.4.5 Database Availability	1-12
1.1.5 Understanding Network Security	1-12
1.1.5.1 Firewall Access Control	1-12
1.2 Understanding Database Instances	1-14
1.3 Components of Oracle Net Services	1-16
1.3.1 About Oracle Net	1-16
1.3.1.1 Oracle Net Foundation Layer	1-16
1.3.1.2 Oracle Protocol Support	1-17

1.3.2	About Oracle Net Listener	1-18
1.3.3	About Oracle Connection Manager	1-18
1.3.4	About Networking Tools	1-19
1.3.5	About Oracle Advanced Security	1-20

## 2 Identifying and Accessing the Database

---

2.1	Understanding Database Instances	2-1
2.2	Understanding Database Services	2-3
2.3	Connecting to a Database Service	2-5
2.3.1	About Connect Descriptors	2-6
2.3.1.1	About IPv6 Addresses in Connect Descriptors	2-7
2.3.2	About the Protocol Address	2-8
2.3.3	About Service Registration	2-8
2.3.3.1	Specifying an Instance Name	2-8
2.3.3.2	Specifying a Service Handler	2-8
2.4	Understanding Service Handlers	2-9
2.4.1	About Dispatchers	2-10
2.4.2	About Dedicated Server Processes	2-11
2.4.3	About Database Resident Connection Pooling	2-13
2.5	Understanding Naming Methods	2-14
2.5.1	Choosing a Naming Method	2-15
2.5.2	Establishing a Client Session Using a Naming Method	2-16
2.5.3	Entering a Connect String	2-17
2.5.3.1	Connect Identifier and Connect Descriptor Syntax Characteristics	2-17
2.6	Enhancing Service Accessibility Using Multiple Listeners	2-18
2.6.1	About Connect-Time Failover	2-18
2.6.2	About Transparent Application Failover	2-18
2.6.3	About Client Load Balancing	2-19
2.6.4	About Connection Load Balancing	2-19

## 3 Managing Network Address Information

---

3.1	Using Localized Management	3-1
3.2	Using a Directory Server for Centralized Management	3-2
3.2.1	Understanding the Directory Information Tree	3-3
3.2.1.1	Fully-Qualified Names for Domain Component Namespaces	3-5
3.2.1.2	Fully-Qualified Names for X.500 Namespaces	3-6
3.2.1.3	Using the Relative Name of an Entry	3-7
3.2.1.4	Using the Fully-Qualified Name of an Entry	3-8
3.2.2	Understanding Oracle Context	3-8

3.2.3	Understanding Net Service Alias Entries	3-9
3.2.4	Who Can Add or Modify Entries in the Directory Server	3-11
3.2.5	Client Connections Using Directory Naming	3-12
3.2.6	Considerations When Using Directory Servers	3-12
3.2.6.1	Performance Considerations	3-13
3.2.6.2	Security Considerations	3-13
3.2.6.3	Object Classes	3-16
3.2.7	Limitations of Directory Naming Support with Microsoft Active Directory	3-17

## 4 Understanding the Communication Layers

---

4.1	Understanding Oracle Net Stack Communication for Client/Server Applications	4-1
4.1.1	About the Client Communication Stack	4-4
4.1.1.1	Client Application Layer	4-4
4.1.1.2	Presentation Layer	4-4
4.1.1.3	Oracle Net Foundation Layer	4-4
4.1.1.4	Oracle Protocol Support Layer	4-5
4.1.2	About the Server Communication Stack	4-5
4.2	Using Oracle Net Stack Communication for Java Applications	4-6
4.3	Using Oracle Net Stack Communication for Web Clients	4-6
4.4	Understanding Oracle Protocol Support Layer	4-7
4.4.1	About TCP/IP Protocol	4-7
4.4.1.1	IPv6 Address Notation	4-8
4.4.1.2	IPv6 Interface and Address Configurations	4-10
4.4.1.3	IPv6 Network Connectivity	4-10
4.4.1.4	IPv6 Support in Oracle Database 12c	4-12
4.4.2	About TCP/IP with SSL Protocol	4-12
4.4.3	About Named Pipes Protocol	4-13
4.4.4	About Sockets Direct Protocol (SDP)	4-13
4.4.5	About Exadirect Protocol	4-13
4.4.6	About Websocket Protocol	4-13

## 5 Understanding Oracle Net Architecture

---

5.1	About Service Registration	5-1
5.2	About the Listener and Connection Requests	5-2
5.3	About Oracle Restart	5-3
5.4	About Blocked Connection Requests	5-4
5.5	Understanding Database Server Process Architecture	5-4
5.5.1	About Shared Server Processes	5-4
5.5.2	About Dedicated Server Processes	5-5

5.6	Understanding Oracle Connection Manager Architecture	5-6
5.7	Complete Architecture	5-7

## Part II Configuration and Administration of Oracle Net Services

---

### 6 Quick Start to Oracle Net Services

---

6.1	Prerequisites for Establishing Connectivity	6-1
6.2	Confirming Network Availability	6-2
6.3	Starting Oracle Net Listener and the Oracle Database Server	6-2
6.4	Starting Oracle Connection Manager	6-4
6.5	Connecting to the Database	6-5
6.6	Using Easy Connect to Connect to a Database	6-6

### 7 Managing Oracle Net Services

---

7.1	Using the User Interface Tools	7-1
7.1.1	Using Oracle Enterprise Manager Cloud Control to Configure Oracle Net Services	7-1
7.1.1.1	Accessing the Net Services Administration Page	7-2
7.1.2	Using Oracle Net Manager to Configure Oracle Net Services	7-2
7.1.2.1	Starting Oracle Net Manager	7-3
7.1.2.2	Navigating Oracle Net Manager	7-3
7.1.2.3	Using Oracle Net Manager Wizards	7-3
7.1.3	Deciding When to Use Oracle Enterprise Manager Cloud Control and Oracle Net Manager	7-4
7.1.4	Using Oracle Net Configuration Assistant to Configure Network Components	7-5
7.2	About the OracleNetAdmins Group	7-6
7.2.1	Adding Users To the OracleNetAdmins Group	7-6
7.2.2	Removing Users From the OracleNetAdmins Group	7-7
7.2.3	Changing Ownership of the OracleNetAdmins Group	7-7
7.3	Using Listener Control Utility to Administer the Listener	7-8
7.4	Performing Common Network Tasks	7-9

### 8 Configuring Naming Methods

---

8.1	Understanding the Easy Connect Naming Method	8-1
8.1.1	About Easy Connect Plus	8-3
8.1.2	Examples of Easy Connect Naming Method	8-5
8.1.3	Configuring Easy Connect Naming on the Client	8-14
8.1.4	Configuring Easy Connect Naming to Use a DNS Alias	8-15

8.2	Configuring the Local Naming Method	8-16
8.2.1	Configuring the tnsnames.ora File During Installation	8-17
8.2.2	Configuring the tnsnames.ora File After Installation	8-17
8.3	Configuring the Directory Naming Method	8-24
8.4	Creating Multiple Default Contexts in a Directory Naming Server	8-32
8.5	Exporting Local Naming Entries to a Directory Naming Server	8-33
8.6	Exporting Directory Naming Entries to a tnsnames.ora File	8-36
8.7	Configuring External Naming Methods	8-37

## 9 Configuring and Administering Oracle Net Listener

---

9.1	Overview of Oracle Net Listener	9-1
9.2	Configuring Dynamic Service Registration	9-2
9.2.1	Setting Initialization Parameters for Service Registration	9-3
9.2.2	Registering Information with a Local Listener	9-3
9.2.3	Registering Information with a Remote Listener	9-5
9.2.4	Registering Information with All Listeners in a Network	9-7
9.2.5	Configuring a Naming Method	9-9
9.3	Configuring Oracle Net Listener During Installation	9-10
9.4	Customizing Oracle Net Listener Configuration	9-10
9.4.1	Configuring Listening Protocol Addresses	9-11
9.4.1.1	Configuring Listening Protocol Addresses Using Oracle Enterprise Manager Cloud Control	9-11
9.4.1.2	Configuring Listening Protocol Addresses Using Oracle Net Manager	9-12
9.4.2	Handling Large Volumes of Concurrent Connection Requests	9-12
9.4.3	Managing Oracle Net Listener Security	9-13
9.4.3.1	Specifying Valid Nodes and Subnets	9-13
9.5	Administering the Listener	9-14
9.5.1	Starting and Stopping a Listener	9-14
9.5.1.1	Starting or Stopping a Listener Using the Listener Control Utility	9-15
9.5.1.2	Starting or Stopping a Listener Using Oracle Enterprise Manager Cloud Control	9-16
9.5.2	Managing a Listener in an Oracle Restart Configuration	9-16
9.5.2.1	Viewing Configured Listeners Using the SRVCTL Utility	9-16
9.5.2.2	Adding or Removing a Listener Using the SRVCTL Utility	9-17
9.5.2.3	Starting or Stopping a Listener Using the SRVCTL Utility	9-17
9.5.3	Determining the Current Status of a Listener	9-17
9.5.3.1	Showing Status Using Listener Control	9-18
9.5.3.2	Showing Status Using Oracle Enterprise Manager Cloud Control	9-19
9.5.4	Monitoring Services of a Listener	9-19
9.5.5	Monitoring Listener Log Files	9-21

## 10 Configuring and Administering Oracle Connection Manager

---

10.1	About the cman.ora File	10-2
10.2	How to Configure Oracle Connection Manager	10-4
10.2.1	Configuring the cman.ora file for the Oracle Connection Manager Host	10-4
10.2.1.1	Configure Secure Sockets Layer on the Oracle Connection Manager (CMAN)	10-5
10.2.1.2	Enabling Access Control	10-6
10.2.2	Configuring Clients for Oracle Connection Manager	10-6
10.2.3	Configuring the Oracle Database Server for Oracle Connection Manager	10-8
10.2.3.1	Configuring Service Registration for Use with Oracle Connection Manager	10-8
10.2.3.2	Enabling Session Multiplexing for Oracle Connection Manager	10-9
10.2.4	Configuring Oracle Connection Manager in Traffic Director Mode	10-10
10.2.4.1	Configuring cman.ora File for Oracle Connection Manager in Traffic Director Mode	10-10
10.2.4.2	Configuring a Wallet for Oracle Connection Manager in Traffic Director Mode Proxy Authentication	10-11
10.2.4.3	Configuring Databases for Oracle Connection Manager in Traffic Director Mode Proxy Authentication	10-13
10.2.4.4	Configuring Service Registration with Oracle Connection Manager in Traffic Director Mode	10-13
10.2.4.5	Configuring Proxy Resident Connection Pool in Oracle Connection Manager in Traffic Director Mode	10-13
10.2.4.6	Configuring Oracle Connection Manager in Traffic Director Mode for Unplanned Events	10-15
10.2.4.7	Configuring Oracle Connection Manager in Traffic Director Mode for Planned Down Events	10-16
10.2.4.8	Configuring Secure Sockets Layer on Oracle Connection Manager in Traffic Director Mode	10-16
10.2.4.9	Oracle Connection Manager in Traffic Director Mode Restrictions	10-17
10.3	Using Oracle Connection Manager as a Bridge for IPv4 and IPv6	10-18
10.4	Using the Oracle Connection Manager Control Utility to Administer Oracle Connection Manager	10-20
10.5	About Using Oracle Connection Manager in Traffic Director Mode	10-21
10.5.1	Enhancements to Oracle Connection Manager in Traffic Director Mode	10-24
10.6	About CMCTL REST Interface	10-24
10.6.1	Configuring CMCTL REST Interface	10-25
10.6.2	REST APIs for CMCTL Commands	10-26
10.7	Migrating CMAN Sessions During Patching	10-27



## 11 Configuring a Shared Server Architecture

---

11.1	How Oracle Net Manages Client Loads	11-1
11.2	About Dispatchers	11-1
11.2.1	Grouping Services by Dispatcher	11-2
11.2.2	Monitoring Dispatchers	11-3
11.3	Enabling Session Multiplexing	11-3
11.4	Configuring Clients for Environments with Both Shared and Dedicated Servers	11-4

## 12 Configuring Profiles

---

12.1	Overview of Profile Configuration	12-1
12.2	Configuring the Profile During Installation	12-1
12.3	Understanding Client Attributes for Names Resolution	12-2
12.3.1	About the Default Domain for Clients	12-2
12.3.1.1	Specifying a Default Domain	12-2
12.3.2	Prioritizing Naming Methods	12-3
12.3.3	Routing Connection Requests to a Process	12-4
12.4	Settings for Database Access Control	12-5
12.4.1	Configuring Database Access Control	12-5
12.5	About Advanced Profile Information	12-6
12.5.1	Setting the Advanced Features in the sqlnet.ora File Using Oracle Net Services	12-9
12.6	Configuring External Naming Methods	12-10
12.7	Configuring Oracle Network Security	12-10

## 13 Enabling Advanced Features of Oracle Net Services

---

13.1	Configuring Advanced Network Address and Connect Data Information	13-1
13.1.1	Creating a List of Listener Protocol Addresses	13-1
13.1.2	About the Address List Parameters	13-4
13.1.2.1	Configuring Address List Parameters	13-6
13.1.3	About the Advanced Connect Data Parameters	13-6
13.2	Understanding Connection Load Balancing	13-8
13.2.1	Example of Connection Load Balancing for Shared Server Configuration	13-9
13.2.2	Example of Connection Load Balancing for Dedicated Server Configuration	13-12
13.2.3	COLOCATION_TAG of Client Connections	13-14
13.3	Configuring Transparent Application Failover	13-15

13.3.1	About Transparent Application Failover	13-15
13.3.2	What Transparent Application Failover Restores	13-16
13.3.3	About the FAILOVER_MODE Parameters	13-17
13.3.4	Implementing Transparent Application Failover	13-18
13.3.4.1	TAF with Connect-Time Failover and Client Load Balancing	13-18
13.3.4.2	TAF Retrying a Connection	13-18
13.3.4.3	TAF Pre-establishing a Connection	13-19
13.3.5	Verifying Transparent Application Failover	13-19
13.4	Specifying the Instance Role for Primary and Secondary Instance Configurations	13-20
13.5	Understanding Static Service Registration	13-23
13.5.1	Configuring Static Registration for the Listener	13-24
13.6	Configuring Connections to Third-Party Database Services	13-26
13.6.1	Default Configuration for External Procedures	13-26
13.6.1.1	Configuring Oracle Net Services for External Procedures	13-29
13.6.2	About Oracle Net Services for Oracle Heterogeneous Services	13-33
13.6.2.1	Configuring Oracle Database to Connect to Agents	13-33
13.6.3	Configuring Oracle Net Services for an Oracle Rdb Database	13-35

## 14 Optimizing Performance

---

14.1	Understanding the Benefits of Network Data Compression	14-1
14.2	Configuring Session Data Unit	14-1
14.2.1	Setting the SDU Size for the Database	14-2
14.2.2	Setting the SDU Size for the Client	14-3
14.3	Determining the Bandwidth-Delay Product	14-3
14.4	Configuring I/O Buffer Space	14-4
14.4.1	Configuring I/O Buffer Size on the Server	14-5
14.4.1.1	Setting the Buffer Size Parameter for Shared Server Processes	14-6
14.4.2	Configuring I/O Buffer Space on the Client	14-6
14.5	Configuring SDP Support for InfiniBand Connections	14-6
14.5.1	Prerequisites for Using SDP	14-7
14.5.2	Configuring SDP on the Server	14-7
14.5.3	Configuring SDP on the Client	14-8
14.6	Configuring Exadirect Support for InfiniBand Connections	14-9
14.6.1	Prerequisites for Using Exadirect	14-9
14.6.2	Configuring Exadirect on the Server	14-10
14.6.3	Configuring Exadirect on the Client	14-10
14.7	Limiting Resource Consumption by Unauthorized Users	14-10
14.8	About Data-Dependent Routing	14-12

## Part III Testing and Troubleshooting Oracle Net Services

---

### 15 Testing Connections

---

15.1	Testing the Network	15-1
15.2	Using the TNSPING Utility to Test Connectivity from the Client	15-2
15.3	Using the TRCROUTE Utility to Test Connectivity from the Client	15-4

### 16 Troubleshooting Oracle Net Services

---

16.1	Understanding Automatic Diagnostic Repository	16-1
16.1.1	ADRCI: ADR Command Interpreter	16-5
16.2	Diagnosing Oracle Net Services	16-6
16.2.1	Diagnosing Server Problems	16-6
16.2.2	Diagnosing Client Problems	16-8
16.3	Resolving the Most Common Error Messages for Oracle Net Services	16-11
16.3.1	ORA-03113: End-of-file on Communication Channel	16-12
16.3.2	ORA-12154: Could Not Resolve the Connect Identifier Specified	16-12
16.3.2.1	ORA-12154 Error When Using the Local Naming Method	16-13
16.3.2.2	ORA-12154 Error When Using the Directory Naming Method	16-13
16.3.2.3	ORA-12154 Error When Using the Easy Connect Naming Method	16-14
16.3.2.4	ORA-12154 Error When Using the External Naming Method	16-14
16.3.3	ORA-12170: Connect Timeout Occurred	16-14
16.3.4	TNS-12500 or ORA-12500: Listener Failed to Start a Dedicated Server Process	16-15
16.3.5	ORA-12514: Listener Does Not Currently Know of Service Requested in Connect Descriptor	16-16
16.3.6	ORA-12520: Listener Could Not Find Available Handler for Requested Type of Server	16-16
16.3.7	ORA-12521: Listener Does Not Currently Know of Instance Requested in Connect Descriptor	16-17
16.3.8	ORA-12525: Listener Has Not Received Client's Request in Time Allowed	16-17
16.3.9	ORA-12533: Illegal Address Parameters	16-18
16.3.10	TNS-12540 or ORA-12540: TNS:Internal Limit Restriction Exceeded and TNS-00510: Internal Limit Restriction Exceeded	16-18
16.3.11	TNS-12541 or ORA-12541: TNS:No Listener	16-19
16.3.12	TNS-12549 or ORA-12549: TNS:Operating System Resource Quota Exceeded and TNS-00519: Operating System Resource Quota Exceeded	16-19

16.3.13	TNS-12560 or ORA-12560: TNS:Protocol Adapter Error Occurred	16-19
16.3.14	Directory Naming Errors	16-20
16.4	Troubleshooting Suggestions for Oracle Net Services	16-21
16.4.1	Questions to Consider When Troubleshooting Oracle Net Services	16-21
16.5	Example of Troubleshooting a TNS-12154 Error	16-22
16.6	Logging Error Information for Oracle Net Services	16-22
16.6.1	Oracle Net Error Stacks	16-23
16.6.1.1	Understanding Error Stack Messages	16-23
16.6.2	Oracle Net Services Log File Names	16-24
16.6.3	Oracle Network Log File Segmentation	16-25
16.6.4	About the Logging Parameters	16-25
16.6.4.1	sqlnet.ora Log Parameters	16-26
16.6.4.2	listener.ora Log Parameters	16-26
16.6.4.3	cman.ora Log Parameters	16-27
16.6.5	Setting Logging Parameters in Configuration Files	16-28
16.6.5.1	Setting Parameters for the sqlnet.ora File Using Oracle Net Manager	16-28
16.6.5.2	Setting Parameters for the listener.ora File Using Oracle Enterprise Manager Cloud Control	16-28
16.6.5.3	Setting Parameters for the listener.ora File Using Oracle Net Manager	16-29
16.6.6	Setting Logging During Control Utilities Runtime	16-29
16.6.7	Using Log Files	16-30
16.6.8	Analyzing Listener Log Files	16-30
16.6.8.1	Listener Log Audit Trail Information	16-30
16.6.8.2	Listener Service Registration Event Information	16-32
16.6.8.3	Listener Direct Hand-Off Information	16-33
16.6.8.4	Listener Subscription for ONS Node Down Event Information	16-34
16.6.8.5	Listener Oracle Clusterware Notification Information	16-34
16.6.9	Analyzing Oracle Connection Manager Logs	16-34
16.7	Tracing Error Information for Oracle Net Services	16-37
16.7.1	Understanding Oracle Net Services Trace File Names	16-38
16.7.2	Setting Tracing Parameters	16-38
16.7.2.1	cman.ora Trace Parameters	16-39
16.7.2.2	listener.ora Trace Parameters	16-39
16.7.2.3	sqlnet.ora Trace Parameters	16-41
16.7.2.4	Setting Tracing Parameters in Configuration Files	16-44
16.7.3	Setting Tracing During Control Utilities Runtime	16-46
16.7.4	Evaluating Oracle Net Services Trace Files	16-46
16.7.4.1	Flow of Data Packets Between Network Nodes	16-46
16.7.4.2	Oracle Net Data Packet Formats	16-47
16.7.4.3	Pertinent Oracle Net Trace Error Output	16-48

16.7.5	Using the Trace Assistant to Examine Trace Files	16-51
16.7.5.1	Trace Assistant Syntax	16-51
16.7.5.2	Packet Examples	16-53
16.7.5.3	Two-Task Common (TTC) Packet Examples	16-57
16.7.5.4	Connection Example	16-62
16.7.5.5	Statistics Example	16-65
16.8	Contacting Oracle Support Services	16-65

# Preface

*Oracle Database Net Services Administrator's Guide* describes how to use Oracle Net Services. This guide describes the Oracle Net Services product and its components, as well as Oracle Net Services administrative and deployment topics.

- [Audience](#)
- [Documentation Accessibility](#)
- [Related Documentation](#)
- [Conventions](#)

## Audience

*Oracle Database Net Services Administrator's Guide* is intended for the following readers:

- Network administrators
- Directory server administrators
- Database administrators
- Decision makers

This guide is especially targeted for network administrators who are responsible for ensuring connectivity. For network administrators, Oracle recommends:

- For a conceptual understanding of Oracle Net Services, read all of [Understanding Oracle Net Services](#)
- For essential configuration instructions, read all of [Configuration and Administration of Oracle Net Services](#)
- For troubleshooting, read [Testing and Troubleshooting Oracle Net Services](#)

For directory administrators, Oracle recommends:

- For understanding how Oracle Net Services uses a directory server, read [Managing Network Address Information](#) in [Understanding Oracle Net Services](#)
- For instructions about configuring naming information in a directory server, and exporting existing naming data to a directory server, read [Configuring Naming Methods](#) in [Configuration and Administration of Oracle Net Services](#)

For database administrators, Oracle recommends:

- For a general understanding of networking, read [Introducing Oracle Net Services](#) and [Quick Start to Oracle Net Services](#)
- For an overview of communication layers, read [Understanding the Communication Layers](#)

- For understanding how to configure Oracle database server features that require listener and shared server configuration, read [Configuring and Administering Oracle Net Listener](#), [Configuring a Shared Server Architecture](#), and [Optimizing Performance](#)

For decision makers, Oracle recommends

- For an understanding of how Oracle Net Services fits into the overall network architecture and for explaining the basics of Oracle Net Services, read [Introducing Oracle Net Services](#), [Managing Network Address Information](#), and [Quick Start to Oracle Net Services](#)

Oracle recommends that all readers look over [Understanding Oracle Net Services](#), to ensure that they have the background required to benefit from the rest of the guide.

## Documentation Accessibility

For information about Oracle's commitment to accessibility, visit the Oracle Accessibility Program website at <http://www.oracle.com/pls/topic/lookup?ctx=acc&id=docacc>.

### Access to Oracle Support

Oracle customers that have purchased support have access to electronic support through My Oracle Support. For information, visit <http://www.oracle.com/pls/topic/lookup?ctx=acc&id=info> or visit <http://www.oracle.com/pls/topic/lookup?ctx=acc&id=trs> if you are hearing impaired.

## Related Documentation

For additional information, see the following Oracle resources:

- *Oracle Database Net Services Reference*
- Oracle Database 18c documentation set
- *Oracle Database Global Data Services Concepts and Administration Guide*

Many books in the documentation set use the sample schemas of the seed database, which is installed by default when you install Oracle Database. Refer to *Oracle Database Sample Schemas* for information about how these schemas were created and how you can use them yourself. Oracle error message documentation is only available in HTML.

To download free release notes, installation documentation, white papers, or other collateral, visit the Oracle Technology Network. You must register online before using Oracle Technology Network; registration is free and can be done at

<http://www.oracle.com/technetwork/index.html>

If you already have a user name and password for Oracle Technology Network, then you can go directly to the documentation section of the Oracle Technology Network website at

<http://docs.oracle.com/>

For information about the OSI, see:

---

<http://www.ietf.org>

## Conventions

The examples for directories in the book are for Linux. Unless otherwise noted, Microsoft Windows directory paths are the same except that they use a backslash (\) instead of the forward slash (/).

The following text conventions are used in this document:

---

Convention	Meaning
<b>boldface</b>	Boldface type indicates graphical user interface elements associated with an action, or terms defined in text or the glossary.
<i>italic</i>	Italic type indicates book titles, emphasis, or placeholder variables for which you supply particular values.
monospace	Monospace type indicates commands within a paragraph, URLs, code in examples, text that appears on the screen, text that you enter, file names and directory names.

---



# Part I

## Understanding Oracle Net Services

Part I provides an overview of Oracle Net Services concepts, products, and tools.

This part contains the following chapters:

- [Introducing Oracle Net Services](#)
- [Identifying and Accessing the Database](#)
- [Managing Network Address Information](#)
- [Understanding the Communication Layers](#)
- [Understanding Oracle Net Architecture](#)

# 1

## Introducing Oracle Net Services

Understand the basic elements of Oracle Net Services architecture and the Oracle Net foundation layer.

- [About Oracle Net Services](#)
- [Understanding Database Instances](#)
- [Components of Oracle Net Services](#)

### 1.1 About Oracle Net Services

Oracle Net Services provides enterprise-wide connectivity solutions in distributed, heterogeneous computing environments. Oracle Net Services eases the complexities of network configuration and management, maximizes performance, and improves network diagnostic capabilities.

 **Note:**

The terms "SQL\*Net" and "Net Services" are used interchangeably throughout Oracle documentation and both these terms refer to the same functionality.

This section introduces the basic networking concepts involved in a typical network configuration.

- [Understanding Connectivity](#)
- [Understanding Manageability](#)
- [Understanding Shared Server Architecture](#)
- [Understanding Performance](#)
- [Understanding Network Security](#)

#### 1.1.1 Understanding Connectivity

Oracle Net, a component of Oracle Net Services, enables a network session from a client application to an Oracle Database server. When a network session is established, Oracle Net acts as the data courier for both the client application and the database. It is responsible for establishing and maintaining the connection between the client application and database, as well as exchanging messages between them. Oracle Net is able to perform these jobs because it is located on each computer in the network.

- [About Client/Server Application Connections](#)
- [About Web Client Application Connections](#)

### 1.1.1.1 About Client/Server Application Connections

Oracle Net enables connections from traditional client/server applications to Oracle Database servers. [Figure 1-1](#) shows how Oracle Net enables a network connection between a client and a database server. Oracle Net is a software component that resides on both the client and the database server. Oracle Net is layered on top of network Oracle protocol support, rules that determine how applications access the network and how data is subdivided into packets for transmission across the network. In the following figure, Oracle Net communicates with TCP/IP to enable computer-level connectivity and data transfer between the client and the database.

**Figure 1-1 Client/Server Application Connection**

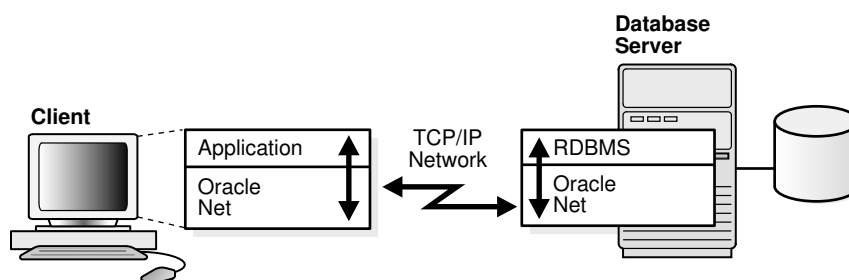

Specifically, Oracle Net is comprised of the Oracle Net foundation layer, which establishes and maintains connections, and Oracle protocol support, which maps the foundation layer technology to industry-standard protocols.

- [Java Client Application Connections](#)

#### 1.1.1.1.1 Java Client Application Connections

Java client applications access an Oracle database through a Java Database Connectivity (JDBC) Driver, a standard Java interface for connecting from Java to a relational database. Oracle offers the following drivers:

- JDBC OCI Driver for client-side use with an Oracle client installation.
- JDBC Thin Driver, a pure Java driver for client-side use without an Oracle installation, particularly with applets.

These drivers use Oracle Net to enable connectivity between a client application and an Oracle database.

The following figure shows a Java client application using a JDBC OCI driver and an Oracle Database server. The Java client application makes calls to the JDBC OCI driver, which translates the JDBC calls directly into the Oracle Net layer. The client then uses Oracle Net to communicate with Oracle Database that is also configured with Oracle Net.

**Figure 1-2 Java Application Connection**

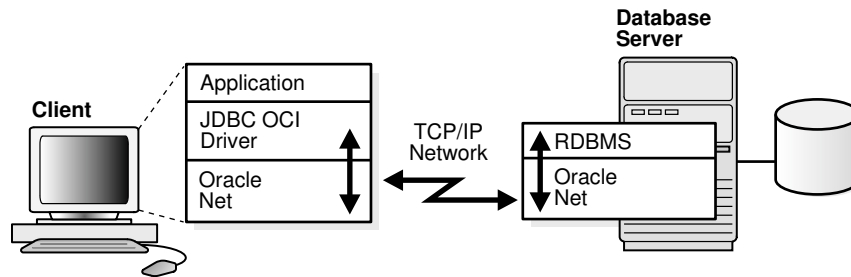

 **See Also:**

- *Oracle Database JDBC Developer's Guide*
- *Oracle Database JDBC Java API Reference*

### 1.1.1.2 About Web Client Application Connections

Internet connections from client web browsers to an Oracle Database server are similar to client/server applications, except that the connection request goes to an application web server.

Figure 1-3 shows the basic architecture for web client connections, including a client web browser, an application web server, and an Oracle Database server. The browser on the client communicates with HTTP to the web server to make a connection request. The web server sends the request to an application where it is processed. The application then uses Oracle Net to communicate with the Oracle Database server that also is configured with Oracle Net.

**Figure 1-3 Web Client Connections through Application Web Server**

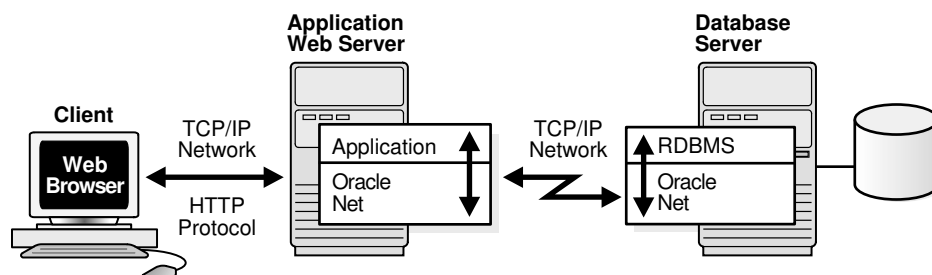

The basic components have the following characteristics:

- **HyperText Transport Protocol (HTTP)**  
HTTP provides the language that enables web browsers and application web servers to communicate.

- Application Web Server  
An application web server manages data for a website, controls access to that data, and responds to requests from web browsers. The application on the web server communicates with the database and performs the job requested by the web server.
- [Web Client Connections Through Java Application Web Server](#)
- [Web Client Connections Without an Application Web Server](#)

### 1.1.1.2.1 Web Client Connections Through Java Application Web Server

An application web server can host Java applications and servlets, as shown in [Figure 1-4](#). Web browsers make a connection request by communicating through HTTP to an application web server. The application web server sends the request to an application or a servlet, which uses a JDBC OCI or a JDBC Thin driver to process the request. The driver then uses Oracle Net to communicate with the Oracle Database server that also is configured with Oracle Net.

**Figure 1-4 Web Client Connections Through Java Application Web Server**

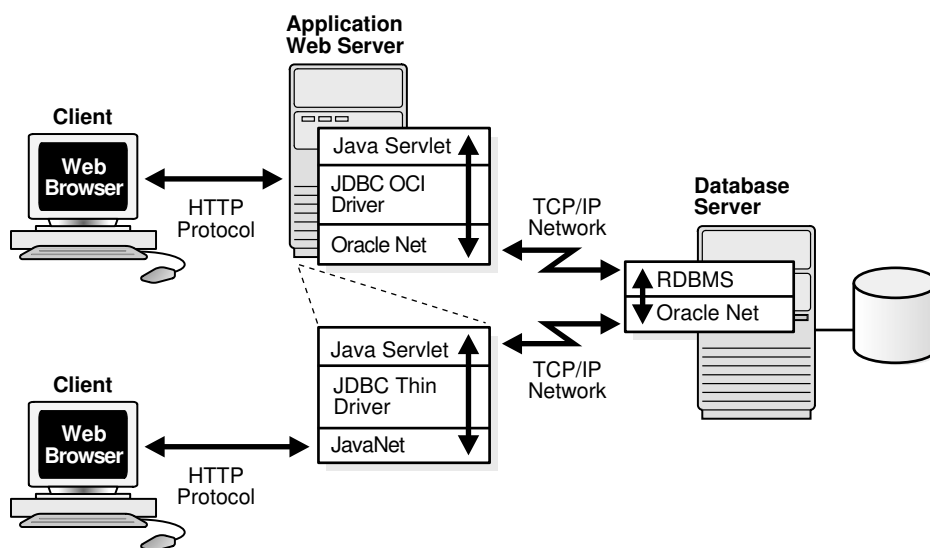

### 1.1.1.2.2 Web Client Connections Without an Application Web Server

Web clients that do not require an application web server to access applications can access Oracle Database directly, for example, by using a Java applet. In addition to regular connections, the database can be configured to accept HTTP protocol, FTP, or WebDAV protocol connections. These protocols are used for connections to Oracle XML DB in the Oracle Database instance.

The following figure shows two different web clients. The first web client makes an HTTP connection to the database. The second web client uses a web browser with a JDBC Thin driver, which in turn uses a Java version of Oracle Net called JavaNet to communicate with the Oracle Database server that is configured with Oracle Net.

 **See Also:**

*Oracle XML DB Developer's Guide*

**Figure 1-5 Web Client Connection Scenarios**

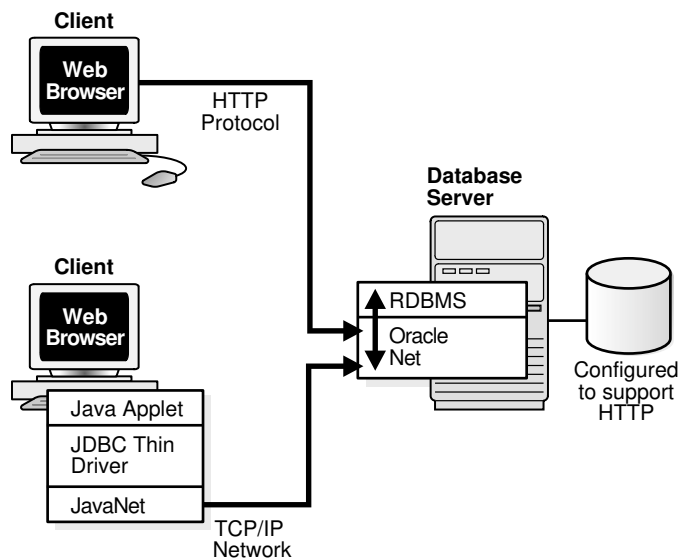

## 1.1.2 Understanding Manageability

Oracle Net Services offers several manageability features to configure and manage networking components.

- [About Location Transparency](#)
- [About Centralized Configuration and Management](#)
- [About Quick Installation and Configuration](#)

### 1.1.2.1 About Location Transparency

Each database is represented by one or more services. A service is identified by a service name, for example, `sales.us.example.com`. A client uses a service name to identify the database it must access. The information about the database service and its location in the network is transparent to the client because the information needed for a connection is stored in a repository.

The repository is represented by one or more naming methods. A naming method is a resolution method used by a client application to resolve a connect identifier to a connect descriptor when attempting to connect to a database service. Oracle Net Services offers several naming methods that support localized configuration on each client, or centralized configuration that can be accessed by all clients in the network.

For example, in the following figure, a company has three databases that clients can access. Each database has a distinct service name, such as `sales.us.example.com`, `hr.us.example.com`, and `mktg.us.example.com`.

1. The client uses the repository to find the information it needs for `sales.us.example.com`.
2. After the client has the information it needs, it connects to the database.

**Figure 1-6 Service Information Repository**

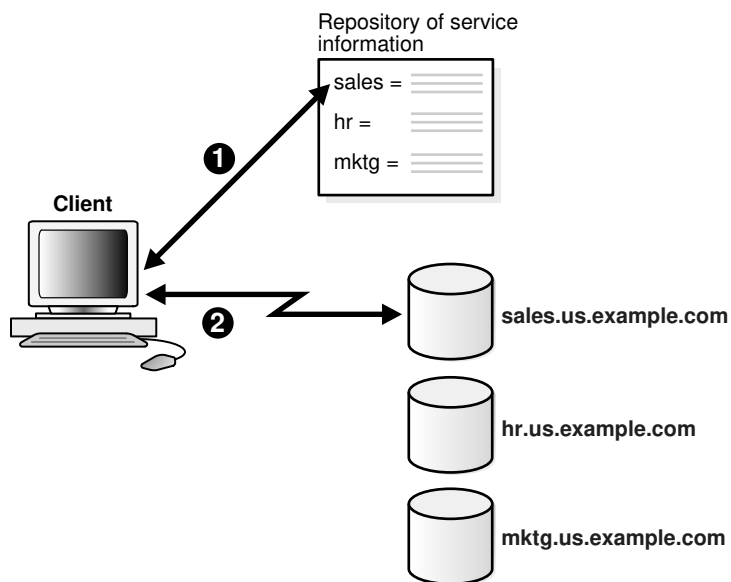

### 1.1.2.2 About Centralized Configuration and Management

To manage large networking environments, administrators have to be able to easily access a centralized repository to specify and modify the network configuration. For this reason, the Oracle Net Services configuration can be stored in a LDAP-compliant directory server.

Support of LDAP-compliant directory servers provides a centralized vehicle for managing and configuring a distributed Oracle network. The directory can act as a central repository for all information about database network components, user and corporate policies, and user authentication and security, thus replacing client-side and server-side localized configuration files.

All computers on the network can refer to the directory for information. [Figure 1-7](#) shows clients, Oracle Database servers, and other servers (such as application web servers) connecting to a centralized directory server.

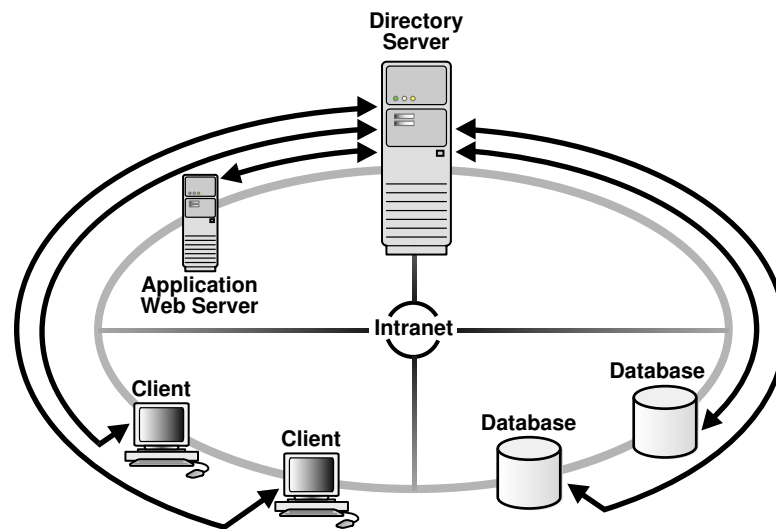
**Figure 1-7 Centralized Storage of Network Configuration with a Directory Server****See Also:**

"[Using a Directory Server for Centralized Management](#)" for an in-depth overview of directory server concepts

### 1.1.2.3 About Quick Installation and Configuration

Networking elements for the Oracle Database server and clients are preconfigured for most environments. The Easy Connect naming method is enabled by default, and does not require a repository. Clients connect using the hostname of the database. As a result, clients and servers are ready to connect out-of-the-box using Easy Connect, giving users the benefits of distributed computing.

### 1.1.3 Understanding Shared Server Architecture

The Oracle Database shared server architecture increases the scalability of applications and the number of clients that can simultaneously be connected to the database. The shared server architecture also enables existing applications to scale up without making any changes to the application itself.

When using a shared server, clients do not communicate directly with a database server process, a database process that handles a client's requests on behalf of a database. Instead, client requests are routed to one or more dispatchers. The dispatchers place the client requests in a common queue. An idle shared server from the shared pool of server processes picks up and processes a request from the queue. This means a small pool of server processes can serve a large number of clients.

The Shared Server Architecture and Dedicated Server Architecture figures show the basic difference between the shared server connection model and the traditional dedicated server connection model. In the shared server model, a dispatcher can



support multiple client connections concurrently. In the dedicated server model, there is one server process for each client. Each time a connection request is received, a server process is started and dedicated to that connection until completed. This causes a processing delay.

**Figure 1-8 Shared Server Architecture**

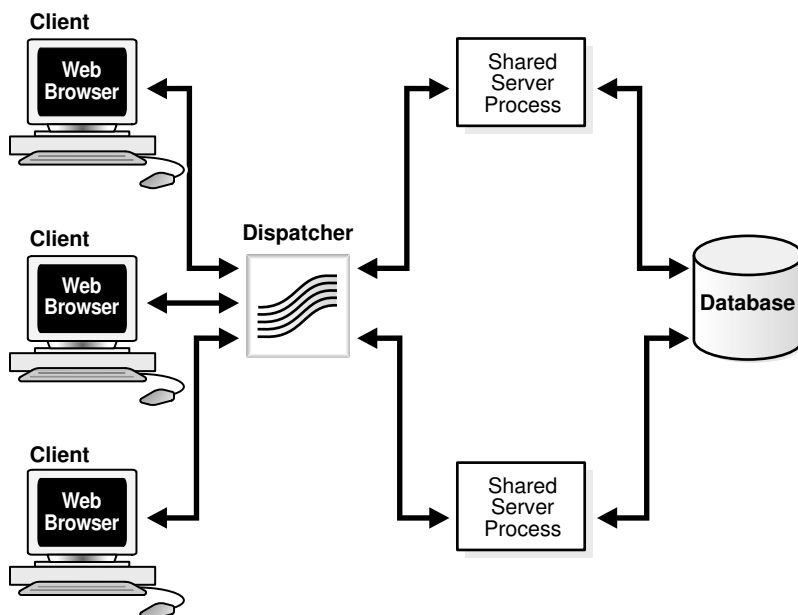

**Figure 1-9 Dedicated Server Architecture**

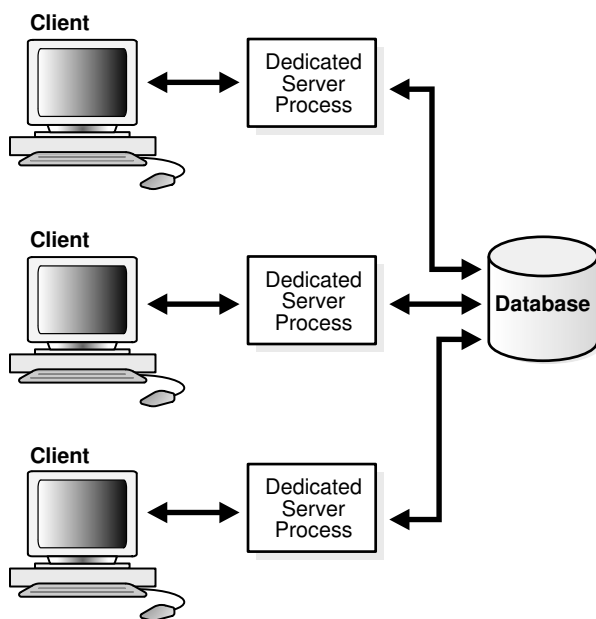

A shared server is ideal for configurations with a large number of connections because it reduces the server memory requirements. A shared server is well suited for both Internet and intranet environments.

Utilization of server resources can be further enhanced with Oracle Connection Manager. Oracle Connection Manager, an Oracle Net Services component, enables multiple client network sessions to be multiplexed, or funneled, through a single network connection to a database.

The session multiplexing feature reduces the demand on resources needed to maintain multiple network sessions between two processes by enabling the server to use fewer network connection endpoints for incoming requests. In this way, the total number of network sessions that a server can handle is increased. One Oracle Connection Manager with multiple gateways enables thousands of concurrent users to connect to a server.

The following figure shows how session multiplexing can be used in a web architecture. When Oracle Connection Manager is run on the same computer as an application web server, the application web server can route multiple client sessions through Oracle Connection Manager to ensure that those sessions have continuous access to an Oracle Database server. This functionality is especially useful for web applications where session availability and response time are major concerns.

**Figure 1-10 Session Multiplexing**

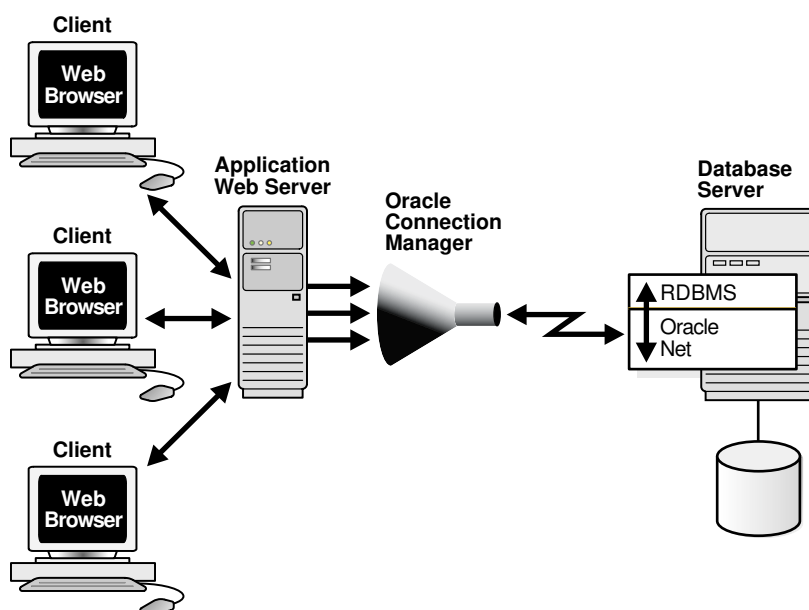

The following are the advantages and disadvantages of session multiplexing. Session multiplexing is recommended for networks where continuous connectivity is required.

#### **Advantages of Session Multiplexing**

- Limits the number of network resources used for each process
- Supports large client populations
- Maximizes the number of client/server sessions over a limited number of process connections
- Optimizes resource utilization
- Enables identification and monitoring of real users

- Enables mid-tier applications to support additional services
- Requires only a single transport for clients with multiple applications
- Requires only a single network connection for database links

#### **Disadvantage of Session Multiplexing**

Clients must connect to Oracle Connection Manager.

## 1.1.4 Understanding Performance

System performance is important to users. Users usually start to notice performance when a system takes longer than one second to respond. Oracle Net configuration can be modified to enhance system performance.

This section discusses performance considerations.

- [Listener Queue Size](#)
- [Session Data Unit Size for Data Transfer Optimization](#)
- [Persistent Buffer Flushing for TCP/IP](#)
- [Sockets Direct Protocol](#)
- [Database Availability](#)

### 1.1.4.1 Listener Queue Size

If you anticipate receiving a large number of connection requests for a listening process (such as a listener or Oracle Connection Manager) over TCP/IP, then Oracle Net enables you to configure the listening queue to be higher than the system default.

### 1.1.4.2 Session Data Unit Size for Data Transfer Optimization

Before sending data across the network, Oracle Net buffers and encapsulates data into the session data unit (SDU). Oracle Net sends the data stored in this buffer when the buffer is full, flushed, or when database server tries to read data. When large amounts of data are being transmitted or when the message size is consistent, adjusting the size of the SDU buffers can improve performance, network utilization, or memory consumption. You can deploy SDU at the client, application web server, and database.

Tuning your application to reduce the number of round trips across the network is the best way to improve your network performance. If this is done, then it is also possible to optimize data transfer by adjusting the size of the SDU.

#### **Considerations for Modifying the Size of the SDU**

Modify the SDU size under the following situations:

- The data coming back from the server is fragmented into separate packets.
- You are on a wide area network (WAN) that has long delays.
- The packet size is consistently the same.
- Large amounts of data are returned.

Do not modify the SDU size under the following situations:

- The application can be tuned to avoid the delays listed in the adjacent column.
- You have a high speed network where the effect of the data transmission is negligible.
- Your requests return small amounts of data from the server.

 **Note:**

Starting with Oracle Database 11g, Oracle Net Services optimizes bulk data transfer for certain components, such as Oracle SecureFiles LOBs and Oracle Data Guard redo transport services. The SDU size limit, as specified in the network parameter files, does not apply to these bulk data transfers. Bulk data transfer optimization does not apply when ASO options are enabled or TLS transport is used.

 **See Also:**

"[Configuring Session Data Unit](#)"

### 1.1.4.3 Persistent Buffer Flushing for TCP/IP

Under certain conditions for some applications using TCP/IP, Oracle Net packets may not get flushed immediately to the network. Most often, this behavior occurs when large amounts of data are streamed. The implementation of TCP/IP itself is the reason for the lack of flushing, causing unacceptable delays. To remedy this problem, specify no delays in the buffer flushing process.

 **See Also:**

*Oracle Database Net Services Reference* for additional information about the TCP.NODELAY parameter

### 1.1.4.4 Sockets Direct Protocol

Oracle Net Services provides support for InfiniBand high-speed networks. InfiniBand is a high-bandwidth I/O architecture designed to increase communication speed between CPUs, server-side devices, and network subsystems. Oracle Net Services provides support for Sockets Direct Protocol (SDP). SDP is an industry-standard wire protocol intended for use between InfiniBand network peers.

SDP reduces the overhead of TCP/IP by eliminating intermediate replication of data and transferring most of the messaging burden away from the CPU and onto the network hardware. The result is a low-latency, increased bandwidth, high-throughput connection that reduces the amount of CPU cycles dedicated to network processing.

The communication between clients, including Oracle WebLogic Server or any other third-party middle-tier client, and Oracle Database 12c can take advantage of high-speed interconnect benefits. Oracle WebLogic Server includes Oracle TCP/IP support as part of its installation.

A driver installed on the Oracle WebLogic Server servers transparently converts TCP/IP support to SDP support. The SDP requests are then sent to an InfiniBand switch that processes and forwards the requests from the Oracle WebLogic Server servers to the database server.



**See Also:**

["Configuring SDP Support for InfiniBand Connections"](#)

### 1.1.4.5 Database Availability

Availability to the database is crucial for any network. You can configure multiple listeners to handle client connection requests for the same database service. This is beneficial in Oracle Real Application Clusters configurations, where each instance has a listener associated with it. Multiple listener configurations enable you to use the following features.

- Connect-time failover enables clients to request a different listener, usually on a different node, if the first listener fails.
- Client load balancing enables clients to randomize requests to the multiple listeners, usually on different nodes. These features can be used together or separately. Together, they ensure access to the database and distribute the load to not overburden a single listener.

### 1.1.5 Understanding Network Security

Data access and the secure transfer of data are important considerations when deploying Oracle Database. Granting and denying access to a database is crucial for a secure network environment. Oracle Net Services enables database access control using firewall access control and valid node registration.

- [Firewall Access Control](#)



**See Also:**

["Managing Oracle Net Listener Security"](#) for information about valid node registration

#### 1.1.5.1 Firewall Access Control

Oracle Connection Manager can be configured to grant or deny client access to a particular database service or a computer. By specifying filtering rules, you can allow or restrict specific client access to a server, based on the following criteria:

- Source host names or IP addresses for clients
- Destination host names or IP addresses for servers
- Destination database service names
- Client use of Oracle Net Services security features

Figure 1-11 shows an Oracle Connection Manager positioned between three clients and an Oracle Database server. Oracle Connection Manager is configured to allow access to the first two clients and to deny access to the third.

**Figure 1-11 Intranet Network Access Control with Oracle Connection Manager**

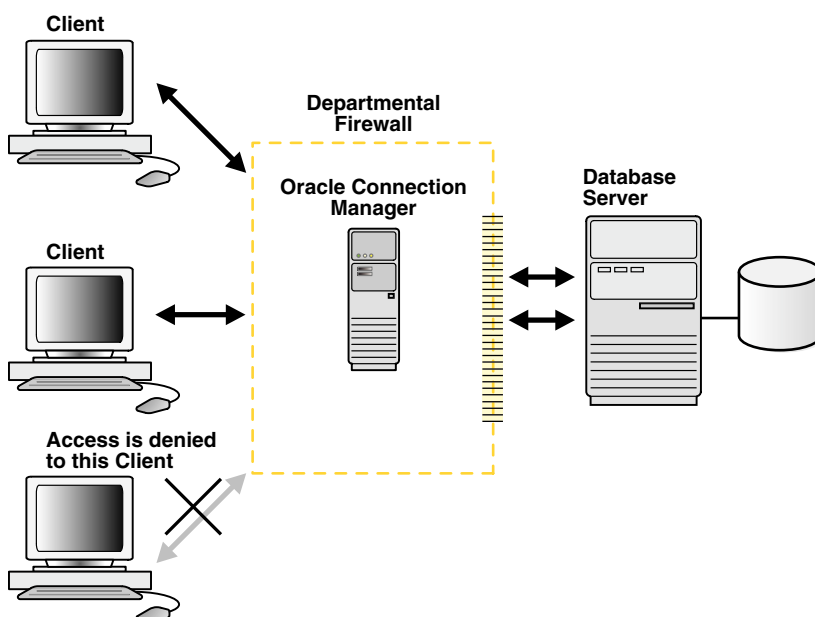

Although Oracle Connection Manager cannot be integrated with third-party firewall products, vendors can package it with their own products in a way that enables this product to serve as an application gateway.

In general, firewalls should be set to receive incoming requests, and allow outbound calls from Oracle Database. By defining filtering rules, you can limit access to the network.

**▲ Caution:**

Incorrectly setting your firewall options can cause security problems. Before changing your firewall settings, discuss the options and your network site policies with your system administrator.

Figure 1-12 shows an application gateway controlling traffic between internal and external networks and providing a single checkpoint for access control and auditing. As a result, unauthorized Internet hosts cannot directly access the database inside a corporation, but authorized users can still use Internet services outside the corporate

network. This capability is critical in Internet environments to restrict remote access to sensitive data.

**Figure 1-12 Internet Network Access Control with an Application Gateway**

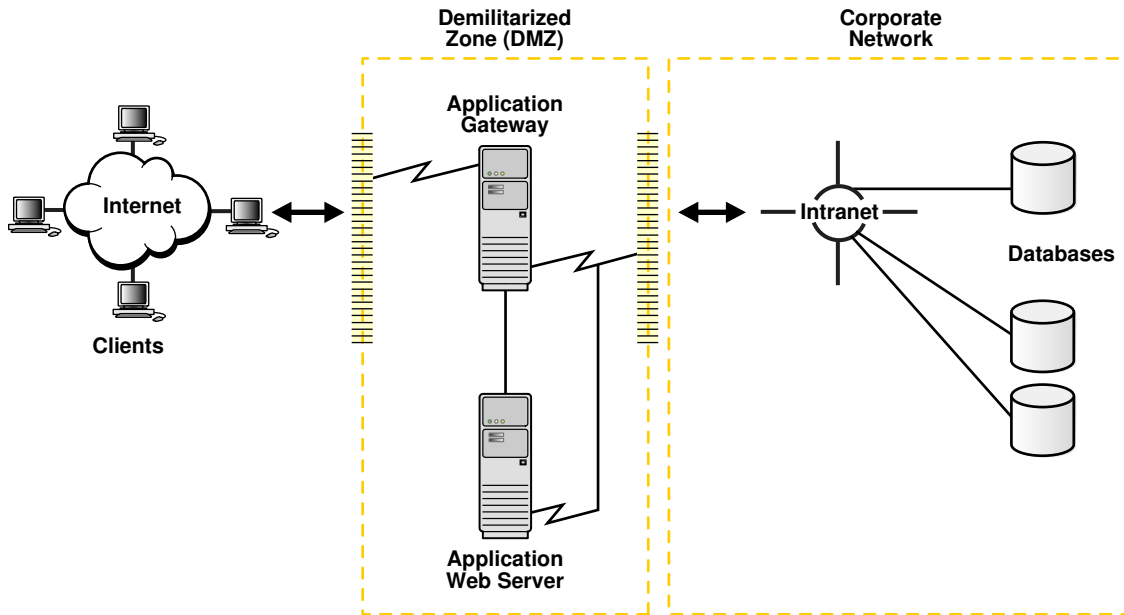

It is important to deploy at least two Oracle Connection Manager firewalls or Oracle Net Firewall proxies in an Internet network environment in the event that one firewall goes down.

## 1.2 Understanding Database Instances

A database has at least one instance. An instance is comprised of a memory area called the System Global Area (SGA) and Oracle background processes. The memory and processes of an instance efficiently manage the associated database's data and serve the database users.

 **Note:**

An instance also manages other services, such as Oracle XML DB.

The following figure shows two database instances, `sales` and `finance`, associated with their respective databases and service names.

Figure 1-13 One Instance for Each Database

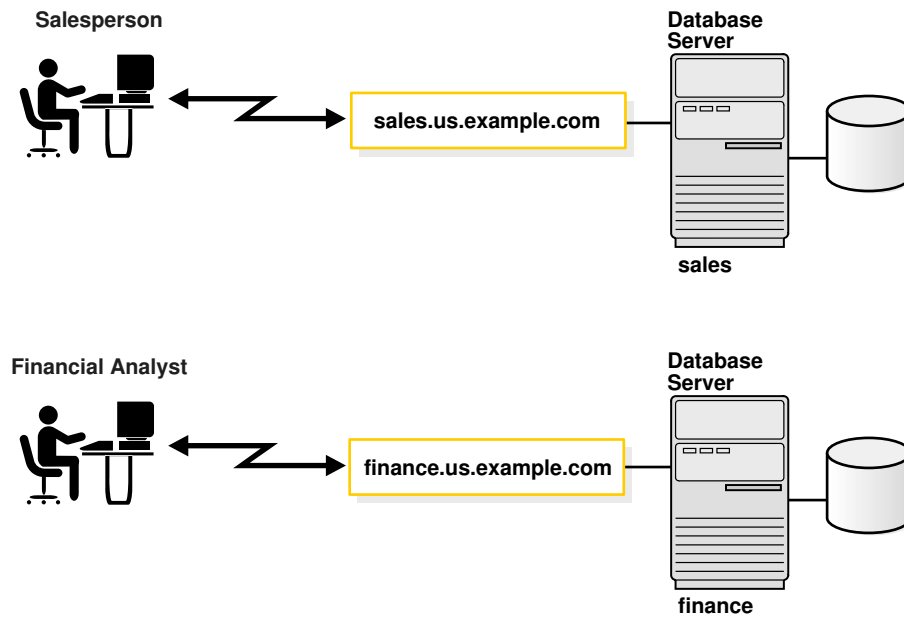

Instances are identified by an instance name, such as `sales` and `finance` in this example. The instance name is specified by the `INSTANCE_NAME` initialization parameter. The instance name defaults to the Oracle system identifier (SID) of the database instance.

Some hardware architectures allow multiple computers to share access to data, software, or peripheral devices. Oracle Real Application Clusters (Oracle RAC) can take advantage of such architecture by running multiple instances on different computers that share a single physical database.

The following figure shows an Oracle RAC configuration. In this example, two instances, `sales1` and `sales2`, are associated with one database service, `sales.us.example.com`.



Figure 1-14 Multiple Instances Associated with an Oracle RAC Database

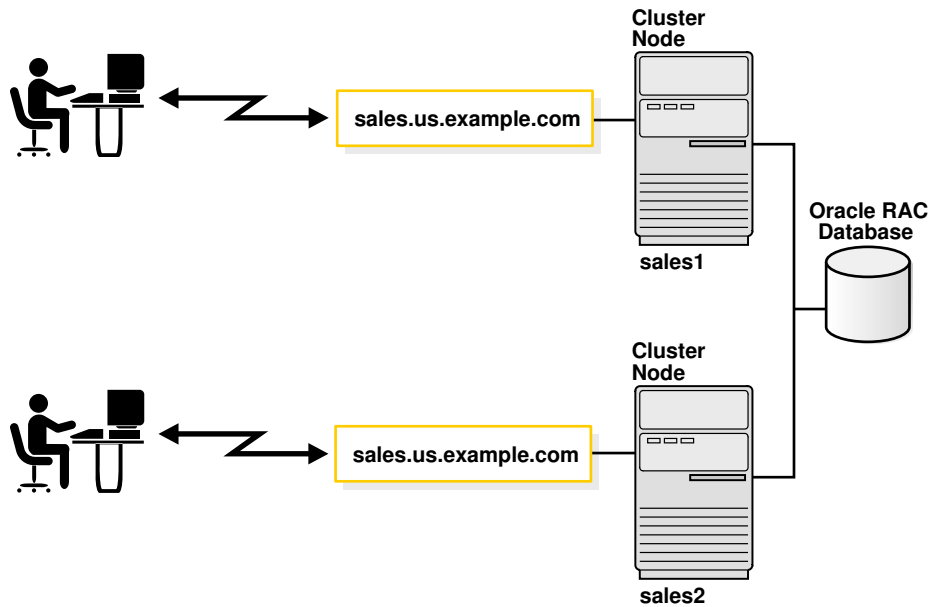

## 1.3 Components of Oracle Net Services

This section describes the connectivity, manageability, scalability, and security features.

- [About Oracle Net](#)
- [About Oracle Net Listener](#)
- [About Oracle Connection Manager](#)
- [About Networking Tools](#)
- [About Oracle Advanced Security](#)

### 1.3.1 About Oracle Net

Oracle Net is a software layer that resides on the client and on the Oracle Database server. It is responsible for establishing and maintaining the connection between the client application and server, as well as exchanging messages between them, using industry-standard protocols. Oracle Net has two software components:

- [Oracle Net Foundation Layer](#)
- [Oracle Protocol Support](#)

#### 1.3.1.1 Oracle Net Foundation Layer

On the client side, applications communicate with Oracle Net foundation layer to establish and maintain connections. The Oracle Net foundation layer uses Oracle protocol support that communicates with an industry-standard network protocol, such as TCP/IP, to communicate with the Oracle Database server.

[Figure 1-15](#) illustrates the communication stack on the client.

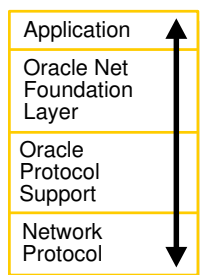
**Figure 1-15 Oracle Net on the Client**

The Oracle Database server side is similar to the client side as illustrated in [Figure 1-16](#). A network protocol sends client request information to an Oracle protocol support layer, which then sends information to the Oracle Net foundation layer. The Oracle Net foundation layer then communicates with the Oracle Database server to process the client request.

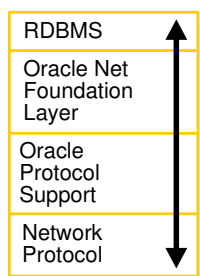
**Figure 1-16 Oracle Net on the Server**

### 1.3.1.2 Oracle Protocol Support

The Oracle Net foundation layer uses Oracle protocol support to communicate with the following industry-standard network protocols:

- TCP/IP (version 4 and version 6)
- TCP/IP with SSL
- Named Pipes
- SDP

Oracle protocol support maps Oracle Net foundation layer functionality to industry-standard protocols used in client/server connections.

**See Also:**

["Understanding Oracle Protocol Support Layer"](#)

## 1.3.2 About Oracle Net Listener

Oracle Database server receives the initial connection through Oracle Net Listener. Oracle Net Listener, referred to in this document as the listener, brokers a client request, handing off the request to the server. The listener is configured with a protocol address, and clients configured with the same protocol address can send connection requests to the listener. When a connection is established, the client and Oracle server communicate directly with one another.

Oracle Net listener supports ACLs (Access Control Lists) for service and this is supported for all IP protocols.

 **See Also:**

DBSFUSER.DBMS\_SFW\_ACL\_ADMIN in *Oracle Database PL/SQL Packages and Types Reference* for more information about listener ACLs

The following figure shows the listener accepting a connection request from a client and forwarding that request to an Oracle server.

**Figure 1-17 Listener in a Connection Request**

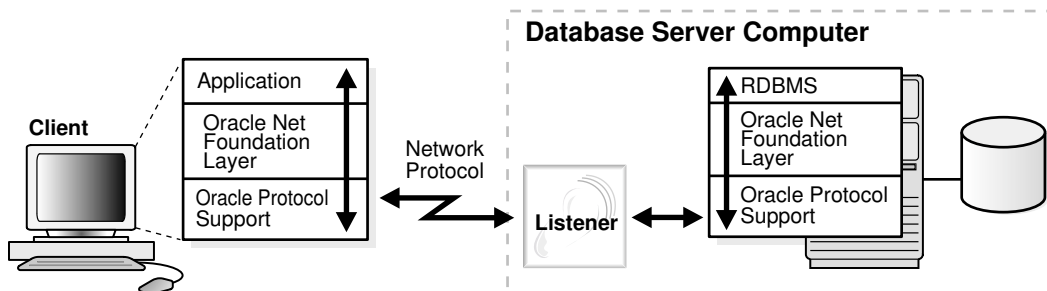

 **See Also:**

[Configuring and Administering Oracle Net Listener](#) for additional information about the listener

## 1.3.3 About Oracle Connection Manager

Oracle Connection Manager is the software component that resides on its own computer, separate from a client or an Oracle Database server. It proxies and screens requests for the database server. In addition, it multiplexes database sessions.

In its session multiplexing role, Oracle Connection Manager funnels multiple sessions through a single transport protocol connection to a particular destination. In this way, Oracle Connection Manager reduces the demand on resources needed to maintain

multiple sessions between two processes by enabling the Oracle Database server to use fewer connection endpoints for incoming requests.

As an access control filter, Oracle Connection Manager controls access to Oracle databases.

 **Note:**

Oracle Connection Manager can act as a Connection Manager in Traffic Director Mode by setting `tdm=yes` in `cman.ora`.

Oracle Connection Manager in Traffic Director mode provides improved high availability (HA) (planned and unplanned), connection multiplexing support, and load balancing. This feature also provides an inband client notification mechanism to deliver planned shutdown for Oracle Connection Manager down and service down events to the OCI client.

 **See Also:**

- ["Understanding Shared Server Architecture"](#)
- ["Firewall Access Control"](#) for a description of filtering

## 1.3.4 About Networking Tools

Oracle Net Services provides user interface tools and command-line utilities to configure, manage, and monitor the network.

- Oracle Net Configuration Assistant is a standalone tool that enables you to configure listeners and naming methods.
- Oracle Enterprise Manager Cloud Control combines configuration functionality across multiple file systems, along with listener administrative control to provide an integrated environment for configuring and managing Oracle Net Services.
- Oracle Net Manager provides configuration functionality for an Oracle home on a local client or server host.
- Command-line control utilities to configure, administer, and monitor network components, including listeners and Oracle Connection Managers.

With Oracle Enterprise Manager Cloud Control or Oracle Net Manager, you can fine-tune the listener and naming method configuration created with Oracle Net Configuration Assistant. In addition, Oracle Enterprise Manager Cloud Control and Oracle Net Manager offer built-in wizards and utilities to test connectivity, migrate data from one naming method to another, and create additional network components.



**See Also:**

[Managing Oracle Net Services](#)

## 1.3.5 About Oracle Advanced Security

Oracle Advanced Security is a separately licensable product that provides Oracle Database Transparent Data Encryption (TDE) and Oracle Data Redaction. TDE encrypts data so that only an authorized recipient can read it. Oracle Data Redaction enables an administrator to redact (mask) column data, using the following types of redaction:

- Full redaction redacts all the contents of the column data. The redacted value returned to the querying user depends on the data type of the column. For example, columns of the NUMBER data type are redacted with a zero (0) and character data types are redacted with a blank space.
- Partial redaction redacts a portion of the column data. For example, masking most of a credit card number with asterisks (\*), except for the last four digits.
- Regular expressions enable using patterns of data to redact. For example, use regular expressions to redact email addresses, which can have varying character lengths. It is designed for use with character data only.
- Random redaction present the redacted data to the querying user as randomly-generated values each time it is displayed.
- No redaction enables an administrator to test the internal operation of the redaction policies, with no effect on the results of queries against tables with policies defined on them.



**See Also:**

*[Oracle Database Advanced Security Guide](#)*

# 2

## Identifying and Accessing the Database

Understand how databases are identified, and how clients access them.

- [Understanding Database Instances](#)
- [Understanding Database Services](#)
- [Connecting to a Database Service](#)
- [Understanding Service Handlers](#)
- [Understanding Naming Methods](#)
- [Enhancing Service Accessibility Using Multiple Listeners](#)

### 2.1 Understanding Database Instances

A database has at least one instance. An instance is comprised of a memory area called the System Global Area (SGA) and Oracle background processes. The memory and processes of an instance efficiently manage the associated database's data and serve the database users.

 **Note:**

An instance also manages other services, such as Oracle XML DB.

The following figure shows two database instances, `sales` and `finance`, associated with their respective databases and service names.

Figure 2-1 One Instance for Each Database

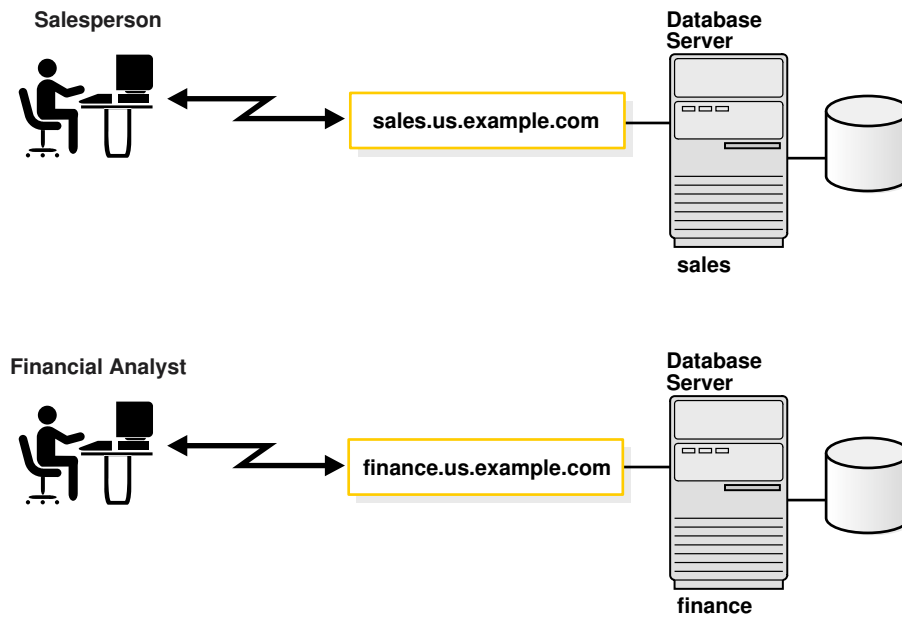

Instances are identified by an instance name, such as `sales` and `finance` in this example. The instance name is specified by the `INSTANCE_NAME` initialization parameter. The instance name defaults to the Oracle system identifier (SID) of the database instance.

Some hardware architectures allow multiple computers to share access to data, software, or peripheral devices. Oracle Real Application Clusters (Oracle RAC) can take advantage of such architecture by running multiple instances on different computers that share a single physical database.

The following figure shows an Oracle RAC configuration. In this example, two instances, `sales1` and `sales2`, are associated with one database service, `sales.us.example.com`.

Figure 2-2 Multiple Instances Associated with an Oracle RAC Database

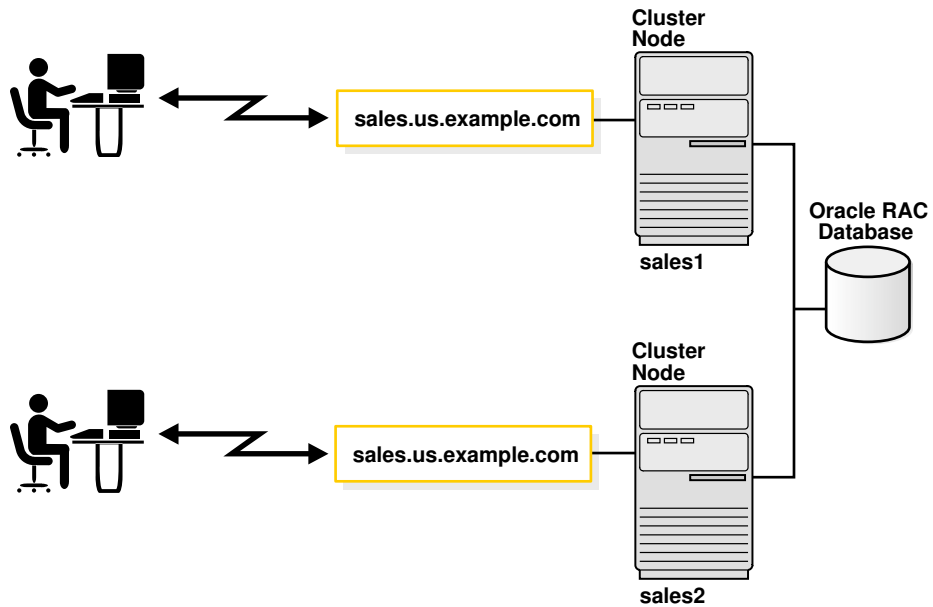

## 2.2 Understanding Database Services

An Oracle database is represented to clients as a service. A database can have one or more services associated with it.

The following figure shows two databases, each with its own database service for clients. One service, `sales.us.example.com`, enables salespersons to access the sales database. Another service, `finance.us.example.com`, enables financial analysts to access the finance database.

Figure 2-3 One Service for Each Database

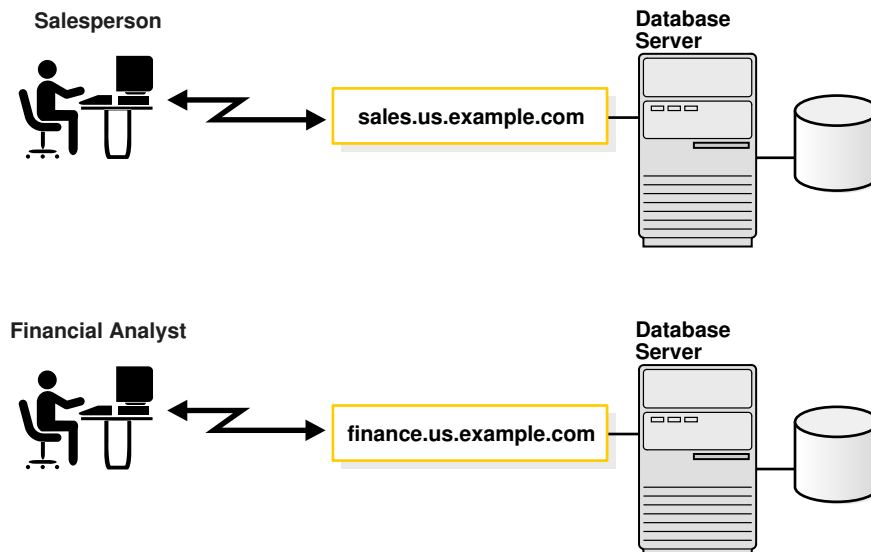



The sales and finance databases are each identified by a service name, `sales.us.example.com` and `finance.us.example.com`, respectively. A service name is a logical representation of a database. When an instance starts, it registers itself with a listener using one or more service names. When a client program or database connects to a listener, it requests a connection to a service.

A service name can identify multiple database instances, and an instance can belong to multiple services. For this reason, the listener acts as a mediator between the client and instances and routes the connection request to the appropriate instance. Clients connecting to a service need not specify which instance they require.

The service name is specified by the `SERVICE_NAMES` initialization parameter in the server parameter file. The server parameter file enables you to change initialization parameters with `ALTER SYSTEM` commands, and to carry the changes across a shutdown and startup. The `DBMS_SERVICE` package can also be used to create services. The service name defaults to the global database name, a name comprising the database name (`DB_NAME` initialization parameter) and domain name (`DB_DOMAIN` initialization parameter). In the case of `sales.us.example.com`, the database name is `sales` and the domain name is `us.example.com`.

 **Note:**

Starting with Oracle Database 19c, customer use of the `SERVICE_NAMES` parameter is deprecated. To manage your services, Oracle recommends that you use the `SRVCTL` or `GDSCTL` command line utilities, or the `DBMS_SERVICE` package.

The following figure shows clients connecting to multiple services associated with one database.

**Figure 2-4 Multiple Services Associated with One Database**

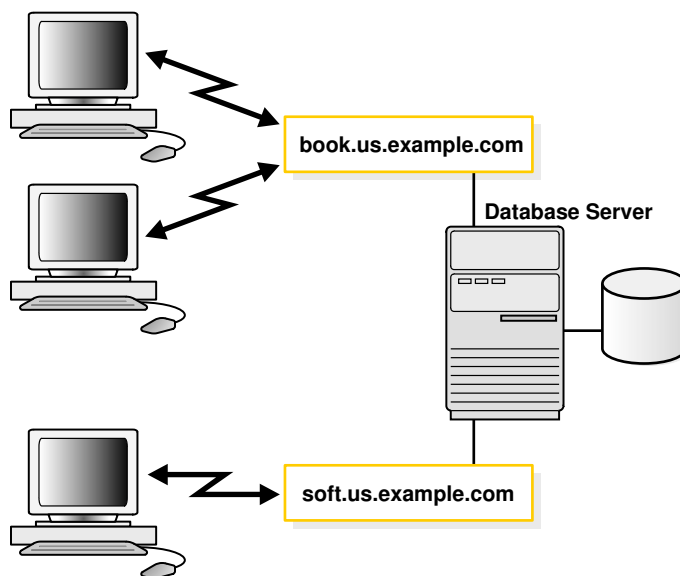

Associating multiple services with one database enables the following functionality:

- A single database can be identified different ways by different clients.
- A database administrator can limit or reserve system resources. This level of control enables better allocation of resources to clients requesting one of the services.

 **See Also:**

- *Oracle Database Administrator's Guide* for additional information about initialization parameters
- *Oracle Database SQL Reference* for additional information about the `ALTER SYSTEM` statement
- *Oracle Database Reference* for additional information about the `SERVICE_NAMES` parameter
- *Oracle Database PL/SQL Packages and Types Reference* for additional information about the `DBMS_SERVICE` package.

## 2.3 Connecting to a Database Service

To connect to a database service, clients use a connect descriptor that provides the location of the database and the name of the database service. The following example is an Easy Connect descriptor that connects to a database service named `sales.us.example.com`, and the host `sales-server` (the port is 1521 by default):

```
sales-server/sales.us.example.com
```

The following example shows the entry in the `tnsnames.ora` file for the preceding Easy Connect connect descriptor and database service:

```
(DESCRIPTION=
  (ADDRESS=(PROTOCOL=tcp)(HOST=sales-server)(PORT=1521))
  (CONNECT_DATA=
    (SERVICE_NAME=sales.us.example.com)))
```

- [About Connect Descriptors](#)
- [About the Protocol Address](#)
- [About Service Registration](#)

 **See Also:**

["Understanding Naming Methods"](#)

## 2.3.1 About Connect Descriptors

A connect descriptor is comprised of one or more protocol addresses of the listener and the connect information for the destination service in the `tnsnames.ora` file.

[Example 2-1](#) shows a connect descriptor mapped to the `sales` database.

### Example 2-1 Connect Descriptor

```
sales=
(DESCRIPTION=
 (ADDRESS=(PROTOCOL=tcp)(HOST=sales-server)(PORT=1521))
 (CONNECT_DATA=
  (SID=sales)
  (SERVICE_NAME=sales.us.example.com)
  (INSTANCE_NAME=sales)))
```

As shown in [Example 2-1](#), the connect descriptor contains the following parameters:

- The ADDRESS section contains the following:
  - PROTOCOL parameter, which identifies the listener protocol address. The protocol is `tcp` for TCP/IP.
  - HOST parameter, which identifies the host name. The host is `sales-server`.
  - PORT parameter, which identifies the port. The port is `1521`, the default port number.
  - Optional `HTTPS_PROXY` and `HTTPS_PROXY_PORT` parameters, that allow the database client connection to traverse through the organization's forward web proxy. These parameters are applicable only to the connect descriptors where `PROTOCOL=TCPS`.
- The CONNECT\_DATA section contains the following:
  - SID parameter, which identifies the system identifier (SID) of the Oracle database. The SID is `sales`.
  - SERVICE\_NAME parameter, which identifies the service. The destination service name is a database service named `sales.us.example.com`.

The value for this connect descriptor parameter comes from the `SERVICE_NAMES` initialization parameter (`SERVICE_NAMES` uses a final S) in the initialization parameter file. The `SERVICE_NAMES` initialization parameter is typically the global database name, which includes the database name and domain name. In the example, `sales.us.example.com` has a database name of `sales` and a domain of `us.example.com`.

#### Note:

Starting with Oracle Database 19c, customer use of the `SERVICE_NAMES` parameter is deprecated. To manage your services, Oracle recommends that you use the `SRVCTL` or `GDSCTL` command line utilities, or the `DBMS_SERVICE` package.

- INSTANCE\_NAME parameter, which identifies the database instance. The instance name is optional.

The `INSTANCE_NAME` parameter in the initialization parameter file defaults to the SID entered during installation or database creation.

- [About IPv6 Addresses in Connect Descriptors](#)

 **See Also:**

"[Understanding Database Instances](#)", and "[Understanding Database Services](#)"

### 2.3.1.1 About IPv6 Addresses in Connect Descriptors

A host can use IP version 4 (IPv4) and IP version 6 (IPv6) interfaces. IPv6 addresses and host names that resolve to IPv6 addresses are usable in the `HOST` parameter of a TNS connect address, which can be obtained through any of the supported net naming methods listed in [Table 2-1](#).

End-to-end connectivity using IPv6 in Oracle Database 12c requires the following configuration:

- The client TNS connect address must connect to the Oracle Net Listener on the IPv6 endpoint.
- The database instance configured for Oracle Net Listener must listen for connection requests on IPv6 endpoints.

For a given host name, Oracle Net attempts to connect to all IP addresses returned by Domain Name System (DNS) name resolution until a successful connection is established or all addresses have been attempted. Suppose that in [Example 2-1](#) the `sales-server` host is an IPv4-only host that is accepting client connections. DNS maps `sales-server` to the following IP addresses:

1. IPv6 address `2001:0db8:0:0::200C:417A`
2. IPv4 address `192.0.2.213`

In this case, Oracle Net first tries to connect on the IPv6 address because it is first in the DNS list. In this example, `sales-server` does not support IPv6 connectivity, so this attempt fails. Oracle Net proceeds to connect to the IPv4 address, which succeeds.

 **See Also:**

- "[About TCP/IP Protocol](#)"
- "[Configuring Listening Protocol Addresses](#)"
- "[Using Oracle Connection Manager as a Bridge for IPv4 and IPv6](#)"
- "[IPv6 Network Connectivity](#)"

## 2.3.2 About the Protocol Address

The address portion of the connect descriptor is the protocol address of the listener. To connect to a database service, clients first contact a listener process that typically resides on the database server. The listener receives incoming client connection requests and sends these requests to the database server. After the connection is established, the client and database server communicate directly.

The listener is configured to accept requests from clients at a protocol address. This address defines the protocol the listener is listening on and any other protocol-specific information. For example, the listener could be configured to listen at the following protocol address:

```
(DESCRIPTION=
  (ADDRESS=(PROTOCOL=tcp)(HOST=sales-server)(PORT=1521)))
```

The preceding example shows a TCP/IP protocol address that specifies the host of the listener and a port number. Client connect descriptors configured with this same protocol address can send connection requests to this listener.

## 2.3.3 About Service Registration

The connect descriptor specifies the database service name with which clients seek to establish a connection. The listener knows which services can handle connection requests because Oracle Database dynamically registers this information with the listener. This process of registration is called service registration. Registration also provides the listener with information about the database instances and the service handlers available for each instance. A service handler can be a dispatcher or dedicated server.

- [Specifying an Instance Name](#)
- [Specifying a Service Handler](#)

### 2.3.3.1 Specifying an Instance Name

If connecting to a specific instance of the database is required, then clients can specify the `INSTANCE_NAME` of a particular instance in the connect descriptor. This feature can be useful for an Oracle RAC configuration. For example, the following connect descriptor specifies the instance name `sales1` that is associated with `sales.us.example.com`.

```
(DESCRIPTION=
  (ADDRESS=(PROTOCOL=tcp)(HOST=sales-server)(PORT=1521))
  (CONNECT_DATA=
    (SERVICE_NAME=sales.us.example.com)
    (INSTANCE_NAME=sales1)))
```

### 2.3.3.2 Specifying a Service Handler

Clients that always want to use a particular service handler type can use a connect descriptor to specify the service handler type. In the following example, the connect descriptor uses `(SERVER=shared)` to request a dispatcher when connecting to a database. The database may be configured to use dedicated servers by default.

```
(DESCRIPTION=
  (ADDRESS=(PROTOCOL=tcp)(HOST=sales-server)(PORT=1521))
  (CONNECT_DATA=
    (SERVICE_NAME=sales.us.example.com)
    (SERVER=shared)))
```

When the listener receives the client request, it selects one of the registered service handlers. Depending on the type of handler selected, the communication protocol used, and the operating system of the database server, the listener performs one of the following actions:

- Hands the connect request directly off to a dispatcher.
- Sends a redirect message back to the client with the location of the dispatcher or dedicated server process. The client then connects directly to the dispatcher or dedicated server process.
- Spawns a dedicated server process and passes the client connection to the dedicated server process.

After the listener has completed the connection operation for the client, the client communicates directly with the Oracle database without the listener's involvement. The listener resumes listening for incoming network sessions.

The following should be considered when specifying service handlers:

- If you want the client to use a dedicated server, then specify `(SERVER=dedicated)`. If the `SERVER` parameter is not set, then a shared server configuration is assumed. However, the client will use a dedicated server if no dispatchers are available.
- If database resident connection pooling is enabled on the server, then specify `(SERVER=pooled)` to get a connection from the pool. If database resident connection pooling is not enabled on the server, then the client request is rejected, and the user receives an error message.

#### See Also:

- ["About the Listener and Connection Requests"](#) for a discussion about how the listener works with service handlers
- *Oracle Call Interface Programmer's Guide* and *Oracle Database Administrator's Guide*
- *Oracle Database Global Data Services Concepts and Administration Guide* for additional information about management of global services

## 2.4 Understanding Service Handlers

Service handlers act as connection points to an Oracle database. A service handler can be a dispatcher or a dedicated server process, or pooled.

- [About Dispatchers](#)
- [About Dedicated Server Processes](#)

- [About Database Resident Connection Pooling](#)

## 2.4.1 About Dispatchers

The shared server architecture uses a dispatcher process to direct client connections to a common request queue. An idle shared server process from a shared pool of server processes picks up a request from the common queue. This approach enables a small pool of server processes to serve a large number of clients. A significant advantage of the shared server model over the dedicated server model is reduced system resources, enabling support of an increased number of users.

The listener uses the dispatcher as a type of service handler to which it can direct client requests. When a client request arrives, the listener performs one of the following actions:

- Hands the connection request directly to a dispatcher.
- Issues a redirect message to the client, containing the protocol address of a dispatcher. The client then terminates the network session to the listener and establishes a network session to the dispatcher, using the network address provided in the redirect message.

The listener uses direct hand off whenever possible. Redirect messages are used, for example, when dispatchers are remote to the listener.

The following figure shows the listener handing a connection request directly to a dispatcher.

1. The listener receives a client connection request.
2. The listener hands the connect request directly to the dispatcher.
3. The client is now connected to the dispatcher.

**Figure 2-5 Direct Hand Off to a Dispatcher**

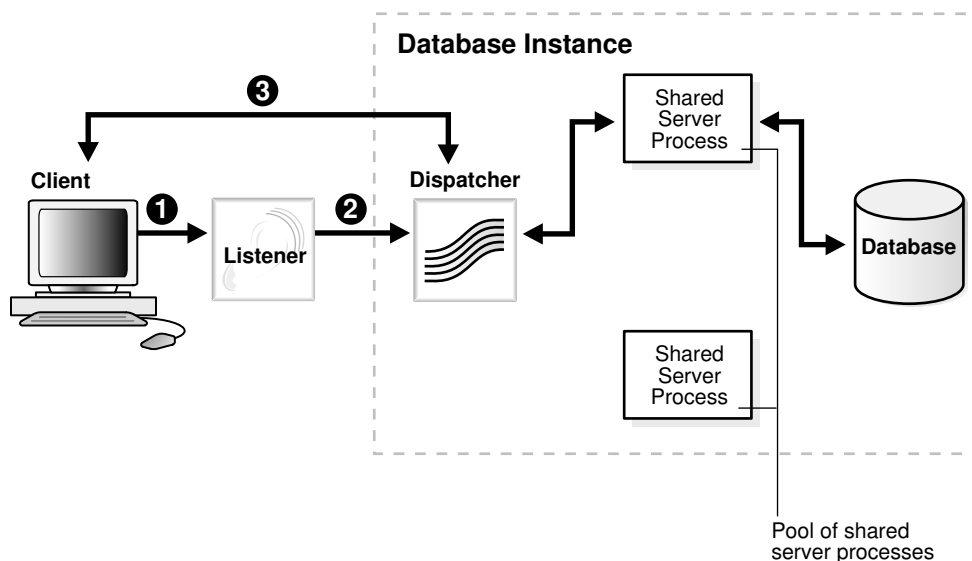

The following figure shows the role of a dispatcher in a redirected connection.

1. The listener receives a client connection request.
2. The listener provides the location of the dispatcher to the client in a redirect message.
3. The client connects directly to the dispatcher.

**Figure 2-6 Redirected Connection to a Dispatcher**

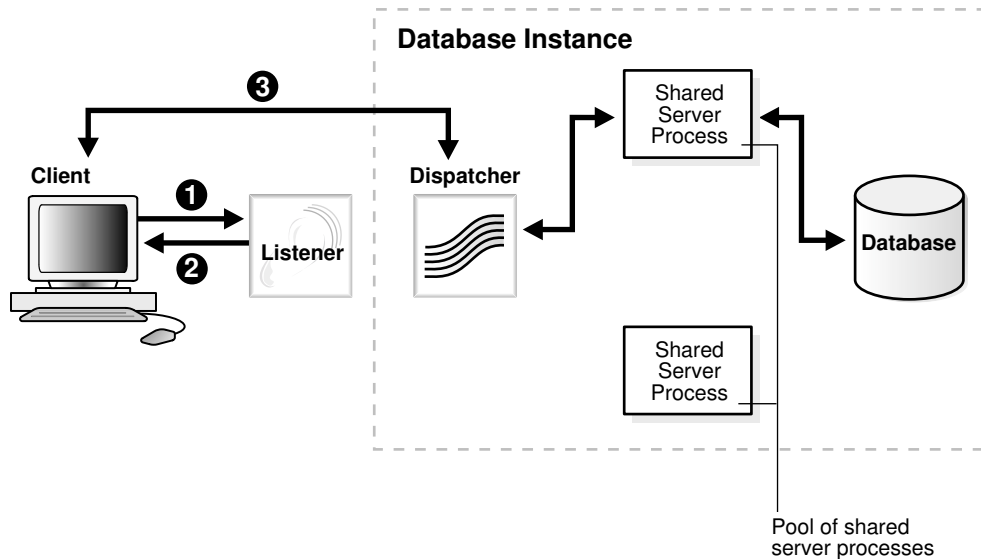

## 2.4.2 About Dedicated Server Processes

In a dedicated server configuration, the listener starts a separate dedicated server process for each incoming client connection request dedicated to servicing the client. After the session is complete, the dedicated server process terminates. Because a dedicated server process has to be started for each connection, this configuration may require more system resources than shared server configurations.

A dedicated server process is a type of service handler that the listener starts when it receives a client request. To complete a client/server connection, one of the following actions occurs:

- The dedicated server inherits the connection request from the listener.
- The dedicated server informs the listener of its listening protocol address. The listener passes the protocol address to the client in a redirect message and terminates the connection. The client connects to the dedicated server directly using the protocol address.

One of the preceding actions is selected based on the operating system and the transport protocol.

If the client and database exist on the same computer, then a client connection can be passed directly to a dedicated server process without going through the listener. This is known as a bequeath protocol. The application initiating the session spawns a dedicated server process for the connection request. This happens automatically if the application used to start the database is on the same computer as the database.



 **Note:**

In order for remote clients to connect to dedicated servers, the listener and the database instance must be running on the same computer.

Figure 2-7 shows the listener passing a client connection request to a dedicated server process.

1. The listener receives a client connection request.
2. The listener starts a dedicated server process, and the dedicated server inherits the connection request from the listener.
3. The client is now connected directly to the dedicated server.

**Figure 2-7 Connection to a Dedicated Server Process**

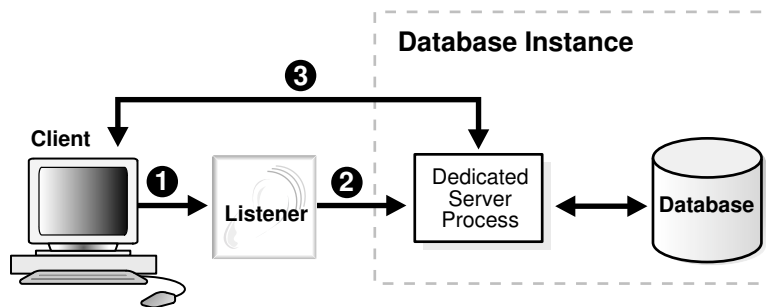
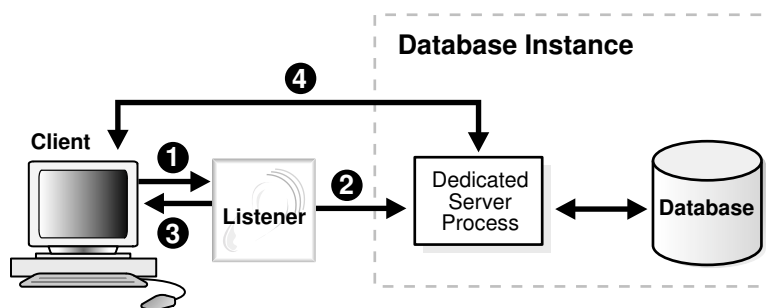

Figure 2-8 shows the role of a dedicated server in a redirected connection.

1. The listener receives a client connection request.
2. The listener starts a dedicated server process.
3. The listener provides the location of the dedicated server process to the client in a redirect message.
4. The client connects directly to the dedicated server.

**Figure 2-8 Redirected Connection to a Dedicated Server Process**



## 2.4.3 About Database Resident Connection Pooling

Database resident connection pooling provides a connection pool in the database server for typical web application usage scenarios in which an application acquires a database connection, works on it for a relatively short duration, and then releases it. Database resident connection pooling pools "dedicated" servers. A pooled server is the equivalent of a server foreground process and a database session combined. Database resident connection pooling uses dynamic registration between the server and the listener. It cannot use static registration.

Database resident connection pooling complements middle-tier connection pools that share connections between threads in a middle-tier process. In addition, it enables sharing of database connections across middle-tier processes on the same middle-tier host and even across middle-tier hosts. This results in significant reduction in key database resources needed to support a large number of client connections, thereby reducing the database tier memory footprint and boosting the scalability of both middle-tier and database tiers. Having a pool of readily available servers has the additional benefit of reducing the cost of creating and closing client connections.

Database resident connection pooling provides pooling for dedicated connections across client applications and processes. This feature is useful for applications that must maintain persistent connections to the database and optimize server resources, such as memory.

Clients obtaining connections out of the database resident connection pool are persistently connected to a background process, the connection broker, instead of the dedicated servers. The connection broker implements the pool functionality and performs the multiplexing of inbound connections from the clients to a pool of dedicated servers with sessions.

When a client must perform database work, the connection broker picks up a dedicated server from the pool and assigns it to the client. Subsequently, the client is directly connected to the dedicated server until the request is served. After the server finishes processing the client request, the server goes back into the pool and the connection from the client is restored to the connection broker.

The following figure shows the process.

**Figure 2-9 Dedicated Server Processes Handling Connections Through the Connection Broker Process**

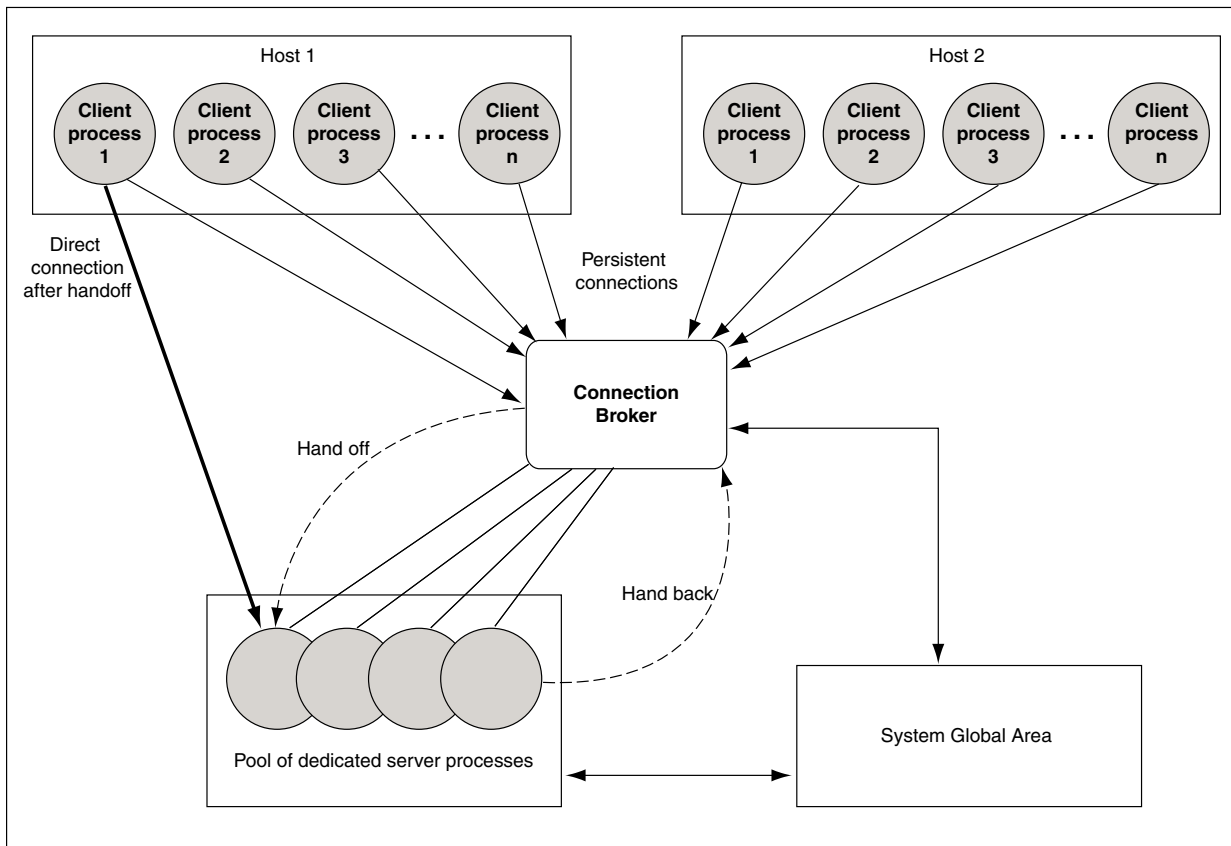

## 2.5 Understanding Naming Methods

A naming method is a resolution method used by a client application to resolve a connect identifier to a connect descriptor when attempting to connect to a database service. Users initiate a connection request by providing a connect string. A connect string includes a user name and password, along with a connect identifier. A connect identifier can be the connect descriptor or a name that resolves to a connect descriptor. The connect descriptor contains:

- Network route to the service, including the location of the listener through a protocol address
- A database service name or Oracle system identifier (SID)

The following `CONNECT` command uses a connect string that has a complete connect descriptor as the connect identifier instead of a network service name. The string should be entered on a single line. It is shown on two lines because of page width.

```
SQL> CONNECT hr@(DESCRIPTION=(ADDRESS=(PROTOCOL=tcp)(HOST=sales-server1)
(PORT=1521)))(CONNECT_DATA=(SERVICE_NAME=sales.us.example.com))
```

One of the most common connect identifiers is a network service name, a simple name for a service. The following `CONNECT` command uses a connect string that uses network service name `sales` as the connect identifier:

```
SQL> CONNECT hr@sales
```

When network service name `sales` is used, connection processing takes place by first mapping `sales` to the connect descriptor. This mapped information is accessed by naming methods. The following naming methods are available:

- Local naming
- Directory naming
- Easy Connect naming
- External naming
- [Choosing a Naming Method](#)
- [Establishing a Client Session Using a Naming Method](#)
- [Entering a Connect String](#)

## 2.5.1 Choosing a Naming Method

Selecting the appropriate naming method for mapping names to connect descriptors depends upon the size of the organization.

- For a small organization with only a few databases, use Easy Connect naming to make TCP/IP connections with the host name of the database server or local naming to store names in `tnsnames.ora` file on the clients.
- For large organizations with several databases, use directory naming to store names in a centralized directory server.
- For an Internet network, configure the application web servers needed to connect to the databases with the local naming method.

[Table 2-1](#) summarizes the relative advantages and disadvantages of each naming method and provides recommendations for using them in the network.

**Table 2-1 Naming Methods: Advantages and Disadvantages**

Naming Method	Description	Advantages/Disadvantages	Recommended for:
Local Naming	Stores network service names and their connect descriptors in a localized configuration file named <code>tnsnames.ora</code> , which by default is located in the <code>ORACLE_BASE_HOME/network/admin</code> directory.	<p><b>Advantages:</b></p> <ul style="list-style-type: none"> <li>• Provides a straightforward method for resolving network service name addresses.</li> <li>• Resolves network service names across networks running different protocols.</li> </ul> <p><b>Disadvantage:</b> Requires local configuration of all network service name and address changes.</p>	Simple distributed networks with a small number of services that change infrequently.

**Table 2-1 (Cont.) Naming Methods: Advantages and Disadvantages**

Naming Method	Description	Advantages/Disadvantages	Recommended for:
Directory Naming	Stores connect identifiers in a centralized LDAP-compliant directory server to access a database service.	<p><b>Advantages:</b></p> <ul style="list-style-type: none"> <li>Centralizes network names and addresses in a single place, facilitating administration of name changes and updates. This eliminates the need for an administrator to make changes to what potentially could be hundreds or even thousands of clients.</li> <li>Directory stores names for other services.</li> <li>Tools provide simple configuration.</li> </ul> <p><b>Disadvantage:</b> Requires access to a directory server.</p>	Large, complex networks (over 20 databases) that change on a frequent basis.
Easy Connect Naming	Enables clients to connect to an Oracle database server by using a TCP/IP connect string consisting of a host name and optional port and service name.	<p><b>Advantages:</b></p> <ul style="list-style-type: none"> <li>Requires minimal user configuration. The user can provide only the name of the database host to establish a connection.</li> <li>The easy naming method requires no client-side configuration.</li> <li>Eliminates the need to create and maintain a local names configuration file (<code>tnsnames.ora</code>).</li> </ul> <p><b>Disadvantage:</b> Available only in a limited environment, as indicated in the <b>Recommended for</b> column.</p>	<p>Simple TCP/IP networks that meet the following criteria:</p> <ul style="list-style-type: none"> <li>The client and server are connecting using TCP/IP.</li> <li>No features requiring a more advanced connect descriptor are required.</li> </ul>
External Naming	Stores network service names in a supported third-party naming service, such as Network Information Service (NIS) External Naming.	<p><b>Advantage:</b> Enables administrators to load Oracle network service name into their native name service using tools and utilities with which they are already familiar.</p> <p><b>Disadvantage:</b> Requires third-party naming services that cannot be administered using Oracle Net products.</p>	Networks with existing name services.

A naming method configuration consists of the following steps:

1. Select a naming method.
2. Map connect descriptors to the names.
3. Configure clients to use the naming method.

## 2.5.2 Establishing a Client Session Using a Naming Method

A typical process for establishing a client session using a naming method is as follows:

1. The client initiates a connect request by providing a connect identifier.
2. The connect identifier is resolved to a connect descriptor by a naming method.

3. The client makes the connection request to the address provided in the connect descriptor.
4. A listener receives the request and directs it to the appropriate database server.
5. The connection is accepted by the database server.

 **Note:**

Besides connect descriptors, you can use naming methods to map a connect name to a protocol address or protocol address list.

## 2.5.3 Entering a Connect String

After the network components are started you should be able to make a connection across the network. How you make a connection depends upon the naming method, and the tool used for the connection.

The connect string takes the following format:

```
CONNECT username@connect_identifier
```

On most operating systems, you can define a default connect identifier. When using the default, a connect identifier does not need to be specified in the connect string. To define a default connect identifier, use the `TWO_TASK` environment variable on Linux and UNIX platforms or the `LOCAL` environment variable or registry entry on Microsoft Windows.

For example, if the `TWO_TASK` environment variable is set to `sales`, then you can connect to a database from SQL\*Plus with `CONNECT username` rather than `CONNECT username@sales`. Oracle Net checks the `TWO_TASK` variable, and uses the value `sales` as the connect identifier.

- [Connect Identifier and Connect Descriptor Syntax Characteristics](#)

 **See Also:**

Oracle operating system-specific documentation for instructions on setting the `TWO_TASK` and `LOCAL` environment variables

### 2.5.3.1 Connect Identifier and Connect Descriptor Syntax Characteristics

Connect identifiers used in a connect string cannot contain spaces, unless enclosed within single quotation marks (') or double quotation marks ("). In the following examples, a connect identifier and a connect descriptor that contain spaces are enclosed within single quotation marks:

```
CONNECT scott@(DESCRIPTION=(ADDRESS=(PROTOCOL=tcp)(HOST=sales-server)
(PORT=1521))(CONNECT_DATA=(SERVICE_NAME=sales.us.example.com)))'
Enter password: password
```

```
CONNECT scott@'cn=sales, cn=OracleContext, dc=us, dc=example, dc=com'  
Enter password: password
```

Single quotation marks are required if double quotation marks are used in a connect identifier. For example:

```
CONNECT scott@'sales@"good"example.com'  
Enter password: password
```

Similarly, double quotation marks are required if a single quotation marks are used in a connect identifier. For example:

```
CONNECT scott@"cn=sales, cn=OracleContext, ou=Mary's Dept, o=example"  
Enter password: password
```

## 2.6 Enhancing Service Accessibility Using Multiple Listeners

For some configurations, such as Oracle RAC, multiple listeners on multiple nodes can be configured to handle client connection requests for the same database service. In the following example, `sales.us.example.com` can connect using listeners on either `sales1-server` or `sales2-server`.

```
(DESCRIPTION=  
  (ADDRESS_LIST=  
    (ADDRESS=(PROTOCOL=tcp)(HOST=sales1-server)(PORT=1521))  
    (ADDRESS=(PROTOCOL=tcp)(HOST=sales2-server)(PORT=1521)))  
  (CONNECT_DATA=  
    (SERVICE_NAME=sales.us.example.com)))
```

A multiple-listener configuration also enables you to leverage the failover and load balancing features, either individually or in combination with each other.

- [About Connect-Time Failover](#)
- [About Transparent Application Failover](#)
- [About Client Load Balancing](#)
- [About Connection Load Balancing](#)

### 2.6.1 About Connect-Time Failover

The connect-time failover feature enables clients to connect to another listener if the initial connection to the first listener fails. The number of listener protocol addresses determines how many listeners are tried. Without connect-time failover, Oracle Net attempts a connection with only one listener.

### 2.6.2 About Transparent Application Failover

The Transparent Application Failover (TAF) feature is a runtime failover for high availability environments, such as Oracle Real Application Clusters. TAF fails over and reestablishes application-to-service connections. It enables client applications to automatically reconnect to the database if the connection fails and, optionally, resume a `SELECT` statement that was in progress. The reconnection happens automatically from within the Oracle Call Interface (OCI) library.

## 2.6.3 About Client Load Balancing

The client load balancing feature enables clients to randomize connection requests among the listeners. Oracle Net progresses through the list of protocol addresses in a random sequence, balancing the load on the various listeners. Without client load balancing, Oracle Net progresses through the list of protocol addresses sequentially until one succeeds.

## 2.6.4 About Connection Load Balancing

The connection load balancing feature improves connection performance by balancing the number of active connections among multiple dispatchers. In a single-instance environment, the listener selects the least-loaded dispatcher to handle the incoming client requests. In an Oracle Real Application Clusters environment, connection load balancing can balance the number of active connections among multiple instances.

Due to dynamic service registration, a listener is always aware of all instances and dispatchers regardless of their location. Depending on the load information, a listener decides which instance and, if shared server is configured, to which dispatcher to send the incoming client request.

In a shared server configuration, a listener selects a dispatcher in the following order:

1. Least-loaded node
2. Least-loaded instance
3. Least-loaded dispatcher for that instance

In a dedicated server configuration, a listener selects an instance in the following order:

1. Least-loaded node
2. Least-loaded instance

If a database service has multiple instances on multiple nodes, then the listener chooses the least-loaded instance on the least-loaded node.



# 3

## Managing Network Address Information

Identify how the network address information for Oracle Net Services can be stored in local files or in a centralized directory server. Using localized management, network address information is stored in `tnsnames.ora` files on each computer in the network. Using centralized management, network address information is stored in centralized directory server.

- [Using Localized Management](#)
- [Using a Directory Server for Centralized Management](#)

### 3.1 Using Localized Management

When localized management is used, network computers are configured with the files described in [Table 3-1](#). The files are stored locally on the computers.

**Table 3-1 Oracle Net Configuration Files Used with Localized Management**

Configuration File	Description
<code>tnsnames.ora</code>	Located primarily on the clients, this file contains network service names mapped to connect descriptors. This file is used for the local naming method.
<code>sqlnet.ora</code>	Located on client and database server computers, this file may include the following: <ul style="list-style-type: none"><li>• Client domain to append to unqualified service names or network service names</li><li>• Order of naming methods the client should use when resolving a name</li><li>• Logging and tracing features to use</li><li>• Route of connections</li><li>• External naming parameters</li><li>• Oracle security parameters</li><li>• Database access control parameters</li></ul>
<code>listener.ora</code>	Located on the database server, this configuration file for the listener may include the following: <ul style="list-style-type: none"><li>• Protocol addresses it is accepting connection requests on</li><li>• Database and nondatabase services it is listening for</li><li>• Control parameters used by the listener</li></ul>
<code>cman.ora</code>	Located on the computer where Oracle Connection Manager runs, this configuration file includes the following components: <ul style="list-style-type: none"><li>• A listening endpoint</li><li>• Access control rule list</li><li>• Parameter list</li></ul> Each Oracle Connection Manager configuration is encapsulated within a single name-value (NV) string, which consists of the preceding components.

Configuration files are by default created in the `ORACLE_BASE_HOME/network/admin` directory. However, configuration files can be created in other directories. Oracle Net checks the other directories for the configuration files. For example, the order for checking the `tnsnames.ora` file is as follows:

- The directory specified by the `TNS_ADMIN` environment variable. If the file is not found in the directory specified, then it is assumed that the file does not exist.
- If the `TNS_ADMIN` environment variable is not set, then Oracle Net checks for the files in the `ORACLE_BASE_HOME/network/admin` directory.
- If the files are not present in the `ORACLE_BASE_HOME/network/admin` directory, then Oracle Net checks for the files in the `ORACLE_HOME/network/admin` directory.

 **Note:**

On Microsoft Windows, the `TNS_ADMIN` environment variable is used if it is set in the environment of the process. If the `TNS_ADMIN` environment variable is not defined in the environment, or the process is a service which does not have an environment, then Microsoft Windows scans the registry for a `TNS_ADMIN` parameter.

 **See Also:**

- *Oracle Database Global Data Services Concepts and Administration Guide* for information about the `gsm.ora` file
- Operating system-specific documentation

## 3.2 Using a Directory Server for Centralized Management

When an Oracle network uses a directory server, the directory server manages global database links as network service names for the Oracle databases in the network. Users and programs can use a global link to access objects in the corresponding database.

Oracle Net Services uses a centralized directory server as one of the primary methods for storing connect identifiers. Clients use the connect identifiers in their connect string, and the directory server resolves the connect identifier to a connect descriptor that is passed back to the client. This feature is called directory naming. This type of infrastructure reduces the cost of managing and configuring resources in a network.

Oracle Internet Directory provides a centralized mechanism for managing and configuring a distributed Oracle network. The directory server can replace client-side and server-side localized `tnsnames.ora` files.

The following figure shows a client resolving a connect identifier through a directory server.

1. The client contacts the directory server to resolve a connect identifier to a connect descriptor.

2. The directory server resolves the connect identifier and retrieves the connect descriptor for the client.
3. The client sends the connection request to the listener, using the connect descriptor.

**Figure 3-1 Client Using a Directory Server to Resolve a Connect Identifier**

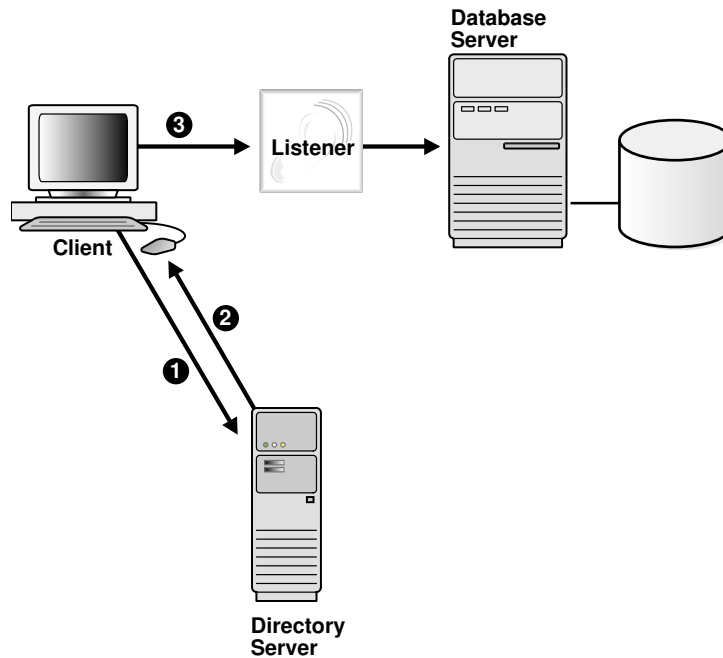

 **Note:**

Java Database Connectivity (JDBC) Drivers support directory naming. See *Oracle Database JDBC Developer's Guide* for additional information.

This section contains the following topics:

- [Understanding the Directory Information Tree](#)
- [Understanding Oracle Context](#)
- [Understanding Net Service Alias Entries](#)
- [Who Can Add or Modify Entries in the Directory Server](#)
- [Client Connections Using Directory Naming](#)
- [Considerations When Using Directory Servers](#)
- [Limitations of Directory Naming Support with Microsoft Active Directory](#)

## 3.2.1 Understanding the Directory Information Tree

Directory servers store information in a hierarchical namespace structure called a directory information tree (DIT). Each node in the tree is called an entry. Oracle Net

Services uses both the tree structure and specific entries in the tree. DITs are commonly aligned with an existing domain structure such as a Domain Name System (DNS) structure or a geographic and organization structure.

The following figure shows a DIT structured according to DNS domain components.

**Figure 3-2 DNS Domain Component DIT**

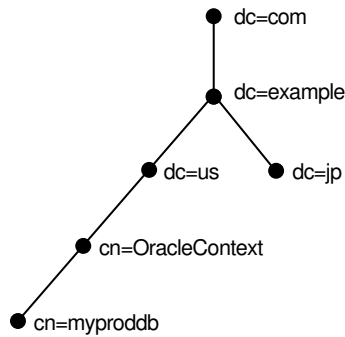

The following figure shows a DIT structured according to country, organization, and organizational units. This structure is commonly referred to as an X.500 DIT.

**Figure 3-3 X.500 DIT**

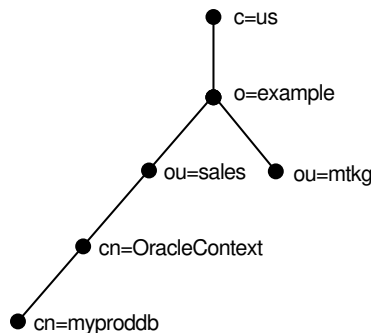

For example, consider [Figure 3-4](#). The `cn=sales` and `cn=db1` entries represent a network service name and a database service, respectively. Additional entries under `cn=sales` and `cn=db1` contain the connect descriptor information. These entries are not represented in the graphic. The `cn=sales` and `cn=db1` entries enable clients to connect to the database using connect strings `CONNECT username@sales` and `CONNECT username@db1`.

**Figure 3-4 Database Service and Net Service Entries in a DIT**

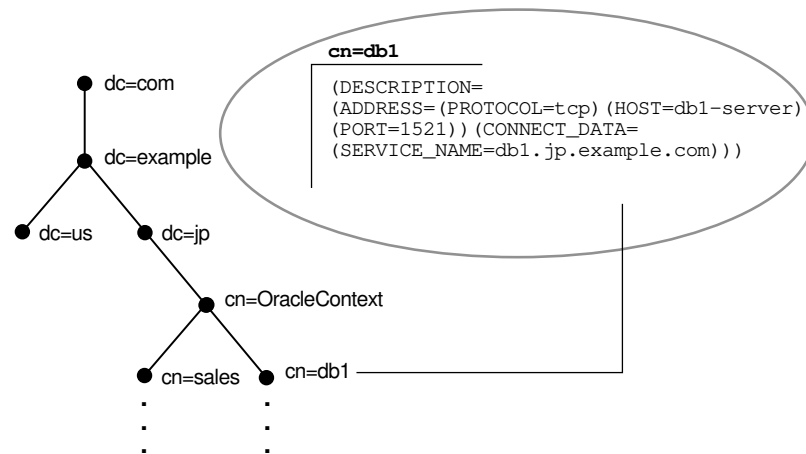

Each entry is uniquely identified by a distinguished name (DN). The DN indicates exactly where the entry resides in the directory server hierarchy. The DN for db1 is `dn:cn=db1,cn=OracleContext,dc=jp,dc=example,dc=com`. The DN for sales is `dn:cn=sales,cn=OracleContext,dc=jp,dc=example,dc=com`. The format of a DN places the lowest component of the DIT to the left, then moves progressively up the DIT.

Each DN is made up of a sequence of relative distinguished names (RDNs). The RDN consists of an attribute, such as `cn`, and a value, such as `db1` or `sales`. The RDN for db1 is `cn=db1`, and the RDN for sales is `cn=sales`. The attribute and its value uniquely identify the entry.

- [Fully-Qualified Names for Domain Component Namespaces](#)
- [Fully-Qualified Names for X.500 Namespaces](#)
- [Using the Relative Name of an Entry](#)
- [Using the Fully-Qualified Name of an Entry](#)

### 3.2.1.1 Fully-Qualified Names for Domain Component Namespaces

For domain component namespaces, the default directory entry defined for the client must be in one of the following formats:

```
dc[,dc][...]  
ou,dc[,dc][...]
```

In the preceding syntax, `[dc]` represents an optional domain component, `[...]` represents additional domain component entries and `ou` represents the organizational unit entry.

The fully-qualified name used in the connect identifier by the client must be in one of the following formats:

```
cn.dc[.dc][...]  
cn[.ou]@dc[.dc][...]
```

In the preceding syntax, `[cn]` represents the Oracle Net entry.

### Example 3-1 Using a Fully-Qualified Name with an Organizational Unit

Consider a directory server that contains an entry for database object `sales` with a DN of `cn=sales,cn=OracleContext,dc=jp,dc=example,dc=com`. In this example, the client requires a connect identifier of `sales.jp.example.com`.

Consider a similar entry that contains database object `sales` with a DN of `cn=sales,cn=OracleContext,ou=mktg,dc=jp,dc=example,dc=com`.

Because domain components must be separated from organization units, the client must use the format `cn.ou@dc.dc.dc`. The client requires the connect identifier to be `sales.mktg@jp.example.com`.

Figure 3-5 illustrates the preceding example.

Figure 3-5 Fully-Qualified Name for Domain Component Namespaces

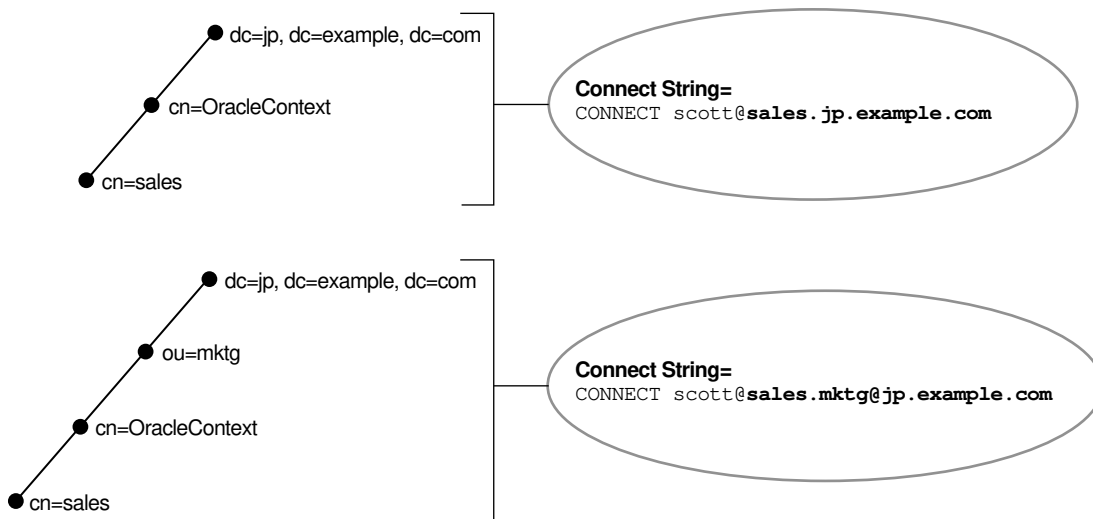

### 3.2.1.2 Fully-Qualified Names for X.500 Namespaces

For X.500 namespaces, the default directory entry defined for the client must be in one of the following formats:

```
[ou],o
[ou],o,c
```

In the preceding formats, `[ou]` represents an optional organizational unit name, `o` represents the organization, and `c` represents the country.

The fully-qualified name the client uses as the connect identifier must be in one of the following formats:

```
cn[.ou].o
cn[.ou].o.c
```

In the preceding formats, `cn` represents the Oracle Net entry.

For example, if the directory contains database object `sales` with a DN of `cn=sales,cn=OracleContext,ou=mktg,o=example,c=jp`, then the client requires a connect identifier of `sales.mktg.example.jp`. Figure 3-6 illustrates this example.

Figure 3-6 Fully-Qualified Name for X.500 Namespaces

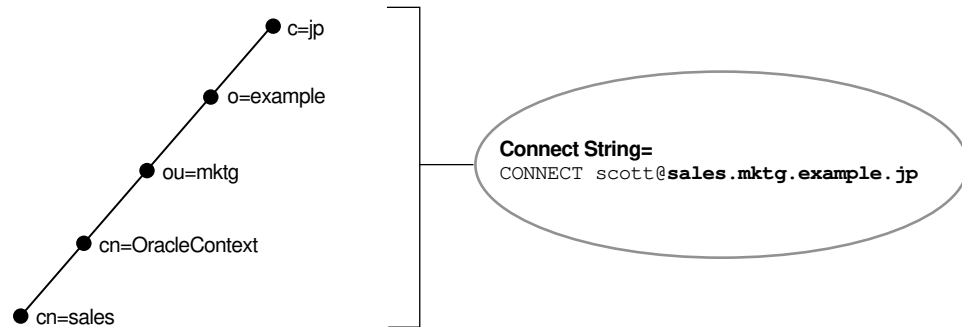

### 3.2.1.3 Using the Relative Name of an Entry

If a client is configured with a default realm Oracle Context, then an entry can be identified by its relative name, and the service can be referred to by its common name. A relative name can be used if the entry is in the same Oracle Context that was configured to be the default Oracle Context for the client's Oracle home.

Consider a directory server that contains an entry for a database called sales with a DN of `dn:cn=sales,cn=OracleContext,o=example,c=us`, as shown in Figure 3-7. If the client is configured with a default realm Oracle Context of `cn=OracleContext,o=example,c=us`, then the connect identifier can simply be `sales`.

Figure 3-7 Relative Naming

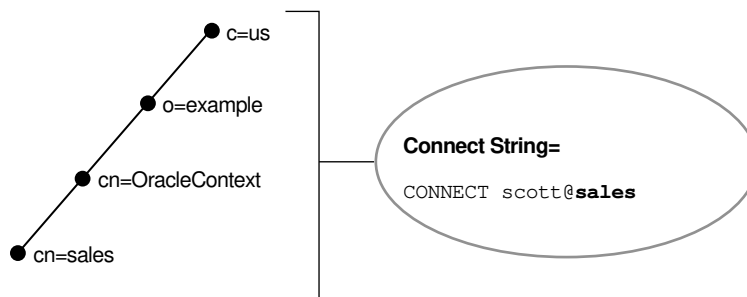

 **Note:**

The JDBC OCI Driver supports both full-qualified and relative naming. The JDBC Thin Driver supports fully-qualified naming only when the complete DN is used.

 **See Also:**

- *Oracle Fusion Middleware Administrator's Guide for Oracle Internet Directory* for additional information about how clients locate a directory
- *Oracle Database JDBC Developer's Guide* for additional information about JDBC drivers

### 3.2.1.4 Using the Fully-Qualified Name of an Entry

Consider the same directory structure as shown in [Figure 3-7](#), but with the client's Oracle home configured with a default realm Oracle Context of `cn=OracleContext,o=example,c=jp`.

Because the client is configured with a default Oracle Context that does not match the location of sales in the directory server, a connect string that uses sales does not work. Instead, the client must specifically identify the location of sales, which can be done using one of the following ways:

- The entry's complete DN can be used in the connect string, for example:

```
CONNECT username@"cn=sales,cn=OracleContext,o=example,c=us"  
Enter password: password
```

JDBC Thin drivers support fully-qualified naming only when the complete DN is used. However, many applications do not support the use of a DN.

- The entry can be referred to by a fully-qualified DNS-style name which is mapped by the Directory Naming adapter to the full x.500 DN of the database object in the LDAP directory, for example:

```
CONNECT username@sales.example.us  
Enter password: password
```

 **Note:**

JDBC OCI Drivers support fully-qualified naming. JDBC Thin Drivers support fully-qualified naming only when the complete DN is used. See the *Oracle Database JDBC Developer's Guide* for additional information.

## 3.2.2 Understanding Oracle Context

In [Figure 3-8](#), the entries `db1` and `sales` reside under `cn=OracleContext`. This entry is a special RDN called an Oracle Context. The entries under Oracle Context support various directory-enabled features, including directory naming.



Figure 3-8 Oracle Context in the DIT

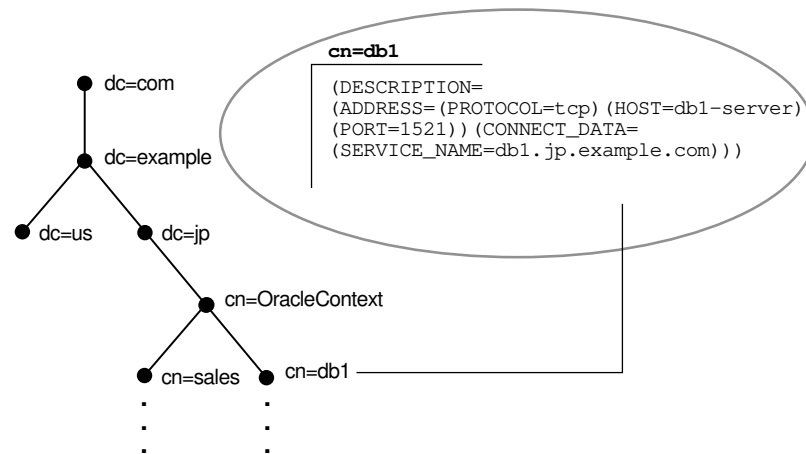

During directory configuration, you set the default Oracle Context. Clients use this Oracle Context as the default location to look up connect identifiers in the directory server. With Oracle Internet Directory, an Oracle Context located at the root of the DIT, with DN of `dn:cn=OracleContext`, points to a default Oracle Context in an identity management realm. An identity management realm is a collection of identities governed by the same administrative policies. This Oracle Context is referred to as a realm Oracle Context. Unless configured to use another Oracle Context, clients use this realm-specific Oracle Context.

The default Oracle Context affects the connect string. For example, if a client must access the `db1` and `sales` entry frequently, then a reasonable default Oracle Context would be `dc=jp,dc=example,dc=com`. If a client directory entry does not match the directory entry where a service is located, then the client must specify the fully-qualified name of an entry in the connect string, as described in ["Client Connections Using Directory Naming"](#).

 **Note:**

The RDN `cn=OracleContext` does not have to be explicitly specified in the connect string.

 **See Also:**

*Oracle Fusion Middleware Administrator's Guide for Oracle Internet Directory* for additional information about an identity management realm

### 3.2.3 Understanding Net Service Alias Entries

Directory naming enables you to create network service alias entries in addition to database service and network service name entries. A network service alias is an

alternative name for a network service name or database service. A network service alias entry does not have connect descriptor information. Instead, it references the location of the entry for which it is an alias. When a client requests a directory lookup of a network service alias, the directory determines that the entry is a network service alias and completes the lookup as if it is the referenced entry. For example, in the following figure, a network service alias of db1alias is created for a database service of db1. When db1alias is used to connect to a database service, as in `CONNECT username@db1alias`, it will actually resolve to and use the connect descriptor information for db1.

**Figure 3-9 Net Service Alias db1alias in a Directory Server**

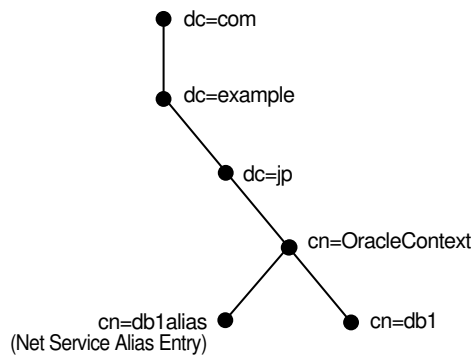

There are several uses for network service aliases. As shown in [Figure 3-9](#), a network service alias can be useful as a way for clients to refer to a network service name by another name. Another use is to have a network service alias in one Oracle Context for a database service or network service name in a different Oracle Context. This enables a database service or network service name to be defined once in the directory server, but referred to by clients that use other Oracle Contexts.

In [Figure 3-10](#), database service db1 resides in `dc=jp,dc=example,dc=com`. A network service alias named db1 is created in `dc=us,dc=example,dc=com`. This enables clients in both Japan and the United States to use the connect string `CONNECT username@db1` as opposed to clients in the United States needing to specify `CONNECT username@db1.jp.example.com`.

**Figure 3-10 Net Service Alias db1 in a Directory Server**

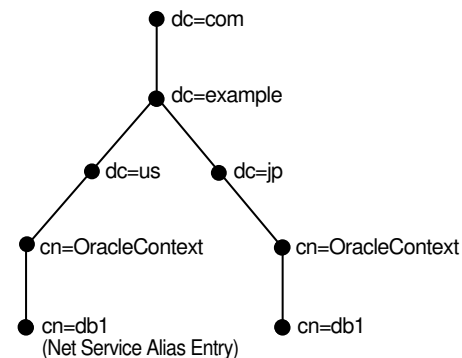

## 3.2.4 Who Can Add or Modify Entries in the Directory Server

The database service entries are configured during or after installation. You can then use Oracle Enterprise Manager Cloud Control or Oracle Net Manager to modify the Oracle Net attributes of the database service entries. You can also use these tools to create network service name and network service alias entries.

To use these configuration tools, a DIT structure containing a root Oracle Context, and identity management realm must exist. The directory administrator creates this structure with Oracle Internet Directory Configuration Assistant. For some deployments, the directory administrator may need to create additional Oracle Contexts. Additional Oracle Contexts are usually used to subdivide large sites, or separate a production environment from a test environment.

Certain tools are used by certain groups, and you must be a member of the group to use the tools, as described in the following:

- To create a database service entry with Database Configuration Assistant:
  - OracleDBCreators group (cn=OracleDBCreators,cn=OracleContext...)
  - OracleContextAdmins group (cn=OracleContextAdmins,cn=Groups,cn=OracleContext...)
- To create network service names or network service aliases with Oracle Net Manager:
  - OracleNetAdmins group (cn=OracleNetAdmins,cn=OracleContext...)
  - OracleContextAdmins group

The OracleNetAdmins group is owned by itself. Members of the OracleNetAdmins group have create, modify, and read access to Oracle Net objects and attributes. They can also add or delete members in the group, and add or delete groups to be owners of the OracleNetAdmins group.

Any member of the OracleNetAdmins group can add or delete other members from the OracleNetAdmins group. If you prefer another group to add or delete OracleNetAdmins members, then you can change the owner attribute of the OracleNetAdmins group to another group. The owner cannot be an individual user entry but must be a group entry, and the group entry is one comprised of the LDAP schema object classes GroupOfUniqueNames and orclPriviledgeGroup.

The OracleContextAdmins group is a super-user group for Oracle Context. Members of the OracleContextAdmins group can add all supported types of entries to Oracle Context.

The directory user that created Oracle Context is automatically added to these groups. Other users can be added to these groups by the directory administrator.

 **See Also:**

- ["Configuring the Directory Naming Method"](#) for additional information about using Oracle Net Manager
- *Oracle Database Administrator's Guide* for additional information about registering a database service with Database Configuration Assistant

## 3.2.5 Client Connections Using Directory Naming

Most clients needing to perform name lookups in the directory server access the directory server using anonymous authentication. To perform a lookup, the directory server must allow anonymous authentication. Directory servers usually allow anonymous authentication by default, however, some directory servers, such as earlier releases of Oracle Internet Directory, require directory configuration to allow anonymous access.

To look up entries, a client must be able to find the directory server in which that entry resides. Clients locate a directory server in one of two ways:

- Dynamically using DNS. In this case, the directory server location information is stored and managed in a central domain name server. The client, at request processing time, retrieves this information from DNS.
- Statically in the directory server usage file, `ldap.ora`, created by Oracle Internet Directory Configuration Assistant and stored on the client host.

After a directory is found, clients are directed to the realm Oracle Context from the root Oracle Context.

Clients make connections to a database using connect identifiers in the same way they might use other naming methods. A connect identifier can be a database service, network service name, or network service alias. These can be referred to by their common names (relative name) if the default Oracle Context is where the entity resides. If not, then the connect identifier needs a fully-qualified name or distinguished name.

 **See Also:**

- *Oracle Fusion Middleware Administrator's Guide for Oracle Internet Directory*
- Microsoft Active Directory documentation

## 3.2.6 Considerations When Using Directory Servers

The following considerations should be reviewed when using directory servers:

- [Performance Considerations](#)
- [Security Considerations](#)

- [Object Classes](#)

### 3.2.6.1 Performance Considerations

Connect identifiers are stored in a directory server for all clients to access. Depending on the number of clients, there can be a significant load on a directory server.

During a connect identifier lookup, a name is searched under a specific Oracle Context. Users expect relatively quick performance so the database connect time is not affected. Because of the scope of the lookup, users may begin to notice slow connect times if lookups take more than one second.

You can resolve performance problems by changing the network topology or implementing replication.



#### See Also:

Directory server vendor documentation for details on resolving performance issues

### 3.2.6.2 Security Considerations

Administrative clients can create and modify entries in the directory server, so security is essential. This section contains the following security-related topics:

- [Authentication Methods](#)
- [Access Control Lists](#)

#### 3.2.6.2.1 Authentication Methods

Clients use different methods of authentication depending upon the task that is to be performed.

- Clients that perform lookups for information in the directory server typically use anonymous authentication. In Oracle Database 12c, it is possible to configure clients to authenticate their LDAP bind during name lookup. Sites that need to protect their network service data or disable anonymous binds to the directory must configure their clients to use wallets to authenticate during name lookup. These clients require setting the following two parameters in the `sqlnet.ora` file:

```
names.ldap_authenticate_bind = TRUE
wallet_location = location_value
```

- Clients that administer the directory server entries authenticate with the directory server. Database Configuration Assistant or Oracle Net Manager can be used to add or modify the entries. Only authenticated users with proper privileges can modify entries. Use one of the following authentication methods:

- Simple Authentication

The client identifies itself to the directory server by means of a DN and a password. The server verifies that the DN and password sent by the client matches the DN and password stored in the directory server.

– Strong Authentication

The client identifies itself to the directory server by means of a public-key encryption available with Secure Sockets Layer (SSL). In public-key encryption, the sender of a message encrypts the message with the public key of the recipient. Upon delivery, the recipient decrypts the message using the recipient's private key.

### 3.2.6.2.2 Access Control Lists

Authentication is used with **access control lists (ACLs)** to determine whether clients can read, modify, or add information in the directory server. ACLs specify the following:

- The entries that the user can access.
- The authentication method used to access the entry.
- The access rights, or what the user can do with the object, such as read or write.

ACLs are established for a group of users. During Oracle Context creation, the `OracleDBCreators`, `OracleNetAdmins`, and `OracleContextAdmins` groups are created.

The user who creates Oracle Context using Oracle Net Configuration Assistant is automatically added as the first member of these groups.

[Table 3-2](#) describes ACL requirements for these groups, anonymous users, and their relation to Oracle Net entries in the directory server.

**Table 3-2 ACL Requirements for User Groups**

Group	ACL Requirements
Anonymous users	<p>All Oracle Net attributes and objects in the directory server have read access for the anonymous user. Read access of these objects for anonymous is also applied to Oracle Context. This enables anonymous users to browse directory naming entries contained within the <code>cn=OracleContext</code> RDN. This does not include objects used for enterprise user security.</p> <p>Oracle Net Configuration Assistant sets up this access during client installation.</p>
OracleContextAdmins group users	<p>Members of <code>OracleContextAdmins</code> (<code>cn=OracleContextAdmins, cn=Groups, cn=OracleContext, . . .</code>) have create, modify, and read access to all directory naming objects. Oracle Net Configuration Assistant establishes these access rights for this group during Oracle Context creation.</p> <p>In addition to the Oracle Context creator, other users can be added to this group by the directory administrator using Oracle Enterprise Manager Cloud Control.</p>
OracleDBCreators group users	<p>Members of <code>OracleDBCreators</code> (<code>cn=OracleDBCreators, cn=OracleContext, . . .</code>) have create and read access to database service objects and attributes. Oracle Net Configuration Assistant establishes the access rights for this group during Oracle Context creation.</p> <p>In addition to the Oracle Context creator, other users can be added to this group by the directory administrator with Oracle Enterprise Manager Cloud Control.</p>

**Table 3-2 (Cont.) ACL Requirements for User Groups**

Group	ACL Requirements
OracleNetAdmins group users	<p>Members of OracleNetAdmins (cn=OracleNetAdmins, cn=OracleContext, ...) have create, modify, and read access to directory naming objects and attributes. Oracle Net Configuration Assistant establishes these access rights for this group during Oracle Context creation.</p> <p>In addition to the Oracle Context creator, other users can be added to this group by the directory administrator.</p>

Situations in which a high degree of security is desired for lookup or read-access to Oracle Net Services name and related data, administrators can define additional read-access control for some or all of the data. Such ACL definitions can prevent anonymous users from reading the Oracle Net Services data. If read-access to Oracle Net Services data is restricted, then clients must use authenticated binds to do name lookups.

There are no predefined groups or procedures for the Oracle configuration tools for defining read-access restrictions on this data, so administrators must use standard object management tools from their directory system to manually create any necessary groups and ACLs.

ACLs can be added to Oracle Net Services objects using `ldapmodify` and an LDIF-format file. [Example 3-2](#) shows how to restrict all access for user, `cn=user1`:

**Example 3-2 Restricting User Access with an Access Control List**

```
dn: cn=sales,cn=oraclecontext,dc=example,dc=com
replace: orclentrylevelaci
orclentrylevelaci: access to attr=(*)
by dn="cn=user1" (noread,nosearch,nowrite,nocompare)
```

The preceding example illustrates the basic form of an ACL for a single object. This approach is not necessarily the best way to define access because access definitions for objects are complex and may involve security properties which are inherited from parent nodes in the DIT. Oracle recommends that administrators refer to the documentation for their directory systems, and integrate access management for Oracle Net Services objects into a directory-wide policy and security implementation.

For Oracle Internet Directory directories, `oidadmin` has functionality to create users, groups, and also define ACLs for objects and general directory security.

 **See Also:**

- Documentation from your directory server vendor for information about how to set ACLs on directory entry
- "[Authentication Methods](#)" for information about configuring clients to use authenticated binds for name lookup
- "[About the OracleNetAdmins Group](#)" for information about adding users to the OracleNetAdmins group
- *Oracle Fusion Middleware Administrator's Guide for Oracle Internet Directory*

### 3.2.6.3 Object Classes

Directories must be populated with the correct version of the Oracle schema before Oracle Context, a database service or network service name entry can be created. The Oracle schema defines the type of objects, called object classes, that can be stored in the directory server and their attributes. The following table lists the object classes for database service, network service name, and network service alias entries.

**Table 3-3 Oracle Net Services LDAP Main Object Classes**

Object Class	Description
orclDbServer	Defines the attributes for database service entries.
orclNetService	Defines the attributes for network service name entries.
orclNetServiceAlias	Defines the attributes for network service alias entries.

The following table lists the object classes used by `orclDbServer`, `orclNetService`, and `orclNetServiceAlias`.

**Table 3-4 Oracle Net Services LDAP Derived Object Classes**

Object Class	Description
orclNetAddress	Defines a listener protocol address.
orclNetAddressList	Defines a list of addresses.
orclNetDescription	Specifies a connect descriptor containing the protocol address of the database and the connect information to the service.
orclNetDescriptionList	Defines a list of connect descriptors.

These object classes use attributes that specify the contents of connect descriptors.



 **See Also:**

*Oracle Database Net Services Reference* for additional information about these object classes and their attributes

## 3.2.7 Limitations of Directory Naming Support with Microsoft Active Directory

In addition to Oracle Internet Directory, directory naming support is also provided with Microsoft Active Directory with the following limitations:

- Oracle provides support for Microsoft Active Directory only on Microsoft Windows operating systems. Therefore, client computers and the database server must run on Microsoft Windows operating systems to access or create entries in Microsoft Active Directory.
- The following features are not supported by Microsoft Active Directory:
  - Multiple Oracle Contexts  
Microsoft Active Directory can support only one Oracle Context.
  - Net service aliases  
You cannot create network service aliases in Microsoft Active Directory. However, you can create network service names.

 **See Also:**

Microsoft Active Directory documentation for Microsoft-specific information

# 4

## Understanding the Communication Layers

The primary function of Oracle Net is to establish and maintain connections between a client application and an Oracle database server. Oracle Net is comprised of several communication layers that enable clients and database servers to share, modify, and manipulate data.

- [Understanding Oracle Net Stack Communication for Client/Server Applications](#)
- [Using Oracle Net Stack Communication for Java Applications](#)
- [Using Oracle Net Stack Communication for Web Clients](#)
- [Understanding Oracle Protocol Support Layer](#)

### See Also:

[Introducing Oracle Net Services](#) for an introductory overview of Oracle Net architecture

### 4.1 Understanding Oracle Net Stack Communication for Client/Server Applications

A database server is the Oracle software managing a database, and a client is an application that requests information from the server. The way the client and server communicate is known as the client/server stack.

Information passed from a client application sent by the client communication stack across a network protocol is received by a similar communication stack on the database server side. The process flow on the database server side is the reverse of the process flow on the client side, with information ascending through the communication layers.

[Figure 4-1](#) illustrates the various layers on the client and on the database server after a connection has been established.

**Figure 4-1 Layers Used in a Client/Server Application Connection**

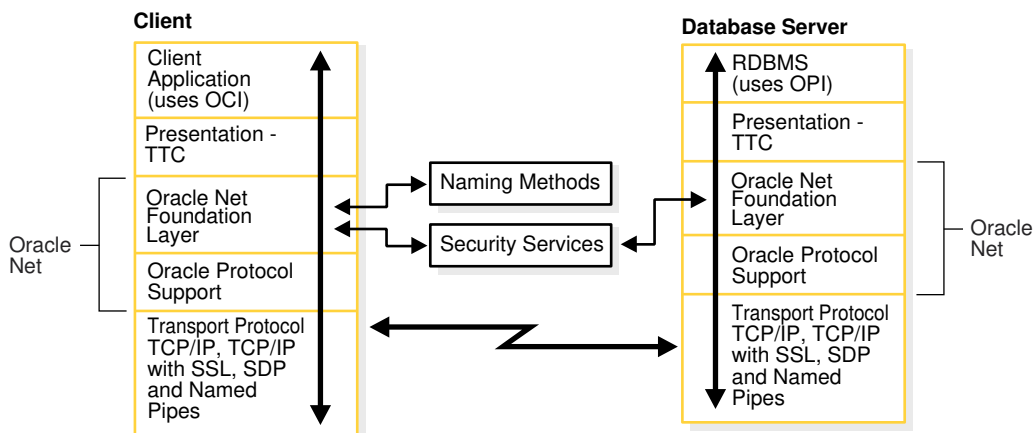

This communication architecture is based on the Open Systems Interconnection (OSI) model. In the OSI model, communication between separate computers occurs in a stack-like fashion with information passing from one node to the other through several layers of code, including:

1. Physical layer
2. Data link layer
3. Network layer
4. Transport layer
5. Session layer
6. Presentation layer
7. Application layer

The following figure shows how Oracle Net software consisting of the Oracle Net foundation layer and Oracle Protocol Support fits into the session layer of the OSI model.

**Figure 4-2** OSI Communication Layers

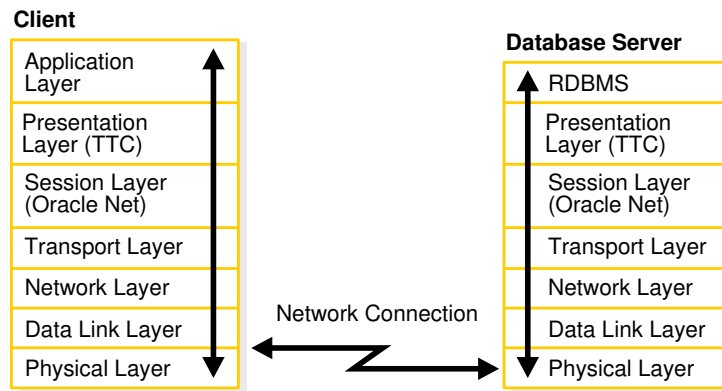

**illustration:** net81100  
**release:** 9  
**caption:** OSI Communication Layers  
**date:** 12/18/00  
**platform:** pc

 **See Also:**

For additional information about the OSI stack, go to

<http://www.ietf.org>

This section contains the following topics:

- [About the Client Communication Stack](#)
- [About the Server Communication Stack](#)

## 4.1.1 About the Client Communication Stack

The client communication stack includes the following:

- [Client Application Layer](#)
- [Presentation Layer](#)
- [Oracle Net Foundation Layer](#)
- [Oracle Protocol Support Layer](#)

### 4.1.1.1 Client Application Layer

During a session with the database, the client uses Oracle Call Interface (OCI) to interact with the database server. OCI is a software component that provides an interface between the application and SQL.



#### See Also:

*Oracle Call Interface Programmer's Guide*

### 4.1.1.2 Presentation Layer

Character set differences can occur if the client and database server run on different operating systems. The presentation layer resolves any differences. It is optimized for each connection to perform conversion when required.

The presentation layer used by client/server applications is Two-Task Common (TTC). TTC provides character set and data type conversion between different character sets or formats on the client and database server. At the time of initial connection, TTC is responsible for evaluating differences in internal data and character set representations and determining whether conversions are required for the two computers to communicate.

### 4.1.1.3 Oracle Net Foundation Layer

The Oracle Net foundation layer is responsible for establishing and maintaining the connection between the client application and database server, as well as exchanging messages between them. The Oracle Net foundation layer can perform these tasks because of Transparent Network Substrate (TNS) technology. TNS provides a single, common interface for all industry-standard OSI transport and network layer protocols. TNS enables peer-to-peer application connectivity, where two or more computers can communicate with each other directly, without the need for any intermediary devices.

On the client side, the Oracle Net foundation layer receives client application requests and resolves all generic computer-level connectivity issues, such as:

- The location of the database server or destination
- How many protocols are involved in the connection
- How to handle interrupts between client and database server based on the capabilities of each

On the server side, the Oracle Net foundation layer performs the same tasks as it does on the client side. It also works with the listener to receive incoming connection requests.

In addition to establishing and maintaining connections, the Oracle Net foundation layer communicates with naming methods to resolve names and uses security services to ensure secure connections.

#### 4.1.1.4 Oracle Protocol Support Layer

Oracle protocol support layer is positioned at the lowest layer of the Oracle Net foundation layer. It is responsible for mapping TNS functionality to industry-standard protocols used in the client/server connection. This layer supports the following network protocols:

- TCP/IP (IPv4 and IPv6)
- TCP/IP with SSL
- Named Pipes
- Sockets Direct Protocol (SDP)
- Exadirect

All Oracle software in the client/server connection process requires an existing network protocol stack to establish the computer-level connection between the two computers for the transport layer. The network protocol is responsible for transporting data from the client computer to the database server computer, at which point the data is passed to the server-side Oracle protocol support layer.



#### See Also:

"[Understanding Oracle Protocol Support Layer](#)" for descriptions of the protocols

#### 4.1.2 About the Server Communication Stack

The server communication stack uses the same layers as the client stack with the exception that the database uses Oracle Program Interface (OPI). For each statement sent from OCI, OPI provides a response. For example, an OCI request to fetch 25 rows would elicit an OPI response to return the 25 rows after they have been fetched.

## 4.2 Using Oracle Net Stack Communication for Java Applications

The Oracle Java Database Connectivity (JDBC) Drivers provide Java applications access to an Oracle database. Oracle offers two JDBC drivers.

- JDBC OCI Driver is a type 2 JDBC driver which is used by client/server Java applications. The JDBC OCI driver uses a communication stack similar to a standard client/server communication stack. The JDBC OCI driver converts JDBC invocations to calls to OCI which are then sent over Oracle Net to the Oracle database server.
- JDBC Thin Driver is a type 4 driver which is used by Java applets. The JDBC Thin Driver establishes a direct connection to the Oracle database server over Java sockets. The JDBC Thin driver uses a Java implementation of the Oracle Net foundation layer called JavaNet and a Java implementation of TTC called JavaTTC to access the database.

The following figure shows the stack communication layers used by JDBC drivers.

**Figure 4-3 Layers Used for Java-Client Applications**

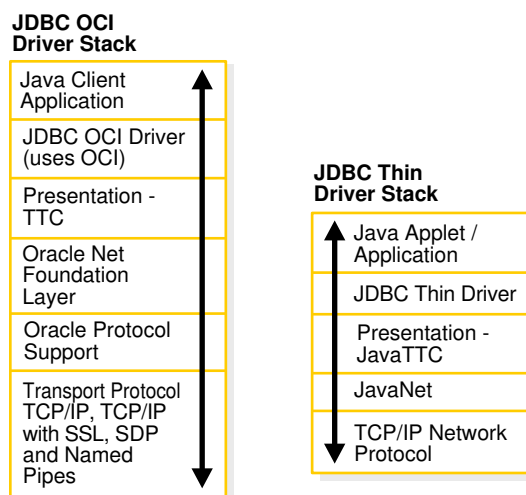

**See Also:**

*Oracle Database JDBC Developer's Guide*

## 4.3 Using Oracle Net Stack Communication for Web Clients

The Oracle database server supports many other implementations for the presentation layer that can be used for web clients accessing features inside the database in

addition to TTC. The listener facilitates this by supporting any presentation implementation requested by the database.

Figure 4-4 shows the stack communication layers used in an HTTP or FTP connection to Oracle XML DB in the Oracle database instance. WebDAV connections use the same stack communication layers as HTTP and FTP.

**Figure 4-4 Layers Used in Web Client Connections**

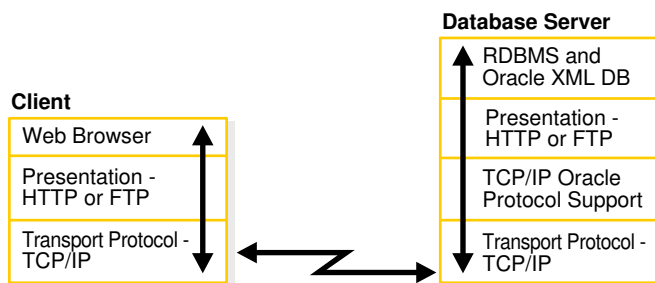

 **See Also:**

*Oracle XML DB Developer's Guide*

## 4.4 Understanding Oracle Protocol Support Layer

A network protocol is responsible for transporting data from the client computer to the database server computer. This section describes the protocols used by the Oracle Protocol Support layer of the Oracle Net communication stack.

- [About TCP/IP Protocol](#)
- [About TCP/IP with SSL Protocol](#)
- [About Named Pipes Protocol](#)
- [About Sockets Direct Protocol \(SDP\)](#)
- [About Exadirect Protocol](#)
- [About Websocket Protocol](#)

### 4.4.1 About TCP/IP Protocol

TCP/IP (Transmission Control Protocol/Internet Protocol) is the standard communication protocol suite used for client/server communication over a network. TCP is the transport protocol that manages the exchange of data between hosts. IP is a network layer protocol for packet-switched networks.

Oracle Net supports IP in two versions: IP version 4 (IPv4) and IP version 6 (IPv6). IPv6 addresses the shortcomings of the currently used IPv4. The primary benefit of IPv6 is a large address space derived from the use of 128-bit addresses.



- [IPv6 Address Notation](#)
- [IPv6 Interface and Address Configurations](#)
- [IPv6 Network Connectivity](#)
- [IPv6 Support in Oracle Database 12c](#)

**See Also:**

<http://tools.ietf.org/html/rfc2460> for the IPv6 specification

### 4.4.1.1 IPv6 Address Notation

Oracle Database supports the standard IPv6 address notations specified by RFC 2732. A 128-bit IP address is generally represented as 8 groups of 4 hexadecimal digits, with the colon (:) symbol as the group separator. For example, the following address is in a valid IPv6 format:

```
2001:0db8:0000:0000:0000:0000:200C:417A
```

Each hexadecimal digit in the address represents 4 bits, so each group in the address represents 16 bits. The following addresses represent the first and last hosts in the 2001:0db8:0000:0000 subnet:

```
2001:0db8:0000:0000:0000:0000:0000:0000
```

```
2001:0db8:0000:0000:FFFF:FFFF:FFFF:FFFF
```

In shorthand notation, consecutive zero fields can be compressed with a double colon (::) separator, as shown in the following equivalent notations:

```
2001:0db8:0:0::200C:417A
```

```
2001:0db8::200C:417A
```

```
2001:DB8::200C:417A
```

- [CIDR Notation](#)
- [IPv6 Addresses in URLs](#)
- [IPv4-Mapped Addresses](#)

**See Also:**

- <http://www.ietf.org/rfc/rfc2732.txt> for RFC 2732, and information about notational representation
- <http://www.ietf.org/rfc/rfc3513.txt> for RFC 3513, and information about proper IPv6 addressing

### 4.4.1.1.1 CIDR Notation

Classless Inter-Domain Routing (CIDR) is a method of grouping IP addresses into subnets that are independent of the value of the addresses. Classless routing was

designed to overcome the exhaustion of address space in the IP class system and the unmanageable growth in the size of routing tables.

CIDR denotes a network by the first address in the network and the size in bits of the network prefix in decimal, separated with a slash (/). For example, `2001:0db8::/32` indicates that the first 32 bits of the address identify the network, whereas the remaining bits identify the hosts in the network.

CIDR uses an analogous notation for IPv4 address. For example, in the notation `192.0.2.0/24` the first 24 bits of the address represent the network prefix. The `DBMS_NETWORK_ACL_ADMIN` package, which provides an API to manage access control lists, supports CIDR notation for both IPv6 and IPv4 addresses and subnets.

#### See Also:

- *Oracle Database PL/SQL Packages and Types Reference* to learn about `DBMS_NETWORK_ACL_ADMIN`
- <http://tools.ietf.org/html/rfc4632> for RFC 4632

### 4.4.1.1.2 IPv6 Addresses in URLs

In URLs, IPv6 addresses are enclosed by the left bracket ([) and right bracket (]) characters. For example, the IPv6 address `[2001:0db8:0:0:8:800:200C:417A]` forms part of the following URLs:

```
http://[2001:0db8:0:0:8:800:200C:417A]
http://[2001:0db8:0:0:8:800:200C:417A]:80/index.html
```

### 4.4.1.1.3 IPv4-Mapped Addresses

IPv4-mapped addresses are a subclass of IPv6 addresses in which the following conditions are true:

- The first 80 bits are set to 0 in the standard IPv6 notation
- The second 16 bits are set to 1 in the standard IPv6 notation
- The last 32 bits are in IPv4 notation

An IPv4-mapped address can represent the addresses of IPv4-only nodes as IPv6 addresses.

[Example 4-1](#) shows the same IP address in different notations. The first address uses standard IPv6 notation. The second address is an IPv4-mapped address in which the last 32 bits use dotted-decimal IPv4 notation. The last address uses a shorthand notation to compress the consecutive zero fields.

#### **Example 4-1 IPv4-Mapped Address**

```
0000:0000:0000:0000:0000:FFFF:C0A8:0226
0000:0000:0000:0000:0000:FFFF:192.0.2.38
::FFFF:192.0.2.38
```

 **See Also:**

<http://tools.ietf.org/html/rfc4942> for security consideration relating to the use of IPv4-mapped addresses

### 4.4.1.2 IPv6 Interface and Address Configurations

A host may have different IPv4 and IPv6 interface configurations. The following configurations are possible for a host:

- Only an IPv4 interface, in which case the host is an IPv4-only host.
- Only an IPv6 interface, in which case the host is an IPv6-only host.
- Both an IPv4 and IPv6 interface, in which case the host is a dual-stack host.

A single host may also use different types of IP address. For example, a domain name server may associate a dual-stack host both by an IPv4 and an IPv6 address or only an IPv6 address. The IP address configurations that are not supported are the following:

- An IPv4-only host cannot use an IPv6 address.
- An IPv6-only host cannot use an IPv4 address.

Figure 4-5 shows possible host and interface configurations. The dual-stack host in the center of the diagram can communicate with IPv4 hosts over IPv4 and with IPv6 hosts over IPv6.

**Figure 4-5 Supported Host and Interface Configurations**

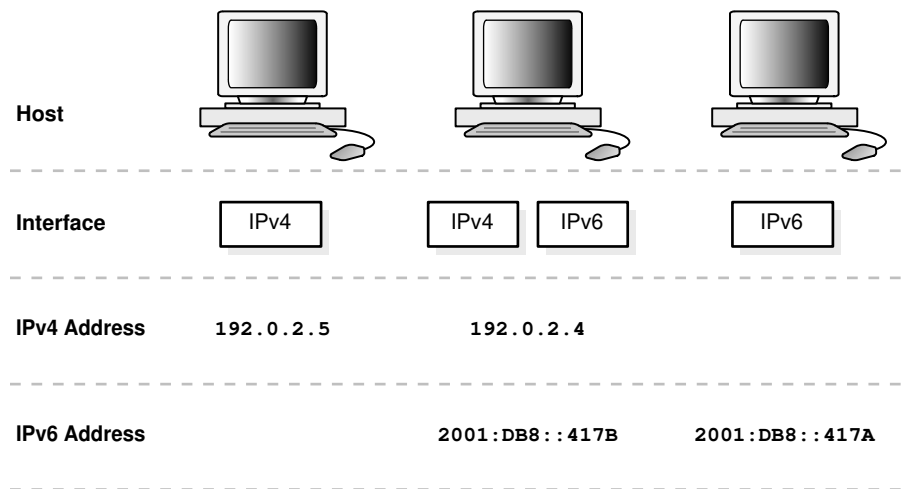

### 4.4.1.3 IPv6 Network Connectivity

The network connectivity of a host refers to its ability to communicate with another host over a network. For example, if a dual-stack client must communicate with an IPv6-only server, then the network and router must make end-to-end communication between these hosts possible.

A client or server host is IPv6-capable if it meets the following criteria:

- It has a configured IPv6 interface.
- It can connect to other hosts using the IPv6 protocol.

The IPv6 capability of a host is partially dependent on the network and partially dependent on its interface and address configuration. Figure 4-6 shows the possibilities for connectivity in a client/server network. For example, an IPv4-only host can connect to either an IPv4-only or dual-stack server, but not an IPv6-only server. Both dedicated and shared server modes are supported.

**Figure 4-6 Client/Server Connectivity**

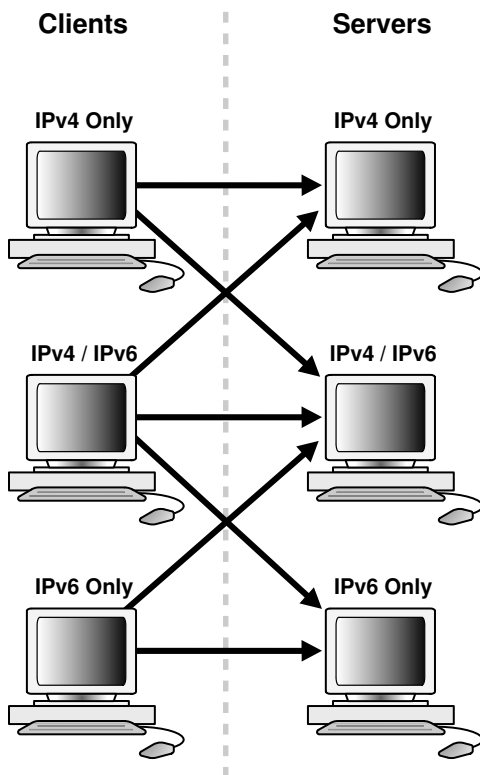

Table 4-1 summarizes the IP protocols used for client/server connectivity with different host and network configurations.

**Table 4-1 Supported Host and Network Configurations**

Client	IPv4-Only Server	Dual-Stack Server	IPv6-Only Server
IPv4-Only Client	Supported (v4)	Supported (v4)	Not Supported
Dual-Stack Client	Supported (v4)	Supported (v4, v6)	Supported (v6)
IPv6-Only Client	Not Supported	Supported (v6)	Supported

 **See Also:**

- ["About IPv6 Addresses in Connect Descriptors"](#)
- ["Configuring Listening Protocol Addresses"](#)
- ["Using Oracle Connection Manager as a Bridge for IPv4 and IPv6"](#)

#### 4.4.1.4 IPv6 Support in Oracle Database 12c

Components in this release of Oracle Database 12c support IPv6 in the configurations described in ["IPv6 Network Connectivity"](#), with the following exception:

- Oracle Clusterware for private and ASM networks

 **See Also:**

*Oracle Clusterware Administration and Deployment Guide*

#### 4.4.2 About TCP/IP with SSL Protocol

The TCP/IP with Secure Sockets Layer (SSL) protocol enables an Oracle application on a client to communicate with remote databases through TCP/IP and SSL. SSL stores authentication data, such as certificates and private keys, in an Oracle Wallet. When the client initiates a connection to the database server, SSL performs a handshake between the two using the certificate. During the handshake, the following processes occur:

- The client and database server negotiate a cipher suite made up a set of authentication, encryption, and data integrity types to apply to the messages they exchange.
- Depending on its configuration, the database server sends its certificate to the client in a message encrypted with the client's public key. The database server may also send a request for the client's certificate in the same message. The client decrypts this message by using its own private key, then verifies that the database server's certificate bears the certificate authority's signature.
- If required, the client may send the user's certificate to the database server. The certificate ensures that the user's information is correct and that the public key actually belongs to that user.

The database checks the user certificate to verify that it bears the signature of the certificate authority.

 **See Also:**

*Oracle Database Security Guide*

### 4.4.3 About Named Pipes Protocol

Named Pipes is specifically designed for Microsoft Windows LAN environments. The Named Pipes protocol is a high-level interface providing interprocess communications between clients and database servers using distributed applications. One server-side process creates a named pipe, and the client-side process opens it by name. What one side writes, the other can read.

If a remote Oracle database is running on a host system that supports network communication using Named Pipes, then Oracle Net enables applications on a client to communicate with the Oracle database using Named Pipes.

### 4.4.4 About Sockets Direct Protocol (SDP)

The Sockets Direct Protocol (SDP) is an industry-standard wire protocol between InfiniBand network peers. When used over an InfiniBand network, SDP reduces TCP/IP overhead by eliminating intermediate replication of data and transferring most of the messaging burden away from the CPU and onto the network hardware.

### 4.4.5 About Exadirect Protocol

The Exadirect protocol is an innovative protocol for low overhead database access. Use the new transport to improve latency and throughput by leveraging Remote Direct Memory Access (RDMA) in an InfiniBand environment.

Exadirect protocol uses TCP for control communication and IB RC transport for data.

The Exadirect protocol adapter is supported only on Oracle Linux in this release.

### 4.4.6 About WebSocket Protocol

The Database client connection supports secure websocket protocol. The secure websocket connection establishment is designed to work over HTTPS, to support HTTPS proxies, and intermediary proxies. This protocol offers a native connection to the database with minimum protocol overhead. Secure websocket protocol is used to negotiate SQL\*Net protocol during connection establishment between the database server and the client. The secure websocket protocol uses TLS and requires wallet for operation.

The Web server should support web socket tunneling. Web server proxy module (in case of Apache or Oracle HTTP Server (OHS), `mod_proxy_wstunnel`) proxies the secure web socket database connection data between the client and the backend database server. The Database client connects using secure websocket protocol to Web server and the Web server connects to the database using websocket protocol.

# 5

## Understanding Oracle Net Architecture

The Oracle Net listener is an application positioned on top of the Oracle Net foundation layer. The database receives an initial connection from a client application through the listener.

The listener brokers client requests, handing off the requests to the Oracle database server. Every time a client requests a network session with a database, the listener receives the initial request.

Figure 5-1 illustrates the various layers on the client and database during an initial connection. As shown in the diagram, the listener is at the top layer of the server-side network stack.

**Figure 5-1 Layers Used in an Initial Connection**

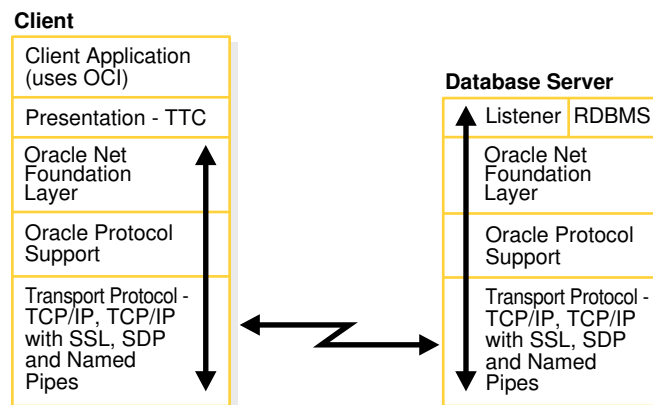

- [About Service Registration](#)
- [About the Listener and Connection Requests](#)
- [About Oracle Restart](#)
- [About Blocked Connection Requests](#)
- [Understanding Database Server Process Architecture](#)
- [Understanding Oracle Connection Manager Architecture](#)
- [Complete Architecture](#)

### 5.1 About Service Registration

The listener determines whether a database service and its service handlers are available through service registration. During registration, the Listener Registration (LREG) process provides the listener with information about the following:

- Names of the database services provided by the database
- Name of the database instance associated with the services and its current and maximum load
- Service handlers (dispatchers and dedicated servers) available for the instance, including their type, protocol addresses, and current and maximum load

The preceding information enables the listener to direct a client request appropriately.

The following figure shows two database instances registering information with two listeners. The figure does not represent all the information that can be registered. For example, listening endpoints, such as the port numbers, can be dynamically registered with the listener.

**Figure 5-2 Service Registration**

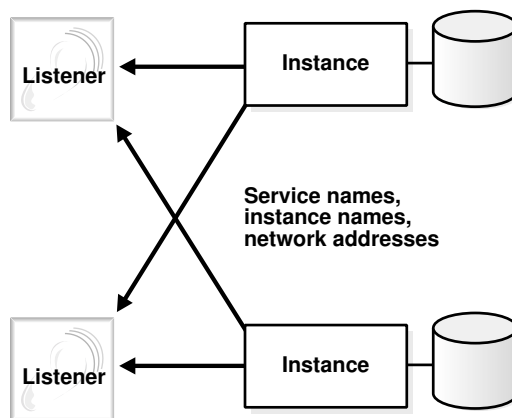

If the listener is not running when an instance starts, then the LREG process cannot register the service information. LREG attempts to connect to the listener periodically, but it may take up to 60 seconds before LREG registers with the listener after it has been started. To initiate service registration immediately after the listener is started, use the SQL statement `ALTER SYSTEM REGISTER`. This statement is especially useful in high availability configurations.

## 5.2 About the Listener and Connection Requests

Each listener is configured with one or more protocol addresses that specify its listening endpoints. The protocol address defines the protocol the listener listens on and any other protocol-specific information. For example, the listener could be configured to listen at the following protocol address:

```
(DESCRIPTION=
  (ADDRESS=(PROTOCOL=tcp)(HOST=sales-server)(PORT=1521)))
```

The preceding example shows a TCP/IP address that specifies the host of the listener (`sales-server`) and a port number (1521).

Clients configured with a protocol address can send connection requests to the listener. When a client request reaches the listener, it selects an appropriate service handler to service the request and forwards the request to the handler. A service handler is a dispatcher or a dedicated server process that acts as a connection point to a database.



The following figure illustrates the role of the listener during the establishment of a connection. The figure shows a browser making an HTTP connection and a client making a database connection.

1. The browser or client send a connection request to the listener.
2. The listener parses the request and forwards it to the service handler for the database service requested.
3. The browser or client connect to the database.

**Figure 5-3 Listener Architecture**

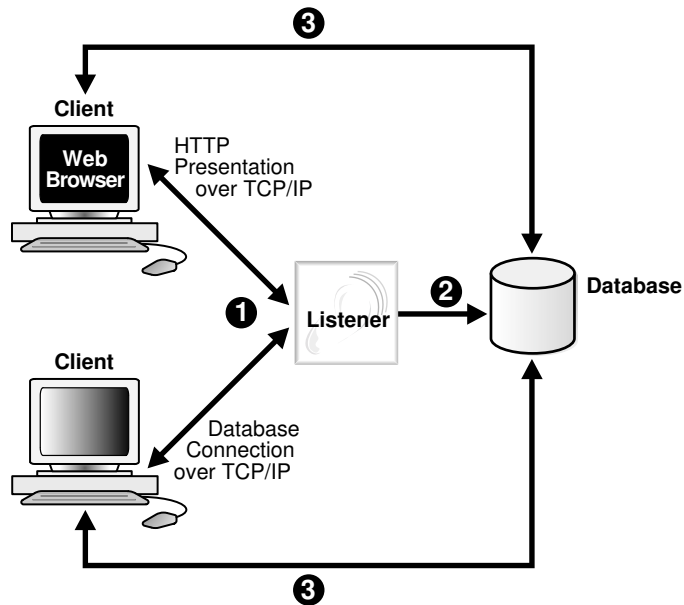

## 5.3 About Oracle Restart

Oracle Restart enhances the availability of Oracle databases in a single-instance environment. Using the Server Control (SRVCTL) utility, you can add components such as the listener to an Oracle Restart configuration. The configuration enables the listener to start automatically when the listener fails or is not running.

When using Oracle Restart, note the following:

- Use the SRVCTL utility to start and stop the listener. Do not use the listener control utility LSNRCTL.
- Each listener must have a unique name.

### See Also:

- ["Managing a Listener in an Oracle Restart Configuration"](#)
- *Oracle Database Administrator's Guide* to learn how to configure Oracle Restart

## 5.4 About Blocked Connection Requests

Blocked connection requests can occur when an incoming request occurs before the respective instance has been registered, or when a database is in restricted mode, such as when a shutdown of the database is in progress. If a database instance is in restricted mode, then LREG instructs the listener to block all connections to the instance. Clients attempting to connect receive one of the following errors:

- ORA-12526: TNS:listener: all appropriate instances are in restricted mode
- ORA-12527: TNS:listener: all appropriate instances are in restricted mode or blocking new connections
- ORA-12528: TNS:listener: all appropriate instances are blocking new connections

The ORA-12528 error occurs when a database instance is not yet registered with the listener.

### See Also:

- *Oracle Database Error Messages* for information about these error messages
- *Oracle Database SQL Reference* for information about the `ALTER SYSTEM REGISTER` statement
- *Oracle XML DB Developer's Guide* for information about dynamically registering HTTP, FTP, and WebDAV listening endpoints

## 5.5 Understanding Database Server Process Architecture

Based on the service handler type registered with the listener, the listener forwards requests to either a shared server or dedicated server process. The shared server architecture enables a database server to allow many client processes to share server processes. In a dedicated server configuration, the listener starts a separate dedicated server process for each incoming client connection request dedicated to servicing the client.

- [About Shared Server Processes](#)
- [About Dedicated Server Processes](#)

### 5.5.1 About Shared Server Processes

Shared server processes are used in the shared server architecture, as shown in [Figure 5-4](#). With shared server architectures, client processes ultimately connect to a dispatcher. The LREG process registers the location and load of the dispatchers with the listener, enabling the listener to forward requests to the least loaded dispatcher. This registration process is not shown in the figure.

A dispatcher can support multiple client connections concurrently. Each client connection is bound to a virtual circuit. A virtual circuit is a piece of shared memory

used by the dispatcher for client database connection requests and replies. The dispatcher places a virtual circuit on a common request queue when a request arrives. An idle shared server picks up the virtual circuit from the request queue, services the request, and relinquishes the virtual circuit before attempting to retrieve another virtual circuit from the request queue. Shared servers place all completed requests into a dispatcher's response queue in the SGA (System Global Area). This approach enables a small pool of server processes to serve a large number of clients.

Figure 5-4 Shared Server Architecture

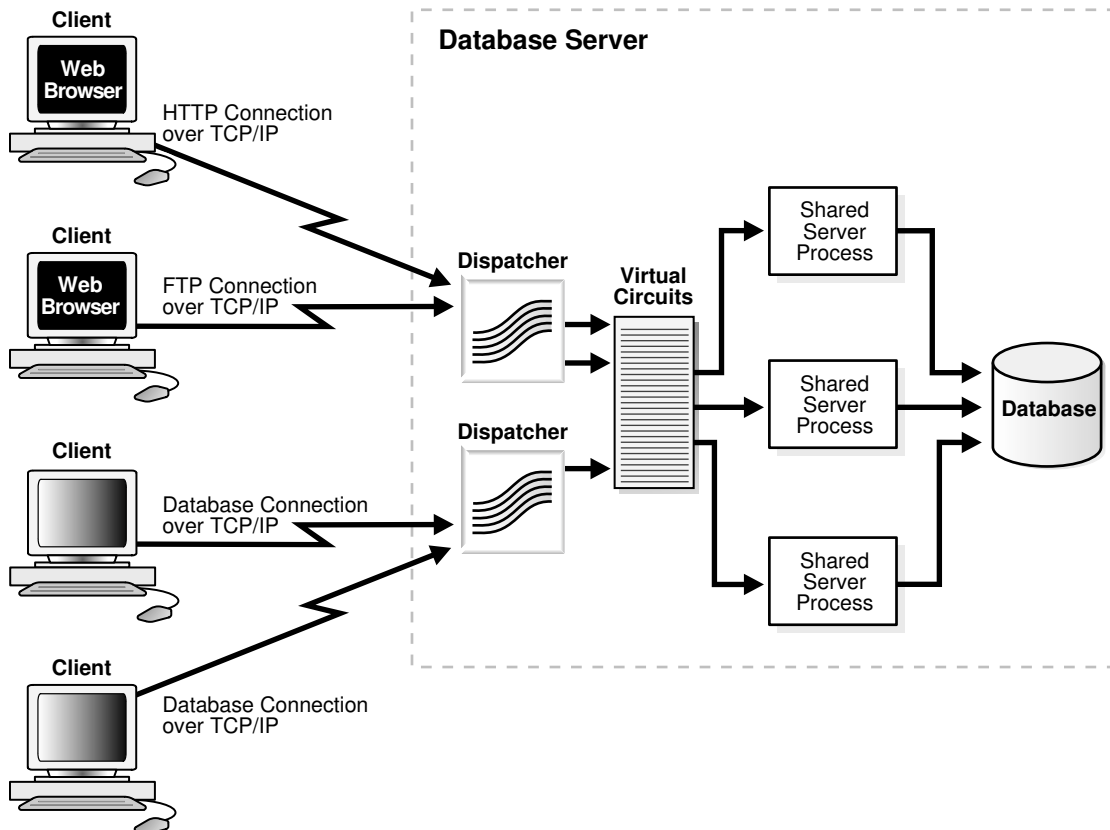

## 5.5.2 About Dedicated Server Processes

In a dedicated server architecture, each client process connects to a dedicated server process. The server process is not shared by any other client. [Figure 5-5](#) illustrates a dedicated server architecture.

LREG registers information about dedicated server processes with the listener. This enables the listener to start a dedicated server process when a client request arrives and forward the request to it.



**Note:**

Dedicated server architectures do not support HTTP, FTP, or WebDAV clients. Only database clients are supported.

**Figure 5-5 Dedicated Server Architecture**

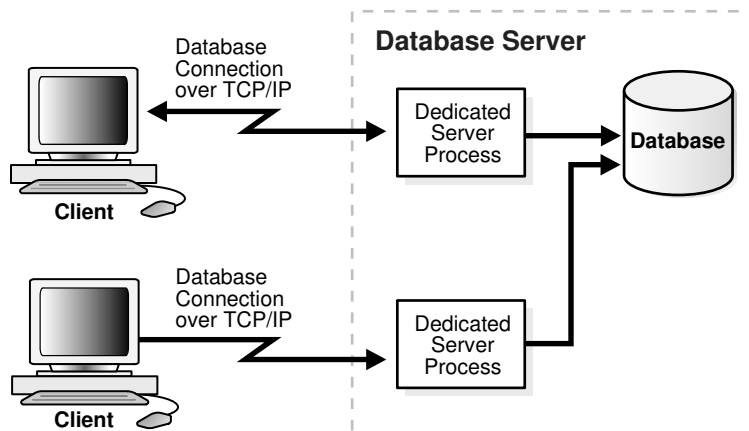

## 5.6 Understanding Oracle Connection Manager Architecture

Oracle Connection Manager is a gateway through which client connection requests are sent either to the next hop or directly to the database server. Clients who relay connection requests through an Oracle Connection Manager can take advantage of the session multiplexing and access control features configured on Oracle Connection Manager. It carries no service information until a LREG process registers its services.

Oracle Connection Manager consists of three components:

- listener
- CMGW (Oracle Connection Manager Gateway)
- CMADMIN (Oracle Connection Manager Administration)

The listener receives client connections and evaluates against a set of rules whether to deny or allow access. If it allows access, then the listener forwards a request to a gateway process, selecting the one with the fewest connections. The CMGW process, in turn, forwards the request to another Oracle Connection Manager or directly to the database server, relaying data until the connection terminates. If a connection to the server already exists, then the gateway multiplexes, or funnels, its connections through the existing connection. CMADMIN monitors the state of the gateway processes and the listener, shutting down or starting up processes as needed. In addition, it registers the location and load of the gateway processes with the listener, and it answers requests from the Oracle Connection Manager Control utility.

In the following figure, the listener screens connection requests. A gateway process registers with the CMADMIN process, and the CMADMIN process registers with the listener. Finally, the listener forwards the connection requests to the gateway process. After receiving the three valid client connections, the gateway process multiplexes

them through a single network protocol connection to the database. The fourth connection is denied when it is evaluated against the set of rules.

**Figure 5-6 Oracle Connection Manager Architecture**

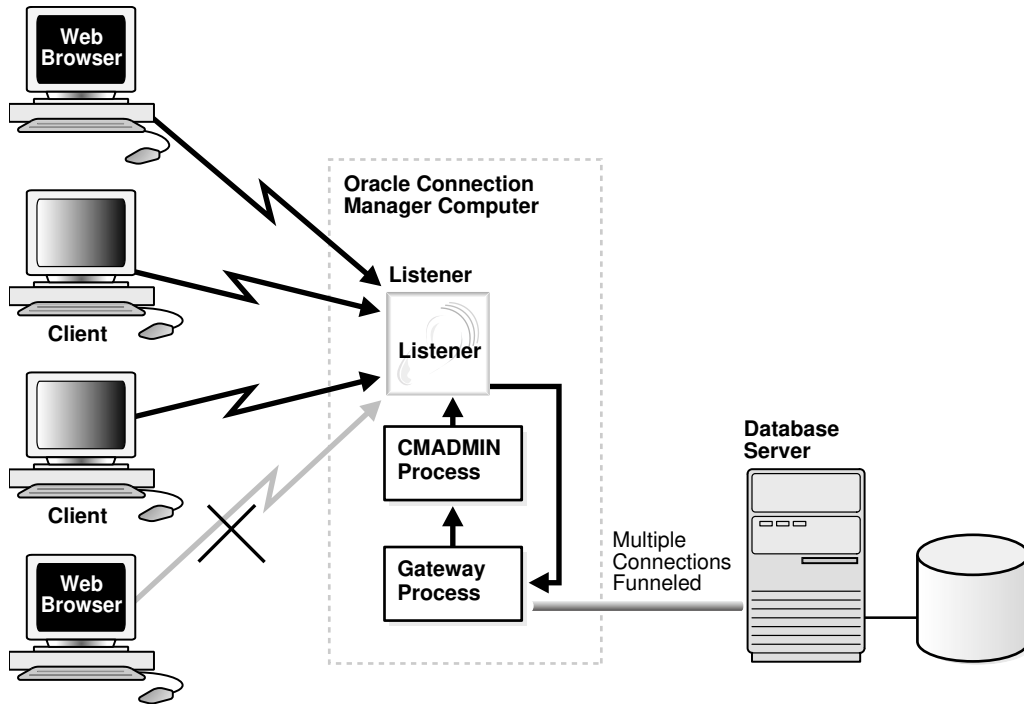

## 5.7 Complete Architecture

Oracle Net provides an architectural solution that allows for greater scalability in Internet and intranet environments.

Figure 5-7 shows how multiple connections to an Oracle database server are made more scalable with Oracle Connection Manager and a shared server architecture. Oracle Connection Manager is used to offload some of the network I/O of the application web servers, and a shared server is used to serve more concurrent users.

Figure 5-7 Scalable Architectural Solutions

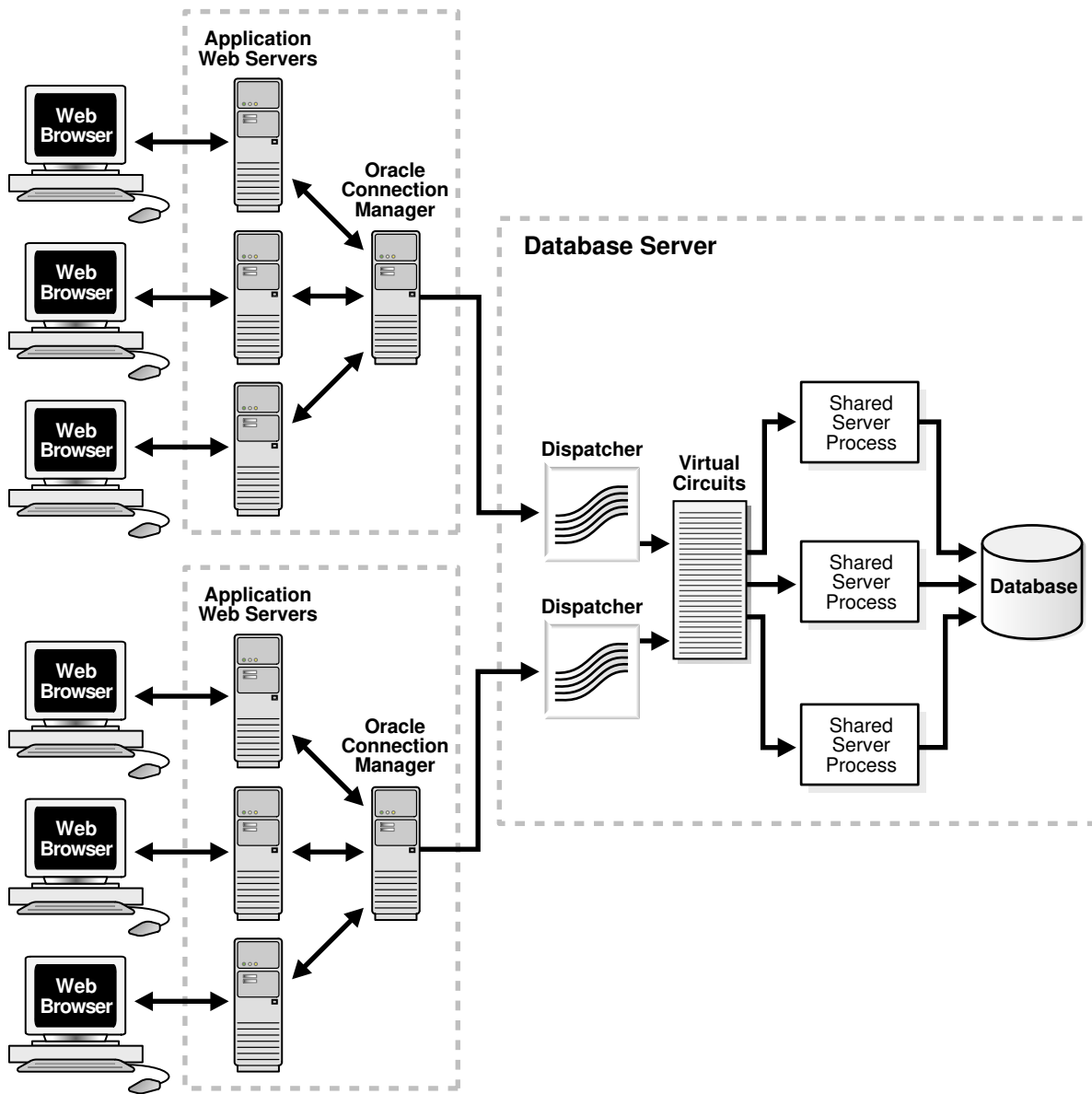

# Part II

## Configuration and Administration of Oracle Net Services

Part II describes how to set up and configure Oracle Net Services.

This part contains the following chapters:

- [Quick Start to Oracle Net Services](#)
- [Managing Oracle Net Services](#)
- [Configuring Naming Methods](#)
- [Configuring and Administering Oracle Net Listener](#)
- [Configuring and Administering Oracle Connection Manager](#)
- [Configuring a Shared Server Architecture](#)  
You can manage server loads on Oracle Database by managing dispatchers, and configuring your clients to take advantages of Oracle Net Services features.
- [Configuring Profiles](#)
- [Enabling Advanced Features of Oracle Net Services](#)
- [Optimizing Performance](#)

# 6

## Quick Start to Oracle Net Services

Help novice users set up and test a simple but common network configuration, such as one between a client application and a database over a TCP/IP network.

- [Prerequisites for Establishing Connectivity](#)
- [Confirming Network Availability](#)
- [Starting Oracle Net Listener and the Oracle Database Server](#)
- [Starting Oracle Connection Manager](#)
- [Connecting to the Database](#)
- [Using Easy Connect to Connect to a Database](#)

### 6.1 Prerequisites for Establishing Connectivity

The tasks in this chapter show a TCP/IP connection between a database server and a client computer. The following conditions are assumed about the database server and client computer:

- Database server
  - The server is running on a network that can access the client
  - An Oracle database is installed
  - A listener is configured
  - TCP/IP protocol support is installed
- Client computer
  - The client computer is running on a network that can access the database server
  - Oracle Client is installed
  - TCP/IP protocol support is installed

In a TCP/IP network, each computer has a unique IP address. A name resolution service, such as Domain Name System (DNS), can be used to map the IP address of a computer with its host name. If a name resolution service is not used, then the mapping is typically stored in a centrally maintained file called `hosts`. This file is located in the `/etc` directory on Linux and the `\windows\system32\drivers\etc` directory on Microsoft Windows. For example, an entry for a database server computer named `sales-server` may look like the following:

```
#IP address of server      host name      alias
192.0.2.203              sales-server   sales.us.example.com
```



## 6.2 Confirming Network Availability

Before using Oracle Net to connect a client computer to a database server, confirm that the client computer can successfully communicate with the database server computer. Evaluating network connectivity can eliminate network-based errors.

The following procedure describes how to confirm network connectivity:

1. Confirm that the database server computer can communicate with itself with a loopback test as follows:

- a. To confirm hardware connectivity, enter the following command at the command line:

```
ping ip_address
```

In the preceding command, *ip\_address* is the IP address of the database server computer, such as the following:

```
ping 192.0.2.203
```

- b. To confirm the DNS or host name is configured properly, enter the following command at the command line:

```
ping host_name
```

In the preceding command, *host\_name* is the host name of the server.

- c. To test the TCP/IP setup for the server, enter the following command:

```
ping 127.0.0.1
```

```
ping6 ::1
```

The IP address 127.0.0.1 is the standard IPv4 address for a loopback test. The IP address ::1 (0: 0: 0: 0: 0: 0: 0: 1) is the standard IPv6 address for a loopback test.

2. Verify the client computer can successfully communicate with the database server computer.

The method for verification varies according to the network protocol. For TCP/IP, you can use PING, FTP or TELNET utilities.

If the client computer cannot reach the server, then verify that the network cabling and network interface cards are correctly connected. Contact your network administrator to correct these problems.

## 6.3 Starting Oracle Net Listener and the Oracle Database Server

Oracle Net Listener and the Oracle Database server must be running in order for the database server to receive connections. The following procedure describes how to start Oracle Net Listener:

1. Start the listener with the Listener Control utility. From the command line, enter the following:

```
lsnrctl  
LSNRCTL> START [listener_name]
```

In the preceding command, *listener\_name* is the name of the listener defined in the `listener.ora` file. It is not necessary to identify the listener if you are using the default name `LISTENER`.

A status message indicating that the listener has successfully started displays.

2. Start the database as follows:

- a. Start SQL\*Plus without connecting to the database using the following command:

```
SQLPLUS /nolog
```

- b. Connect to the database as `SYSDBA` using the following command:

```
SQL> CONNECT username as sysdba
```

You will be prompted to enter a password.

 **Note:**

For simplicity, this example does not perform the password management techniques that a deployed system normally uses. In a production environment, follow the Oracle Database password management guidelines, and disable any sample accounts. See *Oracle Database Security Guide* for password management guidelines and other security recommendations.

- c. Start the database using the following command:

```
SQL> STARTUP database_name
```

In the preceding command, *database\_name* is the name of the database.

 **See Also:**

*Oracle Database Administrator's Guide* for additional information about starting the database

3. Confirm that database service registration with the listener has completed using the Listener Control utility and the following command:

```
LSNRCTL> SERVICES [listener_name]
```

The `SERVICES` command lists the services supported by the database, along with at least one available service handler. If the database service registration is not listed, then enter the following SQL command:

```
SQL> ALTER SYSTEM REGISTER;
```

 **See Also:**

"[Monitoring Services of a Listener](#)" for additional information about the `SERVICES` command

## 6.4 Starting Oracle Connection Manager

If Oracle Connection Manager is installed, then start Oracle Connection Manager as follows:

1. Start the Oracle Connection Manager Control utility (CMCTL) using the following commands:

```
cmctl  
CMCTL> ADMINISTER [instance_name]
```

In the preceding command, *instance\_name* is the name of Oracle Connection Manager to administer. You can determine the name by viewing the `cmn.ora` file. The file is located on the Oracle Connection Manager computer in the `ORACLE_BASE_HOME/network/admin` directory by default.

Oracle Connection Manager displays a status message indicating the name of the instance, and informs you that the instance has not yet been started.

 **Note:**

If you do not provide an instance name as an argument, then provide Oracle Connection Manager with a fully qualified host name. This is the default. After you issue the `ADMINISTER` command, CMCTL displays the instance name as follows:

```
CMAN_fully_qualified_host_name
```

2. Start Oracle Connection Manager that you have chosen to administer using the following command:

```
cmctl> STARTUP
```

Oracle Connection Manager confirms that the instance has been started, and provides status for the instance.

3. Exit from the Oracle Connection Manager Control utility using the following command:

```
cmctl> EXIT
```

On Microsoft Windows, you can start Oracle Connection Manager through the Control Panel, as follows:

1. Select **Services** in the Control Panel.
2. Select the OracleHOME\_NAMECMan service, and then click **Start**.
3. In the Services window, click **Close**.

## 6.5 Connecting to the Database

There are several methods to connect to an Oracle database. [Table 6-1](#) lists syntax to connect to a database.

**Table 6-1 Connecting to a Database**

Type of Connection	Connection Syntax	Description
From the command line	<p>The general form of connecting an application to a database server from the command line is:</p> <pre>tool username@connect_identifier</pre> <p>You will be prompted to enter your password which will be encrypted.</p> <p>For example:</p> <pre>SQLPLUS system@sales Enter password: password</pre>	Most Oracle tools can use the operating system command line to connect, and some provide alternatives.
From a login screen	<pre>username@connect_identifier</pre>	Some tools provide a login screen as an alternative form to log in. A user can log in to a database server by identifying both the user name and connect identifier in the user name field of the tool login screen, and entering the password in the password field.
From a 3GL application	<pre>exec sql connect :username identified by :password</pre> <p>In the preceding connection request, <i>:username</i> and <i>:password</i> are 3GL variables that can be set within the program either statically or by prompting the user. When connecting to a database server, the value of the <i>:username</i> variable is in the form:</p> <pre>username@net_service_name</pre> <p>The <i>:password</i> variable contains the password for the database account to which you are connecting.</p>	Applications written in 3GL, such as OCI and pre-compilers, are used by middle-tier and database application developers for direct database access from a client program.

Table 6-1 (Cont.) Connecting to a Database

Type of Connection	Connection Syntax	Description
From within SQL*Plus	<pre>SQLPLUS /nolog SQL&gt; CONNECT username@net_service_name</pre> <p>For example:</p> <pre>SQLPLUS /nolog SQL&gt; CONNECT scott@serverx Enter password: password</pre> <p>In the preceding commands, <i>username</i> and <i>password</i> are the database user and password, and <i>net_service_name</i> is the network service name.</p>	<p>Some Oracle tools have commands for database connections to allow an alternative user name to be specified without leaving the tool.</p> <p>Other Oracle tools use slightly different methods specific to their function or interface. For example, Oracle CDE tools use login buttons with fields for the user name, password, and remote database ID.</p>

## 6.6 Using Easy Connect to Connect to a Database

After network connectivity has been verified as described in "[Confirming Network Availability](#)", you can use the Easy Connect naming method to connect to the database. This naming method provides out-of-the-box TCP/IP connectivity to databases. It extends the functionality of the host naming method by enabling clients to connect to a database server with an optional port and service name in addition to the host name of the database. The following is the syntax to connect using Easy Connect:

```
CONNECT username/password@host[:port][/:service_name][:server_type][/:instance_name]
```



### Note:

In Oracle Call Interface documentation, *server* is referred to as *connect\_type*.

If Oracle Database server installation was performed in Typical mode, then the default service name used by the Oracle instance is the database name, and the following Easy Connect syntax can be used to connect to that instance:

```
SQLPLUS /nolog
SQL> CONNECT username@"host/db_name"
SQL> Enter password: password
```

 **Note:**

As of Oracle Database 10g, Oracle Database does not support the use of Oracle Names. Oracle Database 12c clients and databases cannot use Oracle Names, including those from an LDAP proxy, to resolve naming. Oracle9i clients can still use Oracle Names to resolve naming for an Oracle Database 12c database. However, customers are strongly encouraged to migrate to LDAP to take advantage of the new features of Oracle Database 12c.

 **See Also:**

["Understanding the Easy Connect Naming Method"](#) for additional information about this method

# 7

## Managing Oracle Net Services

Know about the various administration tools of Oracle Net Services. This involves the main administration applications, Oracle Enterprise Manager Cloud Control and Oracle Net Manager. Also, know about the command-line control utilities.

- [Using the User Interface Tools](#)
- [About the OracleNetAdmins Group](#)
- [Using Listener Control Utility to Administer the Listener](#)
- [Performing Common Network Tasks](#)

### 7.1 Using the User Interface Tools

Oracle Net Services provides tools to help you perform configuration and administrative tasks.

- [Using Oracle Enterprise Manager Cloud Control to Configure Oracle Net Services](#)
- [Using Oracle Net Manager to Configure Oracle Net Services](#)
- [Deciding When to Use Oracle Enterprise Manager Cloud Control and Oracle Net Manager](#)
- [Using Oracle Net Configuration Assistant to Configure Network Components](#)

#### 7.1.1 Using Oracle Enterprise Manager Cloud Control to Configure Oracle Net Services

Oracle Enterprise Manager Cloud Control enables you to configure Oracle Net Services for any Oracle home across multiple file systems. It also provides common administration functions for listeners. Oracle Enterprise Manager Cloud Control provides an integrated environment for configuring and managing Oracle Net Services.

You can use Oracle Enterprise Manager Cloud Control to configure and administer the following from multiple Oracle homes:

- Listeners: Configure listeners to receive client connections.
- Naming: Define connect identifiers and map them to connect descriptors to identify the network location of a service. Oracle Net Manager supports configuration of connect descriptors in local `tnsnames.ora` files or a centralized directory service.
- File location: Specify the file location of the Oracle Net configuration files.
- [Accessing the Net Services Administration Page](#)



### See Also:

Oracle Enterprise Manager Cloud Control documentation set and online help for information about using Oracle Enterprise Manager Cloud Control

## 7.1.1.1 Accessing the Net Services Administration Page

The following procedure describes how to access the Net Services Administration page using Oracle Enterprise Manager Cloud Control:

1. From the Login to Database page, enter the database credentials, and then click **Login**.

The Select Enterprise Manager Home page appears.

2. Select **All Targets** from the Targets menu.
3. Select **Listener** from the Refine Search list.
4. Select the listener by double-clicking on the listener name.
5. Select **Net Services Administration** from the Oracle Listener menu.

The Net Services Administration page appears.

From the Net Services Administration page, you can administer the listeners, naming methods, preferences, and so on. The administration procedures are described in other chapters of this book.

## 7.1.2 Using Oracle Net Manager to Configure Oracle Net Services

Oracle Net Manager enables you to configure Oracle Net Services for an Oracle home on a local client or server host.

You can use Oracle Net Manager to configure the following network components:

- **Listeners:** Create and configure listeners to receive client connections.
- **Naming:** Define connect identifiers and map them to connect descriptors to identify the network location and identification of a service. Oracle Net Manager supports configuration of connect descriptors in local `tnsnames.ora` files or a centralized directory service.
- **Naming methods:** Configure the ways connect identifiers are resolved to connect descriptors.
- **Profiles:** Configure preferences for enabling and configuring Oracle Net features on the client or server.

This section introduces the features of Oracle Net Manager. However, the primary documentation for using Oracle Net Manager is online help.

- [Starting Oracle Net Manager](#)
- [Navigating Oracle Net Manager](#)
- [Using Oracle Net Manager Wizards](#)



### 7.1.2.1 Starting Oracle Net Manager

To start Oracle Net Manager, do the following

- On Linux, run `netmgr` from the `ORACLE_HOME/bin` directory.
- On Microsoft Windows, select **Programs** from the Start menu, and then select **Oracle - HOME\_NAME**. Next, select **Configuration and Migration Tools**, and then **Net Manager**.

### 7.1.2.2 Navigating Oracle Net Manager

The Oracle Net Manager interface includes a toolbar and menu options, as well as property sheets for configuring network components.

The navigator pane provides a tree view of network objects and the objects they contain, organized in a folder hierarchy. You can expand and collapse the folders to monitor or manage objects such as connect identifiers, listeners, and profiles. Click an object to make changes to it.

The following are the main folders in the navigator pane:

- **Local**  
Displays networking elements configured in local configuration files:
  - Net service names in the `tnsnames.ora` file
  - Listeners in the `listener.ora` file
  - Profile in the `sqlnet.ora` file
- **Directory**  
Displays connect identifiers configured in a directory server

### 7.1.2.3 Using Oracle Net Manager Wizards

The Oracle Net Manager wizards provide step-by-step guidance for tasks. The wizards simplify complex tasks by guiding you through the tasks in manageable steps. The wizards are not intended to provide all configuration options. After you have completed a task with a wizard, use the other components of Oracle Net Manager to modify the configuration.

- [Using the Net Service Name Wizard](#)
- [Using the Directory Server Migration Wizard](#)

#### 7.1.2.3.1 Using the Net Service Name Wizard

The Net Service Name wizard guides you through creating a basic network service name in a directory server or a `tnsnames.ora` file.

The following procedure describes how to start the Net Service Name wizard to create network service names:

1. In the navigator pane, select **Directory** or **Local**, and then select **Service Naming**.
2. Click the plus sign (+) on the toolbar, or select **Create** from the Edit menu.

 **See Also:**

Oracle Net Manager online help for detailed information about using the Net Service Name wizard to create a network service name

### 7.1.2.3.2 Using the Directory Server Migration Wizard

If a `tnsnames.ora` file already exists, then its network service names can be exported to a directory server with the Directory Server Migration wizard.

The following procedure describes how to use the Directory Server Migration wizard:

1. Select **Directory** from the Command menu.
2. Select **Export Net Service Names** from the Oracle Net Manager menu.

 **See Also:**

["Exporting Local Naming Entries to a Directory Naming Server"](#)

## 7.1.3 Deciding When to Use Oracle Enterprise Manager Cloud Control and Oracle Net Manager

Much of the functionality previously available only in Oracle Net Manager has been integrated with Oracle Enterprise Manager Cloud Control. Oracle Enterprise Manager Cloud Control provides the ability to manage configuration for multiple Oracle homes across multiple file systems. Oracle Net Manager only enables you to manage configuration for one Oracle home on a local host computer. The following are the key differences between the tools.

Oracle Enterprise Manager Cloud Control

- Configure the following features:
  - Local naming (`tnsnames.ora` files)
  - Directory naming
  - Listeners
- Provide Oracle home support across multiple file system
- Provide the ability to search and sort local and directory naming entries
- Export directory naming entries to a `tnsnames.ora` file
- Perform the following administrative tasks for a selected listener:
  - Show current status
  - Change status
  - Change tracing level settings

- Change logging settings
- Set connect-time failover and load balancing methods when there is more than one listener

#### Oracle Net Manager

- Configure the following features:
  - Local naming (`tnsnames.ora` files)
  - Directory naming
  - Listeners
  - Profiles
- Provide Oracle home support for single host
- Set connect-time failover and load balancing methods when there is more than one listener
- Set the following options for clients and servers:
  - Tracing settings
  - Logging settings
  - Security, authentication and access rights
  - Routing

#### Note:

When Automatic Diagnostic Repository (ADR) is enabled, any changes to the tracing and logging settings using Oracle Enterprise Manager Cloud Control are ignored by the system.

## 7.1.4 Using Oracle Net Configuration Assistant to Configure Network Components

Oracle Net Configuration Assistant configures basic network components during installation, including:

- Listener names and protocol addresses
- Naming methods the client uses to resolve connect identifiers to connect descriptors
- Net service names in a `tnsnames.ora` file
- Directory server usage

Oracle Net Configuration Assistant runs automatically during software installation, as described in the Oracle Database installation guide. It can also be run after installation in standalone mode to configure naming methods, the listener, network service names in the `tnsnames.ora` file, and directory server usage.

To start Oracle Net Configuration Assistant do the following:

- On Linux and UNIX, run `netca` from the `ORACLE_HOME/bin` directory.

- On Microsoft Windows, select **Programs** from the Start menu, and then select **Oracle - HOME\_NAME**. Next, select **Configuration and Migration Tools**, and then **Oracle Net Configuration Assistant**.

 **See Also:**

- Oracle Net Configuration Assistant online help
- *Oracle Grid Infrastructure Installation Guide* for information on running Oracle Net Configuration Assistant in silent mode

The following are the configuration options on the Oracle Net Configuration Assistant Welcome page:

- Listener configuration – Create, modify, delete, or rename a listener.
- Naming Methods configuration – Configure the computer to resolve connect identifiers to connect descriptor with one or more of following naming methods:
  - Local naming
  - Directory naming
  - Easy Connect naming
  - External naming
- Local Net Service Name configuration
  - Create, modify, delete, rename, or test connectivity of a connect descriptor stored in a local `tnsnames.ora` file
- Directory Usage Configuration – Configure a directory server for directory-enabled features.

## 7.2 About the OracleNetAdmins Group

To use Oracle Net Manager, you must be a member of the `OracleNetAdmins` group or the `OracleContextAdmins` group. Oracle Net Configuration Assistant establishes these access rights for these groups during Oracle Context creation.

- [Adding Users To the OracleNetAdmins Group](#)
- [Removing Users From the OracleNetAdmins Group](#)
- [Changing Ownership of the OracleNetAdmins Group](#)

### 7.2.1 Adding Users To the OracleNetAdmins Group

The following procedure describes how to add a user to the `OracleNetAdmins` group using the `ldapmodify` command:

1. Create an Lightweight Directory Interchange Format (LDIF) file that specifies that you want to add a user to the `OracleNetAdmins` group.

You can use the following sample LDIF file. Use the appropriate DN for `cn=OracleNetAdmins` and the user that you want to add.

```
dn: cn=OracleNetAdmins,cn=OracleContext,...
changetype: modify
add: uniquemember
uniquemember: DN of user being added to group
```

2. Enter the following command at the command line to refresh the file:

```
$ ldapmodify -h directory_host -p port -D binddn -q -f ldif_file
```

In the preceding command, *directory\_host* is the directory server host, *port* is the listening TCP/IP port for the directory server, *binddn* is the directory administrator or user DN, and *ldif\_file* is the input file name. If the port is not specified, then the default port of 389 is used. The `-q` option prompts for a single bind password.

## 7.2.2 Removing Users From the OracleNetAdmins Group

The following procedure describes how to remove a user from the OracleNetAdmins group with the `ldapmodify` command:

1. Create an LDIF file that specifies that you want to delete a user to the OracleNetAdmins group.

You can use the following sample LDIF file. Enter the appropriate DN for `cn=OracleNetAdmins` and the user that you want to delete.

```
dn: cn=OracleNetAdmins,cn=OracleContext,...
changetype: modify
delete: uniquemember
uniquemember: DN of user being deleted from group
```

2. Enter the following command to delete the user:

```
$ ldapmodify -h directory_host -p port -D binddn -q -f ldif_file
```

In the preceding command, *directory\_host* is the directory server host, *port* is the listening TCP/IP port for the directory server, *binddn* is the directory administrator or user DN, and *ldif\_file* is the input file name. If the port is not specified, then the default port of 389 is used. The `-q` option prompts for a single bind password.

## 7.2.3 Changing Ownership of the OracleNetAdmins Group

The following procedure describes how to add a group as an owner of an OracleNetAdmins group:

1. Create an LDIF file, as follows:
  - a. Specify the group you want to add as an owner.

You can use the following sample LDIF file. Enter the appropriate DN for `cn=OracleNetAdmins` and the DN of the group that you want to add.

```
dn: cn=OracleNetAdmins,cn=OracleContext,...
changetype: modify
add: owner
owner: DN of group to add
```

For example, the following LDIF syntax changes the ownership from the OracleNetAdmins group to another group named `ExampleSecurityAdmins`. The group can be either inside or outside Oracle Context.

```
dn: cn=OracleNetAdmins,cn=OracleContext,...
changetype: modify
add: owner
owner: cn=ExampleSecurityAdmins
```

- b.** (Optional) Specify the group to delete as an owner.

```
dn: cn=OracleNetAdmins,cn=OracleContext,...
changetype: modify
delete: owner
owner: DN of group to delete
```

- 2.** Enter the following command at the command line to refresh the file:

```
$ ldapmodify -h directory_host -p port -D binddn -q -f ldif_file
```

In the preceding command, *directory\_host* is the directory server host, *port* is the listening TCP/IP port for the directory server, *binddn* is the directory administrator or user DN, and *ldif\_file* is the input file name. If the port is not specified, then the default port of 389 is used. The `-q` option prompts for a single bind password to be entered.

## 7.3 Using Listener Control Utility to Administer the Listener

Oracle Net Services provides tools to help you start, stop, configure, and control each network component. The Listener Control utility enables you to administer the listener. The utility is started by the user that owns the Oracle installation, or a member of the designated group, on the same machine where the listener is running. The basic syntax for this utility is as follows:

```
lsnrctl command [listener_name]
```

For example, the following command starts a listener named `lsnr`:

```
lsnrctl START lsnr
```

You can also issue Listener Control utility commands at the `LSNRCTL>` program prompt. To obtain the prompt, enter `lsnrctl` with no arguments at the operating system command line. When you run `lsnrctl`, the utility is started, and you can enter the necessary commands from the program prompt.

For example:

```
lsnrctl
LSNRCTL> START lsnr
```

### See Also:

- ["Customizing Oracle Net Listener Configuration"](#) for additional information about the listener
- *Oracle Database Net Services Reference* for additional information about the Listener Control utility

## 7.4 Performing Common Network Tasks

Network configuration and administration tasks are described throughout this guide.

### Configuring Directory Server for Oracle Net Usage

The following are the tasks for configuring directory server for Oracle Net:

- Configuring directory server usage.

Tool used to perform the task – Oracle Internet Directory Configuration Assistant

 **See Also:**

*Oracle Fusion Middleware Administrator's Guide for Oracle Internet Directory*

- Add users to the OracleNetAdmins group.

Tool used to perform the task – `ldapmodify`

 **See Also:**

["Who Can Add or Modify Entries in the Directory Server"](#)

- Authenticate with the directory.

Tools used to perform the task – Oracle Enterprise Manager Cloud Control, Oracle Net Manager

 **See Also:**

- Online help in Oracle Enterprise Manager Cloud Control
- *Oracle Database Enterprise User Security Administrator's Guide*

- Change Oracle Context.

Tool used to perform the task – Oracle Net Manager

 **See Also:**

Online help in Oracle Net Manager

### Configuring Naming Methods

The following are the tasks for configuring naming methods:

- Configure the local naming method.

Tool used to perform the task – Oracle Enterprise Manager Cloud Control, Oracle Net Manager, Oracle Net Configuration Assistant

 **See Also:**

["Configuring the Local Naming Method"](#)

- Configure the directory naming method.

Tool used to perform the task – Oracle Enterprise Manager Cloud Control, Oracle Net Manager

 **See Also:**

["Configuring the Directory Naming Method"](#)

- Configure the Easy Connect naming method.

Tool used to perform the task – Oracle Net Manager

 **See Also:**

["Understanding the Easy Connect Naming Method"](#)

- Configure external naming methods.

Tool used to perform the task – Oracle Net Manager

 **See Also:**

["Configuring External Naming Methods"](#)

### Migrating to Directory Naming

The following is the task for migrating to directory naming:

Export from `tnsnames.ora` files.

Tools used to perform the task – Oracle Enterprise Manager Cloud Control, Oracle Net Manager

 **See Also:**

["Exporting Directory Naming Entries to a `tnsnames.ora` File"](#)

### Configuring Profiles

The following are the tasks for configuring profiles:

- Prioritize naming methods.

Tool used to perform the task – Oracle Net Manager, Oracle Net Configuration Assistant



 **See Also:**

["Prioritizing Naming Methods"](#)

- Configure a default domain that is automatically appended to any unqualified network service name.

Tool used to perform the task – Oracle Net Manager, Oracle Net Configuration Assistant

 **See Also:**

["About the Default Domain for Clients"](#)

- Route connection requests.

Tool used to perform the task – Oracle Net Manager, Oracle Net Configuration Assistant

 **See Also:**

["Routing Connection Requests to a Process"](#)

- Configure access control.

Tool used to perform the task – Oracle Net Manager

 **See Also:**

["Settings for Database Access Control"](#)

- Configure an authentication method.

Tool used to perform the task – Oracle Net Manager

 **See Also:**

["Configuring Oracle Network Security"](#)

- Configure connect request timeouts.

Tool used to perform the task – Manual configuration

 **See Also:**

["Limiting Resource Consumption by Unauthorized Users"](#)

### Configuring Listeners

The following are the tasks for configuring listeners:

- Configure listening protocol addresses.  
Tool used to perform the task – Oracle Enterprise Manager Cloud Control, Oracle Net Manager, Oracle Net Configuration Assistant

 **See Also:**  
["Configuring Listening Protocol Addresses"](#)

- Configure dynamic service registration.  
Tool used to perform the task – Automatic configuration

 **See Also:**  
["Configuring Dynamic Service Registration"](#)

- Configure static service registration.  
Tool used to perform the task – Oracle Enterprise Manager Cloud Control, Oracle Net Manager

 **See Also:**  
["Understanding Static Service Registration "](#)

- Configure connect request timeouts.  
Tool used to perform the task – Manual configuration

 **See Also:**  
["Limiting Resource Consumption by Unauthorized Users"](#)

### Administering Listeners

The following are the tasks for administering listeners:

- Start and stop listeners.  
Tool used to perform the task – Listener Control Utility

 **See Also:**  
["Starting and Stopping a Listener"](#)

- View registered information.  
Tool used to perform the task – Listener Control Utility



**See Also:**

["Monitoring Services of a Listener"](#)

### **Configuring Oracle Connection Manager**

The following are the tasks for configuring Oracle Connection Manager:

- Configure session multiplexing.

Tool used to perform the task – Manual configuration



**See Also:**

["Enabling Session Multiplexing for Oracle Connection Manager"](#)

- Configure access control.

Tool used to perform the task – Manual configuration



**See Also:**

["Enabling Access Control"](#)

# 8

## Configuring Naming Methods

Find out how to configure connectivity information for client connections to the database server.

- [Understanding the Easy Connect Naming Method](#)
- [Configuring the Local Naming Method](#)
- [Configuring the Directory Naming Method](#)
- [Creating Multiple Default Contexts in a Directory Naming Server](#)
- [Exporting Local Naming Entries to a Directory Naming Server](#)
- [Exporting Directory Naming Entries to a tnsnames.ora File](#)
- [Configuring External Naming Methods](#)



### See Also:

"[Understanding Naming Methods](#)" for an overview of naming methods

### 8.1 Understanding the Easy Connect Naming Method

The Easy Connect naming method eliminates the need for service name lookup in the `tnsnames.ora` files for TCP/IP environments. In fact, no naming or directory system is required when using this method.

This naming method provides out-of-the-box TCP/IP connectivity to databases. It extends the functionality of the host naming method by enabling clients to connect to a database server with an optional port and service name in addition to the host name of the database:

```
CONNECT username@[//]host[:port][//service_name][:server_type][//instance_name]
Enter password: password
```

The connect identifier converts to the following connect descriptor:

```
(DESCRIPTION=
  (ADDRESS=(PROTOCOL=tcp)(HOST=host)(PORT=port))
  (CONNECT_DATA=
    (SERVICE_NAME=service_name)
    (SERVER=server_type)
    (INSTANCE_NAME=instance_name)))
```

If the Oracle Database server installation was performed in Typical mode, then the default service name used by the Oracle instance is the database name, and the following Easy Connect syntax can be used to connect to that instance:

```
SQLPLUS /nolog
SQL> CONNECT username@host/db_name
SQL> Enter password: password
```

Table 8-1 lists the Easy Connect syntax elements and descriptions for each.

**Table 8-1 Connect Identifier for Easy Connection Naming Method**

Syntax Element	Description
//	<p>Use // to specify a URL or JDBC connection. Required for URL or JDBC connections. The connect identifier must be preceded by a double-slash (//). For example:</p> <pre>scott@//sales-server Enter password: password</pre> <p>Optional for SQL connections. The connect identifier can be preceded by a double-slash (//). For example, the following connect strings are semantically equivalent:</p> <pre>SQL&gt; CONNECT scott@sales-server SQL&gt; CONNECT scott@//sales-server</pre>
host	<p>Required. Specify the host name or IP address of the database host computer.</p> <p>The host name is domain-qualified if the local operating system configuration specifies a domain.</p> <p>You may use an IPv4 or IPv6 address as a value. IPv6 addresses or host names that resolve to IPv6 addresses must be enclosed in square brackets, as in [2001:0db8:0:0::200C:417A] and [salesdb].</p>
port	<p>Optional. Specify the listening port. The default is 1521.</p>
service_name	<p>Optional. Specify the service name of the database.</p> <p>If a user specifies a service name, then the listener connects the user to that specific database. Otherwise, the listener connects to the database specified by the DEFAULT_SERVICE_listener_name parameter in the listener.ora file. If DEFAULT_SERVICE_listener_name is not configured for the listener and a service name is not explicitly specified by the user as part of the Easy Connect syntax, then the listener returns an error.</p>
server_type	<p>Optional. Specify the database server type to use.</p> <p>This parameter instructs the listener to connect the client to a specific type of service handler.</p> <p>The values for the server_type parameter are dedicated, shared, and pooled. If server is not specified in the Easy Connect syntax, then the type of server is chosen by the listener (shared server if configured, otherwise a dedicated server is used).</p> <p><b>Note:</b> In Oracle Call Interface documentation, server is referred to as connect_type.</p>

**Table 8-1 (Cont.) Connect Identifier for Easy Connection Naming Method**

Syntax Element	Description
instance_name	Optional. Identify the database instance to access. The instance name can be obtained from the INSTANCE_NAME parameter in the initialization parameter file.

 **See Also:**

*Oracle Database Net Services Reference* for additional information about configuring the `DEFAULT_SERVICE_listener_name` parameter, and the `INSTANCE_NAME` initialization parameter

The connect strings in [Example 8-1](#) connect the client to database service `sales.us.example.com` with a listening endpoint of 1521 on database server `sales-server`.

**Example 8-1 Easy Connect Strings**

```
CONNECT scott@sales-server:1521/sales.us.example.com
CONNECT scott@//sales-server/sales.us.example.com
CONNECT scott@//sales-server.us.example.com/sales.us.example.com
```

After each of the connect strings in [Example 8-1](#), you must enter a password to connect to the database service.

The connect strings in [Example 8-1](#) convert into the following connect descriptor:

```
(DESCRIPTION=
  (ADDRESS=(PROTOCOL=tcp)(HOST=sales-server)(PORT=1521))
  (CONNECT_DATA=
    (SERVICE_NAME=sales.us.example.com)))
```

- [About Easy Connect Plus](#)  
Starting with Oracle Database 19c release, the Easy Connect syntax that applications use to connect to Oracle Database has improved functionality. The new version is called Easy Connect Plus.
- [Examples of Easy Connect Naming Method](#)
- [Configuring Easy Connect Naming on the Client](#)
- [Configuring Easy Connect Naming to Use a DNS Alias](#)

## 8.1.1 About Easy Connect Plus

Starting with Oracle Database 19c release, the Easy Connect syntax that applications use to connect to Oracle Database has improved functionality. The new version is called Easy Connect Plus.

Easy Connect Plus simplifies Oracle Database application configuration and deployment for common use cases. With Easy Connect Plus, you no longer need to configure Oracle Net parameter files such as `tnsnames.ora` and `sqlnet.ora`. Easy Connect Plus also no longer requires you to set the `TNS_ADMIN` environment variable.

The new functionality simplifies client configuration, as the client connections to Oracle Database Cloud Services use TLS for network security. The new syntax is as follows:

```
[[protocol:]]//host1{,host12}[:port1]{,host2:port2}[/service_name][:server]
[/instance_name][?parameter_name=value{&parameter_name=value}]
```

The question mark (?) indicates the start of name-value pairs and the ampersand (&) is the delimiter between the name-value pairs.

**Support for specifying protocol:** Easy Connect adaptor supports specification of protocol as part of the connect string. This protocol is applicable to each host in the connect string.

**Multihost or port support:** Easy Connect adaptor can now accept multiple hosts or ports in the connect string. This helps in load-balancing the client connections.

**Name-Value pairs:** Easy Connect adaptor can now accept a list of name value pairs. Each name-value pair will be added as a `DESCRIPTION` level parameter. The following names are supported:.

- ENABLE
- FAILOVER
- LOAD\_BALANCE
- RECV\_BUF\_SIZE
- SEND\_BUF\_SIZE
- SDU
- SOURCE\_ROUTE
- RETRY\_COUNT
- RETRY\_DELAY
- CONNECT\_TIMEOUT
- TRANSPORT\_CONNECT\_TIMEOUT

For example, the following syntax to specify the Session Data Unit (SDU)

```
salesserver1:1521/sales.us.example.com?sdu=16384
```

translates to the following connect descriptor:

```
(DESCRIPTION=
  (SDU=16384)
  (ADDRESS=(PROTOCOL=tcp)(HOST=salesserver1)(PORT=1521))
  (CONNECT_DATA=(SERVICE_NAME=sales.us.example.com)))
```

Similarly, the following syntax to specify connect timeout, transport connect timeout, and retry count values

```
salesserver1:1521/sales.us.example.com?
connect_timeout=60&transport_connect_timeout=30&retry_count=3
```

translates to the following connect descriptor:

```
(DESCRIPTION=
  (retry_count=3)
  (connect_timeout=60)(transport_connect_timeout=30)
  (ADDRESS=(PROTOCOL=tcp)(HOST=salesserver1)(PORT=1521))
  (CONNECT_DATA=(SERVICE_NAME=sales.us.example.com)))
```

**Security Attributes:** The following SECURITY attributes are supported for TLS:

- SSL\_SERVER\_DN\_MATCH=*on/off*
- SSL\_SERVER\_CERT\_DN=*longDN*
- WALLET\_LOCATION=*Wallet location*

## 8.1.2 Examples of Easy Connect Naming Method

Table 8-2 shows examples of Easy Connect naming syntax and how each string converts into a connect descriptor.

**Table 8-2 Examples of Easy Connect Naming**

Naming Option	Connect String	Connect Descriptor
Easy Connect string with host. The host name is sales-server.	sales-server	(DESCRIPTION= (CONNECT_DATA= (SERVICE_NAME=)) (ADDRESS= (PROTOCOL=TCP) (HOST=sales-server) (PORT=1521)))
Easy Connect string with host and port. The host name is sales-server, and the port is 3456.	sales-server:3456	(DESCRIPTION= (CONNECT_DATA= (SERVICE_NAME=)) (ADDRESS= (PROTOCOL=TCP) (HOST=sales-server) (PORT=3456)))
Easy Connect string with host and service name. The host name is sales-server and the service name is sales.	sales-server/sales	(DESCRIPTION= (CONNECT_DATA= (SERVICE_NAME=sales)) (ADDRESS= (PROTOCOL=TCP) (HOST=sales-server) (PORT=1521)))



**Table 8-2 (Cont.) Examples of Easy Connect Naming**

Naming Option	Connect String	Connect Descriptor
<p>Easy Connect string with IPv6 address. The IPv6 address of the host is 2001:0db8:0:0::200C:417A, the port is 80, and the service name is sales.</p>	<p>[2001:0db8:0:0::200C:417A]:80/sales</p> <p>Square brackets are required around IPv6 host names.</p>	<pre>(DESCRIPTION= (CONNECT_DATA= (SERVICE_NAME=sales) (ADDRESS= (PROTOCOL=TCP) (HOST=2001:0db8:0:0::200C:417A) (PORT=80)))</pre>
<p>Easy Connect string with IPv6 host address. The host is sales-server, the port is 80, and the service name is sales.</p>	<p>sales-server:80/sales</p>	<pre>(DESCRIPTION= (CONNECT_DATA= (SERVICE_NAME=sales) (ADDRESS= (PROTOCOL=TCP) (HOST=sales-server) (PORT=80)))</pre>
<p>Easy Connect string with host, service name, and server. The host name is sales-server, the service name is sales, the server is dedicated, and the instance name is inst1</p>	<p>sales-server/sales:dedicated/inst1</p>	<pre>(DESCRIPTION= (CONNECT_DATA= (SERVICE_NAME=sales) (INSTANCE_NAME=inst1) (SERVER=dedicated)) (ADDRESS= (PROTOCOL=TCP) (HOST=sales-server) (PORT=1521)))</pre>
<p>Easy Connect with host and instance name. The host name is sales-server and the instance name is inst1.</p>	<p>sales-server//inst1</p>	<pre>(DESCRIPTION= (CONNECT_DATA= (SERVICE_NAME=) (INSTANCE_NAME=inst1)) (ADDRESS= (PROTOCOL=TCP) (HOST=sales-server) (PORT=1521)))</pre>

**Table 8-2 (Cont.) Examples of Easy Connect Naming**

Naming Option	Connect String	Connect Descriptor
 <b>N</b> <b>o</b> <b>t</b> <b>e</b> <b>:</b> T h e E a s y C o n n e c t P l u s f e a t u r e s u p p o r t s t h i s n a m i n	<pre>salesserver1:1521/sales? SDU=8128&amp;retry_count=3&amp;connect_t imeout=10</pre>	<pre>(DESCRIPTION= (SDU=8128)(retry_count=3) (connect_timeout=10) (ADDRESS=(PROTOCOL=tcp) (HOST=salesserver1)(PORT=1521)) (CONNECT_DATA=(SERVICE_NAME=sal es)))</pre>

**Table 8-2 (Cont.) Examples of Easy Connect Naming**

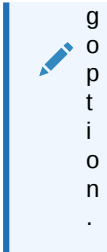
Naming Option	Connect String	Connect Descriptor
 <p data-bbox="164 653 456 873">                     Easy Connect adaptor with a list of name value pairs.                      SDU, RETRY_COUNT,                      CONNECT_TIMEOUT                      The host is salesserver,                      the port is 1521, and the                      service name is sales.                 </p>		

**Table 8-2 (Cont.) Examples of Easy Connect Naming**

Naming Option	Connect String	Connect Descriptor
<p> <b>N</b> <b>o</b> <b>t</b> <b>e</b> <b>:</b> T h e E a s y C o n n e c t P l u s f e a t u r e s u p p o r t s t h i s n a m i n</p>	<p>salesserver1:1521,salesserver2,salesserver3:1522/sales</p>	<pre>( (DESCRIPTION=(LOAD_BALANCE=ON)   (ADDRESS=(PROTOCOL=tcp)     (HOST=sales-server1)     (PORT=1521))   (ADDRESS=(PROTOCOL=tcp)     (HOST=sales-server2)     (PORT=1522))   (ADDRESS=(PROTOCOL=tcp)     (HOST=sales-server3)     (PORT=1522))) (CONNECT_DATA=(SERVICE_NAME=sales)))</pre>

Table 8-2 (Cont.) Examples of Easy Connect Naming

Naming Option	Connect String	Connect Descriptor
	<p>Easy Connect adaptor with multiple hosts or ports in the connect string</p> <p>The host is salesserver, the port is 1521, and the service name is sales.</p>	

**Table 8-2 (Cont.) Examples of Easy Connect Naming**

Naming Option	Connect String	Connect Descriptor
<p> <b>N</b> <b>o</b> <b>t</b> <b>e</b> <b>:</b> T h e E a s y C o n n e c t P l u s f e a t u r e s u p p o r t s t h i s n a m i n</p>	<p>tcps://salesserver1:1521/sales</p>	<pre>(DESCRIPTION= (AADDRESS=(PROTOCOL=tcps) (HHOST=salesserver1)(PORT=1521)) (SEcurity=(SSL_SERVER_DN_MATCH= TRUE)) (CONNECT_DATA=(SERVICE_NAME=sal es)))</pre>

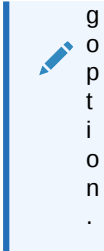
Table 8-2 (Cont.) Examples of Easy Connect Naming

Naming Option	Connect String	Connect Descriptor
	<p>Easy Connect adaptor with specification of protocol as part of the connect string.</p> <p>The host is salesserver, the port is 1521, and the service name is sales.</p>	

**Table 8-2 (Cont.) Examples of Easy Connect Naming**

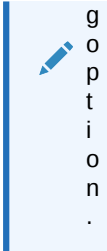

Naming Option	Connect String	Connect Descriptor
<p> <b>N</b> <b>O</b> <b>t</b> <b>e</b> <b>:</b> T h e E a s y C o n n e c t P l u s f e a t u r e s u p p o r t s t h i s n a m i n</p>	<pre>tcps://salesserver:1521/ sales:ssl_server_cert_dn="cn=sales,cn=OracleContext,dc=us,dc=example,dc=com&amp;wallet_location=/tmp/oracle"</pre>	<pre>(DESCRIPTION=  (ADDRESS=(PROTOCOL=tcps)  (HOST=salesserver) (PORT=1521))  (CONNECT_DATA=(SERVICE_NAME=sales))  (SECURITY=(SSL_SERVER_DN_MATCH=TRUE)  (SSL_SERVER_CERT_DN=cn=sales,cn=OracleContext,dc=us,dc=example,dc=com) (MY_WALLET_LOCATION=/tmp/oracle)))</pre>



Table 8-2 (Cont.) Examples of Easy Connect Naming

Naming Option	Connect String	Connect Descriptor
 <p>The following SECURITY attributes are supported for TLS</p> <p>The host is sales-server, the port is 1521, and the service name is sales.</p>		

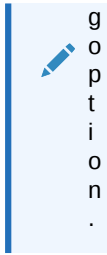
 **See Also:**

- ["About TCP/IP Protocol"](#)
- ["Configuring Listening Protocol Addresses"](#)
- ["Using Oracle Connection Manager as a Bridge for IPv4 and IPv6"](#)

### 8.1.3 Configuring Easy Connect Naming on the Client

Clients can connect to Oracle Database using Easy Connect naming if the following conditions are met:

- Oracle Net Services software is installed on the client.
- Oracle TCP/IP protocol is supported on both the client and database server.
- No features require a more advanced connect descriptor.

Easy Connect naming is not suitable for large or complex environments with advanced features, such as external procedure calls, or Heterogeneous Services, that require additional connect information. In these cases, another naming method is recommended.

Easy Connect naming is automatically configured at installation. Before using it, you may want to ensure that `EZCONNECT` is specified by the `NAMES.DIRECTORY_PATH` parameter in the `sqlnet.ora` file. This parameter specifies the order of naming methods Oracle Net can use to resolve connect identifiers to connect descriptors.

 **Note:**

Starting with Oracle Database 19c Release 2 (19.2), for connections with protocol set to TCPS, `SSL_SERVER_DN_MATCH` is set to `ON` by default when using easy connect. If `SSL_SERVER_CERT_DN` is not set, then a partial DN match done in the following order, should succeed for the client to establish a connection to the server.

1. The host name in the connect string is matched with the host name in the server certificate.
2. The service name in the connect string is matched with the service name in the server certificate.

If `SSL_SERVER_CERT_DN` is set, then a full DN match should succeed for the client to establish a connection to the server.

The following procedure describes how to verify that the Easy Connect naming method is configured:

1. Start Oracle Net Manager.

 **See Also:**

["Using Oracle Net Manager to Configure Oracle Net Services"](#)

2. In the navigator pane, expand **Local**, and then select **Profile**.
3. From the list in the right pane, select **Naming**.
4. Click the **Methods** tab.

Verify that `EZCONNECT` is listed in the Selected Methods list. If it is not, then proceed to Step 5. If it is listed, then proceed to Step 7.

5. From the Available Methods list, select **EZCONNECT**, and then click the right-arrow button.
6. In the Selected Methods list, select **EZCONNECT**, and then use the **Promote** button to move the selection to the top of the list.
7. Select **Save Network Configuration** from the File menu.

The `sqlnet.ora` file updates the `NAMES.DIRECTORY_PATH` parameter, listing `hostname` first:

```
NAMES.DIRECTORY_PATH=(ezconnect, tnsnames)
```

## 8.1.4 Configuring Easy Connect Naming to Use a DNS Alias

You can optionally configure a DNS alias for the host name, as provided with the host naming method in Oracle Database 12c. With host naming, clients use a connect string that uses the following pattern:

```
CONNECT username@DNS_alias
Enter password: password
```

The following procedure describes how to configure a DNS alias:

1. Ensure the database service is registered with the listener.

If the database can find the listener, then information about the database service is dynamically registered with the listener during service registration, including the service name. The listener is found if the following conditions are met:

- The default listener named `LISTENER` on TCP/IP, port 1521 is running.
- The `LOCAL_LISTENER` parameter is set in the initialization file.

If the database cannot find the listener, then refer to "[Configuring Static Registration for the Listener](#)" for information about static registration.

2. Establish a host name resolution environment.

You can configure a mechanism such as DNS, NIS, or a centrally-maintained TCP/IP host file, `/etc/hosts`. For example, if a service name of `sales.us.example.com` for a database exists on a computer named `sales-server`, then the entry in the `/etc/hosts` file would look like the following:

```
#IP address of server      host name      alias
192.0.2.35                sales-server   sales.us.example.com
```

The domain section of the service name must match the network domain.

3. Connect to the database using the DNS alias.

Using the example in the previous step, the client can use `sales.example.com` in the connect string:

```
CONNECT username@sales.us.example.com
Enter password: password
```

If the client and server are in the same domain such as `us.example.com`, then the client must enter only `sales` in the connect string.

## 8.2 Configuring the Local Naming Method

The local naming method adds network service names to the `tnsnames.ora` file. Each network service name maps to a connect descriptor.

[Example 8-2](#) shows the network service name `sales` mapped to the connect descriptor contained in `DESCRIPTION`. The `DESCRIPTION` section contains the protocol address and identifies the destination database service. In this example, the protocol is TCP/IP and the port is 1521.

### Example 8-2 Connector Descriptor with Host Name

```
sales=
(DESCRIPTION=
  (ADDRESS=(PROTOCOL=tcp)(HOST=sales-server)(PORT=1521))
  (CONNECT_DATA=
    (SERVICE_NAME=sales.us.example.com)))
```

[Example 8-3](#) shows a valid `tnsnames.ora` entry to connect to a host identified with an IPv6 address and a port number of 1522.

**Example 8-3 Connect Descriptor with IPv6 Address**

```
salesdb =
( DESCRIPTION =
  ( ADDRESS=(PROTOCOL=tcp)(HOST=2001:0db8:1:1::200c:417a)(PORT=1522) )
  ( CONNECT_DATA =
    (SERVICES_NAME=sales.example.com) )
)
```

You can configure local naming during or after installation, as described in the following sections:

- [Configuring the tnsnames.ora File During Installation](#)
- [Configuring the tnsnames.ora File After Installation](#)

 **See Also:**

["IPv6 Network Connectivity"](#)

## 8.2.1 Configuring the tnsnames.ora File During Installation

Oracle Net Configuration Assistant enables you to configure network service names for clients. Oracle Universal Installer launches Oracle Net Configuration Assistant after software installation. The configuration varies depending on the installation mode.

- Administrator or runtime installation: Oracle Net Configuration Assistant prompts you to configure network service names in the `tnsnames.ora` file to connect to an Oracle Database service.
- Custom installation: Oracle Net Configuration Assistant prompts you to select naming methods to use. If local is selected, then Oracle Net Configuration Assistant prompts you to configure network service names in the `tnsnames.ora` file to connect to an Oracle Database service.

## 8.2.2 Configuring the tnsnames.ora File After Installation

You can add network service names to the `tnsnames.ora` file at any time after installation. To configure the local naming method, perform the following tasks:

- [Task 1, Configure Net Services Names](#)
- [Task 2, Configure Local Naming as the First Naming Method](#)
- [Task 3, Copy the Configuration to the Other Clients](#)
- [Task 4, Configure the Listener](#)
- [Task 5, Connect to the Database](#)

 **Note:**

The underlying network connection must be operational before attempting to configure connectivity with Oracle Net.

**Task 1 Configure Net Services Names**

To configure the network services names, use one of the following methods:

- [Net Services Names Configuration using Oracle Enterprise Manager Cloud Control](#)
- [Net Services Names Configuration using Oracle Net Manager](#)
- [Net Services Names Configuration using Oracle Net Configuration Assistant](#)

Each method provides similar functionality. However, Oracle Net Manager has more configuration options for the `sqlnet.ora` file.

- **Net Services Names Configuration using Oracle Enterprise Manager Cloud Control**

The following procedure describes how to configure network service names in the `tnsnames.ora` file with Oracle Enterprise Manager Cloud Control:

1. Access the Net Services Administration page in Oracle Enterprise Manager Cloud Control.

 **See Also:**

["Accessing the Net Services Administration Page"](#)

2. Select **Local Naming** from the Administer list, and then select the Oracle home that contains the location of the configuration files.
3. The Local Naming page appears. You may be prompted to log in to the database server.
4. Click **Create Like**.

The Create Net Service Name page appears.

5. Enter a name in the Net Service Name field.

You can qualify the network service name with the client's domain. The network service name is automatically domain qualified if the `sqlnet.ora` file parameter `NAMES.DEFAULT_DOMAIN` is set.

 **See Also:**

["About the Default Domain for Clients"](#)

6. In the Database Information section, configure service support as follows:
  - a. Enter a destination service name.

 **See Also:**

"[About Connect Descriptors](#)" for additional information about the service name string to use

- b. Select a database connection type.

The default setting of Database Default is recommended for the connection type. If dedicated server is configured in the initialization parameter file, then you can select Dedicated Server to force the listener to spawn a dedicated server, bypassing shared server configuration. If shared server is configured in the initialization parameter file and you want to guarantee the connection always uses shared server, then select Shared Server.

 **See Also:**

"[Configuring a Shared Server Architecture](#)" for additional information about shared server configuration

7. In the Addresses section, configure protocol support, as follows:

- a. Click **Add**.

The Add Address page appears.

- b. From the Protocol list, select the protocol on which the listener is configured to listen. This protocol must also be installed on the client.
  - c. Enter the appropriate parameter information for the selected protocol in the fields provided.

 **See Also:**

*Oracle Database Net Services Reference* for additional information about protocol parameter settings

- d. (Optional) In the Advanced Parameters section, specify the I/O buffer space limit for send and receive operations of sessions in the Total Send Buffer Size and Total Receive Buffer Size fields.

 **See Also:**

"[Configuring I/O Buffer Space](#)" for additional information about buffer space

- e. Click **OK**.

The protocol address is added to the Addresses section.

8. Click **OK** to add the network service name.

The network service name is added to the Local Naming page.

9. Select connect-time failover and client load balancing option for the addresses.

10. Click **OK**.

 **See Also:**

- "[Creating a List of Listener Protocol Addresses](#)" to configure multiple protocol addresses
- "[About the Advanced Connect Data Parameters](#)" to configure additional CONNECT\_DATA options

- **Net Services Names Configuration using Oracle Net Manager**

The following procedure describes how to configure network service names in the `tnsnames.ora` file with Oracle Net Manager:

1. Start Oracle Net Manager.

 **See Also:**

"[Using Oracle Net Manager to Configure Oracle Net Services](#)"

2. In the navigator pane, select **Service Naming** from Local.
3. Click the plus sign (+) from the toolbar, or select **Create** from the Edit menu.  
The Welcome page of the Net Service Name wizard appears.
4. Enter a name in the Net Service Name field.

You can qualify the network service name with the client's domain. The network service name is automatically domain qualified if the `sqlnet.ora` file parameter `NAMES.DEFAULT_DOMAIN` is set.

 **See Also:**

["About the Default Domain for Clients"](#)

5. Click **Next**.  
The Protocol page appears.
6. Select the protocol on which the listener is configured to listen. The protocol must also be installed on the client.
7. Click **Next**.  
The Protocol Settings page appears.
8. Enter the appropriate parameter information for the selected protocol in the fields provided.

 **See Also:**

*Oracle Database Net Services Reference* for additional information about protocol parameter settings

9. Click **Next**.  
The Service page appears.
10. Enter a destination service name, and optionally, select a database connection type.  
  
Oracle recommends that you use the default setting of Database Default for the connection type. If dedicated server is configured in the initialization parameter file, then you can select Dedicated Server to force the listener to spawn a dedicated server, bypassing shared server configuration. If shared server is configured in the initialization parameter file and you want to guarantee the connection always uses shared server, then select Shared Server.

 **See Also:**

- [Configuring a Shared Server Architecture](#) for additional information about shared server configuration
- ["About Connect Descriptors"](#) for additional information about the service name string to use

11. Click **Next**.  
The Test page appears.



12. Click **Test** to verify that the network service name works, or click **Finish** to dismiss the Net Service Name wizard.

If you click Test, then Oracle Net connects to the database server by using the connect descriptor information you configured. Therefore, the listener and database must be running for a successful test. If they are not, then see "[Starting Oracle Net Listener and the Oracle Database Server](#)" to start components before testing. During testing, a Connection Test dialog box appears, providing status and test results. A successful test results in the following message:

```
The connection test was successful.
```

If the test was successful, then click **Close** to close the Connect Test dialog box, and proceed to Step 13.

If the test was not successful, then do the following:

- a. Ensure that the database and listener are running, and then click **Test**.
  - b. Click **Change Login** to change the user name and password for the connection, and then click **Test**.
13. Click **Finish** to close the Net Service Name wizard.
  14. Select **Save Network Configuration** from the File menu.

#### See Also:

- "[Creating a List of Listener Protocol Addresses](#)" to configure multiple protocol addresses
- "[About the Advanced Connect Data Parameters](#)" to configure additional CONNECT\_DATA options

- **Net Services Names Configuration using Oracle Net Configuration Assistant**

The following procedure describes how to configure network service names in the `tnsnames.ora` file with Oracle Net Configuration Assistant:

1. Start Oracle Net Configuration Assistant.

#### See Also:

["Using Oracle Net Configuration Assistant to Configure Network Components"](#)

The Welcome page appears.

2. Select **Local Net Service Name Configuration**, and then click **Next**.  
The Net Service Name Configuration page appears.

3. Click **Add**, and then click **Next**.  
The Service Name Configuration page appears.
4. Enter a service name in the Service Name field.
5. Click **Next**.
6. Follow the prompts in the wizard and online help to complete network service name creation.

### Task 2 Configure Local Naming as the First Naming Method

Configure local naming as the first method specified in the NAMES.DIRECTORY\_PATH parameter in the `sqlnet.ora` file. This parameter specifies the order of naming methods Oracle Net uses to resolve connect identifiers to connect descriptors.

To configure the local naming method as the first naming method, use one of the following methods:

- [Local Naming Configuration using Oracle Enterprise Manager Cloud Control](#)
- [Local Naming Configuration using Oracle Net Manager](#)

Each method provides the same functionality.

#### Local Naming Configuration using Oracle Enterprise Manager Cloud Control

The following procedure describes how to specify local naming as the first naming method using Oracle Enterprise Manager Cloud Control:

1. Access the Net Services Administration page in Oracle Enterprise Manager Cloud Control.



#### See Also:

["Accessing the Net Services Administration Page"](#)

2. Select **Network Profile** from the Administer list.
3. Click **Go**.
4. Select **Naming Methods**.
5. Select **TNSNAMES** from the Available Methods list.
6. Click **Move** to move the selection to the Selected Methods list.
7. Use the **Promote** button to move TNSNAMES to the top of the list.
8. Click **OK**.

#### Local Naming Configuration using Oracle Net Manager

The following procedure describes how to specify local naming as the first naming method using Oracle Net Manager:

1. Start Oracle Net Manager.

 **See Also:**

["Using Oracle Net Manager to Configure Oracle Net Services"](#)

2. In the navigator pane, select **Profile** from the Local menu.
3. From the list in the right pane, select **Naming**.
4. Click the **Methods** tab.
5. From the Available Methods list, select **TNSNAMES**, and then click the right-arrow button.
6. From the Selected Methods list, select **TNSNAMES**, and then use the **Promote** button to move the selection to the top of the list.
7. Choose **Save Network Configuration** from the File menu.

The `sqlnet.ora` file updates with the `NAMES.DIRECTORY_PATH` parameter, listing `tnsnames` first:

```
NAMES.DIRECTORY_PATH=(tnsnames, EZCONNECT)
```

### Task 3 Copy the Configuration to the Other Clients

After one client is configured, it is best to simply copy the `tnsnames.ora` and `sqlnet.ora` configuration files to the same location on the other clients. This ensures that the files are consistent. Alternatively, you can use Oracle Net Assistant on every client.

### Task 4 Configure the Listener

Ensure that the listener located on the server is configured to listen on the same protocol address configured for the network service name. By default, the listener is configured for the TCP/IP protocol on port 1521.

 **See Also:**

[Configuring and Administering Oracle Net Listener](#) for listener configuration details

### Task 5 Connect to the Database

Clients can connect to the database using the following syntax:

```
CONNECT username@net_service_name
```

## 8.3 Configuring the Directory Naming Method

With the directory naming method, connect identifiers are mapped to connect descriptors contained in an LDAP-compliant directory server, such as Oracle Internet Directory and Microsoft Active Directory. A directory provides central administration of database services and network service names, making it easier to add or relocate services.

A database service entry is created during installation. Oracle Enterprise Manager Cloud Control and Oracle Net Manager are used to create and modify network service

names and network service alias entries, and to modify the database service entry. Clients can use these entries to connect to the database.

To configure the directory naming method, perform the following tasks:

### Task 1 Verify Directory Compatibility

On the computer from which you plan to create network service names, do the following verification steps:

1. Ensure the computer has the latest release of Oracle Net Services software. The release information is located in the About Net Manager option on the help menu.
2. Run Oracle Internet Directory Configuration Assistant to verify directory server, Oracle Context, and Oracle schema releases.

#### See Also:

*Oracle Fusion Middleware Administrator's Guide for Oracle Internet Directory* for additional information about configuring directory server usage

### Task 2 Create Net Service Names in the Directory

You can configure clients to use a network service name rather than the database service entry. The following procedure describes how to create network service names:

#### Note:

- Only users that are members of either the `OracleNetAdmins` or `OracleContextAdmins` group can create network service name entries in a directory. To add or remove users from the `OracleNetAdmins` group, see ["Who Can Add or Modify Entries in the Directory Server"](#).
- You can export existing network service names from a `tnsnames.ora` file. See ["Exporting Local Naming Entries to a Directory Naming Server"](#).

1. Access the Net Services Administration page in Oracle Enterprise Manager Cloud Control.

#### See Also:

["Accessing the Net Services Administration Page"](#)

2. Select **Directory Naming** from the Administer list, and then select the Oracle home that contains the location of the directory server.
3. Click **Go**.

The Directory Naming page appears.

4. Click the **Net Service Names** tab.

5. In the Results section, click **Create**.

The Create Net Service Name page with the General tab appears.

6. Enter a name in the Net Service Name field.

7. In the Database Information section, configure service support, as follows:

- a. Enter a destination service name.

If the destination service name is for an Oracle9i database or later, then select **Use Service Name**, and enter a service name in the Service Name field.

 **See Also:**

["About Connect Descriptors"](#) for additional information about the service name string to use

- b. Select a database connection type. Oracle recommends that you use the Database Default for the connection type. If a shared server is configured in the initialization parameter file, then the following options are available:
  - Select Dedicated Server to force the listener to spawn a dedicated server, and bypass shared server configuration.
  - Select Shared Server to guarantee the connection always uses shared server.

 **See Also:**

[Configuring a Shared Server Architecture](#) for additional information about shared server configuration

8. In the Addresses section, configure protocol support, as follows:

- a. Click **Add**.

The Add Address page appears.

- b. From the Protocol list, select the protocol that the listener is configured to listen. This protocol must also be installed on the client.

- c. Enter the appropriate parameter information for the selected protocol in the fields provided.

 **See Also:**

*Oracle Database Net Services Reference* for additional information about protocol parameter settings

- d. (Optional) In the Advanced Parameters section, specify the I/O buffer space limit for send and receive operations of sessions in the Total Send Buffer Size and Total Receive Buffer Size fields.

 **See Also:**

"[Configuring I/O Buffer Space](#)" for additional information

- e. Click **OK**.

The protocol address is added to the Addresses section.

9. Click **OK** to add the network service name.

The network service name is added to the Results section of the Net Service Names tab.

 **See Also:**

- "[Creating a List of Listener Protocol Addresses](#)" to configure multiple protocol addresses
- "[About the Advanced Connect Data Parameters](#)" to configure additional CONNECT\_DATA options

### Task 3 Modify Connectivity Information for Database Service Entries

When database registration with the directory naming completes, a database service entry is created in the directory. By default, this entry contains network route information with the location of the listener through a protocol address. You can re-create this information or modify the existing network route information.

 **Note:**

Only users that are members of the `OracleNetAdmins` or `OracleContextAdmins` group can modify network information for a database service in a directory. To add or remove users from these groups, see "[Who Can Add or Modify Entries in the Directory Server](#)".

The following procedure describes how to create or modify network route information for a database service:

1. Access the Net Services Administration page in Oracle Enterprise Manager Cloud Control.

 **See Also:**

["Accessing the Net Services Administration Page"](#)

2. Select **Directory Naming** from the Administer list, and then select the Oracle home that contains the location of the directory server.
3. Click **Go**. You may be prompted to log in to the database server and the directory server.

The Directory Naming page appears.

4. Click the **Database Services** tab.
5. In the Simple Search section, select **Oracle Context** and search criteria to see the network service names for Oracle Context.

The database service names display in the Results section.

6. In the Results section, select a database service, and then click **Edit**.

#### Task 4 Create Net Services Aliases

Net service aliases in a directory server enable clients to refer to a database service or a network service name by an alternative name. For example, a network service alias of `salesalias` can be created for a network service name of `sales`. When `salesalias` is used to connect to a database, as in `CONNECT scott@salesalias`, it resolves to and use the connect descriptor information for `sales`.

There are two main uses of network service aliases:

- Use a network service alias as a way for clients to refer to a database service or network service name by another name.
- Use a network service alias in one Oracle Context for a database service or network service name in a different Oracle Context. This enables a database service or network service name to be defined once in the directory server, and referred to by clients that use other Oracle Contexts.

 **See Also:**

["Understanding Net Service Alias Entries"](#) for an overview of network service aliases

 **Note:**

- Only users that are members of either the `OracleNetAdmins` or `OracleContextAdmins` group can create or modify network service alias entries in a directory. To add or remove users from the `OracleNetAdmins` group, see "[Who Can Add or Modify Entries in the Directory Server](#)".
- To create or access network service aliases, ensure that the Oracle home is at least release 9.2.0.4.
- Net service aliases are not supported by Microsoft Active Directory.
- Ensure the `NLS_LANG` environment variable is set for the clients when using network service aliases.

To create a network service alias, use one of the following methods:

- [Network Service Alias Configuration using Oracle Enterprise Manager Cloud Control](#)
- [Network Service Alias Configuration using Oracle Net Manager](#)

Each method provides similar functionality.

### **Network Service Alias Configuration using Oracle Enterprise Manager Cloud Control**

The following procedure describes how to configure a network service alias using Oracle Enterprise Manager Cloud Control:

1. Access the Net Services Administration page in Oracle Enterprise Manager Cloud Control.

 **See Also:**

["Accessing the Net Services Administration Page"](#)

2. Select **Directory Naming** from the Administer list, and then select the Oracle home that contains the location of the directory server.
3. Click **Go**.  
The Directory Naming page appears.
4. Click the **Net Service Aliases** tab.
5. In the Results section, click **Create**.  
The Create Net Service Alias page appears.
6. Enter a name for the alias in the Net Service Alias Name field.
7. In the Referenced Service Detail section, enter the following information in the fields:



- Oracle Context: Select the Oracle Context of the database service or network service name from the list or enter one in the field.
  - Referenced Service Name: Select the DN of the database service or network service name.
8. Click **OK** to add the network service alias.  
The network service alias is added to the Directory Naming page.

### Network Service Alias Configuration using Oracle Net Manager

The following procedure describes how to configure a network service alias using Oracle Net Manager:

1. Start Oracle Net Manager.

 **See Also:**

["Using Oracle Net Manager to Configure Oracle Net Services"](#)

2. In the navigator pane, select **Service Naming** from Directory.
3. Select **Aliases**.
4. Select **Create** from the Edit menu.
5. Enter the network service alias in the Net Service Alias field.
6. Select **Oracle Context** and name.
7. Click **Create**.
8. Select **Save Network Configuration** from the File menu.

### Task 5 Configure LDAP as the First Naming Method for Client Lookups

Configure directory naming as the first method to be used in the NAMES.DIRECTORY\_PATH parameter in the `sqlnet.ora` file. This parameter specifies the order of naming methods Oracle Net uses to resolve connect identifiers to connect descriptors. To configure LDAP as the first naming method you can use one of the following methods:

- [LDAP Configuration using Oracle Enterprise Manager Cloud Control](#)
- [LDAP Configuration using Oracle Net Manager](#)

### LDAP Configuration using Oracle Enterprise Manager Cloud Control

The following procedure describes how to specify directory naming as the first naming method using Oracle Enterprise Manager Cloud Control:

1. Access the Net Services Administration page in Oracle Enterprise Manager Cloud Control.

 **See Also:**

["Accessing the Net Services Administration Page"](#)

2. Select **Network Profile** from the Administer list.

3. Click **Go**.
4. Select **Naming Methods**.
5. Select **LDAP** from the Available Methods list.
6. Click **Move** to move the selection to the Selected Methods list.
7. Use the **Promote** button to move LDAP to the top of the list.
8. Click **OK**.

### LDAP Configuration using Oracle Net Manager

The following procedure describes how to specify directory naming as the first naming method using Oracle Net Manager:

1. Start Oracle Net Manager.



#### See Also:

["Using Oracle Net Manager to Configure Oracle Net Services"](#)

2. In the navigator pane, select **Profile** from the Local menu.
3. From the list in the right pane, select **Naming**.
4. Click the **Methods** tab.
5. From the Available Methods list, select **LDAP**, and then click the right-arrow button.
6. From the Selected Methods list, select **LDAP**, and then use the **Promote** button to move the selection to the top of the list.
7. Select **Save Network Configuration** from the File menu.

The `sqlnet.ora` file updates with the `NAMES.DIRECTORY_PATH` parameter, listing `ldap` first, such as the following:

```
NAMES.DIRECTORY_PATH=(ldap, tnsnames, hostname)
```

### Task 6 Configure the Listener

Ensure that the listener located on the server is configured to listen on the same protocol address configured for the network service name. By default, the listener is configured to listen on the TCP/IP protocol, port 1521.



#### See Also:

[Configuring and Administering Oracle Net Listener](#) for listener configuration details

### Task 7 Connect to the Database

Clients that are configured with a default directory entry that matches the directory location of the database service or network service name can connect to the database using the following syntax:

```
CONNECT username@connect_identifier
```

Clients that are configured with a default directory entry that does not match the entry's directory location must use the entry's distinguished name or its fully-qualified name.

 **See Also:**

- "[Connect Identifier and Connect Descriptor Syntax Characteristics](#)" for connect identifier syntax rules
- "[Understanding the Directory Information Tree](#)" for fully-qualified name usage

## 8.4 Creating Multiple Default Contexts in a Directory Naming Server

If you want clients to use discovery in directories which have more than one Oracle Context, then you can define the `orclCommonContextMap` attribute in the base `admin` context. This attribute overrides the `orclDefaultSubscriber` attribute. During name lookup the discovery operation returns both values, and the client decides based on these which Oracle Context to use.

If the `orclCommonContextMap` attribute is not defined, then the `orclDefaultSubscriber` is used as the default. If `orclCommonContextMap` is defined, then the client finds the default Oracle Context which is associated with its DNS domain in the `orclCommonContextMap`. To enable multiple default contexts, define the `orclCommonContextMap` with a list of associations between a domain and a DN to be used as the default `oracleContext`. A sample LDIF file entry is shown here:

```
$ ldapmodify -v -h sales-server -p 1389 -D cn=orcladmin -q
dn: cn=Common,cn=Products,cn=OracleContext
replace: orclCommonContextMap
orclCommonContextMap:
(contextMap=
(domain_map=(domain=us.example.com)(DN="dc=example,dc=com"))
(domain_map=(domain=uk.example.com)(DN="dc=sales,dc=com"))
)
```

The `contextMap` entry must be entered without line breaks.

 **See Also:**

*Oracle Fusion Middleware Administrator's Guide for Oracle Internet Directory* for additional information about how to configure the directory for context mapping

## 8.5 Exporting Local Naming Entries to a Directory Naming Server

If a `tnsnames.ora` file already exists, then its network service names can be exported to a directory server. The export procedure is performed for one domain at a time.

This section explains how to export data stored in a `tnsnames.ora` file to a directory server. It includes the following tasks:

- [Task 1, Create Structure in the Directory Server](#)
- [Task 2, Create Oracle Contexts](#)
- [Task 3, Configure Directory Server Usage](#)
- [Task 4, Export Objects to a Directory Server](#)

 **Note:**

These tasks assume the directory server has been installed and is running.

### Task 1 Create Structure in the Directory Server

In the directory server, create the directory information tree (DIT) with the structure in which you want to import network service names. Create the structure leading to the top of the Oracle Context.

For example, if the `tnsnames.ora` file supports a domain structure `example.com` and you want to replicate this domain in the directory, then create domain component entries of `dc=com` and `dc=example` in the directory, as shown in the following figure.

**Figure 8-1** `example.com` in Directory Server

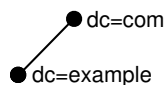

You can replicate the domain structure you currently use with `tnsnames.ora`, or you can develop an entirely different structure. Introducing an entirely different structure can change the way clients enter the network service name in the connect string. Oracle recommends considering relative and fully-qualified naming issues before changing the structure.

 **See Also:**

- Directory server vendor documentation for directory entry configuration instructions
- ["Client Connections Using Directory Naming"](#)

### Task 2 Create Oracle Contexts

Create an Oracle Context under each DIT location that you created in Task 1 using Oracle Internet Directory Configuration Assistant. Oracle Context has a relative distinguished name (RDN) of `cn=OracleContext`. Oracle Context stores network object entries, as well as other entries for other Oracle components. In the following figure, `cn=OracleContext` is created under `dc=example,dc=com`.

**Figure 8-2 Oracle Context**

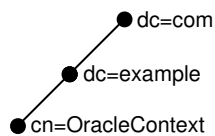

 **See Also:**

- [Managing Network Address Information](#) for additional information about Oracle Context
- *Oracle Fusion Middleware Administrator's Guide for Oracle Internet Directory* for instructions on creating an Oracle Context

### Task 3 Configure Directory Server Usage

If not done as a part of creating Oracle Contexts, then configure the Oracle home for directory server use. The Oracle home you configure should be the one that performs the export.

 **See Also:**

*Oracle Fusion Middleware Administrator's Guide for Oracle Internet Directory* for additional information about configuring directory server usage

### Task 4 Export Objects to a Directory Server

To export network service names contained in a `tnsnames.ora` file to a directory, use either Oracle Enterprise Manager Cloud Control or Oracle Net Manager.

- **Export Objects using Oracle Enterprise Manager Cloud Control**

The following procedure describes how to export objects using Oracle Enterprise Manager Cloud Control

1. Access the Net Services Administration page in Oracle Enterprise Manager Cloud Control.

 **See Also:**

["Accessing the Net Services Administration Page"](#)

2. Select **Directory Naming** from the Administer list, and then select the Oracle home that contains the location of the directory server.
  3. Click **Go**.
- The Directory Naming page appears.
4. Click the **Net Service Names** tab.
  5. In the Related Links section, click **Import Net Service Names To Directory Server**.

The Import Net Service Names To Directory Server page appears.

6. From the Oracle Context list in the Oracle Internet Directory Server Destination section, select Oracle Context to which you want to export the selected network service names.
7. In the Net Service Names to Import section, select the network service names.
8. Click **Add** to add the network service names to the directory.

The network service name is added to the Directory Naming page.

- **Export Objects using Oracle Net Manager**

The following procedure describes how to export objects using Oracle Net Manager:

1. Start Oracle Net Manager.

 **See Also:**

["Using Oracle Net Manager to Configure Oracle Net Services"](#)

2. If the `tnsnames.ora` file you want to export is not loaded in Oracle Net Manager, then select **Open Network Configuration** from the File menu to select the `tnsnames.ora` file to export to the directory.
3. Select **Directory** from the Command menu, and then select **Export Net Service Names**.

The Directory Server Migration wizard starts.

4. Click **Next**.

If network service names with multiple domain were detected in the `tnsnames.ora` file, then the Select Domain page appears. Continue to Step 5.

If the network service names are not domain qualified, then the Select Net Service Names page appears. Skip to Step 6.

5. Select the network domain whose network service names you want to export, and then click **Next**.

The Select Net Service Names page appears.

6. Select the network service names from the list to export, and then click **Next**.  
The Select Destination Context page appears.

7. In the Select Destination Context page, do the following:

- a. From the Directory Naming Context list, select the directory entry that contains the Oracle Context. The directory naming context is part of a directory subtree that contains one or more Oracle Contexts.
- b. From the Oracle Context list, select the Oracle Context to which you want to export the selected network service names.
- c. Click **Next**.

The Directory Server Update page appears with the status of the export operation.

8. Click **Finish** to close the Directory Server Migration wizard.

## 8.6 Exporting Directory Naming Entries to a tnsnames.ora File

After you create the directory naming entries, consider exporting the entries to a local `tnsnames.ora` file, and distributing that file to clients. Clients can use the locally saved file when a directory server is temporarily unavailable.

The following procedure describes how to export directory naming entries to a local `tnsnames.ora` file:

1. Access the Net Services Administration page in Oracle Enterprise Manager Cloud Control.



### See Also:

["Accessing the Net Services Administration Page"](#)

2. Select **Directory Naming** from the Administer list, and then select the Oracle home that contains the location of the directory server.
3. Click **Go**.  
The Directory Naming page appears.
4. Click the **Net Service Names** tab.
5. In the Simple Search section, select **Oracle Context** and search criteria to see the network service names for a particular Oracle Context.

The network service names display in the Results section.

6. In the Results section, click **Save to tnsnames.ora**.

The Processing: Create tnsnames.ora File page appears, informing you of the creation process.

## 8.7 Configuring External Naming Methods

External naming refers to the method of resolving a network service name, stored in a third-party naming service, to a network address, such as network information services (NIS). Organizations and corporations using NIS as part of their systems infrastructure have the option to store network service names and addresses in NIS, using NIS external naming.

For example, when a user gives a command with a network service name (`payroll`) such as the following:

```
SQLPLUS scott@payroll
```

NIS external naming on the node running the client program or database server acting as a client program contacts an NIS server located on the network, and passes the network service name to the NIS server. The NIS server resolves the network service name into an Oracle Net address and returns this address to the client program or server. The client program then uses this address to connect to Oracle Database.

An NIS server runs a program called `ypserv`, which handles name requests. The `ypserv` program stores different types of data in special files called **maps**. For example, passwords are stored in a map called `passwd.byname`. Oracle Database service names are stored in a map called `tnsnames`.

When a user uses a connect string, NIS external naming uses an RPC call to contact the `ypserv` program, and passes the Oracle network service name and the name of the map. The `ypserv` program looks in the `tnsnames` map for the name, such as `payroll`, and its address for the network service name. The address is returned to the client, and the client program uses the address to contact the database server.



 **Note:**

The NIS external naming method is not available on all platforms. Use the `adapters` command to check availability of NIS external naming on your system. If available, then it is listed under Oracle Net naming methods, as follows:

```
$ adapters
```

Installed Oracle Net naming methods are:

```
Local Naming (tnsnames.ora)
Oracle Directory Naming
Oracle Host Naming
NIS Naming
```

See Oracle platform-specific documentation for additional information.

Perform the following tasks:

- **Task 1: Configure NIS Servers to Support NIS External Naming**  
Before configuring servers to support NIS external naming, ensure that NIS is configured and running on the NIS servers that need to resolve Oracle Database network service names. Consult your NIS documentation for specifics. To complete this task, add the `tnsnames` map to the existing NIS maps, and then verify that the `tnsnames` map has been installed properly.
  1. Create a `tnsnames.ora` file, as specified in "[Configuring the Local Naming Method](#)".

 **Note:**

Keep a copy of the `tnsnames.ora` file, preferably in the `ORACLE_BASE_HOME/network/admin` directory. You may need to use this file again later to load network service names into the NIS map.

2. Convert the contents of the `tnsnames.ora` file to a `tnsnames` map using the `tns2nis` program using a command similar to the following:

```
tns2nis tnsnames.ora
```

The `tns2nis` program reads the `tnsnames.ora` file from the current directory. If the `tnsnames.ora` file is not located in the current directory, then use a full path name to specify its location, such as `/etc/tnsnames.ora` or `ORACLE_BASE_HOME/network/admin/tnsnames.ora`.

The `tnsnames` map is then written into the current working directory.

 **Note:**

The `tns2nis` program is supplied with NIS external naming.

3. Copy the `tnsnames` map to the NIS server.
4. Install the `tnsnames` map using `makedbm`, which is an NIS program.

 **Note:**

This step must be performed by the person in charge of NIS administration.

The `makedbm` program converts the `tnsnames` map into two files that the NIS server can read. The location of these files is operating system specific.

For example, to generate and install a `tnsnames` map on Linux, as the `root` user, enter the following at the command line:

```
# makedbm tnsnames /var/yp/'domainname'/tnsnames
```

 **See Also:**

Oracle operating system-specific documentation for details

5. Verify `tnsnames` has been installed properly using the following command:

```
ypmatch net_service_name tnsnames
```

For example, you might enter the following command:

```
ypmatch example.com tnsnames
```

This returns the length of the address in characters, followed by the address such as the following:

```
99 (description=(address=(protocol=tcp) (host=sales)(port=1999)))  
    (connect_data=(service_name=dirprod)))
```

- **Task 2: Configure the Clients**

To configure clients, configure NIS as the first method specified in the `NAMES.DIRECTORY_PATH` parameter in the `sqlnet.ora` file. This parameter specifies the order of naming methods Oracle Net can use to resolve connect identifiers to connect descriptors.

1. Start Oracle Net Manager.



**See Also:**

["Using Oracle Net Manager to Configure Oracle Net Services"](#)

2. In the navigator pane, select **Profile** from the Local menu.
3. From the list in the right pane, select **Naming**.
4. Click the **Methods** tab.
5. From the Available Methods list, select **NIS**, and then click the right-arrow button.
6. In the Selected Methods list, select **NIS**, and then use the **Promote** button to move the selection to the top of the list.
7. Select **Save Network Configuration** from the File menu.  
The `sqlnet.ora` file updates with the `NAMES.DIRECTORY_PATH` parameter, listing `nis` first:

```
NAMES.DIRECTORY_PATH=(nis, hostname, tnsnames)
```

# 9

## Configuring and Administering Oracle Net Listener

Oracle Net Listener is a separate process that runs on the database server. It receives incoming client connection requests and manages the traffic of these requests to the database server. Find out how to configure the listener to accept client connections.

### Note:

In Oracle Database 12c release 2 (12.2), the listener password feature is no longer supported. This does not cause a loss of security because authentication is enforced through local operating system authentication.

- [Overview of Oracle Net Listener](#)
- [Configuring Dynamic Service Registration](#)
- [Configuring Oracle Net Listener During Installation](#)
- [Customizing Oracle Net Listener Configuration](#)
- [Administering the Listener](#)
- [Understanding Listener Redirects](#)

### See Also:

- [Identifying and Accessing the Database](#) for a description of how the listener is used during an initial connection request
- [Understanding the Communication Layers](#) for an architectural overview of the listener

### 9.1 Overview of Oracle Net Listener

#### Note:

The release of the listener must be the same as or later than the latest release of all Oracle databases being serviced through the listener.

A listener is configured with one or more listening protocol addresses, information about supported services, and parameters that control its runtime behavior. The listener configuration is stored in a configuration file named `listener.ora`.

Because the configuration parameters have default values, it is possible to start and use a listener with no configuration. This default listener has a name of `LISTENER`, supports no services on startup, and listens on the following TCP/IP protocol address:

```
(ADDRESS=(PROTOCOL=tcp)(HOST=host_name)(PORT=1521))
```

The listener forwards client requests to supported services. These services are dynamically registered with the listener. This dynamic registration feature is called service registration. The registration is performed by the Listener Registration (LREG) process. Dynamic service registration does not require any manual configuration in the `listener.ora` file.

Service registration offers the following benefits:

- **Connect-time failover**  
Because the listener always monitors the state of the instances, service registration facilitates automatic failover of a client connect request to a different instance if one instance is down.
- **Connection load balancing**  
Service registration enables the listener to forward client connect requests to the least-loaded instance and dispatcher or dedicated server. Service registration balances the load across the service handlers and nodes.
- **High-availability for Oracle Real Application Clusters and Oracle Data Guard**



#### See Also:

- ["Understanding Oracle Net Architecture "](#)
- ["Configuring Dynamic Service Registration"](#)
- ["About the Address List Parameters"](#)
- ["Understanding Connection Load Balancing"](#)

## 9.2 Configuring Dynamic Service Registration

Service registration allows processes, such as an Oracle database, to identify their available services to the listener, which then acts as a port mapper for those services. The listener uses the dynamic service information about the database and instance received through service registration.

Dynamic service registration is configured in the database initialization file. It does not require any configuration in the `listener.ora` file. However, listener configuration must be set to listen on the ports named in the database initialization file, and must not have parameters set that prevent automatic registration, such as `COST` parameters.

This section contains the following configuration topics related to service registration:

- [Setting Initialization Parameters for Service Registration](#)
- [Registering Information with a Local Listener](#)
- [Registering Information with a Remote Listener](#)
- [Registering Information with All Listeners in a Network](#)
- [Configuring a Naming Method](#)

## 9.2.1 Setting Initialization Parameters for Service Registration

To ensure service registration works properly, the initialization parameter file should contain the following parameters:

- `SERVICE_NAMES` for the database service name
- `INSTANCE_NAME` for the instance name
- `LOCAL_LISTENER` for the local listener
- `REMOTE_LISTENER` for the remote listener, if any
- `FORWARD_LISTENER` for the forward listener

For example:

```
SERVICE_NAMES=sales.us.example.com  
INSTANCE_NAME=sales
```

The value for the `SERVICE_NAMES` parameter defaults to the global database name, a name comprising the `DB_NAME` and `DB_DOMAIN` parameters in the initialization parameter file. The value for the `INSTANCE_NAME` parameter defaults to the Oracle system identifier (SID).

### Note:

Starting with Oracle Database 19c, customer use of the `SERVICE_NAMES` parameter is deprecated. To manage your services, Oracle recommends that you use the `SRVCTL` or `GDSCTL` command line utilities, or the `DBMS_SERVICE` package.

### See Also:

*Oracle Database Reference* for additional information about the `SERVICE_NAMES` and `INSTANCE_NAME` parameters

## 9.2.2 Registering Information with a Local Listener

By default, the LREG process registers service information with its local listener on the default local address of TCP/IP, port 1521. If the listener configuration is synchronized with the database configuration, then LREG can register service information with a nondefault local listener or a remote listener on another node. Synchronization occurs when the protocol address of the listener is specified in the `listener.ora` file and the location of the listener is specified in the initialization parameter file.

To have the LREG process register with a local listener that does not use TCP/IP, port 1521, configure the LOCAL\_LISTENER parameter in the initialization parameter file to locate the local listener.

For a shared server environment, you can use the LISTENER attribute of the DISPATCHERS parameter in the initialization parameter file to register the dispatchers with a nondefault local listener. Because the LOCAL\_LISTENER parameter and the LISTENER attribute enable LREG to register dispatcher information with the listener, it is not necessary to specify both the parameter and the attribute if the listener values are the same.

LOCAL\_LISTENER is a comma-delimited list parameter. If a comma appears in the string, then the entire string must be enclosed in double quotation marks. Set the LOCAL\_LISTENER parameter as follows:

```
ALTER SYSTEM SET LOCAL_LISTENER=["]listener_address["][,...];
```

For example, if the listener address "ab,cd" is entered, then it resolves to one listener address. If the address is entered as ab,cd, then it resolves to two listener addresses, ab and cd.

For shared server connections, set the LISTENER attribute as follows:

```
ALTER SYSTEM SET DISPATCHERS="(PROTOCOL=tcp)(LISTENER=listener_address)";
```

In the preceding command, *listener\_address* is resolved to the listener protocol addresses through a naming method, such as a *tnsnames.ora* file on the database server.

 **Note:**

- To dynamically update the LOCAL\_LISTENER parameter, use the SQL statement ALTER SYSTEM as follows:

```
ALTER SYSTEM SET LOCAL_LISTENER=["]listener_address["][,...]
```

If you set the parameter to null using the following statement, then the default local address of TCP/IP, port 1521 is assumed:

```
ALTER SYSTEM SET LOCAL_LISTENER=''
```

- The LISTENER attribute overrides the LOCAL\_LISTENER parameter. As a result, the SQL statement ALTER SYSTEM SET LOCAL\_LISTENER does not affect the setting of this attribute.

In [Example 9-1](#), a database resides on host *sales1-server*. The listener on this host is named *listener\_sales1* and is configured to listen on port 1421 instead of port 1521.

### Example 9-1 Registering a Local Listener in a Dedicated Server Environment

1. On the host where the local listener resides, configure the *listener.ora* file with the protocol address of the listener using Oracle Net Manager.
2. On the database, set the LOCAL\_LISTENER parameter in the database initialization parameter file to the alias of the local listener. For example:

```
ALTER SYSTEM SET LOCAL_LISTENER=listener_sales1;
```

If the database is configured for shared server connections, then you could set the `LISTENER` attribute as follows:

```
ALTER SYSTEM SET DISPATCHERS="(PROTOCOL=tcp)(LISTENER=listener_sales1)";
```

3. Resolve the listener name alias for the `LOCAL_LISTENER` setting through a `tnsnames.ora` file on the database host using a text editor, as follows:

```
listener_sales1=  
(DESCRIPTION =  
  (ADDRESS = (PROTOCOL=tcp)(HOST=sales-server)(PORT=1421)))
```

#### Note:

- If you are registering a local listener and use Oracle Connection Manager, then do not include `(DESCRIPTION =` or its closing parenthesis.
- A network service name entry can be created for the protocol address without the `CONNECT_DATA` section of the connect descriptor.

#### See Also:

- See *Oracle Database SQL Reference* for additional information about the `ALTER SYSTEM` statement.
- ["Configuring Listening Protocol Addresses"](#)
- ["Configuring a Naming Method"](#)

## 9.2.3 Registering Information with a Remote Listener

A **remote listener** is a listener residing on one computer that redirects connections to a database instance on another computer. Remote listeners are typically used in an Oracle Real Application Clusters (Oracle RAC) environment. You can configure registration to remote listeners, such as with Oracle RAC, for dedicated or shared server environments.

In a dedicated server environment, you must enable the LREG background process to register with a remote listener. You do this by configuring the `REMOTE_LISTENER` parameter, which is a comma-delimited list parameter, in the initialization parameter file. The syntax of `REMOTE_LISTENER` is as follows:

```
ALTER SYSTEM SET REMOTE_LISTENER=["]listener_address["][,...];
```

In the preceding command, `listener_address` is resolved to the listener protocol addresses through a naming method such as a `tnsnames.ora` file on the database host. If a comma appears in the listener address, then the entire string must be enclosed in quotation marks.



In a shared server environment, you can use the same registration technique as for a dedicated server environment. Alternatively, you can set the `LISTENER` attribute of the `DISPATCHERS` parameter in the initialization parameter file to register the dispatchers with any listener. The syntax of the `LISTENER` attribute is as follows:

```
ALTER SYSTEM SET DISPATCHERS="(PROTOCOL=tcp)(LISTENER=listener_address)";
```

 **Note:**

The `LISTENER` attribute overrides the `REMOTE_LISTENER` initialization parameter. Because the `REMOTE_LISTENER` initialization parameter and the `LISTENER` attribute enable LREG to register dispatcher information with the listener, you do not need specify both the parameter and the attribute if the listener values are the same.

For example, assume that a remote listener named `listener-sales2` listens on port 1521 on host `sales2-server`, and a database resides on host `sales1-server`. You want the listener on `sales2-server` to redirect connection requests to this database. [Figure 9-1](#) illustrates this scenario.

**Figure 9-1 Remote Listener**

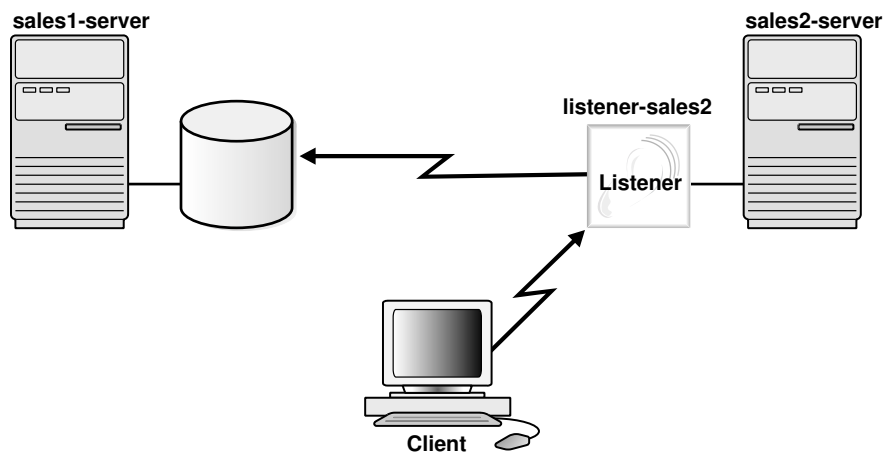

 **See Also:**

*Oracle Database SQL Reference* for additional information about the `ALTER SYSTEM SET` statement

[Example 9-2](#) shows how to register a remote listener in a dedicated server environment. In the example, the remote listener is `sales2-server`.

**Example 9-2 Registering a Remote Listener in a Dedicated Server Environment**

1. On the host where the remote listener resides, use Oracle Net Manager to configure the `listener.ora` file with the protocol addresses of the remote listener.

2. On the database to which you want requests to be redirected, set the `REMOTE_LISTENER` parameter in the database initialization parameter file to the alias of the remote listener, for example:

```
ALTER SYSTEM SET REMOTE_LISTENER=listener_sales2;
```

For shared server connections, set the `DISPATCHER` parameter in the initialization file for the database on host `sales1-server` as follows:

```
ALTER SYSTEM SET DISPATCHERS="(PROTOCOL=tcp)(LISTENER=listeners_sales2)";
```

#### Note:

To statically update the `REMOTE_LISTENER` initialization parameter, use a text editor to de-register the information with the remote listener which it had previously registered information.

3. Resolve the listener name alias for the remote listener through a `tnsnames.ora` file on the database host. For example:

```
listener_sales2=
(DESCRIPTION=
  (ADDRESS=(PROTOCOL=tcp)(HOST=sales2-server)(PORT=1521)))
```

#### See Also:

- ["Configuring a Naming Method"](#)
- ["Configuring Listening Protocol Addresses"](#)
- *Oracle Database Reference* to learn about the `REMOTE_LISTENER` initialization parameter
- *Oracle Real Application Clusters Administration and Deployment Guide* to learn how to configure remote listeners (also called SCAN listeners) in an Oracle RAC environment

## 9.2.4 Registering Information with All Listeners in a Network

A network may contain multiple local and remote listeners. By default, all listeners are cross-registered with each other. By specifying a set of listeners in the `LISTENER_NETWORKS` initialization parameter, you can designate a subset of local listeners with a subset of remote listeners. Listeners specified by the `LISTENER_NETWORKS` parameter should not be specified by the `LOCAL_LISTENER` and `REMOTE_LISTENER` parameters.

The syntax of `LISTENER_NETWORKS` parameter is as follows:

```
LISTENER_NETWORKS = '((NAME=network_name)
  (LOCAL_LISTENER=["]listener_address[,...]["])
  [(REMOTE_LISTENER=["]listener_address[,...]["])]))'
```

In the preceding syntax, *listener\_address* is resolved according to the rules of LOCAL\_LISTENER and REMOTE\_LISTENER.

### Example 9-3 Using Two Networks on a Subnet

Assume there are two distinct networks, *network1* and *network2*. On *network1*, there is a local listener named *local1*, and a remote listener named *remotel*. On *network2*, there is a local listener named *local2*, and a remote listener named *remote2*. The following syntax sets up registration so that the listeners only redirect connections to listeners on the same network.

```
LISTENER_NETWORKS =
  '((NAME=network1) (LOCAL_LISTENER=local1) (REMOTE_LISTENER=remotel))',
  '((NAME=network2) (LOCAL_LISTENER=local2) (REMOTE_LISTENER=remote2))'
```

In the preceding example, *local1* is registered only with *remotel*, and *remotel* only redirects connections to *local1*. The listener *local2* is registered only with *remote2*, and *remote2* only redirects connections to *local2*.

### Example 9-4 Configuring Multiple Listeners

Assume that multiple listeners are listening on a network named *sales-network*. The following conditions are true:

- A database configured for dedicated server connections resides on host *sales1-server*. It is the only database in the network.
- A local listener resides on *sales1-server* and listens on nondefault port 1421.
- A remote listener named *listener\_sales2* resides on host *sales2-server* and listens on port 1521.
- Another remote listener named *listener\_sales3* resides on host *sales3-server* and listens on port 1521.

The following procedure describes how to register information with all listeners in a dedicated server environment:

1. On the hosts where the remote listeners reside (in this example, *sales2-server* and *sales3-server*), configure the *listener.ora* file with the protocol addresses of the remote listener.
2. On the database to which you want requests to be redirected, set the REMOTE\_LISTENER parameter in the database initialization parameter file to the alias of the remote listeners, and the LOCAL\_LISTENER parameter to the alias of the local listener.

Set the parameters in the initialization file for the database on host *sales1-server* as follows:

```
REMOTE_LISTENER="listener_sales2,listener_sales3"
LOCAL_LISTENER=listener_sales1
```

3. Resolve the listener name alias for the LOCAL\_LISTENER and REMOTE\_LISTENER setting through a *tnsnames.ora* file on the database host.

In the *tnsnames.ora* on *sales1-server*, resolve the local listener alias and remote listener aliases *listener\_sales1*, *listener\_sales2*, and *listener\_sales3* as follows:

```
listener_sales1=
  (DESCRIPTION=
    (ADDRESS=(PROTOCOL=TCP)(HOST=sales1-server)(PORT=1421)))

listener_sales2=
```

```
(DESCRIPTION=
  (ADDRESS=(PROTOCOL=TCP)(HOST=sales2-server)(PORT=1521)))

listener_sales3=
  (DESCRIPTION=
    (ADDRESS=(PROTOCOL=TCP)(HOST=sales3-server)(PORT=1521)))

listener_sales_local=
  (DESCRIPTION=
    (ADDRESS=(PROTOCOL=tcp)(HOST=sales1-server)(PORT=1421)))

listener_sales_remote=
  (DESCRIPTION_LIST=
    (DESCRIPTION=(ADDRESS=(PROTOCOL=tcp)(HOST=sales2-server)(PORT=1521)))
    (DESCRIPTION=(ADDRESS=(PROTOCOL=tcp)(HOST=sales3-server)(PORT=1521))))
```

 **See Also:**

- ["Configuring a Naming Method"](#)
- ["Configuring Listening Protocol Addresses"](#)
- *Oracle Database Reference* for additional information about the REMOTE\_LISTENER initialization parameter

## 9.2.5 Configuring a Naming Method

The listener name alias specified for the LOCAL\_LISTENER or REMOTE\_LISTENER initialization parameters, or LISTENER attribute can be resolved using a tnsnames.ora file. For example, a listener can be defined in the init.ora file as the following:

```
LOCAL_LISTENER = (ADDRESS=(PROTOCOL=tcp)(HOST=sales-server)(PORT=1421))
```

To use an alias for the listener, it can be defined in the init.ora and the tnsnames.ora files as follows:

- In the init.ora file:

```
LOCAL_LISTENER = listener_sales1
```

- In the tnsnames.ora file:

```
listener_sales1 = (ADDRESS=(PROTOCOL=tcp)(HOST=sales-server)(PORT=1421))
```

The CONNECT\_DATA information should not be included in the network service entry in the tnsnames.ora file. However, Oracle Enterprise Manager Cloud Control and Oracle Net Manager cannot configure a tnsnames.ora file without the CONNECT\_DATA information. To use listener name aliases, Oracle recommends you modify the tnsnames.ora file using a text editor.

 **Note:**

- Multiple addresses are supported, but connect-time failover and client load balancing features are not supported.
- If the listener alias specified in the `LOCAL_LISTENER` parameter is invalid or not resolved, then the LREG process does not allow the database to start. The following errors occur:

```
ORA-00119: invalid specification for system parameter
LOCAL_LISTENER
ORA-00132: syntax error or unresolved network name '%s'
```

 **See Also:**

[Enabling Advanced Features of Oracle Net Services](#) for additional information about multiple address configuration

## 9.3 Configuring Oracle Net Listener During Installation

Oracle Universal Installer launches Oracle Net Configuration Assistant during installation. Oracle Net Configuration Assistant configures the listening protocol address and service information for Oracle Database.

During an Enterprise Edition or Standard Edition installation on the database server, Oracle Net Configuration Assistant automatically configures a listener with a name of `LISTENER` that has a TCP/IP listening protocol address for Oracle Database. During a Custom installation, Oracle Net Configuration Assistant prompts for the listener name and protocol address.

A listening IPC protocol address for external procedure calls is automatically configured, regardless of the installation type. Oracle Net Configuration Assistant also automatically configures service information for the external procedures in the `listener.ora` file.

If you are using the IPC protocol, then you can improve performance by specifying the maximum number of concurrent IPC connection requests to match your expected connection requests.

## 9.4 Customizing Oracle Net Listener Configuration

If the default or installed configuration is not adequate for a particular environment, then you can use Oracle Net Manager to customize the `listener.ora` configuration.

- [Configuring Listening Protocol Addresses](#)
- [Handling Large Volumes of Concurrent Connection Requests](#)
- [Managing Oracle Net Listener Security](#)

## 9.4.1 Configuring Listening Protocol Addresses

Oracle Enterprise Manager Cloud Control and Oracle Net Manager can be used to configure protocol support for the listener.

The Oracle Net Listener endpoint address configuration accepts both IPv6 addresses and host names that resolve to IPv6 addresses, as explained in "[IPv6 Interface and Address Configurations](#)". This technique can create listening endpoints that service IPv6 clients.

- [Configuring Listening Protocol Addresses Using Oracle Enterprise Manager Cloud Control](#)
- [Configuring Listening Protocol Addresses Using Oracle Net Manager](#)

### 9.4.1.1 Configuring Listening Protocol Addresses Using Oracle Enterprise Manager Cloud Control

The following procedure describes how to configure protocol addresses for the listener using Oracle Enterprise Manager Cloud Control:

1. Access the Net Services Administration page in Oracle Enterprise Manager Cloud Control.



#### See Also:

["Accessing the Net Services Administration Page"](#)

2. Click **Edit**. You may be prompted to log in to the database server.  
The Edit Listener page appears.
3. In the Addresses section, configure protocol support:
  - a. Click **Add**.  
The Add Address page appears.
  - b. From the Protocol list, select the protocol on which the listener is configured to listen.  
  
For TCP/IP, if the computer has more than one IP address and you want the listener to listen on all available IP addresses, then select **TCP/IP** or **TCP/IP with SSL** and enter the host name of the computer in the Host field.
  - c. In Port, enter the port number.  
  
When configuring the listener to listen on TCP/IP, enter the default port of 1521. Otherwise, you must configure the LOCAL\_LISTENER parameter in the initialization parameter file and the non-default port number must be specified for use by any naming method.
  - d. In Host, enter the host address.
  - e. (Optional) In the Advanced Parameters section, specify the I/O buffer space limit for send and receive operations of sessions in the Total Send Buffer Size and Total Receive Buffer Size fields.

- f. Click **OK**.  
The protocol address is added to the Addresses section.
4. Repeat Step 3 for additional protocols.

#### See Also:

- *Oracle Database Net Services Reference* for additional information about protocol addresses and TCP/IP privileged ports
- "[Configuring I/O Buffer Space](#)" for additional information

### 9.4.1.2 Configuring Listening Protocol Addresses Using Oracle Net Manager

The following procedure describes how to configure protocol addresses for the listener using Oracle Net Manager:

1. Start Oracle Net Manager.

#### See Also:

["Using Oracle Net Manager to Configure Oracle Net Services"](#)

2. In the navigator pane, expand **Local**, and then select **Listeners**.
3. Select the listener.
4. From the list in the right pane, select **Listener Locations**.
5. Select the protocol from the Protocol list.
6. Enter the host name for the listener in the Host field.
7. Enter the port number in the Port field.
8. If you want to set send and receive buffer sizes, then click **Show Advanced**, and then enter the sizes in the appropriate fields.
9. Select **Save Network Configuration** from the File menu to save the changes.

### 9.4.2 Handling Large Volumes of Concurrent Connection Requests

If you expect the listener to handle large volumes of concurrent connection requests, then you can specify a listener queue size for its TCP/IP or IPC listening endpoints.

To specify the listener queue size, do the following:

- Specify the `QUEUESIZE` parameter at the end of the protocol address with its value set to the expected number of concurrent requests.

The following example sets the queue size to 20:

```
LISTENER=
  (DESCRIPTION=
    (ADDRESS=(PROTOCOL=tcp)(HOST=sales-server)(PORT=1521)(QUEUESIZE=20)))
```

 **Note:**

The default number of concurrent connection requests is operating system-specific. The defaults for TCP/IP on the Linux operating system and Microsoft Windows follow:

- Linux operating system: 128
- Microsoft Windows XP Professional SP2: 10
- Microsoft Windows Server Enterprise Edition: 200

## 9.4.3 Managing Oracle Net Listener Security

By default, Oracle Net Listener permits only local administration for security reasons. As a policy, the listener can be administered only by the user who started it. This is enforced through local operating system authentication. For example, if `user1` starts the listener, then only `user1` can administer it. Any other user trying to administer the listener gets an error. The super user is the only exception.

Oracle recommends that you perform listener administration in the default mode (secure by means of local operating system authentication), and access the system remotely using a remote login. Oracle Enterprise Manager Cloud Control can also be used for remote administration.

Connections coming to listener on an IP (TCP, TCPS, and SDP) based endpoint with firewall functionality enabled, go through service ACL validation. The listener after receiving the service name validates the connection IP with ACL list.

A new attribute `FIREWALL` is added in the endpoint to enable firewall functionality.

```
(ADDRESS=(PROTOCOL=TCP)(HOST=)(PORT=1521)(FIREWALL=ON))
```

The `FIREWALL` parameter can be configured as follows:

- `(FIREWALL=ON)` is explicitly set in endpoint – This enables strict ACL validation (whitelist-based approach) of all connections coming on this endpoint. If no ACLs are configured for a service, all connections are rejected for that service.
- `FIREWALL` is not set in endpoint – This implies relaxed validation. If ACL is configured for a service, validation is done for that service. In the absence of ACLs, no validation is done and all connections for that service are accepted.
- `(FIREWALL=OFF)` is set in endpoint – No validation is done and all connections are accepted from this endpoint.

The server also enforces the ACLs.

- [Specifying Valid Nodes and Subnets](#)

### 9.4.3.1 Specifying Valid Nodes and Subnets

Listener registration should be restricted to valid nodes and subnets. Valid nodes and subnets can be specified for registration, and excluded nodes can also be specified for registration. By default, every incoming connection for registration at the listener is subjected to IP-based filtering. A connection is only allowed if it originates from the



local machine. If the other nodes and subnets are specified for registration, then the local machine and the ones specified are allowed. The following parameters can be set in the `listener.ora` file to specify valid and restricted nodes and subnets:

- `REGISTRATION_INVITED_NODES_listener_name`: Specifies the nodes that can register with the listener. The list can be host names, or CIDR notation for IPv4 and IPv6 addresses. Presence of a host name in the list results in all IP addresses mapped to it being invited.
- `REGISTRATION_EXCLUDED_NODES_listener_name`: Specifies the nodes that cannot register with the listener. Nodes not specified on the list are allowed to register with the listener.

If both parameters are set, then `REGISTRATION_EXCLUDED_NODES_listener_name` is ignored.

#### See Also:

*Oracle Database Net Services Reference* for additional information about valid node registration checking.

## 9.5 Administering the Listener

After the listener is configured, you can administer it with the Listener Control utility, Oracle Enterprise Manager Cloud Control, and the Server Control utility (SRVCTL). This section describes some of the administrative tasks for the listener. It contains the following topics:

- [Starting and Stopping a Listener](#)
- [Managing a Listener in an Oracle Restart Configuration](#)
- [Determining the Current Status of a Listener](#)
- [Monitoring Services of a Listener](#)
- [Monitoring Listener Log Files](#)

#### See Also:

- *Oracle Database Net Services Reference* for a complete list of the Listener Control utility commands
- Oracle Enterprise Manager Cloud Control online help

### 9.5.1 Starting and Stopping a Listener

To stop or start a listener, use one of the following methods:

 **Note:**

You can configure the listener to start automatically whenever the computer is running or is restarted. Refer to "[Managing a Listener in an Oracle Restart Configuration](#)" for additional information.

- [Starting or Stopping a Listener Using the Listener Control Utility](#)
- [Starting or Stopping a Listener Using Oracle Enterprise Manager Cloud Control](#)

### 9.5.1.1 Starting or Stopping a Listener Using the Listener Control Utility

To start the listener from the command line, enter:

```
lsnrctl START [listener_name]
```

In the preceding command, *listener\_name* is the name of the listener defined in the `listener.ora` file. It is not necessary to identify the listener if you are using the default listener name `LISTENER`.

In addition to starting the listener, the Listener Control utility verifies connectivity to the listener.

To stop a listener from the command line, enter:

```
lsnrctl STOP [listener_name]
```

In the preceding command, *listener\_name* is the name of the listener defined in the `listener.ora` file. It is not necessary to identify the listener if you are using the default listener name `LISTENER`.

 **Note:**

When using the Oracle Home User, the listener control utility prompts for a password on Microsoft Windows systems. This password is the operating system password for the Oracle Home User. The password prompt is displayed only if the listener service does not exist and needs to be created as part of starting the listener.

 **See Also:**

*Oracle Database Platform Guide for Microsoft Windows* for information about the Oracle Home User

## 9.5.1.2 Starting or Stopping a Listener Using Oracle Enterprise Manager Cloud Control

The following procedure describes how to start or stop a listener from Oracle Enterprise Manager Cloud Control:

1. Access the Net Services Administration page in Oracle Enterprise Manager Cloud Control.



### See Also:

["Using Oracle Enterprise Manager Cloud Control to Configure Oracle Net Services"](#)

2. Select **Listeners** from the Administer list, and then select the Oracle home that contains the location of the configuration files.
3. Click **Go**.  
The Listeners page appears.
4. Select the listener.
5. From the Actions list, select **Start/Stop**.
6. Click **Go**.  
The Start/Stop page appears.
7. Depending on the current status of the selected listener, select either **Stop** or **Start**, and then click **OK**.

## 9.5.2 Managing a Listener in an Oracle Restart Configuration

The Oracle Restart feature enhances availability for the processes and applications in a single-instance database environment. The Oracle Restart agents monitor the health of added components by periodically running check operations and restarting the components when necessary.

You can add the listener as a component to the Oracle Restart configuration. The listener is then automatically started by Oracle Restart when it fails or is not running. For example, if you restart the database instance after a planned restart of the computer, then Oracle Restart restarts the listener. Server Control (SRVCTL) is a command-line interface that you can use to manage listeners in an Oracle Restart configuration.

- [Viewing Configured Listeners Using the SRVCTL Utility](#)
- [Adding or Removing a Listener Using the SRVCTL Utility](#)
- [Starting or Stopping a Listener Using the SRVCTL Utility](#)

### 9.5.2.1 Viewing Configured Listeners Using the SRVCTL Utility

To view all configured listeners, use the following command:

```
% srvctl config listener
```

 **See Also:**

*Oracle Database Administrator's Guide* to learn how to configure Oracle Restart and for SRVCTL syntax and semantics

### 9.5.2.2 Adding or Removing a Listener Using the SRVCTL Utility

Adding a listener as an entry to the grid infrastructure enables the agent to monitor the listener. Similarly, removing a listener removes as an entry. Use the `srvctl` command at the operating system command line as follows:

- To add the listener, enter `srvctl add listener`

The following command adds an entry for `listener_sales1` to the grid infrastructure:

```
% srvctl add listener -listener listener_sales1
```

- To remove the listener, enter `srvctl remove listener`

The following command removes the entry for `listener_sales1` from the grid infrastructure:

```
% srvctl remove listener -listener listener_sales1
```

### 9.5.2.3 Starting or Stopping a Listener Using the SRVCTL Utility

The SRVCTL utility enables you to stop and start the listener. If you do not specify the `-listener` parameter, then the SRVCTL utility starts and stops the default listener.

- To start a listener, enter `srvctl start listener`

In the following example, the first command starts the default listener, and the second command starts `listener1` and `listener2`:

```
% srvctl start listener
% srvctl start listener -listener listener1,listener2
```

- To stop a listener, enter `srvctl stop listener`

In the following example, the first command stops the default listener, and the second command stops `listener1` and `listener2`:

```
% srvctl stop listener
% srvctl stop listener -listener listener1,listener2
```

## 9.5.3 Determining the Current Status of a Listener

To show the current status of a listener, use either the `STATUS` command of the Listener Control utility or Oracle Enterprise Manager Cloud Control. The status output provides basic status information about a listener, a summary of listener configuration settings, the listening protocol addresses, and a summary of services registered with the listener.

- [Showing Status Using Listener Control](#)
- [Showing Status Using Oracle Enterprise Manager Cloud Control](#)

### 9.5.3.1 Showing Status Using Listener Control

To show the status the listener from the command line, enter the following command:

```
lsnrctl STATUS [listener_name]
```

In the preceding command, *listener\_name* is the name of the listener defined in the listener.ora file. It is not necessary to identify the listener if you are using the default listener name LISTENER.

[Example 9-5](#) shows example output of the STATUS command.

#### Example 9-5 Listener Control Utility's STATUS Command Output

```
Connecting to (DESCRIPTION=(ADDRESS=(PROTOCOL=ipc)(KEY=net)))
STATUS of the LISTENER
-----
Alias                               LISTENER
Version                             TNSLSNR for Linux: Version 18.0.0.0.0
Start Date                          15-MAY-2017 20:22:00
Uptime                              65 days 10 hr. 5 min. 22 sec
Trace Level                          support
Security                             OFF
Listener Parameter File              /oracle/admin/listener.ora
Listener Log File                    /oracle/network/log/listener.log
Listener Trace File                  /oracle/network/trace/listener.trc
Listening Endpoints Summary...
  (DESCRIPTION=(ADDRESS=(PROTOCOL=ipc)(KEY=net)))
  (DESCRIPTION=(ADDRESS=(PROTOCOL=tcp)(HOST=sales-server)(PORT=1521)))
  (DESCRIPTION=(ADDRESS=(PROTOCOL=tcps)(HOST=sales-server)(PORT=2484)))

Services Summary...
Service "sales.us.example.com" has 1 instance(s).
  Instance "sales", status READY, has 3 handler(s) for this service...
Service "hr.us.example.com" has 1 instance(s).
  Instance "hr", status READY, has 2 handler(s) for this service...
The command completed successfully
```

The STATUS command output includes the sections described in [Table 9-1](#).

**Table 9-1 Listener Control Utility STATUS Command**

Output Section	Description
STATUS of the LISTENER	Status of the listener, including the following: <ul style="list-style-type: none"> <li>Alias of the listener</li> <li>Version of listener</li> <li>Start time and up time</li> <li>Trace level</li> <li>listener.ora file being used</li> <li>Logging and tracing configuration settings</li> </ul>
Listening Endpoints Summary	The protocol addresses the listener is configured to listen on.
Services Summary	A summary of the services registered with the listener and the service handlers allocated to each service.
Service	The registered service.

**Table 9-1 (Cont.) Listener Control Utility STATUS Command**

Output Section	Description
Instance	<p>The name of the instance associated with the service.</p> <p>The status field indicates if the instance can accept connections.</p> <ul style="list-style-type: none"> <li>• <b>READY</b> means that the instance can accept connections.</li> <li>• <b>BLOCKED</b> means that the instance cannot accept connections.</li> <li>• <b>READY/SECONDARY</b> means that this is a secondary instance in an Oracle Real Application Clusters primary/secondary configuration, and is ready to accept connections.</li> <li>• <b>RESTRICTED</b> means the instance is in restricted mode. The listener blocks all connections to this instance.</li> <li>• <b>UNKNOWN</b> means that the instance is registered statically in the <code>listener.ora</code> file rather than dynamically with service registration. Therefore, the status is not known.</li> </ul>

### 9.5.3.2 Showing Status Using Oracle Enterprise Manager Cloud Control

The following procedure describes how to show the status of a listener using Oracle Enterprise Manager Cloud Control:

1. Access the Net Services Administration page in Oracle Enterprise Manager Cloud Control.



#### See Also:

["Using Oracle Enterprise Manager Cloud Control to Configure Oracle Net Services"](#)

2. Select **Listeners** from the Administer list, and then select the Oracle home that contains the location of the configuration files.
3. Click **Go**. You may be prompted to log in to the database server.  
The Listeners page appears.
4. Select a listener.
5. From the Actions list, select **Show Listener Control Status**.
6. Click **Go**.  
The Listener Control Status page appears.
7. After viewing the content, click the listener link at the top of the page.

### 9.5.4 Monitoring Services of a Listener

The `SERVICES` command of the Listener Control utility provides detailed information about the services and instances registered with a listener and the service handlers allocated to each instance. To show information about the services and instances from the command line, enter:

```
lsnrctl SERVICES [listener_name]
```

[Example 9-6](#) shows example output of the SERVICES command.

### Example 9-6 Listener Control Utility's SERVICES Command Output

```
Connecting to (DESCRIPTION=(ADDRESS=(PROTOCOL=ipc)(KEY=net)))
Services Summary...
Service "sales.us.example.com" has 1 instance(s).
  Instance "sales", status READY, has 3 handler(s) for this service...
  Handler(s):
    "DEDICATED" established:0 refused:0 state:ready
      LOCAL SERVER
    "D000" established:0 refused:0 current:0 max:10000 state:ready
      DISPATCHER <machine: sales-server, pid: 1689>
      (ADDRESS=(PROTOCOL=tcp)(HOST=sales-server)(PORT=52414))
    "D001" established:0 refused:0 current:0 max:10000 state:ready
      DISPATCHER <machine: sales-server, pid: 1691>
      (ADDRESS=(PROTOCOL=tcp)(HOST=sales-server)(PORT=52415))
Service "hr.us.example.com" has 1 instance(s).
  Instance "hr", status READY, has 2 handler(s) for this service...
  Handler(s):
    "DEDICATED" established:0 refused:0 state:ready
      LOCAL SERVER
    "D000" established:0 refused:0 current:0 max:10000 state:ready
      DISPATCHER <machine: sales-server, pid: 11326>
      (ADDRESS=(PROTOCOL=tcp)(HOST=sales-server)(PORT=58361))
The command completed successfully
```

This output shows that two database services, `sales.us.example.com` and `hr.us.example.com`, are registered with the listener.

Client connection requests to `sales.us.example.com` are handled by two dispatchers named `D000` and `D001` and one dedicated server. All handlers have a status of `ready`, indicating that they are ready to receive connections.

Client connection requests to `hr.us.example.com` are handled by one dispatcher named `D001` and one dedicated server.

The SERVICES command generates output with the following information as described in [Table 9-2](#).

**Table 9-2 Listener Control Utility SERVICES Command**

Output Section	Description
Services	The registered service.
Instance	<p>The name of the instance associated with the service</p> <p>The status field indicates if the instance can accept connections.</p> <ul style="list-style-type: none"> <li>• <code>READY</code> means the instance can accept connections.</li> <li>• <code>BLOCKED</code> means the instance cannot accept connections.</li> <li>• <code>READY/SECONDARY</code> means the is a secondary instance in an Oracle Real Application Clusters primary/secondary configuration and is ready to accept connections.</li> <li>• <code>RESTRICTED</code> means the instance is in restricted mode. The listener blocks all connections to this instance.</li> <li>• <code>UNKNOWN</code> means the instance is registered statically in the <code>listener.ora</code> file rather than dynamically with service registration. Therefore, the status is non known.</li> </ul>

**Table 9-2 (Cont.) Listener Control Utility SERVICES Command**

Output Section	Description
Handlers	<p>The name of the service handler. Dispatchers are named D000 through D999. Dedicated servers have the name of DEDICATED.</p> <p>This section also identifies the following about the service handler:</p> <ul style="list-style-type: none"> <li>• <code>established</code>: The number of client connections this service handler has established.</li> <li>• <code>refused</code>: The number of client connections it has refused.</li> <li>• <code>current</code>: The number of client connections it is handling, that is, its current load.</li> <li>• <code>max</code>: The maximum number of connections for the service handler, that is, its maximum load.</li> <li>• <code>state</code>: The state of the handler: <ul style="list-style-type: none"> <li>- <code>READY</code> means the service handler can accept new connections.</li> <li>- <code>BLOCKED</code> means the service handler cannot accept new connections.</li> </ul> </li> </ul>

## 9.5.5 Monitoring Listener Log Files

When you notice any of the following conditions, review the listener log file for error information:

- Long connection establishment times
- Connectivity problems and refusals
- Unexpected shutdown of the listener that could indicate a denial-of-service attack



**See Also:**

["Analyzing Listener Log Files"](#)

## 9.6 Understanding Listener Redirects

Starting with Oracle Database 12c release 2 (12.2), the listener redirect feature allows a client to connect to a pluggable database (PDB) using an unchanged connect descriptor even after the PDB is migrated to a new location in the Oracle Public Cloud.

The Listener Registration (LREG) process registers a new handler with the local listener for the PDB or the service which is in the process of migration. This handler contains the new listener address of the database where the PDB or the service is migrated. The new listener address can be that of a Single Client Access Name (SCAN) listener in case of an Oracle RAC database or a local listener in case of a single-instance database. The listener then redirects the client to the new address.

If a local listener redirects to a SCAN listener in an Oracle RAC configuration, then this listener may need to further redirect the client connection request to another cluster node. Such multiple redirects are not supported by Oracle Net listeners by default. To



allow the SCAN listener to forward the already redirected client connection request, add the `ALLOW_MULTIPLE_REDIRECTS_listener_name` parameter to its `listener.ora` file. Set the parameter to `TRUE`. Do not set this parameter for node listeners because it may allow infinite redirection loops in certain network configurations.

# 10

## Configuring and Administering Oracle Connection Manager

Oracle Connection Manager is a proxy server that forwards connection requests to databases or other proxy servers. It operates on the session level. It usually resides on a computer separate from the database server and client computers. Oracle Connection Manager is available for installation with Oracle Database 20c Enterprise Edition. It is a custom installation option on the Client disk.

The primary functions of Oracle Connection Manager are:

- Access control: To use rule-based configuration to filter user-specified client requests and accept others.
- Session multiplexing: To funnel multiple client sessions through a network connection to a shared server destination.

Learn how to configure Oracle Connection Manager features.

- [About the cman.ora File](#)  
You can set parameters in the `cman.ora` file to configure the computer that hosts Oracle Connection Manager.
- [How to Configure Oracle Connection Manager](#)
- [Using Oracle Connection Manager as a Bridge for IPv4 and IPv6](#)
- [Using the Oracle Connection Manager Control Utility to Administer Oracle Connection Manager](#)
- [About Using Oracle Connection Manager in Traffic Director Mode](#)  
Oracle Connection Manager in Traffic Director Mode is a proxy that is placed between supported database clients and database instances.
- [About CMCTL REST Interface](#)  
CMCTL REST interface helps you manage Oracle Connection Manager (Oracle CMAN) instance from remote machines using REST interface. A client that supports HTTPS can issue CMCTL equivalent commands. Each REST API call must have `WWW-Authenticate` HTTPS header with `Basic` authentication method.
- [Migrating CMAN Sessions During Patching](#)  
You can migrate the established client/server sessions from one Oracle Connection Manager (CMAN) instance to another Oracle CMAN instance during a planned upgrade or patching of Oracle CMAN with zero downtime.
- [Oracle Connection Manager Enhancements](#)  
Oracle Connection Manager proxies and screens request for Oracle Database Server.

 **See Also:**

- [Introducing Oracle Net Services](#) for an introduction to Oracle Connection Manager concepts
- [Understanding the Communication Layers](#) for an architectural overview of Oracle Connection Manager

## 10.1 About the `cman.ora` File

You can set parameters in the `cman.ora` file to configure the computer that hosts Oracle Connection Manager.

The `cman.ora` file resides on the computer that hosts Oracle Connection Manager, and is located in the `ORACLE_BASE_HOME/network/admin` directory. If the `cman.ora` file is not present in the `ORACLE_BASE_HOME/network/admin` directory, then look for the file in `ORACLE_HOME/network/admin` directory. Oracle Connection Manager will not start if the `cman.ora` file does not exist. This file includes the following components:

- Listening endpoint
- Access control rule list
- Parameter list

Each Oracle Connection Manager configuration is encapsulated within a single name-value (NV) string, which consists of the preceding components.

One computer can host any number of Oracle Connection Managers, each with its own entry in the `cman.ora` file. When defining more than one Oracle Connection Manager in the file, you can assign a default by giving only one a fully qualified host name.

You can specify multiple rules for both client and Oracle Connection Manager Control utility (CMCTL) connections. The following guidelines apply when making changes:

- You must enter at least one rule for client connections and one rule for CMCTL connections. Omitting a rule results in the rejection of all connections for the rule type omitted.
- Oracle Connection Manager does not support wildcards for partial IP addresses. If you use a wildcard, then use it in place of a full IP address. The IP address of the client may be, for example, `(SRV=*)`.
- Oracle Connection Manager supports only the `/nn` notation for subnet addresses. In [Example 10-1](#), in the first rule, `/24` represents a subnet mask that comprises 24 left-most bits. Only the first 24 bits in the client's IP address are compared with the IP address in the rule.

 **Note:**

Oracle Connection Manager supports IPv6 addressing. See "[Using Oracle Connection Manager as a Bridge for IPv4 and IPv6](#)".

[Example 10-1](#) shows a `cman.ora` file that contains a configuration entry for an Oracle Connection Manager called `CMAN1`.

### Example 10-1 Sample cman.ora File

```
CMAN1=
  (CONFIGURATION=
    (ADDRESS=(PROTOCOL=tcp)(HOST=proxysvr)(PORT=1521))
    (RULE_LIST=
      (RULE=(SRC=192.0.2.32/24)(DST=sales-server)(SRV=*)(ACT=accept)
        (ACTION_LIST=(AUT=on)(MCT=120)(MIT=30)))
      (RULE=(SRC=192.0.2.32)(DST=proxysvr)(SRV=cmon)(ACT=accept)))
    (PARAMETER_LIST=
      (MAX_GATEWAY_PROCESSES=8)
      (MIN_GATEWAY_PROCESSES=3)))
```

[Example 10-1](#) shows the following rules:

- In the first rule in the example, the following parameters are set:
  - `SRC=192.0.2.32/24` is for client connections. It designates the IP address of the client, or source.
  - `DST=sales-server` designates the destination host name. The `ACT` parameter specifies the action, that is, accept, reject, or drop. The `ACTION_LIST` parameter sets attributes for a connection if it is accepted, enabling you to override default parameter settings on a connection-by-connection basis.
- In the second rule, the following parameters are set:
  - `SRC=192.0.2.32` and `DST=proxysvr` represent the same server, indicating that Oracle Connection Manager and CMCTL must reside on the same computer.



#### See Also:

["Enabling Access Control"](#)

[Table 10-1](#) describes the rule-level parameters in the `cman.ora` file.

**Table 10-1 Rule-Level Parameters in cman.ora File**

Parameter	Description
SRC	The source host name or IP address of the client. The IP address can be a subnet, such as <code>192.0.2.62/24</code> .
DST	The destination host name or IP address of the database server. The IP address can be a subnet, such as <code>192.0.2.62/24</code> .
SRV	The service name of the Oracle database obtained from the <code>SERVICE_NAMES</code> parameter in the initialization parameter file ( <code>init.ora</code> ).  The service name is given by the client as part of the connect descriptor when connecting to the listener. This service name is compared to the service name specified in the rule list.

**Table 10-1 (Cont.) Rule-Level Parameters in cman.ora File**

Parameter	Description
ACT	To accept, reject, or drop incoming requests based on the preceding three parameters.

You can define multiple rules in the `RULE_LIST`. The action (`ACT`) in the first matched `RULE` is applied to the connection request. If no rules are defined, then all connections are rejected.

In the following example, client computer `client1-pc` is denied access to the service `sales.us.example.com`, but client `192.0.2.45` is granted access to the service `db1`.

```
(RULE_LIST=
  (RULE=(SRC=client1-pc)(DST=sales-server)(SRV=sales.us.example.com)
  (ACT=reject))
  (RULE=(SRC=192.0.2.45)(DST=192.0.2.200)(SRV=db1)(ACT=accept)))
```

**See Also:**

*Oracle Database Net Services Reference* for additional information about Oracle Connection Manager parameters

## 10.2 How to Configure Oracle Connection Manager

In order to configure Oracle Connection Manager you must configure the proxy server, database, and clients. The following topics describe the general procedure:

- [Configuring the cman.ora file for the Oracle Connection Manager Host](#)
- [Configuring Clients for Oracle Connection Manager](#)
- [Configuring the Oracle Database Server for Oracle Connection Manager](#)
- [Configuring Oracle Connection Manager in Traffic Director Mode](#)

### 10.2.1 Configuring the cman.ora file for the Oracle Connection Manager Host

You make changes to the `cman.ora` file manually. The following procedure describes how to set parameters in the `cman.ora` file:

1. Navigate to the `cman.ora` file in the `ORACLE_BASE_HOME/network/admin` directory. If the `cman.ora` file is not present in the `ORACLE_BASE_HOME/network/admin` directory, then look for the file in `ORACLE_HOME/network/admin` directory.
2. Open the `cman.ora` file with a text editor.
3. Configure the listening endpoint (`ADDRESS`). The listening endpoint specifies the protocol address for the Oracle Connection Manager listener. `CMON`, the Oracle Connection Manager monitoring process,

uses this address to register information about gateway processes with the listener. The database uses the address to register service information at the Oracle Connection Manager node.

The Oracle Connection Manager listener always listens on the TCP/IP protocol.

```
(ADDRESS=(PROTOCOL=tcp)(HOST=proxysvr)(PORT=1521))
```

 **Note:**

Oracle Connection Manager can connect to the database using protocols such as TCP/IP (version 4 and version 6). Starting with Oracle Database 12c release 2 (12.2), the TCPS protocol is also supported

4. Configure the access control rule list (RULE\_LIST).  
The access control rule list specifies which connections are accepted, rejected, or dropped by the listener.
  5. Configure the parameter list (PARAMETER\_LIST).  
The parameter list sets attributes for an Oracle Connection Manager. Parameters take the following forms:
    - If global, then the parameter applies to all Oracle Connection Manager connections unless a rule-level parameter overrides it. To change a global parameter default setting, enter it into the PARAMETER\_LIST with an allowable value.
    - If a rule-level parameter is enabled in the ACTION\_LIST section of the RULE\_LIST, then it applies only to connections specified by the rule. It overrides its global counterpart.
- [Configure Secure Sockets Layer on the Oracle Connection Manager \(CMAN\)](#)
  - [Enabling Access Control](#)

### 10.2.1.1 Configure Secure Sockets Layer on the Oracle Connection Manager (CMAN)

**Step 1: Confirm that a CMAN wallet has been created and that it has a certificate.**

Before proceeding to the next step, confirm that a wallet has been created and that it has a certificate. Perform the following steps:

1. Start Oracle Wallet Manager.
  - On UNIX: Enter the following command from \$ORACLE\_HOME/bin:  

```
owm
```
  - On Windows: Select **Start**, go to **Programs**, click **Oracle-HOME\_NAME**, select **Integrated Management Tools**, and then click **Wallet Manager**.
2. From the Wallet menu, select **Open**.

The wallet should contain a certificate with a Ready status and auto-login turned on. If auto-login is not on, then select it from the Wallet menu and save the wallet again. This turns auto-login on.

**Step 2: Create a Listening Endpoint that uses TCP/IP with SSL (TCPS) and specify the CMAN wallet location on the CMAN side in cman.ora.**

The following example shows `cman.ora` with TCPS protocol:

```
CMAN_1=
  (CONFIGURATION=
    (ADDRESS_LIST=
      (ADDRESS=(PROTOCOL=tcps)(HOST=proxysvr)(PORT=1522))
      (ADDRESS=(PROTOCOL=tcp)(HOST=proxysvr)(PORT=1523))
    )
    (RULE_LIST=
      (RULE=(SRC=*)(DST=*)(SRV=*)(ACT=accept))
    )
    (PARAMETER_LIST=
      (MAX_GATEWAY_PROCESSES=8)
      (MIN_GATEWAY_PROCESSES=3)
    )
  )
wallet_location =
  (SOURCE=
    (METHOD=File)
    (METHOD_DATA=
      (DIRECTORY=wallet_location)
    )
  )
)
```

### 10.2.1.2 Enabling Access Control

Use the `RULE_LIST` parameter to control client access to designated database servers in a TCP/IP environment. By entering filtering rules under this parameter, you can allow or restrict specific clients access to a database server.

The following procedure describes how to configure access control:

1. Open the `cman.ora` file with a text editor.
2. Update the `RULE_LIST` parameter using the following format:

```
(RULE_LIST=
  (RULE=(SRC=source_host)
    (DST=destination_host)
    (SRV=service)
    (ACT=accept | reject | drop)))
```

 **See Also:**

[Table 10-1](#)

### 10.2.2 Configuring Clients for Oracle Connection Manager

To route clients to the database server through Oracle Connection Manager, configure the `tnsnames.ora` file with a connect descriptor that specifies the protocol address of

Oracle Connection Manager. This address enables clients to connect to the Oracle Connection Manager computer. The connect descriptor looks similar to the following:

```
sales=
  (DESCRIPTION=
    (ADDRESS=
      (PROTOCOL=tcp)
      (HOST=cman-pc)
      (PORT=1521))
    (CONNECT_DATA=
      (SERVICE_NAME=example.com)))
```

The following procedure describes how to configure a protocol address for Oracle Connection Manager:

1. Start Oracle Net Manager.



#### See Also:

["Using Oracle Net Manager to Configure Oracle Net Services"](#)

2. In the navigator pane, select **Service Naming** from Directory or Local menus.
3. Click the plus sign (+) on the toolbar, or select **Create** from the Edit menu.  
The Welcome page of the Net Service Name wizard appears.
4. Enter a name in the Net Service Name field.
5. Click **Next**.  
The Protocol page appears.
6. Select the TCP/IP protocol for Oracle Connection Manager.
7. Click **Next**.  
The Protocol Settings page appears.
8. Specify the Oracle Connection Manager port and protocol. The default port number for Oracle Connection Manager is 1521, and the protocol is TCP/IP.



#### See Also:

*Oracle Database Net Services Reference* for protocol parameter settings

9. Click **Next**.  
The Service page appears.
10. Enter a service name in the **Service Name** field, and then select the connection type.



 **See Also:**

"[About Connect Descriptors](#)" for additional information about setting the service name string

11. Click **Next**.

 **Note:**

Do not click **Test**, because a connection cannot be tested at this point.

12. Click **Finish** to save your configuration and close the Net Service Name wizard.

The new network service name and the Oracle Connection Manager protocol address is added to the Service Naming folder.

## 10.2.3 Configuring the Oracle Database Server for Oracle Connection Manager

Configuring the database server involves registering database information remotely with Oracle Connection Manager and, optionally, configuring the server for multiplexing.

- [Configuring Service Registration for Use with Oracle Connection Manager](#)
- [Enabling Session Multiplexing for Oracle Connection Manager](#)

### 10.2.3.1 Configuring Service Registration for Use with Oracle Connection Manager

To enable the database server to communicate with Oracle Connection Manager, the `tnsnames.ora` file must include the service name entry, and the initialization parameter file (`init.ora`) must contain a descriptor that specifies the listening address of Oracle Connection Manager. The following procedure describes how to configure service registration:

1. Resolve the Oracle Connection Manager alias to a service name entry in the `tnsnames.ora` file as follows:

```
cman_listener_address =
  (DESCRIPTION=
    (ADDRESS_LIST=
      (ADDRESS=(PROTOCOL=tcp) (HOST=proxy_server_name) (PORT=1521))))
```

For example, the alias `listener_cman` would be resolved to the following entry in the `tnsnames.ora` file:

```
listener_cman=
  (DESCRIPTION=
    (ADDRESS_LIST=
      (ADDRESS=(PROTOCOL=tcp) (HOST=proxysvr1) (PORT=1521))))
```

2. Specify an alias for Oracle Connection Manager in the `init.ora` file as follows. This alias is the one specified in the `tnsnames.ora` file in step 1.

```
REMOTE_LISTENER=cman_listener_address
```

The alias must be specified because this address is TCP, port 1521 but it is not the default local listening address of TCP, port 1521 of the database server.

For example, the alias for the Oracle Connection Manager listener running on host, `proxyserver1`, specified in step 1, might look like the following in the `init.ora` file:

```
REMOTE_LISTENER=listener_cman
```

3. Configure `REGISTRATION_INVITED_NODES` in `cman.ora` if the database resides on a remote node. For example:

```
(registration_invited_nodes=sales.us.example.com,10.245.129.60)
```

4. After the initialization parameter file is configured with the alias of Oracle Connection Manager, the Listener Registration (LREG) process can register database information with the Oracle Connection Manager listener. Use the following command to register the change:

```
SQL> ALTER SYSTEM REGISTER
```



#### See Also:

["Registering Information with a Remote Listener"](#)

## 10.2.3.2 Enabling Session Multiplexing for Oracle Connection Manager

To enable Oracle Connection Manager to take advantage of session multiplexing, set the `DISPATCHERS` parameter in the initialization parameter file (`init.ora`) with the attributes `PROTOCOL` and `MULTIPLEX`, similar to the following:

```
DISPATCHERS="(PROTOCOL=tcp)(MULTIPLEX=on)"
```

[Table 10-2](#) lists the parameters to set different levels of multiplexing.

**Table 10-2 Session Multiplexing Parameters**

Attribute	Description
PROTOCOL	The network protocol for which the dispatcher generates a listening endpoint.
MULTIPLEX	This parameter is used to enable session multiplexing, as follows: <ul style="list-style-type: none"> <li>• If <code>1</code>, <code>on</code>, <code>yes</code>, <code>true</code>, or <code>both</code> is specified, then multiplexing is enabled for both incoming and outgoing network sessions.</li> <li>• If <code>in</code> is specified, then multiplexing is enabled for incoming network sessions from the client.</li> <li>• If <code>out</code> is specified, then multiplexing is enabled for outgoing network sessions.</li> <li>• If <code>0</code>, <code>off</code>, <code>no</code>, or <code>false</code> is specified, then multiplexing is disabled for both incoming and outgoing network sessions.</li> </ul>

 **See Also:**

- [Configuring a Shared Server Architecture](#) for additional information about configuring shared servers
- *Oracle Database Net Services Reference* for a complete list of parameters and their default and allowed values

## 10.2.4 Configuring Oracle Connection Manager in Traffic Director Mode

Oracle Connection Manager in Traffic Director Mode is a proxy that is placed between the database clients and the database instances.

- [Configuring cman.ora File for Oracle Connection Manager in Traffic Director Mode](#)
- [Configuring a Wallet for Oracle Connection Manager in Traffic Director Mode Proxy Authentication](#)
- [Configuring Databases for Oracle Connection Manager in Traffic Director Mode Proxy Authentication](#)
- [Configuring Service Registration with Oracle Connection Manager in Traffic Director Mode](#)
- [Configuring Proxy Resident Connection Pool in Oracle Connection Manager in Traffic Director Mode](#)
- [Configuring Oracle Connection Manager in Traffic Director Mode for Unplanned Events](#)
- [Configuring Oracle Connection Manager in Traffic Director Mode for Planned Down Events](#)
- [Configuring Secure Sockets Layer on Oracle Connection Manager in Traffic Director Mode](#)
- [Oracle Connection Manager in Traffic Director Mode Restrictions](#)

### 10.2.4.1 Configuring cman.ora File for Oracle Connection Manager in Traffic Director Mode

TDM = YES must be set in the `cman.ora` file to set up Oracle Connection Manager in Traffic Director Mode.

```
cman.ora
CMAN_1=
  (CONFIGURATION=
    (ADDRESS_LIST=
      (ADDRESS=(PROTOCOL=tcp)(HOST=TDMHOST)(PORT=1522))
    )
    (RULE_LIST=
      (RULE=(SRC=*)(DST=*)(SRV=*)(ACT=accept))
    )
  )
```

```

        (PARAMETER_LIST=
          (TDM=YES)
          (TDM_THREADING_MODE=DEDICATED)
          (MAX_GATEWAY_PROCESSES=8)
          (MIN_GATEWAY_PROCESSES=3)
        )
      )
    wallet_location =
      (SOURCE=
        (METHOD=File)
        (METHOD_DATA=
          (DIRECTORY=wallet_location)
        )
      )
    )
  SQLNET.WALLET_OVERRIDE = TRUE

```

## 10.2.4.2 Configuring a Wallet for Oracle Connection Manager in Traffic Director Mode Proxy Authentication

Oracle Connection Manager in Traffic Director Mode connects to the databases using the wallet that must be configured with `cman.ora` file. This wallet has the user name and the password information for the `tdm` user used by Oracle Connection Manager in Traffic Director Mode for proxy authentication. This `tdm` user must exist on all the databases that the Oracle Connection Manager in Traffic Director Mode connects to.



### See Also:

*Oracle Database Enterprise User Security Administrator's Guide*

The following setting causes all outbound connections from Oracle Connection Manager in Traffic Director Mode to use the credentials in the wallet at the specified location for proxy authentication:

```

WALLET_LOCATION =
  (SOURCE =
    (METHOD = FILE)
    (METHOD_DATA =
      (DIRECTORY = wallet_location)
    )
  )
  SQLNET.WALLET_OVERRIDE = TRUE

```

The wallet must be configured for each service. If a new service is added, then you must supply the credentials for the new service using the same wallet.



### Note:

Whenever a new service is added and the credentials for the new service are added to the wallet, the Oracle Cloud Traffic Manager should be restarted for the changes to take effect.

- [Enabling Oracle Connection Manager in Traffic Director Mode to Use the External Password Store](#)

#### Related Topics

- [Configuring Databases for Oracle Connection Manager in Traffic Director Mode Proxy Authentication](#)

### 10.2.4.2.1 Enabling Oracle Connection Manager in Traffic Director Mode to Use the External Password Store

**Step 1: Create a wallet on the Oracle Connection Manager in Traffic Director Mode by using the following syntax at the command line:**

```
mkstore -wrl wallet_location -create
```

*wallet\_location* is the path to the directory where you want to create and store the wallet. This command creates an Oracle wallet with the autologin feature enabled at the specified location. The autologin feature enables the Oracle Connection Manager in Traffic Director Mode to access the wallet contents without supplying a password.

 **See Also:**

**Step 2: Create database connection credentials in the wallet by using the following syntax at the command line:**

```
mkstore -wrl wallet_location -createCredential db_service_name username  
password
```

*wallet\_location* is the path to the directory where you created the wallet in Step 1. The *db\_service\_name* is any service name which is used to identify the database on an Oracle network. The *username* and *password* are the database login credentials.

Repeat this step for each database service that must be accessed by using Oracle Connection Manager in Traffic Director Mode.

 **Note:**

- The same *tdm* user can be used across all services for a given database. However, if required, a different *tdm* user can also be associated for each service.
- For pluggable database (PDB) services, there are two choices for setting up the *tdm* user:  
  
Common *tdm* user: *tdm* user can be a common user, in which case Oracle Connection Manager in Traffic Director Mode uses a single set of credentials for proxy authenticating users from different PDBs in a multitenant container database (CDB).  
  
Per PDB *tdm* user: *tdm* user can be a PDB-specific user, in which case Oracle Connection Manager in Traffic Director Mode uses PDB-specific proxy user for proxy authenticating users in a specific PDB.
- For TCP/IP with SSL (TCPS) configuration, Oracle Connection Manager in Traffic Director Mode wallet is already created. So, skip Step 1 and specify *wallet\_location* in *mkstore* as the same location used for TCPS configuration.

### 10.2.4.3 Configuring Databases for Oracle Connection Manager in Traffic Director Mode Proxy Authentication

Every database to which an application connects through Oracle Connection Manager in Traffic Director Mode must have a user, for example, *tdm*. Oracle Connection Manager in Traffic Director Mode uses proxy authentication and connects to the database as the *tdm* user. All the users that must connect through Oracle Connection Manager in Traffic Director Mode must be granted `CONNECT THROUGH tdm` privilege as follows:

```
ALTER user SCOTT GRANT CONNECT THROUGH tdm
```

### 10.2.4.4 Configuring Service Registration with Oracle Connection Manager in Traffic Director Mode

See [Configuring Service Registration for Use with Oracle Connection Manager](#).

### 10.2.4.5 Configuring Proxy Resident Connection Pool in Oracle Connection Manager in Traffic Director Mode

Oracle Connection Manager in Traffic Director Mode 18.1 supports Proxy Resident Connection Pooling (PRCP). PRCP provides connection services for a larger number of client connections that are routed by using a connection pool comprising of a fewer number of server connections to target databases. PRCP can reduce connection load (connection memory usage) on the database tier and also perform runtime load balancing (RLB) to provide better performance. This can help reduce connection load on the database.

The proxy resident connection pool is configured by specifying the following set of parameters in the `oraaccess.xml` configuration file.

- `<session_pool>` – Sets up session pool parameters.
- `<enable>` – `true` or `false` to make the session pool configuration effective. It is a must have parameter that means if the `<session_pool>` is configured, then `<enable>` must be configured.
- `<min_size>` — Minimum number of connections in the pool. The default value is 0. Since Oracle Connection Manager in Traffic Director Mode is a heterogeneous pool scenario, so all other values are ignored.
- `<max_size>` — Maximum number of connections in the pool. There is no default parameter as it is a must have parameter. It means that if the `<session_pool>` is configured, then `<max_size>` must be configured.
- `<increment>` — Amount of increase in the number of connections in the pool as the pool expands. The default value is 1.
- `<inactivity_timeout>` — Maximum time in seconds for which a connection stays idle in the pool, after which it is terminated. The default value is 0. It means that there is no limit.
- `<max_use_session>` — Maximum number of times a connection can be taken and released to the pool. The default value is 0. It means that there is no limit.
- `<max_life_time_session>` — Time, in seconds, to live for a connection in the pool. The default value is 0. It means that there is no limit.

Using the `oraaccess.xml` file allows you to configure a proxy resident connection pool for each needed connection service. The following example shows two groups of connection parameters associated with its respective config alias, the `sales_config` and the `hr_config`, where each connection string that the application uses is mapped with its respective config alias, thus providing two proxy resident connection pools.

```
<oraaccess xmlns="http://xmlns.oracle.com/oci/oraaccess"
  xmlns:oci="http://xmlns.oracle.com/oci/oraaccess"
  schemaLocation="http://xmlns.oracle.com/oci/oraaccess
  http://xmlns.oracle.com/oci/oraaccess.xsd">
  <default_parameters>
</default_parameters>
  <!--
    Create configuration descriptions, which are
    groups of connection parameters associated with
    a config_alias.
  -->
  <config_descriptions>
    <config_description>
      <config_alias> sales_config </config_alias>
      <parameters>
        <session_pool>
          <enable>true</enable>
          <min_size> 10 </min_size>
          <max_size> 100 </max_size>
          <increment> 5 </increment>
        </session_pool>
      </parameters>
    </config_description>
```

```
<config_description>
  <config_alias> hr_config </config_alias>
  <parameters>
    <session_pool>
      <enable>true</enable>
      <max_size> 10 </max_size>
    </session_pool>
  </parameters>
</config_description>
</config_descriptions>
<!--
      Now map the connection string used by the application
      with a config_alias.
-->
<connection_configs>
  <connection_config>
    <connection_string>sales.us.example.com</connection_string>
    <config_alias>sales_config</config_alias>
  </connection_config>
  <connection_config>
    <connection_string>hr.us.example.com</connection_string>
    <config_alias>hr_config</config_alias>
  </connection_config>
</connection_configs>
</oraaccess>
```

 **See Also:**

Overview of Oracle CMAN configuration file in *Oracle Database Net Services Reference*

### 10.2.4.6 Configuring Oracle Connection Manager in Traffic Director Mode for Unplanned Events

Oracle Connection Manager in Traffic Director Mode implicitly subscribes to Fast Application Notification (FAN) events. For this events must be enabled in `oraaccess.xml`.

Use `DBMS_SERVICE` or `SRVCTL` (for an Oracle RAC database) to specify `COMMIT_OUTCOME` for this specific service.



 **See Also:**

- *Oracle Database PL/SQL Packages and Types Reference* for information about `DBMS_SERVICE`
- *Oracle Clusterware Administration and Deployment Guide* for information about `SRVCTL`

### 10.2.4.7 Configuring Oracle Connection Manager in Traffic Director Mode for Planned Down Events

Oracle Connection Manager in Traffic Director Mode implicitly subscribes to Fast Application Notification (FAN) events. For this `events` must be enabled in `oraaccess.xml`.

For planned down events, use `DBMS_SERVICE` or `SRVCTL` to configure the service and set `failover_mode` to `select`, `commit_outcome` to `TRUE`, and `failover_restore` to `LEVEL1`.

 **See Also:**

- *Oracle Database PL/SQL Packages and Types Reference* for information about `DBMS_SERVICE`
- *Oracle Clusterware Administration and Deployment Guide* for information about `SRVCTL`

### 10.2.4.8 Configuring Secure Sockets Layer on Oracle Connection Manager in Traffic Director Mode

**Step 1: Confirm that an Oracle Connection Manager in Traffic Director Mode wallet has been created and that it has a certificate.**

Before proceeding to the next step, confirm that a wallet has been created and that it has a certificate. Perform the following steps:

1. Start Oracle Wallet Manager.
  - On UNIX: Enter the following command from `$ORACLE_HOME/bin`:  

```
owm
```
  - On Windows: Select **Start**, go to **Programs**, click **Oracle-HOME\_NAME**, select **Integrated Management Tools**, and then click **Wallet Manager**.
2. From the Wallet menu, select **Open**.

The wallet should contain a certificate with a Ready status and auto-login turned on. If auto-login is not on, then select it from the Wallet menu and save the wallet again. This turns auto-login on.

**Step 2: Create a Listening Endpoint that uses TCP/IP with SSL (TCPS) and specify the Oracle Connection Manager in Traffic Director Mode wallet location on the CMAN side in cman.ora.**

The following example shows `cman.ora` with TCPS protocol:

```
CMAN_1=
  (CONFIGURATION=
    (ADDRESS_LIST=
      (ADDRESS=(PROTOCOL=tcps)(HOST=proxysvr)(PORT=1522))
      (ADDRESS=(PROTOCOL=tcp)(HOST=proxysvr)(PORT=1523))
    )
    (RULE_LIST=
      (RULE=(SRC=*)(DST=*)(SRV=*)(ACT=accept))
    )
    (PARAMETER_LIST=
      (MAX_GATEWAY_PROCESSES=8)
      (MIN_GATEWAY_PROCESSES=3)
    )
  )
wallet_location =
  (SOURCE=
    (METHOD=File)
    (METHOD_DATA=
      (DIRECTORY=wallet_location)
    )
  )
SQLNET.WALLET_OVERRIDE = TRUE
```

### 10.2.4.9 Oracle Connection Manager in Traffic Director Mode Restrictions

The following functionality is not supported with Oracle Connection Manager in Traffic Director Mode Restrictions for all drivers:

- Distributed Transactions
- Advanced Queuing (AQ)
- Database Startup or Database Shutdown calls
- Sharding
- XML
- SQL Translation
- Proxy Authentication and SSL External Authentication (such as DN)
- Object REF
- Session switching
- OCIObject\* calls for navigational access
- OCIPickerImage\* calls
- OCIAnyData\* calls
- OCIDirPath\* calls
- OCISubscription\* calls

- OCILCR\*, OCIXStream\* calls
- OCISstmtExecute:
  - Scrollable Cursor
  - Implicit Results
- Change Notification (CQN)
- Client Result Cache
- OCI\_MIGRATE mode
- DRCP: Multi-property Tag and PLSQL callback
- Application Continuity
- OCIConnectionPool
- Authentication as SYSDBA, SYSOPER etc
- Real Application Security (only in Java)
- Datatypes
  - PL/SQL Indexed Table Binds
- Bulk Copy (ODP.Net only)
- Self-Tuning (ODP.Net only)
- ASO encryption and supported algorithms (ASO only)

## 10.3 Using Oracle Connection Manager as a Bridge for IPv4 and IPv6

In some database connection environments, a client and database may use different versions of the IP protocol so that complete connectivity does not exist. In this case at least two hops in the connection use different versions of the IP protocol. For example, a request passes from an IPv4 source to an IPv6 destination, from an IPv6 source to an IPv4 destination, or from IPv6 to IPv6 through an IPv4 network.

You can use Oracle Connection Manager as a network bridge between IPv4 and IPv6. To serve as a bridge, Oracle Connection Manager must run on a dual-stack host configured with at least one IPv4 interface and at least one IPv6 interface.

Use the Oracle Connection Manager filtering feature to filter based on an IPv6 address. You can base rules on complete or partial IP addresses. The following figure shows the format of an IPv6 address.

**Figure 10-1 IPv6 Address Format**

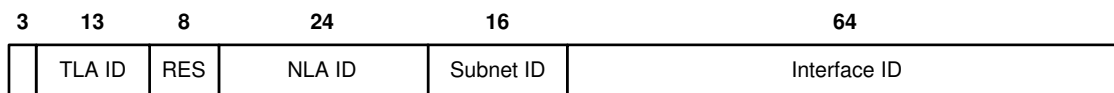

The numbers at the top of the diagram indicate the number of bits in the address. Each hexadecimal character in an IPv6 address represents 4 bits. Bits 4-16 are the

Top-Level Aggregation Identifier (TLA ID) portion of the address. Bits 25-49 are the Next-Level Aggregation Identifiers (NLA ID).

For example, in the address `2001:0db8::203:BAFF:FE0F:C74B`, the binary representation of the first four hexadecimal characters (2001) is as follows:

```
00100000000000001
```

Thus, the first 3 bits in the address are 001. The TLA ID portion of the address is 0000000000001.

The following procedure describes how to create a rules filter for IPv6 address:

1. Navigate to the `cman.ora` file located in the `ORACLE_BASE_HOME/network/admin` directory.  
If the `cman.ora` file is not present in the `ORACLE_BASE_HOME/network/admin` directory, then check for the file in the `ORACLE_HOME/network/admin` directory.
2. Open the `cman.ora` file with a text editor.
3. Create a `RULE` in the `RULE_LIST` based on IPv6 address format.  
For example, assume that the source host is an IPv6-only host with address `2001:0db8::203:BAFF:FE0F:C74B`, whereas the destination is an IPv4-only host named `SALESL1593`. You configure Oracle Connection Manager as an IPv6-to-IPv4 bridge by creating one of the following rules:

Type of Rule	Description	Example
Filter based on subnet ID	Filtering is based on the 64 bits up to and including the subnet ID	<pre>(RULE = (SRC = 2001:0db8::203:BAFF:FE0F:C74B/<b>64</b>) (DST = SALESL1593) (SRV = SALES) (ACT = ACCEPT) (ACTION_LIST = (AUT=ON)(MOCT=10) (MIT=30)(CONN_STATE=YES)) )</pre>
Filter based on NLA ID	Filtering is based on the 48 bits up to and including the NLA ID	<pre>(RULE = (SRC = 2001:0db8::203:BAFF:FE0F:C74B/<b>48</b>) (DST = SALESL1593) (SRV = SALES) (ACT = ACCEPT) (ACTION_LIST = (AUT=ON)(MOCT=10) (MIT=30)(CONN_STATE=YES)) )</pre>
Filter based on TLA ID	Filtering is based on the 16 bits up to and including the TLA ID	<pre>(RULE = (SRC = 2001:0db8::203:BAFF:FE0F:C74B/<b>16</b>) (DST = SALESL1593) (SRV = SALES) (ACT = ACCEPT) (ACTION_LIST = (AUT=ON)(MOCT=10) (MIT=30)(CONN_STATE=YES)) )</pre>

Type of Rule	Description	Example
Filter based on number of bits	Filtering is based on the first 60 bits of the address	(RULE = (SRC = 2001:0db8::203:BAFF:FE0F:C74B/60) (DST = SALES1593) (SRV = SALES) (ACT = ACCEPT) (ACTION_LIST = (AUT=ON)(MOCT=10) (MIT=30)(CONN_STATE=YES)) )

#### See Also:

- ["About TCP/IP Protocol"](#) to learn more about IPv6
- ["About IPv6 Addresses in Connect Descriptors"](#)
- ["Configuring Listening Protocol Addresses"](#)

## 10.4 Using the Oracle Connection Manager Control Utility to Administer Oracle Connection Manager

The Oracle Connection Manager Control utility enables you to administer Oracle Connection Manager. When you issue commands from the operating system, the basic syntax for this utility is as follows:

```
cmctl [command] [argument1 . . . argumentN] [-c instance_name]
```

In the preceding command, `-c` specifies the Oracle Connection Manager instance. You are prompted for the password if one has been set.

#### Caution:

There is an option to specify the password on the command line. However, this exposes the password on the screen, and is a potential security risk. Oracle recommends not using the password option (`-p`) on the command line.

For example, the following command starts the listener, Connection Manager Administration (CMADMIN), and gateway processes for an instance named `cman1`:

```
cmctl STARTUP -c cman1
```

You can also issue Oracle Connection Manager utility commands at the `CMCTL` prompt. To obtain the prompt, enter `cmctl` with no arguments at the operating system command line. The utility may prompt for a password if Oracle Connection Manager was installed with secure installation option. When you run `CMCTL`, the utility is started,

and you can enter the necessary commands from the CMCTL prompt. The following is an example of the CMCTL prompt:

```
cmctl  
CMCTL> STARTUP
```

 **Note:**

Before issuing the `STARTUP` command, do the following:

- Create the `cman.ora` file. A sample file is located in the `ORACLE_BASE_HOME/network/admin/samples` directory after installation of Oracle Connection Manager.
- Run the `ADMINISTER` command to choose an instance to start.

 **See Also:**

- "[Understanding Oracle Connection Manager Architecture](#)" for an overview of the Oracle Connection Manager processes
- *Oracle Database Net Services Reference* for a complete description of Oracle Connection Manager Control utility commands

## 10.5 About Using Oracle Connection Manager in Traffic Director Mode

Oracle Connection Manager in Traffic Director Mode is a proxy that is placed between supported database clients and database instances.

A current database OCI client or supported older version OCI client (Oracle Database 11g Release 2 (11.2) and later) can connect to Oracle Connection Manager in Traffic Director Mode. Oracle Connection Manager in Traffic Director Mode provides improved high availability (HA) (planned and unplanned), connection multiplexing support, and load balancing. This feature also provides an inband client notification mechanism to deliver planned shutdown for Oracle Connection Manager (CMAN) down and service down events to the OCI client. Additional CMAN parameters must be specified in the `cman.ora` configuration file to configure Oracle Connection Manager in Traffic Director Mode.

To configure CMAN to act as an Oracle Connection Manager in Traffic Director Mode, new parameters such as `tdm` and `tdm_threading_model` must be added in the `cman.ora` configuration file. Oracle Connection Manager (CMAN) is the standard Oracle Net proxy for both Oracle RAC and non-RAC databases.

The databases that Oracle Connection Manager in Traffic Director Mode connects to must have a user, for example, `tdm` with the `CONNECT THROUGH` privilege granted to

connect as application users. Oracle Connection Manager in Traffic Director Mode uses proxy authentication and connects as this user.

 **See Also:**

*Oracle Database Net Services Reference* for the existing parameters in the `cman.ora` file that support Oracle Connection Manager in Traffic Director Mode.

*Oracle Database Security Guide* for more information about CONNECT THROUGH.

In this release, Oracle Connection Manager in Traffic Director Mode furnishes support for:

- Transparent performance enhancements and connection multiplexing
- Zero Application Downtime
  - Planned database maintenance or PDB relocation
  - Unplanned database outages for read-mostly workloads
- High Availability of Oracle Connection Manager in Traffic Director Mode, this means no single point of failure
- Security and Isolation

#### Modes of Operation

- Pooled Connection mode

This includes any application using the following database client releases:

- OCI and Open Source Drivers (11.2.0.4 and later)
- JDBC (12.1 and later)
- ODP.NET (12.2 and later)

In addition, applications must be Database Resident Connection Pool (DRCP) aware. This means specifying (SERVER=POOLED) in the application's connect string.

- Non-pooled Connection (or Dedicated) mode

This includes any application using database client releases 11.2.0.4 and later. In this mode, some capabilities such as connection multiplexing are not available.

#### Transparent Performance Enhancements and Session Multiplexing

- Statement caching, rows prefetching and Result set caching are auto-enabled for all mode of operations.
- Database session multiplexing (pooled mode only) using the proxy resident connection pool (PRCP, a proxy mode of DRCP). Applications get transparent connect-time load balancing and run-time load balancing between TDM and Database.
- Multiple Oracle Connection Manager in Traffic Director Mode instances: applications get increased scalability through client-side connect time load balancing or load balancer (BigIP, NGINX, others)

## Zero Application Downtime - Planned Database Maintenance or PDB Relocation

- Pooled mode

Oracle Connection Manager in Traffic Director Mode responds to ONS events for planned outages and re-directs work. The connections are drained from the pool on Oracle Connection Manager in Traffic Director Mode when the request completes.

Service relocation support is available for database release 11.2.0.4 and later.

PDB Relocation: Oracle Connection Manager in Traffic Director Mode responds to in-band notifications when a PDB is relocated, even when ONS is not configured (18.1 and later for server only)

- Non-pooled or Dedicated mode

No request boundary information is received from the client. Oracle Connection Manager in Traffic Director Mode supports planned outage for many applications (as long as only simple session state and cursor state need to be preserved across the request or transaction boundaries). This involves the following:

- Stop Service or PDB at Transaction Boundary or Leverage Oracle Database 18c “Continuous Application Availability” to stop service at request boundary.
- Oracle Connection Manager in Traffic Director Mode leverages “TAF Failover Restore” to reconnect and restore simple states.

## Unplanned Database Outages

For both pooled and non-pooled (dedicated) modes, Oracle Connection Manager in Traffic Director Mode supports unplanned outage for read-mostly applications by leveraging “TAF Failover Restore” to restore simple session state or cursor state and replay SELECT statements and first DML statement.

## Security and Isolation

Oracle Connection Manager in Traffic Director Mode provides:

- Database Proxy supporting TCP/TCPS and protocol conversion
- Firewall based on IP address, Service name and SSL/TLS wallets
- Tenant isolation in a multitenant environment
- Protection against denial-of-service and fuzzing attacks
- Secure tunneling of database traffic across on-premises database and Oracle Cloud

## High Availability of Oracle Connection Manager in Traffic Director Mode

This involves:

- Multiple instances of Oracle Connection Manager in Traffic Director Mode using Load Balancer or client-side load balancing or failover in connect string
- Rolling upgrade of Oracle Connection Manager in Traffic Director Mode instances
- Closure of existing connections from client to Oracle Connection Manager in Traffic Director Mode for planned outages
- In-band notifications to Oracle Database release 18c and later clients. For earlier release clients, notifications are sent with the response of the current request.



- [Enhancements to Oracle Connection Manager in Traffic Director Mode](#)  
Oracle Connection Manager in Traffic Director Mode now supports database links, which extends high availability and failover to databases.

## 10.5.1 Enhancements to Oracle Connection Manager in Traffic Director Mode

Oracle Connection Manager in Traffic Director Mode now supports database links, which extends high availability and failover to databases.

Starting with Oracle Database 20c, Oracle Connection Manager in Traffic Director Mode (TDM) supports the following types of database links:

- **Fixed User:** The user connects to the remote database using the username and password specified during the creation of the database link.
- **Connected User:** The user connects to the remote database using the credentials of the user accessing the database link. These credentials can either be a username and password, or external, such as Kerberos ticket.

You can use database links with Traffic Director Mode in the following scenarios:

- **Scenario 1:**  
When a client connects directly to the database  
In this scenario, both fixed user and connected user database links work.
- **Scenario 2:**  
When a client connects to the database through the Traffic Director Mode  
In this scenario, only fixed user database link works. The connected user database link does not work as the session between TDM and the database is a proxy user session. Proxy user sessions are not allowed over a database link for security reasons.

### Note:

For the database links to work with TDM, the TDM should not be running in Proxy Resident Connection Pool (PRCP) mode for the particular database service.

## 10.6 About CMCTL REST Interface

CMCTL REST interface helps you manage Oracle Connection Manager (Oracle CMAN) instance from remote machines using REST interface. A client that supports HTTPS can issue CMCTL equivalent commands. Each REST API call must have `WWW-Authenticate` HTTPS header with `Basic` authentication method.

- [Configuring CMCTL REST Interface](#)  
Perform the following steps to configure CMCTL REST interface.
- [REST APIs for CMCTL Commands](#)  
Use CMCTL REST interface to automate CMAN tasks in cloud deployments. This functionality is similar to the CMAN `cmctl` control utility.

## 10.6.1 Configuring CMCTL REST Interface

Perform the following steps to configure CMCTL REST interface.

1. Add the `REST_ADDRESS` attribute under the parameters section of the `cman.ora` file.
2. Create an Oracle Wallet.

An Oracle Wallet is a file that stores certificates and authentication credentials. Use the `orapki` utility to create an Oracle Wallet.

You can import a certificate from a recognized authority into an Oracle Wallet or you can create your own authorized and signed certificate and use it with CMAN Oracle Wallet. You can also use a self-signed Oracle Wallet.

For example, to create a wallet with a self-signed certificate, run the following commands:

```
$ORACLE_HOME/bin/orapki wallet create -wallet wallet_directory
$ORACLE_HOME/bin/orapki wallet add -wallet wallet_directory -dn
'cn=root_test, c=US' -keysize 2048 -self_signed -validity 365
```

Where *wallet\_directory* is the file system directory location where the wallet is created.

 **Note:**

Ensure that this directory is not readable by any group or other users.

3. Add CMAN REST client username to the Wallet.

REST interface authentication uses username and password available in Oracle CMAN wallet. CMCTL REST interface process supports only HTTPS protocol. HTTP protocol is not supported. This wallet file must not have read permission to any group or other users. It should have read permissions only to the user owning the CMAN instance.

Use the `mkstore` utility to store username and password in an Oracle CMAN wallet.

For example:

```
mkstore -wrl wallet_directory myusername my_password
```

4. Create an autologin wallet.

Oracle CMAN requires autologin wallet to start HTTPS endpoint. Run the following command to create an autologin wallet:

```
$ORACLE_HOME/bin/orapki wallet create -wallet wallet_location -
auto_login
```

where *wallet\_location* is the directory where you have created the CMAN wallet.

- Specify the wallet location in the `cman.ora` file. Update the `cman.ora` file with wallet directory outside of `cman` alias:

```
CMAN=
  (CONFIGURATION=
    . . .
    (RULE_LIST=
      . . . )
    (PARAMETER_LIST=
      . . . ))
Wallet_location= ...
```

For example:

```
WALLET_LOCATION=
  (SOURCE= (METHOD=FILE)
    (METHOD_DATA=
      (DIRECTORY=wallet directory))
  )
```

### Related Topics

- [Oracle Database Security Guide](#)
- [Oracle Database Net Services Reference](#)

## 10.6.2 REST APIs for CMCTL Commands

Use CMCTL REST interface to automate CMAN tasks in cloud deployments. This functionality is similar to the CMAN `cmctl` control utility.

CMCTL REST interface uses local operating system authentication between REST interface process and Oracle CMAN listener.

After you start an Oracle CMAN instance with REST configuration, you can make a REST call with HTTPS basic authentication.

Use the `curl` command line tool to verify CMAN REST API. For example to list the services that are running, use the following command:



### Note:

The `curl` command is used for testing and verification purposes only.

```
curl -X GET -u username:password https://cmanhostname:rest_port/show/
services
```

### Related Topics

- [Oracle Database Net Services Reference](#)

## 10.7 Migrating CMAN Sessions During Patching

You can migrate the established client/server sessions from one Oracle Connection Manager (CMAN) instance to another Oracle CMAN instance during a planned upgrade or patching of Oracle CMAN with zero downtime.

You can migrate live sessions with data in-transit without disrupting the service. Any operations that are running either on a client or on a server continue to run seamlessly during the migration without loss of service. You can also add new client connections during the migration.

Perform the following steps to migrate client/server sessions:

You must have either upgraded Oracle CMAN to the latest release or applied the latest patch.

1. Install the upgraded Oracle CMAN or the patched Oracle CMAN in a new `ORACLE_HOME`.
2. Use the same `cmn.ora` file that you used for configuring Oracle CMAN to configure the new Oracle CMAN instance.
3. Start the new Oracle CMAN instance from the new `ORACLE_HOME` in migration mode. Use the following command:

```
cmctl startup -migrate -c cmn_alias
```

This command starts a new Oracle CMAN instance and initiates migrating of sessions from old Oracle CMAN instances. An old Oracle CMAN instance will exit as soon as the migration is complete or after 7 minutes timeout.

The address of the old Oracle CMAN instance is added in the `cmn.ora` file with the alias, `cmn_alias_old`. You can use this alias to control and check the status of old Oracle CMAN instance during migration.

You can migrate the sessions in the following scenarios:

- If both client to Oracle CMAN and Oracle CMAN to server use TCP.
- If either a client or a server uses TCPS (TLS) on one end and TCP on the other end. You must install Oracle Database 19c or later on both, the client using TCPS and the server using TCPS.

Unsupported connections will remain connected till the timeout duration.

### Note:

- If both client to Oracle CMAN and Oracle CMAN to server use TCPS, then the migration is not supported.
- Currently session migration is not supported on Microsoft Windows.

## 10.8 Oracle Connection Manager Enhancements

Oracle Connection Manager proxies and screens request for Oracle Database Server.

Starting with Oracle Database 12c release 2 (12.2), Oracle Connection Manager shows the following enhancements:

- It provides a more secure access to the server by supporting SSL protocol. With this support, the database client can communicate to the server through Oracle Connection Manager over TCPS protocol. You can also configure the Oracle Connection Manager to have SSL connection on one side and non-SSL connection on the other side. This also acts as a secure way to hide the internal database servers for the outside clients connecting from the internet.

Multiplexing: If the gateway already has the TCPS connection to the endpoint requested by the database client, then it multiplexes the new connect request on the same connection.

- It can listen on multiple protocol addresses. With multiple listening endpoints, Oracle Connection Manager is now able to support both TCP and TCPS at the same time. The existing single protocol address configuration is still supported. For example:

```
CMAN_ALIAS=
(configuration=
(address_list=
(address=(protocol=TCP)(host=a.b.c.d)(port=12522))
(address=(protocol=TCPS)(host=a.b.c.d)(port=12523))
)
..
)
```

- It has the addition of network data compression facility to improve network throughput and make data transfer faster between the Oracle Database Client and the Oracle Database Server. This is done in different ways according to the database client, database server, and the next hop compression ability. Compression is enabled between any two nodes if it is negotiated by them

If more than two consecutive nodes support and negotiate compression, such case is handled in a way that the intermediate node just relays the compressed data to the next node without performing decompression.

Compression is supported between the Oracle Connection Manager and the server, even if the Oracle Database Client is earlier than the Oracle Database 12c release and cannot support compression.

- It supports up to 2 MB SDU enabling the Oracle Database Client and the Oracle Database Server to negotiate higher SDU when establishing connection through Oracle Connection Manager.
- Starting with this release, valid node checking for registration is enabled by default in Oracle Connection Manager. By default, only the databases on local node are allowed to register with Oracle Connection Manager. The databases on remote node can be permitted or denied to register with Oracle Connection Manager through the use of parameters `REGISTRATION_INVITED_NODES` and `REGISTRATION_EXCLUDED_NODES`. These parameters are documented in *Oracle Database Net Services Reference*

- Starting with Oracle Database 20c, you can manage distribution of bandwidth across services using Oracle Connection Manager.

Oracle Connection Manager has the following enhancements:

- REST APIs for CMCTL Commands
- GROUP syntax for rules
- BANDWIDTH in bytes per second at service level

# 11

## Configuring a Shared Server Architecture

You can manage server loads on Oracle Database by managing dispatchers, and configuring your clients to take advantages of Oracle Net Services features.

- [How Oracle Net Manages Client Loads](#)  
Learn how Oracle Net manages system resource loads using shared server architecture.
- [About Dispatchers](#)
- [Enabling Session Multiplexing](#)
- [Configuring Clients for Environments with Both Shared and Dedicated Servers](#)

### 11.1 How Oracle Net Manages Client Loads

Learn how Oracle Net manages system resource loads using shared server architecture.

When client loads cause a strain on memory and other system resources, you can alleviate load issues by starting shared server resources. The **shared server** architecture enables a database server to allow many client processes to share very few server processes, so the number of users that the database can support is increased. With the shared server architecture, many client processes connect to a **dispatcher**. The dispatcher directs multiple incoming network session requests to a common queue. An idle shared server process from a shared pool of server processes picks up a request from the queue. This means a small pool of server processes can serve a large number of clients. This is useful when a system is overloaded or has limited memory.

### 11.2 About Dispatchers

Shared memory resources for dispatchers, virtual circuits, and shared servers are preconfigured enable shared servers at runtime. Database administrators can start dispatchers and shared servers with the SQL `ALTER SYSTEM` statement without having to restart the instance. When shared server mode is turned on, a dispatcher is started automatically on the TCP/IP protocol even if the `DISPATCHERS` parameter has not been set. Using a shared server is equivalent to setting the `DISPATCHERS` parameter in the database initialization parameter file as follows:

```
DISPATCHERS="(PROTOCOL=tcp)"
```

Configure the `DISPATCHERS` parameter directly if either of the following conditions apply:

- You need to configure a protocol other than TCP/IP.
- You want to configure one or more of the optional dispatcher attributes, such as multiplexing.

You can specify the following attributes for the DISPATCHERS parameter. The `PROTOCOL` attribute is required, and the others are optional. The `ADDRESS` attribute is used to set a specific port number, such as when using a firewall.

- ADDRESS
- CONNECTIONS
- DESCRIPTION
- DISPATCHERS
- LISTENER
- MULTIPLEX
- PROTOCOL (required)
- SERVICE
- SESSIONS

You change the dispatcher configuration using the SQL statement `ALTER SYSTEM`. You do not need to restart the instance after setting the parameters.

- [Grouping Services by Dispatcher](#)
- [Monitoring Dispatchers](#)



#### See Also:

*Oracle Database Administrator's Guide* for additional information about configuring dispatchers

## 11.2.1 Grouping Services by Dispatcher

An Oracle database can be represented by multiple service names. A pool of dispatchers can be allocated exclusively for clients requesting a particular service. This way, the mission critical requests may be given more resources and in effect increase their priority.

For example, the following initialization parameter file shows two dispatchers. The first dispatcher services requests for clients requesting `sales.us.example.com`. The other dispatcher services requests only for clients requesting `adminsales.us.example.com`.

```
SERVICE_NAMES=sales.us.example.com
INSTANCE_NAME=sales
DISPATCHERS="(PROTOCOL=tcp)"
DISPATCHERS="(PROTOCOL=tcp)(SERVICE=adminsales.us.example.com)"
```



#### Note:

You must manually start services on pluggable databases.



## 11.2.2 Monitoring Dispatchers

Use the following views to check configurations and monitor dispatchers:

- **V\$QUEUE**: Contains information about the shared server message queues. This view is only available to the `SYS` user, and users who have `SELECT ANY TABLE` system privilege, such as `SYSTEM`.
- **V\$DISPATCHER**: Provides information about the dispatcher processes, including name, network address, status, various usage statistics, and index number.
- **V\$DISPATCHER\_CONFIG**: Provides configuration information about the dispatchers.
- **V\$DISPATCHER\_RATE**: Provides rate statistics for the dispatcher processes.

### See Also:

- *Oracle Database Performance Tuning Guide* and *Oracle Database Reference* for additional information these views
- *Oracle Database Administrator's Guide* for additional information about shared server configuration
- *Oracle Database Reference* for additional information about configuring the `DISPATCHERS` parameter and supported attributes
- *Oracle Database SQL Reference* for additional information about the `ALTER SYSTEM` statement

## 11.3 Enabling Session Multiplexing

Session multiplexing, available with Oracle Connection Manager, enables multiple client sessions to funnel through a single protocol connection. For example, several client processes can connect to one dispatcher by way of a single connection from Oracle Connection Manager.

Oracle Connection Manager allows communication by users to the dispatcher by way of a shared connection. At any one time, users might need the connection, while other client processes linked to the dispatcher by way of the connection manager process are idle. Session multiplexing is beneficial because it maximizes use of the dispatcher process connections.

Session multiplexing is also useful for database link connections between dispatchers. The limit on the number of sessions for each dispatcher is operating system specific.

To enable session multiplexing, set the attribute `MULTIPLEX` in the `DISPATCHERS` parameter to `on` or an equivalent value.

```
DISPATCHERS="(PROTOCOL=tcp)(MULTIPLEX=on)"
```

**See Also:**

"Enabling Session Multiplexing for Oracle Connection Manager" for configuration details

## 11.4 Configuring Clients for Environments with Both Shared and Dedicated Servers

If a shared server is configured on the server side, and a client connection request arrives when no dispatchers are registered, then the request is processed by a dedicated server process. If you want a particular client always to use a dispatcher, then configure `(SERVER=shared)` in the `CONNECT_DATA` section of the connect descriptor. For example:

```
sales=
(DESCRIPTION=
  (ADDRESS=(PROTOCOL=tcp)(HOST=sales-server)(PORT=1521))
  (CONNECT_DATA=
    (SERVICE_NAME=sales.us.example.com)
    (SERVER=shared)))
```

If the `(SERVER=shared)` attribute is configured and a dispatcher is not available, then the client connection request is rejected, and a message is sent to the client.

If the database is configured for a shared server and a particular client requires a dedicated server, then you can configure the client to use a dedicated server in one of the following ways:

- You can configure a network service name with a connect descriptor that contains `(SERVER=dedicated)` in the `CONNECT_DATA` section. For example:

```
sales=
(DESCRIPTION=
  (ADDRESS=(PROTOCOL=tcp)(HOST=sales-server)(PORT=1521))
  (CONNECT_DATA=
    (SERVICE_NAME=sales.us.example.com)
    (SERVER=dedicated)))
```

- You can configure the client profile file, `sqlnet.ora`, with `USE_DEDICATED_SERVER=on`. This adds `(SERVER=dedicated)` to the `CONNECT_DATA` section of the connect descriptor the client uses.

**Note:**

If `USE_DEDICATED_SERVER` is set to `ON`, then existing `(SERVER=value)` entries in connect descriptors are overwritten with `(SERVER=dedicated)`.

 **See Also:**

- ["About the Advanced Connect Data Parameters"](#) to set the SERVER parameter
- ["Routing Connection Requests to a Process"](#) to set the USE\_DEDICATED\_SERVER parameter
- *Oracle Call Interface Programmer's Guide* and *Oracle Database Administrator's Guide*

# 12

## Configuring Profiles

Learn how to configure client and server configuration parameters in profiles. A profile is a collection of parameters that specifies preferences for enabling and configuring Oracle Net features on the client or database server. A profile is stored and implemented through the `sqlnet.ora` file.

- [Overview of Profile Configuration](#)
- [Configuring the Profile During Installation](#)
- [Understanding Client Attributes for Names Resolution](#)
- [Settings for Database Access Control](#)
- [About Advanced Profile Information](#)
- [Configuring External Naming Methods](#)
- [Configuring Oracle Network Security](#)

### 12.1 Overview of Profile Configuration

You can use a profile to do the following:

- Specify the client domain to append to unqualified names
- Prioritize naming methods
- Enable logging and tracing features
- Route connections through specific processes
- Configure parameters for an external procedure
- Configure Oracle Advanced Security
- Use protocol-specific parameters to restrict access to the database

### 12.2 Configuring the Profile During Installation

Oracle Universal Installer launches Oracle Net Configuration Assistant after software installation on the client and server. Oracle Net Configuration Assistant configures the order of the naming methods that the computer uses to resolve a connect identifier to a connect descriptor.

Configuration with the Oracle Net Configuration Assistant during installation results in an entry in the `sqlnet.ora` file similar to the following:

```
NAMES.DIRECTORY_PATH=(ezconnect,tnsnames)
```

The `NAMES.DIRECTORY_PATH` parameter specifies the priority order of the naming methods to use to resolve connect identifiers. If the installed configuration is not adequate, then use Oracle Net Manager to change the `sqlnet.ora` configuration.

## 12.3 Understanding Client Attributes for Names Resolution

The following sections describe available client configuration options:

- [About the Default Domain for Clients](#)
- [Prioritizing Naming Methods](#)
- [Routing Connection Requests to a Process](#)

### 12.3.1 About the Default Domain for Clients

In environments where the client often requests names from a specific domain, it is appropriate to set a default domain in the client `sqlnet.ora` file with the `NAMES.DEFAULT_DOMAIN` parameter. This parameter is available to the local and external naming methods.

When a default domain is set, it is automatically appended to any unqualified network service name given in the connect string, and then compared to network service names stored in a `tnsnames.ora` file.

For example, if the client `tnsnames.ora` file contains a network service name of `sales.us.example.com`, and the default domain is `us.example.com`, then the user can enter the following connect string:

```
CONNECT scott@sales
Enter password: password
```

In the preceding example, `sales` gets searched as `sales.us.example.com`.

If the connect string includes the domain extension, such as in `CONNECT scott@sales.us.example.com`, then the domain is not appended.

If a network service name in a `tnsnames.ora` file is not domain qualified and the `NAMES.DEFAULT_DOMAIN` parameter is set, then the network service name must be entered with a period (.) at the end of the name. For example, if the domain is set to `us.example.com` and the client `tnsnames.ora` file contains a network service name of `sales2`, then the user would enter the following connect string:

```
CONNECT scott@sales2.
Enter password: password
```

In the preceding example, the client would connect to `sales2`, not `sales2.us.example.com`.

- [Specifying a Default Domain](#)

#### 12.3.1.1 Specifying a Default Domain

The following procedure describes how to specify a default domain:

1. Start Oracle Net Manager.

 **See Also:**

["Using Oracle Net Manager to Configure Oracle Net Services"](#)

2. In the navigator pane, select **Profile** from the Local menu.
3. From the list in the right pane, select **Naming**.
4. Click the **Methods** tab.
5. In the Default Domain field, enter the domain.
6. Select **Save Network Configuration** from the File menu.

The `sqlnet.ora` file should contain an entry that looks similar to the following:

```
NAMES.DEFAULT_DOMAIN=us.example.com
```

## 12.3.2 Prioritizing Naming Methods

After naming methods are configured, as described in [Configuring Naming Methods](#), they must be prioritized. Naming methods to resolve a connect identifier are tried in the order they appear in the list. If the first naming method in the list cannot resolve the connect identifier, then the second method in the list is used, and so on.

The following procedure describes how to specify the order of naming methods:

1. Start Oracle Net Manager.

 **See Also:**

["Using Oracle Net Manager to Configure Oracle Net Services"](#)

2. In the navigator pane, select **Profile** from the Local menu.
3. From the list in the right pane, select **Naming**.
4. Click the **Methods** tab.

[Table 12-1](#) describes the naming method values listed in the Methods tab.

**Table 12-1 Naming Method Values**

Naming Method Value	Description
TNSNAMES	Resolve a network service name through the <code>tnsnames.ora</code> file on the client. <b>See Also:</b> <a href="#">"Configuring the Local Naming Method"</a>
LDAP	Resolve a database service name, network service name, or network service alias through a directory server. <b>See Also:</b> <a href="#">"Configuring the Directory Naming Method"</a>

**Table 12-1 (Cont.) Naming Method Values**

Naming Method Value	Description
EZCONNECT	Enable clients to use a TCP/IP connect identifier, consisting of a host name and optional port and service name, or resolve a host name alias through an existing names resolution service or centrally maintained set of <code>/etc/hosts</code> files.  <b>See Also:</b> " <a href="#">Understanding the Easy Connect Naming Method</a> "
NIS	Resolve service information through an existing network information service (NIS).

5. Select naming methods from the Available Methods list, and then click the right-arrow button.

The selected naming methods move to the Selected Methods list.

6. Order the naming methods according to the order in which you want Oracle Net to try to resolve the network service name or database service name. Select a naming method in the Selected Methods list, and then click **Promote** or **Demote** to move the selection up or down in the list.
7. Select **Save Network Configuration** from the File menu.

The `sqlnet.ora` file updates with the `NAMES.DIRECTORY_PATH` parameter, such as the following:

```
NAMES.DIRECTORY_PATH=(ldap, tnsnames)
```

### 12.3.3 Routing Connection Requests to a Process

Clients and servers can be configured so connection requests are directed to a specific process. The following procedure describes how to route connection requests to a process:

1. Start Oracle Net Manager.

 **See Also:**

["Using Oracle Net Manager to Configure Oracle Net Services"](#)

2. In the navigator pane, select **Profile** from the Local menu.
3. From the list in the right pane, select **General**.
4. Click the **Routing** tab.
5. Select the preferred way for routing connections.

 **Note:**

To configure all connections to use a particular server, you select the **Always Use Dedicated Server** option in Oracle Net Manager. This sets the `USE_DEDICATED_SERVER` parameter in the `sqlnet.ora` file to force the listener to spawn a dedicated server for all network sessions from the client. The result is a dedicated server connection, even if a shared server is configured.

6. Choose **Save Network Configuration** from the File menu.

 **See Also:**

[Table 12-3](#) for a description of the fields and options

## 12.4 Settings for Database Access Control

You can configure the `sqlnet.ora` file to allow access to some clients and deny access to others. [Table 12-2](#) describes the available settings.

**Table 12-2 Access Control Settings in sqlnet.ora**

Oracle Net Manager Field/Option	sqlnet.ora File Parameter	Description
Check TCP/IP client access rights	TCP.VALIDNODE_CHECKING	Specify whether to screen access to the database. If this field is selected, then Oracle Net Manager checks the parameters <code>TCP.EXCLUDED_NODES</code> and <code>TCP.INVITED_NODES</code> to determine which clients to allow access to the database. If this field is deselected, then Oracle Net Manager does not screen clients.
Clients excluded from access	TCP.EXCLUDED_NODES	Specify which clients using the TCP/IP protocol are excluded access to the database.
Clients allowed access	TCP.INVITED_NODES	Specify which clients using the TCP/IP protocol are allowed access to the database.

If the `TCP.INVITED_NODES` parameter does not include the listener node, then the Listener Control utility cannot connect to the listener. This will prevent start, stop and administration commands from being performed on the listener.

If there are invalid host names or IP addresses listed in the `TCP.INVITED_NODES` parameter or the `TCP.EXCLUDED_NODES` parameter, then the Listener Control utility cannot contact the listener.

- [Configuring Database Access Control](#)

### 12.4.1 Configuring Database Access Control

The following procedure describes how to configure database access control:



1. Start Oracle Net Manager.



**See Also:**

["Using Oracle Net Manager to Configure Oracle Net Services"](#)

2. In the navigator pane, select **Profile** from the Local menu.
3. From the list in the right pane, select **General**.
4. Click the **Access Rights** tab.
5. Select the **Check TCP/IP client access rights** option.
6. In the Clients allowed to access fields and Clients excluded from access field, enter either a host name or an IP address for a client that you want to include or exclude, using commas to delimit entries placed on the same line.

## 12.5 About Advanced Profile Information

Table 12-3 describes the advanced `sqlnet.ora` file settings that you can set.

**Table 12-3** Advanced Settings in `sqlnet.ora`

Oracle Net Manager Field/Option	sqlnet.ora File Parameter	Description
Send operation Time Out	SQLNET.SEND_TIMEOUT	<p>Specify the time, in ms, seconds, or minutes, for a database client or server to wait for data from the peer after establishing a connection.</p> <p>Setting this parameter for clients ensure that receive operation is not left in wait state indefinitely or for a long period due to an abnormal termination of server process or server busy state. If a client does not receive response data in time specified, then it logs <code>ORA-12535: TNS:operation timed out</code> and <code>ORA-12609: TNS: Receive timeout occurred</code> errors in the <code>sqlnet.log</code> file.</p> <p>You can also set this parameter on the server-side to specify the time, in ms, sec, or min, for a server to wait for client data after connection establishment. If a client does not send any data in the specified time, then the database server logs <code>ORA-12535: TNS:operation timed out</code> and <code>ORA-12609: TNS: Receive timeout occurred</code> messages to the <code>sqlnet.log</code> file. Without this parameter, the database server may continue to wait for data from clients that may be down or are experiencing difficulties. The server usually blocks on input from the client and gets these timeouts frequently if set to a low value.</p>

**Table 12-3 (Cont.) Advanced Settings in sqlnet.ora**

Oracle Net Manager Field/Option	sqlnet.ora File Parameter	Description
Receive operation Time Out	SQLNET.RECV_TIMEOUT	<p>Specify the time, in seconds, for a database server to wait for client data after connection establishment. A client must send some data within the specified time interval.</p> <p>Setting this parameter is recommended for environments in which clients shut down on occasion or abnormally. If a client does not send any data in the time specified, then the database server logs ORA-12535: TNS:operation timed out and ORA-12609: TNS: Receive timeout occurred errors to the sqlnet.log file.</p> <p>Without this parameter, the database server continues to wait for data from clients that may be down or are experiencing difficulties.</p> <p>You can also use this setting on the client side to specify the time, in seconds, for a client to wait for response data from the database server after connection establishment. Without this parameter, the client may wait for a long period of time for a response from a database server overwhelmed with requests.</p>
Connection Time Out	SQLNET.INBOUND_CONNECT_TIMEOUT	Specify the time, in seconds, for a client to connect with the database server and provide the necessary authentication information.
Total Send Buffer Size	SEND_BUF_SIZE	Specify the buffer space limit for send operations of sessions.
Total Receive Buffer Size	RECV_BUF_SIZE	Specify the buffer space limit for receive operations of sessions.
TNS Time Out Value	SQLNET.EXPIRE_TIME	<p>Specify time intervals, in minutes, to send a probe to verify that client/server connections are active. Setting a value greater than 0 ensures that connections are not left open indefinitely, due to an abnormal client termination. If the probe finds a terminated connection, or a connection that is no longer in use, then it returns an error, causing the server process to exit. This setting is intended for the database server, which typically handles multiple connections at any one time.</p> <p>You can also use this parameter for database clients to verify if the server connection is active.</p> <p>Limitations on using this terminated connection detection feature are:</p> <ul style="list-style-type: none"> <li>• You cannot use it on bequeathed connections.</li> <li>• Though very small, a probe packet generates additional traffic that may degrade your network performance.</li> <li>• Depending on your operating system, the server may need to perform additional processing to distinguish the connection probing event from other events. This can also result in degraded network performance.</li> </ul>
Client Registration ID	SQLNET.CLIENT_REGISTRATION	Specify a unique identifier for a client. This identifier is passed to the listener with any connection request. The identifier can be any string up to 128 characters long.

Table 12-3 (Cont.) Advanced Settings in sqlnet.ora

Oracle Net Manager Field/Option	sqlnet.ora File Parameter	Description
Logon Authentication Protocol Version	SQLNET.ALLOWED_LOGON_VERSION_CLIENT SQLNET.ALLOWED_LOGON_VERSION_SERVER	<p>Define the minimum authentication protocol allowed when connecting to Oracle Database instances. The term <code>VERSION</code> in the parameter name refers to the version of the authentication protocol, not the Oracle Database release. If the client or server does not meet the minimum release specified by its partner, then authentication fails with an <code>ORA-28040</code> error.</p> <p>Supported values include:</p> <ul style="list-style-type: none"> <li>• 12a for Oracle Database 12c authentication protocols (strongest protection)</li> <li>• 12 for the critical patch updates CPUOct2012 and later Oracle Database 11g authentication protocols (recommended)</li> <li>• 11 for Oracle Database 11g authentication protocols</li> <li>• 10 for Oracle Database 10g authentication protocols</li> <li>• 9 for Oracle9i Database authentication protocol</li> <li>• 8 for Oracle8i Database authentication protocol</li> </ul> <p>The default value is 12 or 12a. Note the following implications of setting the value to 11 or 12:</p> <ul style="list-style-type: none"> <li>• The setting <code>SEC_CASE_SENSITIVE_LOGON=FALSE</code> must not be used. If it is set as <code>FALSE</code>, then user accounts and secure roles become unusable. The <code>SEC_CASE_SENSITIVE_LOGON</code> initialization parameter enables or disables case sensitivity for passwords.</li> <li>• To take advantage of the password protections introduced in Oracle Database 11g, users must change their passwords.</li> <li>• Releases of OCI clients before Oracle Database 10g and all versions of JDBC thin clients cannot authenticate to the Oracle database using password-based authentication.</li> </ul> <p>When an Oracle Database 12c server has a database link to a server running an earlier Oracle Database release, set the value of the <code>SQLNET.ALLOWED_LOGON_VERSION_CLIENT</code> parameter on the Oracle Database 12c server to match the <code>SQLNET.ALLOWED_LOGON_VERSION</code> setting of the server running the earlier release.</p>
Turn Off UNIX Signal Handling	BEQUEATH_DETACH	<p>Turn on or off UNIX signal handling.</p> <p>Because the client application spawns a server process internally through the bequeath protocol as a child process, the client application becomes responsible for cleaning up the child process when it completes. When the server process completes its connection responsibilities, it becomes a terminated process. Signal handlers are responsible for cleaning up these terminated processes. Setting this parameter configures the client profile to pass this process to the UNIX initialization process by disabling signal handlers.</p>

Table 12-3 (Cont.) Advanced Settings in sqlnet.ora

Oracle Net Manager Field/Option	sqlnet.ora File Parameter	Description
Disable Out-of-Band Break	DISABLE_OOB	Turn on or off out-of-band breaks.  If deselected or set to <code>off</code> , then Oracle Net can send and receive break messages using urgent data requests provided by the underlying protocol. Once enabled, this feature applies to all protocols used by this client.  If selected or set to <code>on</code> , then it disables the ability to send and receive break messages using urgent data requests of the underlying protocol.
Disable Out-of-Band Auto Break option	DISABLE_OOB_AUTO	Checks TCP OOB (Out of Band) support in client to server path at the connection time. The client enables OOB only if the server path supports OOB.

- [Setting the Advanced Features in the sqlnet.ora File Using Oracle Net Services](#)

 **See Also:**

- "[Limiting Resource Consumption by Unauthorized Users](#)" for complete information about configuring the `SQLNET.INBOUND_CONNECT_TIMEOUT` setting
- "[Configuring I/O Buffer Space](#)" for complete information about configuring the `SEND_BUF_SIZE` and `RECV_BUF_SIZE` settings
- *Oracle Database Security Guide* for additional information about the `SQLNET.ALLOWED_LOGON_VERSION_CLIENT` and `SQLNET.ALLOWED_LOGON_VERSION_SERVER` settings
- *Oracle Database Net Services Reference* for additional information about the `SQLNET.ALLOWED_LOGON_VERSION_CLIENT` and `SQLNET.ALLOWED_LOGON_VERSION_SERVER` settings
- Oracle operating system-specific documentation to determine if the protocol supports urgent data requests. TCP/IP is an example of a protocol that supports this feature.

## 12.5.1 Setting the Advanced Features in the sqlnet.ora File Using Oracle Net Services

The following procedure describes how to set advanced features in the `sqlnet.ora` file:

1. Start Oracle Net Manager.

 **See Also:**

["Using Oracle Net Manager to Configure Oracle Net Services"](#)

2. In the navigator pane, select **Profile** from the Local menu.
3. From the list in the right pane, select **General**.
4. Click the **Advanced** tab.
5. Enter the values for the fields or options you want to set.
6. Select **Save Network Configuration** from the File menu.

## 12.6 Configuring External Naming Methods

The `sqlnet.ora` file is used to configure required client parameters needed for Network Information Service (NIS) external naming. The following procedure describes how to configure the NIS parameter in the `sqlnet.ora` file:

1. Start Oracle Net Manager.

 **See Also:**

["Using Oracle Net Manager to Configure Oracle Net Services"](#)

2. In the navigator pane, select **Profile** from the File menu.
3. From the list in the right pane, select **Naming**.
4. Click the **External** tab.
5. Enter `NAMES.NIS.META_MAP` in the Meta Map field.
6. Select **Save Network Configuration** from the File menu.

## 12.7 Configuring Oracle Network Security

Oracle network security features enable data encryption and integrity checking, enhanced authentication, and single sign-on. The features also provide centralized user management on LDAP-compliant directory servers and certificate-based single sign-on. This functionality relies on the Secure Sockets Layer (SSL).

The following procedure describes how to configure a client or server to use Oracle network security features:

1. Start Oracle Net Manager.

 **See Also:**

["Using Oracle Net Manager to Configure Oracle Net Services"](#)

2. In the navigator pane, select **Profile** from the Local menu.

3. From the list in the right pane, select **Network Security**.

Each Network Security tab page enables you to configure a separate set of parameters. The tab pages are as follows:

- Authentication: For configuration of available authentication methods, such as KERBEROS5 and RADIUS.
  - Other Params: For configuration of the authentication service.
  - Integrity: For configuration of the type of integrity, checksum level and available methods.
  - Encryption: For configuration of the encryption type and method.
  - SSL: For setting the use of SSL.
4. Select or edit options as applicable.
5. Select **Save Network Configuration** from the File menu.

 **See Also:**

- The help button on the particular tab page
- Network security topics in the Oracle Net Manager online help. To access these topics in the online help, select Network Security, and then select the How To option
- *Oracle Database Security Guide* for additional information about configuration

# 13

## Enabling Advanced Features of Oracle Net Services

Understand how to configure the advanced features of Oracle Net Services, including advanced connect data parameters, load balancing, failover, and connections to non-database services.

- [Configuring Advanced Network Address and Connect Data Information](#)
- [Understanding Connection Load Balancing](#)
- [Configuring Transparent Application Failover](#)
- [Specifying the Instance Role for Primary and Secondary Instance Configurations](#)
- [Understanding Static Service Registration](#)
- [Configuring Connections to Third-Party Database Services](#)

### 13.1 Configuring Advanced Network Address and Connect Data Information

A database service can be accessed by several routes and protocol addresses. You configure which routes to use by setting the list of protocol addresses. You configure the order addresses are used by specifying the address parameters.

- [Creating a List of Listener Protocol Addresses](#)
- [About the Address List Parameters](#)
- [About the Advanced Connect Data Parameters](#)

#### 13.1.1 Creating a List of Listener Protocol Addresses

A database service may be accessed by more than one network route, or protocol address. In the following example, `sales.us.example.com` can connect to the `sales.us.example.com` service using listeners on either `sales1-server` or `sales2-server`.

```
sales.us.example.com=  
(DESCRIPTION=  
  (ADDRESS_LIST=  
    (ADDRESS=(PROTOCOL=tcp)(HOST=sales1-server)(PORT=1521))  
    (ADDRESS=(PROTOCOL=tcp)(HOST=sales2-server)(PORT=1521)))  
  (CONNECT_DATA=  
    (SERVICE_NAME=sales.us.example.com)))
```

To add a network protocol address to an existing network service name or database service, use one of the following procedures:

- [Adding a Network Protocol Using Oracle Enterprise Manager Cloud Control](#)

- [Adding a Network Protocol Using Oracle Net Manager](#)

### Adding a Network Protocol Using Oracle Enterprise Manager Cloud Control

The following procedure describes how to add a network protocol to an existing network service name or database service using Oracle Enterprise Manager Cloud Control:

1. Access the Directory Naming or Local Naming page in Oracle Enterprise Manager Cloud Control:
  - a. Access the Net Services Administration page in Oracle Enterprise Manager Cloud Control.



#### See Also:

["Using Oracle Enterprise Manager Cloud Control to Configure Oracle Net Services"](#)

- b. Select **Local Naming** or **Directory Naming** from the Administer list, and then select the Oracle home for the directory server or the location of the local configuration files.
  - c. Click **Go**.

The Local Naming or Directory Naming page appears.
2. Select the directory service or network service name.
    - For Local Naming, select a network service from the list, and then click **Edit**.
    - For Directory Naming, perform a search of the network service name in the Simple Search section, then select the network service or database service from the Results list, and then click **Edit**.
  3. In the Addresses section, click **Add**.

The Add Address page appears.
  4. From the Protocol list, select the protocol which the listener is configured to listen. This protocol must also be installed on the client.
  5. Enter the appropriate parameter information for the selected protocol in the fields provided.



#### See Also:

*Oracle Database Net Services Reference* for protocol parameter settings

6. (Optional) In the Advanced Parameters section, specify the I/O buffer space limit for send and receive operations of sessions in the Total Send Buffer Size and Total Receive Buffer Size fields.





**See Also:**

"[Configuring I/O Buffer Space](#)" for additional information about buffer space

7. Click **OK**.  
The protocol address is added to the Addresses section.
8. Click **OK** to update the address information.

### Adding a Network Protocol Using Oracle Net Manager

The following procedure describes how to add a network protocol to an existing network service name or database service using Oracle Net Manager:

1. Start Oracle Net Manager.



**See Also:**

"[Using Oracle Net Manager to Configure Oracle Net Services](#)"

2. In the navigator pane, select **Service Naming** from the Directory or Local menus.
3. Select either the network service name or a database service.  
The right pane displays the current destination service and address list.
4. In the Address Configuration box, click the plus sign (+) to add a new address.  
A new Address tab appears:
  - a. Select the protocol and enter appropriate address information.



**See Also:**

*Oracle Database Net Services Reference* for details about protocol address parameters

- b. (Optional) On the Address tab, click **Advanced** to specify the I/O buffer space limit for send and receive operations of sessions in the Total Send Buffer Size and Total Receive Buffer Size fields.



**See Also:**

"[Configuring I/O Buffer Space](#)" for additional information about buffer space

- c. Order the protocol addresses using the left-arrow and right-arrow buttons. This will order the addresses in the protocol address list. Unless multiple address options are configured, the first address in the list is contacted.
5. Select **Save Network Configuration** from the File menu.

## 13.1.2 About the Address List Parameters

When a database service is accessible by multiple listener protocol addresses, specify the order in which the addresses are to be used, such as chosen randomly or tried sequentially. The following table lists the parameters used with multiple protocol addresses.

**Table 13-1 Address List Parameters in the tnsnames.ora File**

Parameter	Description
FAILOVER	<p>At connect time, this parameter instructs Oracle Net to fail over to a different listener if the first listener fails when set to <code>on</code>. The number of addresses in the list determines how many addresses are tried. When set to <code>off</code>, instructs Oracle Net to try one address.</p> <p>Connect-time failover is turned <code>on</code> by default for multiple address lists (<code>ADDRESS_LIST</code>), connect descriptors (<code>DESCRIPTION</code>), and multiple connect descriptors (<code>DESCRIPTION_LIST</code>).</p>
LOAD_BALANCE	<p>When set to <code>on</code>, this parameter instructs Oracle Net to progress through the list of protocol addresses in a random sequence, balancing the load on the various listeners. When set to <code>off</code>, instructs Oracle Net to try the addresses sequentially until one succeeds.</p> <p>Client load balancing is turned <code>on</code> by default for multiple connect descriptors (<code>DESCRIPTION_LIST</code>).</p>
SOURCE_ROUTE	<p>When set to <code>on</code>, this parameter instructs Oracle Net to use each address in the order presented until the destination is reached. This parameter is required for reaching the destination using a specific route, that is, by specific computers. This parameter is used to enable connections to Oracle Connection Manager.</p>

 **Note:**

You cannot set source routing (`SOURCE_ROUTE`) at the same level as connect-time failover (`FAILOVER`) or client load balancing (`LOAD_BALANCE`). Source routing connects to each address in the list sequentially whereas connect-time failover and client load balancing select a single address from a list.

When a connect descriptor in a `tnsnames.ora` file contains at least two protocol addresses for an Oracle Connection Manager hop, then parameters for connect-time failover and load balancing within the hop can be included in the file.

The following table describes the address list options.

**Table 13-2 Address List Options Dialog Box**

Option	Parameter Setting
Try each address, in order, until one succeeds.	FAILOVER=on
Try each address, randomly, until one succeeds.	LOAD_BALANCE=on FAILOVER=on
Try one address, selected at random.	LOAD_BALANCE=on
Use each address in order until destination reached.	SOURCE_ROUTE=on
Use only the first address.	LOAD_BALANCE=off FAILOVER=off SOURCE_ROUTE=off

The following example shows a `tnsnames.ora` file configured for client load balancing:

```
sales.us.example.com=
  (DESCRIPTION=
    (ADDRESS_LIST=
      (LOAD_BALANCE=on)
      (ADDRESS=(PROTOCOL=tcp)(HOST=sales1-server)(PORT=1521))
      (ADDRESS=(PROTOCOL=tcp)(HOST=sales2-server)(PORT=1521)))
    (CONNECT_DATA=
      (SERVICE_NAME=sales.us.example.com)))
```

The following example shows a `tnsnames.ora` file configured for connect-time failover:

```
sales.us.example.com=
  (DESCRIPTION=
    (ADDRESS_LIST=
      (LOAD_BALANCE=off)
      (FAILOVER=on)
      (ADDRESS=(PROTOCOL=tcp)(HOST=sales1-server)(PORT=1521))
      (ADDRESS=(PROTOCOL=tcp)(HOST=sales2-server)(PORT=1521)))
    (CONNECT_DATA=
      (SERVICE_NAME=sales.us.example.com)))
```

The following example shows a `tnsnames.ora` file configured for Oracle Connection Manager and load balancing:

```
sales.us.example.com=
  (DESCRIPTION=
    (SOURCE_ROUTE=ON)
    (ADDRESS=(PROTOCOL=tcp)(HOST=cman-pc1)(PORT=1630))
    (ADDRESS=
      (LOAD_BALANCE=ON)
      (ADDRESS=(PROTOCOL=tcp)(HOST=cman-pc2)(PORT=1521))
      (ADDRESS=(PROTOCOL=tcp)(HOST=cman-pc3)(PORT=1521)))
    (CONNECT_DATA=
      (SERVICE_NAME=sales.us.example.com)))
```

- [Configuring Address List Parameters](#)



**See Also:**

"[Configuring Clients for Oracle Connection Manager](#)" for additional information about configuring clients for source routing

### 13.1.2.1 Configuring Address List Parameters

The following procedure describes how to configure address list parameters:

1. Perform the procedure in "[Creating a List of Listener Protocol Addresses](#)".
2. Use Oracle Enterprise Manager Cloud Control or Oracle Net Manager to configure address list options.
  - For Oracle Enterprise Manager Cloud Control, select the appropriate option in the Connect-time Failover and Client Load Balancing section.
  - For Oracle Net Manager, click **Advanced** in the Address Configuration box. The Address List Options dialog box appears. Select the appropriate option.

### 13.1.3 About the Advanced Connect Data Parameters

Starting with Oracle Database 12c release 2 (12.2), data compression can be set in the `sqlnet.ora` file. The parameters that set compression are `SQLNET.COMPRESSION` and `SQLNET.COMPRESSION_LEVELS`. Setting these parameters in the `sqlnet.ora` file affects all the connections using the `sqlnet.ora` file, except for Oracle Data Guard streaming redo and SecureFiles LOBs (Large Objects). The following example shows how to set compression:

```
SQLNET.COMPRESSION = on
SQLNET.COMPRESSION_LEVELS =(low,high)
```

The `CONNECT_DATA` section of a connect descriptor in the `tnsnames.ora` file defines the destination database service. In the following example, `SERVICE_NAME` defines a service called `sales.us.example.com`:

```
sales.us.example.com=
  (DESCRIPTION=
    (ADDRESS=(PROTOCOL=tcp)(HOST=sales-server)(PORT=1521))
    (CONNECT_DATA=
      (SERVICE_NAME=sales.us.example.com)))
```

In addition to the service name, you can optionally configure the connect data information with the parameters described in [Table 13-3](#).

**Table 13-3 Advanced Connect Data Settings in the `tnsnames.ora` File**

Oracle Enterprise Manager Cloud Control/Oracle Net Manager Option	<code>tnsnames.ora</code> File Parameter	Description
Instance Name	<code>INSTANCE_NAME</code>	The database instance to access. The instance name can be obtained from the <code>INSTANCE_NAME</code> parameter in the initialization parameter file.

**Table 13-3 (Cont.) Advanced Connect Data Settings in the tnsnames.ora File**

Oracle Enterprise Manager Cloud Control/Oracle Net Manager Option	tnsnames.ora File Parameter	Description
Session Data Unit Size	SDU	The transfer rate of data packets being sent across the network. You can specify the session data unit (SDU) size to change the performance characteristics having to do with the packets sent across the network. The SDU size limit is 2 MB.
Use for Heterogeneous Services	HS	If you want an Oracle database server to access a third-party system through Heterogeneous Services, then set this option to on.
Oracle RDB Database	RDB_DATABASE	The file name of the Oracle Rdb database.
Type of Service	TYPE_OF_SERVICE	The type of service to use for the Oracle Rdb database.
Global Database Name	GLOBAL_NAME	Oracle Rdb database identifier.

In the following example, the transfer rate for data packets is set:

```
sales.us.example.com=
  (DESCRIPTION=
    (ADDRESS=(PROTOCOL=tcp)(HOST=sales-server)(PORT=1521))
    (CONNECT_DATA=
      (SERVICE_NAME=sales.us.example.com)
      (SDU=8192)))
```

Use Oracle Enterprise Manager Cloud Control or Oracle Net Manager to configure advanced CONNECT\_DATA parameters for either a network service name or a database service.

### Configuring Advanced Connect Descriptor Parameters Using Oracle Enterprise Manager Cloud Control

The following procedure describes how to configure advanced connect descriptor parameters using Oracle Enterprise Manager Cloud Control:

1. Access the Directory Naming or Local Naming page in Oracle Enterprise Manager Cloud Control, as follows:
  - a. Access the Net Services Administration page in Oracle Enterprise Manager Cloud Control.

 **See Also:**

["Using Oracle Enterprise Manager Cloud Control to Configure Oracle Net Services"](#)

- b. Select **Local Naming** or **Directory Naming** from the **Administer** list, and then select the Oracle home for the directory server or the location of the local configuration files.

- c. Click **Go**.  
The Directory Naming or Local Naming pages appear.
2. Select the directory service or network service name.
  - For Local Naming, select a network service from the list, and then click **Edit**.
  - For Directory Naming, search the network service name in the Simple Search section by selecting the network service or database service from the Results list, and then clicking **Edit**.
3. Click the **Advanced** tab.
4. Enter fields or select options as appropriate, and then click **OK**.
5. Click **OK** to update the connect data information.

### Configuring Advanced Connect Descriptor Parameters Using Oracle Net Manager

The following procedure describes how to configure advanced connect descriptor parameters using Oracle Net Manager:

1. Start Oracle Net Manager.

 **See Also:**

["Using Oracle Net Manager to Configure Oracle Net Services"](#)

2. In the navigator pane, select **Service Naming** from Directory or Local menus.
3. Select either the network service name or a database service.  
The right pane displays the current destination service and address list.
4. In the Service Identification box, click **Advanced**.  
The Advanced Service Options dialog box appears.
5. Enter fields or select options as appropriate, and then click **OK**.
6. If you are making these changes to the Local folder, then select **Save Network Configuration** from the File menu. Changes to the Directory folder are saved automatically.

## 13.2 Understanding Connection Load Balancing

The connection load balancing feature improves connection performance by balancing the number of active connections among multiple dispatchers. In an Oracle Real Application Clusters (Oracle RAC) environment, connection load balancing can also balance the number of active connections among multiple instances.

Because the Listener Registration (LREG) process can register with remote listeners, a listener can always be aware of all instances and dispatchers, regardless of their location. Depending on the load information, a listener decides which instance and, if shared server is configured, which dispatcher to send the incoming client request.

In a shared server configuration, a listener selects a dispatcher in the following order:

1. Least loaded node.

2. Least loaded instance.
3. Least loaded dispatcher for that instance.

In a dedicated server configuration, a listener selects an instance in the following order:

1. Least loaded node.
2. Least loaded instance.

Load Balancing across nodes for HTTP presentation is introduced in this release. The remote listener can load balance across instances that are on different nodes for HTTP presentation using HTTP redirect.

An Oracle RAC environment requires that the dispatchers on each instance be cross-registered with the other listeners on the other nodes. This is achieved by the use of the `LISTENER` attribute of the `DISPATCHERS` parameter.

 **Note:**

For optimum connection load balancing results, the instances that belong to the same database service should be on equivalent hardware and software configurations.

- [Example of Connection Load Balancing for Shared Server Configuration](#)
- [Example of Connection Load Balancing for Dedicated Server Configuration](#)
- [COLOCATION\\_TAG of Client Connections](#)

The `COLOCATION_TAG` parameter is an alphanumeric string that you can use with the `CONNECT_DATA` parameter of the TNS connect string.

 **See Also:**

- ["Registering Information with a Remote Listener"](#) for additional information about cross-registration
- *Oracle Database Reference* for complete information about the `SERVICE_NAMES` and `INSTANCE_NAME` parameters
- [Configuring a Shared Server Architecture](#) for additional information about the `LISTENER` attribute
- *Oracle Database Global Data Services Concepts and Administration Guide* for information about management of global services

## 13.2.1 Example of Connection Load Balancing for Shared Server Configuration

**Figure 13-1** shows an Oracle RAC shared server database with two instances, `sales1` and `sales2`, of the same service, `sales.us.example.com`. The instances `sales1` and

sales2 reside on computers sales1-server and sales2-server, respectively. Instance sales1 has one dispatcher and instance sales2 has two dispatchers. Listeners named listener run on nodes 1 and 2. The listener attribute in the DISPATCHERS parameter has been configured to allow for service registration of information to both listeners.

**Figure 13-1 Load Balancing Environment for a Shared Server Configuration**

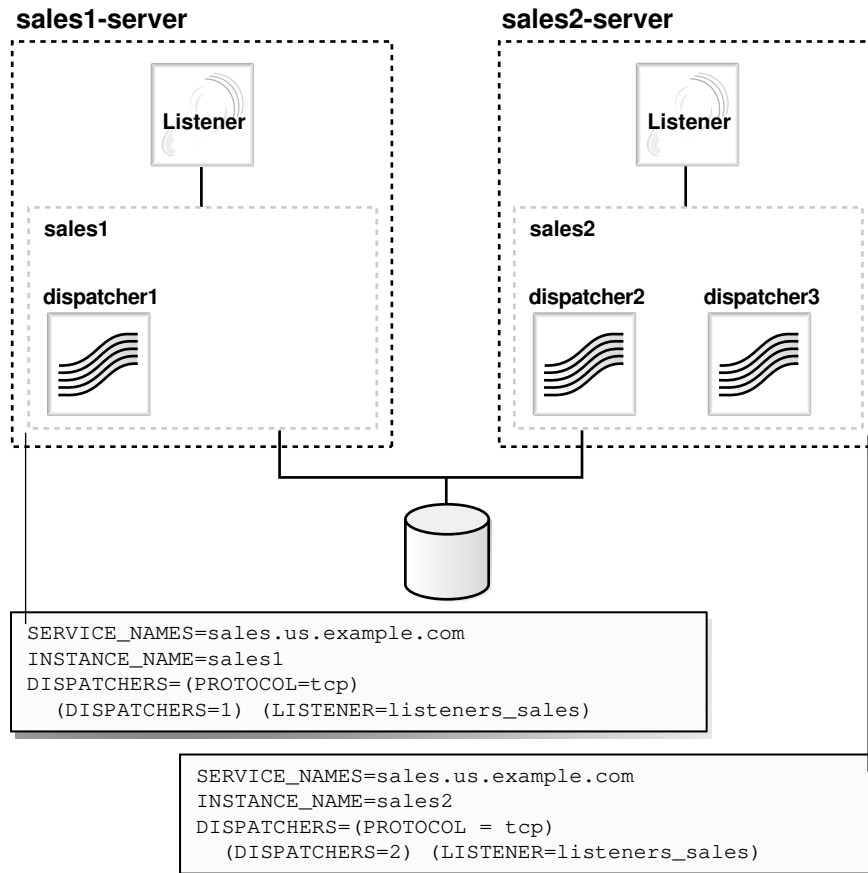

In this example, sales2-server is the least loaded node, sales2 is the least loaded instance, and dispatcher2 is the least loaded dispatcher. The following load information is registered.

- The one minute load average for each instance is 600 for sales1 and 400 for sales2. This can happen if more processing is required on sales1-server.
- The number of connections to each instance is 200 for sales1 and 300 for sales2.
- The number of dispatcher connections to each instance is 200 for dispatcher1, 100 for dispatcher2, and 200 for dispatcher3.
- The number of connections to sales1 (200) is the same as that of its only dispatcher, dispatcher1.
- The number of connections on sales2 (300) is the sum of the connections on its two dispatchers, dispatcher2 (100) and dispatcher3 (200).



The `listeners_sales` value in `(LISTENER=listeners_sales)` is resolved through a local `tnsnames.ora` file on both servers as follows:

```
listeners_sales=
  (DESCRIPTION=
    (ADDRESS_LIST=
      (ADDRESS=(PROTOCOL=tcp)(HOST=sales1-server)(PORT=1521))
      (ADDRESS=(PROTOCOL=tcp)(HOST=sales2-server)(PORT=1521))))
```

Based on the environment, the following actions occur. The numbered actions correspond to the arrows shown in Figure 13-2:

1. LREG processes for instances `sales1` and `sales2` register with both listeners. The listeners are updated dynamically on the load of the instances and dispatchers.
2. The client sends a connect request. A connect descriptor is configured to try each protocol address randomly until one succeeds:

```
sales.us.example.com=
  (DESCRIPTION=
    (LOAD_BALANCE=on)
    (FAILOVER=on)
    (ADDRESS=(PROTOCOL=tcp)(HOST=sales1-server)(PORT=1521))
    (ADDRESS=(PROTOCOL=tcp)(HOST=sales2-server)(PORT=1521))
    (CONNECT_DATA=(SERVICE_NAME=sales.us.example.com)))
```

The listener on `sales1-server` was randomly chosen to receive the client connect request.

The listener on `sales1-server` compares the load of the instances `sales1` and `sales2`. The comparison takes into account the load on nodes `sales1-server` and `sales2-server`, respectively. Because `sales2-server` is less loaded than `sales1-server`, the listener selects `sales2-server` over `sales1-server`.

3. The listener compares the load on dispatchers `dispatcher2` and `dispatcher3`. Because `dispatcher2` is less loaded than `dispatcher3`, the listener redirects the client connect request to `dispatcher2`.
4. The client connects directly to `dispatcher2`.

Figure 13-2 Load Balancing Example for a Shared Server Configuration

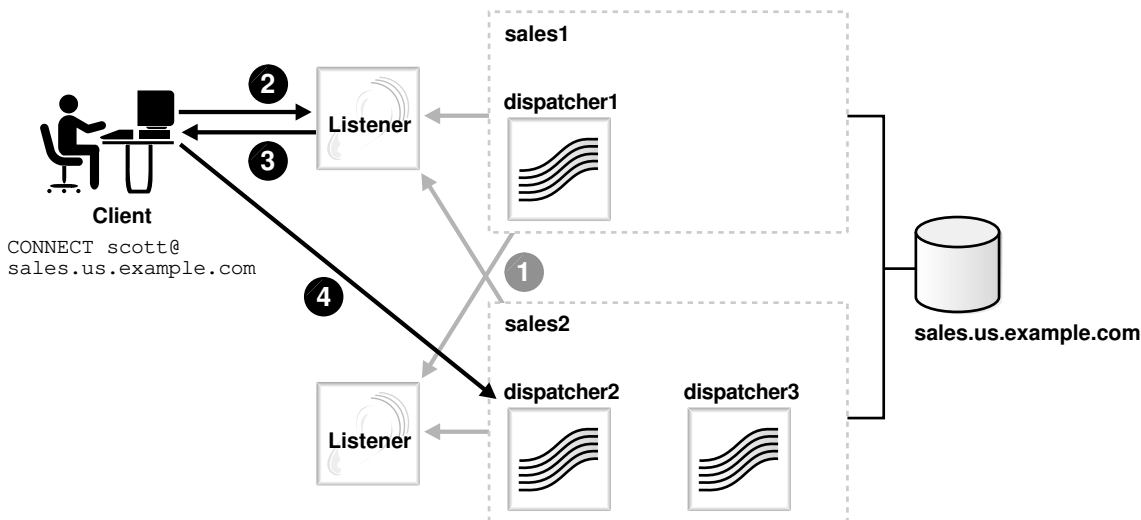

## 13.2.2 Example of Connection Load Balancing for Dedicated Server Configuration

Figure 13-3 shows an Oracle RAC dedicated server database with two instances, sales1 and sales2, of the same service, sales.us.example.com. The instances sales1 and sales2 reside on computers sales1-server and sales2-server, respectively. Listeners named listener run on nodes 1 and 2. The REMOTE\_LISTENER initialization parameter has been configured to allow for service registration of information to both listeners.

**Figure 13-3 Load Balancing Environment for a Dedicated Server Configuration**

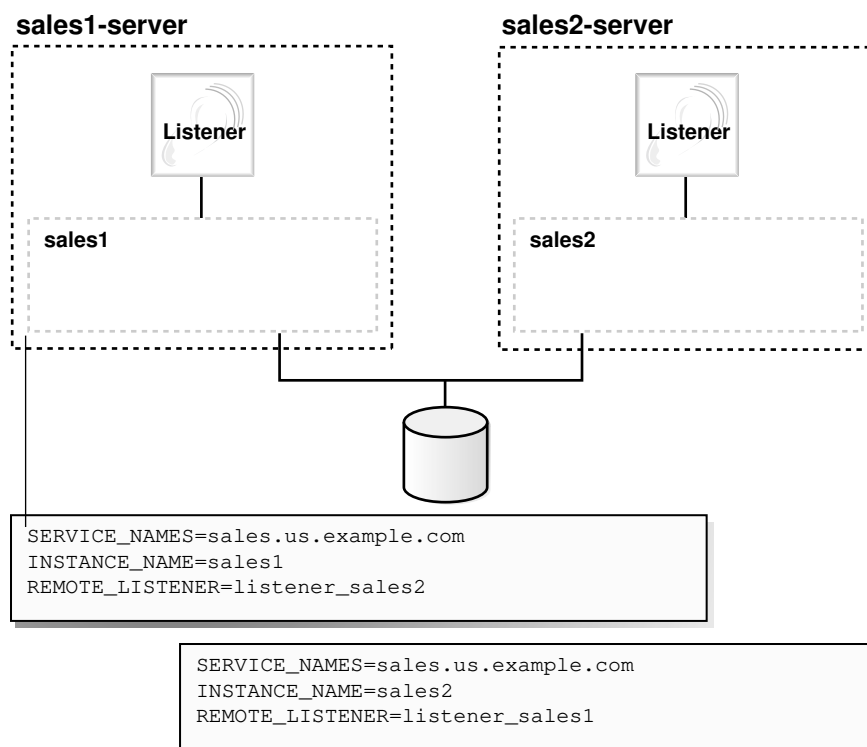

In this example, the following load information is registered:

- sales1-server has a node load average of 450 per minute.
- sales2-server has a node load average of 200 per minute.
- sales1 has 200 connections.
- sales2 has 150 connections.

The listener\_sales1 value in (REMOTE\_LISTENER=listener\_sales1) is resolved through a local tnsnames.ora file on the sales2-server as follows:

```

listener_sales1=
  (DESCRIPTION=
    (ADDRESS=(PROTOCOL=tcp)(HOST=sales1-server)(PORT=1521)))
    
```

The `listener_sales2` value in `(REMOTE_LISTENER=listener_sales2)` is resolved through a local `tnsnames.ora` file on the `sales1-server` as follows:

```
listener_sales2=
  (DESCRIPTION=
    (ADDRESS=(PROTOCOL=tcp)(HOST=sales2-server)(PORT=1521)))
```

Based on the environment, the following actions occur. The numbered actions correspond to the arrows shown in [Figure 13-4](#):

1. LREG processes for instances `sales1` and `sales2` register with both listeners. The listeners are dynamically updated on the load of the instances.

Based on the preceding information, `sales2-server` is the least loaded node and `sales2` is the least loaded instance.

2. The client sends a connect request.

A connect descriptor is configured to try each protocol address randomly until one succeeds:

```
sales.us.example.com=
  (DESCRIPTION=
    (ADDRESS_LIST=
      (LOAD_BALANCE=on)
      (FAILOVER=on)
      (ADDRESS=(PROTOCOL=tcp)(HOST=sales1-server)(PORT=1521))
      (ADDRESS=(PROTOCOL=tcp)(HOST=sales2-server)(PORT=1521)))
    (CONNECT_DATA=(SERVICE_NAME=sales.us.example.com)))
```

The listener on `sales1-server` was randomly chosen to receive the client connect request.

The listener on `sales1-server` compares the load of the instances `sales1` and `sales2`. The comparison takes into account the load on nodes `sales1-server` and `sales2-server`, respectively. Because `sales2-server` is less loaded than `sales1-server`, the listener selects `sales2-server` over `sales1-server`.

3. The listener on `sales1-server` redirects the client connect request to the listener on `sales2-server`.
4. The client connects to the listener on `sales2-server`. The listener starts a dedicated server process, and the dedicated server process inherits the connection request from the listener.

Figure 13-4 Load Balancing Example for a Dedicated Server Configuration

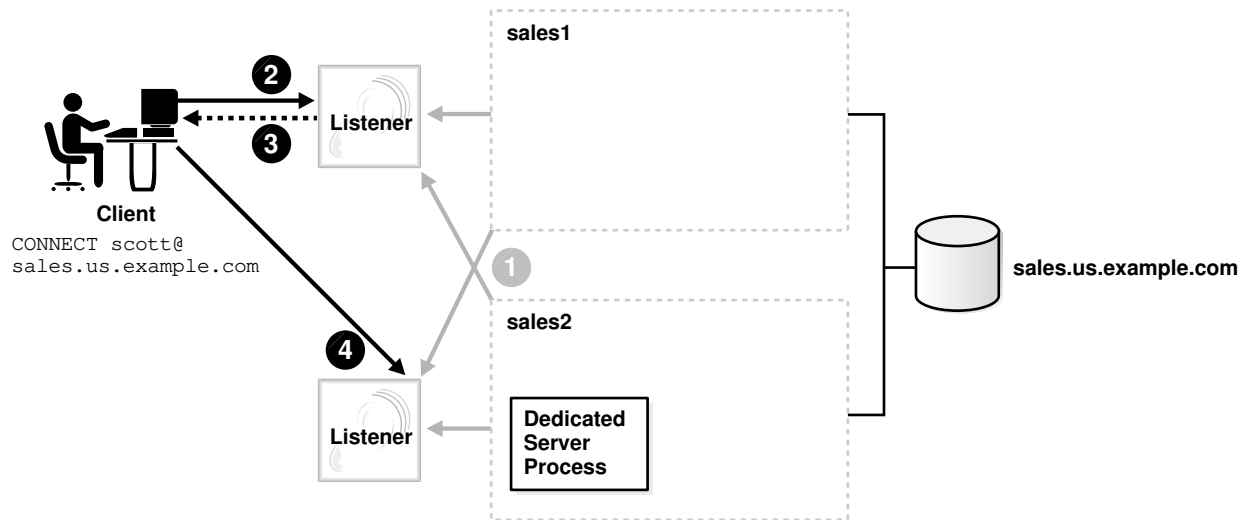

### 13.2.3 COLOCATION\_TAG of Client Connections

The `COLOCATION_TAG` parameter is an alphanumeric string that you can use with the `CONNECT_DATA` parameter of the TNS connect string.

When you set the `colocation_tag` within the `CONNECT_DATA` parameter, load balancing is ignored. The listener makes an effort to send all connections that have the same `colocation_tag` to the same database instance. The instance selection algorithm is based on the `colocation_tag`, and the list of available instances for the specified service.

For example, the listener will try to route all clients to the same database instance that have the `COLOCATION_TAG` set to `interactive` in the connection descriptor.

```
sales.us.example.com=
  (DESCRIPTION=
    (ADDRESS=(PROTOCOL=tcp)(HOST=sales-server)(PORT=1521))
    (CONNECT_DATA=(SERVICE_NAME=sales.us.example.com)
      (COLOCATION_TAG=interactive)))
```

 **Note:**

Under certain conditions, such as, when maximum load of an instance is reached or when new instances are added or deleted for a service, the colocation of client connections that have the same `colocation_tag` to the same database instance may not be consistent.

### Related Topics

- [COLOCATION\\_TAG](#)

## 13.3 Configuring Transparent Application Failover

Transparent Application Failover (TAF) instructs Oracle Net to fail over a failed connection to a different listener. This enables the user to continue to work using the new connection as if the original connection had never failed.

TAF involves manual configuration of a network service name that includes the `FAILOVER_MODE` parameter included in the `CONNECT_DATA` section of the connect descriptor.

- [About Transparent Application Failover](#)
- [What Transparent Application Failover Restores](#)
- [About the FAILOVER\\_MODE Parameters](#)
- [Implementing Transparent Application Failover](#)
- [Verifying Transparent Application Failover](#)

### 13.3.1 About Transparent Application Failover

TAF is a client-side feature that allows clients to reconnect to surviving databases in the event of a failure of a database instance. Notifications are used by the server to trigger TAF callbacks on the client-side.

TAF is configured using either client-side specified TNS (Transparent Network Substrate) connect string or using server-side service attributes. If both methods are used to configure TAF, then the server-side service attributes supersede the client-side settings. Server-side service attributes are the preferred way to set up TAF.

TAF can operate in one of two modes, Session Failover and Select Failover. Session Failover re-creates lost connections and sessions. Select Failover replays queries that were in progress.

When there is a failure, callback functions are initiated on the client-side using Oracle Call Interface (OCI) callbacks. This works with standard OCI connections as well as connection pool and session pool connections.

TAF operates with Oracle Data Guard to provide automatic failover. TAF works with the following database configurations to effectively mask a database failure:

- Oracle Real Application Clusters
- Replicated systems
- Standby databases
- Single instance Oracle database

 **See Also:**

- *Oracle Real Application Clusters Administration and Deployment Guide*
- *Oracle Call Interface Programmer's Guide* for more details on callbacks, and session pools

## 13.3.2 What Transparent Application Failover Restores

TAF automatically restores some or all of the following elements associated with active database connections. Other elements may need to be embedded in the application code to enable TAF to recover the connection.

- **Client-server database connections:** TAF automatically reestablishes the connection using the same connect string or an alternate connect string that you specify when configuring failover.
- **Users' database sessions:** TAF automatically logs a user in with the same user ID as was used before the failure. If multiple users were using the connection, then TAF automatically logs them in as they attempt to process database commands. Unfortunately, TAF cannot automatically restore other session properties. These properties can be restored by invoking a callback function.
- **Completed commands:** If a command was completed at the time of connection failure, and it changed the state of the database, then TAF does not resend the command. If TAF reconnects in response to a command that may have changed the database, then TAF issues an error message to the application.
- **Open cursors used for fetching:** TAF allows applications that began fetching rows from a cursor before failover to continue fetching rows after failover. This is called select failover. It is accomplished by re-running a `SELECT` statement using the same snapshot, discarding those rows already fetched and retrieving those rows that were not fetched initially. TAF verifies that the discarded rows are those that were returned initially, or it returns an error message.
- **Active transactions:** Any active transactions are rolled back at the time of failure because TAF cannot preserve active transactions after failover. The application instead receives an error message until a `ROLLBACK` command is submitted.
- **Server-side program variables:** Server-side program variables, such as PL/SQL package states, are lost during failures, and TAF cannot recover them. They can be initialized by making a call from the failover callback.

 **See Also:**

*Oracle Call Interface Programmer's Guide*

### 13.3.3 About the FAILOVER\_MODE Parameters

The FAILOVER\_MODE parameter must be included in the CONNECT\_DATA section of a connect descriptor. The FAILOVER\_MODE parameter can contain the parameters described in [Table 13-4](#).

**Table 13-4 Additional Parameters of the FAILOVER\_MODE Parameter**

FAILOVER_MODE Parameters	Description
BACKUP	A different network service name for backup connections. A backup should be specified when using <code>preconnect</code> to pre-establish connections.
DELAY	The amount of time in seconds to wait between connect attempts. If RETRIES is specified, then DELAY defaults to one second. If a callback function is registered, then this parameter is ignored.
METHOD	The setting for fast failover from the primary node to the backup node: <ul style="list-style-type: none"> <li><code>basic</code>: Set to establish connections at failover time. This option requires almost no work on the backup server until failover time.</li> <li><code>preconnect</code>: Set to pre-established connections. This provides faster failover but requires that the backup instance be able to support all connections from every supported instance.</li> </ul>
RETRIES	The number of times to attempt to connect after a failover. If DELAY is specified, then RETRIES defaults to five retry attempts. If a callback function is registered, then this parameter is ignored.
TRANSACTION	The ability for a transaction to complete after a recoverable database error. This parameter is set using the SRVCTL utility or the DBMS_SERVICE package. This parameter is used with <code>COMMIT_OUTCOME=TRUE</code> .
TYPE	The type of failover. Three types of Oracle Net failover functionality are available by default to Oracle Call Interface (OCI) applications: <ul style="list-style-type: none"> <li><code>session</code>: Set to fail over the session. If the user's connection is lost, then a new session is automatically created for the user on the backup. This type of failover does not attempt to recover select operations.</li> <li><code>select</code>: Set to enable users with open cursors to continue fetching on them after failure. However, this mode involves overhead on the client side in normal select operations.</li> <li><code>none</code>: This is the default. No failover functionality is used. This can also be explicitly specified to prevent failover from happening.</li> </ul>

 **Note:**

Oracle Net Manager does not provide support for TAF parameters. These parameters must be set manually.

## 13.3.4 Implementing Transparent Application Failover

Depending on the `FAILOVER_MODE` parameters, you can implement TAF in several ways. Oracle recommends the following methods:



### Important:

Do not set the `GLOBAL_DBNAME` parameter in the `SID_LIST_listener_name` section of the `listener.ora` file. A statically configured global database name disables TAF.

- [TAF with Connect-Time Failover and Client Load Balancing](#)
- [TAF Retrying a Connection](#)
- [TAF Pre-establishing a Connection](#)

### 13.3.4.1 TAF with Connect-Time Failover and Client Load Balancing

Implement TAF with connect-time failover and client load balancing for multiple addresses. In the following example, Oracle Net connects randomly to one of the protocol addresses on `sales1-server` or `sales2-server`. If the instance fails after the connection, then the TAF application fails over to the other node's listener, reserving any `SELECT` statements in progress.

```
sales.us.example.com=
  (DESCRIPTION=
    (LOAD_BALANCE=on)
    (FAILOVER=on)
    (ADDRESS=
      (PROTOCOL=tcp)
      (HOST=sales1-server)
      (PORT=1521))
    (ADDRESS=
      (PROTOCOL=tcp)
      (HOST=sales2-server)
      (PORT=1521))
    (CONNECT_DATA=
      (SERVICE_NAME=sales.us.example.com)
      (FAILOVER_MODE=
        (TYPE=select)
        (METHOD=basic))))
```

Although the preceding example has multiple addresses, the `ADDRESS_LIST` parameter was not used. This is because the `ADDRESS_LIST` parameter is not mandatory.

### 13.3.4.2 TAF Retrying a Connection

TAF also provides the ability to automatically retry connecting if the first connection attempt fails with the `RETRIES` and `DELAY` parameters. In the following example, Oracle Net tries to reconnect to the listener on `sales1-server`. If the failover connection fails, then Oracle Net waits 15 seconds before trying to reconnect again. Oracle Net attempts to reconnect up to 20 times.



```

sales.us.example.com=
  (DESCRIPTION=
    (ADDRESS=
      (PROTOCOL=tcp)
      (HOST=sales1-server)
      (PORT=1521))
    (CONNECT_DATA=
      (SERVICE_NAME=sales.us.example.com)
      (FAILOVER_MODE=
        (TYPE=select)
        (METHOD=basic)
        (RETRIES=20)
        (DELAY=15))))

```

### 13.3.4.3 TAF Pre-establishing a Connection

A backup connection can be pre-established. The initial and backup connections must be explicitly specified. In the following example, clients that use network service name `sales1.us.example.com` to connect to the listener on `sales1-server` are also preconnected to `sales2-server`. If `sales1-server` fails after the connection, then Oracle Net fails over to `sales2-server`, preserving any `SELECT` statements in progress. Similarly, Oracle Net preconnects to `sales1-server` for those clients that use `sales2.us.example.com` to connect to the listener on `sales2-server`.

```

sales1.us.example.com=
  (DESCRIPTION=
    (ADDRESS=
      (PROTOCOL=tcp)
      (HOST=sales1-server)
      (PORT=1521))
    (CONNECT_DATA=
      (SERVICE_NAME=sales.us.example.com)
      (INSTANCE_NAME=sales1)
      (FAILOVER_MODE=
        (BACKUP=sales2.us.example.com)
        (TYPE=select)
        (METHOD=preconnect))))
sales2.us.example.com=
  (DESCRIPTION=
    (ADDRESS=
      (PROTOCOL=tcp)
      (HOST=sales2-server)
      (PORT=1521))
    (CONNECT_DATA=
      (SERVICE_NAME=sales.us.example.com)
      (INSTANCE_NAME=sales2)
      (FAILOVER_MODE=
        (BACKUP=sales1.us.example.com)
        (TYPE=select)
        (METHOD=preconnect))))

```

### 13.3.5 Verifying Transparent Application Failover

You can query the `FAILOVER_TYPE`, `FAILOVER_METHOD`, and `FAILED_OVER` columns in the `V$SESSION` view to verify that TAF is correctly configured. To view the columns, use a query similar to the following:

```
SELECT MACHINE, FAILOVER_TYPE, FAILOVER_METHOD, FAILED_OVER, COUNT(*)
FROM V$SESSION
GROUP BY MACHINE, FAILOVER_TYPE, FAILOVER_METHOD, FAILED_OVER;
```

The output before failover looks similar to the following:

MACHINE	FAILOVER_TYPE	FAILOVER_METHOD	FAILED_OVER	COUNT(*)
sales1	NONE	NONE	NO	11
sales2	SELECT	PRECONNECT	NO	1

The output after failover looks similar to the following:

MACHINE	FAILOVER_TYPE	FAILOVER_METHOD	FAILED_OVER	COUNT(*)
sales2	NONE	NONE	NO	10
sales2	SELECT	PRECONNECT	YES	1



#### Note:

You can monitor each step of TAF using an appropriately configured OCI TAF CALLBACK function.



#### See Also:

- *Oracle Call Interface Programmer's Guide*
- *Oracle Database Reference* for additional information about the V\$SESSION view

## 13.4 Specifying the Instance Role for Primary and Secondary Instance Configurations

The INSTANCE\_ROLE parameter is an optional parameter for the CONNECT\_DATA section of a connect descriptor. It enables you to specify a connection to the primary or secondary instance of Oracle RAC configurations.

This parameter is useful when:

- You want to explicitly connect to a primary or secondary instance. The default is the primary instance.
- You want to use TAF to preconnect to a secondary instance.

[Table 13-5](#) describes the INSTANCE\_ROLE parameters.

**Table 13-5 INSTANCE\_ROLE Parameters**

INSTANCE_ROLE Parameter	Description
PRIMARY	Specifies a connection to the primary instance.
SECONDARY	Specifies a connection to the secondary instance.
ANY	Specifies a connection to whichever instance has the lowest load, regardless of primary or secondary instance role.

### Connection to Instance Role Type

In the following example of the `tnsnames.ora` file, network service name `sales_primary` enables connections to the primary instance, and network service name `sales_secondary` enables connections to the secondary instance.

```
sales_primary=
  (DESCRIPTION=
    (ADDRESS_LIST=
      (ADDRESS=
        (PROTOCOL=tcp)
        (HOST=sales1-server)
        (PORT=1521))
      (ADDRESS=
        (PROTOCOL=tcp)
        (HOST=sales2-server)
        (PORT=1521)))
    (CONNECT_DATA=
      (SERVICE_NAME=sales.us.example.com)
      (INSTANCE_ROLE=primary)))
sales_secondary=
  (DESCRIPTION=
    (ADDRESS_LIST=
      (ADDRESS=
        (PROTOCOL=tcp)
        (HOST=sales1-server)
        (PORT=1521))
      (ADDRESS=
        (PROTOCOL=tcp)
        (HOST=sales2-server)
        (PORT=1521)))
    (CONNECT_DATA=
      (SERVICE_NAME=sales.us.example.com)
      (INSTANCE_ROLE=secondary)))
```

### Connection to a Specific Instance

There are times when Oracle Enterprise Manager Cloud Control and other system management products need to connect to a specific instance regardless of its role to perform administrative tasks. For these types of connections, configure `(INSTANCE_NAME=instance_name)` and `(INSTANCE_ROLE=any)` to connect to the instance regardless of its role.

In the following example, network service name `sales1` enables connections to the instance on `sales1-server` and `sales2` enables connections to the instance on `sales2-server`. `(SERVER=dedicated)` is specified to force a dedicated server connection.

```

sales1=
  (DESCRIPTION=
    (ADDRESS=
      (PROTOCOL=tcp)
      (HOST=sales1-server)
      (PORT=1521))
    (CONNECT_DATA=
      (SERVICE_NAME=sales.us.example.com)
      (INSTANCE_ROLE=any)
      (INSTANCE_NAME=sales1)
      (SERVER=dedicated)))
sales2=
  (DESCRIPTION=
    (ADDRESS=
      (PROTOCOL=tcp)
      (HOST=sales2-server)
      (PORT=1521))
    (CONNECT_DATA=
      (SERVICE_NAME=sales.us.example.com)
      (INSTANCE_ROLE=any)
      (INSTANCE_NAME=sales2)
      (SERVER=dedicated)))

```



#### Note:

Failover is incompatible with the preceding settings.

### TAF Pre-establishing a Connection

If TAF is configured, then a backup connection can be pre-established to the secondary instance. The initial and backup connections must be explicitly specified. In the following example, Oracle Net connects to the listener on `sales1-server` and preconnects to `sales2-server`, the secondary instance. If `sales1-server` fails after the connection, then the TAF application fails over to `sales2-server`, the secondary instance, preserving any `SELECT` statements in progress.

```

sales1.example.com=
  (DESCRIPTION=
    (ADDRESS=
      (PROTOCOL=tcp)
      (HOST=sales1-server)
      (PORT=1521))
    (CONNECT_DATA=
      (SERVICE_NAME=sales.us.example.com)
      (INSTANCE_ROLE=primary)
      (FAILOVER_MODE=
        (BACKUP=sales2.example.com)
        (TYPE=select)
        (METHOD=preconnect))))
sales2.example.com=
  (DESCRIPTION=
    (ADDRESS=
      (PROTOCOL=tcp)
      (HOST=sales2-server)
      (PORT=1521))
    (CONNECT_DATA=

```

```
(SERVICE_NAME=sales.us.example.com)
(INSTANCE_ROLE=secondary))
```

## 13.5 Understanding Static Service Registration

The listener uses the dynamic service information about the database and instance before using statically configured information in the `listener.ora` file. Configuration of static service information is necessary in the following cases:

- Use of external procedure calls
- Use of Oracle Heterogeneous Services
- Use of Oracle Data Guard
- Remote database startup from a tool other than Oracle Enterprise Manager Cloud Control
- Connections to Oracle databases earlier than Oracle8*i* release 2 (8.1)

[Example 13-1](#) shows a `listener.ora` file configured for static service registration. The `LISTENER` entry defines the listening protocol address for a listener named `Listener`, and the `SID_LIST_LISTENER` entry provides information about the external services statically supported by the `Listener` listener.

### Example 13-1 Example listener.ora File

```
LISTENER=
  (DESCRIPTION=
    (ADDRESS_LIST=
      (ADDRESS=(PROTOCOL=tcp)(HOST=sales-server)(PORT=1521))
      (ADDRESS=(PROTOCOL=ipc)(KEY=extproc)(queuesize=50))))
SID_LIST_listener=
  (SID_LIST=
    (SID_DESC=
      (SID_NAME=plsextproc)
      (ORACLE_HOME=/oracle8)
      (PROGRAM=extproc)))
```

The `SID_LIST_listener_name` parameter setting in the `listener.ora` file specifies information about the databases served by the listener. When services are configured statically, a listener starts a dedicated server process when it receives a client request. If the instance is not up, then the server returns an Oracle not available error message.

If a database cannot find the listener, then configure the `listener.ora` file with the `GLOBAL_DBNAME` parameter, as shown in the following example

```
SID_LIST_listener=
(SID_LIST=
(SID_DESC=
  (GLOBAL_DBNAME=sales.example.com)
  (SID_NAME=sales)
  (ORACLE_HOME=/u01/app/oracle))
```



**Note:**

A statically-configured global database name disables TAF. To use TAF, do not set the GLOBAL\_DBNAME parameter in the SID\_LIST\_listener\_name section of the listener.ora file.

Table 13-6 describes static service settings in the listener.ora file.

**Table 13-6 Static Service Settings in listener.ora**

Oracle Net Manager Field	listener.ora File Parameter	Description
SID	SID_NAME	The Oracle system identifier (SID) of the instance. You can obtain the SID value from the INSTANCE_NAME parameter in the initialization parameter file.
Service Name	GLOBAL_DBNAME	<p>The database service.</p> <p>While processing a client connection request, the listener tries to match the value of this parameter with the value of the SERVICE_NAME parameter in the client connect descriptor. If the client connect descriptor uses the SID parameter, then the listener does not attempt to map the values. This parameter is primarily intended for configurations with Oracle8 databases (where dynamic service registration is not supported for dedicated servers). This parameter may also be required for use with Oracle8i and later database services by some configurations.</p> <p>The value for this parameter is typically obtained from the combination of the DB_NAME and DB_DOMAIN parameters (DB_NAME.DB_DOMAIN) in the initialization parameter file, but the value can also contain any valid name used by clients to identify the service.</p> <p>When using a connect descriptor with a SERVICE_NAME parameter, ensure that any SID_DESC entry does not have the value GLOBAL_DBNAME.</p>
Oracle Home Directory	ORACLE_HOME	<p>The Oracle home location of the instance. Without this setting, the listener assumes its Oracle home for the instance.</p> <p>On Linux and UNIX, this setting is optional.</p> <p>On Microsoft Windows, this setting is ignored. The Oracle home specified by the ORACLE_HOME parameter in HKEY_LOCAL_MACHINE\SOFTWARE\ORACLE\HOMEID of the Microsoft Windows registry is used.</p>
Not applicable	SID_LIST_listener_name	The section of the listener.ora file that defines the database served by the listener.

- [Configuring Static Registration for the Listener](#)

## 13.5.1 Configuring Static Registration for the Listener

The following procedure describes how to statically configure the listener:

 **Note:**

If you are using connect-time failover or TAF, such as in an Oracle Real Application Clusters environment, then do not set the GLOBAL\_DBNAME parameter.

1. Access the Net Services Administration page in Oracle Enterprise Manager Cloud Control.

 **See Also:**

["Using Oracle Enterprise Manager Cloud Control to Configure Oracle Net Services"](#)

2. Select **Listeners** from the Administer list, and then select the Oracle home that contains the configuration files.
3. Click **Go**. You may be prompted to log in to the database server.  
The Listeners page appears.
4. Select a listener, and then click **Edit**.  
The Edit Listener page appears.
5. Click the **Static Database Registration** tab, and then click **Add**.  
The Add Database Service page appears. Enter the required information in the fields.
6. Click **OK**.

 **Note:**

You can also configure static service information with Oracle Net Manager. See **Statically Configure Database Service Information** in the online help for additional information.

 **See Also:**

["Configuring Dynamic Service Registration"](#) for additional information about configuring dynamic service registration Oracle Databases

## 13.6 Configuring Connections to Third-Party Database Services

The following topics describe how to configure connections to third-party database services:

- [Default Configuration for External Procedures](#)
- [About Oracle Net Services for Oracle Heterogeneous Services](#)
- [Configuring Oracle Net Services for an Oracle Rdb Database](#)

### 13.6.1 Default Configuration for External Procedures

An external procedure is a procedure called from another program, written in a different language. An example is a PL/SQL program calling one or more C routines that are required to perform special-purpose processing.

When an application calls an external procedure, Oracle Database starts an external procedure agent named `extproc`. Using the network connection established by Oracle Database, the application passes the following information to the agent:

- DLL or shared library name
- External procedure name
- Any parameters

The agent then loads the DLL or the shared library, and runs the external procedure and passes back to the application any values returned by the external procedure. The agent must reside on the same computer as the application making the external procedure call.

When you use the default configuration for external procedures, the `extproc` agent is spawned directly by Oracle Database. There are no configuration changes required for either the `listener.ora` or `tnsnames.ora` file. However, you must define the environment variables to be used by external procedures in the `extproc.ora` file located in the `ORACLE_BASE_HOME/hs/admin` directory. If the default configuration for external procedures is not used, then the parameters listed in [Table 13-7](#) must be set.

**Table 13-7 External Procedures Settings in listener.ora**

Oracle Enterprise Manager Cloud Control Field	listener.ora Parameter	Description
Program Name	PROGRAM	The name of the external procedure agent executable. <b>Note:</b> On Microsoft Windows, the executable must reside in the <code>ORACLE_HOME\bin</code> directory.



Table 13-7 (Cont.) External Procedures Settings in listener.ora

Oracle Enterprise Manager Cloud Control Field	listener.ora Parameter	Description
Environment Variables	ENVS	<p>The environment variables to be used by external procedures in the <code>extproc.ora</code> file located in the <code>ORACLE_BASE_HOME/hs/admin</code> directory.</p> <p><b>Note:</b> When <code>extproc.ora</code> is in use, it precedes the same environment variables of <code>ENVS</code> in <code>listener.ora</code>.</p> <p><b>Syntax:</b> <code>SET name=value</code></p> <p><b>Example:</b> <code>SET EXTPROC_DLLS=ANY</code></p> <p>Specify the <code>EXTPROC_DLLS</code> environment variable to restrict the DLLs that the <code>extproc</code> agent is allowed to load. Without the <code>EXTPROC_DLLS</code> environment variable, the <code>extproc</code> agent loads DLLs from the <code>ORACLE_HOME/lib</code> directory on UNIX operating systems and the <code>ORACLE_HOME\bin</code> directory on Microsoft Windows.</p> <p>Set <code>EXTPROC_DLLS</code> to one of the following values:</p> <ul style="list-style-type: none"> <li>Colon-separated list of DLLs<sup>1</sup> <p><b>Syntax:</b> <code>"DLL: DLL"</code></p> <p>This value allows the <code>extproc</code> agent to load the specified DLLs and the DLLs from the <code>ORACLE_HOME/lib</code> directory on UNIX operating systems and the <code>ORACLE_HOME\bin</code> directory on Microsoft Windows. You must enter the complete directory path and file name of the DLLs.</p> </li> <li>ONLY (Recommended for maximum security)<sup>1</sup> <p><b>Syntax:</b> <code>"ONLY: DLL: DLL"</code></p> <p>This value allows the <code>extproc</code> agent to load only the specified DLLs. You must enter the complete directory path and file name of the DLLs.</p> </li> <li>ANY <p><b>Syntax:</b> <code>"ANY"</code></p> <p><b>Description:</b> This value allows the <code>extproc</code> agent to load any DLL. ANY disables DLL checking.</p> </li> </ul> <p><b>Examples:</b></p> <pre>"EXTPROC_DLLS=/home/xyz/mylib.so:/home/abc/urllib.so, LD_LIBRARY_PATH=/private/xpm/lib:/private/mylibs, MYPATH=/usr/ucb:/usr/local/packages,APL_ENV_FILE=/apl/conf/env.txt"</pre> <pre>"EXTPROC_DLLS=ONLY:/home/xyz/mylib.so:/home/abc/urllib.so, LD_LIBRARY_PATH=/private/xpm/lib:/private/mylibs, MYPATH=/usr/ucb:/usr/local/packages,APL_ENV_FILE=/apl/conf/env.txt"</pre> <pre>"EXTPROC_DLLS=ANY,LD_LIBRARY_PATH=/private/xpm/lib:/private/mylibs, MYPATH=/usr/ucb:/usr/local/packages,APL_ENV_FILE=/apl/conf/env.txt"</pre>

 **Note:**

If effective user and real user, or effective group and real group are

Table 13-7 (Cont.) External Procedures Settings in listener.ora

Oracle Enterprise Manager Cloud Control Field	listener.ora Parameter	Description
		<div style="border: 1px solid #ccc; padding: 5px; background-color: #e6f2ff;">  different, then LD_LIBRARY_PATH environment setting is ignored.                 </div>
Oracle Home Directory	ORACLE_HOME	The Oracle home location of the agent.
Oracle System Identifier (SID)	SID_NAME	A system identifier for the external procedure agent by any name. See the examples in <a href="#">Configuring Oracle Net Services for External Procedures</a> for more information about how to work with the external procedure agent spawned by Oracle listener.

<sup>1</sup> The DLLs are separated by semi-colons (;) on Microsoft Windows.

 **Note:**

The default configuration for external procedures does not require a network listener to work with Oracle Database and the `extproc` agent. The `extproc` agent is spawned directly by Oracle Database and eliminates the risks that the `extproc` agent might be spawned by Oracle Listener unexpectedly. This default configuration is recommended for maximum security.

You can change the default configuration for external procedures and have the `extproc` agent spawned by Oracle Listener. To do this, you must perform additional network configuration steps.

Having the `extproc` agent spawned by Oracle Listener is necessary if you use:

- Multi-threaded agent
- Oracle Database in MTS mode on Microsoft Windows
- The AGENT clause of the LIBRARY specification or the AGENT IN clause of the PROCEDURE specification such that you can redirect external procedures to a different `extproc` agent.

- [Configuring Oracle Net Services for External Procedures](#)

 **See Also:**

*Oracle Database Security Guide* for additional information about securing external procedures

### 13.6.1.1 Configuring Oracle Net Services for External Procedures

You can change the default configuration for external procedures and have the `extproc` agent spawned by the listener similar to earlier releases of Oracle Database. Here is the process:

1. Configure an existing listener or create a new listener to serve external procedures.

[Example 13-2](#) shows a sample configuration in the `listener.ora` file.

#### Example 13-2 listener.ora File with an External Procedure

```
LISTENER=
  (DESCRIPTION=
    (ADDRESS_LIST=
      (ADDRESS=(PROTOCOL=tcp)(HOST=sale-server)(PORT=1521))
      (ADDRESS=(PROTOCOL=ipc)(KEY=extproc))))
SID_LIST_LISTENER=
  (SID_LIST=
    (SID_DESC=
      (GLOBAL_DBNAME=sales.us.example.com)
      (ORACLE_HOME=/oracle)
      (SID_NAME=sales))
    (SID_DESC=
      (SID_NAME=plsextproc)
      (ORACLE_HOME=/oracle)
      (PROGRAM=extproc)))
```

2. Add a new entry in `tnsnames.ora`.

[Example 13-3](#) shows a sample configuration in the `tnsnames.ora` file.

#### Example 13-3 tnsnames.ora File with an External Procedure

```
EXTPROC_CONNECTION_DATA_1=
  (DESCRIPTION=
    (ADDRESS=(PROTOCOL=ipc)(KEY=extproc))
    (CONNECT_DATA=
      (SID=plsextproc)))
```

3. Use `AGENT` clause of the `LIBRARY` specification or `AGENT IN` clause of the `PROCEDURE` specification such that you can redirect external procedures to a different `extproc` agent (for example, `extproc` spawned by Oracle listener).

```
$ cat test.c

#include <stdlib.h>
int negative(char* db, int n)
{
    return -1*n;
}

char* mygetenv(const char* env)
{
    return getenv(env);
}

$ gcc -shared -fPIC -o test.so test.c
```

```
$ cp test.so $ORACLE_HOME/lib
```

In SQL\*PLUS, run:

```
DROP DATABASE LINK extproclink;
CREATE DATABASE LINK extproclink USING 'extproc_connection_data_1';

CREATE OR REPLACE LIBRARY test1 AS '$ORACLE_HOME/lib/test.so';
/

--
-- Use 'AGENT' clause in LIBRARY SPEC
--
CREATE OR REPLACE LIBRARY test2 AS '$ORACLE_HOME/lib/test.so' AGENT
'extproclink';
/

--
-- Use 'AGENT IN' clause in FUNCTION
--
CREATE OR REPLACE FUNCTION ftest1(x VARCHAR2, y BINARY_INTEGER)
RETURN BINARY_INTEGER
AS LANGUAGE C
LIBRARY test1
NAME "negative"
PARAMETERS(x STRING, y INT)
AGENT IN ( x );
/

CREATE OR REPLACE FUNCTION ftest2(x VARCHAR2)
RETURN VARCHAR2
AS LANGUAGE C
LIBRARY test2
NAME "mygetenv";
/

$ select ftest1('extproclink', 123) from dual;

$ select ftest2('LD_LIBRARY_PATH') from dual;
```

The listener for external procedures should have a user account that does not have general access to the files owned by the `oracle` user. Specifically, this user should not have permission to read or write to database files or to the Oracle server address space. In addition, this user should have read access to the `listener.ora` file, but must not have write access to it.

Running the listener with lower privileges also prevents using the Listener Control `SET` commands to alter the configuration of the listener in the `listener.ora` file. For this reason, Oracle recommends that you complete `listener.ora` file configuration before running the listener.

- [Modifying the Default Configuration for External Procedures](#)

- [Creating a New Listener to Run External Procedures](#)

### 13.6.1.1.1 Modifying the Default Configuration for External Procedures

To modify the default configuration for external procedures, configure and run a separate or existing listener to serve external procedures. The following procedure describes how to modify the default configuration:

1. Configure an existing listener to serve external procedures using Oracle Net Configuration Assistant as follows. For most installation types, this listener is named `LISTENER`.
  - a. Access the Net Services Administration page in Oracle Enterprise Manager Cloud Control.
  - b. Select **Listeners** from the Administer list, and then select the Oracle home that contains the location of the configuration files.
  - c. Click **Go**.

The Listeners page appears.
  - d. Select the existing listener created by Oracle Net Configuration Assistant, and then click **Edit**.

The Edit Listeners page appears.
  - e. In the Addresses section, select the protocol address for external procedures, and then click **Add**.
  - f. Click the **Other Services** tab.
  - g. Select the row representing the service information for external procedures, and then click **Add**.
2. Add service information about the extproc agent in the `listener.ora` file, including the parameters described in [Table 13-7](#).

### 13.6.1.1.2 Creating a New Listener to Run External Procedures

To configure and run a separate listener to serve external procedures, create the external procedure entries for a different listener using Oracle Net Configuration Assistant. The following procedure describes how to create a new listener:

1. Create a listener to exclusively handle external procedures, as follows:
  - a. Navigate to the Listeners page.
  - b. Click **Create**.

The Create Listener page appears.
  - c. In the Listener Name field, enter a unique listener name, such as `LISTENEREXTPROC`, in the Listener Name field.
2. In the Addresses section, configure an IPC protocol address, as follows:
  - a. Click **Add**.

The Add Address page appears.
  - b. From the Protocol list, select **IPC**.
  - c. In the Key field, enter a key value of the extproc agent.

- d. Click **OK**.

 **See Also:**

"[Configuring Listening Protocol Addresses](#)" for additional information about configuring listener protocol addresses

3. Add service information about the `extproc` agent in the `listener.ora` file, including the parameters described in [Table 13-7](#), as follows:

- a. Click the **Other Services** tab.

- b. Click **Add**.

The Create Other Service page appears.

- c. Enter the following values in the fields:

- `extproc` in the Program Name field.
- The Oracle home where the `extproc` executable resides in the Oracle Home Directory field.
- System identifier, such as `extproc`, in the SID field.

- d. In the Environment Variables section, click **Add Another Row**.

- e. Enter the `EXTPROC_DLLS` environment variable in the Name field, and the directory path and file name of the DLLs in the Value field.

- f. Click **OK**.

The Create Listener page appears.

- g. Click **OK** to add the listener.

The listener is added to the Listeners page.

The `listener.ora` file updates with information for external procedures, as shown in the following output:

```
LISTENEREXTPROC=
  (DESCRIPTION=
    (ADDRESS=
      (PROTOCOL=ipc)(KEY=extproc)))
```

4. Start the listener for external procedures from a user account with lower privileges than the `oracle` user.

 **See Also:**

- "[Starting Oracle Net Listener and the Oracle Database Server](#)" for instructions on using the Listener Control utility `START` command to start the listener
- *Oracle Database Development Guide* for instruction on enabling external procedure calls

## 13.6.2 About Oracle Net Services for Oracle Heterogeneous Services

Heterogeneous Services is an integrated component within the Oracle database server, and provides the generic technology for accessing third-party systems from the Oracle database server. Heterogeneous Services enables you to:

- Use Oracle SQL to transparently access data stored in third-party systems as if the data resides within an Oracle database server.
- Use Oracle procedure calls to transparently access third-party systems, services, or application programming interfaces (APIs) from your Oracle distributed environment.

While Heterogeneous Services provides the generic technology in the Oracle database server, a Heterogeneous Services agent is required to access a particular third-party system.

- [Configuring Oracle Database to Connect to Agents](#)

### 13.6.2.1 Configuring Oracle Database to Connect to Agents

To initiate a connection to the third-party system, the Oracle database server starts an agent process through the listener on the gateway. The following procedure describes how to configure the Oracle database server to be able to connect to the agents:

1. Configure the listener on the gateway to listen for incoming requests from the Oracle database server and spawn Heterogeneous Services agents by configuring the following parameters in the `listener.ora` file:
  - PROGRAM: The name of the agent executable
  - ORACLE\_HOME: The Oracle home location of the agent executable
  - SID\_NAME: The Oracle system identifier (SID)
2. Configure the PROGRAM, ORACLE\_HOME, and SID parameters in Oracle Enterprise Manager Cloud Control.
  - a. Access the Net Services Administration page in Oracle Enterprise Manager Cloud Control.

 **See Also:**

["Using Oracle Enterprise Manager Cloud Control to Configure Oracle Net Services"](#)

- b. Select **Listeners** from the Administer list, and then select the Oracle home that contains the location of the configuration files.
- c. Click **Go**.  
The Listeners page appears.
- d. Select the listener created by Oracle Net Configuration Assistant, and then click **Edit**.  
The Edit Listeners page appears.

- e. Click the **Other Services** tab.
- f. Click **Add**.  
The Create Other Service page appears.
- g. Enter the program name in the Program Name field that will be run to create a gateway, the Oracle home where the agent executable resides in the Oracle Home Directory field, and the Oracle System Identifier (SID) or service name of the third-party system in the SID field.
- h. Click **OK**.  
The Edit Listener page appears.
- i. Click **OK** to modify the listener.  
The Listeners page appears.  
The `listener.ora` file updates information about the Heterogeneous Services, as shown in the following:

```
SID_LIST_LISTENER=
(SID_LIST=
(SID_DESC=
(SID_NAME=sybasegw)
(ORACLE_HOME=/oracle12c)
(PROGRAM=tg4sybs)))
```

3. On the computer where the Oracle database resides, set up a network service name to connect to the listener on the gateway. The connect descriptor must include the `HS=ok` clause to ensure the connection uses Heterogeneous Services, as follows:
  - a. Create a network service name that can be used for connections from the Oracle database server to a third-party system.

#### See Also:

[Task 1, Configure Net Services Names](#) for local naming instructions and [Task 2, Create Net Service Names in the Directory](#) for directory naming instructions

- b. Use either Oracle Enterprise Manager Cloud Control or Oracle Net Manager to configure `HS=ok`.
  - For Oracle Enterprise Manager Cloud Control, access the **Net Services Administration** page, select Local Naming for the listener, and then click the **Advanced** tab in the Create Net Service Name page. Next, click **Use for Heterogeneous Services**.
  - For Oracle Net Manager, click **Advanced** in the Service Identification box. The Advanced Service Options dialog box appears. Click **Use for Heterogeneous Services**.
- c. Click **OK** to confirm the change.

The `tnsnames.ora` file updates with the new network service name configured for Heterogeneous Services, as shown in the following:

```
sybase_gtw=
(DESCRIPTION=
```



```
(ADDRESS=(PROTOCOL=tcp)(HOST=gate-server)(PORT=1521))
(CONNECT_DATA=
  (SERVICE_NAME=sybasegw)
)
(HS=ok))
)
```

 **See Also:**

*Oracle Database Heterogeneous Connectivity Administrator's Guide*

### 13.6.3 Configuring Oracle Net Services for an Oracle Rdb Database

Oracle Rdb is a database for Digital 64-bit operating systems. Because Oracle Rdb has its own listener, the client interacts with Rdb in the same manner as it does with an Oracle database.

To initiate a connection to an Oracle Rdb, set up a network service name to connect to the Oracle Rdb database using the parameters described in [Table 13-8](#).

**Table 13-8 Oracle RDB Database Settings in a Connect Descriptor**

Oracle Enterprise Manager Cloud Control Field	tnsnames.ora Parameter	Description
Rdb Database	RDB_DATABASE	The file name of an Oracle Rdb database.
Type of Service	TYPE_OF_SERVICE	The type of service to use for an Oracle Rdb database. It is used by Rdb interface tools. This feature should only be used if the application supports both Oracle Rdb and Oracle database services, and you want the application to load balance between the two.
Global Database Name	GLOBAL_NAME	The Oracle Rdb database. Optional.

The following procedure describes how to configure a client for an Oracle Rdb database:

1. Create a network service name that can be used for connections from the Oracle server to a third-party system.

 **See Also:**

[Task 1, Configure Net Services Names](#) for local naming instructions and [Task 2, Create Net Service Names in the Directory](#) for directory naming instructions

2. Use either Oracle Enterprise Manager Cloud Control or Oracle Net Manager to set the Oracle Rdb parameters.

- For Oracle Enterprise Manager Cloud Control, access the **Net Services Administration** page, select Local Naming for the listener, and then click the **Advanced** tab in the Create Net Service Name page.
  - For Oracle Net Manager, click **Advanced** in the Service Identification section. The Advanced Service Options dialog box appears.
3. Enter the file name of an Oracle Rdb database in the Rdb Database field.
  4. (Optional) Specify the type of service in the Type of Service field, if needed, and enter the global database name in the Global Database Name field, and then click **OK**.

The `tnsnames.ora` file updates with the new network service name configured for the Oracle Rdb database, similar to the following:

```
alpha5=
  (DESCRIPTION=
    (ADDRESS=...)
    (CONNECT_DATA=
      (SERVICE_NAME=generic)
      (RDB_DATABASE=[.mf]mf_personnel.rdb)
      (GLOBAL_NAME=alpha5)))
```

In the following example, the `TYPE_OF_SERVICE` parameter is used to load balance between an Oracle Rdb database service and an Oracle database service:

```
alpha5=
  (DESCRIPTION_LIST=
    (DESCRIPTION=
      (ADDRESS=...)
      (CONNECT_DATA=
        (SERVICE_NAME=generic)
        (RDB_DATABASE=[.mf]mf_personnel.rdb)
        (GLOBAL_NAME=alpha5)))
    (DESCRIPTION=
      (ADDRESS=...)
      (CONNECT_DATA=
        (SERVICE_NAME=sales.us.example.com))
      (TYPE_OF_SERVICE=oracle_database)))
```

# 14

## Optimizing Performance

Learn how to optimize connection performance.

- [Understanding the Benefits of Network Data Compression](#)
- [Configuring Session Data Unit](#)
- [Determining the Bandwidth-Delay Product](#)
- [Configuring I/O Buffer Space](#)
- [Configuring SDP Support for InfiniBand Connections](#)
- [Configuring Exadirect Support for InfiniBand Connections](#)  
Oracle Net Services provides support for the Exadirect for InfiniBand high-speed networks.. Use the new transport to improve latency and throughput by leveraging Remote Direct Memory Access (RDMA) in an InfiniBand environment
- [Limiting Resource Consumption by Unauthorized Users](#)
- [About Data-Dependent Routing](#)

### 14.1 Understanding the Benefits of Network Data Compression

Network data compression reduces the size of the session data unit (SDU) transmitted over a data connection. Reducing the size of data reduces the time required to transmit a SQL query and result across the network. In addition, compressed data uses less bandwidth which allows transmission of larger data in less time. The data compression process is transparent to the application layer.

The following are some of the benefits of using data compression:

- Increased network throughput means constrained bandwidth environments can utilize compression to reduce query response time.
- Reduced bandwidth utilization allows other applications to use the bandwidth.
- Reduction in the amount of data transferred between sites.

### 14.2 Configuring Session Data Unit

Under typical database configuration, Oracle Net encapsulates data into buffers the size of the SDU before sending the data across the network. Oracle Net sends each buffer when it is filled, flushed, or when an application tries to read data. Adjusting the size of the SDU buffers relative to the amount of data provided to Oracle Net to send at any one time can improve performance, network utilization, and memory consumption. When large amounts of data are being transmitted, increasing the SDU size can improve performance and network throughput. SDU size can be adjusted lower or higher to achieve higher throughput for a specific deployment.

The amount of data provided to Oracle Net to send at any one time is referred to as the message size.

The SDU size can range from 512 bytes to 2 MB. The wide range of sizes allows the network administrator to tune the SDU size for optimal network performance for a given deployment. A high SDU size value requires more memory. The default SDU size for the client and a dedicated server is 8192 bytes. The default SDU size for a shared server is 65535 bytes.

The actual SDU size used is negotiated between the client and the server at connect time and is the smaller of the client and server values. Configuring an SDU size different from the default requires configuring the SDU on both the client and server computers, unless you are using shared servers.

You should consider changing the SDU size when the predominant message size is smaller or larger than 8192. The SDU size should be 70 bytes more than the predominant message size. If the predominant message size plus 70 bytes exceeds the maximum SDU, then the SDU should be set such that the message size is divided into the smallest number of equal parts where each part is 70 bytes less than the SDU size. To change the default, change the `DEFAULT_SDU_SIZE` parameter in the `sqlnet.ora` file.

For example, if the majority of the messages sent and received by the application are smaller than 8 KB, taking into account the 70 bytes for overhead, then setting the SDU to 8 KB will likely produce good results. If sufficient memory is available, then using the maximum value for the SDU minimizes the number of system calls and overhead for Oracle Net Services.

 **Note:**

In Oracle Database 11g, Oracle Net Services optimized bulk data transfer for components, such as Oracle SecureFiles LOBs and Oracle Data Guard redo transport services. The SDU size limit, as specified in the network parameter files, does not apply to these bulk data transfers. Bulk data transfer optimization does not apply when ASO options are enabled or TLS transport is used.

- [Setting the SDU Size for the Database](#)
- [Setting the SDU Size for the Client](#)

 **See Also:**

- ["Session Data Unit Size for Data Transfer Optimization"](#)
- ["Statistics Example"](#)

## 14.2.1 Setting the SDU Size for the Database

To set the SDU size for the database server, configure the following files:

- `sqlnet.ora`  
Configure the `DEFAULT_SDU_SIZE` parameter in the `sqlnet.ora` file, such as the following:  

```
DEFAULT_SDU_SIZE=32767
```
- Initialization parameter file  
If using shared server processes, then set the SDU size in the `DISPATCHERS` parameter in the initialization parameter file, as follows:  

```
DISPATCHERS=" (DESCRIPTION=(ADDRESS=(PROTOCOL=tcp) (SDU=8192)) "
```
- `listener.ora`  
If the listener was configured with a list of targets in the `listener.ora` file, then the value for SDU in the `SID_LIST` parameter overrides the current setting in the `sqlnet.ora` file when using dedicated server processes.

## 14.2.2 Setting the SDU Size for the Client

To set the SDU size for the client, configure the following files:

- `sqlnet.ora`  
For global configuration on the client side, configure the `DEFAULT_SDU_SIZE` parameter in the `sqlnet.ora` file, such as the following:  

```
DEFAULT_SDU_SIZE=32767
```
- `tnsnames.ora`  
For a particular connect descriptor, you can specify the SDU parameter in the `DESCRIPTION` parameter.  

```
sales.us.example.com=
(DESCRIPTION=
  (SDU=11280)
  (ADDRESS=(PROTOCOL=tcp)(HOST=sales-server)(PORT=1521))
(CONNECT_DATA=
  (SERVICE_NAME=sales.us.example.com))
)
```

The SDU size applies to all Oracle Net protocols for the particular connect descriptor.

## 14.3 Determining the Bandwidth-Delay Product

Bandwidth-delay product is the product of network bandwidth and the round trip time of data going over the network. A simple way to determine the round trip time, is to use a command such as `ping` from one host to another and use the response times returned by `ping`.

For example, if a network has a bandwidth of 100 Mbps and a round trip time of 5ms, then the send and receive buffers should be at least  $(100 \times 10^6) \times (5/10^3)$  bits or approximately 62.5 Kilobytes.

The following equation shows the relationships between the units and factors involved:

$$\frac{100,000,000 \text{ bits}}{1 \text{ second}} \times \frac{1 \text{ byte}}{8 \text{ bits}} \times \frac{5 \text{ seconds}}{1000} = 62,500 \text{ bytes}$$

Setting the `SEND_BUF_SIZE` and `RECV_BUF_SIZE` parameters to at least the bandwidth-delay product insures that when large amounts of data are being sent that the network bandwidth will be optimally utilized.

Based on the preceding equation, the bandwidth-delay product of this network link is approximately 64 KB. If the largest message used to transfer redo data between a primary database and a standby database is 1 MB, then the value for the `SEND_BUF_SIZE` and `RECV_BUF_SIZE` parameters could be 1 MB. However, if the average message is less, then a setting of 64 KB should be sufficient to optimize use of the available bandwidth.

For most network protocols, ensure that the `RECV_BUF_SIZE` parameter at one end of the network connection, typically at the client, equals the value of the `SEND_BUF_SIZE` parameter at the other end, typically at the server.



#### See Also:

"[Statistics Example](#)" for additional information about determining messages sizes

## 14.4 Configuring I/O Buffer Space

Reliable network protocols, such as TCP/IP, buffer data into send and receive buffers while sending and receiving to or from lower and upper layer protocols. The sizes of these buffers affect network performance by influencing flow control decisions.

The `RECV_BUF_SIZE` and `SEND_BUF_SIZE` parameters specify sizes of socket buffers associated with an Oracle Net connection. To ensure the continuous flow of data and better utilization of network bandwidth, specify the I/O buffer space limit for receive and send operations of sessions with the `RECV_BUF_SIZE` and `SEND_BUF_SIZE` parameters. The `RECV_BUF_SIZE` and `SEND_BUF_SIZE` parameter values do not have to match, but should be set according to your environment.

For best performance, the size of the send and receive buffers should be set large enough to hold all the data that may be sent concurrently on the network connection. For optimal network performance, these buffers should be set to at least the bandwidth-delay product.

Use these parameters with caution as they affect network and system performance. The default values for these parameters are operating system specific. The following are the defaults for the Linux operating system:

- `SEND_BUF_SIZE`: 131,072 bytes (128k)
- `RECV_BUF_SIZE`: 174,700 bytes

These parameters are supported for TCP, TCP/IP with SSL, and SDPs. Additional protocols may support these parameters on certain operating systems. The

recommended values for these parameters are specified in the installation guide. Refer to operating system specific documentation for additional information.

 **Note:**

- The actual value of the `SEND_BUF_SIZE` and `RECV_BUF_SIZE` parameters may be less than the value specified because of limitations in the host operating system or due to memory constraints.
- It is important to consider the total number of concurrent connections that your system must support and the available memory resources. The total amount of memory consumed by these connections depends on the number of concurrent connections and the size of their respective buffers.

- [Configuring I/O Buffer Size on the Server](#)
- [Configuring I/O Buffer Space on the Client](#)

 **See Also:**

*Oracle Call Interface Programmer's Guide* for additional information about the `OCI_PREFETCH_MEMORY` parameter

## 14.4.1 Configuring I/O Buffer Size on the Server

Because the database server writes data to clients, setting the `SEND_BUF_SIZE` parameter on the server-side is typically adequate. If the database server is receiving large requests, then also set the `RECV_BUF_SIZE` parameter. To configure the database server, set the buffer space size in the `listener.ora` and `sqlnet.ora` files.

In the `listener.ora` file, specify the buffer space parameters for a particular protocol address or for a description. The following is an example of the settings:

```
LISTENER=
(DESCRIPTION=
(AADDRESS=(PROTOCOL=tcp)(HOST=sales-server)(PORT=1521)
(SEND_BUF_SIZE=11784)
(RECV_BUF_SIZE=11784))
(AADDRESS=(PROTOCOL=ipc)(KEY=extproc)
(SEND_BUF_SIZE=11784)
(RECV_BUF_SIZE=11784)))
LISTENER2=
(DESCRIPTION=
(SEND_BUF_SIZE=8192)
(RECV_BUF_SIZE=16384)
(AADDRESS=(PROTOCOL=tcp)(HOST=sales-server)(PORT=1521)))
```

Although the preceding example has multiple addresses, the `ADDRESS_LIST` parameter was not used. This is because the `ADDRESS_LIST` parameter is not mandatory.

The following is an example of the settings in the `sqlnet.ora` file:

```
RECV_BUF_SIZE=65536
SEND_BUF_SIZE=65536
```

- [Setting the Buffer Size Parameter for Shared Server Processes](#)

### 14.4.1.1 Setting the Buffer Size Parameter for Shared Server Processes

If using shared server processes, then you can override the current settings obtained from the server `sqlnet.ora` file by setting the buffer space parameters in the DISPATCHERS initialization parameter as follows:

```
DISPATCHERS="(ADDRESS=(PROTOCOL=tcp)(SEND_BUF_SIZE=65536))"
```

### 14.4.2 Configuring I/O Buffer Space on the Client

To configure the client, set the buffer space size in the following locations in the specified file:

- Setting only the `RECV_BUF_SIZE` parameter is typically adequate. If the client is sending large requests, then also set the `SEND_BUF_SIZE` parameter. These parameters are set in the client's `sqlnet.ora` file.
- For a particular connect descriptor, you can override the current settings in the client `sqlnet.ora` file. You can specify the buffer space parameters for a particular protocol address or description in the `tnsnames.ora` file similar to the following:

```
sales.us.example.com=
  (DESCRIPTION=
    (ADDRESS_LIST=
      (ADDRESS=(PROTOCOL=tcp)(HOST=sales1-server)(PORT=1521)
        (SEND_BUF_SIZE=11784)
        (RECV_BUF_SIZE=11784))
      (ADDRESS=(PROTOCOL=tcp)(HOST=sales2-server)(PORT=1521)
        (SEND_BUF_SIZE=11784)
        (RECV_BUF_SIZE=11784))
    (CONNECT_DATA=
      (SERVICE_NAME=sales.us.example.com)))
hr.us.example.com=
  (DESCRIPTION=
    (SEND_BUF_SIZE=8192)
    (RECV_BUF_SIZE=8192)
    (ADDRESS=(PROTOCOL=tcp)(HOST=hr1-server)(PORT=1521))
    (CONNECT_DATA=
      (SERVICE_NAME=hr.us.example.com)))
```

## 14.5 Configuring SDP Support for InfiniBand Connections

Oracle Net Services provides support for the Sockets Direct Protocol (SDP) for InfiniBand high-speed networks.

SDP is a standard communication protocol for clustered server environments. SDP is an interface between a network interface card and the application. By using SDP, applications place most of the messaging burden upon the network interface card, freeing the CPU for other tasks. As a result, SDP decreases network latency and CPU utilization.



SDP is designed specifically for System Area Networks (SANs). A SAN is characterized by short-distance, high-performance communications between multiple server systems, such as Oracle WebLogic Server or any other third-party middle-tier client and database servers clustered on one switch.

 **Note:**

Check with your individual vendor for their version compatibility with Oracle Database 12c.

Visit the Oracle Technology Network for additional information about SDP support at

<http://www.oracle.com/technetwork/index.html>

The following sections describe how to set up Oracle Net support of SDP for middle tier and database server communication. It contains the following topics:

- [Prerequisites for Using SDP](#)
- [Configuring SDP on the Server](#)
- [Configuring SDP on the Client](#)

 **See Also:**

"[Understanding Performance](#)" for an overview of supported deployments

## 14.5.1 Prerequisites for Using SDP

Prior to configuring support for SDP, install the required hardware, and set up InfiniBand hardware and software compatible with OpenFabrics Enterprise Distribution (OFED) 1.4 or 1.5 from a designated vendor on both the application web server and database server.

During installation of the InfiniBand software, identify the constant that defines SDP or the address family for the system. This can be obtained from the operating system or OFED documentation.

 **See Also:**

Vendor documentation for installation information

## 14.5.2 Configuring SDP on the Server

To configure the database server, configure an SDP address in the `listener.ora` file on the database server.

 **Note:**

If the SDP or address protocol family constant is not 27, the default value for Oracle Net Services, then define the constant in the `SDP.PF_INET_SDP` parameter in the `sqlnet.ora` file.

The following example shows an SDP endpoint that uses port number 1521 on the computer `sales-server`.

```
LISTENER=
  (DESCRIPTION=
    (ADDRESS_LIST=
      (ADDRESS=(PROTOCOL=sdp)(HOST=sales-server)(PORT=1521))
      (ADDRESS=(PROTOCOL=tcp)(HOST=sales-server)(PORT=1521))
      (ADDRESS=(PROTOCOL=ipc)(KEY=extproc))))
```

 **See Also:**

["Creating a List of Listener Protocol Addresses"](#)

## 14.5.3 Configuring SDP on the Client

 **Note:**

If the SDP or address protocol family constant is not 27, the default value for Oracle Net Services, then define the constant in the `SDP.PF_INET_SDP` parameter in the `sqlnet.ora` file.

The following procedure describes how to configure the Oracle WebLogic Server servers or third-party middle-tier client:

1. If configuring third-party middle-tier client, then upgrade the clients to use Oracle Database 12c client software, as follows:
  - a. Run Oracle Universal Installer.
  - b. Select **Oracle Database 12c Client** from the Available Products page.
2. For both Oracle WebLogic Server servers and third-party middle-tier client, create a network service name to connect to the database server, as follows:
  - For Oracle WebLogic Server servers, specify a network service name that uses the same TCP/IP protocol address configured in the `tnsnames.ora` file. For example:

```
sales=
  (DESCRIPTION=
    (ADDRESS=(PROTOCOL=tcp)(HOST=sales-server)))
  (CONNECT_DATA=
    (SERVICE_NAME=sales.us.example.com)))
```

- For third-party middle-tier clients, specify a network service name that uses the same SDP address configured in the `tnsnames.ora` file.

For example:

```
sales=
  (DESCRIPTION=
    (ADDRESS=(PROTOCOL=sdp)(HOST=sales-server)))
    (CONNECT_DATA=
      (SERVICE_NAME=sales.us.example.com)))
```

#### See Also:

[Configuring Naming Methods](#) for additional information about creating connect descriptors

## 14.6 Configuring Exadirect Support for InfiniBand Connections

Oracle Net Services provides support for the Exadirect for InfiniBand high-speed networks.. Use the new transport to improve latency and throughput by leveraging Remote Direct Memory Access (RDMA) in an InfiniBand environment

Exadirect protocol uses TCP for control communication and IB RC transport for data. The Exadirect protocol adapter is supported only on Oracle Linux in this release.

#### Note:

In Oracle Database 12c release 2 (12.2), Exadirect supports a single Exadirect endpoint configuration. It does not support DRCP.

The following sections describe how to set up Oracle Net support of Exadirect for middle tier and database server communication.

- [Prerequisites for Using Exadirect](#)
- [Configuring Exadirect on the Server](#)  
To configure the database server, configure an Exadirect address in the `listener.ora` file on the database server.
- [Configuring Exadirect on the Client](#)  
Specify a network service name that uses the same Exadirect address that is configured in the `tnsnames.ora` file.

### 14.6.1 Prerequisites for Using Exadirect

Exadirect can be used as a transport protocol between Exadata nodes. The Exadata version must be 12.1.2.3.3 or higher for Exadirect to work.

## 14.6.2 Configuring Exadirect on the Server

To configure the database server, configure an Exadirect address in the `listener.ora` file on the database server.

Configure `enable_exadirect_listener_name=on` parameter in `listener.ora` file. The following example shows an Exadirect endpoint that uses port number 1522 on the computer having IB interface as 192.168.10.1.

```
LISTENER
=
(DESCRIPTION=
(AADDRESS_LIST=
(AADDRESS=(PROTOCOL=exadirect)(HOST=192.168.10.1)(PORT=1522))
(AADDRESS=(PROTOCOL=tcp)(HOST=sales-server)(PORT=1521))
(AADDRESS=(PROTOCOL=ipc)(KEY=extproc))))

ENABLE_EXADIRECT_LISTENER=on
```

### Note:

To enable Exadirect flow control, set `exadirect_flow_control=on` in `sqlnet.ora` file. This is a negotiated parameter and should be set in both the server and the client `sqlnet.ora` file. `EXADIRECT_RECVPOLL` parameter specifies the time that a receiver polls for incoming data. Exadirect adapter uses HugePages.

## 14.6.3 Configuring Exadirect on the Client

Specify a network service name that uses the same Exadirect address that is configured in the `tnsnames.ora` file.

Enable Exadirect flow control by setting `exadirect_flow_control=on` in `sqlnet.ora` file.

```
(DESCRIPTION=
(AADDRESS=(PROTOCOL=exadirect)(HOST=192.168.10.1)(port=1522))
(CONNECT_DATA=
(SERVICE_NAME=sales.us.example.com)))
```

## 14.7 Limiting Resource Consumption by Unauthorized Users

Unauthorized access to the listener or database server can result in denial-of-service attacks, whereby an unauthorized client attempts to block authorized users' ability to access and use the system when needed. Malicious clients may attempt to flood the listener or database server with connect requests that have the sole purpose of

consuming resources, such as connections, processes, or threads. To mitigate these types of attacks, configure limits that constrain the time in which resources can be held prior to authentication. Client attempts to exceed the configured limits result in connection terminations and an audit trail containing the IP address of the client being logged.

To limit the resource consumption by unauthorized users and enable the audit trail, set time-limit values for the parameters described in [Table 14-1](#). These parameters do not have default values.

**Table 14-1 Connect-Timeout Parameters**

Parameter	File	Description
INBOUND_CONNECT_TIMEOUT_ <i>listener_name</i>	<code>listener.ora</code>	<p>The time, in seconds, for the client to complete its connect request to the listener after the network connection had been established.</p> <p>If the listener does not receive the client request in the time specified, then it terminates the connection. In addition, the listener logs the IP address of the client and an <a href="#">ORA-12525: Listener Has Not Received Client's Request in Time Allowed</a> error message to the <code>listener.log</code> file.</p>
SQLNET.INBOUND_CONNECT_TIMEOUT	<code>sqlnet.ora</code> on the database server	<p>The time, in seconds, for a client to connect with the database server and provide the necessary authentication information.</p> <p>If the client fails to establish a connection and complete authentication in the time specified, then the database server terminates the connection. In addition, the database server logs the IP address of the client and an <a href="#">ORA-12170: Connect Timeout Occurred</a> error message to the <code>sqlnet.log</code> file. The client receives either an <a href="#">ORA-12547: TNS:lost contact</a>, or an <a href="#">ORA-12637: Packet receive failed</a> error message.</p>

When specifying values for these parameters, consider the following recommendations:

- Set both parameters to an initial low value.
- Set the value of the `INBOUND_CONNECT_TIMEOUT_listener_name` parameter to a lower value than the `SQLNET.INBOUND_CONNECT_TIMEOUT` parameter.

For example, you can set `INBOUND_CONNECT_TIMEOUT_listener_name` to 2 seconds and `INBOUND_CONNECT_TIMEOUT` parameter to 3 seconds. If clients are unable to complete connections within the specified time due to system or network delays that are normal for the particular environment, then increment the time as needed.

 **See Also:**

- ["Resolving the Most Common Error Messages for Oracle Net Services"](#) for a description of error message workarounds
- ["Analyzing Listener Log Files"](#) for additional information about entries in the `listener.log` file
- ["About Advanced Profile Information"](#) for additional information about configuring these parameters

## 14.8 About Data-Dependent Routing

Sharding provides the ability to horizontally partition the data across multiple independent Oracle databases, also called shards, and based on a key specified in the connect string, route the database requests to a particular shard.

The routing is done at the session level and is based on the value of the sharding key specified in the connection string. The data-dependent routing assumes that all the database requests issued within a session are related to the data associated with the specified key value. If a client needs to access data with a different value of the key, it either establishes a new database session or re-uses a pre-established connection that maps to that sharding key. All the components that are responsible for routing database requests, such as shard directors (Global Service Managers) and connection pools, contain a routing table which maps the key value range to shards that store appropriate data. Oracle Sharding automatically maintains consistency of routing tables across all these components.

- [Configuring Data-Dependent Routing for Client-Server Connections](#)  
It involves a single redirection of the connection request process.

### 14.8.1 Configuring Data-Dependent Routing for Client-Server Connections

It involves a single redirection of the connection request process.

Composite sharding enables two levels of sharding - one by list or range and another by consistent hash. This is accomplished by the application providing two keys: a super sharding key and a sharding key. With data-dependent routing, the connect string used by the clients to connect to a shard must contain either the `(SHARDING_KEY=...)` or `(SHARDING_KEY=...) (SUPER_SHARDING_KEY=...)` in the `CONNECT_DATA` section. The connect string should be in the format required to connect to a global service. The shard directors should be specified as endpoints and, a global service name and region name should be used in `CONNECT_DATA` in addition to the `SUPER_SHARDING_KEY`, or the `SHARDING_KEY`, or both.

To process a connection request:

- A connection is established to one of the shard directors.
- The shared director performs a lookup for the service and key values, and then redirects the client to a shard containing the data.

The client executes a SQL statement and receives results directly from the shard.

```
(DESCRIPTION=
  (FAILOVER=on)
  (ADDRESS_LIST=
    (LOAD_BALANCE=ON)
    (ADDRESS=(host=sales-east1)(port=1522))
    (ADDRESS=(host=sales-east2)(port=1522))
    (ADDRESS=(host=sales-east3)(port=1522)))
  (ADDRESS_LIST=
    (LOAD_BALANCE=ON)
    (ADDRESS=(host=sales-west1)(port=1522))
    (ADDRESS=(host=sales-west2)(port=1522))
    (ADDRESS=(host=sales-west3)(port=1522)))
  (CONNECT_DATA=
    (SERVICE_NAME=sales)
    (SHARDING_KEY=40598230) (SUPER_SHARDING_KEY=gold)
    (REGION=east)))
```

### Related Topics

- *Oracle Database Global Data Services Concepts and Administration Guide*

# Part III

## Testing and Troubleshooting Oracle Net Services

Part III describes how to establish connections, and identify and diagnose problems with Oracle Net Services.

- [Testing Connections](#)
- [Troubleshooting Oracle Net Services](#)



# 15

## Testing Connections

After you have configured the network, you should connect and test each component to ensure that the network is functioning properly. Oracle Net Services provides tools to help you test the listener, database, and Oracle Connection Manager.

- [Testing the Network](#)
- [Using the TNSPING Utility to Test Connectivity from the Client](#)
- [Using the TRCROUTE Utility to Test Connectivity from the Client](#)

### 15.1 Testing the Network

The following is the recommended sequence for testing the network:

1. Start and test each listener. To start the listener, use the procedure described in "[Starting Oracle Net Listener and the Oracle Database Server](#)".

To test a listener, initiate a connection from a client to any active database controlled by that listener.

2. Start and test each Oracle Connection Manager, if included in your network. To start Oracle Connection Manager, use the procedure described in "[Starting Oracle Connection Manager](#)".

To test Oracle Connection Manager, initiate a connection from a client to any active database that has been registered with Oracle Connection Manager.

3. Test the server with a loopback test or Oracle Net Manager.

A loopback test uses Oracle Net to go from the database server back to itself, bypassing the Interprocess Communication (IPC). Performing a successful loopback verifies that Oracle Net is functioning on the database server. The following procedure describes how to perform a loopback test using Oracle Net Manager:

- a. Start Oracle Net Manager.



#### See Also:

["Using Oracle Net Manager to Configure Oracle Net Services"](#)

- b. In the navigator, expand **Directory** or **Local**, and then select **Service Naming**.
- c. Select the network service name or database service.
- d. Choose **Command**, and then select **Test Net Service**.

Testing assumes the listener and database are running. If they are not, then see "[Starting Oracle Net Listener and the Oracle Database Server](#)" to start components.

During testing, a Connection Test dialog box appears, providing status and test results. A successful test results in the following message:

```
The connection test was successful.
```

If the test was successful, then proceed to step 3.e.

If the test was not successful, then use the error message to determine further action. For example, if the error message is the following:

```
Attempting to connect using userid: scott
The test did not succeed.
ORA-28000: the account is locked
```

```
There may be an error in the fields entered,
or the server may not be ready for a connection.
```

Change the user name to an account known to be unlocked. To change the user name, click **Change Login**. You are prompted for the password.

e. Click **Close** to close the Connect Test dialog box.

#### 4. Test client with a connection.

To test several different clients in your network, initiate a connection to a database server from each of them using the following command:

```
CONNECT username@connect_identifier
```

## 15.2 Using the TNSPING Utility to Test Connectivity from the Client

The TNSPING utility determines whether the listener for a service on an Oracle Net network can be reached successfully.

If you can connect successfully from a client to a server (or a server to another server) using the TNSPING utility, then it displays an estimate of the round trip time (in milliseconds) it takes to establish a SQLNET connection to the Oracle listener corresponding to the server.

If it fails, then it displays a message describing the error that occurred. This enables you to see the network error that is occurring without the overhead of a database connection.

Use the following command to test connectivity:

```
tnsping net_service_name count
```

In the preceding command, the following arguments are used:

- *net\_service\_name* must exist in `tnsnames.ora` file or the name service in use, such as NIS.
- *count* determines how many times the program attempts to reach the server. This argument is optional.

If the network service name specified is a database name, then TNSPING attempts to contact the corresponding listener. It does not actually determine whether the database is running. Use SQL\*Plus to attempt a connection to the database.

The following are some examples of TNSPING.

 **Note:**

Different platforms may have different interfaces, but the program accepts the same arguments. Invoke TNSPING for the display of the proper interface requirements.

[Example 15-1](#) is an example of checking a listener for a database using a network service name of `sales` using the TNSPING command.

### Example 15-1 Checking a Listener with TNSPING

```
TNSPING sales
```

This produces the following message:

```
TNS Ping Utility for Linux: Version 18.0.0.0.0 - Production on 21-JAN-2018
```

```
Copyright (c) 1997, 2016 Oracle Corporation. All rights reserved.
```

```
Used parameter files:
```

```
Used TNSNAMES adapter to resolve the alias
```

```
Attempting to contact (DESCRIPTION = (ADDRESS_LIST = (ADDRESS = (PROTOCOL =  
TCP)(HOST = sales-server)(PORT = 1521))) (CONNECT_DATA = (SERVICE_NAME =  
sales.us.example.com)))
```

```
OK (10 msec)
```

To determine whether the listener for the `sales` database is available, and to specify that TNSPING try to connect eight times and then give up, use the following syntax:

```
tnsping sales 8
```

This command produces the following message:

```
TNS Ping Utility for Linux: Version 18.0.0.0.0 - Production on 21-JAN-2018
```

```
Copyright (c) 1997, 2016 Oracle Corporation. All rights reserved.
```

```
Used parameter files:
```

```
Used TNSNAMES adapter to resolve the alias
```

```
Attempting to contact (DESCRIPTION = (ADDRESS_LIST = (ADDRESS = (PROTOCOL =  
TCP)(HOST = sales-server)(PORT = 1521))) (CONNECT_DATA = (SERVICE_NAME =  
sales.us.example.com)))
```

```
OK (10 msec)
```

```
OK (0 msec)
```

```
OK (10 msec)
```

```
OK (0 msec)
```

```
OK (10 msec)
```

```
OK (10 msec)
```

```
OK (10 msec)
```

```
OK (0 msec)
```

[Example 15-2](#) is an example of TNSPING attempting to check using an invalid network service name.

**Example 15-2 Checking an Invalid Net Service Name with TNSPING**

```
tnsping badname
```

This attempt produces the following message:

```
TNS Ping Utility for Linux: Version 18.0.0.0.0 - Production on 21-MAY-2018  
Copyright (c) 1997, 2018 Oracle Corporation. All rights reserved.  
Used parameter files:  
TNS-03505: Failed to resolve name
```

[Example 15-3](#) is an example of output when using TNSPING to check a name that is valid, but resolves to an address where no listener is located, for example, the listener may not be started.

**Example 15-3 Checking Valid Net Service Name but No Listener with TNSPING**

```
tnsping sales
```

```
TNS Ping Utility for Linux: Version 18.0.0.0.0 - Production on 21-JAN-2018  
Copyright (c) 1997, 2016 Oracle Corporation. All rights reserved.  
Used parameter files:  
Used TNSNAMES adapter to resolve the alias  
Attempting to contact (DESCRIPTION = (ADDRESS_LIST = (ADDRESS = (PROTOCOL =  
TCP)(HOST = sales-server)(PORT = 1521))) (CONNECT_DATA = (SERVICE_NAME =  
sales.us.example.com)))  
TNS-12541: TNS:no listener
```

## 15.3 Using the TRCROUTE Utility to Test Connectivity from the Client

The Trace Route Utility (TRCROUTE), in Linux and UNIX environments, enables administrators to discover the path or route a connection takes from a client to a server. If TRCROUTE encounters a problem, then it returns an error stack to the client instead of a single error. These additional error messages make troubleshooting easier.

TRCROUTE is different from TNSPING in that it travels as a special type of connect packet, and is routed as such. As it travels toward its destination, the TRCROUTE connect packet collects the TNS addresses of every node it travels through. If an error occurs, then TRCROUTE collects error information that shows where the error occurred. The TRCROUTE displays the information collected on the client screen. You can redirect the TRCROUTE output to a file, and print it.

The TRCROUTE uses minimal resources. It gathers information in the connect data of a special connect packet. Standard connect packets are not affected.

The server is not affected by TRCROUTE. The listener receives and processes the TRCROUTE connect packet. It returns the information to the client by putting it into a refuse packet. The server does not need to start any new processes or deal with dummy connections.

To use the TRCROUTE utility, enter the following command:

```
trcroute net_service_name
```

[Example 15-4](#) shows a successful trace route packet that traveled from a client to a listener.

#### **Example 15-4 Successful Trace Route**

```
trcroute sales

Trace Route Utility for Linux: Version 18.0.0.0.0 - Production on 21-JAN-2018

Copyright (c) 1999, 2018 Oracle Corporation. All rights reserved.

Route of TrcRoute:
-----

Node: Client          Time and address of entry into node:
-----
09-NOV-2012 21:48:48 ADDRESS= PROTOCOL=TCP  HOST=10.150.21.136  PORT=14001

Node: Server          Time and address of entry into node:
-----
09-NOV-2012 21:48:05 ADDRESS= PROTOCOL=TCP  HOST=10.150.21.136  PORT=14001
```

[Example 15-5](#) shows an unsuccessful trace route packet that could not reach the listener because the listener was not up.

#### **Example 15-5 Trace Route with Error**

```
trcroute sales

Trace Route Utility for Linux: Version 18.0.0.0.0 - Production on 21-JAN-2018

Copyright (c) 1999, 2018 Oracle Corporation. All rights reserved.

Route of TrcRoute:
-----

Node: Client          Time and address of entry into node:
-----
25-FEB-2012 14:43:05 ADDRESS= PROTOCOL=TCP  HOST=sales-server  PORT=1521

TNS-12543: TNS:unable to connect to destination
TNS-12541: TNS:no listener
TNS-12560: TNS:protocol adapter error
TNS-03601: Failed in route information collection
```

# 16

## Troubleshooting Oracle Net Services

Oracle Net Services provides methods for understanding, testing and resolving network problems. Oracle Database includes utilities, and log and trace files for testing and diagnosing network connection and problems. The TNSPING and TRCROUTE utilities test connectivity. The log and trace files keep track of the interaction between network components as errors occur. Evaluating this information helps to diagnose and troubleshoot network problems.

Understand the common testing procedures and network errors, and outline procedures for resolving problems. Also, learn methods for logging and tracing error information to diagnose and troubleshoot more complex network problems.

- [Understanding Automatic Diagnostic Repository](#)
- [Diagnosing Oracle Net Services](#)
- [Resolving the Most Common Error Messages for Oracle Net Services](#)
- [Troubleshooting Suggestions for Oracle Net Services](#)
- [Example of Troubleshooting a TNS-12154 Error](#)
- [Logging Error Information for Oracle Net Services](#)
- [Tracing Error Information for Oracle Net Services](#)
- [Contacting Oracle Support Services](#)

### 16.1 Understanding Automatic Diagnostic Repository

The Automatic Diagnostic Repository (ADR) (ADR) is a systemwide tracing and logging central repository. The repository is a file-based hierarchical data store for depositing diagnostic information, including network tracing and logging information.

The ADR home is the unit of the ADR directory that is assigned to an instance of an Oracle product. Each database instance has its own ADR home. Similarly, each listener, Oracle Connection Manager, and client instance has its own ADR home.

In case of a process failure, an incident is generated. The incident dump files are located in the `ADR_BASE/ADR_HOME/incident/` directory, By default, `ADR_BASE` is `ORACLE_BASE` if the `ORACLE_BASE` variable is set. If the variable is not set, then `ADR_BASE` is `ORACLE_HOME/log`. `ADR_BASE` can be set to any location.

The incident dump file location can be found inside the process trace file.

The location of an ADR home is given by the following path, which starts at the ADR base directory:

```
diag/product_type/product_id/instance_id
```

The following table lists the values of the path components for an Oracle Net Listener instance.

**Table 16-1 ADR Home Path Components for an Oracle Net Listener Instance**

Path Component	Value for Oracle Net Listener
product_type	tnslsnr
product_id	host name
instance_id	listener alias name

The following figure illustrates the directory hierarchy of the ADR for an Oracle Net Listener instance. Other ADR homes for other Oracle products or components, such as Automatic Storage Management (ASM) or Oracle Database, can exist within this hierarchy, under the same ADR base.

**Figure 16-1 Directory Structure for an Oracle Net Listener Instance**

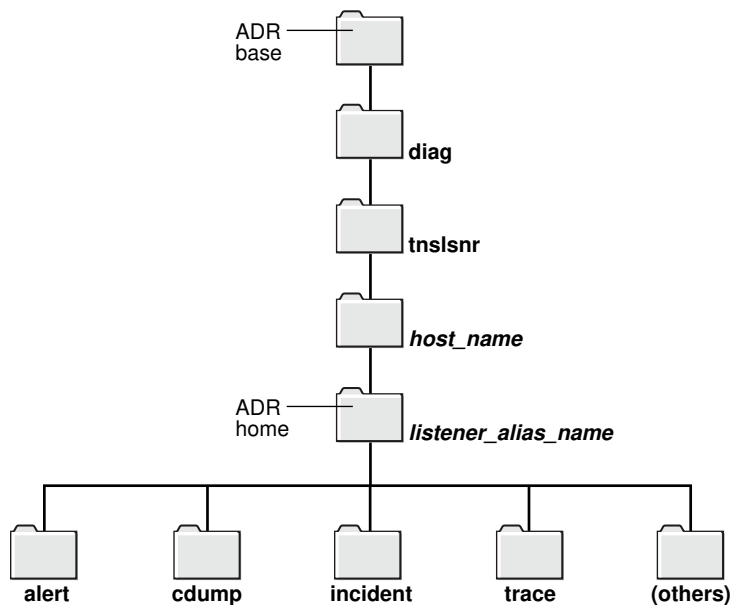

The following table lists the values of the path components for an Oracle Connection Manager instance.

**Table 16-2 ADR Home Path Components for an Oracle Connection Manager Instance**

Path Component	Value for Oracle Connection Manager
product_type	netcman
product_id	host name
instance_id	Oracle Connection Manager instance name

The following figure illustrates the directory hierarchy of the ADR for an Oracle Connection Manager instance. Other ADR homes for other Oracle products or components, such as Oracle ASM or Oracle Database, can exist within this hierarchy, under the same ADR base.

**Figure 16-2 Directory Structure for an Oracle Connection Manager Instance**

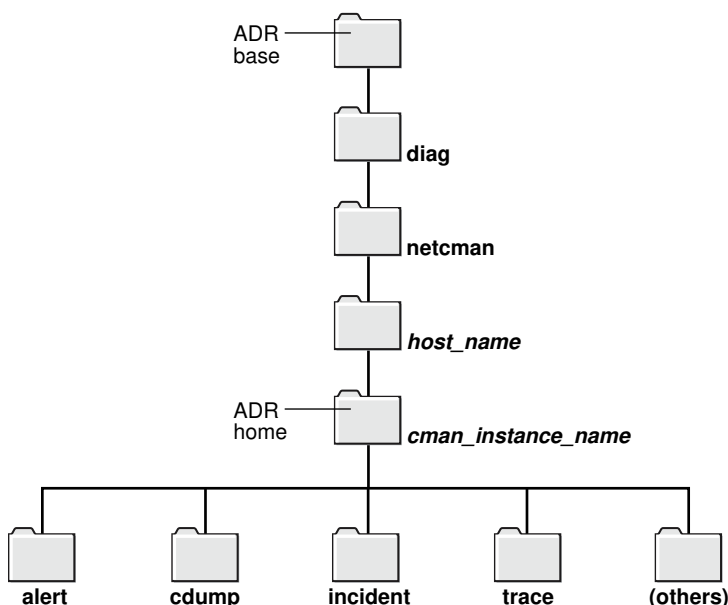

Within the ADR home directory are subdirectories where each instance, such as the database, listener, Oracle Connection Manager, or client, stores diagnostic data. The following table lists all the subdirectories shown in the preceding figure and their contents.

**Table 16-3 ADR Home Subdirectories**

Subdirectory Name	Contents
alert	The XML-formatted log named <code>log.xml</code> .
cdump	Core files.
incident	Multiple subdirectories, in which each subdirectory is named for a particular incident, and each contains dumps pertaining only to that incident.
trace	Background and server process trace files, SQL trace files, and text version of the <code>log.xml</code> file in the alert directory.
(others)	Other subdirectories of ADR home, which store incident packages, health monitor reports, and other information.

The `ADR_BASE` directory is the physical location in which one or more ADR homes are placed. Conceptually, it is the root directory of ADR.

Non-ADR (meaning that the `DIAG_ADR_ENABLED` parameter is set to `OFF`) diagnostic and tracing methods are still current and applicable but the parameters are ignored if ADR is enabled. ADR is enabled by default.

Diagnostic parameters are found in the following configuration files:

- `sqlnet.ora` for clients
- `listener.ora` for listeners



- `cman.ora` for Oracle Connection Managers

The following table compares usage of diagnostic parameters found in the `sqlnet.ora` file used in both ADR-based and non-ADR-based diagnostics.

**Table 16-4 sqlnet.ora File Diagnostic Parameter Comparison**

Parameter	DIAG_ADR_ENABL ED=ON	DIAG_ADR_ENABL ED=OFF
ADR_BASE	Enabled	Disabled
TRACE_LEVEL_CLIENT	Enabled	Enabled
TRACE_LEVEL_SERVER	Enabled	Enabled
TRACE_DIRECTORY_CLIENT	Disabled	Enabled
TRACE_FILE_CLIENT	Disabled	Enabled
TRACE_UNIQUE_CLIENT	Disabled	Enabled
LOG_DIRECTORY_CLIENT	Disabled	Enabled
LOG_FILE_CLIENT	Disabled	Enabled
LOG_DIRECTORY_SERVER	Disabled	Enabled
TRACE_DIRECTORY_SERVER	Disabled	Enabled
TRACE_FILE_SERVER	Disabled	Enabled

The following table compares usage of diagnostic parameters found in the `listener.ora` file used in both ADR-based and non-ADR-based diagnostics.

**Table 16-5 listener.ora File Diagnostic Parameter Comparison**

Parameter	DIAG_ADR_ENABL ED=ON	DIAG_ADR_ENABL ED=OFF
ADR_BASE_listener_name	Enabled	Disabled
LOGGING_listener_name	Enabled	Enabled
TRACE_LEVEL_listener_name	Enabled	Enabled
TRACE_TIMESTAMP_listener_name	Enabled	Enabled
LOG_DIRECTORY_CLIENT_listener_name	Disabled	Enabled
LOG_FILE_CLIENT_listener_name	Disabled	Enabled
TRACE_DIRECTORY_CLIENT_listener_name	Disabled	Enabled
TRACE_FILELEN_listener_name	Disabled	Enabled
TRACE_FILENO_listener_name	Disabled	Enabled

[Table 16-6](#) compares usage of diagnostic parameters found in the `cman.ora` file used in both ADR-based and non-ADR-based diagnostics.

**Table 16-6 cman.ora File Diagnostic Parameter Comparison**

Parameter	DIAG_ADR_ENABL ED=ON	DIAG_ADR_ENABL ED=OFF
ADR_BASE	Enabled	Disabled

**Table 16-6 (Cont.) cman.ora File Diagnostic Parameter Comparison**

Parameter	DIAG_ADR_ENABL ED=ON	DIAG_ADR_ENABL ED=OFF
LOG_LEVEL	Enabled	Enabled
TRACE_LEVEL	Enabled	Enabled
TRACE_TIMESTAMP	Enabled	Enabled
LOG_DIRECTORY	Disabled	Enabled
TRACE_DIRECTORY	Disabled	Enabled
TRACE_FILELEN	Disabled	Enabled
TRACE_FILENO	Disabled	Enabled

- [ADRCI: ADR Command Interpreter](#)

 **See Also:**

- *Oracle Call Interface Programmer's Guide* for additional information about the location of the client ADR Home
- *Oracle Database Administrator's Guide* for additional information about ADR
- *Oracle Database Net Services Reference* for descriptions of the diagnostic parameters

## 16.1.1 ADRCI: ADR Command Interpreter

ADRCI is a command-line tool that is part of the fault diagnosability infrastructure. ADRCI enables you to do the following:

- View diagnostic data within ADR
- Package incident and problem information into a zip file for transmission to Oracle Support Services

Diagnostic data includes incident and problem descriptions, trace files, dumps, health monitor reports, alert log entries, and so on.

ADRCI has a rich command set, and can be used in interactive mode or within scripts. In addition, ADRCI can run scripts of ADRCI commands in the same way that SQL\*Plus runs scripts with SQL and PL/SQL commands.

To view trace files using ADRCI, enter `ADRCI` at a command line. The following are common ADRCI commands used to check a client:

### Client Side

```
adrci> SHOW ALERT
adrci> SHOW BASE -product client
adrci> SET BASE -product client
```

```
adrci> SHOW TRACEFILE
adrci> SHOW TRACE trace_file.trc
adrci> SHOW SPOOL
```

In the preceding commands, the `SHOW ALERT` command shows the `log.xml` file in a text editor, such as VI. The `SHOW BASE -product client` command displays the value of the `ADR_BASE` directory for the client. Use that value for *client* in the `SET BASE` command.

The following are common ADRCI commands used to check a server:

### Server Side

```
adrci> SHOW BASE
adrci> SHOW TRACEFILE
adrci> SHOW TRACE trace_file.trc
```

Other ADRCI command options are available for a more targeted Oracle Net trace file analysis. Type `HELP` at the ADRCI prompt for help documentation.



#### See Also:

*Oracle Database Utilities* for additional information about ADRCI

## 16.2 Diagnosing Oracle Net Services

Any underlying fault, noticeable or not, is reported by Oracle Net Services with an error number or message. The error number and message provide useful information for diagnosing the problem, but may not always identify the actual problem. The tasks in this section help determine which parts of Oracle Net Services do function properly rather than the parts which do not work. They also help to determine in which of the following categories the fault belongs:

- Oracle software
- Operating system layer
- Other network layers

Testing the various network layers progressively should, in most cases, uncover any problem.

- [Diagnosing Server Problems](#)
- [Diagnosing Client Problems](#)

### 16.2.1 Diagnosing Server Problems

To start diagnosing server problems, you should answer the following questions:

- Is any other system such as a workstation or server able to connect to the server using Oracle Net?
- Has the server, database, or listener configuration remained the same for some time?

If you answered yes to either of the preceding questions, then go to "[Diagnosing Client Problems](#)".

If you are unsure, or answered no to any of the preceding questions, then use the tasks in this section to diagnose the problem. Diagnosing Oracle Net Services on the server involves the following tasks:

- [Task 1, Verify the Database is Running](#)
- [Task 2, Perform a Loopback Test](#)

### Task 1 Verify the Database is Running

To check that the database is up, log in to the database and connect with a valid username and password. For example:

```
SQLPLUS system
Enter password: password
```

A message appears, confirming that you are connected with the database. If you receive the following errors, then ask the database administrator to assist you:

- ORA-1017: invalid U/P
- ORA-1034: Oracle not available

### Task 2 Perform a Loopback Test

A loopback test uses Oracle Net to go from the database server back to itself, bypassing the Interprocess Communication (IPC) protocol. Many network protocols provide a means of testing network connections. The PING utility can be used with a TCP/IP network. Performing a successful loopback verifies that Oracle Net is functioning on the database server.

The following procedure describes how to perform a loopback test from the server to the database:

1. Ensure that the `listener.ora`, `tnsnames.ora`, and `sqlnet.ora` files exist in the correct locations, as described in "[Using Localized Management](#)".
2. Start Oracle Net Manager.



#### See Also:

["Using Oracle Net Manager to Configure Oracle Net Services"](#)

3. In the navigator, expand the **Directory** or **Local** option.
4. Expand **Service Naming** to view the available network service and database names.
5. Select the network service name or database service.
6. Choose **Command**, and then select **Test Net Service**.

Testing assumes the listener and database are running. If they are not, then see "[Starting Oracle Net Listener and the Oracle Database Server](#)" to start components.

During testing, a Connection Test dialog box appears, providing status and test results. A successful test results in the following message:

The connection test was successful.

If the test was successful, then proceed to step 7.

If the test was not successful, then do the following:

- a. Ensure the database and listener are running, and then click **Test**.
  - b. Click **Change Login** to change the username and password for the connection, and then click **Test**.
    - If the loopback test passes, then go to "[Diagnosing Client Problems](#)".
    - If the loopback test continues to fail, then contact Oracle Support Services.
7. Click **Close** to close the Connect Test dialog box.

## 16.2.2 Diagnosing Client Problems

Verify at least one of the following statements. This will help you decide if it is a client problem.

- The database server passed a loopback test, showing the connection worked.
- Other computers connect using Oracle Net Services to the same database.
- Connections from this workstation worked before making changes on this computer, such as the installation of a new product or modification to the network configuration.

The following procedure describes how to perform diagnostics on the client:

1. Check that you have installed the same protocol support that was installed on the database server.

On Linux and UNIX platforms you can use the `ADAPTERS` utility to verify protocol support. On the database server, run the following command from the `ORACLE_HOME/bin` directory to display the protocol support, naming methods, and security options linked with the `oracle` executable:

```
adapters ./oracle
```

The `adapters` utility displays output similar to the following:

Installed Oracle Net transport protocols are:

```
IPC
BEQ
TCP/IP
SSL
RAW
SDP/IB
```

Installed Oracle Net naming methods are:

```
Local Naming (tnsnames.ora)
Oracle Directory Naming
Oracle Host Naming
NIS Naming
```

Installed Oracle Advanced Security options are:

```
RC4 40-bit encryption
```

```
RC4 56-bit encryption
RC4 128-bit encryption
RC4 256-bit encryption
DES40 40-bit encryption
DES 56-bit encryption
3DES 112-bit encryption
3DES 168-bit encryption
AES 128-bit encryption
AES 192-bit encryption
AES 256-bit encryption
MD5 crypto-checksumming
SHA crypto-checksumming (for FIPS)
SHA-1 crypto-checksumming
Kerberos v5 authentication
RADIUS authentication
```

On the client, run the `adapters` command from the `ORACLE_HOME/bin` directory to display the configured Oracle protocol support, naming methods, and security options. The `ADAPTERS` utility displays output similar to the following:

Installed Oracle Net transport protocols are:

```
IPC
BEQ
TCP/IP
SSL
RAW
SDP/IB
Exadirect
```

Installed Oracle Net naming methods are:

```
Local Naming (tnsnames.ora)
Oracle Directory Naming
Oracle Host Naming
```

Installed Oracle Advanced Security options are:

```
RC4 40-bit encryption
RC4 56-bit encryption
RC4 128-bit encryption
RC4 256-bit encryption
DES40 40-bit encryption
DES 56-bit encryption
3DES 112-bit encryption
3DES 168-bit encryption
AES 128-bit encryption
AES 192-bit encryption
AES 256-bit encryption
MD5 crypto-checksumming
SHA-1 crypto-checksumming
Kerberos v5 authentication
RADIUS authentication
```

 **Note:**

RAW is an internal protocol used by Oracle Net.

 **See Also:**

*Oracle Database Administrator's Reference* for additional information about the `adapters` utility

2. Check base connectivity for underlying network transport. Oracle Net technology depends on the underlying network for a successful connection.

**Table 16-7**

Protocol	Verify that you can...
TCP/IP	Use terminal emulation or file transfer utilities, (PING, FTP, TELNET) from the client to the database server.
Named Pipes	<ul style="list-style-type: none"> <li>• See other computers or servers on the Microsoft network.</li> <li>• Ensure that you are able to share drives within the network.</li> </ul>

3. Ensure that the Oracle Net foundation layer and the appropriate Oracle protocol support are present by verifying that all Oracle Net Services software has been installed for the client.
4. Ensure that the client computer has the `tnsnames.ora` and the `sqlnet.ora` files in the correct locations.

 **See Also:**

["Using Localized Management"](#)

If any other working client computers are connecting to the selected Oracle Database, then back up your existing files and copy both the working `tnsnames.ora` and `sqlnet.ora` files from the working client computer to the non-working clients. This eliminates the possibility of errors in the files.

5. Test the Oracle Net foundation layer. You can test using the following command to connect to SQL\*Plus:

```
SQLPLUS user/password@connect_string
```

 **Note:**

Do not use the `TNSPING` utility. The `TNSPING` utility works like the TCP/IP ping utility and does not create and open a socket, nor does it connect with the listener. It only shows that the listener is present on the database server.

6. If the connection still fails, then do the following:
  - a. Use tracing, as described in section ["Tracing Error Information for Oracle Net Services"](#).

- b. Check the Oracle Support Services website for a specific diagnostics bulletin on the error received.
- c. Contact Oracle Support Services.

## 16.3 Resolving the Most Common Error Messages for Oracle Net Services

Due to the complexity of network communications, network errors may originate from a variety of sources, for a variety of reasons. If an error occurs, then applications such as SQL\*Plus, that depend on network services from Oracle Net Services, normally generate an error message.

A list of the most common network error messages follows:

For information about the specific error messages, use the Oracle error tool `oerr`, by entering the following command at any command line:

```
oerr code error_number
```

In the preceding command, *code* is the type of message, such as ORA and TNS, and *error\_number* is the number associated with the error message.

- [ORA-03113: End-of-file on Communication Channel](#)
- [ORA-12154: Could Not Resolve the Connect Identifier Specified](#)
- [ORA-12170: Connect Timeout Occurred](#)
- [TNS-12500 or ORA-12500: Listener Failed to Start a Dedicated Server Process](#)
- [ORA-12514: Listener Does Not Currently Know of Service Requested in Connect Descriptor](#)
- [ORA-12520: Listener Could Not Find Available Handler for Requested Type of Server](#)
- [ORA-12521: Listener Does Not Currently Know of Instance Requested in Connect Descriptor](#)
- [ORA-12525: Listener Has Not Received Client's Request in Time Allowed](#)
- [ORA-12533: Illegal Address Parameters](#)
- [TNS-12540 or ORA-12540: TNS:Internal Limit Restriction Exceeded and TNS-00510: Internal Limit Restriction Exceeded](#)
- [TNS-12541 or ORA-12541: TNS:No Listener](#)
- [TNS-12549 or ORA-12549: TNS:Operating System Resource Quota Exceeded and TNS-00519: Operating System Resource Quota Exceeded](#)
- [TNS-12560 or ORA-12560: TNS:Protocol Adapter Error Occurred](#)
- [Directory Naming Errors](#)





**See Also:**

*Oracle Database Error Messages* for a complete listing of error messages

## 16.3.1 ORA-03113: End-of-file on Communication Channel

This message indicates that an error has occurred on the database server.

Check the `alert_sid.log` file on the server. An unexpected end of file was processed on the communication channel. This may be an indication that the communications link may have gone down at least temporarily, or it may indicate that the server has gone down. You may need to modify your retransmission count.

## 16.3.2 ORA-12154: Could Not Resolve the Connect Identifier Specified

This message indicates that a connection to a database or other service was requested using a connect identifier, and the connect identifier specified could not be resolved into a connect descriptor using one of the naming methods configured. For example, if the type of connect identifier used was a network service name then the network service name could not be found in a naming method repository, or the repository could not be located or reached.

Perform the following steps:

1. Check the type of naming adapters listed in the `NAMES.DIRECTORY_PATH` parameter in the `sqlnet.ora` file. If none are configured, then use the `adapters` command to determine which adapters are in use. The following example shows the adapters:

```
$ adapters
...
Installed Oracle Net naming methods are:

Local Naming (tnsnames.ora)
Oracle Directory Naming
Oracle Host Naming
NIS Naming
```

The network service name given in the connect string should be defined for at least one of the naming methods.

2. Check the resolution path for each adapter for possible problems. For example, ensure that the name given in the connect string is correct and complete, using the full name of the network service if necessary.

In addition to the preceding steps, perform the steps depending on your naming methods:

- [ORA-12154 Error When Using the Local Naming Method](#)
- [ORA-12154 Error When Using the Directory Naming Method](#)
- [ORA-12154 Error When Using the Easy Connect Naming Method](#)
- [ORA-12154 Error When Using the External Naming Method](#)

### 16.3.2.1 ORA-12154 Error When Using the Local Naming Method

Perform the following steps when using the local naming method:

1. Verify that the `tnsnames.ora` file exists and is in the correct location. You can find the `tnsnames.ora` file in any of the following locations:
  - The directory specified by the `TNS_ADMIN` environment variable, if it is set.
  - The `ORACLE_BASE_HOME/network/admin` directory. If the file is not present in the `ORACLE_BASE_HOME/network/admin` directory, then look for the file in `ORACLE_HOME/network/admin` directory.
2. Verify there is an entry in the `tnsnames.ora` file for the name given in the connect string. This network service name should match the name in the `tnsnames.ora` file exactly if the name is simple and there is not `NAMES_DEFAULT_DOMAIN` in the `sqlnet.ora` file, or the network service name is a fully-qualified name. If the network service name in the connect string is simple, then check the `NAMES_DEFAULT_DOMAIN` parameter in the `sqlnet.ora` file. Its value is appended to the network service name given in the connect string. This fully-qualified name should be the entry in the `tnsnames.ora` file.
3. If you are connecting from a login dialog box, then verify that you are not placing an at sign (`@`) before the connect network service name.
4. Activate client tracing, and repeat the operation.

### 16.3.2.2 ORA-12154 Error When Using the Directory Naming Method

Perform the following steps when using the directory naming method:

1. Verify the `ldap.ora` file exists and is in the correct location. The following directories are searched for `ldap.ora` file in the order given. The `ldap.ora` file found will be used.
  - The directory specified by the `TNS_ADMIN` environment variable.
  - The `ORACLE_BASE_HOME/network/admin` directory. If the file is not present in the `ORACLE_BASE_HOME/network/admin` directory, then look for the file in `ORACLE_HOME/network/admin` directory.
  - The directory specified by the `LDAP_ADMIN` environment variable.
  - The `ORACLE_BASE_HOME/network/admin` directory for a read-only Oracle home.
  - The `ORACLE_HOME/network/admin` directory for a read/write Oracle home.
2. Verify that the parameters defined in the `ldap.ora` file are correct, as follows:
  - The `DIRECTORY_SERVERS` parameter defines the correct host and port for one or more valid LDAP servers.
  - The `DEFAULT_ADMIN_CONTEXT` parameter defines the location of the Oracle Context in this directory which should include the network service entry.

If the `ldap.ora` file does not exist, then these parameters are resolved using automatic discovery.

3. Verify that the LDAP server host and port are defined in DNS.
4. Verify that the directory has the default Oracle Context defined.

5. Use the `ldapsearch` utility or a directory administration tool to verify that the network service object exists in the Oracle Context at the location given by the value of the `DEFAULT_ADMIN_CONTEXT` parameter.

### 16.3.2.3 ORA-12154 Error When Using the Easy Connect Naming Method

Verify that the host name given is correct, and is defined in the local host name resolution service, such as local hosts file, DNS, and so on.

### 16.3.2.4 ORA-12154 Error When Using the External Naming Method

Perform the following steps when using the external naming method:

1. Verify that the NIS file for `tnsnames` map is properly set up.
2. Check that the network service name matches the `tnsnames` entry as described in "[ORA-12154 Error When Using the Local Naming Method](#)".

#### See Also:

- "[Example of Troubleshooting a TNS-12154 Error](#)" for additional information about troubleshooting the error
- "[Using Localized Management](#)" for configuration file location information
- [Configuring Naming Methods](#) for naming information

### 16.3.3 ORA-12170: Connect Timeout Occurred

This message indicates that the client failed to establish a connection and complete authentication in the time specified by the `SQLNET.INBOUND_CONNECT_TIMEOUT` parameter in the `sqlnet.ora` file. This error may be a result of network or system delays, or it may indicate that a malicious client is trying to cause a denial-of-service attack on the database server.

- If the error occurred due to system or network delays that are normal for the particular environment, then perform the following steps:
  1. Turn on tracing to determine which clients are timing out.

#### See Also:

["Tracing Error Information for Oracle Net Services"](#)

2. Reconfigure the `SQLNET.INBOUND_CONNECT_TIMEOUT`, `SQLNET.SEND_TIMEOUT`, or `SQLNET.RECV_TIMEOUT` parameters in the `sqlnet.ora` file to larger values.
- If you suspect a malicious client, then perform the following steps:
    1. Restrict access to the client. You can configure parameters for access rights in the `sqlnet.ora` file.

2. Locate the IP address of the client in the `sqlnet.log` file on the database server to identify the source. Keep in mind that an IP address can be forged.

For example, the following `sqlnet.log` excerpt shows a client IP address of 192.0.2.35.

```
Fatal NI connect error 12170.

VERSION INFORMATION:
TNS for Linux: Version 18.0.0.0.0
Oracle Bequeath NT Protocol Adapter for Linux: Version 18.0.0.0.0
TCP/IP NT Protocol Adapter for Linux: Version 18.0.0.0.0
Time: 03-JAN-2018 13:51:12
Tracing to file: /ora/trace/svr_13279.trc
Tns error struct:
  nr err code: 0
  ns main err code: 12637
  TNS-12637: Packet receive failed
  ns secondary err code: 12604
  nt main err code: 0
  nt secondary err code: 0
  nt OS err code: 0
Client address: (ADDRESS=(PROTOCOL=tcp)(HOST=192.0.2.35)(PORT=52996))
```

If the time out occurs before the IP address can be retrieved by the database server, then enable listener tracing to determine the client that made the request.

#### See Also:

- ["Limiting Resource Consumption by Unauthorized Users"](#) for additional information about setting the `SQLNET.INBOUND_CONNECT_TIMEOUT` parameter
- ["Settings for Database Access Control"](#)
- ["Tracing Error Information for Oracle Net Services"](#)

## 16.3.4 TNS-12500 or ORA-12500: Listener Failed to Start a Dedicated Server Process

These messages indicate that the listener failed to start the Oracle program. Possible reasons include:

- The maximum number of processes allowed for a single user was exceeded
- The listener does not have execute permission on the Oracle program
- The associated Microsoft Windows service is not started

In some cases, these errors can be caused by the same conditions which cause the following errors:

- TNS-12549 or ORA-12549
- TNS-00519

- TNS-12540 or ORA-12540
- TNS-00510
- TNS-12560 or ORA-12560

Perform the appropriate action:

- Increase the number of processes by setting the `PROCESSES` parameter in the database initialization file to a larger value.
- Check the `listener.log` file for detailed error stack information.

### 16.3.5 ORA-12514: Listener Does Not Currently Know of Service Requested in Connect Descriptor

This message indicates that the listener received a request to establish a connection to a database or other service. The connect descriptor received by the listener specified a service name for a service (usually a database service) that has either not yet dynamically registered with the listener or has not been statically configured for the listener. This may be a temporary condition such as after the listener has started, but before the database instance has registered with the listener.

Perform the following steps:

1. Wait a moment, and then try to connect a second time.
2. Check which services are currently known by the listener by running the Listener Control utility `STATUS` or `SERVICES` command.
3. Check that the `SERVICE_NAME` parameter in the connect descriptor specifies a service name known by the listener.
4. Check for an event in the `listener.log` file.

#### See Also:

- ["Determining the Current Status of a Listener" and "Monitoring Services of a Listener"](#)
- ["Analyzing Listener Log Files"](#)

### 16.3.6 ORA-12520: Listener Could Not Find Available Handler for Requested Type of Server

This message indicates that the type of service handler requested by the client is incorrect or not registered for the requested `SERVICE_NAME/INSTANCE_NAME` parameters, or the database instance is not registered with the listener.

If you suspect the problem is the wrong type of service handler, then perform the following steps:

1. If `(server=value)` is set in the connect descriptor, then ensure that the value is set to the appropriate service handler type for the database, that is, `dedicated` for dedicated server or `shared` for dispatchers. You can use the Listener Control utility

`SERVICES` command to see what service handlers are currently registered with the listener.

2. If the `USE_DEDICATED_SERVER` parameter is set to `ON` in the `sqlnet.ora` file, then ensure the database is configured to use dedicated servers. If it is not, then set this parameter to `OFF`.
3. Ensure that the database instance is running. If the instance not running, then start it so that it can register with the listener.



**See Also:**

"[Monitoring Services of a Listener](#)" for additional information about service handlers

## 16.3.7 ORA-12521: Listener Does Not Currently Know of Instance Requested in Connect Descriptor

This message indicates that the instance name in the connect descriptor is incorrect, or the database instance is not registered with the listener.

Perform the following steps:

1. Ensure the service name specified in the connect descriptor is correct.
2. Ensure the database instance is running. If the instance not running, then start it so that it can register with the listener. You can use the Listener Control utility `SERVICES` command to see what instances are currently registered with the listener.



**See Also:**

"[Monitoring Services of a Listener](#)" for additional information about `SERVICES` command

## 16.3.8 ORA-12525: Listener Has Not Received Client's Request in Time Allowed

This message indicates that the client failed to complete its connect request in the time specified by the `INBOUND_CONNECT_TIMEOUT_listener_name` parameter in the `listener.ora` file. This error may be a result of network or system delays, or it may indicate that a malicious client is trying to cause a denial-of-service attack on the listener.

- If the error occurred due to system or network delays that are normal for the particular environment, then reconfigure the `INBOUND_CONNECT_TIMEOUT_listener_name` parameter in `listener.ora` to a larger value.
- If you suspect a malicious client, then perform the following steps:

1. Locate the IP address of the client in the `listener.log` file to identify the source. Keep in mind that an IP address can be forged.

For example, the following `listener.log` file excerpt shows a client IP address of 192.0.2.35.

```
03-MAY-2012 16:42:35 * <unknown connect data> *
(ADDRESS=(PROTOCOL=tcp)(HOST=192.0.2.35)(PORT=53208)) * establish *
<unknown sid> * 12525
TNS-12525: TNS:listener has not received client's request in time
allowed
TNS-12604: TNS: Application timeout occurred
```

2. Restrict access to the client. You can configure parameters for access rights in the `sqlnet.ora` file.

#### See Also:

- "[Limiting Resource Consumption by Unauthorized Users](#)" for additional information about setting the `INBOUND_CONNECT_TIMEOUT_listener_name` parameter
- "[Settings for Database Access Control](#)"

## 16.3.9 ORA-12533: Illegal Address Parameters

This message indicates that the protocol specific parameters in the `ADDRESS` section of the designated connect descriptor are incorrect.

Correct the protocol address.

#### Note:

This error is often caused by hand-editing of the `tnsnames.ora` file. Only edit the `tnsnames.ora` file using Oracle Enterprise Manager Cloud Control or Oracle Net Manager.

#### See Also:

*Oracle Database Net Services Reference* for correct protocol syntax

## 16.3.10 TNS-12540 or ORA-12540: TNS:Internal Limit Restriction Exceeded and TNS-00510: Internal Limit Restriction Exceeded

These messages indicate that an internal limit has been exceeded. Possible limits include the following:

- Number of open connections that Oracle Net can process simultaneously
- Number of memory buffers that can be used simultaneously
- Number of processes a particular database instance is allowed

The first two are examples of hard limits. The third is an example of a limit which can be increased by setting PROCESSES parameter in the database initialization file to a larger value. In this case, a TNS-12500 or ORA-12500 error is also returned. In some cases, these errors can be caused by the same conditions which cause TNS-12549 or ORA-12549, and TNS-00519 errors.

Wait for the open connections to close and retry. If the error persists, then check the `sqlnet.log` or `listener.log` file for detailed error stack information.

### 16.3.11 TNS-12541 or ORA-12541: TNS:No Listener

These messages indicate that the connection request could not be completed because the listener is not running.

Perform the following actions:

- Ensure the supplied destination address matches one of the addresses used by the listener.
- Verify the listener is running at the address specified by the request.
- Ensure the listener is listening on the host and port specified by the request.
- Verify the client is pointing to the listener.

### 16.3.12 TNS-12549 or ORA-12549: TNS:Operating System Resource Quota Exceeded and TNS-00519: Operating System Resource Quota Exceeded

These messages indicate that a quota or hard limit imposed by the operating system has been exceeded.

Possible limits include:

- The maximum number of processes allowed for a single user
- The operating system is running low on paging space

Perform the appropriate action:

- Increase the number of processes by setting the PROCESSES parameter in the database initialization file to a larger value.
- Check the `sqlnet.log` or `listener.log` file for detailed error stack information, such as an operating system error code to help identify which quota has been exceeded.

### 16.3.13 TNS-12560 or ORA-12560: TNS:Protocol Adapter Error Occurred

These messages indicate that there was an error when using a particular protocol. This error may be due to incorrect configuration of an ADDRESS parameter or may



occur due to errors returned from the underlying protocol or operating system interface.

In some cases, these errors are caused by the same conditions which cause TNS-00510, TNS-00519, TNS-12540, ORA-12540, TNS-12549 or ORA-12549 errors.

These errors occur on Microsoft Windows systems only. Perform the following actions:

1. Select **Run** from the Microsoft Windows Start menu.
2. Enter `MSCONFIG` in the Open field.
3. Go to the Services tab.
4. Enable `OracleServicesid` if it is disabled.
5. Restart the computer.
6. Check that Oracle Services started.

### 16.3.14 Directory Naming Errors

Directory naming issues associated with connectivity errors for database service or network service name entries in a directory server require analysis of the data. You can analyze the data contained within a directory server with the `ldifwrite` command line tool. The `ldifwrite` tool is an Oracle Internet Directory tool.

The `ldifwrite` tool can be used to convert all or part of the information residing in a directory server to LDIF. The `ldifwrite` tool performs a subtree search, including all entries following the specified distinguished name (DN), including the DN itself.

The `ldifwrite` tool syntax is as follows:

```
ldifwrite -c net_service_name/database_service -b base_DN -f ldif_file
```

The following table lists `ldifwrite` tool arguments and descriptions for each.

**Table 16-8 Idifwrite Arguments**

Argument	Description
<code>-c net_service_name/database_service</code>	The network service name or database service name that connects to the directory server.
<code>-b base_DN</code>	The base of the subtree to be written out in LDIF format.
<code>-f ldif_file</code>	The output file name.

The following example writes all the directory naming entries under `dc=us,dc=example,dc=com` to the `output1.ldi` file:

```
ldifwrite -c ldap -b "dc=us,dc=example,dc=com" -f output.ldif
```

 **Note:**

Check the `ldap.ora` file to determine the `base_DN` value. It is the same as the `DEFAULT_ADMIN_CONTEXT` entry in the `ldap.ora` file.

## 16.4 Troubleshooting Suggestions for Oracle Net Services

The following suggestions may be useful when diagnosing network problems:

- Use the node or network address during configuration instead of the name of the server computer. This eliminates any internal lookup problems and make the connection slightly faster.
- If you are using TCP/IP addresses, then use the IP address rather than the host name. For example, change the `HOST=server_name` line in the `tnsnames.ora` file to the IP address, such as `HOST=192.0.2.5`.
- Perform a loopback test on the server as described in [Task 2, Perform a Loopback Test](#). If the test passes, then use FTP to send the `tnsnames.ora` and `sqlnet.ora` files to the client.
- Check the systems between the client and the server. If it is a wide area network (WAN), then identify any intermediate systems that may not work correctly. If all computers are fine, then the problem may be a timing issue.
- Verify whether there is a timing issue. Timing issues are associated with an `ORA-12535` error in the client log files.

To resolve a timing issue, try speeding up the connection by using exact addresses instead of names and increase the `INBOUND_CONNECT_TIMEOUT_listener_name` parameter in the `listener.ora` file. The default value for this parameter is 10 seconds.

- Determine which Oracle applications are failing. SQL\*Plus may work, but CASE tools may not. If you determine the problem is a data volume issue, then try to transfer a large (5 MB) file with the base connectivity.
- [Questions to Consider When Troubleshooting Oracle Net Services](#)

### 16.4.1 Questions to Consider When Troubleshooting Oracle Net Services

The following questions can help diagnose a problem:

- Do all computers have a problem, or is it just one?

If one computer works and another does not, and the same software (Oracle and third-party products) is installed on each computer, then, if possible, swap out the network cables to see if the problem occurs on the second client. If it does occur, then it indicates that the problem has something to do with the client/server connection and is not local to the client.

- What kind of connections exist between the client and the server, for example, X.25, ISDN, or leased line?

Sniffers and LAN analyzers are useful for locating intermittent connection failures, and detecting time outs and resent packets. You can also see which side is waiting for a response.

## 16.5 Example of Troubleshooting a TNS-12154 Error

This section offers some solutions for the TNS-12154 error. The TNS-12154 error is encountered when SQL\*Net cannot find the connect identifier specified for a connection in the `tnsnames.ora` file or other naming adapter.

Before attempting to resolve the problem, it may be helpful to print out or view the `tnsnames.ora` file and the `sqlnet.ora` file. Looking at these files at the same time is helpful because references are made to both.

In this example, the `tnsnames.ora` and `sqlnet.ora` files are located in the default network administration directory on the client system.

Be sure that the `tnsnames.ora` file and the `sqlnet.ora` file resemble the following examples.

[Example 16-1](#) shows an example of a `tnsnames.ora` file.

### Example 16-1 tnsnames.ora Sample

```
DEV1.WORLD =
  (DESCRIPTION =
    (ADDRESS =
      (PROTOCOL = TCP)
      (HOST = 192.0.2.56)
      (PORT = 1521)
    )
    (CONNECT_DATA =
      (SERVICE_NAME = sales.example.com)
    )
  )
```

[Example 16-2](#) shows an example of a `sqlnet.ora` file.

### Example 16-2 sqlnet.ora Sample

```
TRACE_LEVEL_CLIENT = OFF
SQLNET.AUTHENTICATION_SERVICES = (NONE)
NAMES.DIRECTORY_PATH = (TNSNAMES)
AUTOMATIC_IPC = OFF
```

The alias in [Example 16-1](#) is `DEV1.WORLD`. However, the `NAMES.DEFAULT_DOMAIN = WORLD` parameter does not exist in [Example 16-2](#). To fix this problem, add the `NAMES.DEFAULT_DOMAIN = WORLD` parameter anywhere in the `sqlnet.ora` file. Save the file, and try the connection again.

## 16.6 Logging Error Information for Oracle Net Services

All errors encountered by Oracle Net Services are appended to a log file for evaluation by a network or database administrator. The log file provides additional information for an administrator about on-screen error messages. The error stack in the log file shows the state of the software at various layers.

To ensure that all errors are recorded, logging cannot be disabled on clients or name servers. Furthermore, only an administrator may replace or erase log files. The log file for the listener includes audit trail information about every client connection request, and most listener control commands.

- [Oracle Net Error Stacks](#)
- [Oracle Net Services Log File Names](#)
- [Oracle Network Log File Segmentation](#)  
The maximum size and number of text log files can be configured for Oracle Network components such as Oracle Net Listener, Oracle Connection Manager, and Global Service Manager.
- [About the Logging Parameters](#)
- [Setting Logging Parameters in Configuration Files](#)
- [Setting Logging During Control Utilities Runtime](#)
- [Using Log Files](#)
- [Analyzing Listener Log Files](#)
- [Analyzing Oracle Connection Manager Logs](#)

## 16.6.1 Oracle Net Error Stacks

Log files provide information contained in an error stack. An error stack refers to the information that is produced by each layer in an Oracle communications stack as the result of a network error.

The error stack components are described in [Table 16-9](#).

**Table 16-9 Error Stack Components**

Error Stack Component	Description
NI	Network Interface. This layer provides a generic interface for Oracle clients, servers, or external processes to access Oracle Net functions. The NI layer handles the "break" and "reset" requests for a connection.
NS	Network Session (main and secondary layers). These layers receive requests from NI, and settle all generic computer-level connectivity issues, such as: <ul style="list-style-type: none"> <li>• The location of the server or destination (open, close functions).</li> <li>• Whether one or more protocols are involved in the connection (open, close functions).</li> <li>• How to handle interrupts between client and server based on the capabilities of each (send, receive functions).</li> </ul>
NA	Network Authentication. This layer negotiates authentication and encryption requirements.
NT	Network Transport (main, secondary, and operating system layers). These layers map Oracle Net foundation layer functionality to industry-standard protocols.

- [Understanding Error Stack Messages](#)

### 16.6.1.1 Understanding Error Stack Messages

Suppose that a user of a client application tries to establish a connection with a database server using Oracle Net and TCP/IP, by entering the following commands:

```
SQLPLUS scott@example.com
Enter password: password
```

When the commands are entered, the following error displays:

```
ORA-12543: TNS:Unable to connect to destination
```

This message indicates that the connection to the server failed because the database could not be contacted. Although the application displays only a one-line error message, an error stack that is much more informative is recorded in the log file by the network layer.

On the client side, the `sqlnet.log` file as shown in [Example 16-3](#) contains an error stack corresponding to the ORA-12543 error.

### Example 16-3 sqlnet.log File

```
Fatal OSN connect error 12543, connecting to:
  (DESCRIPTION=(CONNECT_DATA=(SID=trace)(CID=(PROGRAM=)
    (HOST=lala)(USER=scott)))(ADDRESS_LIST=(ADDRESS=
    (PROTOCOL=ipc)(KEY=trace))(ADDRESS=(PROTOCOL=tcp)
    (HOST=lala)(PORT=1521))))

VERSION INFORMATION:
TNS for Linux:
Oracle Bequeath NT Protocol Adapter for Linux:
Unix Domain Socket IPC NT Protocol Adaptor for Linux:
TCP/IP NT Protocol Adapter for Linux:
  Tracing to file: /home/db_tracefiles/trace_admin.trc
  Tns error struct:
    TNS-12543: TNS:unable to connect to destination
    ns main err code: 12541
    TNS-12541: TNS:no listener
    ns secondary err code: 12560
    nt main err code: 511
    TNS-00511: No listener
    nt secondary err code: 61
    nt OS err code: 0
```

## 16.6.2 Oracle Net Services Log File Names

Each Oracle Net Services component produces its own log file. When using ADR, the default, the log file names are `log.xml` in the appropriate alert directory. [Table 16-10](#) lists the default log file names and lists the components that generate the log files that appear in the `ADR/diag/instance_name/trace` directory.

**Table 16-10 Log File Names When Using ADR**

Component	Log File
Listener	<code>listener.log</code>
Client or database server	<code>sqlnet.log</code>
Oracle Connection Manager listener	<code>instance-name_pid.log</code>
Oracle Connection Manager CMGW (Oracle Connection Manager Gateway) process	<code>instance-name_cmgw_pid.log</code>

**Table 16-10 (Cont.) Log File Names When Using ADR**

Component	Log File
Oracle Connection Manager CMADMIN (Oracle Connection Manager Administration) process	instance-name_cmadmin_pid.log
Oracle Connection Manager alert log	instance-name_alert.log

### 16.6.3 Oracle Network Log File Segmentation

The maximum size and number of text log files can be configured for Oracle Network components such as Oracle Net Listener, Oracle Connection Manager, and Global Service Manager.

The maximum size and number of text log files can be configured for Oracle Network components such as Oracle Net Listener, Oracle Connection Manager, and Global Service Manager. This feature allows better management of log files, particularly in Cloud environments. This is an ADR only feature and applicable to both text and XML log files.

### 16.6.4 About the Logging Parameters

Parameters that control logging, including the type and amount of information logged, and the location where the files are stored, are set in the configuration file of each network component as described in [Table 16-11](#).

**Table 16-11 Location of Log Parameters**

Network Component	Configuration File
Oracle Connection Manager processes	cman.ora
Listener	listener.ora
Client	sqlnet.ora
Database server	sqlnet.ora

 **Note:**

If the ADR\_ENABLED parameter is set to ON, then all logging parameters are set by ADR. Using Oracle Net Manager to change the parameters will not work.

This section contains the following topics:

- [sqlnet.ora Log Parameters](#)
- [listener.ora Log Parameters](#)

- [cman.ora Log Parameters](#)



**See Also:**

*Oracle Database Net Services Reference* for additional information about the parameters

### 16.6.4.1 sqlnet.ora Log Parameters

[Table 16-12](#) describes the log parameters settings that can be set in the `sqlnet.ora` file.

**Table 16-12** sqlnet.ora Log Parameters

sqlnet.ora Parameter	Oracle Net Manager Field	Description
ADR_BASE	You must set this parameter manually.	The ADR_BASE parameter specifies the base directory for storing tracing and logging incidents. Use this parameter when DIAG_ADR_ENABLED is set to ON.
DIAG_ADR_ENABLED	You must set this parameter manually.	The DIAG_ADR_ENABLED parameter indicates whether ADR tracing is enabled. When the DIAG_ADR_ENABLED parameter is set to OFF, non-ADR file tracing is used.
LOG_DIRECTORY_CLIENT	Client Information: Log Directory	The destination directory for the client log file. By default, the client directory is the current working directory. This parameter is disabled when ADR_ENABLED is set to ON.
LOG_DIRECTORY_SERVER	Server Information: Log Directory	The destination directory for the database server log files. By default the server directory is ORACLE_HOME/network/log. This parameter is disabled when ADR_ENABLED is set to ON.
LOG_FILE_CLIENT	Client Information: Log File	The name of the log file for the client. By default the log name is <code>sqlnet.log</code> .
LOG_FILE_SERVER	You must set this parameter manually.	The name of the log file for the database server. By default the log name is <code>sqlnet.log</code> .

### 16.6.4.2 listener.ora Log Parameters

[Table 16-13](#) describes the log parameters settings that can be set in the `listener.ora` file.

**Table 16-13** listener.ora Log Parameters

listener.ora Parameter	Oracle Net Manager Field	Description
ADR_BASE_listener_name	You must set this parameter manually.	The ADR_BASE_listener_name parameter specifies the base directory for storing which tracing and logging incidents. Use when DIAG_ADR_ENABLED_listener_name is set to ON.

**Table 16-13 (Cont.) listener.ora Log Parameters**

listener.ora Parameter	Oracle Net Manager Field	Description
DIAG_ADR_ENABLED_listener_name	You must set this parameter manually.	The DIAG_ADR_ENABLED_listener_name parameter indicates whether ADR tracing is enabled.  When DIAG_ADR_ENABLED_listener_name is set to OFF, non-ADR file tracing is used.
LOG_DIRECTORY_listener_name LOG_FILE_listener_name	Log File	The destination directory and file for the log file that is automatically generated for listener events. By default the directory is ORACLE_HOME/network/log, and the file name is listener.log. These parameters are disabled when ADR_ENABLED is set to ON.

### 16.6.4.3 cman.ora Log Parameters

Table 16-14 describes the log parameters settings that can be set in the cman.ora file.

**Table 16-14 cman.ora Log Parameters**

cman.ora Parameter	Description
ADR_BASE	The ADR_BASE parameter specifies the base directory for storing tracing and logging incidents.  Use this parameter when DIAG_ADR_ENABLED is set to ON.
DIAG_ADR_ENABLED	The DIAG_ADR_ENABLED parameter indicates whether ADR tracing is enabled.  When the DIAG_ADR_ENABLED parameter is set to OFF, non-ADR file tracing is used.
EVENT_GROUP	The event groups that are logged. Multiple events may be designated using a comma-delimited list. This parameter accepts the following values: <ul style="list-style-type: none"> <li>• INIT_AND_TERM: initialization and termination</li> <li>• MEMORY_OPS: memory operations</li> <li>• CONN_HDLG: connection handling</li> <li>• PROC_MGMT: process management</li> <li>• REG_AND_LOAD: registration and load update</li> <li>• WAKE_UP: events related to CMADMIN wakeup queue</li> <li>• TIMER: gateway timeouts</li> <li>• CMD_PROC: command processing</li> <li>• RELAY: events associated with connection control blocks</li> </ul>
LOG_DIRECTORY	The destination directory for log files.  By default, the directory is ORACLE_HOME/network/log.  This parameter is disabled when ADR_ENABLED is set to ON.



**Table 16-14 (Cont.) cman.ora Log Parameters**

cman.ora Parameter	Description
LOG_LEVEL	The level of logging. Four levels are supported: <ul style="list-style-type: none"> <li>• off (default): no logging</li> <li>• user: user log information</li> <li>• admin: administrative log information</li> <li>• support: Oracle Support Services information</li> </ul>

## 16.6.5 Setting Logging Parameters in Configuration Files

You configure logging parameters for the `sqlnet.ora` file with Oracle Net Manager and for the `listener.ora` file with either Oracle Enterprise Manager Cloud Control or Oracle Net Manager. You must manually configure `cman.ora` file logging parameters.

- [Setting Parameters for the sqlnet.ora File Using Oracle Net Manager](#)
- [Setting Parameters for the listener.ora File Using Oracle Enterprise Manager Cloud Control](#)
- [Setting Parameters for the listener.ora File Using Oracle Net Manager](#)

### 16.6.5.1 Setting Parameters for the sqlnet.ora File Using Oracle Net Manager

The following procedure describes how to set the logging parameters in the `sqlnet.ora` file.

1. Start Oracle Net Manager.



#### See Also:

["Using Oracle Net Manager to Configure Oracle Net Services"](#)

2. In the navigator pane, expand **Profile** under the Local heading.
3. From the list in the right pane, select **General**.
4. Click the **Logging** tab.
5. Specify the settings.
6. Choose **Save Network Configuration** from the File menu.

The name of the log file is `sqlnet.log`.

### 16.6.5.2 Setting Parameters for the listener.ora File Using Oracle Enterprise Manager Cloud Control

The following procedure describes how to set the logging parameters in the `listener.ora` file using Oracle Enterprise Manager Cloud Control:

1. Access the Net Services Administration page in Oracle Enterprise Manager Cloud Control.



**See Also:**

["Using Oracle Enterprise Manager Cloud Control to Configure Oracle Net Services"](#)

2. Select **Listeners** from the Administer list, and then select the Oracle home that contains the location of the configuration files.
3. Click **Go** to display the Listeners page.
4. Select a listener, and then click **Edit** to display the Edit Listeners page.
5. Click the **Logging & Tracing** tab.
6. Specify the settings.
7. Click **OK**.

The name of the log file is `listener.log`.

### 16.6.5.3 Setting Parameters for the listener.ora File Using Oracle Net Manager

The following procedure describes how to set the logging parameters in the `listener.ora` file using Oracle Net Manager:

1. Start Oracle Net Manager.



**See Also:**

["Using Oracle Net Manager to Configure Oracle Net Services"](#)

2. In the navigator pane, expand **Listeners** under the Local heading.
3. Select a listener.
4. From the list in the right pane, select **General**.
5. Click the **Logging and Tracing** tab.
6. Specify the settings.
7. Choose **Save Network Configuration** from the File menu.

The name of the log file is `listener.log`.



**See Also:**

*Oracle Database Net Services Reference*

### 16.6.6 Setting Logging During Control Utilities Runtime

You can set logging during control utility runtime. Setting logging with a control utility does not set parameters in the `*.ora` files, and the setting is only valid for the control utility session.

The following settings can be set for a control utility:

- For a listener, use the `SET LOG_FILE` and `SET LOG_DIRECTORY` commands from the Listener Control utility.
- For an Oracle Connection Manager, use the `SET LOG_DIRECTORY`, `SET LOG_LEVEL`, and `SET EVENT` commands from the Oracle Connection Manager control utility.

 **Note:**

If the `ADR_ENABLED` parameter is set to `ON`, then all logging parameters are set by ADR. Using Oracle Connection Manager to change the parameters will not work.

 **See Also:**

*Oracle Database Net Services Reference*

## 16.6.7 Using Log Files

The following procedure describes how to use a log file to diagnose a network error:

1. Review the log file for the most recent error number received from the application. This is usually the last entry in the log file.
2. Starting from the bottom of the file, locate the first nonzero entry in the error report. This is usually the actual cause.
3. If that error does not provide the information, then review the next error in the log until you locate the correct error information.
4. If the cause of the error is still not clear, then turn on tracing and repeat the command that produced the error message.

## 16.6.8 Analyzing Listener Log Files

This section describes what is recorded in the listener log file.

- [Listener Log Audit Trail Information](#)
- [Listener Service Registration Event Information](#)
- [Listener Direct Hand-Off Information](#)
- [Listener Subscription for ONS Node Down Event Information](#)
- [Listener Oracle Clusterware Notification Information](#)

### 16.6.8.1 Listener Log Audit Trail Information

The listener log file contains audit trail information that enables you to collect and analyze network usage statistics, as well as information indicating the following:

- A client connection request
- A RELOAD, START, STOP, STATUS, or SERVICES command issued by the Listener Control utility

You can use the audit trail information to view trends and user activity by first storing it in a table and then collating it in a report format. To import the data into a table, use an import utility such as SQL\*Loader.

- [Format of the Listener Log Audit Trail](#)

### 16.6.8.1.1 Format of the Listener Log Audit Trail

The audit trail formats text into the following fields:

```
Timestamp * Connect Data [* Protocol Info] * Event [* SID | Service] * Return Code
```

Properties of the audit trail are as follows:

- Each field is delimited by an asterisk (\*).
- Protocol address information and service name or SID information appear only when a connection is attempted.
- A successful connection or command returns a code of zero.
- A failure produces a code that maps to an error message.

[Example 16-4](#) shows a log file excerpt with RELOAD command request.

#### Example 16-4 Listener Log Event for Successful RELOAD Request

```
14-MAY-2012 00:29:54 *
(connect_data=(cid=(program=)(host=sales-server)(user=jdoe))(command=reload)
(arguments=64)(service=listener)(version=135290880))
* reload * 0
```

[Example 16-5](#) shows a log file excerpt with a successful connection request.

#### Example 16-5 Listener Log Events for a Successful Connection Request

```
14-MAY-2012 15:28:58 *
(connect_data=(service_name=sales.us.example.com)(cid=(program=)(host=sales-server)
(user=jdoe)))
* (address=(protocol=tcp)(host=192.0.2.35)(port=41349)) * establish
* sales.us.example.com * 0
```

[Example 16-6](#) shows a log file excerpt with a successful execution of the STATUS command by host sales-server. It is followed by an unsuccessful connection attempt by a client with an IP address of 192.0.2.35. This connection attempt resulted in an [ORA-12525: Listener Has Not Received Client's Request in Time Allowed](#) error message. This error occurs when a client fails to complete its connection request in the time specified by the INBOUND\_CONNECT\_TIMEOUT\_listener\_name parameter in the listener.ora file. This client could be attempting a denial-of-service attack on the listener.

#### Example 16-6 Listener Log Events for an Unsuccessful Connection Request

```
03-MAY-2012 16:41:57 *
(CONNECT_DATA=(CID=(PROGRAM=)(HOST=sales-server)(USER=jdoe))(COMMAND=status)
(ARGUMENTS=64)(SERVICE=LISTENER)(VERSION=153092352)) * status * 0
03-MAY-2012 16:42:35 * <unknown connect data> *
```

```
(ADDRESS=(PROTOCOL=tcp)(HOST=192.0.2.35)(PORT=53208)) * establish *
<unknown sid> * 12525
TNS-12525: TNS:listener has not received client's request in time allowed
TNS-12604: TNS: Application timeout occurred
```



**See Also:**

*Oracle Database Error Messages* for a complete listing of error messages

## 16.6.8.2 Listener Service Registration Event Information

The listener records service registration events. During service registration, the Listener Registration (LREG) process provides the listener with information about the following:

- Service names for each running instance of the database
- Instance names of the database
- Service handlers (dispatchers or dedicated servers) available
- Dispatcher, instance, and node load information
- Dynamic listening endpoints

The recorded service registration-related events mentioned in the following table are listed in the `listener.log` file:

**Table 16-15 Service Registration Event Log Information**

Event	Description
service_register	The listener received registration information for an instance.
service_update	The listener received updated registration information for a particular instance, such as dispatcher or instance load information.
service_died	The listener lost its connection to Listener Registration (LREG). All registration information for the instance is discarded. Clients are unable to connect to the instance until LREG registers it again.

- [Format of the Listener Service Registration Information](#)

### 16.6.8.2.1 Format of the Listener Service Registration Information

The service registration events are formatted into the following fields:

```
Timestamp * Event * Instance Name * Return Code
```

Properties of service registration fields are as follows:

- Each field is delimited by an asterisk (\*).
- It is normal for the events to appear multiple times in a row for one instance.

- A successful registration returns a code of zero, meaning the client can connect to the instance.
- A failure produces a code that maps to an error message.

**Example 16-7** shows a log file with service registration events. The listener is able to receive a client request after a successful `service_register` event, but is unable to receive client requests after a `service_died` event.

### Example 16-7 Listener Log with Service Registration Events

```
-----
14-MAY-2012 15:28:43 * service_register * sales * 0
14-MAY-2012 15:28:43 * service_register * sales * 0
14-MAY-2012 15:28:58 *
(connect_data=(service_name=sales.us.example.com)
(cid=(program=)(host=sales-server)(user=jdoe)))
* (address=(protocol=tcp)(host=192.0.2.35)(port=41349)) * establish
* sales.us.example.com * 0
14-MAY-2012 15:38:44 * service_update * sales * 0
14-MAY-2012 15:38:44 * service_update * sales * 0
14-MAY-2012 15:48:45 * service_update * sales * 0
14-MAY-2012 15:48:45 * service_update * sales * 0
14-MAY-2012 15:50:57 *
(connect_data=(service_name=sales.us.example.com)(cid=(program=)
(host=sales-server)(user=jdoe)))
* (address=(protocol=tcp)(host=192.0.2.35)(port=41365)) * establish
* sales.us.example.com * 0
14-MAY-2012 15:51:26 * service_died * sales * 12537
14-MAY-2012 15:51:26 * service_died * sales * 12537
14-MAY-2012 15:52:06 *
(connect_data=(service_name=sales.us.example.com)
(cid=(program=)(host=sales-server)(user=jdoe)))
* (address=(protocol=tcp)(host=192.0.2.35)(port=41406)) * establish
* sales.us.example.com * 12514
TNS-12514: TNS:listener could not resolve SERVICE_NAME given in connect descriptor
-----
```

#### See Also:

*Oracle Database Error Messages* for a complete listing of error messages

### 16.6.8.3 Listener Direct Hand-Off Information

The listener records direct hand-off events to dispatchers. These events are formatted into the following fields:

```
Timestamp * Presentation * Handoff * Error Code
```

Properties of direct hand-off fields are as follows:

- Each field is delimited by an asterisk (\*).
- A successful connection or command returns a code of zero.
- A failure produces a code that maps to an error message.

The following example shows a direct hand-off event in the log file.

**Example 16-8 Listener Log Event for Direct Hand-Off**

```
21-MAY-2012 10:54:55 * oracle.aurora.net.SALESHttp2 * handoff * 0
```

#### 16.6.8.4 Listener Subscription for ONS Node Down Event Information

The listener subscribes to the Oracle Notification Service (ONS) node down event on startup if the ONS configuration file is available. This subscription enables the listener to remove the affected service when it receives node down event notification from ONS. The listener uses asynchronous subscription for the event notification.

The following warning message is recorded to the listener log file on each `STATUS` command if the subscription has not completed, such as the ONS daemon is not running on the host.

```
WARNING: Subscription for node down event still pending
```

The listener cannot receive the ONS event while subscription is pending. Other than that, no other listener functionality is affected.

#### 16.6.8.5 Listener Oracle Clusterware Notification Information

If the required Oracle Clusterware (shown as CRS in the following log messages) libraries are installed and Oracle Clusterware is started on the host, then Oracle Listener will notify Oracle Clusterware about its status during start and stop processes. After successful notification, listeners record the event in the log. No message is recorded if the notification fails.

```
Listener completed notification to CRS on start  
Listener completed notification to CRS on stop
```

#### 16.6.9 Analyzing Oracle Connection Manager Logs

Oracle Connection Manager generates four types of log files, one each for its listener, gateway, CMADMIN processes, and alerts. The alert log file is a chronological record of all critical errors. In addition to logging critical errors, the alert log captures information about instance startup and shutdown. It also records the value of all configuration parameters at the beginning and end of a session.

[Example 16-9](#) and [Example 16-10](#) are representative of the CMADMIN and gateway log files. [Table 16-16](#) explains log entries. Each entry consists of a timestamp and an event. You can configure the `cmn.ora` file to log events for the following categories:

- Initialization and termination
- Memory operations
- Connection handling
- Process management
- Registration and load update
- Events related to CMADMIN wakeup queue
- Gateway timeouts
- Command processing
- Events associated with connection control blocks

Use the SET EVENT command to specify which events to log.

Example 16-9 shows a typical CMADMIN log.

### Example 16-9 CMADMIN Log File

```

-----
(LOG_RECORD=(TIMESTAMP=08-MAY-2012 08:46:40)(EVENT=Parameter list)
(listener_address=(address=(protocol=tcp)(host=sales1)(port=1574)))
(aso_authentication_filter=OFF)
(connection_statistics=ON)
(log_directory=/home/user/network/admin/log)
(log_level=support)
(max_connections=256)
(idle_timeout=5)
(inbound_connect_timeout=0)
(session_timeout=20)
(outbound_connect_timeout=0)
(max_gateway_processes=1)
(min_gateway_processes=1)
(password=OFF)
(trace_directory=/home/user/network/admin/log)
(trace_level=off)
(trace_timestamp=OFF)
(trace_filelen=0)
(trace_fileno=0)
)
(LOG_RECORD=(TIMESTAMP=08-MAY-2012 08:46:40)(EVENT=Shared Memory Size)
(BYTES=82524))
(LOG_RECORD=(TIMESTAMP=08-MAY-2012 08:46:40)(EVENT=GMON Attributes validated)
(Type=Information))
(LOG_RECORD=(TIMESTAMP=08-MAY-2012 08:46:40)(EVENT=NS Listen Successful)
((ADDRESS=(PROTOCOL=tcp)(HOST=usunnae16)(PORT=55878))))
(LOG_RECORD=(TIMESTAMP=08-MAY-2012 08:46:44)(EVENT=Received command)(CMD=verify
password))
(LOG_RECORD=(TIMESTAMP=08-MAY-2012 08:46:44)(EVENT=Received command)
(CMD=version))
(LOG_RECORD=(TIMESTAMP=08-MAY-2012 08:46:44)(EVENT=Received command)
(CMD=show status))
(LOG_RECORD=(TIMESTAMP=08-MAY-2012 08:46:44)(EVENT=Failed to get procedure id))
(LOG_RECORD=(TIMESTAMP=08-MAY-2012 08:49:12)(EVENT=Received command)(CMD=verify
password))
(LOG_RECORD=(TIMESTAMP=08-MAY-2012 08:49:15)(EVENT=Failed to get procedure id))
(LOG_RECORD=(TIMESTAMP=08-MAY-2012 08:49:29)(EVENT=Received command)(CMD=verify
password))
(LOG_RECORD=(TIMESTAMP=08-MAY-2012 08:49:46)(EVENT=Failed to get procedure id))
(LOG_RECORD=(TIMESTAMP=08-MAY-2012 08:49:50)(EVENT=Received command)(CMD=verify
password))
(LOG_RECORD=(TIMESTAMP=08-MAY-2012 08:49:50)(EVENT=Received command)
(CMD=probe monitor))
(LOG_RECORD=(TIMESTAMP=08-MAY-2012 08:49:50)(EVENT=Received command)
(CMD=shutdown normal))
-----

```

Example 16-10 shows a typical gateway log file.

### Example 16-10 Gateway Log File

```

-----
(LOG_RECORD=(TIMESTAMP=08-MAY-2012 08:46:41)(EVENT=NS Initialised))
(LOG_RECORD=(TIMESTAMP=08-MAY-2012 08:46:41)(EVENT=Memory Allocated)
(BYTES=1024))

```



```
(LOG_RECORD=(TIMESTAMP=08-MAY-2012 08:46:41)(EVENT=NCR Initialised))
(LOG_RECORD=(TIMESTAMP=08-MAY-2012 08:46:41)(EVENT=Connected to Monitor))
(LOG_RECORD=(TIMESTAMP=08-MAY-2012 08:46:41)(EVENT=State Change from Empty to
Init))
(LOG_RECORD=(TIMESTAMP=08-MAY-2012 08:46:41)(EVENT=Memory Allocated)
(BYTES=251904))
(LOG_RECORD=(TIMESTAMP=08-MAY-2012 08:46:41)(EVENT=Memory Allocated)
(BYTES=2048))
(LOG_RECORD=(TIMESTAMP=08-MAY-2012 08:46:41)(EVENT=CCB Initialised))
(LOG_RECORD=(TIMESTAMP=08-MAY-2012 08:46:41)(EVENT=Started Listening))
(LOG_RECORD=(TIMESTAMP=08-MAY-2012 08:46:41)(EVENT=State Change from Init to
Ready))
(LOG_RECORD=(TIMESTAMP=08-MAY-2012 08:46:47)(EVENT=Housekeeping))
(LOG_RECORD=(TIMESTAMP=08-MAY-2012 08:48:06)(EVENT=Ready)(CONN NO=0))
(LOG_RECORD=(TIMESTAMP=08-MAY-2012 08:48:06)(EVENT=Ready)(CONN NO=0))
(LOG_RECORD=(TIMESTAMP=08-MAY-2012 08:48:07)(EVENT=Housekeeping))
(LOG_RECORD=(TIMESTAMP=08-MAY-2012 08:48:12)(EVENT=Housekeeping))
(LOG_RECORD=(TIMESTAMP=08-MAY-2012 08:48:13)(EVENT=Idle Timeout)(CONN NO=0))
(LOG_RECORD=(TIMESTAMP=08-MAY-2012 08:48:17)(EVENT=Housekeeping))
(LOG_RECORD=(TIMESTAMP=08-MAY-2012 08:48:22)(EVENT=Housekeeping))
(LOG_RECORD=(TIMESTAMP=08-MAY-2012 08:48:25)(EVENT=Ready)(CONN NO=0))
(LOG_RECORD=(TIMESTAMP=08-MAY-2012 08:48:25)(EVENT=Ready)(CONN NO=0))
(LOG_RECORD=(TIMESTAMP=08-MAY-2012 08:48:27)(EVENT=Housekeeping))
(LOG_RECORD=(TIMESTAMP=08-MAY-2012 08:48:30)(EVENT=Idle Timeout)(CONN NO=0))
(LOG_RECORD=(TIMESTAMP=08-MAY-2012 08:48:32)(EVENT=Housekeeping))
(LOG_RECORD=(TIMESTAMP=08-MAY-2012 08:48:37)(EVENT=Housekeeping))
(LOG_RECORD=(TIMESTAMP=08-MAY-2012 08:48:42)(EVENT=Ready)(CONN NO=0))
(LOG_RECORD=(TIMESTAMP=08-MAY-2012 08:48:42)(EVENT=Ready)(CONN NO=0))
(LOG_RECORD=(TIMESTAMP=08-MAY-2012 08:48:42)(EVENT=Housekeeping))
(LOG_RECORD=(TIMESTAMP=08-MAY-2012 08:48:47)(EVENT=Housekeeping))
(LOG_RECORD=(TIMESTAMP=08-MAY-2012 08:48:52)(EVENT=Housekeeping))
(LOG_RECORD=(TIMESTAMP=08-MAY-2012 08:48:57)(EVENT=Housekeeping))
(LOG_RECORD=(TIMESTAMP=08-MAY-2012 08:49:02)(EVENT=Session Timeout)(CONN NO=0))
(LOG_RECORD=(TIMESTAMP=08-MAY-2012 08:49:02)(EVENT=Housekeeping))
-----
```

Table 16-16 shows the log file entries and their descriptions.

**Table 16-16 CMADMIN and Gateway Log Entries**

Log File	Event	Description
CMADMIN	Failed to get procedure ID	The CMCTL session connected to CMADMIN has disconnected.
CMADMIN	GMON Attributes validated	Informational message. The parameters needed for CMADMIN to come up are specified correctly.
CMADMIN	Invalid connect data	An unknown client is trying to connect to CMADMIN. This is most likely a denial of service attack.
CMADMIN	No connect data	An unknown client is trying to connect to CMADMIN. This is most likely a denial of service attack.
Gateway	Connected to Monitor	The gateway has connected to CMADMIN.
Gateway	Housekeeping	Informational message. Internal housekeeping for the gateway process is in order. The gateway process is properly connected to the CMADMIN process.

**Table 16-16 (Cont.) CMADMIN and Gateway Log Entries**

Log File	Event	Description
Gateway	Idle Timeout	The connection was disconnected because it was idle longer than the time specified in the <code>cman.ora</code> file.
Gateway	Out of connection control block (CCB)	CMADMIN cannot process a connection request. There could be two reasons: <ul style="list-style-type: none"> <li>Faulty load update between CMADMIN and listener.</li> <li>Someone is trying to connect to CMADMIN directly (possibly a denial of service attack).</li> </ul>
Gateway	Session Timeout	The connection was disconnected because it exceeded the session timeout specified in the <code>cman.ora</code> file.
Gateway	State change from Empty to Init	State change message from the gateway. After it reaches init state, the gateway begins some internal data initialization.
Gateway	State change from Init to Ready	State change message from the gateway. After it reaches a ready state, the gateway begins accepting connections from the client.

## 16.7 Tracing Error Information for Oracle Net Services

Tracing produces a detailed sequence of statements that describe network events as they are run. Tracing an operation enables you to obtain more information about the internal operations of the components of Oracle Net Services than is provided in a log file. This information is output to files that can be evaluated to identify the events that led to an error.

### Note:

Tracing uses a large amount of disk space and may have a significant impact upon system performance. Therefore, you should enable tracing only when necessary.

This section contains the following topics:

- [Understanding Oracle Net Services Trace File Names](#)
- [Setting Tracing Parameters](#)
- [Setting Tracing During Control Utilities Runtime](#)
- [Evaluating Oracle Net Services Trace Files](#)
- [Using the Trace Assistant to Examine Trace Files](#)

## 16.7.1 Understanding Oracle Net Services Trace File Names

Each Oracle Net Services component produces its own trace file. [Table 16-17](#) provides the default trace file names and lists the components that generate the trace files.

**Table 16-17 Trace Files Names**

Trace File	Component
instance-name_pid.trc	Oracle Connection Manager listener
instance-name_cm gw_pid.trc	Oracle Connection Manager CMGW process
instance-name_cmadmin_pid.trc	Oracle Connection Manager CMADMIN process
listener.trc	Listener
sqlnet.trc	Client
svr_pid.trc	Database server
tnsping.trc	TNSPING utility

## 16.7.2 Setting Tracing Parameters

Parameters that control tracing, including the type and amount of information trace, and the location where the files are stored, are set in the configuration file of each network component as described in [Table 16-18](#).

**Table 16-18 Location of Trace Parameters**

Configuration File	Component
cman.ora	Oracle Connection Manager processes
listener.ora	Listener
sqlnet.ora	Client
	Database server
	TNSPING utility

This section contains the following topics:

- [cman.ora Trace Parameters](#)
- [listener.ora Trace Parameters](#)
- [sqlnet.ora Trace Parameters](#)
- [Setting Tracing Parameters in Configuration Files](#)

### See Also:

*Oracle Database Net Services Reference* for additional information about these parameters

## 16.7.2.1 cman.ora Trace Parameters

Table 16-19 describes the trace parameters settings for Oracle Connection Manager that can be set in the `cman.ora` file.

**Table 16-19 cman.ora Trace Parameters**

cman.ora Parameter	Description
TRACE_DIRECTORY	The destination directory for trace files. By default, the directory is <code>ORACLE_HOME/network/trace</code> .
TRACE_FILELEN	The size of the trace file in KB. When the size is reached, the trace information is written to the next file. The number of files is specified with the <code>TRACE_FILENO</code> parameter.
TRACE_FILENO	The number of trace files for tracing. When this parameter is set along with the <code>TRACE_FILELEN</code> parameter, trace files are used in a cyclical fashion. The first file is filled, then the second file, and so on. When the last file has been filled, the first file is reused, and so on.  The trace file names are distinguished from one another by their sequence number. For example, if this parameter is set to 3, then the Oracle Connection Manager trace files for the gateway processes would be named <code>instance-name_cmgw1_pid.trc</code> , <code>instance-name_cmgw2_pid.trc</code> and <code>instance-name_cmgw3_pid.trc</code> .  In addition, trace events in the trace files are preceded by the sequence number of the file.
TRACE_LEVEL	The level of detail the trace facility records for the listener. The trace level value can either be a value within the range of 0 (zero) to 16 where 0 is no tracing and 16 represents the maximum amount of tracing or one of the following values: <ul style="list-style-type: none"> <li>• <code>off</code> (equivalent to 0) provides no tracing.</li> <li>• <code>user</code> (equivalent to 4) traces to identify user-induced error conditions.</li> <li>• <code>admin</code> (equivalent to 6) traces to identify installation-specific problems.</li> <li>• <code>support</code> (equivalent to 16) provides trace information for troubleshooting by Oracle Support Services.</li> </ul> The Oracle Connection Manager listener, gateway, and CMADMIN processes create trace files on both Linux and Microsoft Windows.
TRACE_TIMESTAMP	If the <code>TRACING</code> parameter is enabled, then a time stamp in the form of <code>dd-mon-yyyy hh:mi:ss:mi1</code> is created for every trace event in the listener trace file.

## 16.7.2.2 listener.ora Trace Parameters

Table 16-20 describes the trace parameters settings for the listener that can be set in the `listener.ora` file.

**Table 16-20 listener.ora Trace Parameters**

<b>listener.ora Parameter</b>	<b>Oracle Enterprise Manager Cloud Control/Oracle Net Manager Field</b>	<b>Description</b>
<code>TRACE_LEVEL_listener_name</code>	Select a trace level/Trace Level	The level of detail the trace facility records for the listener. The trace level value can either be a value within the range of 0 (zero) to 16 where 0 is no tracing and 16 represents the maximum amount of tracing or one of the following values: <ul style="list-style-type: none"> <li>• <code>off</code> (equivalent to 0) provides no tracing.</li> <li>• <code>user</code> (equivalent to 4) traces to identify user-induced error conditions.</li> <li>• <code>admin</code> (equivalent to 6) traces to identify installation-specific problems.</li> <li>• <code>support</code> (equivalent to 16) provides trace information for troubleshooting by Oracle Support Services.</li> </ul>
<code>TRACE_DIRECTORY_listener_name</code> <code>TRACE_FILE_listener_name</code>	Trace File	The destination directory and file for the trace file. By default, the directory is <code>ORACLE_HOME/network/trace</code> , and the file name is <code>listener.trc</code> .
<code>TRACE_FILEAGE_listener_name</code>	You must set this parameter manually.	The maximum age of listener trace files in minutes. When the age limit is reached, the trace information is written to the next file. The number of files is specified with the <code>TRACE_FILENO_listener_name</code> parameter.
<code>TRACE_FILEAGE_SERVER</code>	You must set this parameter manually.	Specifies the maximum age of server trace files in minutes. When the age limit is reached, the trace information is written to the next file. The number of files is specified with the <code>TRACE_FILENO_SERVER</code> parameter.
<code>TRACE_FILELEN_listener_name</code>	You must set this parameter manually.	The size of the listener trace files in KB. When the size is reached, the trace information is written to the next file. The number of files is specified with the <code>TRACE_FILENO_listener_name</code> parameter

**Table 16-20 (Cont.) listener.ora Trace Parameters**

listener.ora Parameter	Oracle Enterprise Manager Cloud Control/Oracle Net Manager Field	Description
TRACE_FILENO_ <i>listener_name</i>	You must set this parameter manually.	<p>The number of trace files for listener tracing. When this parameter is set along with the TRACE_FILELEN_<i>listener_name</i> parameter, trace files are used in a cyclical fashion. The first file is filled, then the second file, and so on. When the last file has been filled, the first file is re-used, and so on.</p> <p>The trace file names are distinguished from one another by their sequence number. For example, if the default trace file of <code>listener.trc</code> is used, and this parameter is set to 3, then the trace files would be named <code>listener1.trc</code>, <code>listener2.trc</code> and <code>listener3.trc</code>.</p> <p>In addition, trace events in the trace files are preceded by the sequence number of the file.</p> <p>When this parameter is set with the TRACE_FILEAGE_<i>listener_name</i> parameter, trace files are cycled based on the age of the trace file. The first file is used until the age limit is reached, then the second file is use, and so on. When the last file's age limit is reached, the first file is re-used, and so on.</p> <p>When this parameter is set with both the TRACE_FILELEN_<i>listener_name</i> and TRACE_FILEAGE_<i>listener_name</i> parameters, trace files are cycled when either the size limit or the age limit is reached.</p>
TRACE_TIMESTAMP_ <i>listener_name</i>	You must set this parameter manually.	A time stamp in the form of <code>dd-mon-yyyy hh:mi:ss:mi1</code> for every trace event in the listener trace file.

### 16.7.2.3 sqlnet.ora Trace Parameters

Table 16-21 describes the trace parameters settings that can be set in the `sqlnet.ora` file.

**Table 16-21 sqlnet.ora Trace Parameters**

sqlnet.ora Parameter	Oracle Net Manager Field	Description
TRACE_DIRECTORY_CLIENT	Client Information: Trace Directory	The destination directory for the client trace output. By default, the client directory is <code>ORACLE_HOME/network/trace</code> .

**Table 16-21 (Cont.) sqlnet.ora Trace Parameters**

sqlnet.ora Parameter	Oracle Net Manager Field	Description
TRACE_DIRECTORY_SERVER	Server Information: Trace Directory	The destination directory for the database server trace output. By default, the server directory is ORACLE_HOME/network/trace.
TRACE_FILE_CLIENT	Client Information: Trace File	The name of the trace file for the client. By default, the trace file name is sqlnet.trc.
TRACE_FILE_SERVER	Server Information: Trace File	The name of the trace file for the database server. By default the trace file name is svr_pid.trc.
TRACE_FILEAGE_CLIENT	You must set this parameter manually.	Specifies the maximum age of client trace files in minutes. When the age limit is reached, the trace information is written to the next file. The number of files is specified with the TRACE_FILENO_CLIENT parameter.
TRACE_FILEAGE_SERVER	You must set this parameter manually.	Specifies the maximum age of server trace files in minutes. When the age limit is reached, the trace information is written to the next file. The number of files is specified with the TRACE_FILENO_SERVER parameter.
TRACE_FILELEN_CLIENT	You must set this parameter manually.	The size of the client trace files in KB. When the size is reached, the trace information is written to the next file. The number of files is specified with the TRACE_FILENO_CLIENT parameter.
TRACE_FILELEN_SERVER	You must set this parameter manually.	The size of the database server trace files in KB. When the size is reached, the trace information is written to the next file. The number of files is specified with the TRACE_FILENO_SERVER parameter.
TRACE_FILENO_CLIENT	You must set this parameter manually.	<p>The number of trace files for client tracing. When this parameter is set along with the TRACE_FILELEN_CLIENT parameter, trace files are used in a cyclical fashion. The first file is filled, then the second file, and so on. When the last file has been filled, the first file is re-used, and so on.</p> <p>The trace file names are distinguished from one another by their sequence number. For example, if the default trace file of sqlnet.trc is used, and this parameter is set to 3, then the trace files would be named sqlnet1_pid.trc, sqlnet2_pid.trc and sqlnet3_pid.trc.</p> <p>In addition, trace events in the trace files are preceded by the sequence number of the file.</p> <p>When this parameter is set with the TRACE_FILEAGE_CLIENT parameter, trace files are cycled based on the age of the trace file. The first file is used until the age limit is reached, then the second file is use, and so on. When the last file's age limit is reached, the first file is re-used, and so on.</p> <p>When this parameter is set with both the TRACE_FILELEN_CLIENT and TRACE_FILEAGE_CLIENT parameters, trace files are cycled when either the size limit or age limit is reached.</p>

**Table 16-21 (Cont.) sqlnet.ora Trace Parameters**

sqlnet.ora Parameter	Oracle Net Manager Field	Description
TRACE_FILENO_SERVER	You must set this parameter manually.	<p>The number of trace files for database server tracing. When this parameter is set along with the TRACE_FILELEN_SERVER parameter, trace files are used in a cyclical fashion. The first file is filled, then the second file, and so on. When the last file has been filled, the first file is re-used, and so on.</p> <p>The trace file names are distinguished from one another by their sequence number. For example, if the default trace file of <i>svr_pid.trc</i> is used, and this parameter is set to 3, then the trace files would be named <i>svr1_pid.trc</i>, <i>svr2_pid.trc</i> and <i>svr3_pid.trc</i>.</p> <p>In addition, trace events in the trace files are preceded by the sequence number of the file.</p> <p>When this parameter is set with the TRACE_FILEAGE_SERVER parameter, trace files are cycled based on the age of the trace file. The first file is used until the age limit is reached, then the second file is use, and so on. When the last file's age limit is reached, the first file is re-used, and so on.</p> <p>When this parameter is set with both the TRACE_FILELEN_SERVER and TRACE_FILEAGE_SERVER parameters, trace files are cycled when either the size limit or age limit is reached.</p>
TRACE_LEVEL_CLIENT	Client Information: Trace Level	<p>The level of detail the trace facility records for the client. The trace level value can either be a value within the range of 0 (zero) to 16 where 0 is no tracing and 16 represents the maximum amount of tracing or one of the following values:</p> <ul style="list-style-type: none"> <li>• <i>off</i> (equivalent to 0) provides no tracing.</li> <li>• <i>user</i> (equivalent to 4) traces to identify user-induced error conditions.</li> <li>• <i>admin</i> (equivalent to 6) traces to identify installation-specific problems.</li> <li>• <i>support</i> (equivalent to 16) provides trace information for troubleshooting by Oracle Support Services.</li> </ul>
TRACE_LEVEL_SERVER	Server Information: Trace Level	<p>The level of detail the trace facility records for the database server. The trace level value can either be a value within the range of 0 (zero) to 16 where 0 is no tracing and 16 represents the maximum amount of tracing or one of the following values:</p> <ul style="list-style-type: none"> <li>• <i>off</i> (equivalent to 0) provides no tracing.</li> <li>• <i>user</i> (equivalent to 4) traces to identify user-induced error conditions.</li> <li>• <i>admin</i> (equivalent to 6) traces to identify installation-specific problems.</li> <li>• <i>support</i> (equivalent to 16) provides trace information for troubleshooting by Oracle Support Services.</li> </ul>



**Table 16-21 (Cont.) sqlnet.ora Trace Parameters**

sqlnet.ora Parameter	Oracle Net Manager Field	Description
TRACE_TIMESTAMP_CLIENT	You must set this parameter manually.	A time stamp in the form of <i>dd-mon-yyyy hh:mi:ss:mi1</i> for every trace event in the client trace file, <i>sqlnet.trc</i> .
TRACE_TIMESTAMP_SERVER	You must set this parameter manually.	A time stamp in the form of <i>dd-mon-yyyy hh:mi:ss:mi1</i> for every trace event in the client trace file, <i>sqlnet.trc</i> .
TRACE_UNIQUE_CLIENT	Client Information: Unique Trace File Name	When the value is set to <i>on</i> , Oracle Net creates a unique file name for each trace session by appending a process identifier to the name of each trace file generated, and enabling several files to coexist. For example, trace files named <i>sqlnetpid.trc</i> are created if default trace file name <i>sqlnet.trc</i> is used. When the value is set to <i>off</i> , data from a new client trace session overwrites the existing file.

You can manually add the TNSPING utility tracing parameters described in [Table 16-22](#) to the *sqlnet.ora* file. The TNSPING utility determines whether a service, such as a database or other TNS services on an Oracle Net network can be successfully reached.

**Table 16-22 TNSPING Trace Parameters**

sqlnet.ora Parameter	Description
TNSPING.TRACE_DIRECTORY	The destination directory for TNSPING trace file, <i>tnsping.trc</i> . By default, the directory is <i>ORACLE_HOME/network/trace</i> .
TNSPING.TRACE_LEVEL	The level of detail the trace facility records for the TNSPING utility. The trace level value can either be a value within the range of 0 (zero) to 16 where 0 is no tracing and 16 represents the maximum amount of tracing or one of the following values: <ul style="list-style-type: none"> <li><i>off</i> (equivalent to 0) provides no tracing.</li> <li><i>user</i> (equivalent to 4) traces to identify user-induced error conditions.</li> <li><i>admin</i> (equivalent to 6) traces to identify installation-specific problems.</li> <li><i>support</i> (equivalent to 16) provides trace information for troubleshooting by Oracle Support Services.</li> </ul>

### 16.7.2.4 Setting Tracing Parameters in Configuration Files

Configure tracing parameters for the *sqlnet.ora* file with Oracle Net Manager and *listener.ora* file with either Oracle Enterprise Manager Cloud Control or Oracle Net Manager. You must manually configure *cman.ora* file tracing parameters.

- [Setting Tracing Parameters for sqlnet.ora File Using Oracle Net Manager](#)
- [Setting Tracing Parameters for the Listener Using Oracle Enterprise Manager Cloud Control](#)

- [Setting Tracing Parameters for the Listener Using Oracle Net Manager](#)

#### 16.7.2.4.1 Setting Tracing Parameters for sqlnet.ora File Using Oracle Net Manager

The following procedure describes how to set the tracing parameters for the `sqlnet.ora` file using Oracle Net Manager:

1. Start Oracle Net Manager.



**See Also:**

["Using Oracle Net Manager to Configure Oracle Net Services"](#)

2. In the navigator pane, expand **Profile** under the Local heading.
3. From the list in the right pane, select **General**.
4. Click the **Tracing** tab.
5. Specify the settings.
6. Choose **Save Network Configuration** from the File menu.

The name of the trace file for the client is `sqlnet.trc`. The name of the trace file for the server is `svr_pid.trc`.

#### 16.7.2.4.2 Setting Tracing Parameters for the Listener Using Oracle Enterprise Manager Cloud Control

The following procedure describes how to set the tracing parameters for the listener using Oracle Enterprise Manager Cloud Control:

1. Access the Net Services Administration page in Oracle Enterprise Manager Cloud Control.



**See Also:**

["Using Oracle Enterprise Manager Cloud Control to Configure Oracle Net Services"](#)

2. Select **Listeners** from the **Administer** list, and then select the Oracle home that contains the location of the configuration files.
3. Click **Go** to display the Listeners page.
4. Select a listener, and then click **Edit** to display the Edit Listeners page.
5. Click the **Logging & Tracing** tab.
6. Specify the settings.
7. Click **OK**.

The name of the trace file is `listener.trc`.

### 16.7.2.4.3 Setting Tracing Parameters for the Listener Using Oracle Net Manager

The following procedure describes how to set the tracing parameters for the listener using Oracle Net Manager:

1. Start Oracle Net Manager.



#### See Also:

["Using Oracle Net Manager to Configure Oracle Net Services"](#)

2. In the navigator pane, expand **Listeners** from the Local heading.
3. Select a listener.
4. From the list in the right pane, select **General**.
5. Click the **Logging and Tracing** tab.
6. Specify the settings.
7. Choose **Save Network Configuration** from the File menu.

## 16.7.3 Setting Tracing During Control Utilities Runtime

You can set tracing during control utility runtime. Setting tracing with a control utility does not set parameters in the \*.ora files. The setting is only valid for the session of the control utility:

- For the listener, use the `SET TRC_DIRECTORY`, `SET TRC_FILE`, and `SET TRC_LEVEL` commands from the Listener Control utility.
- For Oracle Connection Manager, use the `SET TRACE_DIRECTORY` and `SET TRACE_LEVEL`, and `SET TRACE_TIMESTAMP` commands from the Oracle Connection Manager control utility.

## 16.7.4 Evaluating Oracle Net Services Trace Files

Trace files can help Oracle Support Services diagnose and troubleshoot network problems. This section explains how to perform basic analysis of trace files.

- [Flow of Data Packets Between Network Nodes](#)
- [Oracle Net Data Packet Formats](#)
- [Pertinent Oracle Net Trace Error Output](#)

### 16.7.4.1 Flow of Data Packets Between Network Nodes

Oracle Net performs its functions by sending and receiving data packets. You can view the actual contents of the Oracle Net packet in your trace file by specifying a trace level of `support`. The order of the packet types sent and received help to determine how the connection was established.

## 16.7.4.2 Oracle Net Data Packet Formats

Each line in the trace file begins with a procedure followed by a message. Following each procedure is a line of hexadecimal data representing actual data. The actual data that flows inside the packet is sometimes viewable to the right of the hexadecimal data.

Each packet has a keyword that denotes the packet type. All packet types begin with the prefix "nsp". This is helpful when reviewing trace files for specific packet information. The following keywords are used in a trace file:

- NSPTCN: Used with connect packet types.
- NSPTAC: Used with accept packet types.
- NSPTRF: Used with refuse packet types.
- NSPTRS: Used with resend packet types.
- NSPTDA: Used with data packet types.
- NSPCNL: Used with control packet types.
- NSPTMK: Used with marker packet types.

[Example 16-11](#) shows typical packet information. In the example, the nscon procedure sends an NSPTCN packet over the network.

### Example 16-11 Packet Information

```

nscon: entry
nscon: doing connect handshake...
nscon: sending NSPTCN packet
npsend: entry
npsend: plen=187, type=1
npsend: 187 bytes to transport
npsend:packet dump
npsend:00 BB 00 00 01 00 00 00 |.....|
npsend:01 33 01 2C 0C 01 08 00 |.3.,....|
npsend:7F FF 7F 08 00 00 00 01 |.....|
npsend:00 99 00 22 00 00 08 00 |..."....|
npsend:01 01 28 44 45 53 43 52 |..(DESCR|
npsend:49 50 54 49 4F 4E 3D 28 |IPTION=(|
npsend:43 4F 4E 4E 45 43 54 5F |CONNECT_|
npsend:44 41 54 41 3D 28 53 49 |DATA=(SI|
npsend:44 3D 61 70 33 34 37 64 |D=ap347d|
npsend:62 31 29 28 43 49 44 3D |b1)(CID=|
npsend:28 50 52 4F 47 52 41 4D |(PROGRAM|
npsend:3D 29 28 48 4F 53 54 3D |=)(HOST=|
npsend:61 70 32 30 37 73 75 6E |sales-12|
npsend:29 28 55 53 45 52 3D 6D |)(USER=m|
npsend:77 61 72 72 65 6E 29 29 |scott))|
npsend:29 28 41 44 44 52 45 53 |)(ADDRES|
npsend:53 5F 4C 49 53 54 3D 28 |S_LIST=(|
npsend:41 44 44 52 45 53 53 3D |ADDRESS=|
npsend:28 50 52 4F 54 4F 43 4F |(PROTOCO|
npsend:4C 3D 74 63 70 29 28 48 |L=tc)(H|
npsend:4F 53 54 3D 61 70 33 34 |OST=sale|
npsend:37 73 75 6E 29 28 50 4F |s-12)(PO|
npsend:52 54 3D 31 35 32 31 29 |RT=1521)|
npsend:29 29 29 00 00 00 00 00 |))).....|

```

```
nspsend: normal exit
nscon: exit (0)
```

### 16.7.4.3 Pertinent Oracle Net Trace Error Output

When there is a problem, the error code is logged in the trace file. [Example 16-12](#) illustrates typical trace file output for a failed SQL\*Plus connection to a database server. The error message and error stack are shown in bold.

#### Example 16-12 Trace Example

```
[22-MAY-2012 13:34:07:687] nsprecv: entry
[22-MAY-2012 13:34:07:687] nsbal: entry
[22-MAY-2012 13:34:07:687] nsbgetfl: entry
[22-MAY-2012 13:34:07:687] nsbgetfl: normal exit
[22-MAY-2012 13:34:07:687] nsmal: entry
[22-MAY-2012 13:34:07:687] nsmal: 44 bytes at 0x132d90
[22-MAY-2012 13:34:07:687] nsmal: normal exit
[22-MAY-2012 13:34:07:687] nsbal: normal exit
[22-MAY-2012 13:34:07:687] nsprecv: reading from transport...
[22-MAY-2012 13:34:07:687] nttrd: entry
[22-MAY-2012 13:35:09:625] nttrd: exit
[22-MAY-2012 13:35:09:625] ntt2err: entry
[22-MAY-2012 13:35:09:625] ntt2err: Read unexpected EOF ERROR on 10
[22-MAY-2012 13:35:09:625] ntt2err: exit
[22-MAY-2012 13:35:09:625] nsprecv: transport read error
[22-MAY-2012 13:35:09:625] nsprecv: error exit
[22-MAY-2012 13:35:09:625] nserror: entry
[22-MAY-2012 13:35:09:625] nserror: nsres: id=0, op=68, ns=12537,
ns2=12560;
nt[0]=507, nt[1]=0, nt[2]=0; ora[0]=0, ora[1]=0, ora[2]=0
[22-MAY-2012 13:35:09:625] nscon: error exit
[22-MAY-2012 13:35:09:625] nsdo: nsctxrnk=0
[22-MAY-2012 13:35:09:625] nsdo: error exit
[22-MAY-2012 13:35:09:625] nscall: unexpected response
[22-MAY-2012 13:35:09:625] nsclose: entry
[22-MAY-2012 13:35:09:625] nstimarmed: entry
[22-MAY-2012 13:35:09:625] nstimarmed: no timer allocated
[22-MAY-2012 13:35:09:625] nstimarmed: normal exit
[22-MAY-2012 13:35:09:625] nsdo: entry
[22-MAY-2012 13:35:09:625] nsdo: cid=0, opcode=98, *bl=0, *what=0,
uflgs=0x440, cflgs=0x2
[22-MAY-2012 13:35:09:625] nsdo: rank=64, nsctxrnk=0
[22-MAY-2012 13:35:09:625] nsdo: nsctx: state=1, flg=0x4201, mvd=0
[22-MAY-2012 13:35:09:625] nsbfr: entry
[22-MAY-2012 13:35:09:625] nsbaddfl: entry
[22-MAY-2012 13:35:09:625] nsbaddfl: normal exit
[22-MAY-2012 13:35:09:625] nsbfr: normal exit
[22-MAY-2012 13:35:09:625] nsbfr: entry
[22-MAY-2012 13:35:09:625] nsbaddfl: entry
[22-MAY-2012 13:35:09:625] nsbaddfl: normal exit
[22-MAY-2012 13:35:09:625] nsbfr: normal exit
[22-MAY-2012 13:35:09:625] nsdo: nsctxrnk=0
[22-MAY-2012 13:35:09:625] nsdo: normal exit
[22-MAY-2012 13:35:09:625] nsclose: closing transport
[22-MAY-2012 13:35:09:625] nttdisc: entry
[22-MAY-2012 13:35:09:625] nttdisc: Closed socket 10
[22-MAY-2012 13:35:09:625] nttdisc: exit
[22-MAY-2012 13:35:09:625] nsclose: global context check-out (from slot 0)
complete
```

```
[22-MAY-2012 13:35:09:703] nsnadisc: entry
[22-MAY-2012 13:35:09:703] nadisc: entry
[22-MAY-2012 13:35:09:703] nacomtm: entry
[22-MAY-2012 13:35:09:703] nacompd: entry
[22-MAY-2012 13:35:09:703] nacompd: exit
[22-MAY-2012 13:35:09:703] nacompd: entry
[22-MAY-2012 13:35:09:703] nacompd: exit
[22-MAY-2012 13:35:09:703] nacomtm: exit
[22-MAY-2012 13:35:09:703] nas_dis: entry
[22-MAY-2012 13:35:09:703] nas_dis: exit
[22-MAY-2012 13:35:09:703] nau_dis: entry
[22-MAY-2012 13:35:09:703] nau_dis: exit
[22-MAY-2012 13:35:09:703] naeetrm: entry
[22-MAY-2012 13:35:09:703] naeetrm: exit
[22-MAY-2012 13:35:09:703] naectrm: entry
[22-MAY-2012 13:35:09:703] naectrm: exit
[22-MAY-2012 13:35:09:703] nagbltrm: entry
[22-MAY-2012 13:35:09:703] nau_gtm: entry
[22-MAY-2012 13:35:09:703] nau_gtm: exit
[22-MAY-2012 13:35:09:703] nagbltrm: exit
[22-MAY-2012 13:35:09:703] nadisc: exit
[22-MAY-2012 13:35:09:703] nsnadisc: normal exit
[22-MAY-2012 13:35:09:703] nsbfr: entry
[22-MAY-2012 13:35:09:703] nsbaddfl: entry
[22-MAY-2012 13:35:09:703] nsbaddfl: normal exit
[22-MAY-2012 13:35:09:703] nsbfr: normal exit
[22-MAY-2012 13:35:09:703] nsmfr: entry
[22-MAY-2012 13:35:09:703] nsmfr: 2256 bytes at 0x130508
[22-MAY-2012 13:35:09:703] nsmfr: normal exit
[22-MAY-2012 13:35:09:703] nsmfr: entry
[22-MAY-2012 13:35:09:703] nsmfr: 484 bytes at 0x1398a8
[22-MAY-2012 13:35:09:703] nsmfr: normal exit
[22-MAY-2012 13:35:09:703] nsclose: normal exit
[22-MAY-2012 13:35:09:703] nscall: connecting...
[22-MAY-2012 13:35:09:703] nsclose: entry
[22-MAY-2012 13:35:09:703] nsclose: normal exit
[22-MAY-2012 13:35:09:703] nladget: entry
[22-MAY-2012 13:35:09:734] nladget: exit
[22-MAY-2012 13:35:09:734] nsmfr: entry
[22-MAY-2012 13:35:09:734] nsmfr: 144 bytes at 0x132cf8
[22-MAY-2012 13:35:09:734] nsmfr: normal exit
[22-MAY-2012 13:35:09:734] nsmfr: entry
[22-MAY-2012 13:35:09:734] nsmfr: 156 bytes at 0x138e70
[22-MAY-2012 13:35:09:734] nsmfr: normal exit
[22-MAY-2012 13:35:09:734] nladtrm: entry
[22-MAY-2012 13:35:09:734] nladtrm: exit
[22-MAY-2012 13:35:09:734] nscall: error exit
[22-MAY-2012 13:35:09:734] nioqper: error from nscall
[22-MAY-2012 13:35:09:734] nioqper: ns main err code: 12537
[22-MAY-2012 13:35:09:734] nioqper: ns (2) err code: 12560
[22-MAY-2012 13:35:09:734] nioqper: nt main err code: 507
[22-MAY-2012 13:35:09:734] nioqper: nt (2) err code: 0
[22-MAY-2012 13:35:09:734] nioqper: nt OS err code: 0
[22-MAY-2012 13:35:09:734] niomapnserror: entry
[22-MAY-2012 13:35:09:734] niqme: entry
[22-MAY-2012 13:35:09:734] niqme: reporting NS-12537 error as ORA-12537
[22-MAY-2012 13:35:09:734] niqme: exit
[22-MAY-2012 13:35:09:734] niomapnserror: returning error 12537
[22-MAY-2012 13:35:09:734] niomapnserror: exit
[22-MAY-2012 13:35:09:734] niotns: Couldn't connect, returning 12537
[22-MAY-2012 13:35:10:734] niotns: exit
```

```
[22-MAY-2012 13:35:10:734] nsbfrfl: entry
[22-MAY-2012 13:35:10:734] nsbrfr: entry
[22-MAY-2012 13:35:10:734] nsbrfr: nsbfs at 0x132d90, data at 0x132dc8.
[22-MAY-2012 13:35:10:734] nsbrfr: normal exit
[22-MAY-2012 13:35:10:734] nsbrfr: entry
[22-MAY-2012 13:35:10:734] nsbrfr: nsbfs at 0x1248d8, data at 0x132210.
[22-MAY-2012 13:35:10:734] nsbrfr: normal exit
[22-MAY-2012 13:35:10:734] nsbrfr: entry
[22-MAY-2012 13:35:10:734] nsbrfr: nsbfs at 0x12d820, data at 0x1319f0.
[22-MAY-2012 13:35:10:734] nsbrfr: normal exit
[22-MAY-2012 13:35:10:734] nsbfrfl: normal exit
[22-MAY-2012 13:35:10:734] nigtrm: Count in the NI global area is now 1
[22-MAY-2012 13:35:10:734] nigtrm: Count in the NL global area is now 1
```

 **Note:**

In the error stack in the preceding example, an operating system error code is shown. Each operating system has its own error codes, refer to your system documentation for information about operating system error codes.

The most efficient way to evaluate error codes is to find the most recent `nserror` entry logged, as the session layer controls the connection. The most important error messages are the ones at the bottom of the file. They are the most recent errors and the source of the problem with the connection.

For information about the specific return codes, use the Oracle error tool `oerr`, by entering the following at any command line:

```
oerr tns error_number
```

As an example, consider the following `nserror` entry logged in the trace file shown in [Example 16-12](#):

```
[22-MAY-2012 13:35:09:625] nserror: nsres: id=0, op=68, ns=12537, ns2=12560;  
nt[0]=507, nt[1]=0, nt[2]=0; ora[0]=0, ora[1]=0, ora[2]=0
```

In the preceding example, the main TNS error is 12537, and its secondary error is 12560. The protocol adapter error is 507. Using `oerr`, you can find out more information about return codes 12537, 12560, and 507. User input is shown in bold in the following examples.

```
oerr tns 12537  
12537, 00000, "TNS:connection closed"  
// *Cause: "End of file" condition has been reached; partner has disconnected.  
// *Action: None needed; this is an information message.
```

```
oerr tns 12560  
12560, 00000, "TNS:protocol adapter error"  
// *Cause: A generic protocol adapter error occurred.  
// *Action: Check addresses used for proper protocol specification. Before  
// reporting this error, look at the error stack and check for lower level  
// transport errors. For further details, turn on tracing and reexecute the  
// operation. Turn off tracing when the operation is complete.
```

```
oerr tns 507  
00507, 00000, "Connection closed"  
// *Cause: Normal "end of file" condition has been reached; partner has
```

```
// disconnected.
// *Action: None needed; this is an information message.
```

## 16.7.5 Using the Trace Assistant to Examine Trace Files

Oracle Net Services provides a tool called the **Trace Assistant** to help understand the information provided in trace files by converting existing lines of trace file text into a more readable paragraph. The Trace Assistant works only with level 16 (support) Oracle Net Services trace files.

### Note:

The Trace Assistant can only be used when the `DIAG_ADR_ENABLED` parameter is set to `off`. See "[Understanding Automatic Diagnostic Repository](#)".

- [Trace Assistant Syntax](#)
- [Packet Examples](#)
- [Two-Task Common \(TTC\) Packet Examples](#)
- [Connection Example](#)
- [Statistics Example](#)

### 16.7.5.1 Trace Assistant Syntax

To run the Trace Assistant, enter the following command at any command line prompt:

```
trcasst [options] filename
```

The options are described in [Table 16-23](#).

**Table 16-23 Trace Assistant Syntax**

Option	Description
<code>-elevel</code>	Displays error information. After the <code>-e</code> , use 0, 1, or 2 error decoding level may follow: <ul style="list-style-type: none"> <li>• 0 or nothing translates the NS error numbers dumped from the <code>nserror</code> function plus lists all other errors</li> <li>• 1 displays only the NS error translation from the <code>nserror</code> function</li> <li>• 2 displays error numbers without translation</li> </ul>



**Table 16-23 (Cont.) Trace Assistant Syntax**

Option	Description
-la	<p>If a connection ID exists in the NS connect packet, then the output displays the connection IDs. Connection IDs are displayed as hexadecimal, eight-byte IDs. A generated ID is created by Trace Assistant if the packet is not associated with any connection, that is, the connect packet is overwritten in the trace file. This can occur with cyclic trace files.</p> <p>For each ID, the output lists the following:</p> <ul style="list-style-type: none"> <li>• Socket ID, if the connection has one.</li> <li>• Connect packet send or receive operation.</li> <li>• Current setting of the MULTIPLEX attribute of the DISPATCHERS parameter in the initialization parameter file. When MULTIPLEX is set to ON, session multiplexing is enabled.</li> <li>• Session ID, if MULTIPLEX is set to ON.</li> <li>• Connect data information.</li> </ul> <p><b>Notes:</b></p> <ul style="list-style-type: none"> <li>• Do not use this option with other options.</li> <li>• The IDs generated by the Trace Assistant do not correlate with client/server trace files.</li> </ul>
-li ID	<p>Displays the trace for a particular ID from the -la output</p> <p><b>Note:</b> Only use this option with output from the -la option.</p>
-otype	<p>Displays the amount and type of information to be output. After the -o the following options can be used:</p> <ul style="list-style-type: none"> <li>• c to display summary connectivity information.</li> <li>• d to display detailed connectivity information.</li> <li>• u to display summary Two-Task Common (TTC) information.</li> <li>• t to display detailed TTC information.</li> <li>• q to display SQL commands enhancing summary TTC information. Use this option with u, such as -ouq.</li> </ul> <p><b>Note:</b> As output for d contains the same information as displayed for c, do not submit both c and d. If you submit both, then only output d is processed.</p>
-s	<p>Displays the following statistical information:</p> <ul style="list-style-type: none"> <li>• Total number of bytes sent and received.</li> <li>• Maximum open cursors.</li> <li>• Currently open cursors.</li> <li>• Count and ratio of operations.</li> <li>• Parsing and execution count for PL/SQL.</li> <li>• Total calls sent and received.</li> <li>• Total, average, and maximum number of bytes sent and received.</li> <li>• Total number of transports and sessions present.</li> <li>• Timestamp information, if any.</li> <li>• Sequence numbers, if any.</li> </ul>

If no options are provided, then the default is `-odt -e0 -s`, which provides detailed connectivity and TTC events, error level zero (0), and statistics in the trace file.

The following example shows how the Trace Assistant converts the trace file information into a more readable format using the `-e1` option.

### Example 16-13 trcasst -e1 Output

```

*****
*                               Trace Assistant                               *
*****

ntus2err: exit
ntuscni: exit
ntusconn: exit
nserver: entry
-<ERROR>- nserver: nsres: id=0, op=65, ns=12541, ns2=12560; nt[0]=511, nt[1]=2,
nt[2]=0
////////////////////////////////////
Error found. Error Stack follows:
      id:0
      Operation code:65
      NS Error 1:12541
      NS Error 2:12560
NT Generic Error:511
  Protocol Error:2
    OS Error:0
NS & NT Errors Translation
12541, 00000 "TNS:no listener"
// *Cause: The connection request could not be completed because the listener
// is not running.
// *Action: Ensure that the supplied destination address matches one of
// the addresses used by the listener - compare the TNSNAMES.ORA entry with
// the appropriate LISTENER.ORA file (or TNSNAV.ORA if the connection is to
// go by way of an Interchange). Start the listener on the remote machine.
/
12560, 00000 "TNS:protocol adapter error"
// *Cause: A generic protocol adapter error occurred.
// *Action: Check addresses used for proper protocol specification. Before
// reporting this error, look at the error stack and check for lower level
// transport errors.For further details, turn on tracing and reexecute the
// operation. Turn off tracing when the operation is complete.
/
00511, 00000 "No listener"
// *Cause: The connect request could not be completed because no application
// is listening on the address specified, or the application is unable to
// service the connect request in a sufficiently timely manner.
// *Action: Ensure that the supplied destination address matches one of
// the addresses used by the listener - compare the TNSNAMES.ORA entry with
// appropriate LISTENER.ORA file (or TNSNAV.ORA if the connection is to go
// by way of an Interchange. Start the listener on the remote machine.
/
////////////////////////////////////
*****
*                               Trace Assistant has completed                               *
*****

```

However, other errors may also exist within the trace file that were not logged from the nserver function.

## 16.7.5.2 Packet Examples

Trace Assistant also enables you to view data packets from both the Oracle Net and TTC communication layers. Trace Assistant offers two options to view these packets:

- Summary connectivity (using option `-oc`)
- Detailed connectivity (using option `-od`)

[Example 16-14](#) shows summary information from the `-oc` option.

#### Example 16-14 Summary Information from `trcasst -oc` Output

```
*****
*                               Trace Assistant                               *
*****

---> Send 198 bytes - Connect packet
Connect data length: 140
Connect Data:
  (DESCRIPTION=(ADDRESS=(PROTOCOL=TCP)(HOST=sales-server)(PORT=1521))
  (CONNECT_DATA=(SERVICE_NAME=sales.us.example.com)(CID=(PROGRAM=)
  (HOST=sales-server)(USER=joe))))

<--- Received 76 bytes - Redirect packet
Redirect data length: 66
Redirect Data:
  (ADDRESS=(PROTOCOL=tcp)(HOST=sales-server)(PORT=1521))

---> Send 198 bytes - Connect packet
Connect data length: 140
Connect Data:
  (DESCRIPTION=(ADDRESS=(PROTOCOL=TCP)(HOST=sales-server)(PORT=1521))
  (CONNECT_DATA=(SERVICE_NAME=sales.us.example.com)(CID=(PROGRAM=)
  (HOST=sales-server)(USER=joe))))

<--- Received 32 bytes - Accept packet
Connect data length: 0
---> Send 153 bytes - Data packet
      Native Services negotiation packet

<--- Received 127 bytes - Data packet
      Native Services negotiation packet

---> Send 32 bytes - Data packet

<--- Received 140 bytes - Data packet

*****
*                               Trace Assistant has completed                               *
*****
```

The packets being sent or received have a prefix of `---> Send nnn bytes` or `<--- Received nnn bytes` showing that this node is sending or receiving a packet of a certain type and with *nnn* number of bytes. This prefix enables you to determine if the node is the client or the database server. The connection request is always sent by the client, and received by the database server or listener.

[Example 16-15](#) shows detailed information from the `-od` option. The output shows all of the details sent along with the connect data in negotiating a connection.

#### Example 16-15 Detailed Information from `trcasst -od` Output

```
*****
*                               Trace Assistant                               *
*****

---> Send 241 bytes - Connect packet
```

```
Current NS version number is: 311.
Lowest NS version number can accommodate is: 300.
Global options for the connection:
  can receive attention
  no attention processing
  Don't care
  Maximum SDU size:8192
  Maximum TDU size:32767
  NT protocol characteristics:
    Test for more data
    Test operation
    Full duplex I/O
    Urgent data support
    Generate SIGURG signal
    Generate SIGPIPE signal
    Generate SIGIO signal
    Handoff connection to another
  Line turnaround value :0
  Connect data length :183
  Connect data offset :58
  Connect data maximum size :512
    Native Services wanted
    NAU doing O3LOGON - DH key foldedin
    Native Services wanted
    NAU doing O3LOGON - DH key foldedin
  Cross facility item 1: 0
  Cross facility item 2: 0
  Connection id : 0x000059F70000004C
  (DESCRIPTION=(ADDRESS=(PROTOCOL=TCP)(HOST=sales-server)(PORT=1521))
  (CONNECT_DATA=(SERVICE_NAME=sales.us.example.com)(SRVR=SHARED)(CID=(PROGRAM=)
  (HOST=sales-server)(USER=joe))))

<--- Received 76 bytes - Redirect packet
  Redirect data length: 66
  (ADDRESS=(PROTOCOL=tcp)(HOST=sales-server)(PORT=1521))

---> Send 241 bytes - Connect packet
Current NS version number is: 311.
Lowest NS version number can accommodate is: 300.
Global options for the connection:
  can receive attention
  no attention processing
  Don't care
  Maximum SDU size:8192
  Maximum TDU size:32767
  NT protocol characteristics:
    Test for more data
    Test operation
    Full duplex I/O
    Urgent data support
    Generate SIGURG signal
    Generate SIGPIPE signal
    Generate SIGIO signal
    Handoff connection to another
  Line turnaround value :0
  Connect data length :183
  Connect data offset :58
  Connect data maximum size :512
    Native Services wanted
    NAU doing O3LOGON - DH key foldedin
    Native Services wanted
```

```

        NAU doing O3LOGON - DH key foldedin
Cross facility item 1: 0
Cross facility item 2: 0
Connection id : 0x000059F70000007A
(DESCRIPTION=(ADDRESS=(PROTOCOL=TCP)(HOST=sales-server)(PORT=1521))
(CONNECT_DATA=(SERVICE_NAME=sales.us.example.com)(SRVR=SHARED)(CID=(PROGRAM=
(HOST=sales-server)(USER=joe))))
<--- Received 32 bytes - Accept packet
        Accepted NS version number is: 310.
Global options for the connection:
        no attention processing
        Don't care
        Accepted maximum SDU size: 8192
        Accepted maximum TDU size: 32767
        Connect data length: 0
                Native Services wanted
                NAU doing O3LOGON - DH key foldedin
                Native Services wanted
                NAU doing O3LOGON - DH key foldedin

---> Send 153 bytes - Data packet
        Native Services negotiation packet version#: 150999040
        Service data packet #0 for Supervisor has 3 subpackets
                Subpacket #0: Version #150999040
                Subpacket #1: 0000000000000000
                Subpacket #2: DEADBEEF0003000000040004000100010002
        Service data packet #1 for Authentication has 3 subpackets
                Subpacket #0: Version #150999040
                Subpacket #1: UB2: 57569
                Subpacket #2: FCFF
        Service data packet #2 for Encryption has 2 subpackets
                Subpacket #0: Version #150999040
                Subpacket #1: 00000000000000000000
        Service data packet #3 for Data Integrity has 2 subpackets
                Subpacket #0: Version #150999040
                Subpacket #1: 000000

<--- Received 127 bytes - Data packet
        Native Services negotiation packet version#: 135290880
        Service data packet #0 for Supervisor has 3 subpackets
                Subpacket #0: Version #135290880
                Subpacket #1: 0000
                Subpacket #2: DEADBEEF00030000000200040001
        Service data packet #1 for Authentication has 2 subpackets
                Subpacket #0: Version #135290880
                Subpacket #1: FBFF
        Service data packet #2 for Encryption has 2 subpackets
                Subpacket #0: Version #135290880
                Subpacket #1: UB1: 0
        Service data packet #3 for Data Integrity has 2 subpackets
                Subpacket #0: Version #135290880
                Subpacket #1: UB1: 0
        ....

---> Send 11 bytes - Marker packet
        One data byte.
        Hex character sent over to the server: 2

<--- Received 11 bytes - Marker packet
        One data byte.
        Hex character sent over to the server: 2

```

```

<--- Received 155 bytes - Data packet

---> Send 25 bytes - Data packet

<--- Received 11 bytes - Data packet

---> Send 13 bytes - Data packet

<--- Received 11 bytes - Data packet

---> Send 10 bytes - Data packet
Data Packet flags:
End of file
*****
*                               Trace Assistant has completed                               *
*****

```

### 16.7.5.3 Two-Task Common (TTC) Packet Examples

TTC handles requests such as open cursor, select rows, and update rows that are directed to the database server. All requests are answered by the database server. If you request to log on, then a response is returned from the database server that the request was completed.

Summary information for TTC from the `-ou` option is different from other displays in that it shows two packets on each line, rather than one. This is done to mirror the request/response pairings process by which TTC operates.

Output is displayed in the following format:

```

description TTC_message cursor_number SQL_statement bytes_sent
bytes_received

```

[Example 16-16](#) shows all of the details sent along with the connect data in negotiating a connection.

#### Example 16-16 trcasst -ou Output

```

*****
*                               Trace Assistant                               *
*****

```

		Bytes Sent	Bytes Rcvd
Send operation(TTIPRO)		32	140
Send operation(TTIDTY)		33	22
Get the session key (OSESKEY)		229	145
Generic authentication call (OAUTH)		368	1001
Send operation(TTIPFN)		44	144
Send operation(TTIPFN)		36	16
Parse a statement (OSQL)	# 1 SELECT USER FROM ...	47	100
Fast upi calls to opial7 (OALL7)	# 1	130	111
Fetch row (OFETCH)	# 1	21	137
Close cursor (OCLOSE)	# 1	17	11
New v8 bundled call (OALL8)	# 0 !Keep Parse BEGI...	156	145
Send operation(TTIPFN)		51	16
Parse a statement (OSQL)	# 1 SELECT ATTRIBUTE,...	186	100
Fast upi calls to opial7 (OALL7)	# 1	246	111

```

Fetch row (OFETCH)                # 1                21    126
Close cursor (OCLOSE)             # 1                17    11
Send operation(TTIPFN)            36    16
Parse a statement (OSQL)          # 1 SELECT CHAR_VALUE... 208 100
Fast upi calls to opial7 (OALL7)  # 1                130 111
Fetch row (OFETCH)                # 1                21    126
Close cursor (OCLOSE)             # 1                17    11
Send operation(TTIPFN)            36    16
Fast upi calls to opial7 (OALL7)  # 1 !Keep Parse BEGI... 183 41
Send operation(TTIRXD)            20    111
Close cursor (OCLOSE)             # 1                17    11
New v8 bundled call (OALL8)       # 0 Parse Fetch SELE... 165 278
Send operation(TTIPFN)            51    16
Parse a statement (OSQL)          # 1 commit          31    100
Execute statement (OEXEC)         # 1 number of rows: 1 25    100
Close cursor (OCLOSE)             # 1                17    11
Send operation(TTIPFN)            36    16
Fast upi calls to opial7 (OALL7)  # 1 !Keep Parse BEGI... 183 41
Send operation(TTIRXD)            60    111
Close cursor (OCLOSE)             # 1                17    11
Send operation(TTIPFN)            36    16
Fast upi calls to opial7 (OALL7)  # 1 !Keep Parse BEGI... 183 41
Send operation(TTIRXD)            20    111
Close cursor (OCLOSE)             # 1                17    11
New v8 bundled call (OALL8)       # 0 Parse Fetch sele... 144 383
New v8 bundled call (OALL8)       # 1 !Keep Fetch      121 315
Logoff off of Oracle (OLOGOFF)    13    11

```

```

*****
*                               Trace Assistant has completed                               *
*****

```

Example 16-17 shows detailed TTC information from the `-ot` option.

### Example 16-17 Detailed TTC Information from `trcasst -ot` Output

```

*****
*                               Trace Assistant                               *
*
*****

Set protocol (TTIPRO)
  Operation 01 (con) Send protocol version=6
  Originating platform: x86_64/Linux 2.4.xx

Set protocol (TTIPRO)
  Operation 01 (con) Receive protocol version=6
  Destination platform: x86_64/Linux 2.4.xx

Set datatypes (TTIDTY)

Set datatypes (TTIDTY)

Start of user function (TTIFUN)
  Get the session key (OSESKEY)

Return opi parameter (TTIRPA)

Start of user function (TTIFUN)
  Generic authentication call (OAUTH)

```

```
Return opi parameter (TTIRPA)

Piggyback function follows (TTIPFN)
Start of user function (TTIFUN)
    V8 session switching piggyback (O80SES)
Start of user function (TTIFUN)
    Get Oracle version/date (OVERSION)

Return opi parameter (TTIRPA)
Oracle Database 18c Enterprise Edition Release 18.0.0.0.0 - 64bit Production
Version 18.1.0.0.0
Start of user function (TTIFUN)
    New v8 bundled call (OALL8) Cursor # 0
Parse Fetch

Describe information (TTIDCB)

Start of user function (TTIFUN)
    Fetch row (OFETCH) Cursor # 3

ORACLE function complete (TTIOER)
ORA-01403: no data found

Piggyback function follows (TTIPFN)
Start of user function (TTIFUN)
    Cursor Close All (OCCA)
Start of user function (TTIFUN)
    New v8 bundled call (OALL8) Cursor # 0
Parse Fetch

Describe information (TTIDCB)

Piggyback function follows (TTIPFN)
Start of user function (TTIFUN)
    Cursor Close All (OCCA)
Start of user function (TTIFUN)
    New v8 bundled call (OALL8) Cursor # 0
Parse Fetch

Describe information (TTIDCB)

Piggyback function follows (TTIPFN)
Start of user function (TTIFUN)
    Cursor Close All (OCCA)
Start of user function (TTIFUN)
    New v8 bundled call (OALL8) Cursor # 0
!Keep Parse

Sending the I/O vector only for fast upi (TTIIOV)

Piggyback function follows (TTIPFN)
Start of user function (TTIFUN)
```



```

Cursor Close All (OCCA)
Start of user function (TTIFUN)
  New v8 bundled call (OALL8) Cursor # 0
Parse Fetch

```

```
Describe information (TTIDCB)
```

```

Piggyback function follows (TTIPFN)
Start of user function (TTIFUN)
  Cursor Close All (OCCA)
Start of user function (TTIFUN)
  Commit (OCOMMIT)

```

```
V6 Oracle func complete (TTISTA)
```

```

Start of user function (TTIFUN)
  Commit (OCOMMIT)

```

```
V6 Oracle func complete (TTISTA)
```

```

Start of user function (TTIFUN)
  Logoff off of Oracle (OLOGOFF)
  MAXIMUM OPEN CURSORS: 0
  CURSORS NOT CLOSED: 0

```

```

V6 Oracle func complete (TTISTA)
  Succeeded

```

```

*****
*                               Trace Assistant has completed                               *
*****

```

**Example 16-18** shows detailed SQL information from the `-ouq` option. On each line of the output, the first item displayed is the actual request made. The second item shows on what cursor that operation has been performed. The third item is either a listing of the SQL command or flag that is being answered. The number of bytes sent and received are displayed at the far right. A flag can be one of the following:

- !PL/SQL = Not a PL/SQL request
- COM = Commit
- IOV = Get I/O Vector
- DEFN = Define
- EXEC = Execute
- FETCH = Fetch
- CAN = Cancel
- DESCSEL = Describe select
- DESCBND = Describe Bind
- BND = Bind
- PARSE = Parse

- EXACT = Exact

**Example 16-18 Detailed SQL Information from trcasst -ouq Output**

```

*****
*                               Trace Assistant                               *
*****
                                                                 Bytes  Bytes
                                                                 Sent   Rcvd

Send operation(TTIPRO)                                           32    140
Send operation(TTIDTY)                                           33     22
Get the session key (OSESKEY)                                    229    145
Generic authentication call (OAUTH)                              368   1001
Send operation(TTIPFN)                                           44    144
Send operation(TTIPFN)                                           36     16
Parse a statement (OSQL) # 1                                     47    100
      SELECT USER FROM DUAL

Fast upi calls to opial7 (OALL7) # 1                             130    111
Fetch row (OFETCH) # 1                                         21    137
Close cursor (OCLOSE) # 1                                       17     11
New v8 bundled call (OALL8) # 0 !Keep Parse                       156    145
      BEGIN DBMS_OUTPUT.DISABLE; END;

Send operation(TTIPFN)                                           51     16
Parse a statement (OSQL) # 1                                     186    100
      SELECT ATTRIBUTE,SCOPE,NUMERIC_VALUE,CHAR_VALUE,DATE
      VALUE FROM SYSTEM.PRODUCT_PRIVS WHERE (UPPER('S
      QL*Plus') LIKE UPPER(PRODUCT)) AND (UPPER(USER) LI
      KE USERID)

Fast upi calls to opial7 (OALL7) # 1                             246    111
Fetch row (OFETCH) # 1                                         21    126
Close cursor (OCLOSE) # 1                                       17     11
Send operation(TTIPFN)                                           36     16
Parse a statement (OSQL) # 1                                     208    100
      SELECT CHAR_VALUE FROM SYSTEM.PRODUCT_PRIVS WHERE
      (UPPER('SQL*Plus') LIKE UPPER(PRODUCT)) AND ((UPPE
      R(USER) LIKE USERID) OR (USERID = 'PUBLIC')) AND (
      UPPER(ATTRIBUTE) = 'ROLES')

Fast upi calls to opial7 (OALL7) # 1                             130    111
Fetch row (OFETCH) # 1                                         21    126
Close cursor (OCLOSE) # 1                                       17     11
Send operation(TTIPFN)                                           36     16
Fast upi calls to opial7 (OALL7) # 1 !Keep Parse                 183     41
      BEGIN DBMS_APPLICATION_INFO.SET_MODULE(:1,NULL); E
      ND;

Send operation(TTIRXD)                                           20    111
Close cursor (OCLOSE) # 1                                       17     11
New v8 bundled call (OALL8) # 0 Parse Fetch                       165    278
      SELECT DECODE('A','A','1','2') FROM DUAL

Send operation(TTIPFN)                                           51     16
Parse a statement (OSQL) # 1                                     31    100
      commit

Execute statement (OEXEC) # 1 number of rows: 1                 25    100
Close cursor (OCLOSE) # 1                                       17     11
Send operation(TTIPFN)                                           36     16

```

```

Fast upi calls to opial7 (OALL7)          # 1 !Keep Parse          183    41
      BEGIN DBMS_APPLICATION_INFO.SET_MODULE(:1,NULL); E
      ND;

Send operation(TTIRXD)                    60    111
Close cursor (OCLOSE)                    # 1          17    11
Send operation(TTIPFN)                    36    16
Fast upi calls to opial7 (OALL7)          # 1 !Keep Parse          183    41
      BEGIN DBMS_APPLICATION_INFO.SET_MODULE(:1,NULL); E
      ND;

Send operation(TTIRXD)                    20    111
Close cursor (OCLOSE)                    # 1          17    11
New v8 bundled call (OALL8)              # 0 Parse Fetch          144    383
      select * from dept

New v8 bundled call (OALL8)              # 1 !Keep Fetch          121    315
Logoff off of Oracle (OLOGOFF)           13    11

*****
*                               Trace Assistant                               *
*****

```

## 16.7.5.4 Connection Example

**Example 16-19** shows output from the `-la` option. The output shows the following information:

- Connect IDs received
- Socket ID on which this connection has come
- Operation
  - Receive identifies the trace as a database server trace. In this example, Receive is the operation.
  - Send identifies the trace as a client trace.
- MULTIPLEX attribute of the DISPATCHERS parameter is set to ON
- 32-bit session ID
- Connect data information received

### Example 16-19 trcasst -la Output

```

*****
*                               Trace Assistant                               *
*****

Connection ID: 00000B270000000B
  Socket Id: 15
  Operation: Receive
  Multiplex: ON
  Session Id: 8362785DE4FC0B19E034080020F793E1
  Connect Data:
  (DESCRIPTION=(ADDRESS=(PROTOCOL=TCP)(HOST=sales-server)(PORT=1521))
  (CONNECT_DATA=(SERVER=shared)
  (SERVICE_NAME=sales.us.example.com)(CID=(PROGRAM=)(HOST=sales-server)
  (USER=oracle)))
Connection ID: 00000B240000000B
  Socket Id: 15

```

```

Operation: Receive
Multiplex: ON
Session Id: 8362785DE4FB0B19E034080020F793E1
Connect Data:
  (DESCRIPTION=(ADDRESS=(PROTOCOL=TCP)(HOST=sales-server)(PORT=1521))
  (CONNECT_DATA=(SERVER=shared)
  (SERVICE_NAME=sales.us.example.com)(CID=(PROGRAM=)(HOST=sales-server)
  (USER=oracle)))
Connection ID: 00000B1F00000008
Socket Id: 15
Operation: Receive
Multiplex: ON
Session Id: 8362785DE4F90B19E034080020F793E1
Connect Data:
  (DESCRIPTION=(ADDRESS=(PROTOCOL=TCP)(HOST=sales-server)(PORT=1521))
  (CONNECT_DATA=(SERVER=shared)
  (SERVICE_NAME=sales.us.example.com)(CID=(PROGRAM=)(HOST=sales-server)
  (USER=oracle)))
*****
*                               Trace Assistant has completed                               *
*****

```

**Example 16-20** shows output for connection ID 00000B1F00000008 from the `-li 00000B1F00000008` option.

### Example 16-20 `trcasst -li` Output

```

*****
*                               Trace Assistant                               *
*****
<--- Received 246 bytes - Connect packet
Current NS version number is: 310.
Lowest NS version number can accommodate is: 300.
Global options for the connection:
  Can receive attention
  No attention processing
  Don't care
  Maximum SDU size: 8192
  Maximum TDU size: 32767
  NT protocol characteristics:
    Test for more data
    Test operation
    Full duplex I/O
    Urgent data support
    Generate SIGURG signal
    Generate SIGPIPE signal
    Generate SIGIO signal
    Handoff connection to another
  Line turnaround value: 0
  Connect data length: 188
  Connect data offset: 58
  Connect data maximum size: 512
    Native Services wanted
    NAU doing O3LOGON - DH key foldedin
    Native Services wanted
    NAU doing O3LOGON - DH key foldedin
  Cross facility item 1: 0
  Cross facility item 2: 0
  Connection id: 0x00000B1F00000008
  (DESCRIPTION=(ADDRESS=(PROTOCOL=TCP)(HOST=sales-server)(PORT=1521))

```

```
(CONNECT_DATA=(SERVER=shared)(SERVICE_NAME=sales.us.example.com)
(CID=(PROGRAM=(HOST=sales-server)(USER=oracle))))

---> Send 114 bytes - Accept packet
Accepted NS version number is: 310.
Global options for the connection:
  No attention processing
  Don't care
  Accepted maximum SDU size: 8192
  Accepted maximum TDU size: 32767
  Connect data length: 0
    Native Services wanted
    NAU doing O3LOGON - DH key foldedin
    Native Services wanted
    NAU doing O3LOGON - DH key foldedin
  Connection Time out: 1000
  Tick Size: 100
  Reconnect Data: (ADDRESS=(PROTOCOL=tcp)(HOST=sales-server)(PORT=34454))
  Session Id: 8362785DE4F90B19E034080020F793E1
<--- Received 164 bytes - Data packet
  Native Services negotiation packet version#: 135290880
    Service data packet #0 for Supervisor has 3 subpackets
      Subpacket #0: Version #135290880
      Subpacket #1: 0000000000000000
      Subpacket #2: DEADBEEF0003000000040004000100010002
    Service data packet #1 for Authentication has 3 subpackets
      Subpacket #0: Version #135290880
      Subpacket #1: UB2: 57569
      Subpacket #2: FCFF
    Service data packet #2 for Encryption has 2 subpackets
      Subpacket #0: Version #135290880
      Subpacket #1: 0000000000
    Service data packet #3 for Data Integrity has 2 subpackets
      Subpacket #0: Version #135290880
      Subpacket #1: 0000
---> Send 143 bytes - Data packet
  Native Services negotiation packet version#: 135290880
    Service data packet #0 for Supervisor has 3 subpackets
      Subpacket #0: Version #135290880
      Subpacket #1: 0000
      Subpacket #2: DEADBEEF00030000000200040001
    Service data packet #1 for Authentication has 2 subpackets
      Subpacket #0: Version #135290880
      Subpacket #1: FBFF
    Service data packet #2 for Encryption has 2 subpackets
      Subpacket #0: Version #135290880
      Subpacket #1: UB1: 0
    Service data packet #3 for Data Integrity has 2 subpackets
      Subpacket #0: Version #135290880
      Subpacket #1: UB1: 0
<--- Received 48 bytes - Data packet
Set protocol (TTIPRO)
  Operation 01 (con) Receive protocol version=6
  Destination platform: SVR4-be-8.1.0
---> Send 156 bytes - Data packet
Set protocol (TTIPRO)
  Operation 01 (con) Send protocol version=6
  Originating platform: SVR4-be-8.1.0
<--- Received 49 bytes - Data packet
Set datatypes (TTIDTY)
---> Send 38 bytes - Data packet
```

```

Set datatypes (TTIDTY)
<--- Received 245 bytes - Data packet
Start of user function (TTIFUN)
    Get the session key (OSESKEY)
---> Send 161 bytes - Data packet
Return opi parameter (TTIRPA)
...
*****
*                               Trace Assistant has completed                               *
*****

```

## 16.7.5.5 Statistics Example

The type of statistics gathered is approximately the number of TTC calls, packets, and bytes sent and received between the network partners. [Example 16-21](#) shows typical trace file statistics from the `-s` option.

### Example 16-21 trcasst -s Output

```

*****
*                               Trace Assistant                               *
*****
-----
Trace File Statistics:
-----
Total number of Sessions: 3

DATABASE:
  Operation Count:    0 OPENS,    21 PARSES,    21 EXECUTES,    9 FETCHES
  Parse Counts:
    9 PL/SQL,    9 SELECT,    0 INSERT,    0 UPDATE,    0 DELETE,
    0 LOCK,    3 TRANSACT,    0 DEFINE,    0 SECURE,    0 OTHER
  Execute counts with SQL data:
    9 PL/SQL,    0 SELECT,    0 INSERT,    0 UPDATE,    0 DELETE,
    0 LOCK,    0 TRANSACT,    0 DEFINE,    0 SECURE,    0 OTHER

Packet Ratio: 6.142857142857143 packets sent per operation
Currently opened Cursors: 0
Maximum opened Cursors : 0

ORACLE NET SERVICES:
  Total Calls :    129 sent,    132 received,    83 oci
  Total Bytes :    15796 sent,    13551 received
  Average Bytes:    122 sent per packet,    102 received per packet
  Maximum Bytes:    1018 sent,    384 received

Grand Total Packets:    129 sent,    132 received

*****
*                               Trace Assistant has completed                               *
*****

```

## 16.8 Contacting Oracle Support Services

Some messages recommend contacting Oracle Support Services to report a problem. When you contact Oracle Support Services, have the following information available:

- The hardware, operating system, and release number of the operating system running Oracle Database.

- The complete release number of Oracle Database, such as release 12.2.0.1.0.
- All Oracle programs (with release numbers) in use when the error occurred, such as SQL\*Plus release 12.2.0.1.0.
- If you encountered one or more error codes or messages, then the exact code numbers and message text, in the order in which they appeared.
- The problem severity, according to the following codes:
  - 1: Program not usable. Critical effect on operations.
  - 2: Program usable. Operations severely restricted.
  - 3: Program usable with limited functions. Not critical to overall operations.
  - 4: Problem circumvented by customer. Minimal effect, if any, on operations.

You will also be expected to provide the following:

- Your name
- The name of your organization
- Your Oracle Support ID number
- Your telephone number

# Index

## Numerics

---

1521 port, [9-11](#)  
if not using, [9-3](#)

## A

---

access control lists (ACLs)  
described, [3-14](#)  
access control to database  
with Oracle Connection Manager, [1-14](#), [10-6](#)  
with sqlnet.ora parameters, [12-5](#)  
ACTION\_LIST networking parameter, [10-3](#), [10-5](#)  
ADAPTERS utility, [16-8](#)  
Address List Options dialog box, [13-4](#)  
ADDRESS networking parameter, [10-5](#)  
ADR  
See automatic diagnostic repository  
ADR\_BASE log parameter, [16-26](#), [16-27](#)  
ADR\_BASE\_listener\_name log parameter, [16-26](#)  
ADRCI, [16-5](#)  
application web servers, [1-4](#)  
application Web servers, [1-4](#)  
architecture  
Oracle Connection Manager, [5-6](#)  
attributes  
defined, [3-5](#)  
audit trail  
described, [16-30](#)  
script for using information, [16-31](#)  
auto-starting listeners, [9-15](#)  
automatic diagnostic repository, [16-1](#)

## B

---

BACKUP networking parameter, [13-17](#)  
Bequeath protocol, [2-11](#)  
BEQUEATH\_DETACH networking parameter,  
[12-8](#)  
buffer flushing, described, [1-11](#)

## C

---

centralized naming, [3-1](#)  
establishing a connection with, [3-1](#)

Check TCP/IP client access rights option in  
Oracle Net Manager, [12-5](#)  
client configuration  
connect-time failover, [2-18](#)  
default domains, [12-2](#)  
load balancing requests among listeners,  
[2-19](#), [13-4](#)  
local naming, [8-17](#)  
log files, [16-26](#)  
network service names, [6-6](#)  
Oracle Connection Manager address, [10-6](#)  
Oracle Rdb connections, [13-35](#)  
shared server, [11-4](#)  
sqlnet.log file, [16-26](#)  
trace files, [16-41](#)  
Transparent Application Failover (TAF), [2-18](#)  
client connections  
syntax, [2-17](#)  
client load balancing  
configuring, [13-4](#)  
described, [2-19](#)  
Client Registration ID field in Oracle Net  
Manager, [12-7](#)  
client troubleshooting, [16-8](#)  
client-server connections  
routing, [14-12](#)  
Clients allowed to access field in Oracle Net  
Manager, [12-5](#)  
Clients excluded from access field in Oracle Net  
Manager, [12-5](#)  
CMADMIN (Connection Manager Administration),  
[5-6](#)  
CMAN DISPATCHERS parameter, [10-9](#)  
See also DISPATCHERS parameter  
cman.log file, [16-25](#)  
cman.ora file  
log parameters  
ADR\_BASE, [16-27](#)  
DIAG\_ADR\_ENABLED, [16-27](#)  
EVENT\_GROUP, [16-27](#)  
LOG\_DIRECTORY, [16-27](#)  
LOG\_LEVEL, [16-28](#)  
parameters  
ACTION\_LIST, [10-3](#), [10-5](#)  
ADDRESS, [10-5](#)



- cman.ora file (*continued*)
    - parameters (*continued*)
      - RULE\_LIST, [10-6](#)
    - setting up, [10-4](#)
    - trace parameters
      - TRACE\_DIRECTORY, [16-39](#)
      - TRACE\_FILELEN, [16-39](#)
      - TRACE\_FILENO, [16-39](#)
      - TRACE\_LEVEL, [16-39](#)
      - TRACE\_TIMESTAMP, [16-39](#)
  - CMGW (Connection Manager Gateway), [5-6](#)
  - COLOCATION\_TAG Parameter, [13-14](#)
  - configure
    - Oracle Connection Manager in Traffic Director Mode, [10-17](#)
    - Secure Sockets Layer, [10-5](#), [10-16](#)
  - configuring
    - access control, [10-6](#), [12-5](#)
    - client
      - Exadirect, [14-10](#)
    - clients
      - client load balancing, [13-4](#)
      - connect-time failover, [2-18](#), [13-4](#)
      - default domains, [12-2](#)
      - local naming, [8-17](#)
      - naming methods in profile, [12-3](#)
      - network service names, [6-6](#)
      - Transparent Application Failover (TAF), [2-18](#)
    - connect-request timeouts, [14-10](#)
    - connection load balancing, [13-8](#)
    - connection requests in a profile, [12-4](#)
    - database client
      - Exadirect, [14-10](#)
    - database servers
      - access control, [12-5](#)
      - connect-request timeouts, [14-10](#)
      - Exadirect, [14-10](#)
      - session data unit (SDU), [14-7](#), [14-8](#)
      - shared server, [11-1](#)
    - directory naming, [8-24](#)
    - Easy Connect naming, [8-1](#)
    - Exadirect protocol, [14-9](#)
    - external naming, [8-37](#)
    - Heterogeneous Services connections, [13-33](#)
    - instance role, [13-20](#)
    - listeners, [9-1](#)
      - connect-request timeouts, [14-10](#)
      - directory naming, [8-24](#)
      - external procedures, [13-31](#)
      - local naming, [8-17](#)
      - queue size, [9-12](#)
      - service information, [13-23](#)
    - local naming, [8-16](#)
    - localized management, [3-1](#)
  - configuring (*continued*)
    - multiple protocol addresses, [13-1](#)
    - naming methods, [8-1](#)
    - network domain, default, [12-2](#)
    - network service aliases, [8-24](#)
    - network service names
      - directory naming, [8-24](#)
      - external naming, [8-37](#)
      - local naming, [8-18](#)
    - Oracle Advanced Security, [12-10](#)
    - Oracle Rdb database connections, [13-35](#)
    - primary and secondary instances, [13-20](#)
    - protocol addresses, [9-11](#)
    - quick reference, [7-9](#)
    - SDP protocol, [14-6](#)
    - servers
      - connect-request timeouts, [14-10](#)
      - Exadirect, [14-10](#)
      - session data unit (SDU), [14-7](#), [14-8](#)
      - shared server, [11-1](#)
      - service registration, [10-8](#), [10-13](#)
      - session data unit (SDU) size, [13-7](#)
      - session multiplexing, [10-9](#)
  - connect identifiers, [2-17](#)
  - connect-time failover
    - and GLOBAL\_DNAME parameter, [13-25](#)
    - configuring, [13-4](#)
    - service registration, [9-2](#)
  - connection broker, [2-13](#)
  - connection load balancing, [13-8](#)
  - configuring
    - dedicated server, [13-12](#)
    - shared server, [13-9](#)
  - described, [2-19](#)
  - service registration, [9-2](#)
  - Connection Time Out field in Oracle Net Manager, [12-7](#)
  - connections, [2-9](#)
    - adjusting listener queue size to avoid errors, [1-10](#), [9-12](#)
    - bequeath, [2-11](#)
    - concurrent, increasing number of, [9-12](#)
    - connect strings, entering, [2-17](#)
    - dedicated servers, [12-4](#)
    - directory naming, [8-24](#)
    - Heterogeneous Services, [13-33](#)
    - local naming, [8-17](#)
    - NIS external naming, [8-37](#)
    - Oracle Connection Manager, [12-4](#)
    - Oracle Rdb databases, [13-35](#)
  - CONNECTIONS (CON or CONN) attribute, [11-2](#)
- ## D
- 
- data transfer, maximizing, [1-10](#)

- data-dependent routing
  - configuring, [14-12](#)
  - database requests, [14-12](#)
- database resident connection pooling, [2-13](#)
- database server configuration
  - access control, [12-5](#)
  - allocating resources with shared server, [11-2](#)
  - connect-request timeouts, [14-10](#)
  - local naming, [8-18](#)
  - log files, [16-26](#)
  - loopback tests, [16-6](#)
  - shared server, [11-1](#)
  - trace files, [16-41](#)
- database server connections
  - syntax, [2-17](#)
- dedicated connection, [2-13](#)
- dedicated server
  - configuring, [11-4](#)
- dedicated servers
  - bequeathed sessions, [2-11](#)
  - connect descriptor configuration, [2-9](#)
  - defined, [1-7](#)
  - described, [2-11](#), [2-12](#), [5-4](#)
  - difference with shared server, [1-7](#)
  - routing connections, [12-4](#)
- denial-of-service attacks, [14-10](#)
- DIAG\_ADR\_ENABLED log parameter, [16-26](#), [16-27](#)
- DIAG\_ADR\_ENABLED\_listener\_name log parameter, [16-27](#)
- diagnosing
  - See troubleshooting
- direct hand-off
  - described, [2-10](#)
  - events in listener.log, [16-33](#)
- directory configuration
  - adding users to the OracleNetAdmins group, [7-6](#)
  - exporting
    - network service names from a tnsnames.ora file, [8-33](#)
  - migrating
    - network service names from a tnsnames.ora file, [8-33](#)
- directory information tree (DIT), defined, [3-3](#)
- directory naming, [16-20](#)
  - advantages and disadvantages, [2-16](#)
  - architecture, [3-3](#)
  - authentication methods
    - native, [3-13](#)
    - simple, [3-13](#)
    - SSL, [3-13](#)
    - strong, [3-13](#)
  - configuring, [8-24](#)
  - connecting to database services, [3-12](#)
- directory naming (*continued*)
  - connecting with, [8-24](#)
  - connections
    - using the fully-qualified name of an entry, [3-8](#)
    - using the relative name of an entry, [3-7](#)
  - establishing a connection with, [8-24](#)
  - exporting
    - network service names from a tnsnames.ora file, [8-33](#)
  - fully-qualified naming, [3-8](#)
  - Java Database Connectivity (JDBC)
    - OCI drivers, [3-7](#), [3-8](#)
    - Thin drivers, [3-7](#), [3-8](#)
  - Java Database Connectivity (JDBC) Thin drivers, [3-3](#), [3-8](#)
  - listener configuration for, [8-24](#)
  - migrating
    - network service names from a tnsnames.ora file, [8-33](#)
  - object classes, [3-16](#)
  - objects
    - database services, [3-4](#)
    - network service aliases, [3-9](#)
    - network service names, [3-4](#)
  - Oracle Context, [3-8](#)
  - Oracle Net Manager, [3-11](#)
  - Oracle schema, [3-16](#)
  - OracleContextAdmins group, [3-11](#), [3-14](#)
  - OracleDBCreators group, [3-11](#), [3-14](#)
  - OracleNetAdmins group, [3-15](#), [7-6](#), [8-25](#), [8-27](#), [8-29](#)
  - overview, [3-2](#)
  - recommended for, [2-16](#)
  - security, [3-13](#)
  - troubleshooting, [16-20](#)
  - with relative naming, [3-7](#)
- Directory Server Migration Wizard, [7-4](#), [8-35](#)
- directory servers
  - attributes, [3-5](#)
  - directory information tree (DIT), [3-3](#)
  - distinguished name (DN), [3-5](#)
  - entry, [3-3](#)
  - Microsoft Active Directory, [3-17](#)
  - Oracle Context, [3-8](#)
  - overview, [1-6](#)
  - performance, [3-13](#)
  - relative distinguished name (RDN), [3-5](#)
  - security, [3-13](#)
- Directory Usage configuration option in Oracle Net Configuration Assistant, [7-6](#)
- Disable Out-of-Band Break option in Oracle Net Manager, [12-9](#)
- DISABLE\_OOB networking parameter, [12-9](#)

dispatchers, [1-7](#), [5-4](#)  
 described, [1-7](#), [2-10](#), [5-4](#)  
 DISPATCHERS (DIS or DISP) attribute, [11-2](#)  
 DISPATCHERS initialization parameter, [11-1](#)  
   CONNECTIONS attribute, [11-2](#)  
   DISPATCHERS attribute, [11-2](#)  
   LISTENER attribute, [9-4](#), [9-6](#), [11-2](#)  
   MULTIPLEX attribute, [11-2](#)  
   SESSIONS attribute, [11-2](#)  
 DISPATCHERS parameter, [10-9](#)  
   MULTIPLEX attribute, [10-9](#)  
   PROTOCOL attribute, [10-9](#)  
 distinguished name (DN), defined, [3-5](#)  
 duties of a network administrator, [7-9](#)  
 dynamic registration, [2-13](#)

## E

---

easy connect naming  
 advantages and disadvantages, [2-16](#)  
 recommended for, [2-16](#)  
 syntax examples, [8-5](#)  
 Easy Connect naming  
 configuring, [8-1](#)  
 Easy Connect Plus, [8-3](#)  
 enabling  
   external password store, [10-12](#)  
 entry, defined, [3-3](#)  
 Environment field in Oracle Net Manager, [13-27](#)  
 ENVS networking parameter, [13-27](#)  
 error messages  
   contacting Oracle Support Services, [16-65](#)  
   in trace file, [16-48](#)  
   ORA-12154, [16-12](#)  
   ORA-12170, [14-11](#), [16-14](#)  
   ORA-12203  
     sample error stack, [16-24](#)  
   ORA-12514, [16-16](#)  
   ORA-12520, [16-16](#)  
   ORA-12521, [16-17](#)  
   ORA-12525, [14-11](#), [16-17](#)  
   ORA-12526, [5-4](#)  
   ORA-12527, [5-4](#)  
   ORA-12528, [5-4](#)  
   ORA-12533, [16-18](#)  
   ORA-12535, [12-6](#)  
   ORA-12547, [14-11](#)  
   ORA-12608, [12-7](#)  
   ORA-12609, [12-6](#)  
   ORA-12637, [14-11](#)  
   resolving, [16-1](#)  
   using log file to track, [16-30](#)  
 error stack  
   described, [16-23](#)  
   entries in log files, [16-30](#)

error stack (*continued*)  
   sample, [16-24](#)  
   typical layers in, [16-23](#)  
 EVENT\_GROUP log parameter, [16-27](#)  
 Exadirect protocol  
   configuring, [14-9](#)  
 exporting  
   network service names from a tnsnames.ora  
     file to a directory, [8-33](#)  
 external naming  
   advantages and disadvantages, [2-16](#)  
   configuring, [8-37](#)  
   network information service, [2-16](#)  
   NIS, [12-4](#)  
   recommended for, [2-16](#)  
 external password store  
   enabling, [10-12](#)  
 EXTPROC\_DLLS environment variable, [13-27](#)

## F

---

failover  
   connect-time, [2-18](#), [13-4](#)  
   Transparent Application Failover (TAF), [2-18](#),  
     [13-15](#)  
 FAILOVER networking parameter, [13-4](#), [13-13](#)  
 FAILOVER\_MODE networking parameter, [13-15](#),  
   [13-17](#)  
 FTP presentation, [4-7](#)  
   dedicated server configuration, [5-6](#)  
   shared server configuration, [5-5](#)  
 FTP protocol, [1-4](#)  
 fully-qualified naming  
   Java Database Connectivity (JDBC)  
     OCI drivers, [3-7](#), [3-8](#)  
     Thin drivers, [3-8](#)  
   with directory naming, [3-8](#)

## G

---

global database name  
   configuring on the listener, [9-3](#)  
   defined, [2-6](#)  
   described, [9-3](#)  
 Global Database Name field in Oracle Net  
 Manager, [13-7](#), [13-24](#), [13-35](#)  
 GLOBAL\_DBNAME parameter, [13-23](#), [13-24](#)  
 GLOBAL\_NAME networking parameter, [13-7](#),  
   [13-35](#)

## H

---

Heterogeneous Services  
   configuring connections to, [13-33](#)

Heterogeneous Services (*continued*)

- described, [13-33](#)

## host naming

- requirements, [8-14](#)

HS networking parameter, [13-7](#)HTTP presentation, [4-7](#)

- dedicated server configuration, [5-6](#)

- shared server configuration, [5-5](#)

HTTP protocol, [1-3](#)

## I

INBOUND\_CONNECT\_TIMEPUT\_*listener\_name*

- networking parameter, [14-10](#)

## InfiniBand network communication

- configuring Exadirect support, [14-9](#)

- configuring SDP protocol support, [14-6](#)

## initialization parameter file

- DISPATCHERS parameter, [11-1](#)

- INSTANCE\_NAME parameter, [1-15](#), [2-2](#)

- LOCAL\_LISTENER parameter, [9-4](#), [9-11](#)

- REMOTE\_LISTENER parameter, [9-5](#), [9-7](#)

- SERVICE\_NAMES parameter, [2-4](#), [2-6](#)

## installation

- default configuration

- listeners, [9-10](#)

- local naming, [8-17](#)

- profiles, [12-1](#)

Instance Name field in Oracle Net Manager, [13-6](#)instance role configuration, [13-20](#)

- connections in TAF, [13-20](#)

- connections to primary and secondary

- instances, [13-20](#)

- connections to specific instances, [13-20](#)

INSTANCE\_NAME networking parameter, [1-15](#),

- [2-2](#), [2-6](#), [13-6](#), [13-20](#)

## IPv6

- addresses, [4-8](#), [4-9](#)

- configurations, [4-10](#)

- connect descriptors, [2-7](#)

- network protocol, [4-5](#)

- Oracle Database components, [4-12](#)

- TCP/IP protocol, [4-7](#)

## J

## Java Database Connectivity (JDBC),

- drivers, [1-2](#)

OCI drivers, [4-6](#)

- fully-qualified naming support, [3-7](#), [3-8](#)

- relative naming support, [3-7](#)

Thin drivers, [4-6](#)

- directory naming support, [3-3](#), [3-8](#)

- fully-qualified naming support, [3-8](#)

- relative naming support, [3-7](#)

JavaNet, [4-6](#)JavaNet layer, [1-4](#)JavaTTC, [4-6](#)

## JDBC

- See Java Database Connectivity (JDBC)

## L

LISTENER (LIS or LIST) attribute, [9-4](#), [9-6](#), [11-2](#)

## Listener configuration option in Oracle Net

- Configuration Assistant, [7-6](#)

## Listener Control utility

- commands

- SERVICES, [6-3](#), [9-19](#)

- START, [6-3](#)

- STATUS, [9-18](#)

- starting a listener, [9-15](#)

- stopping a listener, [9-15](#)

- using, [7-8](#)

listener redirects, [9-21](#)listener.log file, [16-24](#), [16-25](#)

## listener.ora file

- log parameters

- ADR\_BASE\_*listener\_name*, [16-26](#)

- DIAG\_ADR\_ENABLED\_*listener\_name*, [16-27](#)

- LOG\_DIRECTORY\_*listener\_name*, [16-27](#)

- LOG\_FILE\_*listener\_name*, [16-27](#)

- parameters

- ENVS, [13-27](#)

- GLOBAL\_DBNAME, [13-24](#)

- INBOUND\_CONNECT\_TIMEOUT\_*listener\_name*, [14-10](#)

- ORACLE\_HOME, [13-24](#), [13-28](#), [13-33](#)

- PROGRAM, [13-26](#), [13-33](#)

- SID\_NAME, [13-24](#), [13-28](#), [13-33](#)

- trace parameters

- TRACE\_DIRECTORY\_*listener\_name*, [16-40](#)

- TRACE\_FILE\_*listener\_name*, [16-40](#)

- TRACE\_FILEAGE\_*listener\_name*, [16-40](#)

- TRACE\_FILEAGE\_SERVER, [16-40](#)

- TRACE\_FILELEN\_*listener\_name*, [16-40](#)

- TRACE\_FILENO\_*listener\_name*, [16-41](#)

- TRACE\_LEVEL\_*listener\_name*, [16-40](#)

- TRACE\_TIMESTAMP\_*listener\_name*, [16-41](#)

listener.trc file, [16-38](#)listeners, [1-18](#), [2-8](#), [13-33](#)

- adjusting queue size for, [9-12](#)

- auto-starting, [9-15](#)

- client load balancing, [2-19](#)

- configuring, [9-1](#)

- address list, [13-1](#)

- directory naming method, [8-24](#)

- external procedures, [13-31](#)

- global database name, [9-3](#)

- local naming method, [8-17](#)

- listeners (*continued*)
    - configuring (*continued*)
      - nondefault address, [9-3](#)
      - Oracle System Identifier, [13-24](#)
      - protocol addresses, [9-11](#)
      - service information, [13-23](#)
      - SID, [13-24](#)
    - connect-time failover, [2-18](#)
    - connection load balancing, [2-19](#), [13-8](#)
    - default address, [9-3](#)
    - default configuration, [9-10](#)
    - direct hand-off, [2-10](#)
    - handling concurrent connections, [9-12](#)
    - increasing queue size, [9-12](#)
    - log files, [9-21](#), [16-26](#), [16-30](#)
      - audit trail, [16-30](#)
      - direct hand-off event information, [16-33](#)
      - service registration event information, [16-32](#)
    - monitoring, [9-18](#), [9-19](#), [9-21](#)
    - multiple addresses, [13-1](#)
    - Oracle Net Listener, [1-18](#)
    - queue size, [1-10](#)
    - redirect connections, [2-10](#)
    - security
      - connect-request timeouts, [14-10](#)
    - trace files, [16-39](#)
    - Transparent Application Failover (TAF), [2-18](#)
  - load balancing
    - client, [2-19](#)
    - connection, [2-19](#), [13-8](#)
  - LOAD\_BALANCE networking parameter, [13-4](#)
  - LOCAL environment variable, [2-17](#)
  - local naming
    - advantages and disadvantages, [2-15](#)
    - client configuration, [8-17](#)
    - configuring, [8-16](#)
    - connecting with, [8-17](#)
    - database server configuration, [8-18](#)
    - default configuration, [8-17](#)
    - establishing a connection with, [8-17](#)
    - listener configuration for, [8-17](#)
    - recommended for, [2-15](#)
  - Local Net Service Name configuration option in
    - Oracle Net Configuration Assistant, [7-6](#)
  - LOCAL registry entry, [2-17](#)
  - LOCAL\_LISTENER initialization parameter, [9-4](#), [9-11](#), [11-2](#)
  - log files, [9-21](#), [16-26](#), [16-30](#)
    - default names for, [16-24](#)
    - listener.log, [16-24](#), [16-26](#)
    - Oracle Connection Manager, [16-34](#)
    - segmentation, [16-25](#)
    - sqlnet.log, [16-24](#)
  - log files (*continued*)
    - sqlnet.log for clients and database servers, [16-26](#)
    - using to track errors, [16-30](#)
  - log parameters
    - cman.ora
      - ADR\_BASE, [16-27](#)
      - DIAG\_ADR\_ENABLED, [16-27](#)
      - EVENT\_GROUP, [16-27](#)
      - LOG\_DIRECTORY, [16-27](#)
      - LOG\_LEVEL, [16-28](#)
    - listener.ora
      - ADR\_BASE\_listener\_name, [16-26](#)
      - DIAG\_ADR\_ENABLED\_listener\_name, [16-27](#)
      - LOG\_DIRECTORY\_listener\_name, [16-27](#)
      - LOG\_FILE\_listener\_name, [16-27](#)
    - sqlnet.ora
      - ADR\_BASE, [16-26](#)
      - DIAG\_ADR\_ENABLED, [16-26](#)
      - LOG\_DIRECTORY\_CLIENT, [16-26](#)
      - LOG\_DIRECTORY\_SERVER, [16-26](#)
      - LOG\_FILE\_CLIENT, [16-26](#)
      - LOG\_FILE\_SERVER, [16-26](#)
  - LOG\_DIRECTORY log parameter, [16-27](#)
  - LOG\_DIRECTORY\_CLIENT log parameter, [16-26](#)
  - LOG\_DIRECTORY\_listener\_name log parameter, [16-27](#)
  - LOG\_DIRECTORY\_SERVER log parameter, [16-26](#)
  - LOG\_FILE\_CLIENT log parameter, [16-26](#)
  - LOG\_FILE\_listener\_name log parameter, [16-27](#)
  - LOG\_FILE\_SERVER log parameter, [16-26](#)
  - LOG\_LEVEL log parameter, [16-28](#)
  - Ligon Authentication Protocol Version field in
    - Oracle Net Manager, [12-8](#)
  - loopback test, [16-6](#)
  - LREG process, [9-2](#), [10-9](#), [16-32](#)
- ## M
- 
- maximizing data transfer, by adjusting SDU size, [1-10](#)
  - METHOD networking parameter, [13-17](#)
  - Microsoft Active Directory, [3-17](#)
  - migrating
    - network service names from a tnsnames.ora file to a directory, [8-33](#)
  - multiple addresses, [13-4](#)
    - configuring client load balancing, [13-5](#)
    - configuring connect-time failover, [13-5](#)
  - multiple protocol addresses, [13-1](#)
  - MULTIPLEX (MUL or MULT) attribute, [10-9](#), [11-2](#)

## N

---

Named Pipes protocol  
described, [4-13](#)

NAMES.DEFAULT\_DOMAIN networking  
parameter, [12-3](#)

NAMES.DIRECTORY\_PATH networking  
parameter, [12-4](#)

ezconnect, [12-4](#)

hostname, [12-4](#)

ldap, [12-3](#)

nis, [12-4](#)

tnsnames, [12-3](#)

naming method, [12-3](#)

naming methods, [2-16](#)  
described, [2-15](#)  
directory naming, [8-24](#)  
Easy Connect naming, [8-1](#)  
external naming, [8-37](#)  
local naming, [8-16](#)  
localized, [3-1](#)  
overview, [1-6](#)

Naming Methods configuration option in Oracle  
Net Configuration Assistant, [7-6](#)

Net Service Name Wizard, [7-3](#), [8-20](#), [10-6](#)

net service names  
testing with TNSPING, [15-4](#)

network administrator duties, [7-9](#)

Network Authentication (NA)  
layer in error stacks, [16-23](#)

network availability, determining, [6-2](#)

network configuration  
centralized management, [3-1](#)  
localized management, [3-1](#)

network domain, default configuring, [12-2](#)

network information service  
See NIS

Network Interface (NI)  
layer in error stacks, [16-23](#)

network performance, improving  
by adjusting SDU size, [1-10](#)  
client load balancing, [2-19](#)  
listener queue size, [1-10](#)

network planning  
session data unit (SDU) size, [1-10](#)

network service aliases  
configuring, [8-24](#)  
described, [3-9](#)  
directory naming, [3-9](#)  
uses of, [3-10](#)

network service names  
configuring, [6-6](#)  
directory naming, [8-24](#)  
external naming, [8-37](#)  
local naming, [8-18](#)

network service names (*continued*)  
multiple addresses, [13-1](#), [13-4](#)  
prioritizing naming methods, [12-3](#)  
testing with TNSPING, [15-3](#)

Network Session (NS), layer in error stacks,  
[16-23](#)

Network Transport (NT), layer in error stacks,  
[16-23](#)

networking planning  
internal networks  
availability, [1-12](#)  
client load balancing, [1-12](#)  
connect-time failover, [1-12](#)

networkservice names  
adding an address, [13-1](#)

NIS external naming, [2-16](#), [12-4](#)  
configuring, [8-37](#)  
connecting with, [8-37](#)  
establishing a connection with, [8-37](#)  
maps, [8-38](#)

## O

---

object classes  
described, [3-16](#)

Open Systems Interconnection (OSI)  
described, [4-2](#)

ORA-12154 error message, [16-12](#)

ORA-12170 error message, [14-11](#), [16-14](#)

ORA-12203 error message  
sample error stack, [16-24](#)

ORA-12514 error message, [16-16](#)

ORA-12520 error message, [16-16](#)

ORA-12521 error message, [16-17](#)

ORA-12525 error message, [14-11](#), [16-17](#)

ORA-12526 error messages, [5-4](#)

ORA-12527 error messages, [5-4](#)

ORA-12528 error messages, [5-4](#)

ORA-12533 error message, [16-18](#)

ORA-12535 error message, [12-6](#), [12-7](#)

ORA-12547 error message, [14-11](#)

ORA-12637 error message, [14-11](#)

Oracle Advanced Security  
configuring with Oracle Net Manager, [12-10](#)  
overview, [1-20](#)

Oracle Call Interface (OCI) layer, described, [4-4](#)

Oracle Clusterware  
notification information, [16-34](#)

Oracle Connection Manager  
architecture, [5-6](#)  
CMADMIN process, [5-6](#)  
configure  
Secure Sockets Layer, [10-5](#)  
configuring  
access control, [10-6](#)

- Oracle Connection Manager (*continued*)
  - configuring (*continued*)
  - clients, [10-6](#)
  - database server, [10-8](#), [10-9](#)
  - Oracle Connection Manager computer, [10-4](#)
  - protocol address for Oracle Connection Manager, [10-6](#)
  - service registration, [10-8](#)
  - session multiplexing, [10-9](#)
- gateway process, [5-6](#)
- listener, [5-6](#)
- log files, [16-27](#)
  - names, [16-24](#)
  - understanding, [16-34](#)
- overview, [1-18](#)
- routing connections, [12-4](#)
- session multiplexing, [5-6](#)
- trace files, [16-39](#)
  - configuring, [16-44](#)
  - names, [16-38](#)
- Oracle Connection Manager Control utility
  - using, [10-20](#)
- Oracle Connection Manager in Traffic Director Mode, [10-21](#)
  - configure
    - Secure Sockets Layer, [10-16](#)
  - configuring, [10-10](#)
    - Oracle Connection Manager computer, [10-10](#)
    - service registration, [10-13](#)
  - configuring proxy resident connection pools, [10-13](#)
  - enabling
    - external password store, [10-12](#)
  - restrictions
    - Oracle Connection Manager in Traffic Director Mode Restrictions, [10-17](#)
- Oracle Context
  - defined, [3-8](#)
- Oracle Home Directory field in Oracle Net Manager, [13-24](#), [13-28](#)
- Oracle Net
  - buffers, [1-10](#), [1-11](#)
  - defined, [1-16](#)
  - Oracle Net foundation layer, [1-16](#)
  - Oracle protocol support, [1-17](#)
  - overview, [1-1](#)
  - scalability features, [1-7](#)
  - shared server, [1-7](#)
  - understanding, [1-1](#)
- Oracle Net Configuration Assistant
  - described, [7-5](#)
  - Directory Usage configuration option, [7-6](#)
- Oracle Net Configuration Assistant (*continued*)
  - listener configuration, [9-10](#)
  - Listener configuration option, [7-6](#)
  - local naming method, [8-22](#)
  - Local Net Service Name configuration option, [7-6](#)
  - Naming Methods configuration option, [7-6](#)
  - network service names, [8-22](#)
  - OracleContextAdmins group, [3-14](#)
  - OracleDBCreators group, [3-11](#), [3-14](#)
  - OracleNetAdmins group, [3-15](#)
  - servers
    - listener configuration, [7-6](#)
    - starting, [7-5](#)
- Oracle Net foundation layer, [1-16](#), [4-4](#)
- Oracle Net Listener, [1-18](#)
  - described, [1-18](#)
  - starting, [6-2](#)
    - See also listeners
- Oracle Net Manager
  - adding addresses, [13-1](#)
  - Address List Options dialog box, [13-4](#)
  - clients
    - client load balancing, [13-4](#)
    - connect-time failover, [13-4](#)
    - default network domains, [12-2](#)
    - local naming method, [8-18](#), [8-20](#)
    - Oracle Connection Manager, [10-6](#)
  - described, [7-2](#)
  - directory naming, [3-11](#)
  - Directory Server Migration Wizard, [8-35](#)
  - Heterogeneous Services connections, [13-33](#)
  - Instance Name field, [13-6](#)
  - listeners
    - Environment field, [13-27](#)
    - Global Database Name field, [13-7](#), [13-24](#)
    - Oracle Home Directory field, [13-24](#), [13-28](#)
    - Oracle System Identifier field, [13-28](#)
    - Program Name field, [13-26](#)
    - protocol addresses, [9-11](#)
    - SID field, [13-24](#)
    - static service information, [13-23](#)
  - local naming method, [8-18](#), [8-20](#)
  - multiple address options, [13-4](#)
  - navigating, [7-3](#)
  - Net Service Name Wizard, [8-20](#), [10-6](#)
  - network service aliases, [8-24](#)
  - network service names, [8-18](#), [8-20](#)
  - Oracle Rdb Database field, [13-7](#)
  - Oracle Rdb databases, [13-35](#)
    - Global Database Name field, [13-35](#)
    - Rdb Database field, [13-35](#)
    - Type of Service field, [13-35](#)

- Oracle Net Manager (*continued*)
    - profiles, [12-10](#)
      - advanced options, [12-6](#)
      - Check TCP/IP client access rights option, [12-5](#)
      - Client Registration ID field, [12-7](#)
      - Clients allowed to access field, [12-5](#)
      - Clients excluded from access field, [12-5](#)
      - Connection Time Out field, [12-7](#)
      - Disable Out-of-Band Break option, [12-9](#)
      - Logon Authentication Protocol Version field, [12-8](#)
      - Receive operation Time Out field, [12-7](#)
      - Send operation Time Out field, [12-6](#)
      - TNS Time Out Value option, [12-7](#)
      - Total Receive Buffer field, [12-7](#)
      - Total Send Buffer field, [12-7](#)
      - Turn Off UNIX Signal Handling option, [12-8](#)
    - routing connection requests, [12-4](#)
    - session data unit (SDU) field in Oracle Net Manager, [13-7](#)
    - specifying naming methods, [12-3](#)
    - starting, [7-3](#)
    - Type of Service field, [13-7](#)
    - Use for Heterogeneous Services option, [13-7](#), [13-34](#)
    - wizards, [7-3](#)
  - Oracle Net Services
    - components
      - Oracle Connection Manager, [1-18](#)
      - Oracle Net, [1-16](#)
      - Oracle Net Listener, [1-18](#)
    - described, [1-16](#)
  - Oracle protocol support
    - described, [1-17](#), [4-5](#)
    - Named Pipes, [4-13](#)
    - TCP/IP, [4-7](#)
    - TCP/IP with SSL, [4-12](#)
    - websocket protocol, [4-13](#)
  - Oracle Rdb database
    - configuring for connection to, [13-35](#)
    - described, [13-35](#)
  - Oracle Rdb Database field in Oracle Net Manager, [13-7](#)
  - Oracle Real Application Clusters
    - connect-time failover, [2-18](#)
  - Oracle schema
    - described, [3-16](#)
  - Oracle Support Services
    - contacting, [16-65](#)
  - Oracle System Identifier (SID) field in Oracle Net Manager, [13-28](#)
  - Oracle System Identifier, configuring on the listener, [13-24](#)
  - ORACLE\_HOME networking parameter, [13-24](#), [13-28](#), [13-33](#)
  - Oracle9i Real Application Clusters
    - connect-time failover, [13-4](#)
    - FAILOVER networking parameter, [13-4](#)
    - FAILOVER\_MODE networking parameter, [13-17](#)
    - Transparent Application Failover (TAF), [13-15](#)
  - OracleContextAdmins group, [3-11](#), [3-14](#)
  - OracleDBCreators group, [3-11](#), [3-14](#)
  - OracleHOME\_NAMECMan service, [6-5](#)
  - OracleNetAdmins group, [3-15](#), [7-6](#), [8-25](#), [8-27](#), [8-29](#)
  - OSI
    - See Open Systems Interconnect (OSI)
- 
- ## P
- packets
    - examining trace data, [16-53](#), [16-62](#)
    - types of, [16-47](#)
  - planning
    - internal networks
      - availability, [1-12](#)
      - connect-time failover, [1-12](#)
      - session data unit (SDU) size, [1-10](#)
  - pooled servers, [2-13](#)
  - port 1521
    - if not using, [9-3](#)
  - ports
    - privileged, [9-11](#)
  - presentation layer
    - FTP, [4-7](#)
    - HTTP, [4-7](#)
    - JavaTTC, [4-6](#)
    - Two-Task Common (TTC), [4-4](#)
    - WebDAV, [4-7](#)
  - primary and secondary instances, [13-20](#)
  - privileged ports, [9-11](#)
  - profiles (sqlnet.ora)
    - configuring
      - advanced options, [12-6](#)
      - default domains, [12-2](#)
      - default configuration, [12-1](#)
      - naming methods, specifying, [12-3](#)
      - routing connection requests, [12-4](#)
  - Program Name field in Oracle Net Manager, [13-26](#)
  - PROGRAM networking parameter, [13-26](#), [13-33](#)
  - PROTOCOL (PRO or PROT) attribute, [10-9](#)
  - protocol address, [2-8](#)
  - protocols
    - FTP, [1-4](#)
    - HTTP, [1-3](#), [1-4](#)



protocols (*continued*)  
 Named Pipes, [4-13](#)  
 Oracle support for, [1-17](#)  
 TCP/IP, [4-7](#)  
 TCP/IP with SSL, [4-12](#)  
 WebDAV, [1-4](#)  
 websocket, [4-13](#)  
 Proxy Authentication  
   configuring  
     Oracle Connection Manager in Traffic Director Mode, [10-13](#)  
 proxy server, [10-1](#)

## Q

---

queue size, [1-10](#), [9-12](#)  
 QUEUE\_SIZE parameter, [9-12](#)  
   for adjusting listener queue size, [1-10](#), [9-12](#)

## R

---

randomizing requests among listeners, [2-19](#)  
 Rdb Database field, [13-35](#)  
 RDB\_DATABASE networking parameter, [13-7](#), [13-35](#)  
 Receive operation Time field in Oracle Net Manager, [12-7](#)  
 redirect connection, [2-10](#)  
 relative distinguished name (RDN), [3-5](#)  
 relative naming  
   directory naming, [3-7](#)  
   Java Database Connectivity (JDBC)  
     OCI drivers, [3-7](#)  
     Thin drivers, [3-7](#)  
 request queue, [5-5](#)  
 resolving  
   errors  
     See troubleshooting, [16-1](#)  
 response queue, [5-5](#)  
 Restrictions on Connection Manager in Traffic Director Mode  
   with Connection Manager in Traffic Director Mode, [10-17](#)  
 routing  
   key value, [14-12](#)  
 routing connections, [12-4](#)  
 RULE\_LIST networking parameter, [10-6](#)

## S

---

SDP protocol  
   configuring, [14-6](#)  
 Secure Sockets Layer on CMAN  
   with Oracle Connection Manager, [10-5](#)

Secure Sockets Layer on Connection Manager in Traffic Director Mode  
   with Connection Manager in Traffic Director Mode, [10-16](#)  
 security  
   database server  
     access control configuration, [12-5](#)  
     connect-request timeouts, [14-10](#)  
   listeners  
     connect-request timeouts, [14-10](#)  
 Send operation Time field in Oracle Net Manager, [12-6](#)  
 server configuration  
   access control, [12-5](#)  
   allocating resources with shared server, [11-2](#)  
   connect-request timeouts, [14-10](#)  
   local naming, [8-18](#)  
   log files, [16-26](#)  
   loopback tests, [16-6](#)  
   shared server, [11-1](#)  
   trace files, [16-41](#)  
 server connections  
   syntax, [2-17](#)  
 SERVER networking parameter, [2-9](#)  
 server troubleshooting, [16-6](#)  
 servers  
   access control, [12-5](#)  
 service handlers  
   dedicated servers, [2-11](#), [5-4](#)  
   dispatchers, [2-10](#)  
 service name  
   configuring, [2-6](#)  
   described, [2-3](#), [2-4](#)  
 service registration  
   benefits, [9-2](#)  
   configuring, [10-8](#), [10-13](#)  
   connect-time failover, [9-2](#)  
   connection load balancing, [2-19](#), [9-2](#), [13-8](#)  
   defined, [2-8](#)  
   events in listener.log, [16-32](#)  
   service\_died listener log event, [16-32](#)  
   service\_register listener log event, [16-32](#)  
   service\_update listener log event, [16-32](#)  
 service\_died listener log event, [16-32](#)  
 SERVICE\_NAME networking parameter, [2-6](#)  
 SERVICE\_NAMES initialization parameter, [2-4](#), [2-6](#)  
 service\_register listener log event, [16-32](#)  
 service\_update listener log event, [16-32](#)  
 SERVICES command, [9-19](#)  
   of Listener Control utility, [6-3](#), [9-19](#)  
 session data unit (SDU), [1-10](#), [1-11](#), [13-7](#)  
   adjusting to improve network performance, [1-10](#)  
   configuring, [14-1](#)

- session data unit (SDU) (*continued*)
  - field in Oracle Net Manager, [13-7](#)
- session multiplexing, [1-9](#), [5-6](#), [10-9](#)
- SESSIONS (SES or SESS) attribute, [11-2](#)
- shared server
  - allocating resources, [11-2](#)
  - compared with dedicated server, [1-7](#)
  - configuring, [11-4](#)
  - connect descriptor configuration parameters, [2-9](#)
  - connection load balancing, [2-19](#), [13-8](#)
  - defined, [1-7](#)
  - described, [5-4](#)
  - dispatchers, [1-7](#), [2-10](#), [5-4](#)
  - request queue, [5-5](#)
  - response queue, [5-5](#)
  - virtual circuits, [5-4](#)
- SID field in Oracle Net Manager, [13-24](#)
- SID\_LIST\_listener\_name parameter, [13-23](#)
  - external procedures, [13-32](#)
- SID\_NAME networking parameter, [13-24](#), [13-28](#), [13-33](#)
- SID, configuring on the listener, [13-24](#)
- simple authentication for directory naming, [3-13](#)
- SOURCE\_ROUTE networking parameter, [13-4](#), [13-5](#)
- SQLNET.ALLOWED\_LOGON\_VERSION\_CLIENT networking parameter, [12-8](#)
- SQLNET.ALLOWED\_LOGON\_VERSION\_SERVER networking parameter, [12-8](#)
- SQLNET.CLIENT\_REGISTRATION networking parameter, [12-7](#)
- SQLNET.EXPIRE\_TIME networking parameter, [12-7](#)
- SQLNET.INBOUND\_CONNECT\_TIMEOUT networking parameter, [12-7](#), [14-11](#)
- sqlnet.log file, [16-24](#)
- sqlnet.ora file
  - log parameters
    - ADR\_BASE, [16-26](#)
    - DIAG\_ADR\_ENABLED, [16-26](#)
    - LOG\_DIRECTORY\_CLIENT, [16-26](#)
    - LOG\_DIRECTORY\_SERVER, [16-26](#)
    - LOG\_FILE\_CLIENT, [16-26](#)
    - LOG\_FILE\_SERVER, [16-26](#)
  - parameters
    - NAMES.DEFAULT\_DOMAIN, [12-2](#)
    - NAMES.DIRECTORY\_PATH, [12-3](#)
    - SQLNET.ALLOWED\_LOGON\_VERSION\_CLIENT, [12-8](#)
    - SQLNET.ALLOWED\_LOGON\_VERSION\_SERVER, [12-8](#)
    - SQLNET.INBOUND\_CONNECT\_TIMEOUT, [14-11](#)
    - TCP.EXCLUDED\_NODES, [12-5](#)
    - TCP.INVITED\_NODES, [12-5](#)
- sqlnet.ora file (*continued*)
  - parameters (*continued*)
    - TCP.VALIDNODE\_CHECKING, [12-5](#)
  - trace parameters
    - TNSPING.TRACE\_DIRECTORY, [16-44](#)
    - TNSPING.TRACE\_LEVEL, [16-44](#)
    - TRACE\_DIRECTORY\_CLIENT, [16-41](#)
    - TRACE\_DIRECTORY\_SERVER, [16-42](#)
    - TRACE\_FILE\_CLIENT, [16-42](#)
    - TRACE\_FILE\_SERVER, [16-42](#)
    - TRACE\_FILEAGE\_CLIENT, [16-42](#)
    - TRACE\_FILEAGE\_SERVER, [16-42](#)
    - TRACE\_FILELEN\_CLIENT, [16-42](#)
    - TRACE\_FILELEN\_SERVER, [16-42](#)
    - TRACE\_FILENO\_CLIENT, [16-42](#)
    - TRACE\_FILENO\_SERVER, [16-43](#)
    - TRACE\_LEVEL\_CLIENT, [16-43](#)
    - TRACE\_LEVEL\_SERVER, [16-43](#)
    - TRACE\_TIMESTAMP\_CLIENT, [16-44](#)
    - TRACE\_TIMESTAMP\_SERVER, [16-44](#)
    - TRACE\_UNIQUE\_CLIENT, [16-44](#)
- SQLNET.RECV\_BUF\_SIZE networking parameter, [12-7](#)
- SQLNET.RECV\_TIMEOUT networking parameter, [12-7](#)
- SQLNET.SEND\_BUF\_SIZE networking parameter, [12-7](#)
- SQLNET.SEND\_TIMEOUT networking parameter, [12-6](#)
- sqlnet.trc file, [16-38](#)
- SSL authentication for directory naming, [3-14](#)
- START command
  - of Listener Control utility, [6-3](#), [9-15](#)
- starting
  - databases, [6-2](#)
  - Oracle Net Configuration Assistant, [7-5](#)
  - Oracle Net Listener, [6-2](#)
  - Oracle Net Manager, [7-3](#)
- static service registration, [13-23](#)
- STATUS command
  - of Listener Control utility, [9-18](#)
- STOP command
  - of Listener Control utility, [9-15](#)
- strong authentication for directory naming, [3-14](#)
- svr\_pid.trc file, [16-38](#)
- syntax
  - for connect identifiers, [2-17](#)
  - for Listener Control utility, [7-8](#)
  - for Oracle Connection Manager Control utility, [10-20](#)

---

**T**

- TAF
  - See Transparent Application Failover (TAF)

- TCP.EXCLUDED\_NODES networking
  - parameter, [12-5](#)
- TCP.INVITED\_NODES networking parameter, [12-5](#)
- TCP.VALIDNODE\_CHECKING networking
  - parameter, [12-5](#)
- TCP/IP protocol
  - described, [4-7](#)
- TCP/IP with SSL protocol
  - described, [4-12](#)
- terminated connection detection
  - configuring, [12-7](#)
  - limitations, [12-7](#)
- terminated connection timeout
  - See terminated connection timeout
- testing
  - client configuration
    - with TCROUTE, [15-4](#)
    - with TNSPING, [15-2](#)
  - with control utilities, [7-8](#)
- TNS
  - See Transparent Network Substrate (TNS)
- TNS Time Out Value option in Oracle Net Manager, [12-7](#)
- TNS\_ADMIN environment variable, [3-2](#)
- tnsnames.ora file
  - exporting entries to directory server, [8-33](#)
  - migrating entries to directory server, [8-33](#)
  - parameters
    - BACKUP parameter, [13-17](#)
    - FAILOVER, [13-4](#)
    - FAILOVER\_MODE, [13-17](#)
    - GLOBAL\_NAME, [13-7](#)
    - HS, [13-7](#)
    - INSTANCE\_NAME, [13-6](#), [13-20](#)
    - LOAD\_BALANCE, [13-4](#)
    - METHOD, [13-17](#)
    - RDB\_DATABASE, [13-7](#)
    - SDU, [13-7](#)
    - SOURCE\_ROUTE, [13-4](#), [13-5](#)
    - TYPE, [13-17](#)
    - TYPE\_OF\_SERVICE, [13-7](#)
- TNSPING utility, [15-2](#)
  - compared to TRCROUTE utility, [15-4](#)
- TNSPING.TRACE\_DIRECTORY trace
  - parameter, [16-44](#)
- TNSPING.TRACE\_LEVEL trace parameter, [16-44](#)
- Total Receive Buffer field in Oracle Net Manager, [12-7](#)
- Total Send Buffer field in Oracle Net Manager, [12-7](#)
- Trace Assistant
  - examining trace files with, [16-51](#)
  - functions of, [16-51](#)
- Trace Assistant (*continued*)
  - option reference, [16-51](#)
  - trace data for IDs, [16-62](#)
  - trace data for packets, [16-53](#)
  - trace data statistics, [16-65](#)
- trace files
  - analyzing with Trace Assistant, [16-51](#)
  - default names for, [16-38](#)
  - error message information, [16-48](#)
  - examining with Trace Assistant, [16-51](#)
  - listener.trc, [16-39](#)
  - sqlnet.trc for clients, [16-41](#)
  - svr\_pid.trc for servers, [16-41](#)
- trace parameters
  - cman.ora
    - TRACE\_DIRECTORY, [16-39](#)
    - TRACE\_FILELEN, [16-39](#)
    - TRACE\_FILENO, [16-39](#)
    - TRACE\_LEVEL, [16-39](#)
    - TRACE\_TIMESTAMP, [16-39](#)
  - listener.ora
    - TRACE\_DIRECTORY\_listener\_name, [16-40](#)
    - TRACE\_FILE\_listener\_name, [16-40](#)
    - TRACE\_FILEAGE\_listener\_name, [16-40](#)
    - TRACE\_FILEAGE\_SERVER, [16-40](#)
    - TRACE\_FILELEN\_listener\_name, [16-40](#)
    - TRACE\_FILENO\_listener\_name, [16-41](#)
    - TRACE\_LEVEL\_listener\_name, [16-40](#)
    - TRACE\_TIMESTAMP\_listener\_name, [16-41](#)
  - sqlnet.ora
    - TNSPING.TRACE\_DIRECTORY, [16-44](#)
    - TNSPING.TRACE\_LEVEL, [16-44](#)
    - TRACE\_DIRECTORY\_CLIENT, [16-41](#)
    - TRACE\_DIRECTORY\_SERVER, [16-42](#)
    - TRACE\_FILE\_CLIENT, [16-42](#)
    - TRACE\_FILE\_SERVER, [16-42](#)
    - TRACE\_FILEAGE\_CLIENT, [16-42](#)
    - TRACE\_FILEAGE\_SERVER, [16-42](#)
    - TRACE\_FILELEN\_CLIENT, [16-42](#)
    - TRACE\_FILELEN\_SERVER, [16-42](#)
    - TRACE\_FILENO\_CLIENT, [16-42](#)
    - TRACE\_FILENO\_SERVER, [16-43](#)
    - TRACE\_LEVEL\_CLIENT, [16-43](#)
    - TRACE\_LEVEL\_SERVER, [16-43](#)
    - TRACE\_TIMESTAMP\_CLIENT, [16-44](#)
    - TRACE\_TIMESTAMP\_SERVER, [16-44](#)
    - TRACE\_UNIQUE\_CLIENT, [16-44](#)
- TRACE\_DIRECTORY trace parameter, [16-39](#)
- TRACE\_DIRECTORY\_CLIENT trace parameter, [16-41](#)
- TRACE\_DIRECTORY\_listener\_name trace parameter, [16-40](#)

TRACE\_DIRECTORY\_SERVER trace parameter, [16-42](#)

TRACE\_FILE\_CLIENT trace parameter, [16-42](#)

TRACE\_FILE\_listener\_name trace parameter, [16-40](#)

TRACE\_FILE\_SERVER trace parameter, [16-42](#)

TRACE\_FILEAGE\_CLIENT trace parameter, [16-42](#)

TRACE\_FILEAGE\_listener\_name trace parameter, [16-40](#)

TRACE\_FILEAGE\_SERVER trace parameter, [16-40](#), [16-42](#)

TRACE\_FILELEN trace parameter, [16-39](#)

TRACE\_FILELEN\_CLIENT trace parameter, [16-42](#)

TRACE\_FILELEN\_listener\_name trace parameter, [16-40](#)

TRACE\_FILELEN\_SERVER trace parameter, [16-42](#)

TRACE\_FILENO trace parameter, [16-39](#)

TRACE\_FILENO\_CLIENT trace parameter, [16-42](#)

TRACE\_FILENO\_listener\_name trace parameter, [16-41](#)

TRACE\_FILENO\_SERVER trace parameter, [16-43](#)

TRACE\_LEVEL trace parameter, [16-39](#)

TRACE\_LEVEL\_CLIENT trace parameter, [16-43](#)

TRACE\_LEVEL\_listener\_name trace parameter, [16-40](#)

TRACE\_LEVEL\_SERVER trace parameter, [16-43](#)

TRACE\_TIMESTAMP trace parameter, [16-39](#)

TRACE\_TIMESTAMP\_CLIENT trace parameter, [16-44](#)

TRACE\_TIMESTAMP\_listener\_name trace parameter, [16-41](#)

TRACE\_TIMESTAMP\_SERVER trace parameter, [16-44](#)

TRACE\_UNIQUE\_CLIENT trace parameter, [16-44](#)

Transparent Application Failover (TAF), and GLOBAL\_DBNAME parameter, [13-25](#)

  configuring, [13-15](#)

  GLOBAL\_DBNAME networking parameter in listener.ora, [13-18](#), [13-24](#), [13-25](#)

  overview, [2-18](#)

  with instance role, [13-20](#)

Transparent Network Substrate (TNS), benefits, [4-4](#)

  described, [4-4](#)

TRCROUTE utility described, [15-4](#)

TRCROUTE utility (*continued*)

troubleshooting, [16-1](#)

  client, [16-8](#)

  loopback tests, [16-6](#)

  questions, [16-21](#)

  server, [16-6](#)

TTC

  See Two-Task Common (TTC)

Turn Off UNIX Signal Handling option in Oracle Net Manager, [12-8](#)

TWO\_TASK environment variable, [2-17](#)

Two-Task Common (TTC) presentation

  dedicated server configurations, [5-6](#)

  described, [4-4](#)

  shared server configurations, [5-5](#)

TYPE networking parameter, [13-17](#)

Type of Service field in Oracle Net Manager, [13-7](#), [13-35](#)

TYPE\_OF\_SERVICE networking parameter, [13-7](#), [13-35](#)

## U

Use for Heterogeneous Services option in Oracle Net Manager, [13-7](#), [13-34](#)

## V

V\$SESSION table, [13-20](#)

virtual circuits, [5-4](#)

## W

Wallet

  configuring

    Oracle Connection Manager in Traffic Director Mode, [10-11](#)

WebDAV presentation, [4-7](#)

  dedicated server configurations, [5-6](#)

  shared server configurations, [5-5](#)

WebDAV protocol, [1-4](#)

websocket protocol

  described, [4-13](#)

Windows NT services

  OracleHOME\_NAMEECMan service, [6-5](#)

wizards

  Directory Server Migration, [7-4](#)

  Net Service Name, [7-3](#)

  Oracle Net Manager, [7-3](#)

## Y

ypserv program, [8-37](#)