

Oracle® Retail Enterprise Inventory Cloud Service

Administration Guide

Release 19.1

F32614-06

December 2020

Copyright © 2020, Oracle and/or its affiliates. All rights reserved.

Primary Author: Tracy Gunston

Contributing Author: Bipin Pradhan

This software and related documentation are provided under a license agreement containing restrictions on use and disclosure and are protected by intellectual property laws. Except as expressly permitted in your license agreement or allowed by law, you may not use, copy, reproduce, translate, broadcast, modify, license, transmit, distribute, exhibit, perform, publish, or display any part, in any form, or by any means. Reverse engineering, disassembly, or decompilation of this software, unless required by law for interoperability, is prohibited.

The information contained herein is subject to change without notice and is not warranted to be error-free. If you find any errors, please report them to us in writing.

If this is software or related documentation that is delivered to the U.S. Government or anyone licensing it on behalf of the U.S. Government, then the following notice is applicable:

U.S. GOVERNMENT END USERS: Oracle programs, including any operating system, integrated software, any programs installed on the hardware, and/or documentation, delivered to U.S. Government end users are "commercial computer software" pursuant to the applicable Federal Acquisition Regulation and agency-specific supplemental regulations. As such, use, duplication, disclosure, modification, and adaptation of the programs, including any operating system, integrated software, any programs installed on the hardware, and/or documentation, shall be subject to license terms and license restrictions applicable to the programs. No other rights are granted to the U.S. Government.

This software or hardware is developed for general use in a variety of information management applications. It is not developed or intended for use in any inherently dangerous applications, including applications that may create a risk of personal injury. If you use this software or hardware in dangerous applications, then you shall be responsible to take all appropriate fail-safe, backup, redundancy, and other measures to ensure its safe use. Oracle Corporation and its affiliates disclaim any liability for any damages caused by use of this software or hardware in dangerous applications.

Oracle and Java are registered trademarks of Oracle and/or its affiliates. Other names may be trademarks of their respective owners.

Intel and Intel Xeon are trademarks or registered trademarks of Intel Corporation. All SPARC trademarks are used under license and are trademarks or registered trademarks of SPARC International, Inc. AMD, Opteron, the AMD logo, and the AMD Opteron logo are trademarks or registered trademarks of Advanced Micro Devices. UNIX is a registered trademark of The Open Group.

This software or hardware and documentation may provide access to or information about content, products, and services from third parties. Oracle Corporation and its affiliates are not responsible for and expressly disclaim all warranties of any kind with respect to third-party content, products, and services unless otherwise set forth in an applicable agreement between you and Oracle. Oracle Corporation and its affiliates will not be responsible for any loss, costs, or damages incurred due to your access to or use of third-party content, products, or services, except as set forth in an applicable agreement between you and Oracle.

Value-Added Reseller (VAR) Language

Oracle Retail VAR Applications

The following restrictions and provisions only apply to the programs referred to in this section and licensed to you. You acknowledge that the programs may contain third-party software (VAR applications) licensed to Oracle. Depending upon your product and its version number, the VAR applications may include:

- (i) the **MicroStrategy** Components developed and licensed by MicroStrategy Services Corporation (MicroStrategy) of McLean, Virginia to Oracle and imbedded in the MicroStrategy for Oracle Retail Data Warehouse and MicroStrategy for Oracle Retail Planning & Optimization applications.
- (ii) the **Wavelink** component developed and licensed by Wavelink Corporation (Wavelink) of Kirkland, Washington, to Oracle and imbedded in Oracle Retail Mobile Store Inventory Management.
- (iii) the software component known as **Access Via**™ licensed by Access Via of Seattle, Washington, and imbedded in Oracle Retail Signs and Oracle Retail Labels and Tags.
- (iv) the software component known as **Adobe Flex**™ licensed by Adobe Systems Incorporated of San Jose, California, and imbedded in Oracle Retail Promotion Planning & Optimization application.

You acknowledge and confirm that Oracle grants you use of only the object code of the VAR Applications. Oracle will not deliver source code to the VAR Applications to you. Notwithstanding any other term or condition of the agreement and this ordering document, you shall not cause or permit alteration of any VAR

Applications. For purposes of this section, "alteration" refers to all alterations, translations, upgrades, enhancements, customizations or modifications of all or any portion of the VAR Applications including all reconfigurations, reassembly or reverse assembly, re-engineering or reverse engineering and recompilations or reverse compilations of the VAR Applications or any derivatives of the VAR Applications. You acknowledge that it shall be a breach of the agreement to utilize the relationship, and/or confidential information of the VAR Applications for purposes of competitive discovery.

The VAR Applications contain trade secrets of Oracle and Oracle's licensors and Customer shall not attempt, cause, or permit the alteration, decompilation, reverse engineering, disassembly or other reduction of the VAR Applications to a human perceivable form. Oracle reserves the right to replace, with functional equivalent software, any of the VAR Applications in future releases of the applicable program.

Contents

Send Us Your Comments	xix
Preface	xxi
Audience	xxi
Documentation Accessibility	xxi
Related Documents	xxi
Improved Process for Oracle Retail Documentation Corrections	xxi
Oracle Retail Documentation at the Oracle Help Center	xxii
Conventions	xxii
1 Technical Architecture	
Multiple Products	1-1
Logical Model	1-2
SaaS Deployment	1-2
Cloud Deployment	1-3
EICS Client	1-3
SOCS Mobile Client	1-3
Web Services	1-3
WTSS / IDCS	1-3
EICS Application Server(s)	1-3
OBIEE Server	1-3
SFTP Server	1-3
Oracle DB Server (DBaaS)	1-3
Client-Server Communication	1-3
Integration	1-4
Oracle Retail Integration Bus (RIB)	1-4
SOAP Web Services	1-4
File-Based ..	1-4
Deployment with Other Products	1-4
Deployment - Performance: Bandwidth, Scaling	1-5
Bandwidth Requirements for Browser Clients	1-5
Network Latency Constraints	1-5
Application Server Clustering	1-5
Database Clustering with RAC	1-5

2	Data Seeding	
	What is Data Seeding?	2-1
	Overview of Data Seeding Process	2-1
	Pre-requisites.....	2-2
	Configure EICS for Data Seeding	2-2
	Security Settings	2-2
	Configuration Parameters.....	2-3
	Steps to Enable Data Seeding in EICS UI.....	2-4
	Steps to Manual Control Importers	2-4
	Optional Steps Prior Initial Seeding	2-5
	Run BDI Data Seeding	2-5
	BDI Process Flow Admin Console.....	2-5
	Extractor	2-7
	Downloader	2-7
	Uploader/Receiver	2-8
	Importer.....	2-8
	Import Staging Data to Application Tables	2-9
	Re-running EICS Importer Data Loads	2-9
	BDI-Based Data Seeding Post-Load Processes.....	2-10
3	Reporting	
	EICS Reporting Framework	3-1
	Report Service.....	3-2
	BI Publisher Server.....	3-2
	Report URL Location	3-2
	Previewing a Report.....	3-4
	EICS Operational Reports	3-5
4	Internationalization	
	Supported Locales	4-1
	SOCS Client Translations.....	4-3
	EICS Client Translations	4-3
	EICS Server Translations.....	4-3
	Translation Topics.....	4-3
	Translation Keys.....	4-4
	Translation Setup Screen.....	4-4
	Bundle Selection Dialog	4-4
	Translation Setup Screen.....	4-5
	Translation File Upload	4-7
	Report Translations.....	4-7
5	Batches	
	Batch Overview.....	5-1
	Batch Admin Users.....	5-2
	Batch Configuration.....	5-2
	Operational Batches	5-5

Archive Activity History	5-6
Archive Dump	5-6
Archive RFID History	5-7
Archive Store Item Stock History	5-7
Archive Item Uin History	5-8
Auto Replenish Capacity	5-8
Cleanup Batch Directories	5-9
Cleanup Shelf Replenishment	5-9
DSD Receiving Closure	5-10
Fulfillment Order Pick Reminders	5-10
Fulfillment Order Reminders	5-11
Generate Problem Line Stock Count	5-11
Generate Unit Amount Stock Count	5-12
Generate Unit Stock Count	5-13
Inventory Extract File SFTP Push	5-15
Item Basket Maintenance	5-15
Item Price to History	5-16
Product Group Schedule Clean up	5-16
Return Not After Date Alert	5-17
Stock Count Authorize Recovery	5-17
Stock Count Export File SFTP Push	5-18
Stock Count Unit and Amount Snapshots	5-18
Transfer Close	5-19
Transfer Delivery Auto Receive	5-20
Transfer Delivery Close	5-20
Transfer Not After Date Alert Batch	5-21
Transfers Overdue	5-22
Vendor Return Closure	5-22
BDI-Based Batches	5-23
Clearance Transaction Import	5-23
Price Change Transaction Import	5-23
Rfid Transaction Import	5-24
Third Party Pricing Import	5-24
Warehouse Avail Inventory Import	5-25
SFTP File-Based Batches	5-25
High Level Batch File Process Overview	5-26
Clearance Price Change Import (with On-premise RPM)	5-26
Inventory Extract	5-26
Pos Transaction Import	5-27
Promotion Price Change Import (with On-premise RPM)	5-28
Regular Price Change Import (with On-premise RPM)	5-28
Retail Sale Audit Import	5-28
Store Sequence Import	5-30
Third Party Stock Count Import	5-30
Warehouse Item Stock Import	5-31
SFTP Nightly Batch File Uploads	5-32
Adding Authorized Keys	5-32

Login to WinSCP.....	5-34
Uploading a Batch File.....	5-35
Export File Downloads.....	5-36
Purge Batches	5-36
Purge Adhoc Stock Count.....	5-37
Purge Areas	5-38
Purge Batch Log	5-38
Purge Closed Transfers	5-39
Purge Completed UIN Detail.....	5-40
Purge DSD and Purchase Orders.....	5-41
Purge Fulfillment Orders	5-42
Purge Invalid Users	5-43
Purge Invalid User Roles	5-43
Purge Inventory Adjustments	5-44
Purge Item	5-45
Purge Item Baskets.....	5-47
Purge Item Hierarchy	5-48
Purge Item Price	5-48
Purge Lockings	5-49
Purge Notifications	5-50
Purge Price Change Worksheet	5-50
Purge Price Histories	5-51
Purge Related Items	5-51
Purge Resolved UIN Problems	5-52
Purge RFID.....	5-52
Purge Sales Posting.....	5-53
Purge Shelf Adjustments.....	5-54
Purge Shelf Replenishment.....	5-54
Purge Staged Message.....	5-55
Purge Stock Counts.....	5-56
Purge Temporary UIN Detail.....	5-56
Purge Ticket Histories	5-57
Purge Vendor Returns.....	5-57
Data Purging Batches - BDI Staging Data	5-58
Purge BDI Inbound Price	5-58
Purge BDI Item	5-59
Purge BDI Item Loc.....	5-59
Purge BDI Location.....	5-60
Purge BDI Misc Group	5-61
Purge BDI Price Hist.....	5-61
Purge BDI Rfid.....	5-62
Purge BDI Store Inventory Avail.....	5-62
Purge BDI Supp Item.....	5-63
Purge BDI UDA.....	5-63
Purge BDI Warehouse Item Avail	5-64
Batch Job Administration	5-64
Job Administration.....	5-65

Job Admin Screen.....	5-66
Job Execution Log Screen.....	5-67
Job Launch Screen.....	5-69
Ad hoc Job.....	5-69
Data Seed Importer Job.....	5-70
Start an Ad hoc Job.....	5-71
View Details for Job.....	5-71
Start a Data Seed Job.....	5-72
Stop a Running Job.....	5-72
Job Scheduler.....	5-72
Job Scheduler Screen.....	5-75
Configuring a Job Schedule.....	5-77
Disabling a Job Schedule.....	5-78

6 Batch - Data Archive

Archive Data Batches.....	6-1
Archive Dump Batches.....	6-2
Archive Batch Scheduling Consideration.....	6-2
Archive Data Dump Files Export.....	6-2

7 Technical Maintenance Screens

Barcode Processor.....	7-1
Barcode Processors.....	7-2
External Printer Setup.....	7-3
MPS Staged Message.....	7-4
MPS Work Type.....	7-6

8 Integration

Overall Integration Touchpoints.....	8-2
Retail Integration Cloud Service (RICS) - based Integration.....	8-2
Customer Orders.....	8-3
Picking.....	8-3
Deliveries.....	8-3
Reverse Picking.....	8-4
Multi Leg.....	8-4
RIB Payloads.....	8-4
Purchase Orders and Vendor Deliveries.....	8-5
Inventory Adjustments.....	8-6
Items.....	8-6
Stock Counts.....	8-6
Transfers.....	8-7
Transfer Creation.....	8-7
Transfer Messages.....	8-7
Transfer Shipment Creation.....	8-7
Transfer Receiving.....	8-7
Transfer Doc.....	8-10

Transfer Shipment.....	8-10
Transfer Receiving	8-11
Vendor Return	8-11
RTV Creation	8-11
RTV Shipment	8-11
Batch Integration	8-14
Overview	8-14
BDI-Based Batch Integration	8-14
Initial Foundation Data Seeding.....	8-14
Recurring BDI Transaction Batches.....	8-16
BDI Transmitter CLI - Client Batch File Loader	8-16
SFTP-Based Batch File Integration	8-17
Web Services	8-19
Functionality	8-19
Available Web Services	8-19
Web Services Basic Design Principles	8-21
Internally Managed vs Externally Managed.....	8-22
Web Service Operation Basic Design Standards	8-23
Interpreting Validation Errors.....	8-23
Common Error Codes	8-24
Validation Error (Fault Example)	8-24
Business Error (Fault Example)	8-25
Web Services	8-26
Web Service: ActivityLock.....	8-26
Web Service: FulfillmentOrderDelivery	8-26
Web Service: FulfillmentOrderPick.....	8-27
Web Service: FulfillmentOrderReversePick.....	8-28
Web Service: InventoryAdjustment	8-28
Web Service: Item Basket.....	8-29
Web Service: POSTransaction	8-30
Web Service: ProductGroup	8-30
Web Service: ProductGroupSchedule.....	8-30
Web Service: ReplenishmentGap.....	8-31
Web Service: RfidInventory.....	8-31
Web Service: ShelfAdjustment.....	8-32
Web Service: ShelfReplenishment	8-32
Web Service: StockCount	8-33
Web Service: Store.....	8-33
Web Service: StoreFulfillmentOrder	8-34
Web Service: StoreInventory	8-34
Web Service: StoreInventoryISN	8-35
Web Service: StoreInventoryUIN	8-35
Web Service: StoreItem	8-36
Web Service: StoreItemPrice.....	8-36
Web Service: StoreNotification	8-37
Web Service: StoreShipmentManifest.....	8-37
Web Service: StoreShipmentReason.....	8-37

Web Service: StoreTransfer.....	8-37
Web Service: TransferDelivery	8-38
Web Service: TransferShipment.....	8-40
Web Service: VendorDelivery	8-41
Web Service: VendorReturn	8-42
Web Service: VendorShipment	8-43
Enterprise Documentation.....	8-44
Sales Integration	8-44
POS and Sales Audit Process Flow.....	8-45
Sales and Return Processing.....	8-46
Customer Order Processing	8-46
Item Disposition	8-46
Drop Ship	8-46
Item Types.....	8-47
RFID	8-47
Integration with Manifesting Systems	8-47
Customer Address	8-48
Integration for Ticket Printing	8-48
Ticket Print	8-48
Retail Home Integration	8-49
Launch EICS from Retail Home.....	8-49
Tile Reports	8-49
Create Tile	8-50
Add Tile State	8-50
Add Data Source	8-51
EICS Endpoints.....	8-51
Shop Floor Out of Stock Items	8-51
Stock Counts - Ready to Authorize	8-52
EICS Operational Views.....	8-52
Launch EICS Operational Views from Tile Report.....	8-52

9 Configuration

System Admin Parameters	9-1
Store Admin Parameters	9-30
Access Permissions	9-42
Data Permissions	9-65

10 Operational Issues Screens

Operational Issues List Screen	10-2
Operational Issues Review	10-2
Operational Review Screen Actions	10-2
Bulk Data Import	10-4
Data Purge.....	10-4
Message Processing.....	10-4
Transactional Execution	10-5

A Appendix: Run Importer Separately from EICS Job Admin

Run Data Seeding Importer Jobs	A-1
BDI Transaction (TX) Importer Jobs.....	A-3

B Appendix: BDI Transmitter CLI Procedure - Load External Data File

BDI Transmitter CLI Tool Setup.....	B-1
Tool Usage	B-3
File Processing	B-4
Output Logs	B-4
Error Reprocessing.....	B-5
Schedule EICS Importer Jobs for Transmitter Loaded Data	B-5
View EICS Importer Jobs Execution Details	B-6

C Appendix: Report Formats

Reports.....	C-1
Report Formats.....	C-2

D Appendix: Batch File Layout Specifications

Third Party Stock Count Parser Import File Layout Specification.....	D-1
Filename Format.....	D-1
Zip Filename Format	D-1
Third Party Stock Count Import File Format.....	D-2
File Layout.....	D-2
Clearance Price Change Import File Layout Specification	D-3
Filename Format.....	D-3
Zip Filename Format	D-3
File Record Types	D-3
File Layout.....	D-3
Regular Price Change Import File Layout Specification	D-4
Filename Format.....	D-4
Zip Filename Format	D-4
File Record Types	D-5
File Layout.....	D-5
Promotion Price Change Import File Layout Specification	D-6
Filename Format.....	D-6
Zip Filename Format	D-7
File Record Types	D-7
File Layout.....	D-7
POS Sale Transaction Import File Specification.....	D-11
Filename Format.....	D-11
Zip Filename Format	D-11
POS Sale Transaction Import File Format	D-11
File Layout.....	D-11
Retail Sale Audit Import File Specification	D-13
Filename Format.....	D-13
Zip Filename Format	D-13

ReSA Transaction Import File Format	D-13
File Layout.....	D-13
Stock Count Results Export File Specification	D-17
Store Sequence Data Parser Import File Layout Specification.....	D-17
Filename Format.....	D-18
Zip Filename Format	D-18
Store Sequence Import File Format	D-18
File Layout.....	D-18
Warehouse Stock Import File Layout Specification	D-19
Filename Format.....	D-19
Zip Filename Format	D-19
Warehouse Stock Import File Format	D-20
File Layout.....	D-20
Inventory Extract Export File Specification	D-20
Filename Format.....	D-20
Inventory Extract File Format	D-20
File Layout.....	D-21

E Appendix: Setup Auto-Authorized Third-Party Stock Count

F Appendix: Unit and Amount Stock Counts Export

Export File Layout	F-1
Export File Location	F-1
Export File Name	F-1

G Appendix: UPC Barcode

Differences between UPC-A and UPC-E	G-1
Conversion between UPC-A and UPC-E	G-2

H Appendix: EICS Provided URLs

EICS web-client URL.....	H-1
SOCS (connections config) URL	H-1
EICS Web Service URLs.....	H-1
BDI Related URLs	H-3
EICS-RICS Integration URLs.....	H-3
EICS-RICS Message Publishing	H-3
Setting Up RIB Message Injector	H-4
BI Related URL	H-5
ORDS (Apex Data Viewer) URL	H-5

I Appendix: Data Seeding Process Flows

Data Seeding Process Flows from Merchandising to EICS	I-1
Data Seeding Mapping Tables between SIOCS and BDI.....	I-3

J Appendix: Pricing Import with On-premise RPM

Clearance Price Change Import with On-premise RPM..... J-1
Promotion Price Change Import with On-premise RPM J-2
Regular Price Change Import with On-premise RPM J-3

K Appendix: Open Transaction Seed

Overview K-1
 Direct Delivery - Transaction Import K-1
 Transfer - Transaction Import K-2
 Purchase Order - Transaction Import K-2
Technical Design K-2
Technical Architecture K-5
Data Process Flow..... K-6
Exception Handling K-7
Data Mapping K-11

L Appendix: Third Party Pricing Integration

Overview L-1
BDI Implementation Considerations L-1
Third Party Pricing Import via BDI CLI File Transmitter L-3
EXT_PRICE_IN L-3
External Price CSV File Fields L-5
File Contents Explanation..... L-5

List of Tables

3-1	Report URL Location.....	3-2
3-2	Operational Reports.....	3-5
4-1	Translation Topics.....	4-3
4-2	Translation Data JET Screens	4-6
5-1	Batch Users and Roles	5-2
5-2	Batch System Configuration Options.....	5-2
5-3	Key Tables for Archive Activity History	5-6
5-4	Key Tables for Archive Dump	5-7
5-5	Key Tables for Archive RFID History	5-7
5-6	Key Tables for Archive Store Item Stock History.....	5-7
5-7	Key Tables for Archive Item Uin History.....	5-8
5-8	Key Tables for Auto Replenish Capacity Batch.....	5-8
5-9	Key Tables for Cleanup Batch Directories.....	5-9
5-10	Key Tables for Cleanup Shelf Replenishment Batch	5-9
5-11	Key Tables for Close DSD Receiving Batch.....	5-10
5-12	Key Tables for Fulfillment Order Pick Reminders Batch.....	5-11
5-13	Key Tables for Fulfillment Order Reminders Batch	5-11
5-14	Key Tables for Problem Line Stock Count Batch.....	5-12
5-15	Key Tables for Generate Unit Amount Stock Count Batch.....	5-13
5-16	Key Tables for Generate Unit Stock Count Batch	5-14
5-17	Key Tables for Item Basket Maintenance Batch.....	5-15
5-18	Key Tables for Item Price to History Batch	5-16
5-19	Key Table for Close Prod Group Schedule Batch.....	5-16
5-20	Key Tables for Return Not After Date Alert Batch	5-17
5-21	Key Tables for Stock Count Authorize Recovery Batch.....	5-17
5-22	Key Tables for Stock Count Unit And Amount Snapshot Batch	5-19
5-23	Key Tables for Close Transfers Batch.....	5-19
5-24	Key Tables for Auto Receive Transfer Deliveries.....	5-20
5-25	Key Tables for Close Transfer Deliveries Batch	5-21
5-26	Key Tables for Transfers Not After Date Alert Batch.....	5-21
5-27	Key Tables for Transfers Overdue Batch.....	5-22
5-28	Key Tables for Close Vendor Return.....	5-22
5-29	Key Tables for Clearance Transaction Import	5-23
5-30	Key Tables for Price Change Transaction Import	5-24
5-31	Key Tables for Rfid Transaction Import	5-24
5-32	Key Tables for Third Party Pricing Import	5-24
5-33	Key Tables for Third Party Pricing Import	5-25
5-34	Key Tables for Inventory Extract Batch	5-27
5-35	Key Tables for Pos Transaction Import Batch.....	5-28
5-36	Key Tables for Retail Sale Audit Import Batch.....	5-29
5-37	Key Tables for Store Sequence Import Batch	5-30
5-38	Key Tables for Third Party Stock Count Import Batch.....	5-31
5-39	Key Tables for Warehouse Item Stock Import Batch.....	5-32
5-40	Key Tables for Purge AdHoc Stock Count Batch.....	5-37
5-41	Key Tables for Purge Area Batch.....	5-38
5-42	Key Tables for Purge Batch Log Batch.....	5-39
5-43	Key Tables for Purge Closed Transfers Batch.....	5-39
5-44	Key Tables for Purge Completed UIN Detail Batch	5-40
5-45	Key Tables for Purge DSD Receivings Batch	5-41
5-46	Key Tables for Purge Fulfillment Orders Batch	5-42
5-47	Key Tables for Purge Invalid Users Batch.....	5-43
5-48	Key Tables for Purge Invalid User Roles Batch.....	5-44
5-49	Key Tables for Purge Inventory Adjustments Batch	5-44

5-50	Key Tables for Purge Item Batch	5-45
5-51	Key Tables for Purge Item Basket Batch.....	5-47
5-52	Key Tables for Purge Item Hierarchy Batch	5-48
5-53	Key Tables for Purge Item Price Batch.....	5-49
5-54	Key Tables for Purge Lockings Batch	5-49
5-55	Key Tables for Purge Notifications Batch.....	5-50
5-56	Key Tables for Purge Price Change Worksheet Batch.....	5-50
5-57	Key Tables for Purge Price Histories Batch.....	5-51
5-58	Key Tables for Purge Related Items Batch	5-52
5-59	Key Tables for Purge Resolved UIN Problems Batch.....	5-52
5-60	Key Tables for Purge Notifications Batch.....	5-53
5-61	Key Tables for Purge Sales Posting Batch	5-53
5-62	Key Tables for Purge Shelf Adjustment Batch.....	5-54
5-63	Key Tables for Purge Shelf Replenishment Batch.....	5-55
5-64	Key Tables for Purge Staged Message Batch	5-55
5-65	Key Tables for Purge Stock Counts Batch.....	5-56
5-66	Key Tables for Purge Temporary UIN Detail Batch	5-57
5-67	Key Tables for Purge Ticket Histories Batch.....	5-57
5-68	Key Tables for Purge Vendor Returns Batch	5-58
5-69	Key Tables for Purge BDI Warehouse Item Avail.....	5-59
5-70	Key Tables for Purge BDI Item	5-59
5-71	Key Tables for Purge BDI Item Loc	5-60
5-72	Key Tables for Purge BDI Location	5-60
5-73	Key Tables for Purge BDI Misc Group	5-61
5-74	Key Tables for Purge BDI Price Hist	5-62
5-75	Key Tables for Purge BDI Rfid.....	5-62
5-76	Key Tables for Purge BDI Store Inventory Avail	5-63
5-77	Key Tables for Purge BDI Supp Item.....	5-63
5-78	Key Tables for Purge BDI UDA	5-64
5-79	Key Tables for Purge BDI Warehouse Item Avail.....	5-64
5-80	Interval Based Schedule	5-72
5-81	Batch Job Schedules	5-73
6-1	Archive Data Batch List	6-1
6-2	Archive Dump Batch List	6-2
7-1	Barcode Processors	7-2
8-1	BDI Foundation Data Seeding Integration Object List.....	8-15
8-2	BDI Transaction Batch List	8-16
8-3	BDI Transmitter CLI List	8-17
8-4	SFTP-Based Batch File Integration Modules.....	8-18
8-5	Shop Floor Out of Stock	8-52
8-6	Stock Counts - Ready to Authorize	8-52
9-1	System Admin Parameters	9-1
9-2	Store Admin Parameters.....	9-30
9-3	Security Permissions.....	9-42
10-1	Security Permissions for Delete Actions.....	10-3
A-1	BDI Transaction (TX) Importer Jobs.....	A-3
B-1	bdi-file-transmitter.properties.....	B-1
C-1	Reports.....	C-1
D-1	Third Party Stock Count Import File.....	D-2
D-2	Clearance Price Change File Layout	D-3
D-3	Regular Price Change File Layout	D-5
D-4	Promotion Price Change Output File Layout	D-7
D-5	T-LOG File.....	D-11
D-6	ReSA File Layout.....	D-13
D-7	Stock Count Export File	D-17

D-8	Store Sequence Import File	D-18
D-9	Warehouse Stock Import File	D-20
D-10	Inventory Extract File	D-21
G-1	UPC Conversion Table	G-2
H-1	EICS Application URL.....	H-1
H-2	SOCS Connections URL	H-1
H-3	EICS Web Service URLs	H-1
H-4	BDI Related URLs	H-3
H-5	RIB Message Publishing.....	H-4
H-6	BI Related URL	H-5
H-7	ORDS (Apex Data Viewer) URL.....	H-5
I-1	Data Seeding Process Flow Dependencies List	I-1
I-2	Data Seeding Mapping Tables between SIOCS and BDI	I-3
J-1	Key Tables for Clearance Price Change with On-premise RPM.....	J-2
J-2	Key Tables for Promotion Price Change with On-premise RPM.....	J-3
J-3	Key Tables for Regular Price Change with On-premise RPM	J-4
J-4	Key Tables for Regular Price Change Batch.....	J-4
K-1	Flattened Database Table Mapping.....	K-3
K-2	Configuration Parameters for DSD Received Status	K-4
K-3	1. Purchase Order.....	K-7
K-4	2. Transfer.....	K-8
K-5	3. Allocation	K-8
K-6	4. Direct Store Delivery (DSD)	K-9

Send Us Your Comments

Oracle Retail Enterprise Inventory Cloud Service Administration Guide, Release 19.1

Oracle welcomes customers' comments and suggestions on the quality and usefulness of this document.

Your feedback is important, and helps us to best meet your needs as a user of our products. For example:

- Are the implementation steps correct and complete?
- Did you understand the context of the procedures?
- Did you find any errors in the information?
- Does the structure of the information help you with your tasks?
- Do you need different information or graphics? If so, where, and in what format?
- Are the examples correct? Do you need more examples?

If you find any errors or have any other suggestions for improvement, then please tell us your name, the name of the company who has licensed our products, the title and part number of the documentation and the chapter, section, and page number (if available).

Note: Before sending us your comments, you might like to check that you have the latest version of the document and if any concerns are already addressed. To do this, access the Online Documentation available on the Oracle Help Center (OHC) website. It contains the most current Documentation Library plus all documents revised or released recently.

Send your comments to us using the electronic mail address: retail-doc_us@oracle.com

Please give your name, address, electronic mail address, and telephone number (optional).

If you need assistance with Oracle software, then please contact your support representative or Oracle Support Services.

If you require training or instruction in using Oracle software, then please contact your Oracle local office and inquire about our Oracle University offerings. A list of Oracle offices is available on our Web site at <http://www.oracle.com>.

Preface

This document describes the administration tasks for Oracle Retail Enterprise Inventory Cloud Service.

Audience

This document is intended for administrators.

Documentation Accessibility

For information about Oracle's commitment to accessibility, visit the Oracle Accessibility Program website at <http://www.oracle.com/pls/topic/lookup?ctx=acc&id=docacc>.

Access to Oracle Support

Oracle customers that have purchased support have access to electronic support through My Oracle Support. For information, visit <http://www.oracle.com/pls/topic/lookup?ctx=acc&id=info> or visit <http://www.oracle.com/pls/topic/lookup?ctx=acc&id=trs> if you are hearing impaired.

Related Documents

For more information, see the following documents in the Oracle Retail Store Inventory Operations Cloud Services Release 19.1 documentation set:

- *Oracle Retail Store Inventory Operations Cloud Services Release Notes*
- *Oracle Retail Store Inventory Operations Cloud Services Implementation Guide*
- *Oracle Retail Enterprise Inventory Cloud Service Security Guide*
- *Oracle Retail Enterprise Inventory Cloud Service User Guide*
- *Oracle Retail Store Operations Cloud Service User Guide*
- *Oracle Retail Store Operations Cloud Service Mobile Guide*

Improved Process for Oracle Retail Documentation Corrections

To more quickly address critical corrections to Oracle Retail documentation content, Oracle Retail documentation may be republished whenever a critical correction is needed. For critical corrections, the republication of an Oracle Retail document may at times not be attached to a numbered software release; instead, the Oracle Retail

document will simply be replaced at the Oracle Help Center (OHC) website, or, in the case of Data Models, to the applicable My Oracle Support Documentation container where they reside.

This process will prevent delays in making critical corrections available to customers. For the customer, it means that before you begin installation, you must verify that you have the most recent version of the Oracle Retail documentation set. Oracle Retail documentation is available at the Oracle Help Center at the following URL:

<https://docs.oracle.com/en/industries/retail/index.html>

An updated version of the applicable Oracle Retail document is indicated by Oracle part number, as well as print date (month and year). An updated version uses the same part number, with a higher-numbered suffix. For example, part number F123456-02 is an updated version of a document with part number F123456-01.

If a more recent version of a document is available, that version supersedes all previous versions.

Oracle Retail Documentation at the Oracle Help Center

Oracle Retail product documentation is available on the following website:

<https://docs.oracle.com/en/industries/retail/index.html>

(Data Model documents are not available through Oracle Help Center. You can obtain them through My Oracle Support.)

Conventions

The following text conventions are used in this document:

Convention	Meaning
boldface	Boldface type indicates graphical user interface elements associated with an action, or terms defined in text or the glossary.
<i>italic</i>	Italic type indicates book titles, emphasis, or placeholder variables for which you supply particular values.
monospace	Monospace type indicates commands within a paragraph, URLs, code in examples, text that appears on the screen, or text that you enter.

Technical Architecture

This chapter describes the overall software architecture, offering a high-level discussion of the general structure of the system.

Overall there is no change in deployment from the previous release period.

There are underlying version updates to the technical stack (DB 19c, Web Logic 12.2.1.4, updated versions of UI libraries, Fusion middle ware libraries and so on.)

Multiple Products

EICS (Enterprise Inventory Cloud Service) and SOCS (Store Operations Cloud Service) are two separately licensed products.

EICS includes:

- EICS Browser Client
- EICS Web Services
- EICS Server Tier
- EICS Database tier with data access code, batches, reports

SOCS includes:

- Oracle MAF Client

In order to use SOCS, EICS needs to be deployed.

Logical Model

Figure 1-1 Logical Model

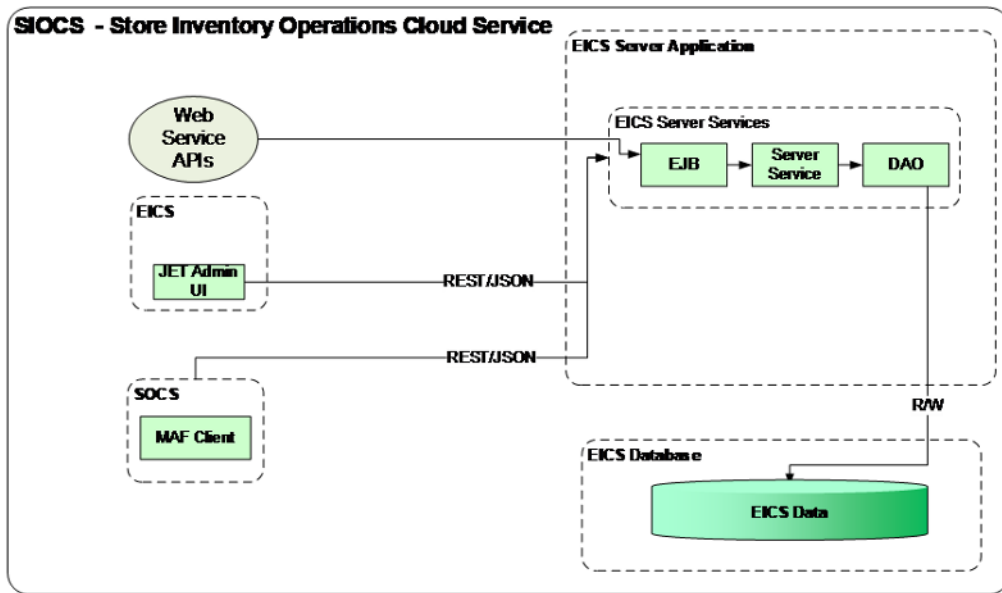

SaaS Deployment

Figure 1-2 SaaS Deployment

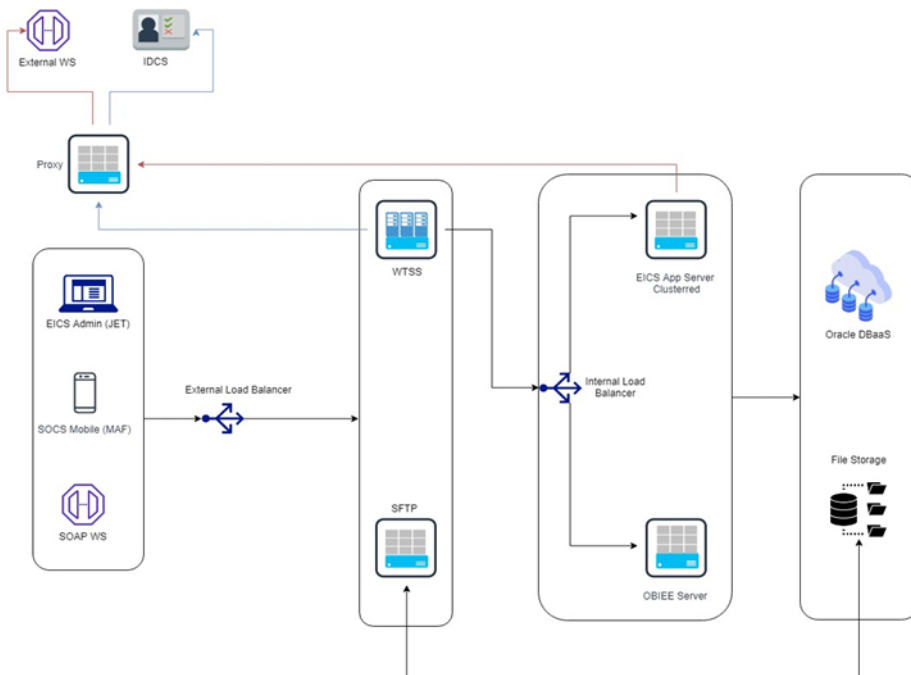

Cloud Deployment

EICS Client

Oracle JET based browser application that allows the user to perform a wide range of administrative functions.

SOCS Mobile Client

The mobile client provides all the day-to-day transactional workflows within an Oracle Mobile Application Framework (MAF) platform. MAF is a hybrid-mobile platform that supports both iOS and Android devices. For more details, please see *Oracle Retail Store Operations Cloud Service Mobile Guide*.

Web Services

There is no GUI for the SOAP web services APIs that are provided by EICS. These APIs allow customers to create or develop applications or add-ons that can replicate some or all of the steps of a transaction workflow.

WTSS / IDCS

WTSS: Web Traffic Security Service

IDCS: Identity Management Cloud Service is used to authenticate users.

EICS Application Server(s)

Server deployed as a J2EE application inside the WebLogic Application Server.

OBIEE Server

OBIEE / BIPublisher is used as reporting engine.

SFTP Server

The Secure File Transfer Protocol server is responsible for the moving of files from outside the internet firewall to within the internet firewall in a secure manner. This is used with File Storage Service.

Oracle DB Server (DBaaS)

Contains EICS schema. Uses JDBC to access data from the database.

WebLogic application server provides a connection pool to use database resources in an efficient fashion.

PL/SQL stored procedures are also used for high volume batch processing.

Client-Server Communication

Client(s) use ReST service calls to access the server.

External systems may use SOAP service calls to access the server.

All transactions are container managed.

Performance is sensitive to network latency (hence compression from client to server).

Integration

Oracle Retail Integration Cloud Server (RICS) is used for integration between multiple systems within the cloud as well as deployment of public web services by EICS and other systems.

Oracle Retail Integration Bus (RIB)

The RIB is a near-real time, message based communication queue. Payloads are delivered in an asynchronous fashion between multiple systems on the enterprise in a non-blocking (fire and forget) manner. This broadcast of notifications is subscribed to by each application interested in an event notification.

SOAP Web Services

Numerous APIs into EICS Server are exposed through operations in a wide-array of SOAP web services available to external applications.

File-Based

EICS receives information through several file-based scenarios in order to receive large volumes of data for more efficient processing. These include sales records, stock counts performed by a third party, and price change from a price management system.

Deployment with Other Products

EICS is deployed in three ways:

- It is deployed with the rest of Retail assets such as Retail Merchandising Foundation Cloud Service and Retail Integration Cloud Service (RIB/RSB/BDI).
- It is deployed with POS/Xstore typically with or without RIB.
- It is deployed as a stand-alone or point deployment.

EICS and SOCS have a distributed deployment model with browser and mobile devices running at stores, connecting with server and database hosted at corporate. The central server deployment allows real-time inventory queries for stock-on-hand positions across the enterprise, but requires a fairly robust network connection between store and corporate environments.

Deployment - Performance: Bandwidth, Scaling

Bandwidth Requirements for Browser Clients

Installations with less than 128 KB bandwidth available between the device containing the browser or the mobile application and the data center are not recommended or supported. Limiting the client to less than 128 KB total available bandwidth causes unpredictable network utilization spikes, and the performance of the client degrades below requirements established for the product.

Network Latency Constraints

EICS is also sensitive to the network latency between the browser or mobile device and the data center. Oracle Retail does not recommend or support installations with more than 100 ms total round-trip network latency between the client device and the data center. Latency beyond the 100 ms limit causes unpredictable network utilization spikes, and the performance of the client degrades below requirements established for the product. The 100 ms limitation provides reasonable, predictable performance and network utilization for transactions.

Application Server Clustering

EICS supports application server clustering with a load balancer for Oracle WebLogic.

The EICS Server can run inside an application server cluster, but the load must be distributed among the nodes in the cluster.

It is also possible to configure a single application server instance with multiple JVMs inside the application server instance. When doing this, an upper limit of 1.5 to 2 JVMs per server CPU is recommended.

Clustering for Oracle WebLogic Server is also supported through a load balancer.

Database Clustering with RAC

EICS supports a RAC-enabled database for performance.

Data Seeding

This chapter contains the following:

- [What is Data Seeding?](#)
- [Overview of Data Seeding Process](#)
- [Pre-requisites](#)
- [Configure EICS for Data Seeding](#)
- [Run BDI Data Seeding](#)

What is Data Seeding?

EICS needs merchandising foundation data (stores, items, initial inventory positions, suppliers, and so on) in order to function.

Initial inventory data seeding is applicable for new or fresh full EICS installation, and should only be run once. Once the initial set of data is seeded into EICS, subsequent inventory changes are communicated via Oracle Retail Integration Cloud Service (RICS - RIB).

EICS data seeding uses Oracle Retail Integration Cloud Service (RICS) BDI process to seed data from MFCS into the EICS. There are 35 processes that get extracted from MFCS into EICS. These processes have been grouped into nine (9) groups based on dependency and functionality. See [Table I-1, Data Seeding Process Flow Dependencies List](#) for details.

Data seeding can be used for a variety of use cases:

- Loading just the Foundation data from Merchandising
- Loading all stores data
- Loading a single store data

Overview of Data Seeding Process

1. An **Extractor** extracts data from a data producing system into an outgoing intermediate integration interface table.
2. A **Downloader** and **transporter** services data to receiver service.
3. An **Uploader** uploads the data to an incoming intermediate integration interface tables.
4. An **Importer** imports the data from the interface tables into EICS application tables.

For additional detail on BDI Data Integration Topologies, please see *Oracle Retail Bulk Data Integration Implementation Guide*.

Pre-requisites

Prior to running data seeding, the following requirements must be met:

Sourcing System must be installed:

The sourcing system is the merchandising foundation data sourcing system, such as MFCS.

BDI Transport System must be installed:

BDI Process Flow: Mechanism to run multiple dependent batch jobs.

- BDI-RMS Batch Job Admin: Provides management of BDI for RMS batch jobs.
- BDI-SIM Batch Job Admin: Provides management of BDI for EICS batch jobs.

Target System must be installed:

EICS is the receiver target system, proper security settings and system configuration for data seeding must be set. See [Configure EICS for Data Seeding](#) section for details.

Configure EICS for Data Seeding

- [Security Settings](#)
- [Configuration Parameters](#)
- [Steps to Enable Data Seeding in EICS UI](#)

Security Settings

There are two types of security assignments. Enterprise Integration Group and Application Permissions. Enterprise security group is managed within IDCS. EICS Application Permissions are managed via EICS. See *Oracle Retail Enterprise Inventory Cloud Service Security Guide* "User Provisioning" section for details.

The following table shows user security relevant to Data Seeding:

Task	Enterprise Security Group	Application Permission Name	Description
BDI Process Flow Integration to access EICS Importer Service	sim_integration_users	N/A	<p>The Application integration user is meant for non-EICS application accessing EICS provided integration resources. The integration app user only needs to be assigned to enterprise security group.</p> <p>Notes:</p> <p>The application integration user does not require access to the EICS client applications, and therefore does not require store assignments or role assignments (permissions).</p>

Task	Enterprise Security Group	Application Permission Name	Description
View EICS Import Job Activities	sim_sysop_users	Access Job Admin	Allows access to EICS batch job screen.
Manual Run Data Seed Importer	sim_sysop_users	Access Data Seed	Allows EICS user to manually run data seeding importer jobs via EICS batch job admin.

Configuration Parameters

The EICS Data Seeding Importer process in EICS imports data from the staged or intermediate tables into EICS application tables. The configuration parameters determine how the importer process operates in EICS.

The data seeding system configuration flags are disabled upon EICS installation because the full set of data should only be loaded once for foundation inventory data and store inventory data.

The following table shows the configuration parameters and their default values.

Configuration Name	Description
Data Seed Foundation Data	<p>The foundation data can be used for initial bulk load of EICS foundation data (such as Supplier, Merchandise Hierarchy, Item and others) from data producing system during initial setup of EICS system. This option should be disabled after EICS data seeding is completed. Default value is set to No.</p> <p>If you set this parameter to Yes, then data from sourcing system is automatically loaded into EICS application tables during BDI Process Flow process. If you leave this parameter to No, the process loads the data from sourcing system into EICS BDI inbound interface tables, then you must run Importer Job to load data from interface tables into application tables manually via EICS Batch Job Admin Console, see Appendix: Run Importer Separately from EICS Job Admin for details.</p>
Data Seed Store Data	<p>The seed store data can be used for initial bulk data load of EICS store inventory data (such as Store Item, and Store Item Stock) from a data producing system. Default value is set to No.</p> <p>If you set this parameter to Yes, then store data from sourcing system are automatically loaded into EICS application tables during BDI Process Flow process. If you leave this parameter to No, the process loads the store data from sourcing system into EICS BDI inbound interface tables, then you must run Importer Job to import store data from interface tables into application tables manually via EICS Batch Job Admin Console, see Appendix: Run Importer Separately from EICS Job Admin for details.</p>
Data Seed By Store	<p>Determines whether the store data are automatically loaded for a single store only when Data Seed Store Data is set to Yes. By default, this parameter is set to No, then all stores and inventory are seeded. To rollout a single store, enable this configuration allow only a single store's inventory data to be seeded. Default value is set to No.</p> <p>If you set this parameter to Yes, then you must run Importer Job for store data manually via EICS Batch Job Admin Console, see Appendix: Run Importer Separately from EICS Job Admin for details.</p>
Data Seed Chunk Limit	Controls the data seeding transaction size limit. Default value is set to 10000.

Configuration Name	Description
Data Seed On Error Continue	This flag determines how the error should be handled during data seeding import process. If the flag is turned on (true), the process will skip the current chunk of data, and continue to process next chunk of data. If the flag is turned off (false), the data loading process will be terminated when an error occurs. Default value is set to No .

To change configuration values:

1. Login to Oracle Enterprise Inventory Cloud Service page as EICS System Ops user.

Note: Full details about the configuration screens can be found in the *Oracle Retail Enterprise Inventory Cloud Service User Guide*.

2. On Main Menu, select Admin - Configuration - System Administration.
3. Search for data seed in option field, change value and save the change.

Figure 2–1 Data Seed Settings

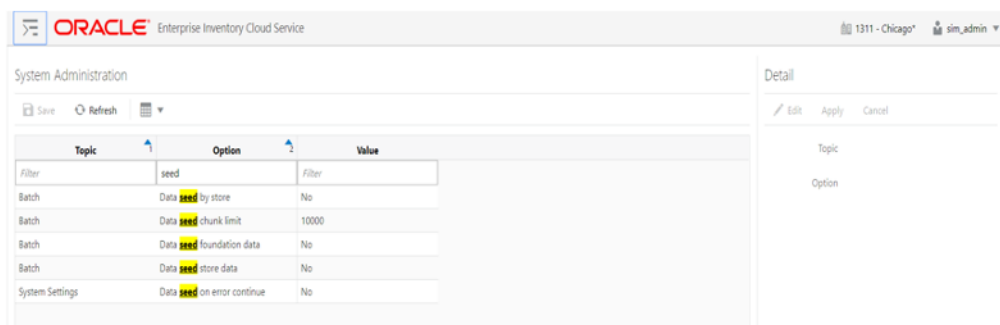

Steps to Enable Data Seeding in EICS UI

To seed initial inventory foundation data from sourcing system directly into destination application tables, an application implementation consultant must perform the following configuration steps:

1. Use EICS System Administration Console to set **data seeding foundation** to **Yes**.
2. Use EICS System Administration Console to set **data seeding store** to **Yes**.

Steps to Manual Control Importers

Optionally, if you want to manually control importer steps, perform the following steps:

1. Use EICS System Administration Console to set **data seeding foundation** to **No**.
2. Use EICS System Administration Console to set **data seeding store** to **No**.
3. Start BDI Process Flow (see [BDI Process Flow Admin Console](#) section for details).
4. Once data is loaded into inbound interface table, if you want to import interface data into application tables, set **data seeding foundation** to **Yes**, set **data seeding store** to **Yes**.

5. Use EICS Batch Job Admin Data Seeding jobs to manually start data seeding importer job.

Optional Steps Prior Initial Seeding

For initial data seeding into EICS, if slowness is observed due to validating data integrity constraints, sysop user can disable the data seeding constraints prior to running initial data seeding (Note: only certain predefined database constraints can be disabled via Data Seeding Console). The database constraints must be enabled after initial data seeding is completed.

To disable data seeding constraints:

1. Login Oracle Enterprise Inventory Cloud Service page as EICS System Ops user.
2. On Main Menu, select **Admin/ Technical Maintenance/Job Admin**.
3. On Job Admin Screen, click **Data Seed**, this will bring you to the Data Seed screen.
4. Select Job Name **Database Constraints**.
5. From Seed Option drop down list, select **Disable Constraint**.
6. Click **Start Job**.

Notes: See Post Data Seeding steps for enable data seeding constraints

Run BDI Data Seeding

You only need to run one time full data seeding to initially seed functional inventory data into EICS.

The data seeding processes can be started via [BDI Process Flow Admin Console](#).

BDI Process Flow Admin Console

To start the process flow:

1. Login to BDI Process Flow Console.
2. Click **Manage Process Flow**.
3. Choose group **SIM** from **Select Group** drop-down list.

Note: For data seeding process flow list, see [Appendix: Data Seeding Process Flows](#) that shows a list of Data Seeding Process Flows from Merchandising to EICS with groups. There are no dependencies within the same data seeding process group.

Figure 2–2 BDI Process Flow Console

The screenshot shows the Oracle Process Flow Admin Console interface. At the top, it says "ORACLE Process Flow Admin Console" and "Welcome, bdiprocessadmin, logout Thu Nov 01 15:48 CDT 2018". Below this are several tabs: "Process Flow Live", "Live Progress View", "Manage Process Flow", "Historical Process Flow Executions", "Manage Configurations", and "System Logs". The main content area is titled "All Process Definitions". There is a checkbox for "Hide Disabled process" and a "Select Group" dropdown menu set to "SIM". A search box contains the text "Enter process name to search...". Below this is a table with the following data:

			split]	CDT 2018	CDT 2018
CodeDetail_Fnd_ProcessFlow_From_RMS	CodeDetail	SIM,EXTERNAL	[sender- side- split]	Fri Oct 05 00:00:01 CDT 2018	Thu Oct 18 19:56:36 CDT 2018
CodeHead_Fnd_ProcessFlow_From_RMS	CodeHead	SIM,EXTERNAL	[sender- side- split]	Fri Oct 05 00:05:00 CDT 2018	Thu Oct 18 19:57:29 CDT 2018

To start the process:

1. Select the process name.
2. Navigate to the lower panel, and click **Launch Process Flow**.
3. Click **Run**.

Figure 2–3 Launch Process

The screenshot shows the "Launch Process" dialog box in the Oracle Process Flow Admin Console. The dialog has a title bar "Launch Process:". Below the title bar are two tabs: "Process Flow Executions" and "Process Flow Configurations". Under "Process Flow Executions" are sub-tabs "Process Flow Details", "Start Process", and "Stop Process". The "Process Name" field is populated with "CodeHead_Fnd_ProcessFlow_From_RMS". The "Process Parameters (Optional)" field is empty, with a "For eg:" example below it: "keyName1=value1,keyName2=value2,keyName3=value3". A "Run" button is located at the bottom right of the dialog.

To view BDI Process Flow details, navigate to **Process Flow Execution** tab to track the status of process flow.

Figure 2–4 Process Flow Details

Process Name	Process Execution Start Time	Process Execution End Time	Process Status
CodeHead_Fnd_ProcessFlow_From_RMS	Wed Nov 07 11:38:06 EST 2018	Wed Nov 07 11:40:08 EST 2018	PROCESS_COMPLETED

View Process Flow component details:

- [Extractor](#)
- [Downloader](#)
- [Uploader/Receiver](#)
- [Importer](#)

Extractor

To view extract data from source app, launch edge app batch job admin. The following shows the steps to view extractor from RMS:

1. Launch RMS Batch Job Admin console.
2. Login as BDI Job Admin user.

Figure 2–5 RMS Batch Job

Job Name	Job Type	Total Jobs	Total Executions	Start Time	Status
Wh_Fnd_ExtractorJob	Wh	17254	17439	Thu Mar 08 01:00:00 PST 2018	COMPLETED
WhAddi_Fnd_ExtractorJob	WhAddi	17253	17438	Thu Mar 08 00:55:01 PST 2018	COMPLETED
UomConversion_Fnd_ExtractorJob	UomConversion	17252	17437		COMPLETED
UomClass_Fnd_ExtractorJob	UomClass	17251	17436	Thu Mar 08 00:45:00 PST 2018	COMPLETED
UdaValues_Fnd_ExtractorJob	UdaValues	17250	17435	Thu Mar 08 00:40:00 PST 2018	COMPLETED
UdaItemLov_Fnd_ExtractorJob	UdaItemLov	17249	17434	Thu Mar 08 00:35:01 PST 2018	COMPLETED

For details, please see *Oracle Retail Bulk Data Integration Implementation Guide*.

Downloader

To view BDI Downloader job details:

1. Launch BDI for edge app batch admin console.
Follow these steps to view download from RMS.

2. Launch BDI RMS Batch Job Admin console.
3. Login as BDI RMS Job Admin user.

Figure 2–6 BDI RMS Batch Job

Job Name	Family	Instance Id	Execution Id	Start Time	Status
PartnerAddr_Fnd_DownloaderAndTransporterToSimJob	PartnerAddr	15792	15771	Thu Mar 08 01:35:01 CST 2018	COMPLETED
PackItem_Fnd_DownloaderAndTransporterToSimJob	PackItem	15760	15759	Thu Mar 08 01:31:03 CST 2018	COMPLETED
MerchHier_Fnd_DownloaderAndTransporterToSimJob	MerchHier	15738	15737		COMPLETED

For details, please see *Oracle Retail Bulk Data Integration Implementation Guide*.

Uploader/Receiver

To view BDI SIM uploader details:

1. Launch BDI SIM Edge Batch Job Admin console.
2. Login as SIM BDI Job Admin user.

Figure 2–7 BDI SIM Batch Job

Job Name	Family	Instance Id	Execution Id	Start Time	Status
WhAddr_Fnd_UploaderJob	WhAddr	15835	15836	Thu Mar 08 02:57:02 CST 2018	COMPLETED

For details, please see *Oracle Retail Bulk Data Integration Implementation Guide*.

Importer

To View EICS Importer details:

1. Launch EICS application, login EICS as System Ops user.
2. On Main Menu, select Admin - Technical Maintenance - Job Admin.

Figure 2–8 EICS Job Admin

Execution ID	Job Name	Instance ID	Status	Start Time
4664	CodeHead_Fnd	4644	Completed	11/2/18 8:58:58 AM

- To view detail record, select the record, then click hyperlink on the execution id. This will bring you to the **Job Execution Detail** screen.

Figure 2–9 Job Execution

Detail ID	Processed	Failed	Message
4888	Yes	No	

Import Staging Data to Application Tables

If you set the EICS seed options to enabled, the data from external source system is automatically imported into the application table, and you can skip the following steps.

If you set the seed options to disabled, and want to import data from staging table to applications through manual steps, please refer to the following:

Task	Step
Enable Data Seed Flags	<p>Login EICS as System Ops user.</p> <p>On Main Menu, select Admin - Configuration - System Administration.</p> <p>Search for data seed on option field, change to desired value and save the change.</p> <p>Enabled Data Seed Foundation Data: true</p> <p>Enable Data Seed Store Data: true</p>
Import data from stage tables to application tables	See Appendix: Run Importer Separately from EICS Job Admin .

Re-running EICS Importer Data Loads

After correcting the errors during process flow, you may re-run the initial data seeding process flow.

Important: Before executing additional runs of data seeding, please choose the appropriate re-seed options in EICS Job Admin Console.

Note: To import data for a specific store, please see Addition Notes: Importing Data for Single Store section

EICS system ops user login EICS, from Main Menu, navigate to Admin Technical Maintenance - Job Admin

On Job Admin Screen, click **Data Seed**. This will bring you to the Data Seed screen (for screen details, see [Data Seed Importer Job](#)), follow following steps:

Task	Step
Delete the previous seeded module data	<p>Choose desired module from job drop-down list, and then select Data Seed Option Deleted.</p> <p>For example:</p> <p>Choose Job Name Store End.</p> <p>Select Seed Option Delete Seeded.</p> <p>If you enter the store id, then only the seed data for that store is deleted.</p>
Re-import data from stage tables (see Re-import data from Source System, Re-import data step)	<p>Choose Job Name Store from job drop-down list, and then select Data Seed Option Seed.</p> <p>For example:</p> <p>If you enter the store id, then only the seed data for that store is seeded.</p> <p>If you want to import all stores, leave the store id as blank.</p>
Re-import data from Source System	<p>Delete the previous seeded module data</p> <p>Go to BDI process flow, choose the flow to be re-run, start the BDI process flow.</p>

BDI-Based Data Seeding Post-Load Processes

1. Enable Oracle Enterprise Inventory Cloud Service (EICS) constraints after data seeding.
 - a. Login EICS as EICS System Ops user.
 - b. On Main Menu, navigate to Admin - Technical Maintenance - Job Admin
 - c. On Job Admin Screen, click **Data Seed**. This will bring you to the Data Seed screen.
 - d. Select **Job Name Database Constraints**.
 - e. From **Seed Option** drop-down list, select **Enable Constraint**, click **Start Job**.
2. Purge data from inbound data seeding stage tables.

The inbound data seeding stage tables can be purged by batch job, the purge job purge group of data seeding interface tables, see [Data Purging Batches - BDI Staging Data](#) in the [Batches](#) chapter.

Alternatively, if you want to purge individual interface table, then follow following steps:

- a. Login EICS as EICS System Ops user.
 - b. On Main Menu, navigate to Admin Technical Maintenance - Job Admin.
 - c. On Job Admin Screen, click **Data Seed**. This will bring you to the Data Seed screen.
 - d. Select Each Importer Job Name (for example Code Head), then choose **Seed Option Delete In**, click **Start Job**.
3. Turn off EICS Data Seeding System Configuration Flags.
- a. Login EICS as EICS System Ops user.
 - b. On Main Menu, navigate to Admin - Configuration - System Administration.
 - c. Search for data seed on option field, change value and save the change.
 - d. Set the following values:
 - Enabled Seed Foundation: No
 - Enable Seed Store Data: No

EICS has the ability to produce reports for retails to view.

Reports are generated from within the functional areas of EICS and include information about shipping documentation, delivery reports, pick detail reports and so on. EICS uses a report screen to preview the report by sending the request parameters as report name and required parameter for the corresponding listed reports.

This section covers the following:

- [EICS Reporting Framework](#)
- [Report URL Location](#)
- [Previewing a Report](#)
- [EICS Operational Reports](#)

EICS Reporting Framework

The following section describes the reporting framework.

Figure 3–1 Reporting Framework

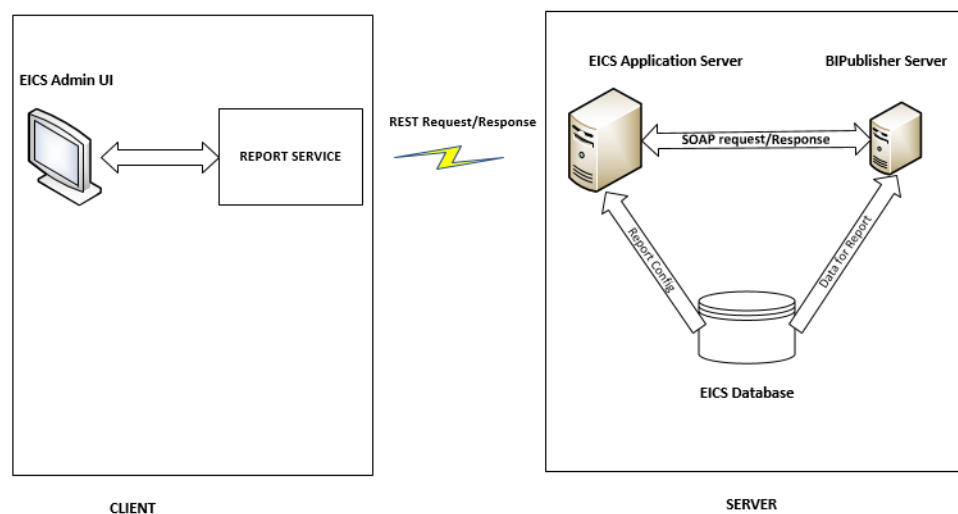

Report Service

The report format type is predefined as pdf format in the client. The report service use REST service calls to access the EICS server.

BI Publisher Server

EICS uses BI Publisher as the printing engine. BI Publisher gets the report data from the database by sql and generated the report in pdf format.

The following is the workflow for the process of Preview Reports:

1. A retailer makes a request on the JET Client to preview a report.
2. Format type of reports (pdf) which is added to the report detail parameters requested by retailers.
3. The client call the reporting service to request the REST call.
4. The REST request hit the EICS server and fetch the report configuration from the EICS database to request the BI Publisher.
5. The BI Publisher server receives URLs or parameters, runs a query to retrieve data to be printed, and formats the data.
6. That data is then sent back to the UI as response and reports are download in the pdf format.

Note: EICS tables (PRINT_FORMAT) refer to the report format. The EICS server fetches the report configuration detail from this table.

Report URL Location

The URL Location for each report type:

Table 3–1 Report URL Location

Type	URL Location
Customer Order Report	<BIP_SIM_REPORTS_FOLDER>/SIM/CustomerOrderReport/CustomerOrderReport.xdo
Customer Order Delivery BOL Report	<BIP_SIM_REPORTS_FOLDER>/SIM/CustomerOrderDeliveryBOLReport/CustomerOrderDeliveryBOLReport.xdo
Customer Order Bin Label Report	<BIP_SIM_REPORTS_FOLDER>/SIM/CustomerOrderBinLabelReport/CustomerOrderBinLabelReport.xdo
Customer Order Delivery Report	<BIP_SIM_REPORTS_FOLDER>/SIM/CustomerOrderDeliveryReport/CustomerOrderDeliveryReport.xdo
Customer Order Pick Report	<BIP_SIM_REPORTS_FOLDER>/SIM/CustomerOrderPickReport/CustomerOrderPickReport.xdo
Customer Order Pick Discrepancy Report	<BIP_SIM_REPORTS_FOLDER>/SIM/CustomerOrderPickDiscrepancyReport/CustomerOrderPickDiscrepancyReport.xdo
Customer Order Reverse Pick Report	<BIP_SIM_REPORTS_FOLDER>/SIM/CustomerOrderReversePickReport/CustomerOrderReversePickReport.xdo
Direct Delivery Report	<BIP_SIM_REPORTS_FOLDER>/SIM/DirectDeliveryReport/DirectDeliveryReport.xdo

Table 3-1 (Cont.) Report URL Location

Type	URL Location
Direct Delivery AGSN Report	<BIP_SIM_REPORTS_FOLDER>/SIM/VendorDeliveryAGSNReport/VendorDeliveryAGSNReport.xdo
Direct Delivery Discrepant Item Report	<BIP_SIM_REPORTS_FOLDER>/SIM/DirectDeliveryDiscrepantItemsReport/DirectDeliveryDiscrepantItemsReport.xdo
Direct Delivery Label Report	<BIP_SIM_REPORTS_FOLDER>/SIM/VendorDeliveryLabel/VendorDeliveryLabel.xdo
Inventory Adjustment Report	<BIP_SIM_REPORTS_FOLDER>/SIM/InventoryAdjustmentReport/InventoryAdjustmentReport.xdo
Inventory Adjustment AGSN Report	<BIP_SIM_REPORTS_FOLDER>/SIM/InventoryAdjustmentAGSNReport/InventoryAdjustmentAGSNReport.xdo
Item Basket Report	<BIP_SIM_REPORTS_FOLDER>/SIM/ItemBasketReport/ItemBasketReport.xdo
Item Detail Report	<BIP_SIM_REPORTS_FOLDER>/SIM/ItemDetailReport/ItemDetailReport.xdo
Purchase Order Report	<BIP_SIM_REPORTS_FOLDER>/SIM/PurchaseOrderReport/PurchaseOrderReport.xdo
RFID History Report	<BIP_SIM_REPORTS_FOLDER>/SIM/RFIDHistoryReport/RFIDHistoryReport.xdo
RTV Report	<BIP_SIM_REPORTS_FOLDER>/SIM/RTVReport/RTVReport.xdo
RTV Shipment Report	<BIP_SIM_REPORTS_FOLDER>/SIM/VendorShipmentReport/VendorShipmentReport.xdo
RTV Shipment BOL Report	<BIP_SIM_REPORTS_FOLDER>/SIM/VendorShipmentBOLReport/VendorShipmentBOLReport.xdo
RTV Shipment Container Report	<BIP_SIM_REPORTS_FOLDER>/SIM/VendorShipmentCartonReport/VendorShipmentCartonReport.xdo
RTV Shipping Label Report	<BIP_SIM_REPORTS_FOLDER>/SIM/VendorShippingLabel/VendorShippingLabel.xdo
Scan List Report	<BIP_SIM_REPORTS_FOLDER>/SIM/ReplenishmentGapReport/ReplenishmentGapReport.xdo
Shelf Adjustment Report	<BIP_SIM_REPORTS_FOLDER>/SIM/ShelfAdjustmentReport/ShelfAdjustmentReport.xdo
Shelf Replenishment Report	<BIP_SIM_REPORTS_FOLDER>/SIM/ShelfReplenishmentReport/ShelfReplenishmentReport.xdo
Stock Count All Location Report	<BIP_SIM_REPORTS_FOLDER>/SIM/StockCountAllLocReport/StockCountAllLocReport.xdo
Stock Count Report	<BIP_SIM_REPORTS_FOLDER>/SIM/StockCountReport/StockCountReport.xdo
Stock Count Export Report	<BIP_SIM_REPORTS_FOLDER>/SIM/StockCountExportReport/StockCountExportReport.xdo

Table 3-1 (Cont.) Report URL Location

Type	URL Location
Stock Count Rejected Item Report	<BIP_SIM_REPORTS_FOLDER>/SIM/StockCountRejectedItemReport/StockCountRejectedItemReport.xdo
Transfer Report	<BIP_SIM_REPORTS_FOLDER>/SIM/TransferReport/TransferReport.xdo
Transfer Receiving Report	<BIP_SIM_REPORTS_FOLDER>/SIM/TransferDeliveryReport/TransferDeliveryReport.xd
Transfer Receiving AGSN Report	<BIP_SIM_REPORTS_FOLDER>/SIM/TransferDeliveryAGSNReport/TransferDeliveryAGSNReport.xdo
Transfer Receiving Exception Report	<BIP_SIM_REPORTS_FOLDER>/SIM/TransferDeliveryExceptionReport/TransferDeliveryExceptionReport.xdo
Transfer Receiving Label Report	<BIP_SIM_REPORTS_FOLDER>/SIM/TransferDeliveryLabel/TransferDeliveryLabel.xdo
Transfer Shipment Report	<BIP_SIM_REPORTS_FOLDER>/SIM/TransferShipmentReport/TransferShipmentReport.xdo
Transfer Shipment BOL Report	<BIP_SIM_REPORTS_FOLDER>/SIM/TransferShipmentBolReport/TransferShipmentBolReport.xdo
Transfer Shipment Container Report	<BIP_SIM_REPORTS_FOLDER>/SIM/TransferShipmentCartonReport/TransferShipmentCartonReport.xdo
Transfer Shipping Label Report	<BIP_SIM_REPORTS_FOLDER>/SIM/TransferShippingLabel/TransferShippingLabel.xdo

Note: <BIP_SIM_REPORTS_FOLDER> is the folder where EICS reports have been uploaded on the BI Publisher server. For example, if EICS reports have been uploaded to the Guest folder, the folder is /Guest.

Previewing a Report

Users can download the report from EICS JET UI Home/Operations/Reports.

Figure 3-2 Reports Screen

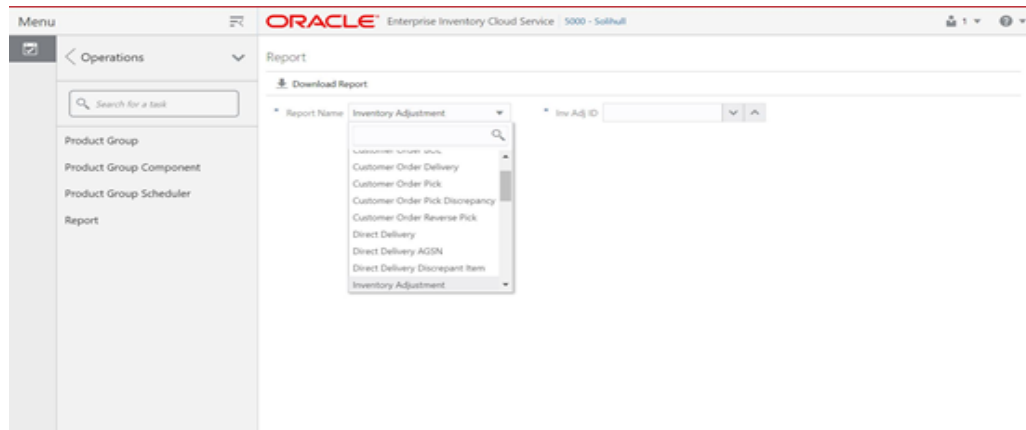

EICS Operational Reports

The following list shows the EICS Operational Reports.

Table 3–2 Operational Reports

Report Name	Report Parameters	Primary Views or Tables
Customer Order Bin Label Report	PICK_ID, COPIES	RPRT_FUL_ORD_BIN_V
Customer Order BOL Report	DELIVERY_ID, LOCALE_ID, STORE_ID, TIMEZONE, COPIES	RPRT_FUL_ORD_DLV_BOL_V
Customer Order Delivery Report	DELIVERY_ID, LOCALE_ID, STORE_ID, TIMEZONE, COPIES	RPRT_FUL_ORD_DLV_V
Customer Order Pick Discrepancy Report	PICK_ID, LOCALE_ID, STORE_ID, TIMEZONE, COPIES	RPRT_FUL_ORD_PICK_DISC_V
Customer Order Pick Report	PICK_ID, LOCALE_ID, STORE_ID, TIMEZONE, COPIES	RPRT_FUL_ORD_PICK_V
Customer Order Report	ORDER_ID, LOCALE_ID, STORE_ID, TIMEZONE, COPIES	RPRT_FUL_ORD_V
Customer Order Reverse Pick Report	REVERSE_PICK_ID, LOCALE_ID, STORE_ID, TIMEZONE, COPIES	RPRT_FUL_ORD_RV_PICK_V
Direct Delivery AGSN Report	CARTON_ID, COPIES	DSD_LINE_ITEM_UIN, ITEM_UIN
Direct Delivery Discrepant Items Report	RECEIPT_ID, LOCALE_ID, STORE_ID, TIMEZONE, COPIES	RPRT_DSD_DISCREPANT_ITEM_V, RPRT_DSD_V
Direct Delivery Label Report	CARTON_ID, LOCALE_ID	STOREDSD, DSD_CARTON, DSD_LINE_ITEM, SUPPLIER, ADDRESS,
Direct Delivery Report	RECEIPT_ID, LOCALE_ID, STORE_ID, TIMEZONE, COPIES	RPRT_DSD_V, NOTES
Inventory Adjustment AGSN Report	INV_ADJUST_ID, COPIES	ITEM_UIN, INV_ADJUST_LINE_ITEM_UIN

Table 3–2 (Cont.) Operational Reports

Report Name	Report Parameters	Primary Views or Tables
Inventory Adjustment Report	INV_ADJUST_ID, LOCALE_ID, STORE_TIMEZONE, COPIES	RPRT_INV_ADJUST_V, CONFIG_SYSTEM
Item Basket Report	ITEM_BASKET_ ID,LOCALE_ID,STORE_ TIMEZONE,COPIES	ITEM_BASKET, CODE_DETAIL
Item Detail Report	ITEMID, STOREID, LOCALE_ID, STORE_TIMEZONE, COPIES	STORE_SEQUENCE_ITEM, STORE_SEQUENCE_AREA, PRINT_FORMAT, TSF_ALLOCATION, ITEM, WAREHOUSE, RPRT_ITEM_DE TAIL_V
Purchase Order Report	PURCHASE_ORDER_ID, LOCALE_ID, STORE_TIMEZONE, COPIES	RPRT_PURCHASE_ORD_V
RFID History Report	ITEM_ID, FROM_DATE, TO_DATE, LOCALE_ID, COPIES	RPRT_RFID_HISTORY_V
RTV Report	RETURN_ID, LOCALE_ID, STORE_TIMEZONE, COPIES	RPRT_RTV_V
RTV Shipment BOL Report	SHIP_NUMBER, LOCALE_ID, STORE_TIMEZONE, COPIES	RPRT_RTV_SHIP_BOL_V, NOTES
RTV Shipment Container Report	CARTON_ID, LOCALE_ID, STORE_TIMEZONE, COPIES	RPRT_RTV_SHIP_V
RTV Shipment Report	SHIP_NUMBER, LOCALE_ID, STORE_TIMEZONE, COPIES	RPRT_RTV_SHIP_V

Table 3–2 (Cont.) Operational Reports

Report Name	Report Parameters	Primary Views or Tables
RTV Shipping Label Report	CARTON_ID, LOCALE_ID, COPIES	RPRT_RTV_SHIP_BOL_V, RTV_SHIP, CODE_DETAIL
Scan List Report	REPLENISH_GAP_ID, LOCALE_ID, STORE_TIMEZONE, COPIES	RPRT_REPLENISH_GAP_V
Shelf Adjustment Report	SHELF_ADJUST_ID, LOCALE_ID, STORE_TIMEZONE, COPIES	RPRT_SHELF_ADJUST_V
Shelf Replenishment Report	SHELF_REPLENISH_ID, LOCALE_ID, STORE_TIMEZONE, COPIES	RPRT_SHELF_REPLENISH_V
Stock Count All Location Report	STORE_ID, STOCK_COUNT_ID, COPIES	RPRT_STOCK_COUNT_V
Stock Count Detail Report	STOCK_COUNT_ID, STOCK_COUNT_CHILD_ID, STORE_TIMEZONE, PHASE, COPIES	RPRT_STOCK_COUNT_V
Stock Count Export Report	STOCK_COUNT_ID, COPIES	STOCK_COUNT_LINE_ITEM, STOCK_COUNT, STOCK_COUNT_LINE_ITEM_UIN
Stock Count Rejected Item Report	STORE_ID, LOCALE_ID, COPIES	RPRT_STOCK_COUNT_NOF_V
Transfer Receiving AGSN Report	CARTON_ID, COPIES	TSF_DELV_LINE_ITEM_UIN, ITEM_UIN
Transfer Receiving Exception Report	DELIVERY_ID, LOCALE_ID, STORE_TIMEZONE, COPIES	TSF_DELV, TSF_DELV_CARTON, TSF_DELV_LINE_ITEM, ITEM, STORE, WAREHOUSE, PARTNER, CONFIG_SYSTEM

Table 3–2 (Cont.) Operational Reports

Report Name	Report Parameters	Primary Views or Tables
Transfer Receiving Label Report	CARTON_ID,LOCALE_ID	TSF_DELV, TSF_DELV_CARTON, TSF_DELV_LINE_ITEM, STORE, ADDRESS
Transfer Receiving Report	DELIVERY_ID, LOCALE_ID, STORE_TIMEZONE, COPIES	TSF_DELV, TSF_DELV_CARTON, TSF_DELV_LINE_ITEM, ITEM, STORE_ITEM_STOCK, STORE, WAREHOUSE, PARTNER, CONFIG_SYSTEM, NOTES
Transfer Report	TRANSFER_ID, LOCALE_ID, STORE_TIMEZONE, COPIES	RPRT_TRANSFER_V
Transfer Shipment BOL Report	SHIPMENT_ID, LOCALE_ID, STORE_TIMEZONE, COPIES	TSF_SHIP,TSF_SHIP_ CARTON,TSF_SHIP_LINE_ ITEM,ITEM,CONFIG_ SYSTEM,SHIPMENT_ BOL,SHIPMENT_CARTON_ DIM,SHIPMENT_CARRIER_ SERVICE, SHIPMENT_CARRIER, STORE,ADDRESS,NOTES
Transfer Shipment Container Report	CARTON_ID, LOCALE_ID, STORE_TIMEZONE, COPIES	TSF_SHIP, TSF_SHIP_CARTON, TSF_SHIP_LINE_ITEM, ITEM, STORE, WAREHOUSE, PARTNER, CONFIG_SYSTEM, SHIPMENT_REASON
Transfer Shipment Report	SHIPMENT_ID, LOCALE_ID, STORE_TIMEZONE, COPIES	RPRT_TSF_SHIP_V, NOTES

Table 3-2 (Cont.) Operational Reports

Report Name	Report Parameters	Primary Views or Tables
Transfer Shipping Label	CARTON_ID, LOCALE_ID	TSF, TSF_SHIP, TSF_SHIP_CARTON, TSF_SHIP_LINE_ITEM, ITEM, SHIPMENT_BOL, STORE, ADDRESS

Internationalization

Internationalization is the process of creating software that can be translated easily. SIOCS has been internationalized to support multiple languages.

This section covers the following:

- [Supported Locales](#)
- [SOCS Client Translations](#)
- [EICS Client Translations](#)
- [EICS Server Translations](#)
- [Translation Topics](#)
- [Translation Keys](#)
- [Translation Setup Screen](#)
- [Translation File Upload](#)
- [Report Translations](#)

Supported Locales

SIOCS supports translation into following locales:

1. Arabic
2. Chinese (Simplified)
3. Chinese (Traditional)
4. Croatian
5. Dutch
6. English
7. French
8. German
9. Greek
10. Hungarian
11. Italian
12. Japanese
13. Korean

14. Polish
15. Portuguese (Brazilian)
16. Russian
17. Spanish
18. Swedish
19. Turkish

Apart from these, extension hooks are added for following new locales on EICS:

1. Albanian
2. Armenian
3. Azerbaijani
4. Belarusian
5. Bengali
6. Bosnian
7. Bulgarian
8. Burmese
9. Czech
10. Danish
11. Estonian
12. Filipino
13. Finnish
14. Georgian
15. Hebrew
16. Hindi
17. Indonesian
18. Kazakh
19. Khmer
20. Lao
21. Latvian
22. Lithuanian
23. Malay
24. Norwegian
25. Romanian
26. Serbian
27. Slovak
28. Slovene
29. Thai
30. Ukrainian

- 31. Urdu
- 32. Uzbek
- 33. Vietnamese

Translation records for these locales are defaulted to English. Translation value can be updated for these locales by accessing administration screen.

SOCS Client Translations

Translation of SOCS Graphical User Interface (GUI) and client-based display messages fall under this category.

SOCS client follows an XML format to organize translation records within a translation bundle. Each supported locale will have its own XLF file. For example, translations for French locale could be found under `SimMobileViewControllerBundle_fr.xlf` file. These XLF files are packaged with the rest of the application when the mobile application is built for deployment and any changes to them will require a new deployment of the mobile application.

EICS Client Translations

Translation of EICS Graphical User Interface (GUI) and client-based display messages fall under this category.

EICS Admin UI translations relies on following two bundle categories:

- Framework bundles: owned by JET/JRAF/LUX.
- EICS bundles: owned by EICS.

All these bundles are merged at runtime to provide an overall translation bundle which is used to provide translated UI content.

EICS owned translation are maintained in the EICS database. EICS client translation bundle is generated at runtime depending on the user locale and is applied on top of framework bundles by a custom plugin to provide an overall translation bundle for the client.

EICS Server Translations

Translation of server data, report data, notifications, server error messages, and other server-based message, fall under this category. These translation records are maintained in EICS database and are translated via a cached server translation provider.

Translation Topics

EICS translation records are grouped under translations topics for ease of management through the administration screens. Each translation key belonging to one of the translation topics below:

Table 4–1 Translation Topics

Translation Topic	Comments
Barcode	Captures translation keys for barcode processors.
Batch	Captures translation keys for batches.

Table 4–1 (Cont.) Translation Topics

Translation Topic	Comments
Carrier	Captures translation keys for shipment carrier and carrier services.
Code Info	Captures translation keys for code type and code details.
Configuration	Captures translation keys for system, store and store default configuration parameters.
Custom Attributes	Captures translation keys related to custom attributes.
Data	Captures translation keys related to system data like status, types and so on.
Date Import	Captures translation keys related to data import.
Inventory Adjustment Reason	Captures translation keys for inventory adjustment reason codes.
Isn Type	Captures translation keys related to ISN types.
Message	Captures translation keys related to server messages which are mostly error messages.
Non Sellable Type	Captures translation keys for non-sellable types.
Notification	Captures notification related translation keys
Reports	Captures translation keys related to reports.
Retail Home	Captures translation keys related to retail home tile reports.
Security	Captures translation keys for security permissions, groups and roles.
Shipment Reason	Captures translation keys for shipment reason codes.
UI	Captures translation keys related to user interface.

Translation Keys

EICS translation keys follow a dotted naming convention (for example, functional.area.key). The key name also identifies the functional area it belongs to which makes it easy to locate on the Translation Setup EICS Admin Client screen. Each key has a corresponding translation for each language. These translations can be modified using the administration screen.

Translation Setup Screen

This EICS admin client screen can be used to look up and edit EICS client and server translation records for a translation locale supported by the system. This screen does not support addition and deletion of translation records.

Bundle Selection Dialog

Bundle selection dialog automatically pops up when you navigate to the [Translation Setup Screen](#).

Select a bundle here and click **Apply** to load translation records.

Figure 4–1 Bundle Selection Dialog

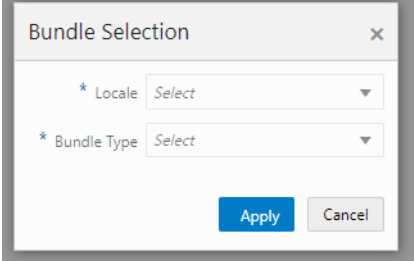

The dialog box titled "Bundle Selection" contains two dropdown menus. The first is labeled "* Locale" with a "Select" option. The second is labeled "* Bundle Type" with a "Select" option. At the bottom, there are two buttons: "Apply" (highlighted in blue) and "Cancel".

- **Locale Selection:** This drop down will list all the translation locales supported by EICS server.
- **Bundle Type Selection:** This drop down will list the translation bundles available for customization.

The screen supports following two bundle types:

- **Server:** This bundle identifies EICS Server translation records.
- **Operations UI:** This bundle identifies EICS Client translation records.

Dialog Buttons

- **Apply:** Clicking this button will load the translation records for the selected bundle criteria.
- **Cancel:** Clicking this button will close the dialog without performing any action.

Translation Setup Screen

The screen allows customization of EICS owned translation records only.

Figure 4–2 Translation Setup Screen

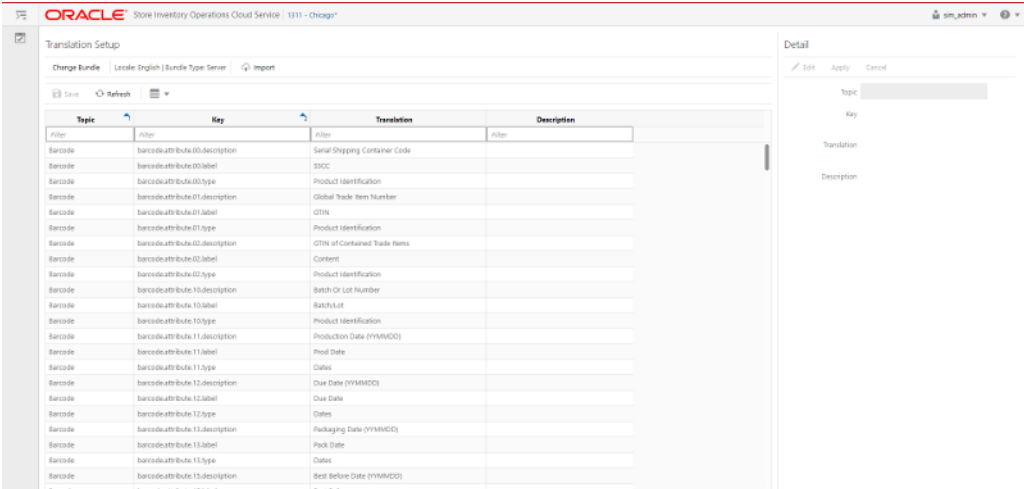

The screenshot shows the Oracle Store Inventory Operations Cloud Service interface. The main area is titled "Translation Setup" and includes a table with columns: Topic, Key, Translation, and Description. The table lists various barcode-related translation records. A "Detail" panel on the right shows the selected record's details.

Topic	Key	Translation	Description
Barcode	barcode@atf@bude@0.description	Serial Shipping Container Code	
Barcode	barcode@atf@bude@0.label	SSCC	
Barcode	barcode@atf@bude@0.type	Product Identification	
Barcode	barcode@atf@bude@01.description	Global Trade Item Number	
Barcode	barcode@atf@bude@01.label	GTIN	
Barcode	barcode@atf@bude@01.type	Product Identification	
Barcode	barcode@atf@bude@02.description	GTIN of Contained Trade Items	
Barcode	barcode@atf@bude@02.label	Content	
Barcode	barcode@atf@bude@02.type	Product Identification	
Barcode	barcode@atf@bude@10.description	Batch Or Lot Number	
Barcode	barcode@atf@bude@10.label	Batch/Lot	
Barcode	barcode@atf@bude@10.type	Product Identification	
Barcode	barcode@atf@bude@11.description	Production Date (YYMMDD)	
Barcode	barcode@atf@bude@11.label	Prod Date	
Barcode	barcode@atf@bude@11.type	Date	
Barcode	barcode@atf@bude@12.description	Exp Date (YYMMDD)	
Barcode	barcode@atf@bude@12.label	Exp Date	
Barcode	barcode@atf@bude@12.type	Date	
Barcode	barcode@atf@bude@13.description	Packaging Date (YYMMDD)	
Barcode	barcode@atf@bude@13.label	Pack Date	
Barcode	barcode@atf@bude@13.type	Date	
Barcode	barcode@atf@bude@15.description	Best Before Date (YYMMDD)	
Barcode	barcode@atf@bude@15.label	Best Before	
Barcode	barcode@atf@bude@15.type	Date	

Navigation: Main Menu/Admin/Translations/Translation Setup

Search Bar Options

- **Change Locale:** Clicking this button will popup bundle selection dialog.
- **Filter criteria:** This area displays the current search criteria.
- **Import:** Clicking this button will display the file import dialog. Refer to [Translation File Upload](#) section for more details.

List Buttons

- **Save:** Saves any changes made to the translation records.
- **Refresh:** Refreshes the translation records by loading them again.
- **Grid View Menu:** It's a drop down menu that provides access to options like reset view, enable/disable column filter and export grid data to a CSV file.

List Attributes

- **Topic:** Translation topic for the translation record.
- **Key:** Translation key for the translation record.
- **Translation:** Actual translated text for the translation record.
- **Description:** Any additional description for the translation record.

Detail Buttons

- **Edit:** Enable editing of translation record.
- **Apply:** Apply changes to the translation record.
- **Cancel:** Cancel any changes made to the translation record.

Detail Attributes

- **Topic:** Translation topic for the translation record. It is not editable.
- **Key:** Translation key for the translation record. It is not editable.
- **Translation:** Actual translated text for the translation record. It is editable.
- **Description:** Any additional description for the translation record. It is editable.

In addition to the Translation Setup screen, the system maintains translation records for the following JET screens:

Table 4-2 Translation Data JET Screens

JET Screen	Column
Barcode Processor	Processor Name
Carrier	Description
Carrier Service	Description
Code Info	Description
Inventory Adjustment	Description
Shipment Reason	Description
Sub-bucket	Description
Custom Flexible Attribute	Display Label
Role Detail	Description

Translation File Upload

Translation Setup Screen allow the user to upload translations file. This allow the user to update translations in a file and import that file into the product.

Clicking on the **Import** button on **Translation Setup Screen** displays this dialog that can be used to download the template and upload updated files for the current locale.

Figure 4-3 Import Translation File

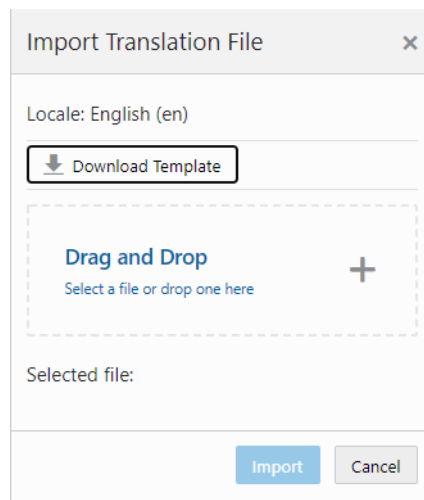

- **Locale:** It displays the selected locale.
- **Download Template:** Clicking on this button downloads a template CSV file which can be used to edit translation values across all available bundles for the selected locale. It does not matter which bundle is currently selected on the **Translation Setup Screen**. The file name would be of the format SIOCS_Translations_<locale>_Template.xlsx where locale is the selected locale.
- **Drag and Drop:** To select an updated file for import, the file can be dragged and dropped into the 'Drag and Drop' space on the dialog. Alternatively, a user can browse the file using the file selection wizard by clicking inside the 'Drag and Drop' space. File size should be > 0 MB and <= 5MB and should belong to the selected locale.
- **Selected File:** It displays the name of the selected file.
- **Import:** Clicking this button initiates the file import process. If there were any errors in the processing, an error file will be generated and the user will be prompted if they want to save the file.
- **Cancel:** Clicking this button will close the dialog without taking any action.

Report Translations

Translation of report templates fall under this category. EICS provides XLF files for each report. At runtime BI publisher identifies the user locale and selects the appropriate XLF file to translate report template.

This section information describes the following topics:

- [Batch Overview](#)
- [Batch Admin Users](#)
- [Batch Configuration](#)
- [Operational Batches](#)
- [BDI-Based Batches](#)
- [SFTP File-Based Batches](#)
- [Purge Batches](#)
- [Batch Job Administration](#)

Batch Overview

The batch processes are designed to process large volume of data.

The batch jobs which are available for the retailer can be differentiated in following categories:

Operational Batch Jobs

These jobs are mostly used to perform back ground operations on the transaction and includes such tasks as generation of a transaction, closing the transaction after a specified date is passed, auto confirmation of the transaction, and so on.

Data Purge Jobs

These jobs are used to perform the purge operation on the application table. Each job is designed to purge the data from specific functional database tables. The number for day to retain the records in database can be configured separately via System Administration parameters.

Importer Batch Jobs

These jobs are used to perform import data from another system.

Batch Admin Users

The following list shows the batch related users. For additional details, please see the *Oracle Retail Enterprise Inventory Cloud Service User Guide*.

Table 5–1 Batch Users and Roles

Job Duties	Application Role	Security Enterprise Group
Manage Batch System Configuration	ADMINISTRATOR	sim_admin_users
Access EICS Job Admin UI	ADMINISTRATOR	sim_admin_users
Manage EICS Adhoc Job	ADMINISTRATOR	sim_batch_users

Batch Configuration

To access the System Configuration screen, navigate Main Menu/Admin/Configuration/System Administration.

To view the Batch configuration, filter by Batch topic.

Figure 5–1 Batch System Administration Screen

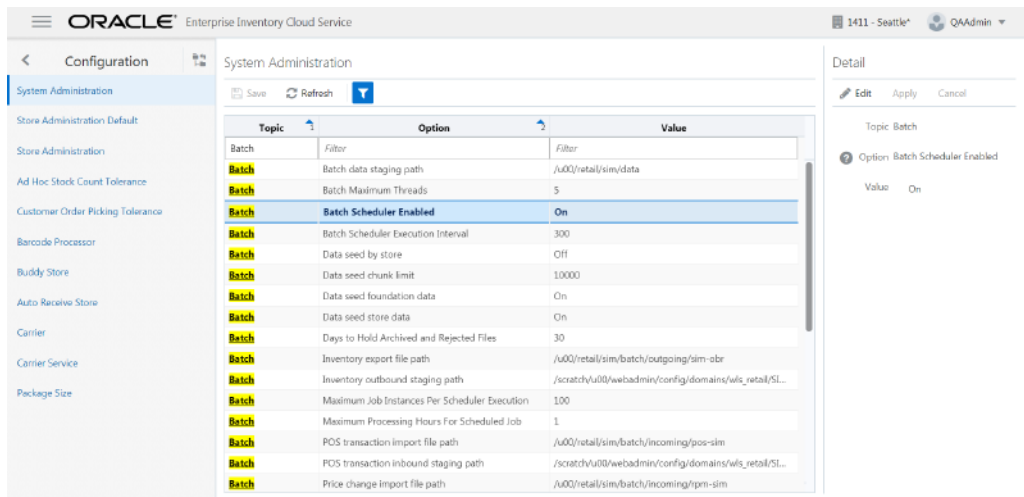

Table 5–2 Batch System Configuration Options

Name	Option	Description	Restricted
archive.dump.interval.days	Archive dump interval days	Interval in days to create dump files for archived purged data.	Yes
archive.max.rows.per.job	Archive maximum rows per batch job	Archive maximum rows per batch job.	Yes
batch.max.file.per.job	Batch.max.file.per.job	Batch max files per job run.	No
batch.job.max.threads	Batch Maximum Threads	Maximum number of threads to be instantiated for batch execution.	No
batch.data.staging.path	Batch data staging path	Base staging directory for the file processing.	Yes

Table 5–2 (Cont.) Batch System Configuration Options

Name	Option	Description	Restricted
days.to.hold.archived.rejected.files	Days to Hold Archived and Rejected Files	Number of day to hold the archived and rejected files after being processed.	No
file.out.stage.inventory.path	Inventory outbound staging path	Staging directory for the inventory extract file.	Yes
file.out.stage.stock.count.path	Stock count outbound staging path	Staging directory for the U/A Stock Count export file.	Yes
file.in.stage.pos.transaction.path	POS transaction inbound staging path	Staging directory for the POS transaction import file processing.	Yes
file.in.stage.price.change.path	Price Change inbound staging path	Staging directory for the Price change import file processing.	Yes
file.in.stage.resa.path	Retail sale audit inbound staging path	Staging directory for the Sales audit import file processing.	Yes
file.in.stage.stock.count.path	Stock count inbound staging path	Staging directory for the Third party stock count import file processing.	Yes
file.in.stage.store.sequence.path	Store sequence inbound staging path	Staging directory for the Sequencing data import file processing.	Yes
file.in.stage.warehouse.stock.path	Warehouse item stock inbound staging path	Staging directory for the Warehouse inventory import file processing.	Yes
days.to.hold.archived.rejected.files	Days to Hold Archived and Rejected Files	Number of day to hold the archived and rejected files after being processed.	No
file.import.pos.transaction.path	POS transaction import file path	Incoming directory for POS transaction zip files.	Yes
file.import.price.change.path	Price change import file path	Incoming directory for Price change zip files. This is for on-Premise RPM, will be phased out in future release.	Yes
file.import.resa.path	Retail sale audit import file path	Incoming directory for Sales audit zip files.	Yes
file.import.stock.count.path	Third party stock import file path	Incoming directory for Third party stock count zip files.	Yes
file.import.store.sequence.path	Store sequence import file path	Incoming directory for store sequencing zip files.	Yes
file.import.warehouse.stock.path	Warehouse item stock import file path	Incoming directory for warehouse inventory import zip files.	Yes
file.export.inventory.path	Inventory export file path	Outgoing directory for inventory extract zip files.	Yes
file.export.stock.count.path	Stock count export file path	Outgoing directory for U/A Stock count extract zip files.	Yes

Table 5–2 (Cont.) Batch System Configuration Options

Name	Option	Description	Restricted
search.limit.batch.job.days	Search Limit Default for Batch Job Days	Default number of days search limit to load the job activity.	No
dataseed.by.store	Data seed by store	Enables/Disables data seeding per store.	Yes
dataseed.chunk.limit	Data seed chunk limit	Chunk limit for records processed in data seeding.	Yes
dataseed.foundation.enabled	Data seed foundation data	Enables/Disables the foundation data seeding.	Yes
dataseed.storedata.enabled	Data seed store data	Enables/Disables the store data seeding.	Yes
file.export.arvdump.path	Archive dump file export path	Archive dump file export path.	Yes
file.out.stage.arvdump.path	Archive dump file outbound staging path	Archive dump file outbound staging path.	Yes
procedure.logPurgingInfo.enabled	Procedure Log Purging Info Enabled	Procedure Log Purging Info Enabled.	Yes
sftp.mfcs.dest.path	MFCS SFTP incoming default path	MFCS SFTP incoming default path. For example, /mfcsftpuser.	Yes
sftp.mfcs.file.out.compress	MFCS Compress data files	MFCS Compress data files. If true, compress data files in zip file.	Yes
sftp.mfcs.file.out.push	MFCS SFTP push	MFCS SFTP push. if true, push data files to MFCS sftp default incoming path; if set to false, the files will be moved to EICS's sftp export location.	Yes
sftp.mfcs.host	MFCS SFTP host	MFCS SFTP host	Yes
sftp.mfcs.port	MFCS SFTP port	MFCS SFTP port	Yes
sftp.mfcs.user.name	MFCS SFTP User	MFCS SFTP User name	Yes
sftp.obr.dest.path	Order Broker SFTP incoming default path	Order Broker SFTP incoming default path, for example, /obrftuser.	Yes
sftp.obr.file.out.compress	Order Broker Compress data files	Order Broker Compress data files. If true, compress data files in zip file.	Yes
sftp.obr.file.out.push	Order Broker SFTP push	Order Broker SFTP push. if true, push data files to OBR sftp default incoming path; if set to false, the files will be moved to EICS's sftp export location.	Yes
sftp.obr.host	Order Broker SFTP host	Order Broker SFTP host.	Yes
sftp.obr.port	Order Broker SFTP port	Order Broker SFTP port.	Yes

Table 5–2 (Cont.) Batch System Configuration Options

Name	Option	Description	Restricted
sftp.obr.user.name	Order Broker SFTP user	Order Broker SFTP user.	
sftp.push.max.files	The max files push to SFTP server per job run	The max files push to SFTP server per job run, default to 100 files.	Yes
sftp.push.timeout	The SFTP push timeout in milliseconds	The SFTP push timeout in milliseconds.	Yes
sftp.shell.log.path	The SFTP push shell script log path	The SFTP push shell script log path.	Yes
sftp.shell.working.path	The SFTP push shell script working path	The SFTP push shell script working path.	Yes

Note: Purge related configurations are listed under purge topic, for complete list of system configuration list, see [Configuration](#) chapter for details. Configuration marked as restricted can only be managed by sys op admin user.

Operational Batches

Operational batches are used to perform back ground operations on the transaction and includes such tasks as generation of a transaction, closing the transaction after a specified date is passed, auto confirmation of the transaction, and so on.

- [Archive Activity History](#)
- [Archive Dump](#)
- [Archive RFID History](#)
- [Archive Store Item Stock History](#)
- [Archive Item Uin History](#)
- [Auto Replenish Capacity](#)
- [Cleanup Batch Directories](#)
- [Cleanup Shelf Replenishment](#)
- [DSD Receiving Closure](#)
- [Fulfillment Order Reminders](#)
- [Fulfillment Order Pick Reminders](#)
- [Generate Problem Line Stock Count](#)
- [Generate Unit Amount Stock Count](#)
- [Generate Unit Stock Count](#)
- [Inventory Extract File SFTP Push](#)
- [Item Basket Maintenance](#)
- [Item Price to History](#)
- [Product Group Schedule Clean up](#)
- [Return Not After Date Alert](#)

- [Stock Count Authorize Recovery](#)
- [Stock Count Export File SFTP Push](#)
- [Stock Count Unit and Amount Snapshots](#)
- [Transfer Close](#)
- [Transfer Delivery Auto Receive](#)
- [Transfer Delivery Close](#)
- [Transfer Not After Date Alert Batch](#)
- [Transfers Overdue](#)
- [Vendor Return Closure](#)

Archive Activity History

This batch moves aged activity history into archive table.

Batch Job Definition Name

Audits_ArchiveJob

Batch Job Parameters

<input_date>

Where input date parameter is defaulted to current timestamp if not specified. System batch input date format is used for parsing input date if specified.

Key Tables

Table 5–3 Key Tables for Archive Activity History

Table	Select	Insert	Update	Delete
ACTIVITY_HISTORY	Yes			Yes
ARV_ACTIVITY_HIST		Yes		

Archive Dump

This batch generates the Oracle data dump files from archived data purging record tables. After the data dump files are generated, the archived tables are truncated. For Archive Data Dump Files Export, see [Batch - Data Archive](#) chapter.

Batch Job Definition Name

ArchiveDump_OpsJob

Batch Job Parameters

<input_date>

Where input date parameter is defaulted to current timestamp if not specified. System batch input date format is used for parsing input date if specified.

Key Tables

Table 5–4 Key Tables for Archive Dump

Table	Select	Insert	Update	Delete
ARV_ACTIVITY_HIST	Yes			Yes
ARV_ITEM_UIN_HIST	Yes			Yes
ARV_STORE_ITEM_STOCK_HIST	Yes			Yes
ARV_RFID_HIST	Yes			Yes
ARV_EXPORT	Yes	Yes	Yes	

Archive RFID History

This batch moves aged RFID history records into archive table.

Batch Job Definition Name

RfidHistory_ArchiveJob

Batch Job Parameters

N/A

Key Tables

Table 5–5 Key Tables for Archive RFID History

Table	Select	Insert	Update	Delete
RFID_HISTORY	Yes			
ARV_RFID_HIST		Yes		

Archive Store Item Stock History

This batch moves aged store item stock history records into archive table.

Batch Job Definition Name

StoreItemStockHistory_ArchiveJob

Batch Job Parameters

<input_date>

Where input date parameter is defaulted to current timestamp if not specified. System batch input date format is used for parsing input date if specified.

Key Tables

Table 5–6 Key Tables for Archive Store Item Stock History

Table	Select	Insert	Update	Delete
STORE_ITEM_STOCK_HISTORY	Yes			Yes
ARV_STORE_ITEM_STOCK_HIST		Yes		

Archive Item Uin History

This batch moves aged activity history into archive table.

Batch Job Definition Name

ItemUinHistory_ArchiveJob

Batch Job Parameters

<input_date>

Where input date parameter is defaulted to current timestamp if not specified. System batch input date format is used for parsing input date if specified.

Key Tables

Table 5–7 Key Tables for Archive Item Uin History

Table	Select	Insert	Update	Delete
ITEM_UIN_HISTORY	Yes			Yes
ARV_ITEM_UIN_HIST		Yes		

Auto Replenish Capacity

This job automatically updates the shopfloor to capacity for certain items based on a product group.

Batch Job Definition Name

AutoReplenishCapacity_OpsJob

Batch Job Parameters

<input_date>

input_dateinput date parameter is defaulted to current timestamp if not specified. System batch input date format is used for parsing input date if specified.

<store id>

Where store id is store identifier. If store id is not specified, then data for all managed stores will be processed in parallel processing.

Key Tables

Table 5–8 Key Tables for Auto Replenish Capacity Batch

Table	Select	Insert	Update	Delete
config_system	Yes			
shelf_replenish	Yes	Yes	Yes	Yes
shelf_replenish_line_item	Yes	Yes	Yes	Yes

Restart/Recovery

This batch can be re-run by starting a new batch job after the issues are resolved.

Cleanup Batch Directories

This job deletes the processed files from batch archive folder and failed files from reject folder of the respective job's directory. The retention period is specified by system configuration parameter **Days to Hold Archived and Rejected Files**.

Batch Job Definition Name

CleanupBatchDirectories_OpsJob

Batch Job Parameters

<input_date>

input_dateinput date parameter is defaulted to current timestamp if not specified. System batch input date format is used for parsing input date if specified.

Key Tables

Table 5–9 Key Tables for Cleanup Batch Directories

Table	Select	Insert	Update	Delete
ACTIVITY_HISTORY	Yes			

Cleanup Shelf Replenishment

The end of day batch process runs at the end of each day to reset the delivery bay and close any open pending shelf replenishments. The system takes the entire inventory from the delivery bay and moves it to the back room. Any pending or in progress shelf replenishment are changed to a cancelled state. Users who are performing a shelf replenishment are kicked out of the system. That is, the batch process takes over the shelf replenishment user's application activity locking. The current user's shelf replenishment process is discarded without being saved. After the batch process is run, all shelf replenishments are either completed or cancelled, and the delivery bay has zero inventory.

Batch Job Definition Name

CleanupShelfReplenishment_OpsJob

Batch Job Parameters

input_date>

input_dateinput date parameter is defaulted to current timestamp if not specified. System batch input date format is used for parsing input date if specified.

Key Tables

Table 5–10 Key Tables for Cleanup Shelf Replenishment Batch

Table	Select	Insert	Update	Delete
shelf_replenish			Yes	
stock_item_stock			Yes	

DSD Receiving Closure

This batch program looks for all the open vendor deliveries whose expected date added to store parameter “Auto Close Days after Expected Date” is before today and automatically confirms all the vendor deliveries.

Batch Job Definition Name

DSDReceivingClosure_OpsJob

Batch Job Parameters

<input_date>

Where input date parameter is defaulted to current timestamp if not specified. System batch input date format is used for parsing input date if specified.

Key Tables

Table 5–11 Key Tables for Close DSD Receiving Batch

Table	Select	Insert	Update	Delete
activity_history		Yes		
config_store	Yes			
dsd	Yes		Yes	
dsd_carton	Yes		Yes	
dsd_line_item	Yes		Yes	
dsd_line_item_att	Yes		Yes	
dsd_line_item_uin	Yes		Yes	
inv_adjust_reason	Yes			
purchase_order	Yes		Yes	
stock_item_v	Yes			
store	Yes			

Fulfillment Order Pick Reminders

This batch process sends out e-mail alerts for fulfillment order picks for which create date has expired by minutes to hold customer orders before sending e-mail alert parameter value and the status is new or in progress.

Batch Job Definition Name

FulfillmentOrderPickReminders_OpsJob

Batch Job Parameters

<input_date>

Where input date parameter is defaulted to current timestamp if not specified. System batch input date format is used for parsing input date if specified.

Key Tables

Table 5–12 Key Tables for Fulfillment Order Pick Reminders Batch

Table	Select	Insert	Update	Delete
ful_ord_pick	Yes			
ful_ord_pick_line_item	Yes			
store_item_stock	Yes			
store	Yes			
config_system	Yes			

Fulfillment Order Reminders

This batch process sends out e-mail alerts for fulfillment orders for which create date has expired by minutes to hold customer orders before sending e-mail alert parameter value.

Batch Job Definition Name

FulfillmentOrderReminders_OpsJob

Batch Job Parameters

<input_date>

Where input date parameter is defaulted to current timestamp if not specified. System batch input date format is used for parsing input date if specified.

<store id>

Where store id is store identifier. If store id is not specified, then data for all managed stores will be processed in parallel processing.

Key Tables

Table 5–13 Key Tables for Fulfillment Order Reminders Batch

Tables	Select	Insert	Update	Delete
config_system	Yes			
config_store	Yes			
store	Yes			
store_item_stock	Yes			
ful_ord	Yes			
ful_ord_line_item	Yes			

Generate Problem Line Stock Count

Before the batch process runs, the retailer establishes a group of items and item hierarchies (by associating them to the problem line group type) and selects applicable parameters (negative SOH, negative available, and so on). The problem line batch process goes through the list of items in the group, determining which fall within the parameters. The system automatically creates a stock count from those items that do fall within the parameters.

If an item is a problem line item (negative inventory for example) on a stock count, and the user does not get the chance to perform the stock count on it that day, the next day the item may no longer be a problem line (positive inventory). However, the system continues to create a stock count for that item because a problem existed at one time.

Batch Job Definition Name

GenerateProblemLineStockCount_OpsJob

Batch Job Parameters

<input_date>

Where input date parameter is defaulted to current timestamp if not specified. System batch input date format is used for parsing input date if specified.

<store id>

Where store id is store identifier. If store id is not specified, then data for all managed stores will be processed in parallel processing.

Key Tables

Table 5–14 Key Tables for Problem Line Stock Count Batch

Tables	Select	Insert	Update	Delete
group_schedule_extract	Yes	Yes		
prod_group_item_bkdn			Yes	Yes
stock_count	Yes	Yes	Yes	Yes
stock_count_line_item	Yes	Yes	Yes	Yes
stock_count_line_item_uin	Yes	Yes	Yes	Yes
stock_count_child	Yes	Yes	Yes	Yes
product_group_schedule	Yes		Yes	
product_group	Yes			
product_group_sched_store	Yes			
item	Yes			
store_item	Yes			
stock_count_line_item	Yes			

Generate Unit Amount Stock Count

This batch program generates Unit Amount stock counts.

On a daily basis, the batch process creates the stock counts that are scheduled for the current day or future date which matches the next scheduled date. The system looks at all the scheduled stock count records and determines whether any are scheduled for today or the user-specified future date. The process creates the stock counts for each individual store. For example, if a scheduled count includes a list of five stores, then five separate stock count records are created.

If an all-location stock count is being run, the batch processing generates individual counts for every macro sequence location.

The date parameter is optional when running the Extract Stock Counts batch. If no date is provided, today's date is used.

Batch Job Definition Name

GenerateUnitAmountStockCount_OpsJob

Batch Job Parameters

<input_date>

Where input date parameter is defaulted to current timestamp if not specified. System batch input date format is used for parsing input date if specified.

<store id>

Where store id is store identifier. If store id is not specified, then data for all managed stores will be processed in parallel processing.

Key Tables

Table 5–15 Key Tables for Generate Unit Amount Stock Count Batch

Table	Select	Insert	Update	Delete
group_schedule_extract		Yes		Yes
product_group	Yes			
product_group_hierarchy	Yes			
product_group_item	Yes			
product_group_sched_store	Yes			
product_group_schedule	Yes		Yes	
product_group_item_bkdn		Yes		Yes
stock_count	Yes	Yes	Yes	
stock_count_child		Yes	Yes	
stock_count_line_item		Yes	Yes	
stock_count_line_item_uin		Yes	Yes	
item	Yes			
store_item	Yes			
store_item_stock	Yes			
item_component	Yes			

Generate Unit Stock Count

This batch program generates Unit stock counts.

On a daily basis, the batch process creates the stock counts that are scheduled for the current day or future date which matches the next scheduled date. The system looks at all the scheduled stock count records and determines whether any are scheduled for today or the user specified future date. The process creates the stock counts for each individual store. For example, if a scheduled count includes a list of five stores, then five separate stock count records are created.

If the system is configured to use unguided stock counts, the batch process does not generate multiple counts even if the item is located at multiple locations within the store.

The date parameter is optional when running the Extract Stock Counts batch. If no date is provided, today's date is used.

Batch Job Definition Name

GenerateUnitStockCount_OpsJob

Batch Job Parameters

<input_date>

Where input date parameter is defaulted to current timestamp if not specified. System batch input date format is used for parsing input date if specified.

<store id>

Where store id is store identifier. If store id is not specified, then data for all managed stores will be processed in parallel processing.

Key Tables

Table 5–16 Key Tables for Generate Unit Stock Count Batch

Table	Select	Insert	Update	Delete
group_schedule_extract		Yes		Yes
product_group	Yes			
product_group_hierarchy	Yes			
product_group_item	Yes			
product_group_sched_store	Yes			
product_group_schedule	Yes		Yes	
product_group_item_bkdn		Yes		Yes
stock_count	Yes	Yes	Yes	Yes
stock_count_child		Yes	Yes	Yes
stock_count_line_item		Yes	Yes	Yes
stock_count_line_item_uin		Yes	Yes	
item	Yes			
store_item	Yes			
store_item_stock	Yes			
item_component	Yes			

Inventory Extract File SFTP Push

This batch scan the inventory extract staging out directories, move the files which have the completer files from EICS app server to Order Broker SFTP Server if system configuration - **OBR SFTP push** is set to true.

Batch Job Definition Name

InventoryExtractSftpPush_OpsJob

Batch Job Parameters

<input_date>

Where input_date is defaulted to current timestamp if not specified. System batch input date format is used for parsing input date if specified.

Key Tables

N/A

Restart/Recovery

This batch can be re-run by starting a new batch job after the issues are resolved.

Item Basket Maintenance

This batch updates the item basket status cancelled when item basket have expired.

Batch Job Definition Name

ItemBasketMaintenance_OpsJob

Batch Job Parameters

<input_date>

Where input_date is defaulted to current timestamp if not specified. It is used for comparing if a record date is a configured number of days prior to the input date. System batch input date format is used for parsing input date if specified.

Key Tables

Table 5-17 Key Tables for Item Basket Maintenance Batch

Table	Select	Insert	Update	Delete
config_system	Yes			
Item_basket	Yes		Yes	

Restart/Recovery

This batch can be re-run by starting a new batch job after the issues are resolved.

Item Price to History

This batch writes the active item price records into item price history table. After the active item prices are recorded in the item price history table, the batch updates the ITEM_PRICE table statuses as completed for these records.

Batch Job Definition Name

ItemPriceToHistory_OpsJob

Batch Job Parameters

<input_date>

Where input date parameter is defaulted to current timestamp if not specified. System batch input date format is used for parsing input date if specified.

<store id>

Where store id is store identifier. If store id is not specified, then data for all managed stores will be processed in parallel processing.

Key Tables

Table 5–18 Key Tables for Item Price to History Batch

Table	Select	Insert	Update	Delete
item_price	Yes		Yes	Yes
item_price_history		Yes		

Product Group Schedule Clean up

This batch program searches for all open product group schedules that have ended date before today (or user specified date), and change the product group schedule status to closed.

Batch Job Definition Name

ProductGroupScheduleCleanup_OpsJob

Batch Job Parameters

<input_date>

Where input date parameter is defaulted to current timestamp if not specified. System batch input date format is used for parsing input date if specified.

Key Tables

Table 5–19 Key Table for Close Prod Group Schedule Batch

Table	Select	Insert	Update	Delete
Product_group_schedule	Yes		Yes	

Return Not After Date Alert

This batch process warns users a number of days in advance that the RTV/RTW is about to reach the **Not After** date and must be dispatched. The value for the number of days of advance warning is configurable using the system's administration screens.

Batch Job Definition Name

ReturnNotAfterDateAlert_OpsJob

Batch Job Parameters

<input_date>

Where input date parameter is defaulted to current timestamp if not specified. System batch input date format is used for parsing input date if specified.

Key Tables

Table 5–20 Key Tables for Return Not After Date Alert Batch

Tables	Select	Insert	Update	Delete
rtv	Yes			
rtv_line_item	Yes			
shipment_reason	Yes			
stock_item	Yes			

Stock Count Authorize Recovery

This batch process looks for stock counts that are stuck in Authorize Processing state. This is a unique state that appears when an error occurs during the final processing of a stock count. The batch attempts to fully authorize the stock count. Errors that occur during the batch process are logged to the server error logs and will indicate the reason for any further processing failures. Successfully authorized stock counts will move to authorized completed state.

Batch Job Definition Name

StockCountAuthorizeRecovery_OpsJob

Batch Job Parameters

<input_date>

Where input date parameter is defaulted to current timestamp if not specified. System batch input date format is used for parsing input date if specified.

Key Tables

Table 5–21 Key Tables for Stock Count Authorize Recovery Batch

Tables	Select	Insert	Update	Delete
stock_count	Yes		Yes	
stock_count_child	Yes		Yes	
stock_count_line_item	Yes		Yes	
stock_count_line_item_uin	Yes			

Table 5–21 (Cont.) Key Tables for Stock Count Authorize Recovery Batch

Tables	Select	Insert	Update	Delete
item_uin	Yes		Yes	
store_item	Yes			
store_item_stock			Yes	
product_group_schedule	Yes			
product_group_sched_store	Yes			
store	Yes			
stock_count_sale	Yes			Yes
inv_adjust_reason	Yes			

Stock Count Export File SFTP Push

This batch scan the stock count export staging out directories, move the files which have the completer files from EICS app server to MFCS SFTP Server if system configuration - MFCS SFTP push is set to true.

Batch Job Definition Name

StockCountExportSftpPush_OpsJob

Batch Job Parameters

<input_date>

Where input_date is defaulted to current timestamp if not specified. System batch input date format is used for parsing input date if specified.

Key Tables

N/A

Restart/Recovery

This batch can be re-run by starting a new batch job after the issues are resolved.

Stock Count Unit and Amount Snapshots

This job takes the snapshot of current inventory for Unit and Amount Type of Stock Counts for the items across all stores or for a specific store.

Batch Job Definition Name

StockCountUnitAndAmountSnapshot_OpsJob

Batch Job Parameters

<store id>

Where store id is store identifier. If store id is not specified, then data for all managed stores will be processed in parallel processing.

Key Tables

Table 5–22 Key Tables for Stock Count Unit And Amount Snapshot Batch

Table	Select	Insert	Update	Delete
stock_count	Yes		Yes	
stock_count_child	Yes		Yes	
stock_count_line_item	Yes		Yes	
Store_item	Yes			
store_item_stock	Yes			

Transfer Close

This batch program looks for all the open transfers which have passed their not after date and are in valid state for closure.

Batch Job Definition Name

TransferClose_OpsJob

Batch Job Parameters

<input_date>

Where input date parameter is defaulted to current timestamp if not specified. System batch input date format is used for parsing input date if specified.

Key Tables

Table 5–23 Key Tables for Close Transfers Batch

Table	Select	Insert	Update	Delete
activity_history		Yes		
config_store	Yes			
mps_staged_message		Yes		
store	Yes			
store_item_stock	Yes		Yes	
tsf	Yes		Yes	
tsf_line_item	Yes		Yes	
tsf_ship	Yes			
tsf_ship_carton	Yes			
tsf_ship_line_item	Yes			

Transfer Delivery Auto Receive

Transfer Delivery Auto Receive batch does the following:

- Retrieves a list of all stores.
- Retrieves the auto receive configuration option for the location types (Store, Warehouse, and Finisher).
- For each store, if the Auto Receive store parameter is set to Date Driven, then the batch auto-receives all deliveries that are in New and In Progress status and whose Ship Date added to the Auto Receive Number of Days is less than the current date.

Batch Job Definition Name

TransferDeliveryAutoReceive_OpsJob

Batch Job Parameters

<input_date>

Where input date parameter is defaulted to current timestamp if not specified. System batch input date format is used for parsing input date if specified.

Key Tables

Table 5–24 Key Tables for Auto Receive Transfer Deliveries

Table	Select	Insert	Update	Delete
activity_history		Yes		
config_store	Yes			
inv_adjust_reason	Yes			
item_uin	Yes		Yes	Yes
store_item_stock	Yes		Yes	
store_item_stock_history		Yes		
store_sequence_area	Yes			
store_sequence_item	Yes			
tsf	Yes		Yes	
tsf_allocation	Yes		Yes	
tsf_delv	Yes			
tsf_delv_carton	Yes		Yes	Yes
tsf_delv_line_item	Yes		Yes	
store	Yes			

Transfer Delivery Close

This batch program looks for all the open transfer deliveries and auto confirms all the transfer deliveries based on the store parameter "Auto Close Receipt".

When the parameter value is "0", close the deliveries at the end of day today and when value is "x" close the deliveries at the end of "x" days starting from today.

Batch Job Definition Name

TransferDeliveryClose_OpsJob

Batch Job Parameters

<input_date>

Where input date parameter is defaulted to current timestamp if not specified. System batch input date format is used for parsing input date if specified.

Key Tables**Table 5–25 Key Tables for Close Transfer Deliveries Batch**

Table	Select	Insert	Update	Delete
activity_history		Yes		
config_store	Yes			
inv_adjust_reason	Yes			
item_uin	Yes		Yes	Yes
store_item_stock	Yes		Yes	
store_item_stock_history		Yes		
store_sequence_area	Yes			
store_sequence_item	Yes			
tsf	Yes		Yes	
tsf_allocation	Yes		Yes	
tsf_delv	Yes			
tsf_delv_carton	Yes		Yes	Yes
tsf_delv_line_item	Yes		Yes	
store	Yes			

Transfer Not After Date Alert Batch

This batch process generates email alerts for any pending transfer requests with not after date coming up within number of days specified in the system parameter "Days to Send Email Alert Before Not After Date for Transfer Requests".

Batch Job Definition Name

TransferNotAfterDateAlert_OpsJob

Batch Job Parameters

<input_date>

Where input date parameter is defaulted to current timestamp if not specified. System batch input date format is used for parsing input date if specified.

Key Tables**Table 5–26 Key Tables for Transfers Not After Date Alert Batch**

Tables	Select	Insert	Update	Delete
tsf	Yes			
tsf_line_item	Yes			

Table 5–26 (Cont.) Key Tables for Transfers Not After Date Alert Batch

Tables	Select	Insert	Update	Delete
store	Yes			

Transfers Overdue

This batch process sends user e-mail for dispatched transfers which have not been received after a number of days. The value for the number of days of e-mail alert is configurable using the system's administration screen.

Batch Job Definition Name

TransfersOverdueBatch_OpsJob

Batch Job Parameters

<input_date>

Where input date parameter is defaulted to current timestamp if not specified. System batch input date format is used for parsing input date if specified.

Key Tables

Table 5–27 Key Tables for Transfers Overdue Batch

Tables	Select	Insert	Update	Delete
tsf_delv	Yes			
tsf_delv_carton	Yes			

Vendor Return Closure

This batch program looks for all the open vendor returns which are in valid state (Closed /Rejected) for closure.

Batch Job Definition Name

VendorReturnClosure_OpsJob

Batch Job Parameters

<input_date>

Where input date parameter is defaulted to current timestamp if not specified. System batch input date format is used for parsing input date if specified.

Key Tables

Table 5–28 Key Tables for Close Vendor Return

Table	Select	Insert	Update	Delete
rtv	Yes	Yes	Yes	
rtv_line_item	Yes	Yes	Yes	Yes
rtv_line_item_uin				Yes
store_item_stock	Yes		Yes	
shipment_reason	Yes			

BDI-Based Batches

BDI (Bulk Data Integration) is the Oracle Retail Integration tool for bulk data movement. The BDI infrastructure applications move data from one application to another. So there is data producing applications and data consuming applications. See [BDI-Based Batch Integration](#) in [Integration](#) chapter for BDI Integration Process details.

This section describes the importer details.

- [Clearance Transaction Import](#)
- [Price Change Transaction Import](#)
- [Rfid Transaction Import](#)
- [Third Party Pricing Import](#)
- [Warehouse Avail Inventory Import](#)

Clearance Transaction Import

This batch imports the clearance price changes from BDI Inbound Interface tables into EICS application tables. This importer job is an integral part of the Clearance Price BDI Process Flow.

Batch Job Definition Name

Clearance_Tx_ImporterJob

Batch Job Parameters

<dataSetId>

Key Tables

Table 5–29 Key Tables for Clearance Transaction Import

Table
CLEARANCE_IN
ITEM_PRICE

Price Change Transaction Import

This batch imports the regular price changes from BDI Inbound Interface tables into EICS application tables. This importer job is an integral part of the Price Change TX BDI Process Flow.

Batch Job Definition Name

PriceChange_Tx_ImporterJob

Batch Job Parameters

<dataSetId>

If dataSetId is not specified, then the each batch job run will find the last 5 datasets within last 7 days and process the datasets in parallel threads via Batch partitioning.

Key Tables**Table 5–30 Key Tables for Price Change Transaction Import****Table**

PRICE_CHANGE_IN
ITEM_PRICE

Rfid Transaction Import

This batch imports the external RFID from BDI Inbound Interface tables into EICS application tables.

This importer job is an integral part of the BDI process.

Batch Job Definition Name

ExtRfid_Tx_ImporterJob

Batch Job Parameters

<dataSetId>

If dataSetId is not specified, then the each batch job run will find the last 5 datasets within last 7 days and process the datasets in parallel threads via Batch partitioning.

Key Tables**Table 5–31 Key Tables for Rfid Transaction Import****Table**

EXT_RFID_IN
RFID

Third Party Pricing Import

This batch imports the external item pricing from BDI Inbound Interface tables into EICS application tables. This importer job is an integral part of the BDI process.

Batch Job Definition Name

ExtPrice_Tx_ImporterJob

Batch Job Parameters

<dataSetId>

If dataSetId is not specified, then the each batch job run will find the last 5 datasets within last 7 days and process the datasets in parallel threads via Batch partitioning.

Key Tables**Table 5–32 Key Tables for Third Party Pricing Import****Table**

EXT_PRICE_IN
ITEM_PRICE

Note: Special Notes to Pricing Imports:

By default EICS integrate with RPCS clearance and regular price change via BDI process flow.

EICS does not integrate with Promotion Offer interface due to it does not provide pricing at item/date level, so there is nothing for SIOCS to consume.

Third Party Pricing Import provides an alternative for import promotion data into EICS.

See [Appendix: Third Party Pricing Integration](#) for additional details.

Warehouse Avail Inventory Import

This batch imports the warehouse available inventory from BDI Inbound Interface tables into EICS application tables. This importer job is an integral part of the BDI process.

Batch Job Definition Name

InvAvailWh_Tx_ImporterJob

Batch Job Parameters

<dataSetId>

If dataSetId is not specified, then the each batch job run will find the last 5 datasets within last 7 days and process the datasets in parallel threads via Batch partitioning.

Key Tables

Table 5–33 Key Tables for Third Party Pricing Import

Table

INV_AVAIL_WH_IN

WAREHOUSE_ITEM

SFTP File-Based Batches

EICS SFTP-Based File batches are file integration via SFTP.

The following topics are covered:

- [High Level Batch File Process Overview](#)
- [Clearance Price Change Import \(with On-premise RPM\)](#)
- [Inventory Extract](#)
- [Pos Transaction Import](#)
- [Promotion Price Change Import \(with On-premise RPM\)](#)
- [Regular Price Change Import \(with On-premise RPM\)](#)
- [Retail Sale Audit Import](#)
- [Store Sequence Import](#)
- [Third Party Stock Count Import](#)

- [Warehouse Item Stock Import](#)
- [SFTP Nightly Batch File Uploads](#)

High Level Batch File Process Overview

- The file import job processes each file from incoming directory when a corresponding completer file presents. The completer is a zero byte file which indicates file transfer is complete and ready for processing.
- The batch file process also handle the movement of input, output and reject files to the respective directories.
- Output files and reject files will be pushed to outgoing for client review and usage.
- Incoming files can be placed on SFTP as single file or zipped by each file type.
- Outgoing files will be zipped by file type and pushed to outgoing location.

Clearance Price Change Import (with On-premise RPM)

See [Appendix: Pricing Import with On-premise RPM](#).

Note: Pricing file import with On-premise RPM will be phased out in future release.

See Clearance Transaction Import for clearance pricing integration with RPCS.

Inventory Extract

This batch extracts the inventory to a file that has been altered on or after the specified date for the specified store.

File Specification

File Name format: PRODUCT_LOCATION_INV_<store id>_<date in YYYYMMDDHH24MISS format>.txt

Where the store id is unique store identifier.

File Layout: See [Inventory Extract Export File Specification](#).

Batch Job Definition Name

InventoryExtract_OpsJob

Batch Job Parameters

<input_date>

Where input date parameter is defaulted to current timestamp if not specified. System batch input date format is used for parsing input date if specified.

<storeId>: If provided, only specified store will be processed. When store id is not specified, the batch will generate exports for all EICS managed stores.

Key Tables

Table 5–34 Key Tables for Inventory Extract Batch

Table	Select	Insert	Update	Delete
item	Yes			
store_item	Yes			
store_item_stock	Yes			

Pos Transaction Import

This batch imports pos transaction records from the flat file (SIMT-LOG file) that came from POS database staging table where polling timer framework will pick those staged requests and update the stock tables.

The batch process takes the sales/order transaction data and stage them to the database staging table from where they are picked up by the polling timer framework to update the store item's inventory buckets (for example, store item's total quantity, shop floor quantity), if applicable.

The file will contain both sale and order transactions. The batch will assign separate request IDs to sales and order transactions.

For sale transactions, a single request ID cannot contain more than MAX_VALUE = 500 transaction line items with an exception that a single transaction ID cannot span across multiple request IDs.

For order transactions, a single request ID cannot contain more than MAX_VALUE = 500 transaction line items with an exception that a single customer order ID cannot span across multiple request IDs.

The file contains transactions for a single store.

Each job run will pick number of files (defined by **Maximum Job Instances Per Batch**) in system configuration and process them in multi-threads. The number of files to be processed is default to 20, the value can be configured via system configuration screen.

Customer can set the job scheduler to be run multiple times per day by changing the schedule intervals.

File Specification

File Name format: SIMTLOG _<date in YYYYMMDDHH24MISS format>_<loc id>.dat

where loc id is the store identifier.

Note: The integration incoming files from file provider which are in old release which are not using the .zip and completer indicator file. EICS is backward compatible with the incoming files which are not in zip and without completer indicator file.

File Layout: See [POS Sale Transaction Import File Specification](#).

Batch Job Definition Name

PosTransactionImport_OpsJob

Batch Job Parameters

<File name>

If not specified, then the data file in incoming directory are processed.

File Error Handling

The batch job will be marked as failed if the file staging fails. The staging process is all or none transaction so if an error occurs during the batch process, none of the transactions in the file will be staged. The user will need to rerun the same file again after resolving any errors.

Key Tables

Table 5–35 Key Tables for Pos Transaction Import Batch

Table	Select	Insert	Update	Delete
pos_transaction	Yes	Yes		
item	Yes			
inv_adjust_reason	Yes			

Promotion Price Change Import (with On-premise RPM)

See [Appendix: Pricing Import with On-premise RPM](#).

Note: Pricing file import with On-premise RPM will be phased out in future release.

See [Appendix: Third Party Pricing Integration](#) batch for promotional price import as alternative.

Regular Price Change Import (with On-premise RPM)

See [Appendix: Pricing Import with On-premise RPM](#).

Note: Pricing file import with On-premise RPM will be phased out in future release.

See Price Change Transaction Import for price integration with RPCS.

Retail Sale Audit Import

This batch program imports sales/order transaction data (ReSA File) that originated in Oracle Retail Xstore Point of Service. The external audit system will provide in its sales upload file a percentage or quantity that indicates how much the inventory needs to be reduced by, in addition to the sold quantity.

For example, meat will become lighter as fluids evaporate. Other items, for example cheese or ham, will only be reduced when of the outside layers are cut off to sell the item.

The batch process takes the sales transaction data to update the store item's inventory buckets. From the batch program, SIOCS learns about inventory movement (that is, what is sold, what is returned, what is reserved and what is fulfilled). Once SIOCS attains the data, SIOCS assumes that sales should be taken from the store's shelf-related inventory buckets. This assumption is important to SIOCS 's shelf

replenishment processing. SIOCS assumes that returns should go to the backroom bucket; the system's logic is that returns must be inspected.

The batch takes the sales/order transaction data and stage them to the SIOCS database staging table from where they are picked up by the polling timer framework to update the store item's inventory buckets (for example, store item's total quantity, shop floor quantity), if applicable.

The file will contain both sales and order transactions. The batch job combines the transaction number and register number to form the transaction ID in SIOCS. Request IDs are assigned to the transactions in such a way that a single request ID will not contain more than MAX_SIZE=500 records with an exception that a single transaction ID should not span across multiple request IDs.

During processing staging records, batch also writes each failure record into a transaction log table.

Each job run will pick number of files (defined by Maximum Job Instances Per Batch) in system configuration and process them in multi-threads. The number of files to be processed is default to 20, the value can be configured via system configuration screen.

Customer can set the job scheduler to be run multiple times per day by changing the schedule intervals.

File Specification

File Name format: SIMT_<date in YYYYMMDDHH24MISS format>_<loc id>

Where <loc id> is store id.

File Layout: See [Retail Sale Audit Import File Specification](#) Specification.

Batch Job Definition Name

RetailSalesAuditImport_OpsJob

Batch Job Parameters

<File name>

If not specified, then the data file in incoming directory are processed.

File Error Handling

The batch job will be marked as failed if the file staging fails. The staging process is all or none transaction so if an error occurs during the batch process, none of the transactions in the file will be staged. The user will need to rerun the same file again after resolving any errors.

Key Tables

Table 5–36 Key Tables for Retail Sale Audit Import Batch

Table	Select	Insert	Update	Delete
pos_transaction		Yes		
inv_adjust_reason	Yes			

Store Sequence Import

This batch imports store sequencing information from a flat file. Before importing, the batch will delete the existing sequencing information including sequence items and sequence areas excluding no-location store area which is the default store sequence area.

Each job run will pick number of files (defined by **Maximum Job Instances Per Batch**) in system configuration and process them in multi-threads. The number of files to be processed is default to 20, the value can be configured via system configuration screen.

Customer can set the job scheduler to be run multiple times per day by changing the schedule intervals.

File Specification

File Name format: SSEQ_<date in YYYYMMDDHH24MISS format>_<loc id>

Where <loc id> is store id.

File Layout: See [Store Sequence Data Parser Import File Layout Specification](#).

Batch Job Definition Name

StoreSequenceImport_OpsJob

Batch Job Parameters

<File name>

If not specified, then the data file in incoming directory are processed.

File Error Handling

The file loading process is all or none transaction so if an error occurs during the batch process, none of the transactions in the file will be committed. The user will need to rerun the same file again after resolving any errors.

Key Tables

Table 5–37 Key Tables for Store Sequence Import Batch

Tables	Select	Insert	Update	Delete
store_sequence_area		Yes		Yes
store_sequence_item		Yes		Yes

Third Party Stock Count Import

This batch imports the stock count quantities which are setup in SIOCS and physical counting is conducted by a third party. The batch updates the store stock on hand quantities; invalid records are saved in the rejected item table.

When the stock count is set up as auto-authorize **Unit and Amount Stock Count**, a **Unit and Amount Stock Counts Export** file is generated as a result of stock count auto authorization. See [Appendix: Unit and Amount Stock Counts Export](#) for details.

Each job run will pick number of files (defined by **Maximum Job Instances Per Batch**) in system configuration and process them in multi-threads. The number of files to be processed is default to 20, the value can be configured via system configuration screen.

Customer can set the job scheduler to be run multiple times per day by changing the schedule intervals.

File Specification

File Name format: STK_<date in YYYYMMDDHH24MISS format>.dat

File Layout: See [Third Party Stock Count Parser Import File Layout Specification](#).

Batch Job Definition Name

ThirdPartyStockCountImport_OpsJob

Batch Job Parameters

<File name>

If not specified, then the data file in incoming directory are processed.

File Error Handling

The batch job will be marked as failed if the file staging fails. The staging process is all or none transaction so if an error occurs during the batch process, none of the transactions in the file will be staged. The user will need to rerun the same file again after resolving any errors.

Key Tables

Table 5–38 Key Tables for Third Party Stock Count Import Batch

Tables	Select	Insert	Update	Delete
stock_count_import	Yes		Yes	
stock_count_rejected_item		Yes		
stock_count	Yes		Yes	
stock_count_child	Yes		Yes	
stock_count_line_item	Yes		Yes	
item_price	Yes			
item	Yes			
store_item	Yes			
item_uin	Yes			
stock_count_line_item_uin	Yes			

Warehouse Item Stock Import

This batch imports the inventory of an items in a warehouse from flat files into warehouse item table. The batch updates the warehouse item total quantity.

Each job run will pick number of files (defined by **Maximum Job Instances Per Batch**) in system configuration and process them in multi-threads. The number of files to be processed is default to 20, the value can be configured via system configuration screen.

Customer can set the job scheduler to be run multiple times per day by changing the schedule intervals.

File Specification

File Name format: WHIMS_<date in YYYYMMDDHH24MISS format>.dat

File Layout: See [Warehouse Stock Import File Layout Specification](#).

Batch Job Definition Name

WarehouseItemStockImport_OpsJob

Batch Job Parameters

<File name>

If not specified, then the data file in incoming directory are processed.

File Error Handling

The import process is all or none transactions so if an error occurs during the batch process, the batch job will be marked as failed. The user will need to rerun the same file again after resolving any errors.

Key Tables**Table 5–39 Key Tables for Warehouse Item Stock Import Batch**

Tables	Select	Insert	Update	Delete
warehouse_item		Yes		Yes

SFTP Nightly Batch File Uploads

The following is the SFTP file upload process. The Private/Public Keys must be generated and the public Key must be associated with your SFTP Account for the file uploads. The [Adding Authorized Keys](#) section describes the step-by-step method to generate the Keys (2048 bit RSA Keys).

- [Adding Authorized Keys](#)
- [Login to WinSCP](#)
- [Uploading a Batch File](#)
- [Export File Downloads](#)

Adding Authorized Keys

Use this process to generate a 2048 bit RSA key and add the same to the SFTP server. With Windows, use the WinSCP tool or with Linux, use ssh-keygen.

1. Launch WinSCP and select Tools/Run PuttyGen.
2. Select SSH-2 RSA for the type of key to generate and enter 2048 for the number of bits in a generated key field and click **Generate**.

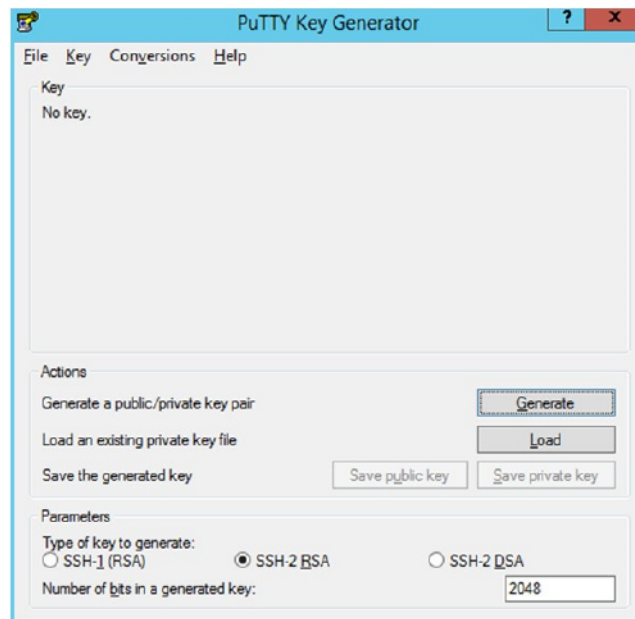
Figure 5–2 Key Generator

3. Move the mouse over the blank space in the window until the key is generated.

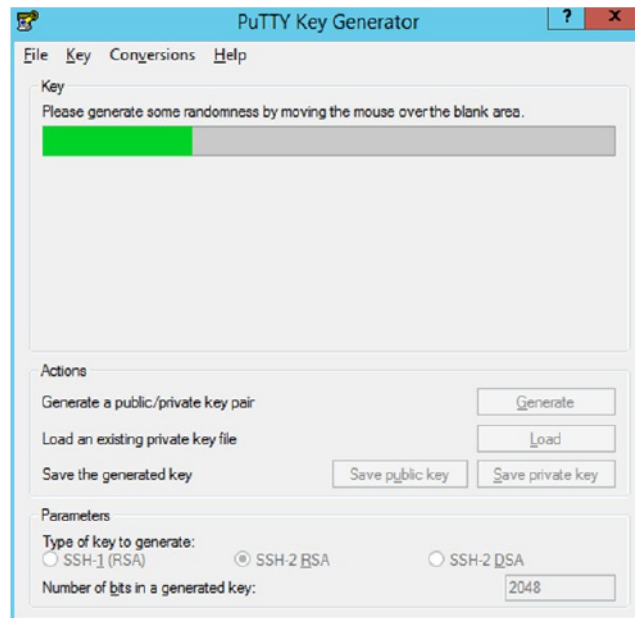
Figure 5–3 Key Generator Progress

4. Once the key is generated, click **Save public key** to save the public key to a file.
5. Click **Save private key** to save the Private key to a file. Confirm to save it with or without a passphrase.
6. Open an SR with Oracle Support, to associate the Public half of the Key with your SFTP account (attach the Key with the SR).

Login to WinSCP

These upload steps use the private key generated in section, [Adding Authorized Keys](#).

1. Launch WinSCP and connect to <SFTP Server> using port 22.
2. Enter the username and then click **Advanced**.
3. Click **Authentication**.
4. In the Private Key File field, click **Browse** and select the private key created in the section, [Adding Authorized Keys](#).

Figure 5–4 Advanced Site Settings

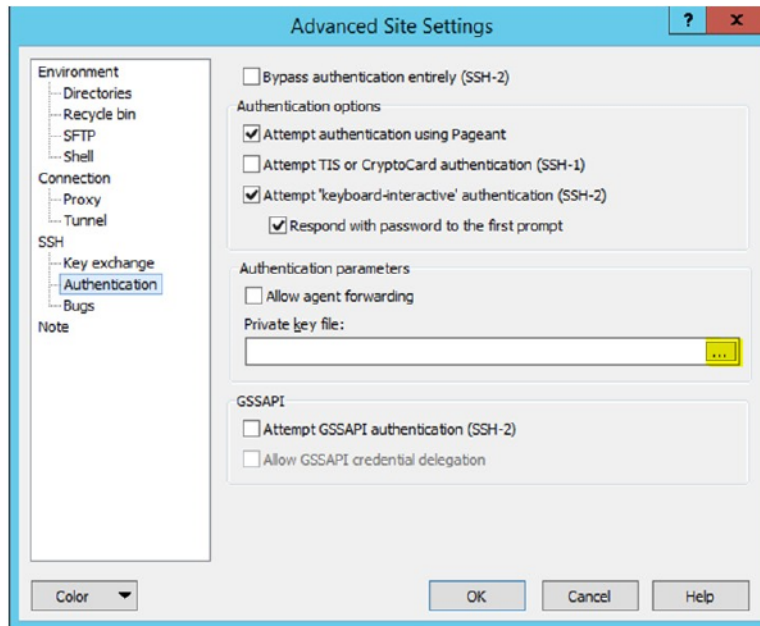

5. After loading the private key file, click **OK**.

Figure 5–5 Private Key File Loaded

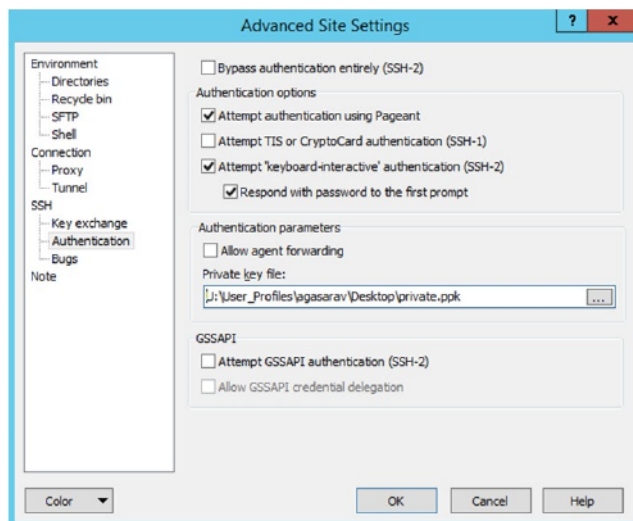

- Click **Login**. The window does not prompt for a password and logs into the SFTP server. Provide a passphrase if one has been set up.

Note: Login can only be performed using the authorized keys. Login with username / password is not supported.

Uploading a Batch File

Login to the WinSCP by following the steps in [Login to WinSCP](#).

- Transfer the file to be copied (for example, test) to /<SFTP User>.

Figure 5–6 <SFTP User> Directory

Name	Type	Changed	Name	Changed
..	Parent directory	2/9/2017 4:36:54 PM	..	2/8/2017 2:49:59 PM
test.complete	COMPLETE File	11/28/2016 9:43:43 PM	COMMAND	2/9/2017 4:36:48 PM
test	File	11/28/2016 9:43:43 PM	COMPLETE	11/28/2016 9:43:43 PM

- Transfer an empty file <filename>.complete (for example, test.complete) to the directory /<SFTP User>.

Figure 5–7 Transferring Empty File

Name	Type	Changed	Name	Changed
..	Parent directory	2/9/2017	..	2/8/2017 2:49:59 PM
test.complete	COMPLETE File	11/28/2016 9:43:43 PM	COMMAND	2/9/2017 4:36:48 PM
test	File	11/28/2016 9:43:43 PM	COMPLETE	11/28/2016 9:43:43 PM
			test	11/28/2016 9:43:43 PM
			test.complete	11/28/2016 9:43:43 PM

- If multiple files have to be transferred, copy all the files to /<SFTP_user>.

Figure 5–8 Transferring Multiple Files

Name	Type	Changed	Name	Changed
..	Parent directory	2/9/2017	..	2/8/2017 2:49:59 PM
test	File	11/28/2016 9:43:43 PM	COMMAND	2/9/2017 4:36:48 PM
test1	File	11/28/2016 9:43:43 PM	COMPLETE	11/28/2016 9:43:43 PM
test2	File	11/28/2016 9:43:43 PM	test	11/28/2016 9:43:43 PM
			test1	11/28/2016 9:43:43 PM
			test2	11/28/2016 9:43:43 PM

- Transfer all the corresponding <filename>.complete files to the /<SFTP_user> directory for the transfer to complete.

Figure 5–9 Transferring .complete Files

Name	Type	Changed	Name	Changed
..	Parent directory	2/9/2017	..	2/8/2017 2:49:59 PM
test.complete	COMPLETE File	11/28/20	COMMAND	2/9/2017 4:36:48 PM
test1.complete	COMPLETE File	11/28/20	COMPLETE	11/28/2016 9:43:43 PM
test2.complete	COMPLETE File	11/28/20	test	11/28/2016 9:43:43 PM
			test.complete	11/28/2016 9:43:43 PM
			test1	11/28/2016 9:43:43 PM
			test1.complete	11/28/2016 9:43:43 PM
			test2	11/28/2016 9:43:43 PM
			test2.complete	11/28/2016 9:43:43 PM

Export File Downloads

The following steps show the download file process.

1. Login to the WinSCP by following the steps in [Login to WinSCP](#).
2. Change the directory to /<SFTP User>/EXPORT.
3. Download all data files.

Purge Batches

- [Purge Adhoc Stock Count](#)
- [Purge Areas](#)
- [Purge Batch Log](#)
- [Purge Closed Transfers](#)
- [Purge Completed UIN Detail](#)
- [Purge DSD and Purchase Orders](#)
- [Purge Fulfillment Orders](#)
- [Purge Invalid Users](#)
- [Purge Invalid User Roles](#)
- [Purge Inventory Adjustments](#)
- [Purge Item](#)
- [Purge Item Baskets](#)
- [Purge Item Hierarchy](#)
- [Purge Item Price](#)
- [Purge Lockings](#)
- [Purge Notifications](#)
- [Purge Price Change Worksheet](#)
- [Purge Price Histories](#)
- [Purge Related Items](#)
- [Purge Resolved UIN Problems](#)
- [Purge RFID](#)
- [Purge Sales Posting](#)
- [Purge Shelf Adjustments](#)
- [Purge Shelf Adjustments](#)

- [Purge Staged Message](#)
- [Purge Stock Counts](#)
- [Purge Temporary UIN Detail](#)
- [Purge Ticket Histories](#)
- [Purge Vendor Returns](#)

Purge Adhoc Stock Count

PurgeAdHocStockCount batch does the following:

- Deletes ad hoc stock counts with a status of in progress.
- Any ad hoc stock count with a creation date/time stamp older than the **Days to Hold In Progress Ad Hoc Counts** parameter value will be deleted. For example, the default value is 1. If the batch program is run with the default value, the batch program would delete all in-progress counts more than 24 hours old.

This batch program deletes ad hoc stock counts with a status of in progress. Any ad hoc stock count with a creation date/time stamp older than the **Days to Hold In Progress Ad Hoc Counts** parameter value will be deleted. For example, the default value is 1. If the batch program is run with the default value, the batch program would delete all in-progress counts more than 24 hours old.

Batch Job Definition Name

AdhocStockCount_PurgeJob

Batch Job Parameters

<input_date>

Where input_date is defaulted to current timestamp if not specified. It is used for comparing if a record date is a configured number of days prior to the input date. System batch input date format is used for parsing input date if specified.

Key Tables

Table 5–40 Key Tables for Purge AdHoc Stock Count Batch

Tables	Select	Insert	Update	Delete
config_system	Yes			
stock_count	Yes			Yes
stock_count_rejected_item	Yes			Yes
stock_count_child	Yes			Yes
stock_count_line_item	Yes			Yes
stock_count_line_item_uin	Yes			Yes
stock_count_line_item_att	Yes			Yes

Restart/Recovery

This batch can be re-run from by starting a new batch job after the issues are resolved.

Purge Areas

Purges product basket records (with status of cancelled) based on the retention period. The retention period is specified by system configuration parameter- **Days to Hold Area**.

Batch Job Definition Name

ProductBasket_PurgeJob

Batch Job Parameters

<input_date>

Where input_date is defaulted to current timestamp if not specified. It is used for comparing if a record date is a configured number of days prior to the input date. System batch input date format is used for parsing input date if specified.

Key Tables

Table 5–41 Key Tables for Purge Area Batch

Tables	Select	Insert	Update	Delete
config_system	Yes			
product_basket_store	Yes			Yes
product_basket	Yes			Yes

Restart/Recovery

This batch can be re-run by starting a new batch job after the issues are resolved.

Purge Batch Log

Purge Batch Log batch does the following:

- Deletes old batch log records.
- Batch log record with an end date/timestamp older than the **Days To Hold Batch Logs** system configuration value and with the Status value of 2 (COMPLETED) is deleted. For example, if the default value is 30 and the batch program is run with the default value, the batch program would delete all the records that are more than 30 days old and are in completed status.
- Delete purge error logs.

Batch Job Definition Name

BatchLog_PurgeJob

Batch Job Parameters

<input_date>

Where input_date is defaulted to current timestamp if not specified. It is used for comparing if a record date is a configured number of days prior to the input date. System batch input date format is used for parsing input date if specified.

Key Tables

Table 5–42 Key Tables for Purge Batch Log Batch

Tables	Select	Insert	Update	Delete
config_system	Yes			
batch_data_error	Yes			Yes
batch_execution	Yes			Yes
purge_error_log	Yes			Yes
purge_error_log	Yes			Yes

Restart/Recovery

This batch can be re-run by starting a new batch job after the issues are resolved.

Purge Closed Transfers

Purge Closed Transfers batch does the following:

- Deletes all the closed transfer which are in either cancelled or completed status and shipments related to them.
- Any closed transfer with an update date older than the **Days to Hold Transfer Documents** parameter value will be deleted.
- For example, the default value is 30. If the batch program is run with the default value, the batch program would delete all closed transfers, transfer requests and related shipments which are closed and was last updated 30 days ago.

Batch Job Definition Name

ClosedTransfers_PurgeJob

Batch Job Parameters

<input_date>

Where input_date is defaulted to current timestamp if not specified. It is used for comparing if a record date is a configured number of days prior to the input date. System batch input date format is used for parsing input date if specified.

Key Tables

Table 5–43 Key Tables for Purge Closed Transfers Batch

Tables	Select	Insert	Update	Delete
config_system	Yes			
tsf	Yes			Yes
tsf_line_item				Yes
tsf_ship	Yes			Yes
tsf_ship_carton				Yes
tsf_ship_line_item	Yes			Yes
tsf_ship_line_item_uin				Yes
tsf_ship_line_item_att				Yes

Table 5–43 (Cont.) Key Tables for Purge Closed Transfers Batch

Tables	Select	Insert	Update	Delete
shipment_bol				Yes
tsf_delv	Yes			
tsf_delv_line_item	Yes			

Restart/Recovery

This batch can be re-run by starting a new batch job after the issues are resolved.

Purge Completed UIN Detail

Purge CompletedUINDetail batch does the following:

- Deletes completed UIN Detail records. A completed UIN is any UIN with a status of Removed from Inventory, Missing, Sold, Shipped to Vendor, or Shipped to Warehouse.
- Any UIN detail record with a complete status and update date at least X days in the past (where X is with system parameter **Days to Hold Completed UINs**) will be deleted from ITEM_UIN and ITEM_UIN_PROBLEM table.

Batch Job Definition Name

CompletedUin_PurgeJob

Batch Job Parameters

<input_date>

Where input_date is defaulted to current timestamp if not specified. It is used for comparing if a record date is a configured number of days prior to the input date. System batch input date format is used for parsing input date if specified.

Key Tables**Table 5–44 Key Tables for Purge Completed UIN Detail Batch**

Tables	Select	Insert	Update	Delete
config_system	Yes			
item_uin	Yes			Yes
item_uin_problem	Yes			Yes

Restart/Recovery

This batch can be re-run by starting a new batch job after the issues are resolved.

Purge DSD and Purchase Orders

Purge DSD Receiving and Purge orders batch process does the following:

- Deletes the Direct Store Delivery receiving.
- Any DSD record which is in Closed/Cancelled status and which has a complete date older than **Days to Hold Received Shipments** is an eligible record for purge.
- In effect, a DSD record can be purged only if its associated PO records can be purged.

Batch Job Definition Name

DsdAndPurchaseOrders_PurgeJob

Batch Job Parameters

<input_date>

Where input_date is defaulted to current timestamp if not specified. It is used for comparing if a record date is a configured number of days prior to the input date. System batch input date format is used for parsing input date if specified.

Key Tables

Table 5–45 Key Tables for Purge DSD Receivings Batch

Tables	Select	Insert	Update	Delete
config_system	Yes			
purchase_order	Yes			Yes
purchase_order_line_item	Yes			Yes
dsd	Yes			Yes
notes	Yes			Yes
dsd_adjustment	Yes			Yes
dsd_carton	Yes			Yes
dsd_line_item	Yes			Yes
dsd_line_item_uin	Yes			Yes
dsd_line_item_att	Yes			Yes
purchase_order	Yes			Yes
purchase_order_line_item				Yes

Restart/Recovery

This batch can be re-run by starting a new batch job after the issues are resolved.

Purge Fulfillment Orders

Purge Fulfillment Orders Batch does the following:

- Deletes all the fulfillment order records which are not in New or In Progress status and for which the update date has expired the purge_date by number of days more than **Days to Hold Customer Order** parameter value.
- Additionally, only those fulfillment orders will be deleted for which customer order ID and fulfillment order ID combination does not exist for any Transfer, Return, Purchase Order, and Warehouse delivery transaction.

Batch Job Definition Name

FulfillmentOrders_PurgeJob

Batch Job Parameters

<input_date>

Where input_date is defaulted to current timestamp if not specified. It is used for comparing if a record date is a configured number of days prior to the input date. System batch input date format is used for parsing input date if specified.

Key Tables

Table 5–46 Key Tables for Purge Fulfillment Orders Batch

Tables	Select	Insert	Update	Delete
config_system	Yes			
tsf	Yes			
purchase_order	Yes			
tsf_delv_line_item	Yes			
ful_ord	Yes			Yes
ful_ord_line_item	Yes			Yes
ful_ord_dlv	Yes			Yes
ful_ord_dlv_line_item	Yes			Yes
ful_ord_dlv_line_item_uin	Yes			Yes
ful_ord_dlv_line_item_att	Yes			Yes
ful_ord_rv_pick	Yes			Yes
ful_ord_rv_pick_line_item	Yes			Yes
ful_ord_pick	Yes			Yes
ful_ord_pick_line_item	Yes			Yes
ful_ord_bin	Yes			Yes

Restart/Recovery

This batch can be re-run by starting a new batch job after the issues are resolved.

Purge Invalid Users

This job deletes invalid application users from data store for those usernames are not found in identity store.

Batch Job Definition Name

InvalidUser_PurgeJob

Batch Job Parameters

<input_date>

Where input_date is defaulted to current timestamp if not specified. It is used for comparing if a record date is a configured number of days prior to the input date. System batch input date format is used for parsing input date if specified.

Key Tables

Table 5–47 Key Tables for Purge Invalid Users Batch

Tables	Select	Insert	Update	Delete
config_system	Yes			
security_user	Yes			
security_user_store	Yes			
security_user_role	Yes			Yes

Restart/Recovery

This batch can be re-run by starting a new batch job after the issues are resolved.

Purge Invalid User Roles

PurgeInvalidUserRoles batch program does the following:

- Removes all expired user roles and orphaned user roles (roles that were deleted by removing a store) from the SIOCS system.
- The batch process finds user role assignments that have an end date that is at least X days in the past (where X is specified by the system parameter **Days to Hold Expired User Roles**), and deletes these expired role assignments.
- The users (excluding super users) with role assignments that have no matching store assignments (orphaned role assignments) are also deleted from SECURITY_USER_ROLE table.

Batch Job Definition Name

InvalidUserRole_PurgeJob

Batch Job Parameters

<input_date>

Where input_date is defaulted to current timestamp if not specified. It is used for comparing if a record date is a configured number of days prior to the input date. System batch input date format is used for parsing input date if specified.

Key Tables

Table 5–48 Key Tables for Purge Invalid User Roles Batch

Tables	Select	Insert	Update	Delete
config_system	Yes			
security_user	Yes			
security_user_store	Yes			
security_user_role	Yes			Yes

Restart/Recovery

This batch can be re-run by starting a new batch job after the issues are resolved.

Purge Inventory Adjustments

Deletes inventory adjustments records with a create date/timestamp older than **Days To Hold Completed Inventory Adjustments** parameter value will be deleted. For example, the default value is 30. If the batch program is run with the default value, the batch program would delete all the inventory adjustment records, which are more than 30 days old.

Batch Job Definition Name

InventoryAdjustment_PurgeJob

Batch Job Parameters

<input_date>

Where input_date is defaulted to current timestamp if not specified. It is used for comparing if a record date is a configured number of days prior to the input date. System batch input date format is used for parsing input date if specified.

Key Tables

Table 5–49 Key Tables for Purge Inventory Adjustments Batch

Tables	Select	Insert	Update	Delete
config_system	Yes			
inv_adjust	Yes			Yes
inv_adjust_line_item	Yes			Yes
inv_adjust_line_item_uin	Yes			Yes
inv_adjust_line_item_att	Yes			Yes

Restart/Recovery

This batch can be re-run by starting a new batch job after the issues are resolved.

Purge Item

This batch program deletes items with a status of Delete (D).

There are two segments in the PurgeItem Batch which do the following different tasks:

- Validate if the Item should be deleted.
- Delete item from all associated tables if validation check is passed.
- Validate if the item should be deleted. The Validations include:
 - If SOH of item, item parent and item grandparent is 0.
 - If any transfers exist for item, item parent and item grandparent.
 - If any RTV exists for item, item parent and item grandparent.
 - If any Inventory adjustment exists for item, item parent and item grandparent and so on.
 - If any Item Basket exists for the item.
 - If any Product Group exists for the item.
 - If any Stock Count exists for the item.
 - If any Store Order exists for the item.
 - If any Item Request exists for the item.
 - If any Direct Store Delivery exists for the item.
 - If any Warehouse Delivery exists for the item.
- Delete item from all associated table. If the validations checks are met, the records related to the item which is marked for the purge action are deleted.

Batch Job Definition Name

Item_PurgeJob

Batch Job Parameters

<input_date>

Where input_date is defaulted to current timestamp if not specified. It is used for comparing if a record date is a configured number of days prior to the input date. System batch input date format is used for parsing input date if specified.

Key Tables

Table 5–50 Key Tables for Purge Item Batch

Tables	Select	Insert	Update	Delete
item_componen	Yes			Yes
Item	Yes			Yes
store_item_stock	Yes			
purchase_order_line_item	Yes			
rtv_line_item	Yes			
stock_count_line_item	Yes			
tsf_line_item	Yes			

Table 5–50 (Cont.) Key Tables for Purge Item Batch

Tables	Select	Insert	Update	Delete
rtv_ship_line_item	Yes			
dsd_line_item	Yes			
dsd_adjustment	Yes			
stock_count_line_item_uin	Yes			
tsf_ship_line_item	Yes			
tsf_delv_line_item	Yes			
item_basket_line_item	Yes			
print_store_order_item	Yes			
item_request_line_item	Yes			
ful_ord_line_item	Yes			
ful_ord_pick_line_item	Yes			
inv_adjust_line_item	Yes			
inv_adjust_template_item	Yes			
shelf_adjust_line_item	Yes			
shelf_replenish_line_item	Yes			
tsf_allocation	Yes			
item_uin	Yes			Yes
store_item	Yes			Yes
item_image	Yes			Yes
store_sequence_item	Yes			Yes
store_item_stock	Yes			Yes
store_item_stock_nonsell	Yes			Yes
supplier_item_manufacture	Yes			Yes
warehouse_item	Yes			Yes
partner_item	Yes			Yes
supplier_item_uom	Yes			Yes
supplier_item	Yes			Yes
supplier_item_country	Yes			Yes
supplier_item_country_dim	Yes			Yes
item_component	Yes			Yes
item_price	Yes			Yes

Table 5–50 (Cont.) Key Tables for Purge Item Batch

Tables	Select	Insert	Update	Delete
item_price_history	Yes			Yes
store_uin_admin_item	Yes			Yes
item_uda	Yes			Yes
product_group_item	Yes			Yes
related_item	Yes			Yes

Restart/Recovery

This batch can be re-run by starting a new batch job after the issues are resolved.

Purge Item Baskets

Purges item basket records (with status of cancelled or completed) based on the retention period. The retention period is specified by system configuration parameter-**Days to Hold Item Basket**.

Batch Job Definition Name

ItemBasket_PurgeJob

Batch Job Parameters

<input_date>

Where input_date is defaulted to current timestamp if not specified. It is used for comparing if a record date is a configured number of days prior to the input date. System batch input date format is used for parsing input date if specified.

Key Tables**Table 5–51 Key Tables for Purge Item Basket Batch**

Tables	Select	Insert	Update	Delete
config_system	Yes			
scan_block_item_att	Yes			Yes
scan_block	Yes			Yes
item_basket_line_item	Yes			Yes
item_basket_cda	Yes			Yes
item_basket_hierarchy	Yes			Yes
item_basket	Yes			Yes

Restart/Recovery

This batch can be re-run by starting a new batch job after the issues are resolved.

Purge Item Hierarchy

Purges all Item Hierarchies that is in delete status. It also records from referencing tables such as STOCK_COUNT_ADHOC_CONFIG and ITEM_HIERARCHY_ATTRIB.

Batch Job Definition Name

ItemHierarchy_PurgeJob

Batch Job Parameters

<input_date>

Where input_date is defaulted to current timestamp if not specified. It is used for comparing if a record date is a configured number of days prior to the input date. System batch input date format is used for parsing input date if specified.

Key Tables

Table 5–52 Key Tables for Purge Item Hierarchy Batch

Table	Select	Insert	Update	Delete
item	Yes			
product_group_hierarchy	Yes			
stock_count_adhoc_config	Yes			Yes
item_hierarchy_attrib	Yes			Yes
item_hierarchy	Yes			Yes

Restart/Recovery

This batch can be re-run by starting a new batch job after the issues are resolved.

Purge Item Price

Purge Item Price batch process does the following:

- Purges records which were expired or were marked as deleted from ITEM_PRICE table based on the retention period. The retention period is specified by system configuration parameter **Days to hold expired item price**.

Following are the rules defining records to be purged:

- **Regular Price Change:** Has status of completed or deleted, effective date was X number of days in the past (relative to the specified date if specified). At any given time, at least one completed latest regular price must be retained in ITEM_PRICE for a store item.
- **Promotion Change:** Has status of completed or deleted, and end date is number of days in the past (relative to the specified date if specified).
- **Clearance Change:** Has status of completed or deleted, and end date is number of days in the past (relative to the specified date if specified).

Batch Job Definition Name

ItemPrice_PurgeJob

Batch Job Parameters

<input_date>

Where input_date is defaulted to current timestamp if not specified. System batch input date format is used for parsing input date if specified.

<store id>

Where store id is store identifier. If store id is not specified, then data for all managed stores will be processed in parallel processing.

Key Tables**Table 5–53 Key Tables for Purge Item Price Batch**

Tables	Select	Insert	Update	Delete
item_price	Yes			Yes

Restart/Recovery

This batch can be re-run by starting a new batch job after the issues are resolved.

Purge Lockings

This batch process deletes lockings records from ACTIVITY_LOCK table. Any lock record with a lock date/timestamp older than **Days to Hold Locking Records** system configuration value will be deleted. For example, the default value is 30. If the batch program is run with the default value, the batch program would delete all the shelf replenishment records, which are more than 30 days old.

Batch Job Definition Name

Lockings_PurgeJob

Batch Job Parameters

<input_date>

Where input_date is defaulted to current timestamp if not specified. It is used for comparing if a record date is a configured number of days prior to the input date. System batch input date format is used for parsing input date if specified.

Key Tables**Table 5–54 Key Tables for Purge Lockings Batch**

Tables	Select	Insert	Update	Delete
config_system	Yes			
activity_lock	Yes			Yes

Restart/Recovery

This batch can be re-run by starting a new batch job after the issues are resolved.

Purge Notifications

This job deletes notifications. The retention period is specified by system configuration parameter **Days to Hold Notifications**.

Batch Job Definition Name

Notifications_PurgeJob

Batch Job Parameters

<input_date>

Where input_date is defaulted to current timestamp if not specified. It is used for comparing if a record date is a configured number of days prior to the input date. System batch input date format is used for parsing input date if specified.

Key Tables

Table 5–55 Key Tables for Purge Notifications Batch

Tables	Select	Insert	Update	Delete
config_system	Yes			
notification	Yes			Yes

Restart/Recovery

This batch can be re-run by starting a new batch job after the issues are resolved.

Purge Price Change Worksheet

This batch process deletes price change worksheet records from the staging table which are in Rejected/Completed status. Any price change record with an effective date/timestamp older than **Days To Hold Price Changes** parameter value will be deleted. For example, the default value is 30. If the batch program is run with the default value, the batch program would delete all the price change records, which are more than 30 days old.

Batch Job Definition Name

PriceChangeWorksheet_PurgeJob

Batch Job Parameters

<input_date>

Where input_date is defaulted to current timestamp if not specified. System batch input date format is used for parsing input date if specified.

<store id>

Where store id is store identifier. If store id is not specified, then data for all managed stores will be processed in parallel processing.

Key Tables

Table 5–56 Key Tables for Purge Price Change Worksheet Batch

Tables	Select	Insert	Update	Delete
config_system	Yes			

Table 5–56 (Cont.) Key Tables for Purge Price Change Worksheet Batch

Tables	Select	Insert	Update	Delete
price_change_worksheet	Yes			Yes
item_price				Yes

Restart/Recovery

This batch can be re-run by starting a new batch job after the issues are resolved.

Purge Price Histories

This batch process deletes price histories. At least a minimum of 4 historical prices are maintained for an item/store. **Days To Hold Price History** will determine the number of days that price histories can be kept in the database.

Batch Job Definition Name

PriceHistories_PurgeJob

Batch Job Parameters

<input_date>

Where input_date is defaulted to current timestamp if not specified. It is used for comparing if a record date is a configured number of days prior to the input date. System batch input date format is used for parsing input date if specified.

<store id>

Where store id is store identifier. If store id is not specified, then data for all managed stores will be processed in parallel processing.

Key Tables**Table 5–57 Key Tables for Purge Price Histories Batch**

Tables	Select	Insert	Update	Delete
config_system	Yes			
item_price_history	Yes			Yes

Restart/Recovery

This batch can be re-run by starting a new batch job after the issues are resolved.

Purge Related Items

This batch process deletes the related items for which the end date has expired for more than **Days To Hold Related Items** system configuration value.

Batch Job Definition Name

RelatedItems_PurgeJob

Batch Job Parameters

<input_date>

Where `input_date` is defaulted to current timestamp if not specified. It is used for comparing if a record date is a configured number of days prior to the input date. System batch input date format is used for parsing input date if specified.

Key Tables

Table 5–58 Key Tables for Purge Related Items Batch

Tables	Select	Insert	Update	Delete
<code>config_system</code>	Yes			
<code>related_item</code>	Yes			Yes

Restart/Recovery

This batch can be re-run by starting a new batch job after the issues are resolved.

Purge Resolved UIN Problems

Deletes resolved UIN exception records. UIN exception records with status of resolved and resolved date is at least X days in the past (where X is system parameter **Days to Hold Resolved UIN Exceptions**) are deleted from `ITEM_UIN_PROBLEM` table.

Batch Job Definition Name

`ResolvedUinProblem_PurgeJob`

Batch Job Parameters

<`input_date`>

Where `input_date` is defaulted to current timestamp if not specified. It is used for comparing if a record date is a configured number of days prior to the input date. System batch input date format is used for parsing input date if specified.

Key Tables

Table 5–59 Key Tables for Purge Resolved UIN Problems Batch

Table	Select	insert	Update	Delete
<code>config_system</code>	Yes			
<code>item_uin_problem</code>	Yes			Yes

Restart/Recovery

This batch can be re-run by starting a new batch job after the issues are resolved.

Purge RFID

This job deletes RFIDs which is not present in location. The retention period is specified by system configuration parameter **Days to Hold RFID**.

Batch Job Definition Name

`Rfid_PurgeJob`

Batch Job Parameters

<`input_date`>

Where `input_date` is defaulted to current timestamp if not specified. It is used for comparing if a record date is a configured number of days prior to the input date. System batch input date format is used for parsing input date if specified.

Key Tables

Table 5–60 Key Tables for Purge Notifications Batch

Tables	Select	Insert	Update	Delete
config_system	Yes			
Rfid	Yes			Yes

Restart/Recovery

This batch can be re-run by starting a new batch job after the issues are resolved.

Purge Sales Posting

This batch process deletes the Point-of-Service transaction from the Oracle Retail Xstore Point of Service transaction staging table. It reads the **Days to Hold Sales Posting** and **Days to Hold Failed Sales** configuration parameters and all the transactions which are present beyond the configuration parameter are deleted. It also purges the POS transaction logs for the request IDs that are in processed status.

Batch Job Definition Name

SalesPosting_PurgeJob

Batch Job Parameters

<input_date>

Where `input_date` is defaulted to current timestamp if not specified. It is used for comparing if a record date is a configured number of days prior to the input date. System batch input date format is used for parsing input date if specified.

Key Tables

Table 5–61 Key Tables for Purge Sales Posting Batch

Tables	Select	Insert	Update	Delete
config_system	Yes			
pos_transaction	Yes			
pos_transaction_log	Yes			

Restart/Recovery

This batch can be re-run by starting a new batch job after the issues are resolved.

Purge Shelf Adjustments

Purges shelf adjustment records (with status of completed) based on the retention period. The retention period is specified by system configuration parameter- **Days to Hold Shelf Adjustment List**.

Batch Job Definition Name

ShelfAdjustments_PurgeJob

Batch Job Parameters

<input_date>

Where input_date is defaulted to current timestamp if not specified. It is used for comparing if a record date is a configured number of days prior to the input date. System batch input date format is used for parsing input date if specified.

Key Tables

Table 5–62 Key Tables for Purge Shelf Adjustment Batch

Tables	Select	Insert	Update	Delete
config_system	Yes			
shelf_adjust_line_item	Yes			Yes
shelf_adjust_cda	Yes			Yes

Restart/Recovery

This batch can be re-run by starting a new batch job after the issues are resolved.

Purge Shelf Replenishment

This batch process deletes shelf replenishment lists which are in Completed/Cancelled state. Any shelf replenishment list record with a status date/timestamp older than **Days To Hold Shelf Replenishment** parameter value will be deleted. For example, the default value is 1. If the batch program is run with the default value, the batch program would delete all the pick list records, which are more than a day old.

In addition, the batch will also delete shelf adjustment lists which are in Complete state. Any shelf adjustment record with an update date/timestamp older than **Days to Hold Shelf Adjustment Lists** parameter value will be deleted.

Batch Job Definition Name

ShelfReplenishments_PurgeJob

Batch Job Parameters

<input_date>

Where input_date is defaulted to current timestamp if not specified. It is used for comparing if a record date is a configured number of days prior to the input date. System batch input date format is used for parsing input date if specified.

Key Tables

Table 5–63 Key Tables for Purge Shelf Replenishment Batch

Tables	Select	Insert	Update	Delete
config_system	Yes			
shelf_adjust	Yes			
product_group	Yes			
shelf_replenish_line_item	Yes			Yes
shelf_replenish	Yes			Yes

Restart/Recovery

This batch can be re-run by starting a new batch job after the issues are resolved.

Purge Staged Message

This batch finds integration staging records that are marked as processed or deleted, and update date is at least *X* days in the past (where *X* is the system parameter **Days to Hold Completed Staging Records**), the batch process deletes these records from MPS_STAGED_MESSAGE table.

Rebuilding the indexes on the MPS_STAGED_MESSAGE table each day is recommended after batch process completes.

Batch Job Definition Name

StagedMessage_PurgeJob

Batch Job Parameters

<input_date>

Where input_date is defaulted to current timestamp if not specified. It is used for comparing if a record date is a configured number of days prior to the input date. System batch input date format is used for parsing input date if specified.

Key Tables

Table 5–64 Key Tables for Purge Staged Message Batch

Tables	Select	Insert	Update	Delete
config_system	Yes			
mps_staged_message	Yes			Yes

Restart/Recovery

This batch can be re-run by starting a new batch job after the issues are resolved.

Purge Stock Counts

This batch process deletes stock counts which are in Completed/Cancelled status. Any stock count with a schedule date/timestamp older than **Days To Hold Completed Stock Counts** parameter value will get deleted. For example, the default value is 30. If the batch program is run with the default value, the batch program would delete all the stock return records, which are more than 30 days old.

Batch Job Definition Name

StockCounts_PurgeJob

Batch Job Parameters

<input_date>

Where input_date is defaulted to current timestamp if not specified. It is used for comparing if a record date is a configured number of days prior to the input date. System batch input date format is used for parsing input date if specified.

Key Tables

Table 5–65 Key Tables for Purge Stock Counts Batch

Table	Select	Insert	Update	Delete
config_system	Yes			
stock_count	Yes			Yes
stock_count_child	Yes			Yes
stock_count_rejected_item	Yes			Yes
shelf_replenish_line_item	Yes			Yes

Restart/Recovery

This batch can be re-run by starting a new batch job after the issues are resolved.

Purge Temporary UIN Detail

This batch process deletes temporary UIN detail records. UIN detail records with no status and update date is at least X days in the past (where X is system parameter **Days to Hold Temporary UINs**) are deleted from ITEM_UIN table.

Batch Job Definition Name

TemporaryUin_PurgeJob

Batch Job Parameters

<input_date>

Where input_date is defaulted to current timestamp if not specified. It is used for comparing if a record date is a configured number of days prior to the input date. System batch input date format is used for parsing input date if specified.

Key Tables

Table 5–66 Key Tables for Purge Temporary UIN Detail Batch

Table	Select	Insert	Update	Delete
Item_uin	Yes			Yes

Restart/Recovery

This batch can be re-run by starting a new batch job after the issues are resolved.

Purge Ticket Histories

Purges ticket history records based on the retention period. The retention period is specified by system configuration parameter- **Days to Hold Ticket History**.

Batch Job Definition Name

TicketHistory_PurgeJob

Batch Job Parameters

<input_date>

Where input_date is defaulted to current timestamp if not specified. It is used for comparing if a record date is a configured number of days prior to the input date. System batch input date format is used for parsing input date if specified.

Key Tables

Table 5–67 Key Tables for Purge Ticket Histories Batch

Table	Select	Insert	Update	Delete
config_system	Yes			
ticket_history	Yes			

Restart/Recovery

This batch can be re-run by starting a new batch job after the issues are resolved.

Purge Vendor Returns

This batch process deletes vendor returns which are in closed or completed status. Any vendor return record with a closed date/timestamp older than **Days to Hold RTV** system configuration value will be deleted. For example, the default value is 30. If the batch program is run with the default value, the batch program would delete all the vendor return records, which are more than 30 days old.

Batch Job Definition Name

VendorReturn_PurgeJob

Batch Job Parameters

<input_date>

Where input_date is defaulted to current timestamp if not specified. It is used for comparing if a record date is a configured number of days prior to the input date. System batch input date format is used for parsing input date if specified.

Key Tables**Table 5–68 Key Tables for Purge Vendor Returns Batch**

Tables	Select	Insert	Update	Delete
config_system	Yes			
rtv_ship	Yes			Yes
rtv_ship_line_item				Yes
rtv_ship_line_item_att				Yes
rtv_ship_line_item_uin				Yes
rtv		Yes		Yes
rtv_line_item				Yes
notes				Yes

Restart/Recovery

This batch can be re-run by starting a new batch job after the issues are resolved.

Data Purging Batches - BDI Staging Data

- [Purge BDI Inbound Price](#)
- [Purge BDI Item](#)
- [Purge BDI Item Loc](#)
- [Purge BDI Location](#)
- [Purge BDI Misc Group](#)
- [Purge BDI Price Hist](#)
- [Purge BDI Rfid](#)
- [Purge BDI Store Inventory Avail](#)
- [Purge BDI Supp Item](#)
- [Purge BDI UDA](#)
- [Purge BDI Warehouse Item Avail](#)

Purge BDI Inbound Price

This job deletes BDI pricing staging data. The retention period is default to 6 months.

Batch Job Definition Name

BdiTxPriceGrp_PurgeJob

Batch Job Parameters

<input_date>

input_date is defaulted to current timestamp if not specified. It is used for comparing if a record date is a configured number of days prior to the input date. System batch input date format is used for parsing input date if specified.

Key Tables**Table 5–69 Key Tables for Purge BDI Warehouse Item Avail****Tables**

EXT_PRICE_IN
 PRICE_CHANGE_IN
 CLERANCE_IN

Restart/Recovery

This batch can be restarted/re-run from previous failures after the issues are resolved.

Purge BDI Item

This job deletes BDI item hierarchy and item staging data. The retention period is default to 6 months.

Batch Job Definition Name

BdiFndMerchItemGrp_PurgeJob

Batch Job Parameters

<input_date>

input_date is defaulted to current timestamp if not specified. It is used for comparing if a record date is a configured number of days prior to the input date. System batch input date format is used for parsing input date if specified.

Key Tables**Table 5–70 Key Tables for Purge BDI Item****Tables**

ITEM_HDR_IN
 ITEM_IMAGE_IN
 MERCH_HIER_IN
 RELATED_ITEM_DTL_IN
 RELATED_ITEM_IN
 PACKITEM_BREAKOUT_IN

Restart/Recovery

This batch can be restarted/re-run from previous failures after the issues are resolved.

Purge BDI Item Loc

This job deletes item location records from BDI inbound interface staging tables. The retention period is default to 6 months.

Batch Job Definition Name

BdiFndItemLocGrp_PurgeJob

Batch Job Parameters

<input_date>

input_date is defaulted to current timestamp if not specified. It is used for comparing if a record date is a configured number of days prior to the input date. System batch input date format is used for parsing input date if specified.

Key Tables**Table 5–71 Key Tables for Purge BDI Item Loc**

Tables

ITEM_LOC_IN

REPL_ITEM_LOC_IN

Restart/Recovery

This batch can be restarted/re-run from previous failures after the issues are resolved.

Purge BDI Location

This job deletes BDI location entities and their addresses staging data. The retention period is default to 6 months.

Batch Job Definition Name

BdiFndLocationGrp_PurgeJob

Batch Job Parameters

<input_date>

input_date is defaulted to current timestamp if not specified. It is used for comparing if a record date is a configured number of days prior to the input date. System batch input date format is used for parsing input date if specified.

Key Tables**Table 5–72 Key Tables for Purge BDI Location**

Tables

PARTNER_IN

PARTNER_ADDR_IN

PARTNER_ORG_UNIT_IN

STORE_IN

STORE_ADDR_IN

SUPS_IN

SUPPLIER_ADDR_IN

SUPS_CFA_EXT_IN

WH_IN

WH_ADDR_IN

Restart/Recovery

This batch can be restarted/re-run from previous failures after the issues are resolved.

Purge BDI Misc Group

This job deletes BDI code and UOM miscellaneous staging data. The retention period is default to 6 months.

Batch Job Definition Name

BdiFndMiscGrp_PurgeJob

Batch Job Parameters

<input_date>

input_date is defaulted to current timestamp if not specified. It is used for comparing if a record date is a configured number of days prior to the input date. System batch input date format is used for parsing input date if specified.

Key Tables

Table 5–73 Key Tables for Purge BDI Misc Group

Tables

CODE_HEAD_IN

CODE_DETAIL_IN

DELIVERY_SLOT_IN

UOM_CONVERSION_IN

UOM_CLASS_IN

Restart/Recovery

This batch can be restarted/re-run from previous failures after the issues are resolved.

Purge BDI Price Hist

This job deletes BDI price history staging data. The retention period is default to 6 months.

Batch Job Definition Name

BdiFndPriceHist_PurgeJob

Batch Job Parameters

<input_date>

input_date is defaulted to current timestamp if not specified. It is used for comparing if a record date is a configured number of days prior to the input date. System batch input date format is used for parsing input date if specified.

Key Tables**Table 5–74 Key Tables for Purge BDI Price Hist**

Tables

PRICE_HIST_IN

Restart/Recovery

This batch can be restarted/re-run from previous failures after the issues are resolved.

Purge BDI Rfid

This job deletes BDI Rfid staging data. The retention period is default to 6 months.

Batch Job Definition Name

BdiTxRfid_PurgeJob

Batch Job Parameters

<input_date>

input_date is defaulted to current timestamp if not specified. It is used for comparing if a record date is a configured number of days prior to the input date. System batch input date format is used for parsing input date if specified.

Key Tables**Table 5–75 Key Tables for Purge BDI Rfid**

Tables

EXT_RFID_IN

Restart/Recovery

This batch can be restarted/re-run from previous failures after the issues are resolved.

Purge BDI Store Inventory Avail

This job deletes BDI Available store inventory staging data. The retention period is default to 6 months.

Batch Job Definition Name

BdiTxInvAvailStore_PurgeJob

Batch Job Parameters

<input_date>

input_date is defaulted to current timestamp if not specified. It is used for comparing if a record date is a configured number of days prior to the input date. System batch input date format is used for parsing input date if specified.

Key Tables**Table 5–76 Key Tables for Purge BDI Store Inventory Avail****Tables**

 INV_AVAIL_STORE_IN

Restart/Recovery

This batch can be restarted/re-run from previous failures after the issues are resolved.

Purge BDI Supp Item

This job deletes BDI Supplier items staging data. The retention period is default to 6 months.

Batch Job Definition Name

BdiFndSupItemGrp_PurgeJob

Batch Job Parameters

<input_date>

input_date is defaulted to current timestamp if not specified. It is used for comparing if a record date is a configured number of days prior to the input date. System batch input date format is used for parsing input date if specified.

Key Tables**Table 5–77 Key Tables for Purge BDI Supp Item****Tables**

 ITEM_SUPPLIER_IN
 ITEM_SUP_CTY_DIM_IN
 ITEM_SUPP_COUNTRY_IN
 ITEM_SUP_MAN_CTY_IN
 ITEM_SUPP_UOM_IN

Restart/Recovery

This batch can be restarted/re-run from previous failures after the issues are resolved.

Purge BDI UDA

This job deletes BDI UDA staging data. The retention period is default to 6 months.

Batch Job Definition Name

BdiFndUdaGrp_PurgeJob

Batch Job Parameters

<input_date>

input_date is defaulted to current timestamp if not specified. It is used for comparing if a record date is a configured number of days prior to the input date. System batch input date format is used for parsing input date if specified.

Key Tables

Table 5–78 Key Tables for Purge BDI UDA

Tables

UDA_IN

UDA_VALUES_IN

UDA_ITEM_DATE_IN

Restart/Recovery

This batch can be restarted/re-run from previous failures after the issues are resolved.

Purge BDI Warehouse Item Avail

This job deletes BDI warehouse item available inventory staging data. The retention period is default to 6 months.

Batch Job Definition Name

BdiTxInvAvailWh_PurgeJob

Batch Job Parameters

<input_date>

input_date is defaulted to current timestamp if not specified. It is used for comparing if a record date is a configured number of days prior to the input date. System batch input date format is used for parsing input date if specified.

Key Tables

Table 5–79 Key Tables for Purge BDI Warehouse Item Avail

Tables

INV_AVAIL_WH_IN

Restart/Recovery

This batch can be restarted/re-run from previous failures after the issues are resolved.

Batch Job Administration

This provides information about the processing and operating details of batch job administration and operations, and covers the following topics:

- [Job Administration](#)
- [Job Scheduler](#)

The batch jobs are installed and configured by the EICS application installer. The batch processes are designed to process large volume of data. The batch jobs can be scheduled as per the retailer's choice to be executed on the specific intervals during the on EICS GUI.

The following diagram illustrates the high level architecture of the current batch processing implemented for the EICS Application Server.

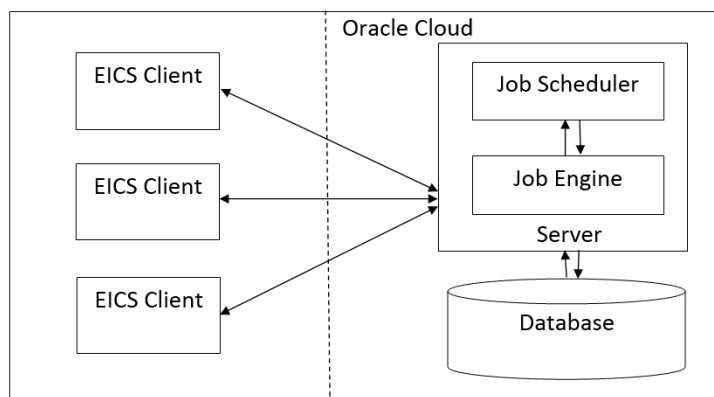
Figure 5–10 EICS Application Server Batch Processing Architecture

- **EICS Client - Server Communication**

EICS client provides an option to the retailer to run the batch jobs on demand. This call to the server is made via HTTP REST service call. The batch job selected and the parameter selected by the user are set on the request and sent to the server on this call. The server handles this request and invokes a start job on the batch engine for the respective job.

- **Job Engine**

The job engine manages the state of a running job and guarantees the execution of each step defined for the job. The call made from the client or job scheduler is passed onto the job engine to start a new instance of the batch job. Users also have an option to stop the running job or to restart any particular job which failed during the processing.

- **Job Scheduler**

This feature of EICS allows a retailer to schedule the batch jobs to run at a specific time interval. Each batch job will initially execute at a pre-configured schedule interval. Retailers will have an option to enable or disable specific batch job schedules as well. For more information please refer to Job Scheduler Section below.

Note: A few of the jobs which are system required will not be available for the retailer to change the schedule interval or disable them. These jobs will always be enabled and can be managed only by cloud admin.

Job Administration

EICS Job Admin is a web application that provides the runtime and GUI for managing batch jobs.

EICS provides an independent user interface for executing and scheduling of the batch jobs. These user interface screen will facilitate users to perform following operations:

- Execute Ad hoc Jobs
- Manual Data Seeding Importer Jobs
- View the Job Execution Log

- View the list of Jobs executed
- Schedule Jobs for execution on specific intervals

The following diagrams show the Batch Admin and relevant GUI components:

Figure 5–11 Batch Admin and GUI Components

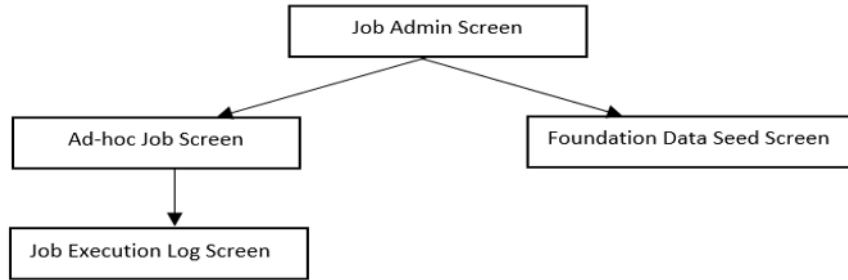

Job Admin Screen

This screen view the list of the job that have been instantiated on the server. User can filter the list of the job loaded on screen on Job Status, Reviewed and Search Limit. The default filter will load the list of the failed job when the screen is initially loaded.

User requires appropriate permission to access this screen on EICS. Navigation path for the Job Admin screen is:

Admin/Technical Maintenance/Job Admin

Figure 5–12 Job Admin Screen

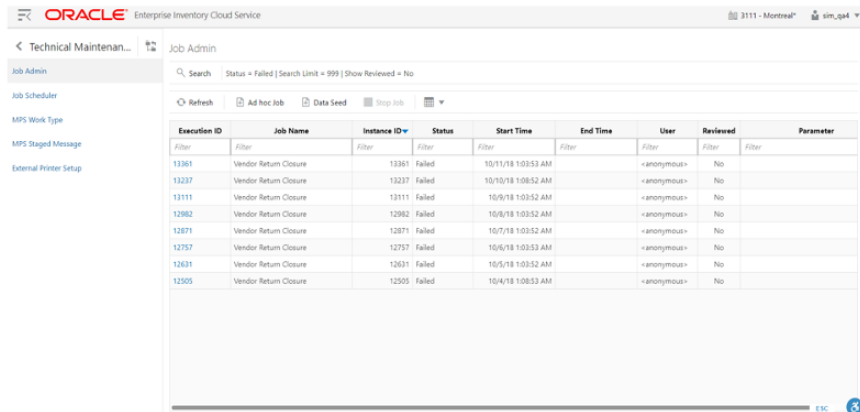

Screen Options

- **Search**
Allows user to filter the list of the batch jobs instantiated by user and the scheduler.
- **Refresh**
This option refreshes the list loaded on the screen, calls is made to server to load the list of batch jobs with current state.
- **Ad hoc Job**

This option refreshes the list loaded on the screen, calls is made to server to load the list of batch jobs with current state.

- **Data Seed**

This option navigates user to Data Seed Job Launcher screen. User can start a new data seed job from this screen by setting the required parameters and data seeding options on the job. User will require appropriate access permission to view this option on the screen.

- **Stop Job**

This option allows user to stop a running job. This option is available only when selected job is in running state that is, STARTED and STARTING.

Table Information

- **Execution ID**

This column displays the job execution identifier generated by the job engine.

- **Job Name**

This column displays the name of the batch job.

- **Instance ID**

This column displays the job instance identifier generated by the job engine.

- **Status**

This column displays the current status of the batch job.

- **Start Time**

This column displays the time when job was started.

- **End Time**

This column display the time when job was completed. If the job is currently in running state the end time will not be available.

- **User**

This column displays the user name of the user who started the job. The job started by the scheduler will have server user name in this column.

- **Reviewed**

This column denote if user has review this job.

- **Parameter**

This column displays the parameter if entered while starting the batch job.

Job Execution Log Screen

This screen display the execution details for the batch job. Users can navigate to this screen by clicking **Job Execution ID** on the Job Admin screen. This screen is designed to view the error logs for the batch jobs and to mark the job as reviewed.

Review flag denotes the selected job has been reviewed by the user. By this user can keep a track which of the failed job are already been review and take necessary actions as required.

The execution detail table load the entries of the execution record if exist for the select batch job.

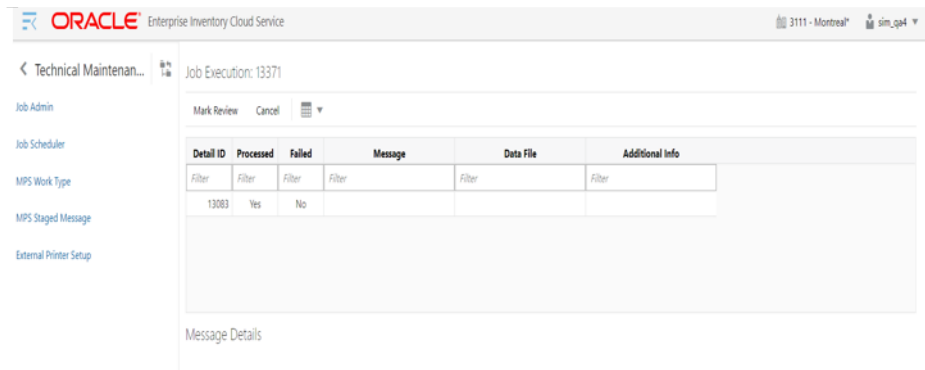
Figure 5–13 Job Execution Screen**Screen Options**

- **Mark Review**

This option allows user to mark the batch job as review. Once the job is marked as review user is navigated back to the Job Admin screen.

- **Cancel**

This option allows user to navigate back to the Job Admin screen.

Table Information

- **Detail ID**

This column displays the execution identifier generated by the job engine.

- **Processed**

This column denotes if the execution record for the job was successfully processed.

- **Failed**

This column denotes if the execution records was failed during the processing.

- **Message**

This columns displays the message from the server to viewing the further details on the job status. This column will be empty for the execution records which are been successfully processed.

- **Data File**

This column displays the file name for which the execution record was created. This column holds data only if the job details with file import processing for example, Retail Sales Audit Import Job.

- **Additional Info**

This column hold the addition info if any for the execution record.

Message Details

This section in non-editable and displays the detailed explanation for the job failure. This section will display respective data on selection job execution record. The log traces of the exact point of failure shall be printed on this section of the screen.

Job Launch Screen

This screen allow user to start a new instance for a job. Select the batch job and enter the parameter, if required, to start job.

The job launcher screen has the following categories:

- [Ad hoc Job](#)
- [Data Seed Importer Job](#)
- [Start an Ad hoc Job](#)
- [View Details for Job](#)
- [Start a Data Seed Job](#)
- [Stop a Running Job](#)

Ad hoc Job This screen allows user to run an ad hoc job. All the job which are either operational or purge job can be started from this screen. All the batch job will not support the execution date and store identifier parameters. The job for which store level processing can be performed will consider these parameter. User will not receive an error or confirmation if the parameters are not valid for the selected job.

User will required appropriate data permissions to select and run a particular job. Navigation to this screen is as follows:

Admin/Technical Maintenance/Job Admin /Ad hoc Job

Figure 5–14 Ad hoc Job Screen

Screen Options

- **Start Job**

This option allows user to start a new instance of the selected job. When the user select this option a call is made to server to start a selected batch job. Server internally makes a call to Batch Operator specifying the Job Name and the parameter if any.
- **Cancel**

This option navigates user back to Job Admin Screen.

Menu Options

- **Job Name**

Allows user to select the job to be started. This is a required field on this screen. The user will be able to view only those jobs in the drop down list which are permitted to the user via data permissions.
- **Store ID**

Allow user to enter the store identifier if the job is expected to be executed for specific store. Not all job accepts store identifier as parameter. For the jobs which doesn't take store identifier as parameter for execution shall ignore this parameter.

- **Execution Date**

Allows user to enter the execution date for the job, if not entered the job will consider the current date for the execution. Not all job accepts execution date as parameter. For the jobs which doesn't take execution date as parameter for execution shall ignore this parameter.

- **Data Set Id**

The Data Set Id is optional parameter for importer job to process the specified data set from bulk data interface table.

Data Seed Importer Job This screen allows user to start data seeding importer specific jobs only. For additional details, please refer to [Data Seeding](#).

User will need appropriate access privileges to navigate to this screen.

Navigation to this screen is as follows:

Admin / Technical Maintenance / Job Admin / Data Seed

Figure 5–15 Data Seed Screen

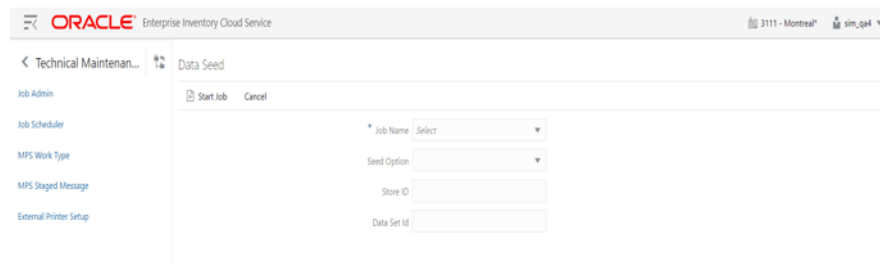

Screen Options

- **Start Job**

This option allows user to start a new instance of the selected job. When the user select this option a call is made to server to start a selected batch job. Server internally makes a call to Batch Operator specifying the Job Name and the parameter if any.

- **Cancel**

This option navigates user back to Job Admin screen.

Menu Options

- **Job Name**

Allows user to select the job to be started. This is a required field on this screen. The user will be able to view only those jobs in the drop down list which are permitted to the user via data permissions.

- **Seed Option**

User can select one of the option available as per the operation to be performed. The seed options are more over job specific and are not applicable for all job. If the

invalid seed option is selected for the job, server will ignore it and perform a normal seed operation.

The options available are:

1. Seed: Seeds the data from BDI integration tables to the application tables.
2. Delete and Seed: Deletes the data from the application tables and reseed the available data in BDI integration tables.
3. Delete Seeded: Deletes the data from the application tables.
4. Delete In: Deletes the data from BDI integration tables.
5. Disable Constraint: Disable the constraints for all the application tables.
6. Enable Constraint: Enable the constraint for the application tables.

For example, if user selects Disable Constraint Option for Store Job, this won't disable the constraint for store table. The server will simply ignore the seed option and continue this as not seed operation.

- **Store ID**

Allows user to perform store level data seeding. The store identifier is not applicable for all the job. For the job which does not support store level data processing for example, Item Header or Supplier will simply ignore the store identifier if entered.

- **Data Set Id**

The Data Set Id is optional parameter for importer job to process the specified data set from bulk data interface table.

Start an Ad hoc Job

1. Login to EICS and navigate to Job Admin screen.
2. Click on Ad hoc Job Menu to navigate to Ad hoc Job screen
3. Select the required Job from the drop down menu.
4. Set the required job parameter for the job, that is, Store ID and/or Execution Date.

Note: Job Parameter doesn't apply to all available batch jobs, for the job which do not take any parameter input will simply ignore the value in case entered.

Some of batch jobs belongs BDI TX (Transaction) category, see [Appendix B, BDI Transaction \(TX\) Importer Jobs](#) section for details.

5. Click on Start Job to start the new instance of job.
6. The new execution record will be populated on the Job Admin Screen List.

View Details for Job

1. Login to EICS and navigate to Job Admin screen.
2. Click the Job Execution Id to navigate to details.
3. To navigate back to Job Admin screen, click Cancel.
4. To mark job execution reviewed, click Mark Reviewed.

Start a Data Seed Job

1. Login to EICS and navigate to Job Admin screen.
2. Click on Data Seed Menu to navigate to Data Seed Screen.
3. Select the required job populated in the drop down menu.
4. Select required Seed Option from drop down.
5. Enter Store ID if required.

Note: Store ID is not supported by all job, will be applicable only for jobs which processed store level data

Stop a Running Job

1. Login to EICS and navigate to Job Admin screen.
2. Select the job which is currently in running state that is, STARTED or STARTING.
3. Click on Stop Job to stop the execution of the running job.
4. Prompted to confirm if the job needs to be stopped. Click Yes to continue.
5. Request is sent to job engine to stop the instance of the job. In case the job is already completed or stopped appropriate message shall be displayed to user.
6. Refresh the list on the screen to view the changes.

Job Scheduler

EICS Job Scheduler allows user to schedule the job available to run under Ad hoc Job screen.

The key features of Job Scheduler are as follows:

- **Interval Based Schedule**

User can schedule the job to run on interval basis. User will be provided below specified interval to be set for each job for execution.

Table 5–80 Interval Based Schedule

Interval	Detail	Execution Hour
30th Minute	Job execution will be every 30th minute of the hour starting from 01:00.	01:00, 01:30, 02:00, 02:30, 03:00, 03:00 ... 23:00, 23:30, 00:00, 00:30.
1 Hour	Job execution will be every 1 hour starting from 01:00.	01:00, 02:00, 03:00, 04:00, 05:00 ... 22:00, 23:00, 00:00.
2 Hours	Job execution will be every 2nd hour of the day starting from 01:00.	01:00, 03:00, 05:00, 07:00, 09:00 ... 21:00, 23:00.
3 Hours	Job execution will be every 3rd hour of the day starting from 01:00.	01:00, 04:00, 07:00, 10:00, 13:00, 16:00, 19:00, 22:00.
4 Hours	Job execution will be every 4th hour of the day starting from 01:00.	01:00, 05:00, 09:00, 13:00, 17:00, 21:00.

Table 5–80 (Cont.) Interval Based Schedule

Interval	Detail	Execution Hour
6 Hours	Job execution will be every 6th hour of the day starting from 01:00.	01:00, 07:00, 13:00, 19:00.
8 Hours	Job execution will be every 8th hour of the day starting from 01:00.	01:00, 09:00, 17:00.
12 Hours	Job execution will be every 12th hour of the day starting from 01:00.	01:00, 13:00.
24 Hours	Job execution will be every 24th hour of the day starting from 01:00.	01:00.

- **Schedule Management**

User will have an option enabling or disabling the scheduler feature for a job at any given point of time. Once disabled the auto execution on the future scheduled interval will be stopped.

- **Scheduler Configuration**

User will have option of configuring the scheduler related configuration.

Table 5–81 Batch Job Schedules

Batch Job	Interval	Restricted
AdhocStockCount_PurgeJob	24 hours	No
ArchiveDump_OpsJob	24 hours	Yes
Audits_ArchiveJob	24 hours	No
AutoReplenishCapacity_OpsJob	24 hours	No
BatchLog_PurgeJob	24 hours	No
BdiFndItemLocGrp_PurgeJob	24 hours	No
BdiFndLocationGrp_PurgeJob	24 hours	No
BdiFndMerchItemGrp_PurgeJob	24 hours	No
BdiFndMiscGrp_PurgeJob	24 hours	No
BdiFndPriceHist_PurgeJob	24 hours	No
BdiFndSupItemGrp_PurgeJob	24 hours	No
BdiFndUdaGrp_PurgeJob	24 hours	No
BdiTxInvAvailStore_PurgeJob	24 hours	No
BdiTxInvAvailStore_PurgeJob	24 hours	No
BdiTxPriceGrp_PurgeJob	24 hours	No
BdiTxRfid_PurgeJob	24 hours	No
CleanupBatchDirectories_OpsJob	24 hours	Yes
CleanupShelfReplenishment_OpsJob	24 hours	Yes
ClearancePriceChange_OpsJob	24 hours	No
Clearance_Tx_ImporterJob	24 hours	Yes

Table 5–81 (Cont.) Batch Job Schedules

Batch Job	Interval	Restricted
ClosedTransfers_PurgeJob	24 hours	No
CompletedUin_PurgeJob	24 hours	No
DSDReceivingClosure_OpsJob	24 hours	Yes
DsdAndPurchaseOrders_PurgeJob	24 hours	No
ExtPrice_Tx_ImporterJob	30 minutes	No
ExtPrice_Tx_ImporterJob	30 minutes	No
FulfillmentOrderPickReminders_OpsJob	24 hours	Yes
FulfillmentOrderPickReminders_OpsJob	24 hours	Yes
FulfillmentOrders_PurgeJob	24 hours	No
GenerateProblemLineStockCount_OpsJob	24 hours	No
GenerateUnitAmountStockCount_OpsJob	24 hours	No
GenerateUnitStockCount_OpsJob	24 hours	No
InvAvailWh_Tx_ImporterJob	30 minutes	No
InvalidUserRole_PurgeJob	24 hours	Yes
InvalidUser_PurgeJob	12 hours	Yes
InventoryAdjustment_PurgeJob	24 hours	No
InventoryExtractSftpPush_OpsJob	24 hours	No
InventoryExtract_OpsJob	24 hours	No
ItemBasketMaintenance_OpsJob	24 hours	No
ItemBasket_PurgeJob	24 hours	No
ItemBasket_PurgeJob	24 hours	No
ItemPriceToHistory_OpsJob	24 hours	Yes
ItemPriceToHistory_OpsJob	24 hours	No
ItemUinHistory_ArchiveJob	24 hours	No
Item_PurgeJob	24 hours	No
Lockings_PurgeJob	24 hours	No
Notifications_PurgeJob	24 hours	No
PosTransactionImport_OpsJob	24 hours	No
PriceChangeWorksheet_PurgeJob	24 hours	No
PriceChange_Tx_ImporterJob	24 hours	Yes
PriceHistories_PurgeJob	24 hours	No
ProductBasket_PurgeJob	24 hours	No
ProductGroupScheduleCleanup_OpsJob	24 hours	Yes
PromotionPriceChange_OpsJob	24 hours	No
RegularPriceChange_OpsJob	24 hours	No
RelatedItems_PurgeJob	24 hours	No
ResolvedUinProblem_PurgeJob	24 hours	No

Table 5–81 (Cont.) Batch Job Schedules

Batch Job	Interval	Restricted
RetailSalesAuditImport_OpsJob	24 hours	No
ReturnNotAfterDateAlert_OpsJob	24 hours	Yes
RfidHistory_ArchiveJob	24 hours	No
Rfid_PurgeJob	24 hours	No
SalesPosting_PurgeJob	24 hours	No
SftpLogFile_PurgeJob	24 hours	No
ShelfAdjustments_PurgeJob	24 hours	No
ShelfReplenishments_PurgeJob	24 hours	No
StagedMessage_PurgeJob	24 hours	No
StockCountAuthorizeRecovery_OpsJob	24 hours	No
StockCountExportSftpPush_OpsJob	24 hours	No
StockCountUnitAndAmountSnapshot_OpsJob	24 hours	No
StockCounts_PurgeJob	24 hours	No
StoreItemStockHistory_ArchiveJob	24 hours	No
StoreSequenceImport_OpsJob	24 hours	No
TemporaryUin_PurgeJob	24 hours	No
ThirdPartyStockCountImport_OpsJob	24 hours	No
TicketHistory_PurgeJob	24 hours	No
TransferClose_OpsJob	24 hours	Yes
TransferDeliveryAutoReceive_OpsJob	24 hours	Yes
TransferDeliveryClose_OpsJob	24 hours	Yes
TransferNotAfterDateAlert_OpsJob	24 hours	Yes
TransfersOverdueBatch_OpsJob	24 hours	Yes
VendorReturnClosure_OpsJob	24 hours	Yes
VendorReturn_PurgeJob	24 hours	No
WarehouseItemStockImport_OpsJob	24 hours	No

Note: Job schedule which are marked as restricted can only be managed by sys op admin user.

Job Scheduler Screen

This screen allows user to manage the schedules for the batch jobs. The list of job available to be scheduled will be sort by the enabled flag followed by Job Name alphabetically that is, the jobs for which the scheduling is enable will be on the top of the list sorted by the Job Names in alphabetical order.

User can edit the batch job and perform following operations:

1. Enable / Disable a schedule.
2. Setting the execution interval for a batch job.

User will require appropriate authorization to access this screen. Retailer will not be able to view or disable the batch jobs which are system required. This batch jobs will be accessible to Cloud Admin user will have a predefined schedule. Navigation to this screen is as follows: Admin/Technical Maintenance/Job Scheduler

Figure 5–16 Job Scheduler Screen

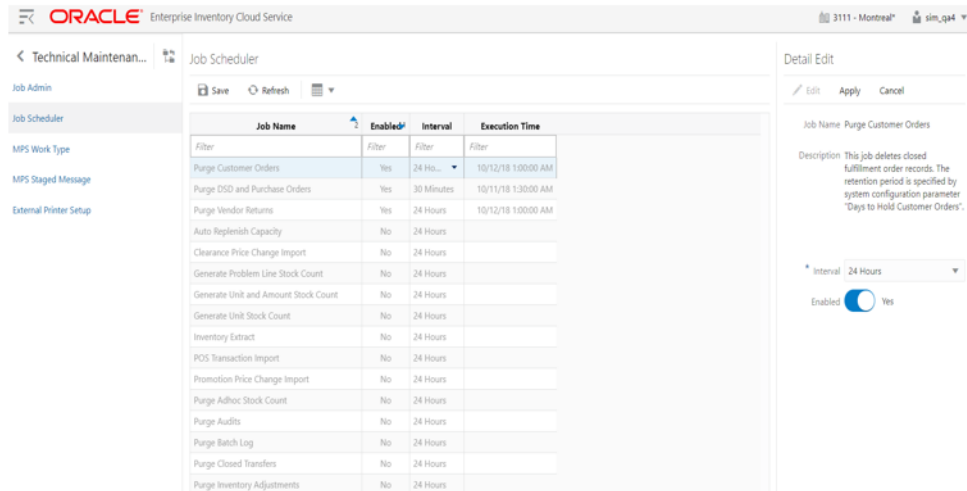

Screen Options

- **Save**

This option allows user to save the changes made to the job schedules. User can make changes to multiple schedule in edit mode and apply the changes, however the changes will take affect only when the save operation is performed.

- **Refresh**

This option refreshes the list of values on the screen.

- **Edit**

This option will be enable only when a schedule is selected to be edited and user have privileges to edit the job schedule. This option takes user to the edit mode in which user can change the execution interval for the job and enable or disable the schedule.

- **Apply**

This option will only apply the changes which are been made during edit mode. This option does not save the changes, it only apply the changes for the job and exit the edit mode. Click the Save option to save the changes.

- **Cancel**

This option is enabled only when user is in edit mode. This option allows user to discard any changes made to the schedule on edit mode or to exit the edit mode.

Menu Options

- **Interval**

User have option to select the appropriate interval for the batch job execution. Depending on the selected interval, server calculates the execution time for the batch job and runs it according. The base time for calculating the execution time on

basis of the interval is 01:00 AM. For the store based job this is as per the store time zone and for system jobs this is as per the server time zone.

Option for selecting the execution interval are as follows:

1. 30 Minutes - Runs every 30 minutes.
 2. 1 Hour - Runs every hour.
 3. 2 Hours - Runs every second hour of the day.
 4. 3 Hours - Runs every third hour of the day.
 5. 4 Hours - Runs every fourth hour of the day.
 6. 6 Hours - Runs every sixth hour of the day.
 7. 8 Hours - Runs every eight hour of the day.
 8. 12 Hours - Expected to be executed twice a day.
 9. 24 Hours - Expected to be executed only once a day.
- **Enabled**

Table Information

- **Job Name**

This column displays the name of the job.

- **Enabled**

This column denotes whether a job is current scheduled.

- **Interval**

This column denotes the interval of the job execution.

- **Execution Time**

This column denote the next execution time for the batch job. This column will not contain data for the jobs which are been disabled.

Configuring a Job Schedule

1. Login in EICS and navigate to the Job Scheduler screen.
2. Select the desired job from the list.

Note: If the Edit option is not available in the menu section, the user is not authorized to edit the batch job. Kindly assign appropriate user group or contact system admin for desired changes.

Some of batch jobs belongs BDI TX (Transaction) category, see [Appendix B, BDI Transaction \(TX\) Importer Jobs](#) section for details.

3. Edit the Job details on right panel.
4. Set required interval for execution and **Enabled** to Yes.
5. Click **Apply** to exit the edit mode.
6. For configuring multiple jobs on a go, repeat Step 2 for each job.
7. Click **Save** to save the current changes made on the screen.

Disabling a Job Schedule

1. Login in EICS and navigate to Job Scheduler screen.
2. Select the job from the list which needs to be disabled.
3. Edit the Job details on right panel.
4. Set **Enabled** as No.
5. Click **Apply** to exit the edit mode.
6. For disabling multiple jobs on a go, repeat Step 2 for each job.
7. Click **Save** to save the current changes made on the screen.

Batch - Data Archive

SIOCS is an inventory transaction system and not a data warehouse.

Large volume of data can cause performance issues for transnational products. It could also cause other operational challenges such as backups could take longer time and storage could go up.

To reduce overall size of the operational tables and improve performance, for selected history tables, SIOCS archives data into archive tables. These archive tables can be purged at later point.

Archive Data Batches

Figure 6–1 Archive Data Batches

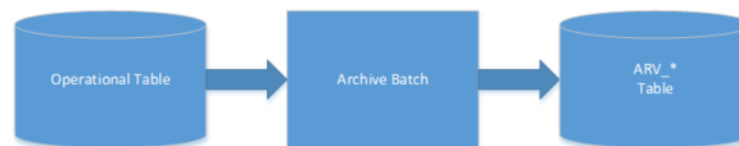

Table 6–1 Archive Data Batch List

Batch Job	Description
Archive RFID History	Archive RFID history records into archive table. See batch chapter Archive RFID History for batch details.
Archive Activity	Archive activity data into activity archive tables. See batch chapter Archive Activity for batch details.
Archive Item UIN History	Archive item UIN data into item UIN archive tables. See batch chapter Archive Item UIN History for batch details.
Archive Store Item Stock History	Archive store item stock history data into store item stock history archive tables. See batch chapter Archive Store Item Stock History for batch details.

Archive Dump Batches

The archive dump process creates the data dump files and truncates the archive tables.

The dump files are created using oracle Data Pump API, these files are written in a proprietary, binary format which are made up of one or more disk files that contain table data.

Figure 6–2 Archive Dump Batches

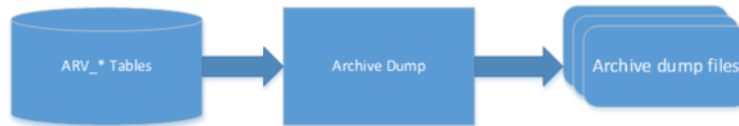

Table 6–2 Archive Dump Batch List

Batch Job	Description
Archive Dump	Export archive history data into Dump files and truncate archive history tables. See Batches chapter: Archive Dump for batch details.

Archive Batch Scheduling Consideration

Archive Data Batches need to be run prior to Archive Dump Batches.

The Archive Dump Batch Job need to be run after Archive Data batches.

Archive Data Dump Files Export

The archived history data dump files can be collected from database directory and exported to retailer per customer's request, Oracle AMS team will need to raise ticket to cloud DBA team to collect the data dump files. Once the data dump files are exported, it is up to retailer to take the files. EICS will no longer keep the data dump files after files are exported to customer.

If customer does not request to be exported to customers, these data dump files will be kept in database archive locations up to time determined by Oracle cloud service agreement.

Note: The data dump file location in database server can be queried using following:

```

Login to SIOCS PDB: SELECT DIRECTORY_PATH FROM DBA_
DIRECTORIES WHERE DIRECTORY_NAME = 'SIOCS_DATA_
PUMP_DIR';
  
```

Technical Maintenance Screens

This section covers the following topics:

- [Barcode Processor](#)
- [External Printer Setup](#)
- [MPS Staged Message](#)
- [MPS Work Type](#)

Barcode Processor

Barcode Processors are used within EICS to scan items. When the application takes a barcode (or manual entry of one), it passes it along to the barcode processors to extra the correct sku number from the barcode in order to retrieve the item. This form allows the control of which barcode processors the application uses and what order they are used in. The barcode processor form is located under Configuration Barcode Processor.

Figure 7–1 Barcode Processor

Processor Name	Sequence	Active
GS1	10	Yes
SKU	20	Yes
Type 2 A	30	Yes
Type 2 B	40	Yes
Type 2 C	50	Yes
Type 2 D	60	Yes
Type 2 E	70	Yes
Type 2 F	80	Yes
Type 2 G	90	Yes
Type 2 H	100	Yes
Type 2 I	110	Yes
Type 2 J	120	Yes
Type 2 K	130	Yes
Type 2 L	140	Yes

The above screen picture shows the list and detail panel in display mode.

List Buttons

- **Save:** Persists currently altered information.
- **Refresh:** Refreshes the screen with currently persisted information.
- **Filter:** Enable or disable the filtering row in the table.

Barcode Processor Attributes

- **Processor Name:** The name of the processor. This does not alter how the processor works. For example, Type 2 E will continue to parse Type 2 E, even if it is renamed to Type 2 K.
- **Sequence:** Sequence indicators the order the barcode processors will attempt to analyze the item scanned. It starts with the lowest sequence number and proceeds upward. Items will be returned by the first barcode processor that finds a valid item within the barcode.
- **Active:** Yes indicates that the barcode processor is active and will be used when scanning items.

Detail Panel

Figure 7–2 *Detail Panel in Edit Mode*

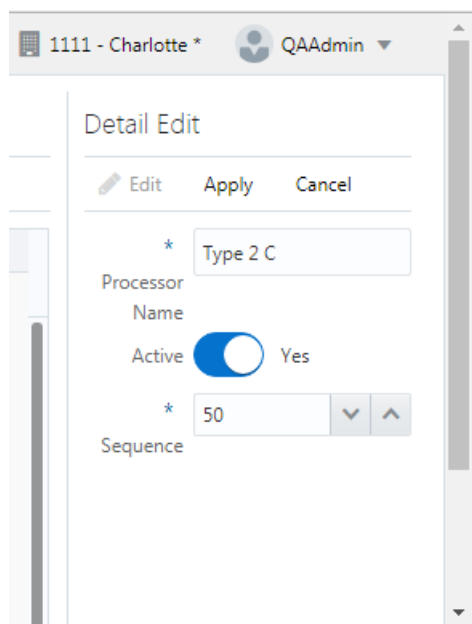

Detail Buttons

- **Edit:** Places the detail information displayed into edit mode.
- **Apply:** Applies the current data to the barcode processor and updates the list information.
- **Cancel:** Places the panel back into display mode without applying the information.

Barcode Processors

Table 7–1 *Barcode Processors*

Barcode Processor	Description
SKU	Parses the data scanned as a direct sku number or Universal Identification Number.
GS1	Parses the data scanned as a GS1 (Global Standards One) seeking out item number within.

Table 7-1 (Cont.) Barcode Processors

Barcode Processor	Description
Type 2 A-L	Barcode processor parses the data as a Universal Product Code (Type 2), otherwise known as random weight barcodes. There is a whole series of available code patterns from sub-type A to sub-type L.
UPC E	Parses the data scanned as a Universal Product Code (Type E), a six digit barcode.
VPN	Parses the data scanned is a Vendor Product Number.
RFID	Parses the data as Radio Frequency Identification (RFID) tag.
RFID GTIN-12	Parses the data as Radio Frequency Identification (RFID) GTIN-12 tag.
RFID GTIN-13	Parses the data as Radio Frequency Identification (RFID) GTIN-13 tag.
ISN	Parses the data as Item Scan Number (ISN) seeking out the IMEI number.

External Printer Setup

The Printers screen is used to configure printers. The user can add, view, edit, and delete a printer as well as assign a network address for each printer. They can also indicate whether or not the printer is the default printer for manifest printing or pre-shipment printing.

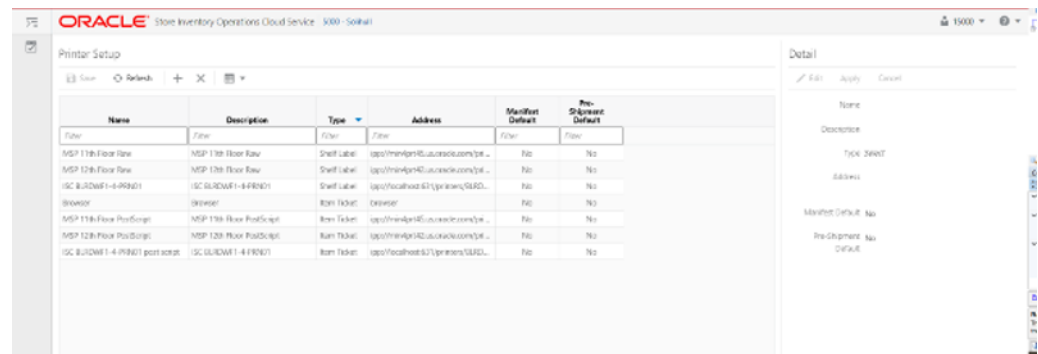
Figure 7-3 Print Setup Navigation And List Screen

List Buttons

- **Save:** Persists currently altered information.
- **Refresh:** Refreshes the screen with currently persisted information.
- **+**: Add a new printer to configuration. It clears out the detail panel so the user can enter new printer information.
- **x:** Remove a printer from configuration. A dialog confirmation warning will occur prior to deletion of the record.
- **Filter:** Enabled are disabled the filtering row in the table.

Printer Attributes

- **Name:** The name of the printer.

- **Description:** Longer name for the printer.
- **Type:** The type of the printer. Valid values are: Item Ticket, Shelf Label and Postscript.
- **Address:** The address of the printer.
- **Manifest Default:** Yes if this is the default printer for manifest printing, otherwise No.
- **Pre-Shipment Default:** Yes if this is the default printer for pre-shipment printing, otherwise No.

Detail Panel

Figure 7-4 Detail Panel In Edit Mode

The screenshot shows a user interface for editing printer details. At the top right, there are two dropdown menus: one showing '15000' and another with a question mark. Below this is a 'Detail Edit' section with three buttons: 'Edit' (with a pencil icon), 'Apply', and 'Cancel'. The form contains the following fields:

- Name:** * Name (required), value: MSP 11th Floor Raw
- Description:** Description, value: MSP 11th Floor Raw
- Type:** * Type (required), value: Shelf Label (dropdown menu)
- Address:** * Address (required), value: ipp://min4prt45.us.oracle.com/printer
- Manifest Default:** A toggle switch is turned on, with the text 'Manifest Default' and 'Yes' next to it.
- Pre-Shipment Default:** A toggle switch is turned on, with the text 'Pre-Shipment Default' and 'Yes' next to it.

On the left side of the panel, there is a table with a 'Manifest Default' column and a 'Filter' row. The table contains several rows with 'No' in the 'Manifest Default' column.

Detail Buttons

- **Edit:** Places the detail information displayed into edit mode.
- **Apply:** Applies the current data to the printer and updates the list information.
- **Cancel:** Places the panel back into display mode without applying the information.

MPS Staged Message

The MPS Staged Message administration form is used to monitor the messages in the Message Processing System queue. Each message contains the detailed information being transmitted between EICS and an external system.

Figure 7-5 MPS Staged Message

Record ID	In/Out	Type	Family	Create Time	Update Time	Expiration Count	Business ID	Store ID	Job ID	Description	
3725	Inbound	SOClw	StockOrder	9/18/18 9:52:15 AM	10/18/18 5:38:10 AM	31	1		1101	3725	SOClw test
3728	Inbound	SOClw	StockOrder	9/18/18 9:57:40 AM	10/18/18 5:39:15 AM	31	10		1111	3728	SOClw test

Filter Bar

- **Search:** This is a button that displays a filtering dialog.
- **Description:** A non-labeled text field follows the Filter button that displays what criteria are currently selected to filter the staged message table.

Filter Dialog Attributes

- **Family:** Limits the search results to only those messages in the specified family.
- **In/Out:** Indicates if the message is inbound to EICS or outbound to an external system.
- **Search Limit:** Limits the number of messages found to the specified limit or less.
- **Show Pending:** If true, only messages that are pending will be displayed.
- **Show Retry:** If true, only messages that are in retry will be displayed.

Figure 7-6 MPS Staged Message Filter

Filter Dialog Buttons

- **Search:** Executes a search for staged messages based on the selected criteria and refreshes the list table with that information.
- **Reset:** Results the filter dialog back to its default settings.
- **Cancel:** Closes the dialog without taking any action.

List Buttons

- **Refresh:** Refreshes the staged message list with current information.
- **Retry:** If a staged message is selected, selecting this button will retry the processing of the staged message.
- **Delete Selected:** If a stage message is selected, selecting this button will attempt to delete the message.
- **Filter:** Activates the filter dialog allowing the user to filter information.

List Attributes

- **Record Id:** A unique identifier assigned to the stage message.
- **In/Out:** Indicates if the message is inbound to EICS or outbound to an external system.
- **Type:** Type of message within a family. For example, most families of messages have a create, modify, and delete type of message.
- **Family:** Describes the family that the message belongs to. This will align with a MPS Work Type scheduled to process this family of messages.
- **Create Time:** The timestamp of the first time the message was created.
- **Update Time:** The timestamp of the last time the message was updated.
- **Execution Count:** The number of times the system has attempted to process the message.
- **Business ID:** A business identifier associated to the message. More than one message may carry a business identifier, and so this can be used to associate messages that may be related to the same activity.
- **Store ID:** The identifier of the store associated to the message.
- **Job ID:** The job identifier is a server-generated sequence number used for grouping related messages. If a message is singular with no other related messages, then its record identifier and job identifier will be identical. For messages, that must be executed sequentially together as a group, they will be assigned the same job identifier but different record identifiers.
- **Description:** A brief formatted description of the staged message that gives some indication of the contents within.

MPS Work Type

The MPS Work Type administration form is used to configure the MPS work types. MPS stands for Message Processing System and each work type represents an external inbound or outbound message family or grouping to be delivered to another system. These work types do not represent the messages themselves (see MPS Staged Message) but the working queue that handles the processing of these external messages.

Figure 7-7 MPS Work Type List

Work Type	Direction	Active	Retry Limit	Pending Count	Retry Count	Fail Count	Last Update	Last New	Retry Delay Secs	Retry Delay Max. Secs	Retry Delay Factor	Retry Delay Random	Purge Processed
ASIn	Inbound	Yes	1	0	0	0	9/27/18 12:45...	9/27/18 12:45...	1	1	1	1	No
ASOut	Outbound	No	-1	2	0	0	10/1/18 9:103...		-1	-1	-1	-1	No
CrPrChg	Inbound	Yes	-1	0	0	0			-1	-1	-1	-1	No
Diffs	Inbound	Yes	-1	0	0	0			-1	-1	-1	-1	No
DaySt	Inbound	Yes	-1	0	0	0			-1	-1	-1	-1	No
DSDReceipt	Outbound	No	-1	2	0	0		10/10/18 11:5...	-1	-1	-1	-1	No
FuRtOrd	Inbound	Yes	-1	0	0	0	9/18/18 3:533...	9/18/18 9:195...	-1	-1	-1	-1	No
FuRtOrdCh	Outbound	No	-1	0	0	0			-1	-1	-1	-1	No
FuRtOrdChCnc	Outbound	No	-1	0	0	0			-1	-1	-1	-1	No
ASOut	Outbound	Yes	1	0	0	0			1	1	1	1	No

Detail

Retry Limit: [Field] Retry Delay Random: [Field]

Retry Delay Secs: [Field] Purge Processed: [Field]

Retry Delay Max. Secs: [Field] Active: [Field]

Retry Delay Factor: [Field]

List Buttons

- **Save:** Persists currently altered information.
- **Refresh:** Refreshes the screen with currently persisted information.
- **Filter:** Enabled are disabled the filtering row in the table.

List Attributes

- **Work Type:** The work type is the name of the message queue being worked on.
- **Direction:** Indicates if the message queues is inbound to EICS or outbound to an external system.
- **Active:** Yes indicates the work type is currently active and attempting to process messages. No indicates it has been disabled.
- **Retry Limit:** The number of times to attempt to process a single message before marking it as failed.
- **Pending Count:** Number of message pending processing.
- **Retry Count:** Number of times the system as attempted to process the message. Zero times means processing has not been attempted yet.
- **Fail Count:** Number of messages that have failed to be processed.
- **Last Update:** The timestamp of the last time a staged message record was updated in the database for this specific work type.
- **Last New:** The timestamp of the last time a staged message record was created in the database for this specific work type.
- **Retry Delay Secs:** The delay in seconds between retries.
- **Retry Delay Max Secs:** The maximum delay in seconds between retries.
- **Retry Delay Random:** The factor used to limit the range of retry delay randomization.
- **Purge Processed:** Indicates if automatic purging of messages that are processed successfully is enabled.

Detail Panel

Figure 7–8 Detail Panel In Edit Mode

The screenshot shows a 'Detail Edit' window with a toolbar containing 'Edit', 'Apply', and 'Cancel' buttons. Below the toolbar, there are four input fields on the left, each with a dropdown arrow and an up/down arrow button:

- * Retry Limit: 2
- * Retry Delay Secs: -1
- * Retry Delay Max. Secs: -1
- Retry Delay Factor: -1

 On the right side, there are two toggle switches:

- Retry Delay Random: -1 (with a dropdown arrow)
- Purge Processed: No (toggle is off)
- Active: No (toggle is off)

Detail Buttons

- **Edit:** Places the detail information displayed into edit mode.
- **Apply:** Applies the current data to the work type and updates the list information.
- **Cancel:** Places the panel back into display mode without applying the information.

Detail Attribute

- **Retry Limit:** The number of times to attempt to process a single message before marking it as failed. Zero indicates it should only be attempted once and will not

be retried. A positive value indicates how many attempts to process the message should be made in addition to the original attempt.

- **Retry Delay Seconds:** The number of seconds between attempts to process a message. Zero indicates no delay whereas a value of 30 indicates 30 seconds between attempting to process the message. This value does not represent an absolute value as it used with other parameters below to produce a calculated message time delay.
- **Retry Delay Max Seconds:** This is the maximum number of seconds for a delay between processing messages. This caps the maximum value for the calculated delay.
- **Retry Delay Factor:** This attribute produces an increased delay between each retry of a failed message in the queue. It is a decimal value starting at 1.0 and increasing. If you enter 1.0, it means there will be no increase in the retry delay seconds during repeated attempts to process a message. A value of 1.5 indicates that the retry delay seconds will be 150% of the retry delay seconds on retry.

A linear delay of 1.0 can be used but may result in messages reaching their retry limit prior to any issues being resolved. A value of 1.5 or larger will produce an increased delay that may allow time for other dependent messages that could be holding up execution to arrive.

- **Retry Delay Random:** Defines the amount of the delay to increase or decrease by a random amount. It accepts values from 0.0 to 1.0. A value of 0.0 disables random variation of the delay. A value of 0.5 indicates the calculated delay may be randomly altered by up to 50% of its value whereas 1.0 indicates it could be randomly altered up to 100% of its value. It is recommended to use at least some small random variation to improve message throughput as this will reduce resource contention and help avoid timing issues.
- **Notes:** The parameters are applied to retries in the following manner. The retry delay seconds is first increased by the retry delay factor, then the retry delay max seconds is applied, and finally the random delay is added or subtracted to determine the final number of seconds to wait between message processing attempts.
- **Purge Processed:** Switch to enable/disable automatic purge of messages that are processed successfully.
- **Active:** Switch to enable/disable a work type.

Integration

This section describes the integration through RIB, Batches and web services.

- [Overall Integration Touchpoints](#)
- [Retail Integration Cloud Service \(RICS\) - based Integration](#)
- [Batch Integration](#)
- [Web Services](#)
- [Sales Integration](#)
- [Integration with Manifesting Systems](#)
- [Integration for Ticket Printing](#)
- [Retail Home Integration](#)

Overall Integration Touchpoints

Figure 8–1 Overall Integration Touchpoints

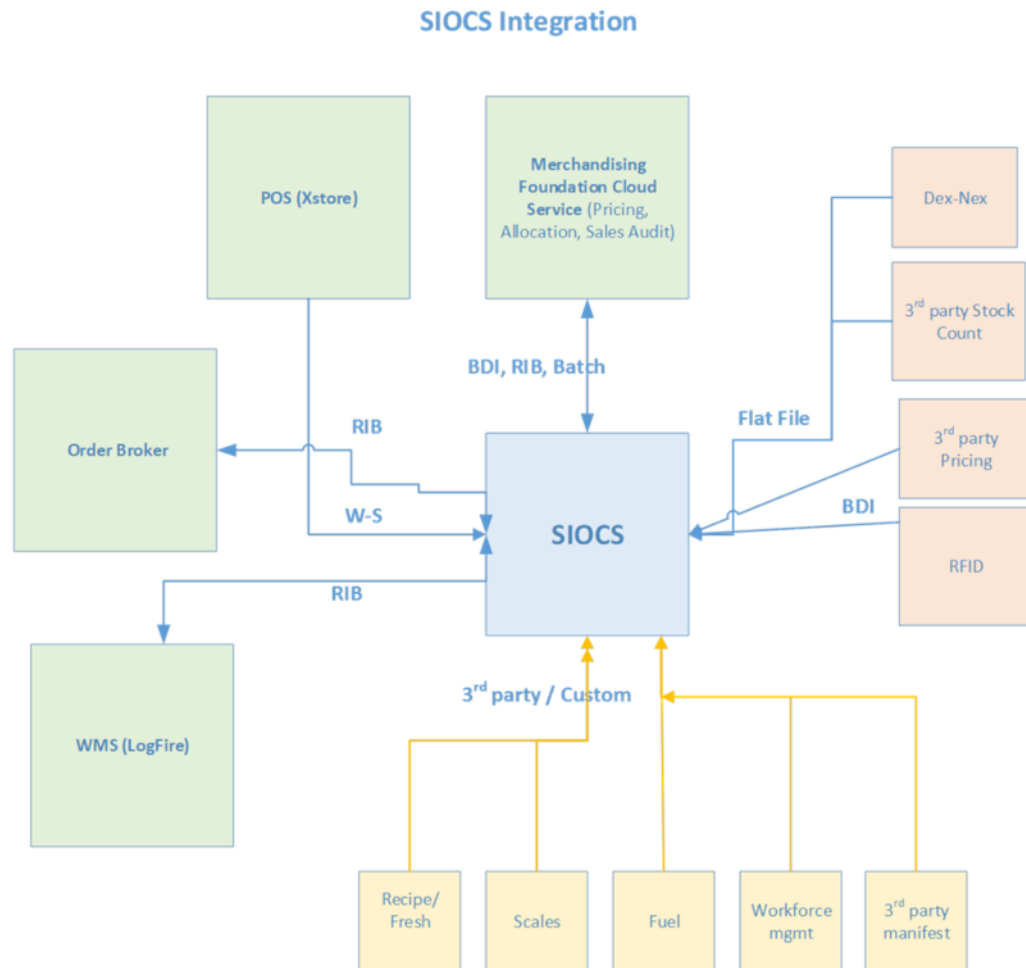

Retail Integration Cloud Service (RICS) - based Integration

RICS is a platform containing RSB, RIB and BDI.

- Customer Orders
- Picking
- Deliveries
- Reverse Picking
- Multi Leg
- RIB Payloads
- Purchase Orders and Vendor Deliveries
- Inventory Adjustments
- Items
- Stock Counts

- [Transfers](#)
- [Transfer Creation](#)
- [Transfer Messages](#)
- [Transfer Shipment Creation](#)
- [Transfer Receiving](#)
- [Transfer Doc](#)
- [Transfer Shipment](#)
- [Transfer Receiving](#)
- [Vendor Return](#)

Customer Orders

- Customer Order Create is used for Customer Orders that are a type of Web Order integrated through a message (FulfilOrdDesc). These integrations are used for the customer order from the Order Management System (OMS).
- The Customer Order Create failure message (FulfilOrdCfmDesc) is a message that will be sent out to external system when we get a Customer Order that comes into the system through the RIB and fails due to validation issues such as an invalid item. The purpose of the create failure is so other systems will know it has failed when it came in and that it is not being processed.
- The Stock Order Status message (SOStatusDesc) will be sent out with an SI upon reserving inventory for the customer order.

Picking

- A Stock Order Status message (SOStatusDesc) is sent out with a type of SI upon reserving inventory. This happens when more is picked than what was on the order due to tolerances. This could also occur when a substitute item is added during the picking process.
- The Stock Order Status message (SOStatusDesc) with a type of SD will be published to un-reserve the original items inventory when a substitute item has been added during picking.
- A Stock Order status message (SOStatusDesc) is sent out with a type of PP when picking is completed.
- Item Substitutes are sent to EICS from the merchandising system through the item message (ItemDesc).

Deliveries

- An ASN Out message (ASNOutDesc) is sent out upon dispatching of the Delivery. This will be done for pick-ups and for shipments.
- The Stock Order Status message (SOStatusDesc) with a type of PP will be published for the pick quantity in the scenario that more was delivered than what was picked.
- The Stock Order Status message (SOStatusDesc) with a type of SI will be published for the reserved quantity. This will occur when more was delivered than what was reserved. This can happen when picking was not required, the

reservation occurs upon receipt of a delivery, and the full amount had not been received, therefore not reserved.

Reverse Picking

- Customer Order Cancellations (FulfilOrdRef) will come into EICS from external system such as an OMS through the RIB. This service will perform all the validations to determine if it should create a reverse pick and whether or not that reverse pick should be auto completed.
- Customer Order Cancellation Confirmation (FulfilOrdRef) is a message to send to OMS upon completing of the system-generated reverse pick.
- Stock Order Status message (SOStatusDesc) with a type of SD will be published for the reserved quantity to un-reserve the inventory for the reverse pick for system-generated picks.
- Stock Order Status message (SOStatusDesc) with a type of PU will be published for the reverse picked quantity to un-pick the inventory for system-generated picks.

Multi Leg

The following integrations are in addition to the standard integrations that already exist such as receipt message, and so on:

- The Stock Order Status message (SOStatusDesc) with a type of SI will be published for the reserved quantity.
- The Stock Order Status message (SOStatusDesc) with type of PP will be published for the picked quantity.

RIB Payloads

RIB payloads are used to communicate information to external systems through RIB Integration.

RIB Payload	Description
FulfilOrdDesc	RIB payload that contains information about a new web order type of fulfillment order to be created in.
FulfilOrdCfmDesc	RIB payload sent from EICS that contains fulfillment order information when that order creating in EICS failed
FulfilOrdRef	RIB payload that contains information about a fulfillment order cancelation. It is sent to EICS to convey a cancelation request and sent from EICS to convey actual cancellations.
SOStatusDesc	Sent from EICS to convey changes in item status for a specific fulfillment order. Such changes of status include (un)reservation and (un)picking.
ASNOutDesc	Sent from EICS to convey a delivery for specified fulfillment order.

Purchase Orders and Vendor Deliveries

MERCHANDISING publishes the Purchase Orders created for the direct store deliveries using RIB messages. EICS subscribes to these messages and stores them in the EICS database to enable receipt against Purchase Orders.

MERCHANDISING publishes the unit cost of the item at the item/supplier/country level for EICS to use in the receiving process.

EICS publishes the receipts done against the Purchase Order to the merchandising system (Receiving message).

EICS publishes the DSD receipts created in EICS without a Purchase Order to the merchandising system (DSDReceipts and DSD Deals messages).

EICS publishes the receiver unit adjustment done for the deliveries that are already confirmed (receiving message).

EICS is also capable of subscribing to the vendor EDI ASNs through RIB using the ASN In message format.

RIB payloads are used to communicate information from EICS to external systems and from external system to EICS through RIB Integration.

RIB Payload (Subscriber)	Description
PORef	RIB payload that contains reference level information of a purchase order. This payload is used for removal of purchase orders.
PODesc	RIB payload that contains detailed information of a purchase order. This payload is used for creation and modification of purchase orders.
ASNInRef	RIB payload that contains reference level information of an ASN. This payload is used for removal of an ASN.
ASNInDesc	RIB payload that contains detailed information about the ASN. This payload is used for creation of a direct delivery (document type= 'P') or a warehouse delivery (document type= 'D'). EICS consumes this payload from warehouse when source and/or destination for ASN is a warehouse system.

RIB Payload	Description
ReceiptDesc	RIB payload that contains detailed information of the direct delivery receipt. This is published when the purchase order is not null. EICS also consumes this payload for warehouse receiving.
DSDReceiptDesc	RIB payload that contains detailed information of the direct delivery receipt. This is published when the purchase order is null.
SOStatusDesc	RIB payload sent from EICS to convey changes in item status for a specific fulfillment order. EICS also consumes this payload from warehouse for stock movements originating at the warehouse.
InvAdjustDesc	RIB payload that contains information about destination of the adjustment and an InvAdjustDtl.

Inventory Adjustments

Inventory adjustments integrate to MERCHANDISING at the item level using the RIB. EICS creates the adjustments and groups them together by a header with multiple items, but for integration purposes they are published out at an item level.

Inventory adjustments are published for all manual and external system generated adjustments where the Publish indicator for the reason code is checked. Adjustments are also published for other types of transactions in EICS where the merchandise system is expecting an adjustment for stock on hand updates, for example, receiving a DSD with damaged goods. An adjustment is created behind the scenes only for publishing purposes to notify the merchandising system to move the goods into the unavailable bucket. These system type adjustments are not considered an adjustment within EICS; however, they are published as such for integration purposes.

EICS subscribes to inventory adjustment messages from warehouse systems and updates the warehouse inventory buckets in EICS.

RIB payloads are used to communicate to external systems through RIB Integration.

The following table shows the list of RIB Payloads available for inventory adjustments.

RIB Payload	Description
InvAdjustDesc	RIB payload that contains information about destination of the adjustment and an InvAdjustDtl.
InvAdjustDtl	Contains detailed information about the item adjustment.

Items

Items come to EICS from a merchandising system through the RIB (items, item loc messages). EICS also gets information about items associated to a supplier through the RIB. Extended attributes are not received or sent on RIB payloads.

RIB Payload	Description
ItemDesc	This payload contains information about an item. It contains a wide variety of information about the item including suppliers, UPCs, ticketing information, image information, UDAs, and related items
ItemLocDesc	This payload contains information about an item at a specific location.
ItemSupDesc	This payload contains information about an item for a specific supplier.
ItemSupCtyDesc	This payload contains information about an item for a specific supplier within a specific country.

Stock Counts

Stock counts generate inventory adjustment when completed.

RIB payloads are used to communicate to external systems through RIB.

RIB Payload	Description
InvAdjustDesc	RIB payload that contains information about destination of the adjustment and an InvAdjustDtl.
InvAdjustDtl	Contains detailed information about the item adjustment.

EICS does not integrate using a web service to any other Oracle Retail products for stock counts.

Transfers

The Transfer Shipping allows for creating shipment, dispatching shipment, canceling shipment, creating container, approving container, adjusting container, and canceling the container.

The Transfer Receiving dialog allows for confirming receipt, copying misdirected container, receiving container and detailed receiving.

This section covers creating transfer documents which are then included in a transfer shipment and dispatched to another store, warehouse, or finisher.

Transfer Creation

Transfer documents can be created in the following ways:

- Requesting store can create a transfer request.
- Sending store can initiate a transfer by creating a transfer.
- Merchandising can create a transfer request.

Each transfer document will have one or more items.

Transfer Messages

EICS will publish messages to Merchandising when the following happen:

- Transfer is rejected.
- Transfer is approved.
- Transfer quantity is updated from the shipment.

Transfer Shipment Creation

Transfer Shipment describes the containers and the items for the shipment taking place. The shipment may be for one or more transfer documents as long as the transfer is going to the same destination. Dispatching a shipment will update the transfer document.

The user can create a shipment without referencing existing transfers or can create a new transfer on fly (Ad hoc transfer) based on the shipment information.

Transfer Receiving

This transaction captures a delivery that took place from a warehouse, store, or finisher to the store receiving the delivery. It describes the containers and the items of the delivery that should be received by the store. Receiving a container of the delivery will update the transfer document.

Figure 8–2 Transfer Request Flow

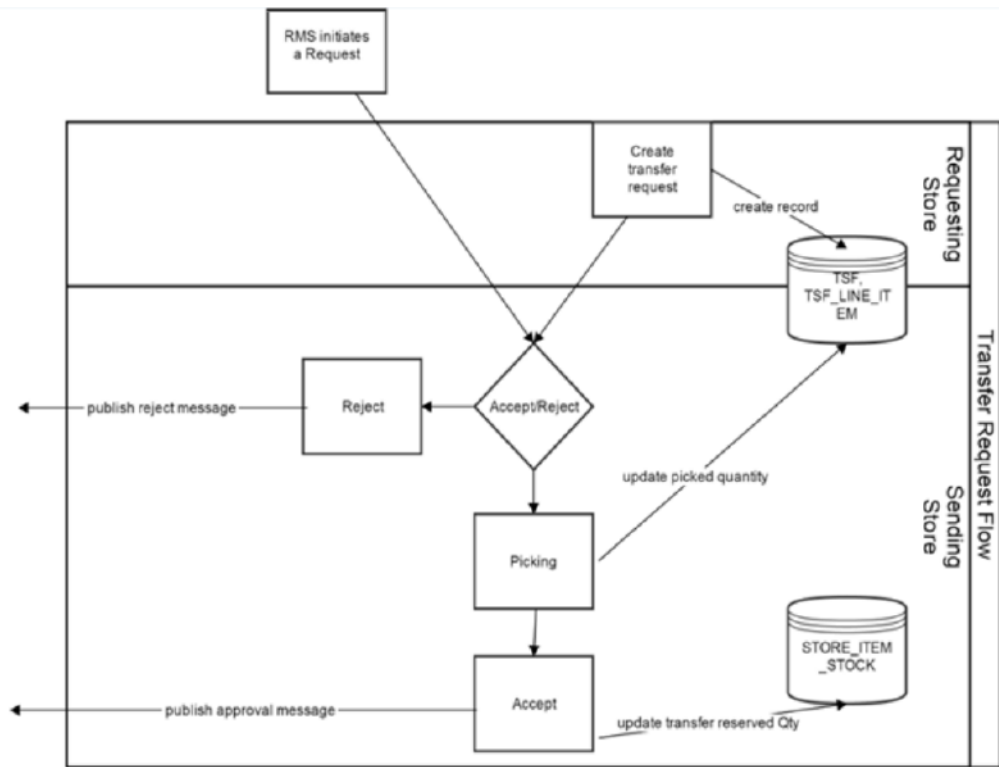

Figure 8–3 Transfer Create Flow

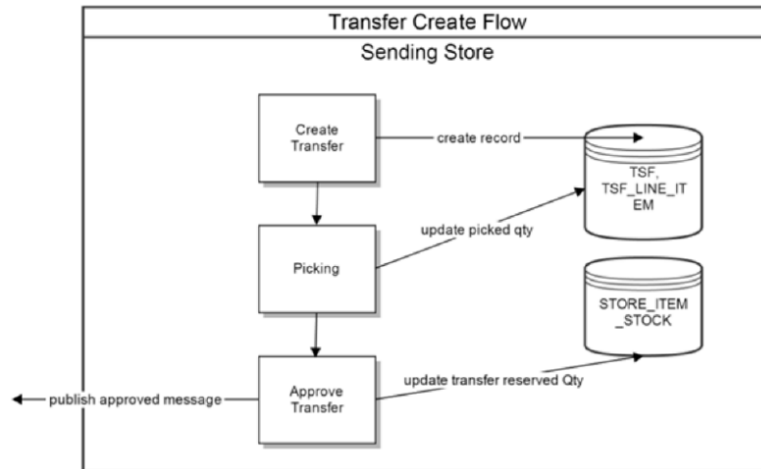

Figure 8-4 Transfer Shipment Creation Flow

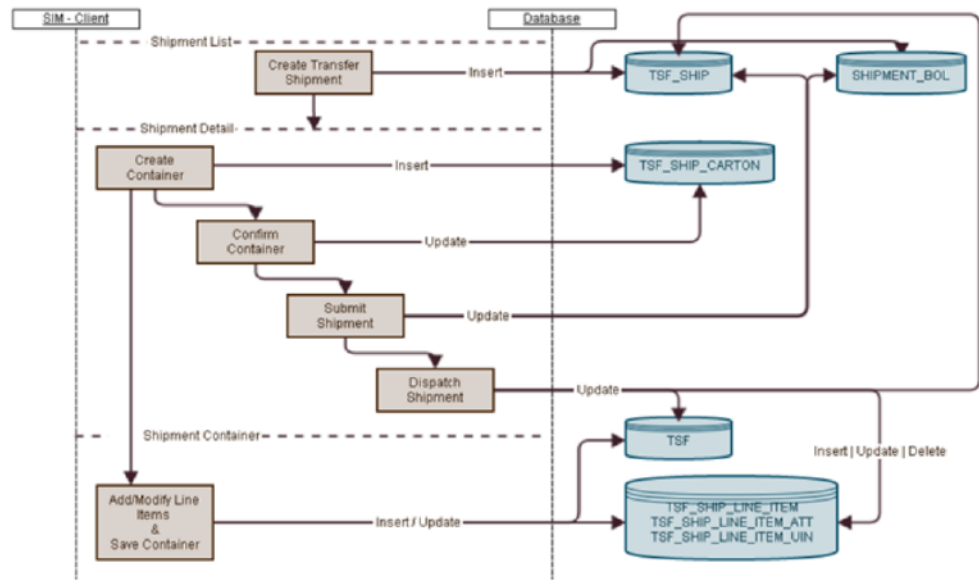
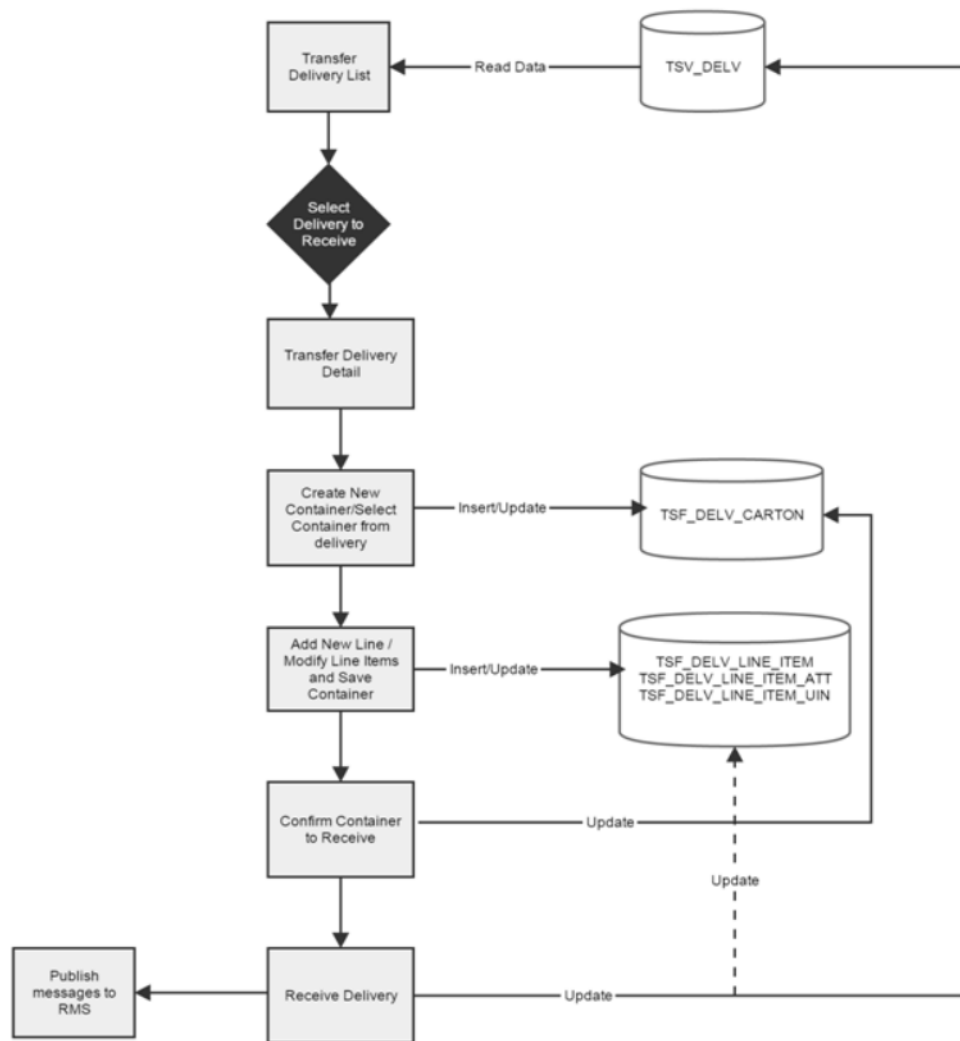

Figure 8–5 Transfer Receiving Process Flow

Transfer Doc

RIB Payload	Description
SODesc	This message is received from external systems when a stock order/transfer has been created
SOSatusDesc	This message is received from external systems when a stock order/transfer has been modified.
SORef	This message is received from external systems when a stock order/transfer has been deleted.

Transfer Shipment

RIB Payload	Description
ASNOutDesc	This message is sent to external systems when the transfer shipment is dispatched.

RIB Payload	Description
ManifestCloseVo	This message is received from an external system to indicate physical shipment has been accepted. This will attempt to auto-close the transfer shipment if all items are shipped.
ManifestDesc	This message is sent to an external system when manifesting is activated and a transfer shipping container is confirmed.
ShipInfoDesc	This message is sent to an external system when pre-shipment notifications are active and a transfer shipment is either submitted or dispatched (without previously being submitted).
SOSStatusDesc	This message is sent to an external system when a transfer shipment container is saved with shipping quantities. It is also sent when a transfer shipment container is canceled but had shipping quantities. Increase and decrease of quantities is indicated by the SI or SD codes.

Transfer Receiving

RIB Payload	Description
ASNInDesc	Sent from external system to indicate a delivery is tracking place. It creates a transfer delivery record within EICS when a store location is involved.
ReceiptDesc	Sent to external system when a transfer delivery is confirmed. Sent from external warehouse system when a transfer delivery is received at the warehouse.

Vendor Return

RTV Creation

RTVs can only be created by a request from MERCHANDISING:

Each vendor return will have one or more items.

RTV Shipment

Each RTV shipment will tie back to a single vendor return document.

RTV shipment can be created in two ways:

- From an externally initiated approved vendor return document.
- Creation of ad hoc vendor return shipment which will create an approved vendor return on the fly.

Each vendor return shipment will have one or more containers; each container in turn will have one or more items.

EICS may publish messages when the following happens:

- RTV shipment container is updated, and saved (Return To Vendor Publish)
- RTV shipment is cancelled or rejected (Return To Vendor Publish)
- RTV shipment is dispatched (Return to Vendor Publish and Ship Info Desc Publish, if dispatched without submitting)
- RTV shipment is submitted (Ship Info Desc Publish)

- RTV shipment container is confirmed (RTV manifesting, if configured)
- RTV shipment is submitted (Pre-shipment notification, if configured)

Figure 8-6 RTV Creation Flow

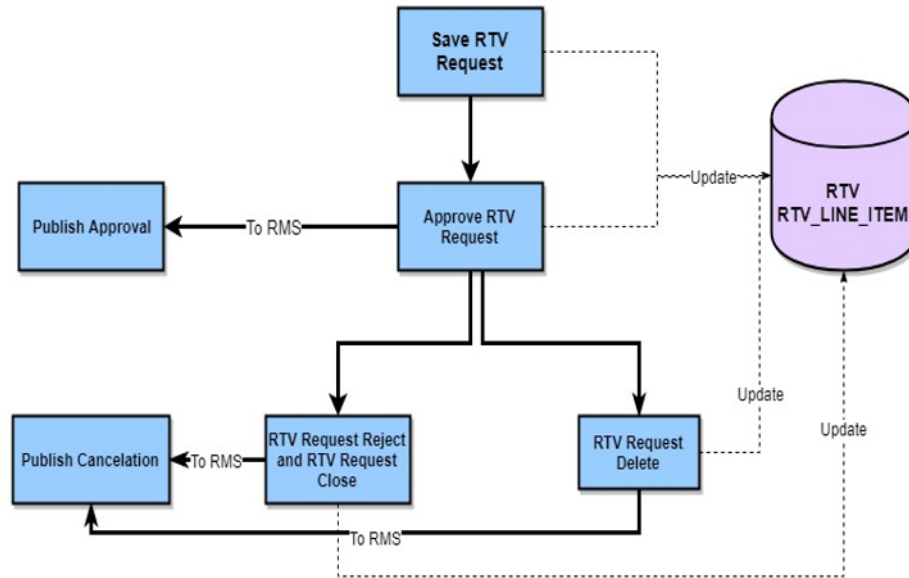

Figure 8-7 RTV Shipment Flow

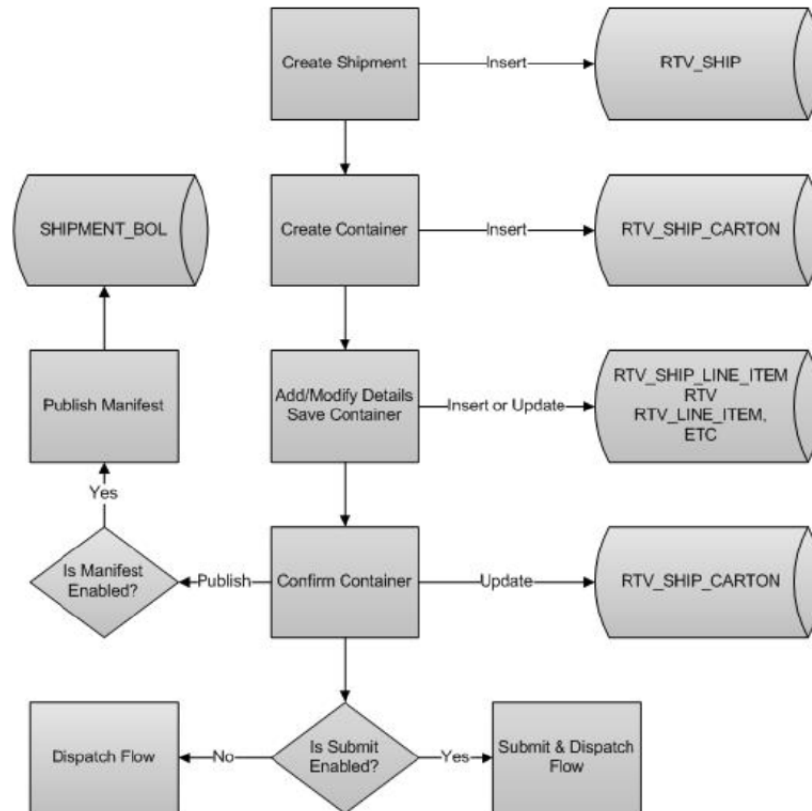
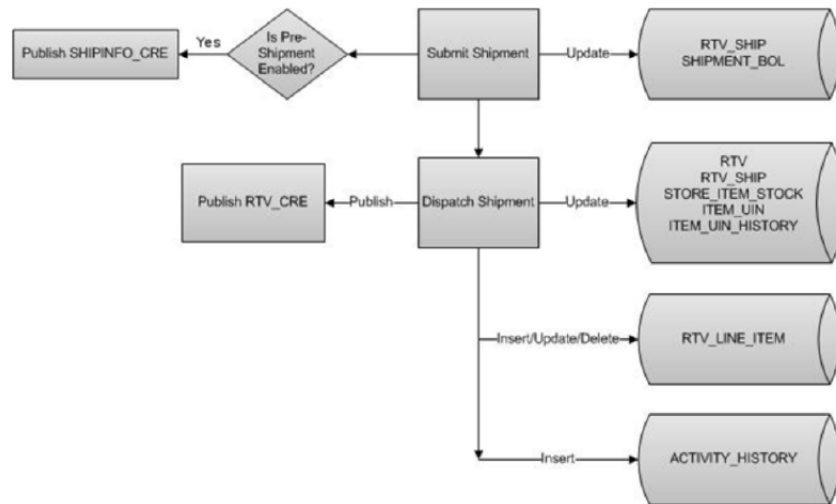
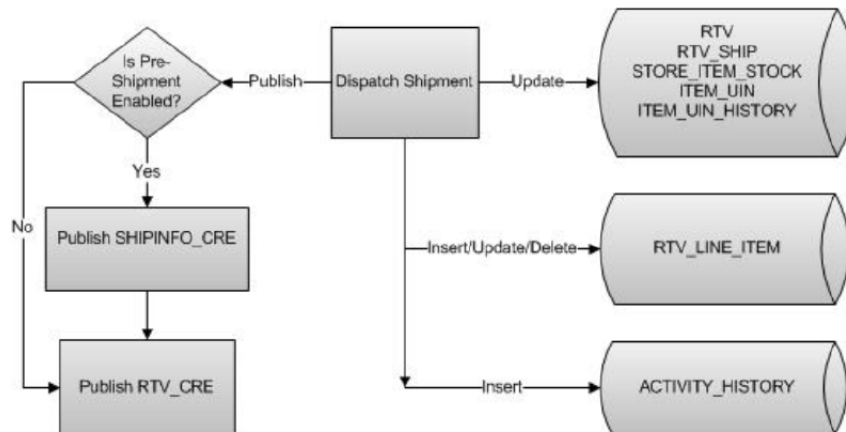

Figure 8–8 RTV Shipment Submit and Dispatch Flow**Figure 8–9 RTV Shipment Dispatch Flow**

The following payloads are used in RTV operations.

RIB Payload	Description
RTVReqDesc	This payload is sent from an external system to indicate a request for a vendor return. It creates or updates a vendor return document within EICS. It contains a series of RTVReqDtl.
RTVReqDtl	This payload contains the detailed information about the items on the vendor return.
RTVReqRef	This payload contains reference information about a vendor return when an external system wishes to attempt to cancel the return.
RTVDesc	This payload is sent from EICS to external systems when an RTV shipment is dispatched. This payload is sent from external warehouse system for vendor returns originating at warehouse.

Batch Integration

This section contains the following:

- [Overview](#)
- [BDI-Based Batch Integration](#)
- [SFTP-Based Batch File Integration](#)

Overview

Batch bulk data is still a predominant integration style within Oracle Retail and its customers. Currently SIOCS bulk data integrations are implemented as BDI-Based batch integration or SFTP-Based batch integration.

BDI-Based Batch Integration

Oracle BDI (Bulk Data Integration) is the latest Oracle Retail Integration tool for bulk data movement. The BDI infrastructure applications move data from one application to another. So there is data producing applications and data consuming applications.

Figure 8–10 BDI-Based Batch Integration Process

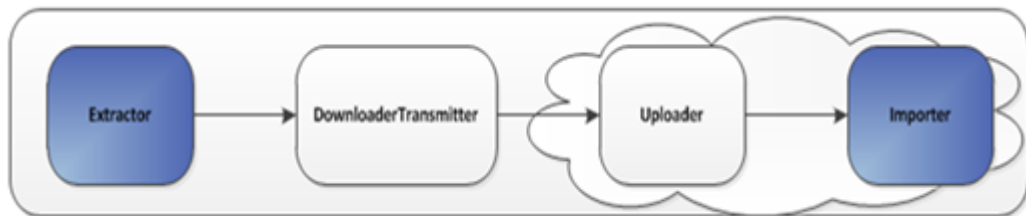

The BDI process:

- An Extractor extracts data from a data producing system into an outgoing intermediate integration interface table.
- A Downloader and transporter services data to receiver service.
- An Uploader uploads the data to an incoming intermediate integration interface tables.
- An Importer imports the data from the interface stage tables into SIOCS application tables.

For more information about data seeding, see the *Oracle® Retail Enterprise Inventory Cloud Service Administration Guide*.

Initial Foundation Data Seeding

Using BDI (Bulk Data Integration) Process Flow, you can load foundation data in bulk, including inventory and stock holding entities, from a data producing system into Oracle SIOCS.

Data Seeding is most suitable for:

- Loading initial inventory holding data
- Loading large volumes of data

Typically, you use data seeding for an initial data seeding and maintain the data in SIOCS thereafter, or through near-real time data integration with data producing system systems.

Table 8–1 BDI Foundation Data Seeding Integration Object List

Business Object	Inbound/Outbound	Source/Destination
Code Detail	Inbound	RMFCS
Code Head	Inbound	RMFCS
Delivery Slot	Inbound	RMFCS
Differentiator Group	Inbound	RMFCS
Differentiator	Inbound	RMFCS
Item Header	Inbound	RMFCS
Item Image	Inbound	RMFCS
Item Location	Inbound	RMFCS
Inventory Available Store	Inbound	RMFCS
Item Supplier	Inbound	RMFCS
Item Supplier Country Dimension	Inbound	RMFCS
Item Supplier Country	Inbound	RMFCS
Item Supplier Manufacturing Country	Inbound	RMFCS
Item Supplier UOM	Inbound	RMFCS
Merchandise Hierarchy	Inbound	RMFCS
Partner	Inbound	RMFCS
Partner Address	Inbound	RMFCS
Partner Org Unit	Inbound	RMFCS
Price History	Inbound	RMFCS
Pack Item	Inbound	RMFCS
Related Item	Inbound	RMFCS
Replenishment Item Location	Inbound	RMFCS
Supplier	Inbound	RMFCS
Supplier Address	Inbound	RMFCS
Store	Inbound	RMFCS
Store Address	Inbound	RMFCS
UDA	Inbound	RMFCS
UDA Item Date	Inbound	RMFCS
UDA Item Free Form	Inbound	RMFCS
UDA Item LOV	Inbound	RMFCS
UDA Values	Inbound	RMFCS
UOM Class	Inbound	RMFCS
UOM Conversion	Inbound	RMFCS
Warehouse	Inbound	RMFCS

Table 8–1 (Cont.) BDI Foundation Data Seeding Integration Object List

Business Object	Inbound/Outbound	Source/Destination
Warehouse Address	Inbound	RMFCS

Recurring BDI Transaction Batches

BDI Transaction batches are recurring batches to move bulk data between integrated applications. You can use BDI Scheduler to schedule selective transaction data batches. For details, please see *Oracle Retail Bulk Data Integration Implementation Guide*.

Table 8–2 BDI Transaction Batch List

Batch Name	Source/ Destination
Clearance TX Import	RPCS
Price Change TX Import	RPCS
Promotion TX Import	RPCS
Inventory Available Warehouse TX Import	RPCS

Transfer Transaction Import

Purchase Order Transaction Import

Clearance TX	Import clearance price from Oracle Retail Pricing Cloud Service via BDI Process Flow.
Price Change TX	Import clearance price from Oracle Retail Pricing Cloud Service via BDI Process Flow.
Promotion TX	Import promotion from Oracle Retail Pricing Cloud Service via BDI Process Flow.
Inventory Available Warehouse TX	Import warehouse available inventory from third party via BDI Process Flow.

BDI Transmitter CLI - Client Batch File Loader

The BDI CLI Transmitter is a standalone command line tool to transmit batch interface data files to a destination BDI receiver system.

It is particularly used where the source system is non-BDI (that is, the source system does not have or use BDI Batch Job Admin application) but needs to send interface data files to a receiver system running the BDI Job Admin application.

The tool uses the BDI Job Admin Receiver REST service URL to transmit the data to the destination system. So it is necessary that the destination system runs the BDI Job Admin application to use the tool.

Note: When use BDI Transmitter CLI tool to integrate with EICS, the app name for EICS in BDI is called SIM (Store Inventory Management).

The following figure illustrates the basic process for importing data using the BDI Transmitter CLI and EICS importer.

Figure 8–11 BDI Transmitter CLI

The BDI Transmitter CLI client tool process the data files from client machine, and load data into receiver application's staging inbound tables. The transmitter tool only load data into the Receiver's staging tables. To move data from receiver's staging tables into application's tables, you can use schedule EICS importer job to import the data from staging tables into EICS application tables.

Following is a list of batch file import implementations using BDI Transmitter CLI tool, alternatively the BDI External Process Flow can be chosen by integration implementation consultant, please see *Oracle Retail Bulk Data Integration Implementation Guide*.

Table 8–3 BDI Transmitter CLI List

Batch Name	Description	Source/ Destination
External Price TX Import	Import pricing data from external source into EICS, you can use BDI CLI Transmitter client tool to load CVS data file into BDI inbound interface tables, then setup SIOCS Batch job schedule to import data from inbound interface tables into EICS application tables. For additional detail, please see Appendix: BDI Transmitter CLI Procedure - Load External Data File .	Third Party
External RFID TX Import	Import RFID data from external source, typically this can be implemented using BDI External Process Flow when external system implemented BDI Job Admin; alternatively you can use BDI CLI Transmitter for CVS data file. For additional detail, please see Appendix: BDI Transmitter CLI Procedure - Load External Data File .	Third Party
Direct Delivery Transaction Import	Initial Seed Open Direct Delivery from External System. See Appendix: Open Transaction Seed for details.	Third Party
Purchase Transaction Import	Initial Seed Open Purchase Order from External System. See Appendix: Open Transaction Seed for details.	Third Party
Transfer Transaction Import	Initial Seed Open Transfer from External System. See Appendix: Open Transaction Seed for details.	Third Party

SFTP-Based Batch File Integration

In addition to BDI-Based Batch to move data between applications, EICS also supports SFTP-Based Batch File Integrations for list of batch modules. For additional detail, please see [File Processing](#) and [SFTP Nightly Batch File Uploads](#).

SFTP-Based Batch File Integration Modules:

Table 8–4 SFTP-Based Batch File Integration Modules

Object Name	Description	Source/Destination
POS Transaction Import	This batch imports POS Transaction records from the flat file that came from POS into the database staging table where polling timer framework will pick those staged requests and update the stock tables.	External POS
Retail Sale Audit Import	This batch program imports sales/order transaction data (SIM-ReSA file) that originated in Oracle Retail Xstore Point of Service. The batch also writes each failure record into a transaction log table.	ReSA
Store Sequence Import	This batch file import sequencing information like store sequence areas and items mapped to those areas from a flat file.	Third Party
Warehouse Item Stock Import	This batch imports the inventory of an items in a warehouse from flat files into warehouse item table.	Third Party
Inventory Extract	This batch extracts the inventory to a file that has been altered on or after the specified date for the specified store. The store id is not mandatory for the batch process. In case store id is not passed the files will be generated per store. The scheduled job will always generate files for all stores.	Order Broker
Stock Count Export	The stock count export files are generated when unit amount stock count is authorized.	Third Party
Clearance Price Change Import with On-prem RPM	<p>This batch process imports the clearance price changes from flat files into item price table. Application uses this data to update price information of the items.</p> <p>For details, see Appendix: Pricing Import with On-premise RPM.</p> <p>This batch will be phased out in future release.</p> <p>For Clearance pricing integration with RPCS, see Clearance Transaction Import</p>	On-prem RPM
Promotion Price Change Import with On-prem RPM	<p>This batch process imports the promotion price changes from flat files into item price table. Application uses this data to update price information of the items.</p> <p>For details, see Appendix: Pricing Import with On-premise RPM.</p> <p>This batch will be phased out in future release.</p> <p>For cloud promotion Pricing Integration, see third Party Pricing Import</p>	On-prem RPM

Table 8–4 (Cont.) SFTP-Based Batch File Integration Modules

Object Name	Description	Source/Destination
Regular Price Change Import with On-prem RPM	<p>This batch process imports the price changes from flat files into item price table. Application uses this data to update price information of the items.</p> <p>For details, see Appendix: Pricing Import with On-premise RPM.</p> <p>This batch will be phased out in future release.</p> <p>For cloud Pricing Integration, see Price Change Transaction Import</p>	On-prem RPM

Web Services

EICS provides a large range of web services to manage the processing of information that is controlled within EICS. Each web service covers a topical area of functionality within EICS and contains numerous operations within to accomplish this functionality. This document is only meant as an outline or summary into using EICS web services and assumes the user has access to the fully documented APIs through the publishing of the web services themselves.

- [Functionality](#)
- [Available Web Services](#)
- [Web Services Basic Design Principles](#)
- [Internally Managed vs Externally Managed](#)
- [Web Service Operation Basic Design Standards](#)
- [Interpreting Validation Errors](#)

Functionality

This document is intended to be used by someone who has read and understands all the functional areas and business functionality described in the *Oracle Retail EICS User's Guide* and *Oracle Retail EICS Administration Guide*.

Available Web Services

The following list contains a summary of the web services available in EICS.

Service	Description
Web Service: ActivityLock	This service is used to manage the locking of data within EICS. Data needs to be locked to be updated securely.
Web Service: FulfillmentOrderDelivery	This service is used to manage fulfillment order deliveries (outgoing shipment to customers). It allows the creation, cancellation and dispatch of deliveries.
Web Service: FulfillmentOrderPick	This service is used to manage fulfillment order picking within EICS. It allows the creation, deletion and confirmation of a pick to complete a fulfillment order.
Web Service: FulfillmentOrderReversePick	This service is used to manage fulfillment order reverse picking within EICS. It allows the creation, update, deletion and confirmation of a reverse pick.

Service	Description
Web Service: InventoryAdjustment	This service is used to manage inventory adjustments within EICS. It allows the creation, update, cancellation and confirmation of inventory adjustments.
Web Service: Item Basket	This service is used to manage item baskets within EICS. It allows the creation, update, and removal of item baskets.
Web Service: POSTransaction	This service processes external point-of-sale transactions updating the inventory accordingly. A point-of-sale is considered an externally managed transaction (internally and externally managed transaction are covered later in this document).
Web Service: ProductGroup	This service is used to create or update a product group.
Web Service: ProductGroupSchedule	This service is used to create, update, or cancel a product group schedule.
Web Service: ReplenishmentGap	This service is used to create, update, or delete a replenishment gap.
Web Service: RfidInventory	This service is used to create, update or delete a RFID facility zone. It is also used to refresh inventory and to process RFID events.
Web Service: ShelfAdjustment	This service is used to create, update, cancel or confirm a shelf adjustment.
Web Service: ShelfReplenishment	This service is used to create, update, cancel or confirm a shelf replenishment.
Web Service: StockCount	This service is used to retrieve the details of a stock count or a stock count child (section of stock count).
Web Service: Store	This service is used to retrieve information about stores such as store detail, associated stores, or transfer zones.
Web Service: StoreFulfillmentOrder	This service is used to manage fulfillment orders within EICS. It allows for the cancellation and rejection of orders and items.
Web Service: StoreInventory	This service is used to lookup information about inventory positions and has several different operations to do so.
Web Service: StoreInventoryUIN	This service is used to create, update, generate or read a UINs.
Web Service: StoreInventoryISN	This service is used to create, update or delete ISN data in EICS.
Web Service: StoreItem	This service is used to lookup various information about an item within the store.
Web Service: StoreItemPrice	This service is used to lookup prices about items within a store.
Web Service: StoreNotification	This service is used to create new notifications within the system.
Web Service: StoreShipmentManifest	This service is used to close documents based on shipped container information.
Web Service: StoreShipmentReason	This service is used to retrieve shipment reasons codes to use when creating shipments.
Web Service: StoreTransfer	This service is used to create, update and request a transfer, which describes the intent to ship items to another store or to a warehouse. It is also used to approve or reject that request. It can be used to directly create, update, approve, cancel, or close an actual transfer.

Service	Description
Web Service: TransferDelivery	This service is used to update, receive, or confirm a transfer delivery (delivery arriving from another store or warehouse). It is also used to create, update, receive, cancel, or confirm the containers on that delivery.
Web Service: TransferShipment	This service is used to create, update, submit, or dispatch a transfer shipment (shipment going out to another store or warehouse). It is also used to create, update, cancel, or confirm the containers on that shipment.
Web Service: VendorDelivery	This service is used to update, receive, reject, or confirm a vendor delivery (delivery arriving from a supplier). It is also used to create, update, cancel, or confirm the containers on that delivery.
Web Service: VendorReturn	This service is used to create, update, approve, cancel, or close a vendor return document, which describes the intent to ship items to a supplier.
Web Service: VendorShipment	This service is used to create, update, open, submit, cancel submit or dispatch a vendor shipment (outgoing shipment to a supplier). It is also used to create, update, cancel, submit or confirm the containers on that shipment.

Web Services Basic Design Principles

Empty Response

In the cast that a web service does not return any information (an empty list), the external system needs to understand that this is a valid response that indicates no item, transaction or queried information was found or retrieved. For example, performing a lookup in which the search criteria entered matched no input.

Error Return Key

Errors returned through a web service will be in the form of a key. This key should be translated into correct language and verbiage by the external system. EICS will not do this translation or provide English verbiage for the encountered web service error.

Boolean Data Type

If a Boolean is the data type on the interface to EICS, and no value is provided, EICS will default the value to False.

Configured System Options in EICS

Web services apply system configurations to the request that are coming in through the web service, but assumes that all input validation that requires user interaction to confirm has been completed by the access or of the web service. This system configuration user-interaction option will be assumed to have been confirmed during the web service processing. In case the system option is a fixed restriction that does not require user interaction, and the input fails this restriction, the web service will return an error. For example:

- Shipping inventory when inventory is less than 0 can be allowed by the user of EICS. The web service assumes that the third party application did prompt the user or that their business always allows the user to do this activity.
- Adding a non-ranged item requires both a system configuration option to be enabled and the user to confirm the process. If the system configuration does not allow it, the web service will block the transaction and return an error. If the

system configuration does allow adding non-ranged items, it is automatically assumed that a user confirmed its addition and the web service adds the item.

- Allowing Receiver Unit Adjustments are dependent on a period of time. If a receiver unit adjustment were to come into EICS after that period of time, it would automatically be rejected and the web service would return an error regardless of presentation or confirmation of user done by the external system.

Internally Managed vs Externally Managed

Internally Initiated

Internally initiated indicates the EICS was responsible for the original creation of the transaction being processed. A web service that creates a new transaction within EICS to be managed creates an internally initiated transaction.

Externally Initiated

Externally initiated indicates that another system created the transaction, has information about it, and notifies EICS of its creation through a notification system, not by requesting EICS create new information. EICS might manage the data after the notification, but did not create the data.

Internally Managed

Internally managed data is information in which EICS is responsible for tracking its state and processing its life cycle. Our deliveries and shipments are primary examples of this. They may be externally initiated or internally initiated, but either way, they are internally managed. EICS is responsible for approving, picking, packing, manifesting, and dispatching the system and internally manages that process.

Externally Managed

Externally managed data is information that EICS does not process or track and is simply informed about after the externally managed data is complete. Point-of-sale transactions are a perfect example of this. We do not manage the sale, but once it is complete, EICS is notified and adjusts the inventory accordingly.

Web Services

EICS web services are intended for integration in order to allow a system using those services to control the flow and processing within EICS. Our web services are primarily designed (almost all of them) to internally manage the information. The services are intended to be used real time with the steps such as approving, picking, and dispatching occurring with real time access to EICS web services while the process is happening.

EICS web services are not designed for externally managed information. If a system is controlling the state managements itself and not informing EICS until later, this will produce out-of-sync inventory. For example, if you create a shipment, pack the shipment, and send it out and then a day later use the web service, to create, update, and dispatch the shipment, all dates and processing of inventory movements will be tagged with the later date as if they occurred real time when the web service is used.

The point-of-sale service is an externally managed service, where the timestamp on the service can be any date and EICS handles the logic of dating things according to that timestamp. Inventory Adjustment also has an "adjustment date" which represents the time the adjustment took place and so the movement of inventory can be controlled externally.

Web Service Operation Basic Design Standards

This section discusses the general approach and design standards for naming and intent regarding operations within a web service.

Lookup

Lookup operations take either an identifier of a set of criteria and find all the relevant records associated to it. A thin or light view of the data being asked for is returned giving reference to information you can do further interrogation on.

Read

Read operations take an identifier and return all relevant information to it. It may only be one level however. For example, reading a transfer shipment returns only all the information at the shipment level and does not read information at the container or item level. Usually the entity that contains items will also retrieve the items. Reading a container will return the container information and the item information within.

Create

Create usually inserts and generates something new and returns an identifier, reference, or handler to that information. Create normally does not take a great deal of information, such as items or anything, but rather gives you a set of IDs that then lets you update the transaction with that reference.

Save or Update

Save or update is used to modify the data usually without changing state on the transaction. The save or update operation is used to add items, remove items, edit attributes, change quantities and all the other tasks one does during a process.

Approve, Cancel, Confirm or Dispatch

Activities that change state take in a simple identifier and then process that state change. To dispatch a shipment, you pass in a reference only to the shipment and it becomes shipped, updating the inventory. This means all changes are done through the save operations prior to making the state change.

Interpreting Validation Errors

If some data could not be processed, the web service will return a fault or a validation fault. The general form that a fault will take is to be a series of problem detail nodes containing a key and value that describes the fault. The first problem detail node will have the key ERROR and the value will be a description of the error type such as INVALID_INPUT. This will be followed by a series of nodes where the KEY is an object class name (ex: Transfer) and the value is its identifier (ex: 123) describing the hierarchy of data the error took place in. For example, a transfer container fault would have two nodes (Transfer:123) and then (TransferCarton:456). If a specific attribute is known, the final node in any problem detail series is will have the key ATTRIBUTE and the value will be the name of the attribute of the error (ex: ITEM_ID:A5X).

Problem Detail Name	Value
ERROR	This describes the error (for example: INVALID_INPUT)
ATTRIBUTE	Identifies the specific attribute that had an error.

EICS follows the same business rules when processing information from a web service as it does from any of its clients, so the same business rules and functionality that exist in the User's Guide also exists for the web service. Understanding the basic functionality will help interpret why the validation or processing error occurred.

Common Error Codes

The following codes are paired as values to the ERROR Key:

Error Code	Description
ACTIVITY_LOCK_NOT_GRANTED	Indicates that a requested activity lock on a piece of data was not granted.
DUPLICATE_INPUT	Indicates the service would create a duplication of input that should be unique.
INVALID_DATE_RANGE	Indicates the end date of a date range is prior to the start date.
INVALID_INPUT	Indicates that the input is invalid. This error is usually followed by object and attribute information.
INVALID_ITEM	Indicates the item does not exist in the system.
INVALID_STATE_FOR_UPDATE	Indicates the transaction or data specified is not in a state that allows it be updated (such as canceled).
INPUT_MISMATCH	Indicates the input to the web service has been altered incorrectly when compared to existing data. For example, the store identifier is different on the web service request than the currently existing transaction.
INPUT_TOO_LARGE	Indicates the input in the web service is larger than is allowed in the transaction date.
ITEM_NOT_RANGED	Indicates the item has not been activated in the location for which the request is made.
MULTIPLE_STORE	Indicates a batch of input data (such as a point-of-sale transaction) was for more than one store in a single web service call.
TIMEZONE_NOT_GMT	Indicates the time input of the web services was not in GMT.
UOM_MISMATCH	Indicates a mismatch of unit of measure information between the input and currently existing data that does not allow the information to be accurately merged.

Validation Error (Fault Example)

```
<S:Envelope xmlns:S="http://schemas.xmlsoap.org/soap/envelope/">
  <S:Body>
    <ns0:Fault xmlns:ns0="http://schemas.xmlsoap.org/soap/envelope/"
      xmlns:ns1="http://www.w3.org/2003/05/soap-envelope">
      <faultcode>ns0:Server</faultcode>
      <faultstring>VALIDATION_ERROR</faultstring>
      <detail>
        <ns0:ValidationWSFaultException
          xmlns:ns0="http://www.oracle.com/retail/integration/services/exception/v1">
          <ns0:shortErrorMessage>VALIDATION_ERROR</ns0:shortErrorMessage>
          <ns0:BusinessProblemDetail>
```

```

        <ns0:problemDescription>VALIDATION_
ERROR</ns0:problemDescription>
        <ns0:ProblemDetailEntry>
            <ns0:name>ERROR</ns0:name>
            <ns0:value>INVALID_INPUT</ns0:value>
        </ns0:ProblemDetailEntry>
        <ns0:ProblemDetailEntry>
            <ns0:name>ShlfAdjRef</ns0:name>
            <ns0:value>1</ns0:value>
        </ns0:ProblemDetailEntry>
        <ns0:ProblemDetailEntry>
            <ns0:name>ATTRIBUTE</ns0:name>
            <ns0:value>shelfAdjustmentId</ns0:value>
        </ns0:ProblemDetailEntry>
    </ns0:BusinessProblemDetail>
</ns0:ValidationWSFaultException>
</detail>
</ns0:Fault>
</S:Body>
</S:Envelope>

```

Business Error (Fault Example)

```

<S:Envelope xmlns:S="http://schemas.xmlsoap.org/soap/envelope/">
  <S:Body>
    <ns0:Fault xmlns:ns0="http://schemas.xmlsoap.org/soap/envelope/"
xmlns:ns1="http://www.w3.org/2003/05/soap-envelope">
      <faultcode>ns0:Server</faultcode>
      <faultstring>BUSINESS_ERROR</faultstring>
      <detail>
        <ns0:ValidationWSFaultException
xmlns:ns0="http://www.oracle.com/retail/integration/services/exception/v1">
          <ns0:shortErrorMessage>BUSINESS_ERROR</ns0:shortErrorMessage>
          <ns0:BusinessProblemDetail>
            <ns0:problemDescription>BUSINESS_ERROR</ns0:problemDescription>
            <ns0:ProblemDetailEntry>
              <ns0:name>ERROR CODE</ns0:name>
              <ns0:value>ADJUSTMENT_NOT_FOUND</ns0:value>
            </ns0:ProblemDetailEntry>
          </ns0:BusinessProblemDetail>

```

```

        </ns0:ValidationWSFaultException>
    </detail>
</ns0:Fault>
</S:Body>
</S:Envelope>

```

Web Services

Web services available in EICS:

Web Service: ActivityLock

The following operations are available within the ActivityLock web service.

Operation	Description
lookupActivityLock	Retrieves information about one or more activity locks that match the input criteria.
readActivityLock	Retrieves detailed information about a single lock using its identifying reference.
createActivityLock	Created an activity lock on a transaction.
deleteActivityLock	Deletes an activity lock thereby releasing processing on a transaction.

Standard Usage

An activity lock is a record indicating the user, time, and a piece of information (a transaction) that should be considered "locked". All server processing validates that the accessing user has a lock on the information before updating, notifying the current user if someone else has modified the information while they were locked and preventing the stale update.

Developers should create locks on information prior to performing update calls and delete locks when the update is finished. For example, create a lock on inventory adjustment with ID 123 with the ActivityLock service, then use `saveInventoryAdjustment` in the Inventory Adjustment service with Adjustment 123, and then delete the activity lock using the ActivityLock service. If you do not gain the lock, you will receive an error when attempting to save an inventory adjustment.

Web Service: FulfillmentOrderDelivery

The following operations are available within the FulfillmentOrderDelivery web service.

Operation	Description
lookupFulfillmentOrderDeliveryHeaders	Retrieves summary information for fulfillment order deliveries that match the search criteria input.
readFulfillmentOrderDeliveryDetail	Reads the complete detailed information about a fulfillment order including items and quantities.
createFulfillmentOrderDelivery	Creates a new fulfillment order delivery including items and quantities in an in-progress status to be further worked on.
cancelFulfillmentOrderDelivery	Cancels the fulfillment order delivery.

Operation	Description
cancelFulfillmentOrderDeliverySubmission	Cancels the fulfillment order review and moves it back into in-progress status for further work.
dispatchFulfillmentOrderDelivery	Dispatches the fulfillment order delivery completing the delivery and updating the inventory.
submitFulfillmentOrderDelivery	Submits the fulfillment order delivery for review prior to dispatching.
updateFulfillmentOrderDelivery	Updates a fulfillment order delivery including items and quantities. This operation requires an activity lock.
lookupCustomAttributeAdmins	Retrieves the custom attribute administration information that describes what customized attributes are available on the fulfillment order delivery.

Standard Usage

A user can create a delivery by using `createFulfillmentOrderDelivery` references the fulfillment order to make a delivery for. The user can then use `updateFulfillmentOrderDelivery` to fill in all the quantities that are going to be shipped and finally use `dispatchFulfillmentOrderDelivery` to indicate that the order has been shipped out, which moves the inventory appropriately.

Web Service: FulfillmentOrderPick

The following operations are available within the FulfillmentOrderPick web service.

Operation	Description
lookupFulfillmentOrderPickHeaders	Retrieves summary information for fulfillment order picks that match the search criteria input.
readFulfillmentOrderPick	Reads the complete detailed information about a fulfillment order pick including items and quantities.
confirmFulfillmentOrderPick	Confirm the fulfillment order pick which allows it to move on to the delivery cycle.
deleteFulfillmentOrderPick	Deletes a fulfillment order pick.
createFulfillmentOrderPickByFulfillmentOrder	Generate a pick based on the information in a fulfillment order.
createFulfillmentOrderPickByBin	Generate a pick based on a number of bins selecting orders as needed to fill the bins.
updateFulfillmentOrderPick	Update the item and quantity information about a pick. This operation requires an activity lock.
lookupCustomAttributeAdmins	Retrieves the custom attribute administration information that describes what customized attributes are available on the fulfillment order pick.

Standard Usage

Picking is used to reserve or set aside quantities for a later delivery. The user can create a pick for an order using `createFulfillmentOrderPickByFulfillmentOrder` or create a bin to place multiple orders in with `createFulfillmentOrderPickByBin`. The picked quantities can be updated through the `updateFulfillmentOrderPick` operation and when the pick is finished, it can be finalized with `confirmFulfillmentOrderPick` which sets assigned the goods as reserved in inventory.

Web Service: FulfillmentOrderReversePick

The following operations are available within the FulfillmentOrderReversePick web service.

Operation	Description
lookupReversePickHeaders	Retrieves summary information for fulfillment order reverse picks that match the search criteria input.
lookupReversePickDetail	Reads the complete detailed information about a fulfillment order reverse pick including items and quantities.
createReversePick	Creates a new fulfillment order reverse pick for the specified fulfillment order.
deleteReversePick	Deletes a fulfillment order reverse pick.
updateFulfillmentOrderReversePick	Updates the items and quantities on a fulfillment order reverse pick. This operation requests an activity lock.
confirmReversePick	Confirms the fulfillment order reverse pick completing the process and assigning the inventory back to a location within the store system.
lookupCustomAttributeAdmins	Retrieves the custom attribute administration information that describes what customized attributes are available on the fulfillment order reverse pick.

Standard Usage

Reverse Picking is used to take reserved quantities and place them back into available inventory. The user can create a reverse pick with `createReversePick`. The quantities to return can be updated through the `updateFulfillmentOrderReversePick` operation and when the reverse pick is ready, it can be finalized with `confirmReversePick` which moves reserved inventory back into available inventory.

Web Service: InventoryAdjustment

The following operations are available within the InventoryAdjustment web service.

Operation	Description
lookupInventoryAdjustmentReason	Retrieve a complete list of adjustment reasons that can be used when updating or saving an inventory adjustment. Reason codes are attached to each line item.
lookupNonSellableQuantityType	Retrieve a complete list of non-sellable quantity types. These code indicate the reason that unavailable inventory is unavailable.
lookupInventoryAdjustmentHeader	Retrieve summary information about inventory adjustment transactions based on the search criteria sent.
readInventoryAdjustmentDetail	Retrieve the complete detailed information about an inventory adjustment, including its item information, based on a unique reference/id.
saveInventoryAdjustment	Creates or updates the information about an inventory adjustment in the data store. You can alter information about items and quantities using this operation. This operation requires having an activity lock.
confirmInventoryAdjustment	Confirms the inventory adjustment, updating all the inventory positions, and closing the adjustment.

Operation	Description
saveAndConfirmInventoryAdjustment	Performs the functionality of saveInventoryAdjustment and immediately thereafter performs the confirmInventoryAdjustment functionality. See those operations.
cancelInventoryAdjustment	Cancel an inventory adjustment. This can only be done prior to the inventory adjustment being confirmed.
lookupCustomAttributeAdmins	Retrieves the custom attribute administration information that describes what customized attributes are available on the inventory adjustment.

Standard Usage

A new inventory adjustment can be created using the `saveInventoryAdjustment` operation. Alternatively, the user can `lookupInventoryAdjustmentHeader` to find a specific inventory adjustment to work on. Either way, `saveInventoryAdjustment` can be used to update the information on an open adjustment. The `lookupInventoryAdjustmentReasons` will retrieve the reasons codes that need to be assigned to items when you update an adjustment. When the adjustment contains all the information you need, the `confirmInventoryAdjustment` operation will finalize the inventory adjustment and shift the inventory appropriately.

Web Service: Item Basket

The following operations are available within the Item Basket web service.

Operation	Description
lookupItemBasketHeaders	Retrieve a list of item basket headers based on search criteria which contain summary information about the item basket.
lookupItemBasketTypes	Retrieve a complete list of item basket types to use when creating a new item basket.
createItemBasket	Creates a new item basket.
readItemBasketDetail	Retrieve the complete detailed information about an item basket based on an identifier.
deleteItemBasket	Cancels an item basket. The basket will no longer be usable and will be marked for eventual purge from the data store. This operation requires an activity lock.
saveItemBasket	Updates an item basket. This operation requires an activity lock.
copyItemBasket	Creates a new item basket with the same information as an existing item basket.
confirmItemBasket	Moves the item basket to a completed state and allows it to be used within logic throughout the system. This operation requires an activity lock.
lookupCustomAttributeAdmins	Retrieves the custom attribute administration information that describes what customized attributes are available on the item basket.

Standard Usage

A new item basket can be created using the `saveItemBasket` operation. Alternatively, the user can `lookupItemBasketHeader` to find a specific item basket to work on. Either way, `saveItemBasket` can be used to update the information on an item basket. When the item basket contains all the information you need, the `confirmItemBasket` operation will finalize the item basket and make it available to use in other areas of the system.

Web Service: POSTransaction

The following operations are available within the StoreNotification web service.

Operation	Description
processPOSTransactions	Processes a point-of-sale transaction or transactions through an asynchronous process. This is designed to optimize the processing of large numbers of point-of-sale transaction (up to a limit of 5,000 PosTrnItm details).

Standard Usage

POS may integrate its transactions to EICS using this web service. The service processes point-of-sale transactions through an asynchronous process. This service only allows 5,000 overall PosTrnItms, though they may be distributed between any number of actual PosTrn transactions. Exceeding this limit causes a web service fault to occur. These transactions may belong to multiple store identifiers. The processing operation validates the input, parses the payload information, creates a POSTransaction object within EICS, and stores these records to be processed later. See [Sales Integration](#) for additional information.

Web Service: ProductGroup

The following operations are available within the ProductGroup web service.

Operation	Description
lookupProductGroupHeader	Retrieves list of summary information about a product group that match the search criteria input.
readProductGroup	Retrieves the detailed information about a single product group based on its unique reference.
saveProductGroup	Creates or updates a product group. The input contains all the detailed information about the product group. An activity lock is needed for this operation.

Standard Usage

With this web service, the user can create or update the contents of a product group, a collection of items associated with a certain type of grouping, such as stock counts. The user can find the product group with `lookupProductGroupHeader`, read in the entire product group with `readProductGroup` and then, if the group is still open, update the contents of the product group with `saveProductGroup`.

Web Service: ProductGroupSchedule

The following operations are available within the ProductGroupSchedule web service.

Operation	Description
lookupProductGroupScheduleHeader	Retrieves list of summary information about a product group schedule that match the search criteria input.
readProductGroupSchedule	Retrieves the detailed information about a single product group schedule based on its unique reference.
saveProductGroupSchedule	Creates or updates a product group. The input contains all the detailed information about the product group schedule. An activity lock is needed for this operation.

Operation	Description
cancelProductGroupSchedule	Cancels the product group schedule.

Standard Usage

With this web service, the user can create or update the contents of schedule, which uses a product group to generate activity within EICS. The user can find the schedule with `lookupProductGroupScheduleHeader`, read in the entire schedule with `readProductScheduleGroup` and then, if the schedule is still open, update the contents of the schedule with `saveProductGroupSchedule`.

Web Service: ReplenishmentGap

The following operations are available within the ReplenishmentGap web service.

Operation	Description
lookupReplenishmentGapHeaders	Retrieves list of summary information about replenishment gaps that match the search criteria input
readReplenishmentGap	Retrieves the detailed information about a single replenishment gap based on its unique reference.
saveReplenishmentGap	Creates a new replenishment gap or updates the detailed information about a replenishment gap. If update, this operation requires an activity lock.
deleteReplenishmentGap	Deletes a replenishment gap.
lookupCustomAttributeAdmins	Retrieves the custom attribute administration information that describes what customized attributes are available on the replenishment gap.

Standard Usage

With this web service, the user can create or update the contents of replenishment gap list which can then be used in creation of shelf replenishment within EICS. A new replenishment gap list can be created using `saveReplenishmentGap`. The user can update existing replenishment gap list with `saveReplenishmentGap`, find replenishment gap lists with `lookupReplenishmentGapHeaders`, read in the entire replenishment gap list with `readReplenishmentGap` and delete a replenishment gap list with `deleteReplenishmentGap`.

Web Service: RfidInventory

The following operations are available within the RfidInventory web service.

Operation	Description
deleteRfidZone	Deletes a zone within a facility. A zone cannot be deleted if RFID tags still exist within the zone.
lookupRfidZones	Returns details about all the zones within a particular facility.
processRfidEvents	Processes Radio-Frequency-Identification based events.
saveRfidZone	Creates or updates the details of a facility zone.

Standard Usage

With this web service, the user can create or update RFID zone within EICS. A new RFID zone can be created using `saveRfidZone`. The user can update existing RFID zone

list with `saveRfidZone`, find RFID zone lists with `lookupRfidZones` and delete a RFID zone with `deleteRfidZone`. The user can process a RFID based events using `processRfidEvents` and refreshes the inventory for items with `refreshInventory`.

Web Service: ShelfAdjustment

The following operations are available within the ShelfAdjustment web service.

Operation	Description
<code>lookupShelfAdjustmentHeaders</code>	Retrieves list of summary information about shelf adjustments that match the search criteria input.
<code>readShelfAdjustment</code>	Retrieves the detailed information about a single shelf adjustment gap based on its unique reference.
<code>saveShelfAdjustment</code>	Creates a new shelf adjustment or updates the detailed information about a current shelf adjustment. If update, this operation requires an activity lock.
<code>confirmShelfAdjustment</code>	Confirms a shelf adjustment completing the workflow and moving inventory positions.
<code>cancelShelfAdjustment</code>	Deletes a shelf adjustment.
<code>lookupCustomAttributeAdmins</code>	Retrieves the custom attribute administration information that describes what customized attributes are available on the shelf adjustment.

Standard Usage

Shelf adjustments are used to adjust the shop-floor or backroom stock in case of any discrepancy. A new shelf adjustment can be created using `saveShelfAdjustment`. The user can update existing shelf adjustment with `saveShelfAdjustment`, find shelf adjustment with `lookupShelfAdjustmentHeaders`, read in the entire shelf adjustment with `readShelfAdjustment`, cancel a shelf adjustment with `cancelShelfAdjustment` and confirm a shelf adjustment with `confirmShelfAdjustment`.

Web Service: ShelfReplenishment

The following operations are available within the ShelfReplenishment web service.

Operation	Description
<code>lookupShelfReplenishmentHeaders</code>	Retrieves list of summary information about shelf replenishments that match the search criteria input.
<code>readShelfReplenishment</code>	Retrieves the detailed information about a single shelf replenishment gap based on its unique reference.
<code>createShelfReplenishment</code>	Creates a new shelf replenishment.
<code>updateShelfReplenishment</code>	Updates the detailed information about a current shelf replenishment. This operation requires an activity lock.
<code>confirmShelfReplenishment</code>	Confirms a shelf replenishment completing the workflow and moving inventory positions.
<code>cancelShelfReplenishment</code>	Deletes a shelf replenishment.
<code>lookupCustomAttributeAdmins</code>	Retrieves the custom attribute administration information that describes what customized attributes are available on the shelf replenishment.

Standard Usage

Shelf replenishment is used to replenish shop-floor stock from backroom or delivery bay. A new shelf replenishment can be created with `createShelfReplenishment`. The user can find shelf replenishments with `lookupShelfReplenishmentHeaders`, read in the entire shelf replenishment with `readShelfReplenishment`, update the shelf replenishment with `updateShelfReplenishment`, confirm the shelf replenishment with `confirmShelfReplenishment` and cancel the shelf replenishment with `cancelShelfReplenishment`.

Web Service: StockCount

The following operations are available within the StockCount web service.

Operation	Description
<code>lookupStockCountHeaders</code>	Retrieves list of summary information about a stock counts that match the search criteria input.
<code>readStockCountDetail</code>	Retrieves the detailed information about a single stock count based on its unique reference. This contains a list of summary information about the child counts.
<code>readStockCountChild</code>	Retrieves the detailed information about a single stock count child.
<code>activateStockCount</code>	This activates and starts the stock counting process including taking a snapshot of current inventory positions.
<code>completeStockCountChild</code>	Completes the counting or recounting of a stock count child, depending on which phase the stock count is in. This process will calculate discrepancies and move the child to the next phase.
<code>updateCountQuantities</code>	Updates the counted or recounted quantity fields for a stock count child based on the current phase of the stock count.
<code>lookupCustomAttributeAdmins</code>	Retrieves the custom attribute administration information that describes what customized attributes are available on the stock count.

Standard Usage

The stock count web services are design primarily to export information for third party counting. You first lookup the headers, choose your head, retrieve all the details for the stock count, which does not contain item information but does contain a list of child count references. You can use these references to grab the full details of a child count which includes items and quantities.

Web Service: Store

The following operations are available within the Store web service.

Operation	Description
<code>lookupAutoReceiveStore</code>	Retrieves all stores that allow auto-receiving of inventory from the input store.
<code>lookupAssociatedStore</code>	Retrieves all stores that are associated to the input store. They are sometimes called buddy stores.
<code>lookupStoresInTransferZone</code>	Retrieves all stores in the same transfer zone as the input store.
<code>readStoreDetail</code>	Retrieves the detailed information about a single store from the input unique reference.

Standard Usage

The Store web service is used to retrieve information about stores. There are no updates. They are used to determine such information as whether or not you can ship to certain stores (such as those in transfer zones).

Web Service: StoreFulfillmentOrder

The following operations are available within the StoreFulfillmentOrder web service.

Operation	Description
lookuFulfillmentOrdersHeads	Retrieves summary information for fulfillment orders that match the search criteria input.
readFulfillmentOrderDetail	Reads the complete detailed information about a fulfillment order including items and quantities.
createFulfillmentOrderDetail	Creates a new fulfillment order with detailed information, including items and quantities.
cancelFulfillmentOrderDetail	Cancels quantities on a fulfillment order. This may cancel the entire order or just reduce or cancel quantities for specific items
rejectFulfillmentOrder	Rejects the fulfillment order indicating that the store will be unable to fulfill that particular order
lookupCustomAttributeAdmins	Retrieves the custom attribute administration information that describes what customized attributes are available on the fulfillment order.

Standard Usage

Unlike some of the other web services, fulfillment order is not managed within EICS. Instead, EICs manages the picking and delivery, but the order itself is managed by an external order management system.

Oracle Retail Order Broker (OB) calls SIOCS for inventory availability.

Web services are supplied to find and read the details of a fulfillment order, but updates are not allowed. Instead, the external system use `createFulfillmentOrderDetail` to notify EICS of a new order to ship, `cancelFulfillmentOrderDetail` to reduce or cancel quantities (note that they cannot be increased), or call `rejectFulfillmentOrder` to notify EICS that the order has been rejected.

Web Service: StoreInventory

The following operations are available within the StoreInventory web service.

Operation	Description
lookupAvailableInventory	Retrieves basic availability information for multiple items at multiple locations. Only transaction-levels items are processed (UPCs are not allowed) and only current inventory is returned. The service supports up to 200 items at 150 locations.
lookupAvailableInventoryAllStores	Retrieves basic availability information for a single item at all store locations. Only transaction-levels items are processed (UPCs are not allowed) and only current inventory is returned.
lookupInventoryInStore	Retrieves a broad set of inventory information for several items at several stores, broken down into various inventory groupings.

Operation	Description
lookupInventoryInTransferZone	Retrieves a broad set of inventory information for items within the specific transfer zone, broken down into various inventory groupings.
lookupInventoryForBuddyStores	Retrieves a broad set of inventory information for associated or buddy stores, broken down into various inventory groupings.
lookupFutureInventory	Retrieves the future inventory information (such as inbound, ordered quantities and expected dates) for an item and store location.
lookupAvailableInventoryAllWarehouses	Retrieves inventory information for a single item at multiple warehouses. Only transaction-level items are processed and only current inventory is returned.

Standard Usage

The StoreInventory is meant to retrieve inventory position information. Available inventory lookups are much smaller and quicker to respond than full inventory lookups. Future inventory is separated from current positions as it is much more time consuming to retrieve. Those who access the web services should give consideration to the purpose before choosing which operation to use.

Web Service: StoreInventoryISN

The following operations are available within the StoreInventoryISN web service.

Operation	Description
lookupIsnTypes	Returns a complete list of Item Scan Number types.
lookupIsn	Returns details about matching Item Scan Numbers in store inventory.
createIsn	Create a new Item Scan Number without changing store inventory.
updateIsn	Updates an existing Item Scan Number without changing store inventory.
deleteIsn	Deletes an Item Scan Number without changing store inventory.
lookupCustomAttributeAdmins	Retrieves all the custom attribute admins configured for ISNs.

Standard Usage

This web service is used to create, update or delete ISN in store inventory. An item scan number is any number meant to be scanned to find an item, and potentially a Unique Identification Number, that is not already an item, UPC, UIN, VPN, or other value. Items Scan Numbers are only used to find information and are not tracked as inventory.

Web Service: StoreInventoryUIN

The following operations are available within the StoreInventoryUIN web service.

Operation	Description
createUIN	Create a new UIN without changing store inventory.
generateUIN	Generate new UINs without changing store inventory.

Operation	Description
readUINDetail	Returns details about a UIN in store inventory. A UIN reference is not unique, so this may return detailed information for UINs across multiple items.
updateUIN	Updates an existing UIN without changing store inventory.

Standard Usage

This web service is used to create, generate, update or read UIN in store inventory.

Web Service: StoreItem

The following operations are available within the StoreItem web service.

Operation	Description
lookupItemHeaderByItem	Retrieves list of summary information about an item that match the item-based search criteria input.
lookupItemHeaderBySource	Retrieves list of summary information about an item that match the source or location-based search criteria input.
lookupItemHeaderByUDA	Retrieves list of summary information about an item that match the UDA (User Defined Attribute)-based search criteria input.
lookupItemHeaderByInventory	Retrieves list of summary information about an item that match the inventory-based search criteria input.
lookupItemCfa	Retrieve a list of custom flexible attributes for the specified item and store.
lookupItemUda	Retrieve a list of user defined attributes for the specified item and store.
readItemDetail	Retrieves the complete detailed information a single item based on its unique reference.
lookupRelatedItem	Retrieves a list of summary information about items related to the item used as input criteria.
saveItemImage	Inserts a new display image or QR code image for the specified item. The service returns immediately and the information is processed asynchronously.

Standard Usage

This web service is used to find items and retrieve information about items. The only exception is the ability to create new image-based information about an item.

Web Service: StoreItemPrice

The following operations are available within the StoreItemPrice web service.

Operation	Description
lookupItemPriceHeader	Retrieve a summary list of item price information based on input criteria. This only retrieves information known to EICS and has no access to a pricing system.
readItemPrice	Retrieves the full details a single item price record based on its unique reference.
lookupItemPriceOnEffectiveDate	Retrieves the item price of an item for a specific date.

Standard Usage

This web service is used to retrieve information about prices that are known to EICS. Integration with pricing systems updates EICS information about item prices on a continual basis. These web services give a view into EICS information only.

Web Service: StoreNotification

The following operations are available within the StoreNotification web service.

Operation	Description
createNotification	Creates a new notification within the system. These notifications are displayed in the client applications.

Standard Usage

This web service is designed for external system that handle related activities to EICS. With this web service, they can send notifications into EICS of activity that needs to take place based on something that has occurred in another system.

Web Service: StoreShipmentManifest

The following operations are available within the StoreShipmentManifest web service.

Operation	Description
closeManifest	Closes the manifest shipments.

Standard Usage

This web service is designed to close manifest shipments. All manifest shipments matching the input criteria like carrier code, carrier service code will be closed.

Web Service: StoreShipmentReason

The following operations are available within the StoreShipmentReason web service.

Operation	Description
lookupAllShipmentReasons	Retrieves all the shipment reasons configured for store shipments.

Standard Usage

This web service exists to allow customers to retrieve information about shipment reasons that can be assigned to line items on outgoing shipments. The shipment based web services taking the code identifier and thus, you will need to read in these shipment reasons to be able to select and apply valid reason codes.

Web Service: StoreTransfer

The following operations are available within the StoreTransfer web service.

Operation	Description
lookupTransferHeader	Retrieve a summary list of transfers that matches the input criteria.
lookupTransferContext	Retrieves all the transfer context options available to assign to a transfer.

Operation	Description
readTransfer	Retrieves the detailed information about transfer, including its items and quantities, based on a unique reference.
createTransferRequest	Creates a brand new transfer request (Location 1 requesting a transfer from Location 2).
saveTransferRequest	Updates a transfer request allowing user to change items and quantities. This must be done prior to requesting it, which finalizes the transfer request. This requires an activity lock.
createTransfer	Generates a new transfer that you can add details to. The saveTransfer method must be used to update details such as items and quantities of the transfer.
saveTransfer	Updates a previously approved transfer item and quantity details. This operation requires an activity lock.
saveTransferApproval	Updates items and quantities on a transfer in requested status that is currently in the process of being approved, but has not yet been approved. This operation requires an activity lock.
requestTransfer	Updates the status to Requested, finally the transfer request. This allows the opposite location to view the new request for transfer of goods. This operation requires an activity lock.
approveTransfer	Approves a transfer request converted the transfer request into an approved transfer. This operation requires having an activity lock.
rejectTransfer	Rejects a transfer in request status which prevents the transfer request from becoming a transfer. This operations requires having an activity lock.
cancelTransfer	Cancels an approved transfer. This operations requires having an activity lock.
closeTransfer	Closes a processed or partially processed transfer finalizing the state of the transfer. This operations requires having an activity lock.
lookupCustomAttributeAdmins	Retrieves the custom attribute administration information that describes what customized attributes are available on the transfer.

Standard Usage

The process is started by one store creating a transfer request from a shipping store using `createTransferRequest`. The requesting store can continue modifying the transfer request using `saveTransferRequest` until it is ready to notify the shipping store, when it then uses the `requestTransfer` to the shipping store. The shipping store can then begin picking items for the transfer and updating the transfer using the `saveTransferApproval` operation. When all the quantities the shipping store are willing to ship are determined, the shipping store uses `approveTransfer` to finalize the approval of the transfer. Alternatively, they can choose to reject the transfer using `rejectTransfer`. It is possible for a shipping store to create a transfer document without going through the request and approval process by using `createTransfer` and `saveTransfer`.

Web Service: TransferDelivery

The following operations are available within the TransferDelivery web service.

Operation	Description
lookupTransferDeliveryHeaders	Retrieves basic information about one or more transfer deliveries that match the criteria specified. This operation is used to find a delivery arriving at the store.
readTransferDeliveryDetail	Retrieves the entire set of information about a transfer delivery header based on the identifier you pass to it.
updateTransferDelivery	Updates the header information on a transfer delivery. This operation requires an activity lock.
receiveTransferDelivery	Receives all the currently open and active containers on a transfer delivery by defaulting quantities into all the unreceived items. This does not move inventory, only defaults quantities. This operation requires an activity lock.
confirmTransferDelivery	Confirms a transfer delivery actually receiving the goods into inventory and updating all the inventory positions. This moves the transfer delivery to a completed status. This operation requires an activity lock.
lookupTransferDeliveryContainerHeaders	Retrieves summary information about every container on a transfer delivery based on the unique delivery reference.
readTransferDeliveryContainerDetail	Reads the entire details of a container including items and quantities based on a unique container reference.
createTransferDeliveryContainer	Generates a new container on the transfer delivery and returns a reference to use so that items and quantity can be added later.
updateTransferDeliveryContainer	Updates the items and quantities on a transfer delivery container. This operation requires an activity lock.
receiveandConfirmTransferDeliveryContainer	It first defaults receiving quantity on the items within the container and then executes the same locking as the confirmTransferDeliveryContainer. This operation requires an activity lock.
confirmTransferDeliveryContainer	Confirms a transfer delivery container as received and updates all the inventory positions. This operation requires an activity lock.
cancelTransferDeliveryContainer	Cancels a transfer delivery container moving it to missing status. Changes cannot be made to a canceled container.
openTransferDeliveryContainer	Re-opens an already confirmed container moving it back into in-progress status.
lookupTransferDeliveryOrders	Retrieves any customer orders associated with the transfer delivery based on the delivery's unique reference.
lookupMisdirectedTransferDeliveryContainers	Retrieves summary information about containers that may have been misdirected based on a set of search criteria as input into the operation.
lookupCustomAttributeAdmins	Retrieves the custom attribute administration information that describes what customized attributes are available on the transfer delivery.

Standard Usage

After reading a transfer delivery using `lookupTransferDeliveryHeader`, you can read the header detail with `readTransferDelivery` or container list with `lookupTransferDeliveryContainers`. You can then use `updateTransferDelivery` to update header attributes and `updateTransferDeliveryContainer` to update items and quantities in the container. To quickly receive the quantities, `receiveTransferDeliveryContainer` automatically fills in quantities, and when quantities are entered

`confirmTransferDeliveryContainer` finalizes the container (and if appropriate configurations and business rules apply) immediately updates the inventory. If `receiveTransferDelivery` or `confirmTransferDelivery` is used, then all containers will either be received or confirmed respectively.

Web Service: TransferShipment

The following operations are available within the TransferShipment web service.

Operation	Description
<code>lookupTransferShipmentHeader</code>	Retrieves basic information about one or more transfer shipments that match the criteria specified. This operation is used to find a shipment.
<code>readTransferShipmentDetail</code>	Retrieves the entire set of information about a transfer shipment header based on a unique reference.
<code>createTransferShipment</code>	Creates a new and empty transfer shipment and returns a reference to the shipment.
<code>saveTransferShipment</code>	Updates the information on a transfer shipment header.
<code>submitTransferShipment</code>	Submits the transfer shipment for review before final dispatch.
<code>cancelSubmittedTransferShipment</code>	Cancels the submission of the transfer shipment for review.
<code>dispatchTransferShipment</code>	Dispatches a transfer shipment. This moves the shipment to dispatched state and updates the inventory. A transfer shipment cannot be modified after dispatch. Dispatch should occur only after all containers are confirmed.
<code>cancelTransferShipment</code>	Cancels a transfer shipment.
<code>lookupTransferShipmentContainer</code>	Finds all the containers on a specific shipment and retrieves basic identification information about each container.
<code>readTransferShipmentContainer</code>	Reads the specific and complete contents of a container.
<code>createTransferShipmentContainer</code>	Creates a new transfer shipment container on the shipment and returns a reference to it.
<code>saveTransferShipmentContainer</code>	Updates the information about a transfer shipment container including adding and removing items and quantities.
<code>confirmTransferShipmentContainer</code>	Confirms that a transfer shipment container is ready for shipment and marks the container as no longer editable.
<code>cancelTransferShipmentContainer</code>	Cancels a transfer shipment container on the shipment.
<code>openTransferShipmentContainer</code>	Re-opens a confirmed container on a shipment prior to the shipment being dispatched so that changes can be made to the container.
<code>lookupCustomAttributeAdmins</code>	Retrieves the custom attribute administration information that describes what customized attributes are available on the transfer shipment.

Standard Usage

To create a shipment for a transfer document, you lookup the transfer shipment using `lookupTransferShipmentHeader`. If it does not exist, you could create one for the document using `createTransferShipment`. You then create a container on the shipment using `createTransferShipmentContainer`. You can update the container with items and quantities using `saveTransferShipmentContainer`. You then confirm the container using

confirmTransferShipmentContainer. Repeat the process for each container as needed. Once all containers are confirmed, you submit if configured using submitTransferShipment and finally dispatch the shipment using dispatchTransferShipment. Dispatching the shipment finalizes the shipment and relieves the inventory.

Web Service: VendorDelivery

The following operations are available within the VendorDelivery web service.

Operation	Description
lookupVendorDeliveryHeaders	Retrieves basic information about one or more vendor deliveries that match the criteria specified. This operation is used to find a delivery from a supplier.
lookupPurchaseOrderHeaders	Retrieves basic information about one or more purchase orders that match the criteria specified.
readVendorDeliveryDetail	Retrieves the entire set of information about a vendor delivery header based on a unique reference.
createVendorDelivery	Generate a new vendor delivery header and returns a referenced to the delivery.
updateVendorDelivery	Updates the information on a vendor delivery header. This does not include containers, items, or quantities. This operation requires an activity lock.
receiveVendorDelivery	Updates the quantities on a vendor delivery filling in any unreceived items within the containers of the delivery with a default value. It "receives" missing quantities but no inventory positions are updated. This operation requires an activity lock.
confirmVendorDelivery	Confirms the vendor delivery updating inventory positions and completing the delivery. This operation requires an activity lock.
rejectVendorDelivery	Rejects the vendor delivery placing it in rejected status. This operation requires an activity lock.
cancelVendorDelivery	Cancels the vendor delivery placing it in canceled status. This operation requires an activity lock.
lookupVendorDeliveryContainerHeaders	Retrieves summary information about every container on a vendor delivery based on the unique delivery reference.
readVendorDeliveryContainerDetail	Reads the entire details of a container including items and quantities based on a unique container reference.
createVendorDeliveryContainer	Generates a new container on the vendor delivery and returns a reference to use so that items and quantity can be added later.
updateVendorDeliveryContainer	Updates the items and quantities on a vendor delivery container. This operation requires an activity lock.
confirmVendorDeliveryContainer	Confirms a vendor delivery container as received and updates all the inventory positions. This operation requires an activity lock.
cancelVendorDeliveryContainer	Cancels a vendor delivery container moving it to missing status. Changes cannot be made to a canceled container.
openVendorDeliveryContainer	Open Vendor delivery container. This will re-open a container after receipt allowing it to be received again.
lookupVendorDeliveryOrders	Retrieves any customer orders associated with the vendor delivery based on the delivery's unique reference.

Operation	Description
lookupVendorDeliveryAdjustments	Retrieves any external receipt adjustments that exist for the delivery based on the specified unique reference.
cancelSubmitVendorDeliveryContainer	Opens a submitted container for further updates, moving the status to in-progress.
submitVendorDeliveryContainer	Moves the status of the container to submitted and prevents further updates. The container may still be confirmed. No inventory positions are updated via this operation.
lookupCustomAttributeAdmins	Retrieves the custom attribute administration information that describes what customized attributes are available on the vendor delivery.

Standard Usage

After reading a vendor delivery using `lookupVendorDeliveryHeader`, you can read the header detail with `readVendorDelivery` or container list with `lookupVendorDeliveryContainers`. You can then use `updateVendorDelivery` to update header attributes and `updateVendorDeliveryContainer` to update items and quantities in the container. To quickly receive the quantities, `receiveVendorDeliveryContainer` automatically fills in quantities, and when quantities are entered `confirmVendorDeliveryContainer` finalizes the container (and if appropriate configurations and business rules apply) immediately updates the inventory. If `receiveVendorDelivery` or `confirmVendorDelivery` is used, then all containers will either be received or confirmed respectively. You can re-open container using `openVendorDeliveryContainer`. To prevent further updates to the container can use `submitVendorDeliveryContainer`. Submitted container can be re-opened and moved to in-progress status for further updates using `cancelSubmitVendorDeliveryContainer`.

Web Service: VendorReturn

The following operations are available within the VendorReturn web service.

Operation	Description
lookupVendorReturnHeader	Retrieves basic information about one or more vendor return documents that match the criteria specified.
readVendorReturnDetail	Retrieves the entire set of information about a vendor return, including items and quantities, based on a unique reference.
saveVendorReturn	Updates the entire set of information about a vendor return, including items and quantities. This operation requires an activity lock.
approveVendorReturn	This marks an in-progress vendor return as approve for shipment. This operation requires an activity lock.
cancelVendorReturn	Cancels a vendor return indicating no further items and quantities should be shipped for the return.
closeVendorReturn	Closes a vendor return document moving it from in-progress to canceled, rejected, or complete status depending on the state of shipped quantities.
lookupCustomAttributeAdmins	Retrieves the custom attribute administration information that describes what customized attributes are available on the vendor return.

Standard Usage

The user may access `lookupVendorReturnHeader` to find vendor returns to deal with. Once the proper vendor return is found, `readVendorReturnDetail` will retrieve all the details of the vendor return including items and quantities. The `saveVendorReturn` operation is then used to update quantities that are expected to ship. Once the vendor return reaches its final state, the operation `approveVendorReturn` will approve the return and get it ready for shipment.

Web Service: VendorShipment

The following operations are available within the VendorShipment web service.

Operation	Description
<code>lookupVendorShipmentHeaders</code>	Retrieves basic information about one or more vendor shipment headers that match the criteria specified.
<code>lookupReturnContext</code>	Retrieves all the context options that are available to assign to a vendor return shipment.
<code>readVendorShipmentDetail</code>	Retrieves the detailed information about a vendor return header based on a unique reference. It does not include information about containers or items.
<code>saveVendorShipment</code>	Creates a new vendor shipment header if not identifying reference is set, or updates the vendor shipment header information if a unique reference is sent as part of the date. When used as an update, an activity lock is needed.
<code>submitVendorShipment</code>	Submits the vendor shipment for review before final dispatch.
<code>cancelVendorShipmentSubmission</code>	Cancels the submission of the vendor shipment for review.
<code>cancelVendorShipment</code>	Cancels a vendor shipment. This moves the shipment to canceled status. Changes cannot be made to a canceled shipment.
<code>dispatchVendorShipment</code>	Dispatches a vendor shipment. This moves the shipment to dispatched state and updates the inventory. A vendor shipment cannot be modified after dispatch. Dispatch should occur only after all containers are confirmed. This operation requires an activity lock.
<code>closeVendorShipment</code>	Closes a vendor shipment using business logic to determine its final state. It cancels the shipment of remaining quantities. Changes cannot be made after a shipment is closed.
<code>lookupVendorShipmentContainerHeaders</code>	Retrieves summary information about all containers within a vendor shipment based on the unique reference of the shipment.
<code>readVendorShipmentContainerDetail</code>	Reads the specific details, including items and quantities, about a container specified by its unique reference.
<code>saveVendorShipmentContainer</code>	Update the details of a container, including items and quantities. This operation requires an activity lock.
<code>confirmVendorShipmentContainer</code>	Confirms that the container is ready for shipment. A confirmed container cannot be modified. This operation requires an activity lock.
<code>cancelVendorShipmentContainer</code>	Cancels a container on the shipment removing it from the shipment.
<code>openVendorShipmentContainer</code>	Opens a confirmed container placing it back into in-progress status so that items can be added or removed from the container.

Operation	Description
lookupCustomAttributeAdmins	Retrieves the custom attribute administration information that describes what customized attributes are available on the vendor shipment.

Standard Usage

To create a shipment for a vendor return document, you lookup the vendor shipment using `lookupVendorShipmentHeader`. If it does not exist, you could create one using `createVendorShipment`. You then create a container on the shipment using `createVendorShipmentContainer`. You can update the container with items and quantities using `saveVendorShipmentContainer`. You then confirm the container using `confirmVendorShipmentContainer`. Repeat the process for each container as needed. Once all containers are confirmed, you submit if configured using `submitVendorShipment` and finally dispatch the shipment using `dispatchVendorShipment`. Dispatching the shipment finalizes the shipment and relieves the inventory.

Enterprise Documentation

Full web service API documentation can be found at:

https://docs.oracle.com/cd/E82085_01/160/RIB%20Integration%20Guide/Output/ServiceTOC.html

Sales Integration

EICS integrates with POS systems and Sales Audit systems to ensure that the inventory positions are accurate. This is especially important where accurate up-to-date inventory positions are required to reduce customer disappointment when trying to locate items that appear in inventory or delays in filling customer orders.

POS is the primary source of sales, returns, void, and some customer order transaction information to EICS.

ReSA sends only modified or new POS transaction records to EICS.

POS systems integrated with EICS can do the transaction notifications using a web service.

Sales Audit systems can only communicate through a file import process.

Figure 8–12 POS and Sales Audit Integration

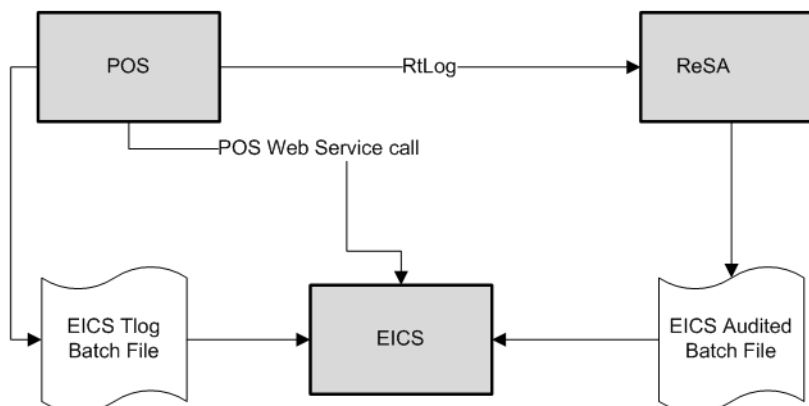

The following features are part of this integration:

- Real-time web service integration
- Batch integration
- Audited sales data integration
- Automatic disposition processing for returns

Batch processing and ReSA processing are discussed elsewhere as are the store and system configurations that might determine how the sale is processed.

POS and Sales Audit Process Flow

The following figure shows how a POS, Retail Sales Audit, and EICS are integrated. A POS generates an RTLog containing all the POS transactions and sends it to the Oracle Retail Sales Audit system (ReSA). ReSA sends the audited modified or new transactions to EICS. ReSA also sends the POS transaction upload file to merchandising to update inventory.

Please note that Oracle Retail Xstore is interfaced with EICS to update the inventory transactions near real time only through web service. It does not use batch.

Non Oracle POS systems can use a batch to import transactions directly into EICS. EICS also processes the POS transactions that have been changed or entered into the sales audit system and updates the inventory based on the delta.

Figure 8-13 POS and Sales Audit Process Flow

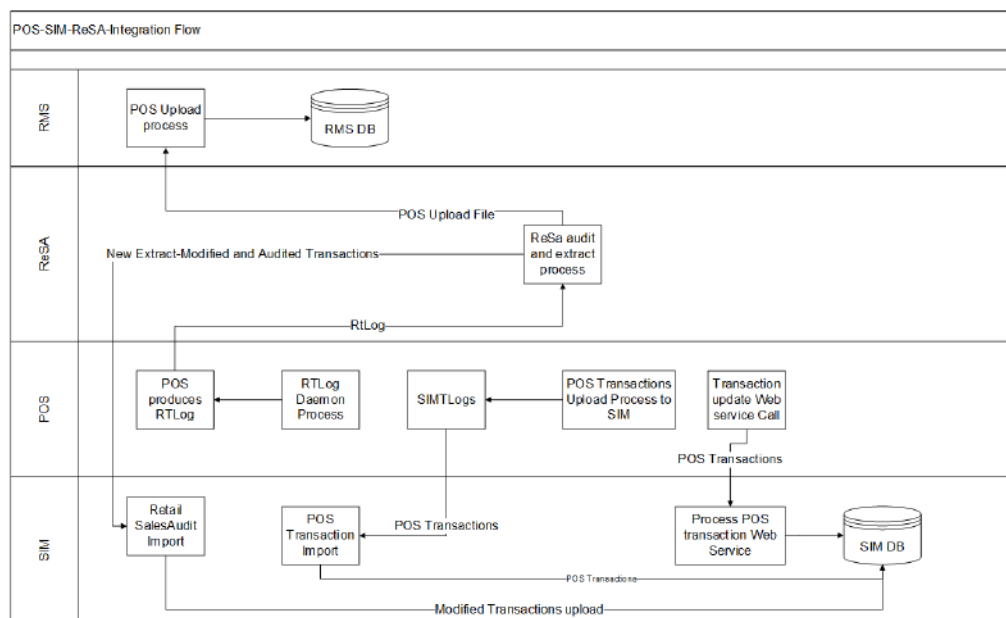

There are two reasons for POS to send sales data directly to EICS and not to the auditing system:

- Real-time inventory updates to support Commerce Anywhere are critical. A possible round trip from POS to ReSA to EICS takes too long in the dynamic inventory environment of today.

- POS is the application that owns sales data and ReSA owns audited data. Architecturally, it makes more sense to have data supplied by the owner of that data. POS sends sales data and ReSA sends audit changes to EICS.

Sales and Return Processing

As part of the sales processing, EICS updates the inventory depending on the nature of the transaction. The following are the supported transaction types for the sales processing: Sale, Return, and Post Void of these transactions. The audit system should not modify the post void transactions. A change to a void is not supported by EICS.

Customer Order Processing

In EICS, the Retail Sales Audit import process, POS Transaction import process, and POS Transaction web service process support the following types of customer orders.

- For layaway and on hold, EICS supports create, update, cancel, and pickup/delivery. For external web order type, only pickup transactions performed in POS are sent to EICS.
- Pickup transactions, both in-store and external, cannot be voided or modified by sales audit and if these transactions are modified by sales audit system, EICS just drops the transaction and does not process.

Note: Current Xstore functionality is limited to only layaway and on hold orders. Web order processing is not supported in this release.

Item Disposition

When the Enable Item Disposition in the Transaction Update store admin parameter is turned on, POS has the opportunity to move inventory for return and post void transactions to 'unavailable' or 'out of stock'. This is especially useful in some environments where items returned have to be disposed of or have to be reprocessed.

The external sale transaction coming into EICS may include a reason code that is mapped to the inventory adjustment reason codes in EICS. Point of Service maps the EICS reason codes, and the reason codes are sent to EICS in the web service or file extract for the return and post void transactions. EICS first processes the return or post void and updates stock on hand. Next, if the indicator is set and a reason code exists, EICS checks this reason code with the one in inventory adjustment reason code table. If a valid match is found, EICS generates an inventory adjustment to notify external systems and execute the disposition instructions tied to the inventory adjustment reason code. Based on the disposition mapped to the reason code, EICS moves the returned inventory to not for sale or out of stock and updates the history trail. If sub-buckets are used, they are also updated if the movement is to not for sale.

If the reason code received is invalid/not present/mapped incorrectly, the system writes an error log and continues to process the stock on hand part of the transaction.

Drop Ship

When the sales records indicate the record is a drop ship, EICS does not perform any processing of this record since the drop ship process implies the inventory is shipped from a third-party location and not from the store.

Item Types

EICS only processes SKU or UPC numbers. GS1 databars, or any other smart barcodes such as VPLUs or Type-E barcodes, should have been extracted to their SKU or UPC number by the POS system.

In addition, EICS only updates inventory for stock holding items. Non-inventory items do not update any stock on hand and are not processed.

Items with the store pack inventory indicator turned off are automatically broken down and the inventory of the component items is updated.

RFID

If the point-of-sale record for an item includes an RFID tag, the tag will be moved to a SOLD status indicating it should be out-of-store.

Integration with Manifesting Systems

In order for access to an external manifesting system to take place, the customer must first setup Carrier Type as "Third Party" and the Carrier Service (Manifest Type) must be Parcel (P). Configuration controls whether manifesting is done for a transfer to store, finisher, or warehouse. In addition, configuration controls manifesting for a return to vendor shipment or a customer order delivery.

Carrier services with manifest type of "O" (Other) and "H" (Home Fleet) do not go through the manifesting system. When Manifest Type is "O," EICS prompts the user to enter the carrier address where the shipment is to be sent for fulfillment. Manifest Type of "H" is within the company and therefore, does not prompt the user for an address.

Some carriers require weight, dimension, or both values to be sent in the manifest payload. If so, the carrier's service should have either the weight indicator or carton dimension indicate set to active (or both) during their carrier service setup.

EICS supplies an outbound and inbound Shipment Manifest SOAP web service. The following are supported service operations:

A web service is used to send all the shipment information to the external manifesting system and also to receive close shipment requests from external systems.

A web service accepts requests from external systems to close shipments. It is used to find those "Submitted" shipments for the provided tracking ID, carrier, service and date, and dispatch those shipments.

Note: EICS supplies a WSDL and XSD that defines the web service, operation, and data content. This web service will need to be implemented either for the manifesting system or a plug-in set up.

ShipmentManifestService

This web service notifies an external manifesting system that a manifest needs to be created.

Service Operation	Description
createManifest	Requests the external manifesting system to create a new parcel manifest for an input transaction.

StoreShipmentManifestService

This web service receives a message from an external manifesting system that the items on the manifest have been picked up.

Service Operation	Description
closeManifest	Instructs EICS that submitted shipments have been picked up by the carrier.

Customer Address

When shipping to customer during the fulfillment order workflow, EICS retrieves the address for the order delivery from an external order managements system. When viewing delivery address information within the client application, it also retrieves it from an external system. The web service is defined to connect to an OrderManagementService.

CustomerOrderAddressService

Service Operation	Description
queryCustomerOrderAddress	Retrieves detailed address information for the order and customer information passed to it.

Integration for Ticket Printing

Ticket Print

When printing tickets, EICS sends ticket information to an external system for printing. This web service needs to be implemented for printing tickets to a physical printer.

TicketPrintService

Service Operation	Description
printTickets	Sends item tickets to an external system to be printed. It must be implemented by the external system in order to receive the tickets.

Retail Home Integration

EICS now supports following integration scenarios with Retail Home:

- Launch EICS web client from Retail Home
- Display a tile report for items that are out of stock on shop floor
- Display a tile report for stock counts that are pending authorization
- Launch detailed operational views in EICS from related tile reports in Retail Home

Launch EICS from Retail Home

Launching EICS client requires an entry to be made under the application navigator section of Retail Home. It enables the user to launch EICS web client in a new browser tab from within Retail Home. Please refer to *Oracle Retail Home Administration Guide* for information on how to work with application navigator in Retail Home.

The EICS application configuration should look like this:

Figure 8–14 Add Application Info

The screenshot shows a dialog box titled "Add Application Info" with a close button (x) in the top right corner. The form contains the following fields and options:

- * Application Name: EICS
- * Color Set: Cyan (dropdown menu)
- Application Code: (dropdown menu)
- Application Link: https://bur00afs-ext-vip1.us.oracle.com
- Platform Service URL: (text input field)
- Supported Features:
 - Application Navigator
 - Notifications
 - Favorites
 - Resource Bundle Customization
- ORAAC Link: (text input field)

At the bottom of the dialog, there are three buttons: "OK and Create Another", "Cancel", and "OK".

- **Application Name:** The name of the application that is, EICS.
- **Color Set:** Any color that you want to allocate to EICS.
- **Application Link:** The URL of EICS web client.
- **Supported Features:** EICS does not integrate with PSRAF so only Application Navigator can be ticked.

The user needs to be part of RETAIL_HOME_ADMIN security group in order to access Application Navigator in Retail Home.

Tile Reports

EICS supports following two types of two metric reports:

- Shop Floor Out of Stock Items
- Stock Counts - Ready to Authorize

Adding these tile reports on Retail Home requires some configurations to be made.

The default two metric report available in Retail Home adds an 'Accept-Version' header which probably won't match with the version of EICS, in such a case, EICS will return a 'Service version mismatch' error. In order to bypass this limitation, the user needs to create a custom tile report to be used with EICS from RPAS two metric summary report template. Please refer to the *Oracle Retail Home Administration Guide* for information on how to create custom tile reports.

The user is then required to create tiles and add them to the dashboard. Please refer to the *Oracle Retail Home Administration Guide* for information on dashboard and tile configuration. While creating tiles, the URL to related operational view can be used to allow direct navigation to the operational view.

Please use the following screenshots for reference while configuring tiles and tile states.

Create Tile

Figure 8–15 Create Dashboard Tile

- **Tile Name:** Name of the tile used as a header for the tile.
- **Application:** The application that the tile belongs to. In this case EICS.
- **URL:** The URL of the related operational view in EICS.
- **Override URL:** Select this to make Retail Home use the configured URL.
- **Tile Color:** Any color that you want to allocate to this tile.

Add Tile State

Figure 8–16 Add Tile State

- **Displayed:** It should be checked in order for the tile state to be displayed.

- **Tile State Report:** The custom tile report that was created for EICS.
- **Expanded Report:** EICS does not use expanded report.

Add Data Source

Figure 8–17 Add Data Source

- **Data For:** It should be for tile state.
- **Active:** It should be checked to use this data source with the tile state.
- **Name:** It should be Retail Home Report Data Service.
- **Type:** It should be REST.
- **Source:** The URL to the related tile state report endpoint in EICS.

After all the configuration, you should be able to see EICS tiles on the dashboard. They should look similar to the ones below:

Figure 8–18 Example EICS Tiles

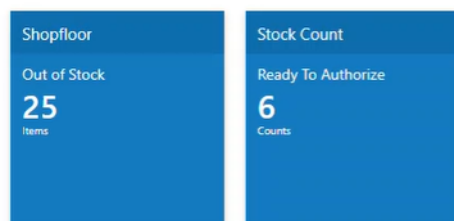

EICS Endpoints

EICS exposes following two endpoints:

Shop Floor Out of Stock Items

This endpoint can be used as a data source for **Shop floor Out of Stock** tile state.

The response contains information on number of items that are out of stock across all the stores that are accessible to the user.

If the percentage of out of stock items to total items is greater than the **Shopfloor Out of Stock Items Critical Percentage** system configuration, EICS marks the response as important which displays a '!' mark next to the number on the tile report.

Table 8–5 Shop Floor Out of Stock

Endpoint	Operational View
https://<EICS-HOST>:<EICS-PORT>/sim-mobile/internal/rhreports/outofstock/shopfloor/tile	Shopfloor Out of Stock

Stock Counts - Ready to Authorize

This endpoint can be used as a data source for **Stock Count - Ready to Authorize** tile state.

The response contains information on number of stock counts that are pending authorization across all stores that are accessible to the user.

Table 8–6 Stock Counts - Ready to Authorize

Endpoint	Operational View
https://<EICS-HOST>:<EICS-PORT>/sim-mobile/internal/rhreports/readytoauthorize/tile	Stock Count - Ready To Authorize

The response payloads of both these endpoints confirm to the two metric payload specification of Retail Home.

User should be a part of `sim_retail_home_users` group to access these endpoints.

EICS does not support CORS (Cross Origin Resource Sharing) at the moment so it requires Retail Home to be deployed behind the same external load balancer and port.

For convenience, EICS also provides a `RETAIL HOME` security role that captures security permissions required to access these operational views. The user still needs appropriate functional area permissions to navigate to transaction detail screens.

EICS Operational Views

EICS has added following operational views that can be hooked with related tiles:

- **Shopfloor Out of Stock Items**

This view gives a store and item level breakdown of the information that is displayed on the tile. The user can look at item level records for each store and navigate to the item detail screen for any store/item combination provided he or she has the required permissions.

This view is available under Operations - Operational Views - Shopfloor Out of Stock menu.

- **Stock Count - Ready to Authorize**

This view gives a store and stock count level breakdown of the information that is displayed on the tile. The user can look at stock count level records for each store and navigate to the stock count detail for any store/count combination provided he or she has the required permissions.

This view is available under Operations - Operational Views - Stock Count - Ready to Authorize menu.

Launch EICS Operational Views from Tile Report

Launching EICS operational views from related tile report requires the tile report to be configured with the URL of the related operational view. Once that is done, clicking on tile report header should open the related EICS operational view in a new browser tab.

Configuration

This chapter describes how you can configure functionality usage.

Configuration can be achieved by adjusting

1. [System Admin Parameters](#)
2. [Store Admin Parameters](#)
3. Feature [Access Permissions](#)

System Admin Parameters

Table 9–1 System Admin Parameters

Options	Description	Default Value	Topic	Type
Allow Non-Range Item	Values: Yes/No This parameter is to determine to give stores the ability to add non ranged items to functional areas in the application.	Yes	ADMIN	Boolean
Auto Default UIN Attributes	Auto default UIN attributes is used during ItemLocCre to default UIN attributes for an item taking values from the store defaults (STORE_UIN_ADMIN_DEPT table). It is also checked whenever we range an item to a store.	No	ADMIN	Boolean
Barcode Scan/Entry Log - Receiving	Values: Yes/No Yes: Captures, on the mobile, all container and item scans or manual entries by user, location, and time at the point of receiving deliveries. Containers are captured in the quick receiving dialog when item level is captured in the Item Receiving function of the Container Summary for DSD and Transfer Receiving. No: Does not capture any container or item information in the mobile receiving dialogs.	Yes	ADMIN	Boolean
Default UOM	Values: Standard UOM / Cases Standard UOM the system will default to the standard UOM until the UOM is changed. Cases the system will default to cases until the UOM is changed.	2	ADMIN	Integer
Disable Pack Size	Values: Yes/No Yes: Pack size is disabled and cannot be changed. No: Pack size is editable and can be updated.	No	ADMIN	Boolean

Table 9–1 (Cont.) System Admin Parameters

Options	Description	Default Value	Topic	Type
Enable Extended Attributes	<p>Values: Yes/No</p> <p>This is a master switch that will turn on and off the feature for collecting extended attributes.</p> <p>If set to 'Yes', the system will capture the extended attributes when scanning a GS1 DataBar</p> <p>If set to 'No', the Ext Attributes are not captured when scanning a GS1 Databar and the button/menu option will not be available on either the EICS or SOCS regardless of the store parameter.</p>	No	ADMIN	Boolean
Enable Sub-buckets	<p>Values: Yes/No</p> <p>Yes: Sub-buckets will be used throughout the application.</p> <p>No: Sub-buckets will not be used in the application.</p>	Yes	ADMIN	Boolean
Maintain RFID History	<p>Values: Yes/No</p> <p>Yes: will create history records in the history table for the every transaction occurred for the RFID Tag.</p> <p>No: will not create the history records however the integration with the RFID solution and RFID tag tracking could still be on.</p>	Yes	ADMIN	Boolean
Shopfloor Out of Stock Items Critical Percentage	<p>Values: 0.01 - 100%</p> <p>If the percentage of out of stock items on shop floor to total items is greater than this percentage, then there will be an '!' alert with the number of items out of stock on the tile report.</p>	0.01%	ADMIN	Integer
System Code	Code identifying the application for integration with an external system. This often is a company ID. This is only used for outbound integration.	INV	ADMIN	String
Audit Direct Store Delivery	Audit Records are log of activities and usage information in the system. This parameter is to determine whether activity records for actions (confirm/submit/update and so on) performed on vendor delivery and vendor delivery carton will be created.	Yes	AUDIT	Boolean
Audit Publish Message	Audit Records are log of activities and usage information in the system. This parameter is to determine whether activity records for outbound messages will be created.	Yes	AUDIT	Boolean
Audit Receive Message	Audit Records are log of activities and usage information in the system. This parameter is to determine whether activity records for inbound messages will be created.	Yes	AUDIT	Boolean
Audit RTV Update	<p>Values: Yes/No</p> <p>Yes: Enables activity logging for rtv request and rtv shipments.</p> <p>No: Disables activity logging for rtv request and rtv shipments.</p>	Yes	AUDIT	Boolean

Table 9–1 (Cont.) System Admin Parameters

Options	Description	Default Value	Topic	Type
Audit Security	Values: Yes/No Yes: Enables activity logging for security events. It includes login success/failure, security management changes (roles, user assignments, and so on). No: Disables activity logging for security events.	Yes	AUDIT	Boolean
Audit Stock Count Completed	Audit Records are log of activities and usage information in the system. This parameter is to determine whether activity records will be created for count or recount complete for stock count child.	Yes	AUDIT	Boolean
Audit Transfer Dispatch	Values: Yes/No Yes: Enables activity logging for transfer shipments. No: Disables activity logging for transfer shipments.	Yes	AUDIT	Boolean
Audit Transfer Receiving	Values: Yes/No Yes: Enables activity logging for transfer receiving. No: Disables activity logging for transfer receiving.	Yes	AUDIT	Boolean
Audit Transfer Update	Values: Yes/No Yes: Enables activity logging for transfer requests. No: Disables activity logging for transfer requests.	Yes	AUDIT	Boolean
Batch Maximum Threads	Gives the maximum number of batch partitions for a batch to run.	5	BATCH	Integer
Maximum Job Instances Per Scheduler Execution	Gives the maximum number of jobs allowed per run of the scheduler.	100	BATCH	Integer
Maximum Processing Hours For Scheduled Job	Determines the maximum processing time for a batch job. After this time, the batch schedule record is updated to failed status.	5	BATCH	Integer
Search Limit Default for Batch Job Days	Gives the default number of days in past for batch job records to be displayed on Batch Job Admin screen on EICS.	7	BATCH	Integer
Batch Scheduler Execution Interval	Gives the batch scheduler execution delay interval duration to throttle batch execution calls.	300	BATCH	Integer
Days to Hold Archived and Rejected Files	Gives the days to hold rejected and archived batch files before deleting them from the batch directory.	30	BATCH	Integer
Procedure Log Purging Info Enabled	Determines whether the procedure log purging info is enabled.	Yes	BATCH	Boolean
Batch max files per job run	Batch max files per job run.	20	BATCH	Integer

Table 9–1 (Cont.) System Admin Parameters

Options	Description	Default Value	Topic	Type
Customer Order Fulfillment Restriction	<p>Values: Restricted/Transaction Controlled</p> <p>Transaction Controlled: The Allow Partial Delivery indicator that comes in on the customer order will be used as it was sent.</p> <p>Restricted: The Allow Partial Delivery Indicator will be updated to 'No' on the Customer Order or Transfer Request upon coming into the system.</p> <p>– Customer Order Deliveries and Transfer Request/Shipment will validate the Allow Partial Delivery indicator as usual, however, it will be set to 'No' and force the user to have a full delivery (with the exception of a user override in customer order deliveries).</p> <p>– Customer Order Picking: When creating a pick, the user will not be able to create the pick if there is not enough available to pick. When confirming a pick, everything must be picked on the customer order.</p> <p>-Reverse Picking: when creating a reverse pick, the user must reverse pick everything that was picked.</p>	Transaction Controlled	CUSTOMER ORDER	Integer
Customer Order Receipt Notification	<p>Values: Yes/No</p> <p>Yes: A receipt notification will be generated when a customer order related transfer receipt or Direct Store Delivery (DSD) has been confirmed.</p> <p>No: The notification will not be generated.</p>	No	CUSTOMER ORDER	Boolean
Customer Order Tracking ID Required	<p>Yes: If the store parameter Manifest Customer Order Deliveries is set to No, the Tracking ID must be captured before dispatching the Customer Order Delivery. If 'Manifest Customer Order Deliveries' is set to Yes, then it is not required.</p> <p>No: Capturing Tracking ID becomes optional while dispatching the Customer Order Delivery.</p>	No	CUSTOMER ORDER	Boolean
Display Item Image for Customer Order Delivery	<p>Values: Yes/No</p> <p>Yes: This parameter indicates that item image will be displayed in Customer Order Deliveries.</p> <p>No: Images will not be displayed in Customer Order Deliveries</p>	No	CUSTOMER ORDER	Boolean
Display Item Image for Customer Order Picking	<p>Values: Yes/No</p> <p>Yes: This parameter indicates that item image will be displayed in Customer Order Picking.</p> <p>No: Images will not be displayed in Customer Order Picking.</p>	No	CUSTOMER ORDER	Boolean
Display Item Image for Customer Order Reverse Picking	<p>Values: Yes/No</p> <p>Yes: This parameter indicates that item image will be displayed in Customer Order Reverse Picking.</p> <p>No: Images will not be displayed in Customer Order Reverse Picking.</p>	No	CUSTOMER ORDER	Boolean

Table 9-1 (Cont.) System Admin Parameters

Options	Description	Default Value	Topic	Type
Display Item Image for Customer Orders	Values: Yes/No Yes: Indicates item image will be displayed in Customer Orders. No: Image will not be displayed in Customer Orders.	No	CUSTOMER ORDER	Boolean
Minutes To Hold New Customer Order Before Sending Notification	Values: 0-999 This system parameter indicates the time interval in minutes to send a follow-up message to a store associated after a customer order (web order) has arrived, but no user has accessed the customer order.	5	CUSTOMER ORDER	Integer
Minutes To Hold Open Customer Order Pick Before Sending Notification	Values: 0-999 This system parameter dictates the time interval in minutes to send a follow-up message to a store associate after a pick list has been created but no one has started the pick list.	15	CUSTOMER ORDER	Integer
New Customer Order Notification	Values: Yes/No Yes: This parameter generates a notification for a new cross channel (web order) customer order. No: No notification is generated.	No	CUSTOMER ORDER	Boolean
New Customer Order Reverse Pick Notification	Values: Yes/No Yes: A notification alert is generated when a new system generated reverse pick comes into the system. No: A notification is not generated upon getting a new system generated reverse pick.	No	CUSTOMER ORDER	Boolean
Always Send DSD Receipt Cost	Values: Yes/No Yes: When the receipt is published, the unit cost will be sent if there is not an override cost. No: When there receipt is published, only the override cost will be sent if it exists.	No	DSD_RECEIVING	Boolean
Display UnitCost for Direct Deliveries	Values: Yes/No Yes: Display Unit Cost and allow editing when receiving. If On, the system displays the original cost and allows entering the new cost for the on-the-fly and Dex/Nex deliveries. For the delivery with PO and ASN, it displays the unit cost. Display the Unit Cost on the Direct Delivery Report when printing. No: Do not display this data to the user in the DSD Receiving Containers screen. Do not display the unit cost on the Direct Delivery Report. If No, the system does not display the unit cost and does not allow editing or entering new cost.	Yes	DSD_RECEIVING	Boolean
Displays Item Image for DSD Receiving	Values: Yes/No Yes: This parameter indicates whether the item image will be displayed in Container Items and Item detail screens. No: Image will not be displayed in that functional area.	No	DSD_RECEIVING	Boolean

Table 9–1 (Cont.) System Admin Parameters

Options	Description	Default Value	Topic	Type
Displays Item Image for Purchase Order	<p>Values: Yes/No</p> <p>Yes: This parameter indicates if the item image will be displayed in Purchase Order Items screen.</p> <p>No: Image will not be displayed in that functional area.</p>	No	DSD_ RECEIVING	Boolean
DSD Receiving Preferred Currency	<p>Values: Store Currency/Supplier Currency</p> <p>This parameter will default the store or supplier currency to newly created POs depending on preference.</p>	Store Currency	DSD_ RECEIVING	Integer
Ignore the Supplier DSD indicator to create a PO on the fly	<p>Values: Yes/No</p> <p>Allows the system to ignore the supplier level indicator when creating a PO in the system.</p> <p>Yes: The system ignores the supplier level flag and will always allow stores to create purchase orders for any supplier based on the receipt.</p> <p>No: The system will verify creating a purchase order on the fly is allowed based on the supplier level flag.</p>	Yes	DSD_ RECEIVING	Boolean
Number of days received direct deliveries can be adjusted	<p>Values: 0-999</p> <p>0: no adjustment</p> <p>1: allowed to adjust until the end of today</p> <p>2: allowed to adjust until the end of tomorrow</p> <p>X: allowed to adjust until X number of days starting with today as day 1</p> <p>This parameter specifies the number of days received direct deliveries can be reopened and adjusted. If a direct delivery falls within the number of days, the system allows to adjust the received delivery. The user will be allowed to edit values and confirm the delivery.</p>	0	DSD_ RECEIVING	Integer
Over Received Quantity Notification	<p>Values: Yes/No</p> <p>This parameter will generate a notification when more than the expected quantity has been received and the store parameter Direct Delivery Auto Remove Over Received Quantity is set to yes.</p>	Yes	DSD_ RECEIVING	Boolean

Table 9-1 (Cont.) System Admin Parameters

Options	Description	Default Value	Topic	Type
Days Beyond PO Not After Date	<p>This parameter is used to determine the Purchase Orders returned in the deliveries on Item Detail as well as calculating the On Order Qty.</p> <p>1. Planned Deliveries</p> <p>Ordered Qty needs to be taking the Not After Date into account.</p> <p>Purchase Order – only include those PO's where Not After Date >= Today + Days Beyond PO Not After Date</p> <p>Transfer – only include those transfers where Not After Date >= Today</p> <p>2. Deliveries – Only display deliveries where:</p> <p>Purchase Order – only include those PO's where Not After Date >= Today + Days Beyond PO Not After Date</p> <p>Transfer – only include those transfers where Not After Date >= Today</p>	50	DSD_RECEIVING	Integer
Display Item Image for Inventory Adjustments - Execution	<p>Values: Yes/No</p> <p>Yes: The item image is displayed within Inventory Adjustments in SOCS.</p> <p>No: The item image is not displayed in Inventory Adjustments.</p>	No	INVENTORY_ADJUSTMENT	Boolean
Display Item Image for Inventory Adjustments - Operations	<p>Values: Yes/No</p> <p>Yes: The item image is displayed within Inventory Adjustments in EICS.</p> <p>No: The item image is not displayed in Inventory Adjustments.</p>	No	INVENTORY_ADJUSTMENT	Boolean
Display Item Image for Item Baskets - Execution	<p>Values: Yes/No</p> <p>Yes: The item image is displayed within Item Basket on the mobile.</p> <p>No: The item image is not displayed in Item Basket on the mobile.</p>	No	ITEM_BASKET	Boolean
Display Item Image for Item Baskets - Operations	<p>Values: Yes/No</p> <p>Yes: The item image is displayed within Item Basket on the desktop.</p> <p>No: The item image is not displayed in Item Basket on the desktop.</p>	No	ITEM_BASKET	Boolean
Display Item Image for Item Lookup - Execution	<p>Values: Yes/No</p> <p>Yes: The item image is displayed within Item Lookup on SOCS.</p> <p>No: The item image is not displayed in Item Lookup.</p>	No	ITEM_LOOKUP	Boolean
Display Item Image for Item Lookup - Operations	<p>Values: Yes/No</p> <p>Yes: This parameter indicates if the item image will be displayed in Item Lookup in EICS. It is in the list and the details.</p> <p>No: Image will not be displayed in Item Lookup.</p>	No	ITEM_LOOKUP	Boolean

Table 9–1 (Cont.) System Admin Parameters

Options	Description	Default Value	Topic	Type
Display Item Image for Item Price Quick Print-Execution	This indicates whether the item image has to be displayed during the quick item price print in mobile.	No	ITEM PRICE	Integer
Background Thread Count	Gives the thread count for background tasks in SOCS.	1	MOBILE	Integer
Barcode Attribute Refresh Rate Milliseconds	Determines the cache refresh rate for barcode attribute labels in milliseconds.	3600000	MOBILE	Integer
Configuration Refresh Rate Milliseconds	Determines the cache refresh rate for system configurations, store configurations, batch scheduler and MPS work type in milliseconds.	3600000	MOBILE	Integer
Date Output Chinese China	This is to determine the date format based on the locale.	yy-MM-dd	MOBILE	String
Date Output Chinese Hong Kong	This is to determine the date format based on the locale.	yy-MM-dd	MOBILE	String
Date Output Chinese Taiwan	This is to determine the date format based on the locale.	yy-MM-dd	MOBILE	String
Date Output English Australia	This is to determine the date format based on the locale.	dd-MM-yy	MOBILE	String
Date Output English Canada	This is to determine the date format based on the locale.	dd-MM-yy	MOBILE	String
Date Output English India	This is to determine the date format based on the locale.	dd-MM-yy	MOBILE	String
Date Output English Ireland	This is to determine the date format based on the locale.	dd-MM-yy	MOBILE	String
Date Output English South Africa	This is to determine the date format based on the locale.	yy-MM-dd	MOBILE	String
Date Output English United Kingdom	This is to determine the date format based on the locale.	dd-MM-yy	MOBILE	String
Date Output English United States	This is to determine the date format based on the locale.	MM-dd-yy	MOBILE	String
Date Output French Belgium	This is to determine the date format based on the locale.	dd-MM-yy	MOBILE	String
Date Output French Canada	This is to determine the date format based on the locale.	yy-MM-dd	MOBILE	String
Date Output French France	This is to determine the date format based on the locale.	dd-MM-yy	MOBILE	String
Date Output French Luxembourg	This is to determine the date format based on the locale.	dd-MM-yy	MOBILE	String
Date Output French Switzerland	This is to determine the date format based on the locale.	dd-MM-yy	MOBILE	String

Table 9–1 (Cont.) System Admin Parameters

Options	Description	Default Value	Topic	Type
Date Output German Austria	This is to determine the date format based on the locale.	dd-MM-yy	MOBILE	String
Date Output German Germany	This is to determine the date format based on the locale.	dd-MM-yy	MOBILE	String
Date Output German Luxembourg	This is to determine the date format based on the locale.	dd-MM-yy	MOBILE	String
Date Output German Switzerland	This is to determine the date format based on the locale.	dd-MM-yy	MOBILE	String
Date Output Italian Italy	This is to determine the date format based on the locale.	dd-MM-yy	MOBILE	String
Date Output Japanese Japan	This is to determine the date format based on the locale.	yy-MM-dd	MOBILE	String
Date Output Korean South Korea	This is to determine the date format based on the locale.	dd-MM-yy	MOBILE	String
Date Output New Zealand	This is to determine the date format based on the locale.	dd-MM-yy	MOBILE	String
Date Output Portuguese Brazil	This is to determine the date format based on the locale.	dd-MM-yy	MOBILE	String
Date Output Portuguese Portugal	This is to determine the date format based on the locale.	dd-MM-yy	MOBILE	String
Date Output Russian Russia	This is to determine the date format based on the locale.	dd-MM-yy	MOBILE	String
Date Output Spanish Argentina	This is to determine the date format based on the locale.	dd-MM-yy	MOBILE	String
Date Output Spanish Bolivia	This is to determine the date format based on the locale.	dd-MM-yy	MOBILE	String
Date Output Spanish Chile	This is to determine the date format based on the locale.	dd-MM-yy	MOBILE	String
Date Output Spanish Columbia	This is to determine the date format based on the locale.	dd-MM-yy	MOBILE	String
Date Output Spanish Costa Rica	This is to determine the date format based on the locale.	dd-MM-yy	MOBILE	String
Date Output Spanish Dominican Republic	This is to determine the date format based on the locale.	MM-dd-yy	MOBILE	String
Date Output Spanish Ecuador	This is to determine the date format based on the locale.	dd-MM-yy	MOBILE	String
Date Output Spanish El Salvador	This is to determine the date format based on the locale.	MM-dd-yy	MOBILE	String

Table 9–1 (Cont.) System Admin Parameters

Options	Description	Default Value	Topic	Type
Date Output Spanish Guatemala	This is to determine the date format based on the locale.	dd-MM-yy	MOBILE	String
Date Output Spanish Honduras	This is to determine the date format based on the locale.	MM-dd-yy	MOBILE	String
Date Output Spanish Mexico	This is to determine the date format based on the locale.	dd-MM-yy	MOBILE	String
Date Output Spanish Nicaragua	This is to determine the date format based on the locale.	MM-dd-yy	MOBILE	String
Date Output Spanish Panama	This is to determine the date format based on the locale.	MM-dd-yy	MOBILE	String
Date Output Spanish Paraguay	This is to determine the date format based on the locale.	dd-MM-yy	MOBILE	String
Date Output Spanish Peru	This is to determine the date format based on the locale.	dd-MM-yy	MOBILE	String
Date Output Spanish Puerto Rico	This is to determine the date format based on the locale.	MM-dd-yy	MOBILE	String
Date Output Spanish Spain	This is to determine the date format based on the locale.	dd-MM-yy	MOBILE	String
Date Output Spanish Uruguay	This is to determine the date format based on the locale.	dd-MM-yy	MOBILE	String
Date Output Spanish Venezuela	This is to determine the date format based on the locale.	dd-MM-yy	MOBILE	String
Enable Device Camera Barcode Scan	Used for enabling device camera for scanning on SOCS.	No	MOBILE	Boolean
Inventory Adjustment Reason Refresh Rate Milliseconds	Determines the cache refresh rate for inventory adjustment reason in milliseconds on SOCS.	3600000	MOBILE	Integer
Item Image Refresh Rate Milliseconds	Determines the cache refresh rate for item image in milliseconds on SOCS.	3600000	MOBILE	Integer
Manual Quantity Entry Default Mode	Values: Scan Mode/Override Scan Mode - the numeric entry popup on MAF will have its mode defaulted per the scan mode (as it has always done) Override - the numeric entry popup on MAF will have its mode always defaulted to override, and it will not look at the scan mode.	Scan Mode	MOBILE	Integer
Non-Sellable Quantity Type Refresh Rate Milliseconds	Determines the cache refresh rate for non-sellable quantity types in milliseconds on SOCS.	3600000	MOBILE	Integer

Table 9-1 (Cont.) System Admin Parameters

Options	Description	Default Value	Topic	Type
Notification Count Refresh Rate Milliseconds	Determines the cache refresh rate for notifications in milliseconds on SOCS.	300000	MOBILE	Integer
RFID Zone Refresh Rate Milliseconds	Determines the cache refresh rate for RFID zones in milliseconds in the system.	3600000	MOBILE	Integer
Scan Focus Item Detail	<p>Determines if sticky focus is enabled on SOCS screens.</p> <p>Yes: Focus will automatically be in the Scan field when on a screen with the scan bar. The system will retain focus in the scan bar field until an error arises or until the user/system moves focus to somewhere else.</p> <p>The keyboard will display on the mobile device while scanning/entering into the scan bar field. This is because the system believes you are typing into the field.</p> <p>No: Focus will not stay in the scan bar.</p>	No	MOBILE	Boolean
Sound Error Enabled	Determines if severe error sound will be played in case of severe errors on SOCS.	Yes	MOBILE	Boolean
Sound Information Enabled	Determines if information sound effect will be played on SOCS.	Yes	MOBILE	Boolean
Sound Scan Enabled	Determines if beep sound will be played on scan on SOCS.	Yes	MOBILE	Boolean
Sound Warning Enabled	Determines if a business error sound will be played on business errors on SOCS.	Yes	MOBILE	Boolean
Store Printer Refresh Rate Milliseconds	Determines the cache refresh rate for store printer in milliseconds on SOCS.	3600000	MOBILE	Integer
Store Refresh Rate Milliseconds	Determines the cache refresh rate for notifications in milliseconds on EICS and SOCS.	3600000	MOBILE	Integer
Tablet Mode Screen Size	Determines the screen size for tablet mode for SOCS.	16,5	MOBILE	.Double
UOM Conversion Refresh Rate Milliseconds	Determines the cache refresh rate for UOM conversion in milliseconds	3600000	MOBILE	Integer
Vibration Enabled	Determines if vibration is enabled on errors on SOCS.	No	MOBILE	Boolean
MPS Enabled	Determines if MPS is enabled which in turn determines if MPS work types can be enabled.	Yes	MPS	Boolean
MPS Increment Threads	Determines the allowed thread increment factor for MPS work types.	2	MPS	Integer
MPS Maximum Queue Age Seconds	Determines the maximum seconds before MPS work queue needs to be refreshed.	180	MPS	Integer
MPS Maximum Queue Size	Determines the maximum size limit for generating MPS work queues.	1000	MPS	Integer
MPS Maximum Threads	Determines the maximum thread count for MPS work types.	8	MPS	Integer

Table 9–1 (Cont.) System Admin Parameters

Options	Description	Default Value	Topic	Type
MPS Refresh Rate Seconds	Determines the MPS work queue refresh rate after checking for the system parameter MPS Maximum Queue Age Seconds. If the MPS Maximum Queue Age Seconds has not exceeded, then this parameter is checked to determine if MPS work queue needs to be refreshed.	15	MPS	Integer
Seconds to Check for Notifications	Defines how many seconds the system will check for new notifications. This applies to any notification inserted into the system.	300	NOTIFICATION	Integer
Days to Hold Areas	Values: 1-999 Days to after which Area records will be purged.	60	PURGE	Integer
Days to Hold Audit Records	Audit Records are log of activities and usage information in the system. This parameter is to determine the number of days to hold the audit records. The batch will delete all records where the create date is less than or equal to current date minus the days to hold.	45	PURGE	Integer
Days To Hold Batch Logs	Delete all logs where the log date is less than or equal to the current date minus the days to hold for any records.	30	PURGE	Integer
Days to Hold Completed Inventory Adjustments	Delete records in 'Complete' Status where the inventory complete date is less than or equal to the current date minus the days to hold.	30	PURGE	Integer
Days to Hold Completed Purchase Orders	Purge all records in 'Closed' status after 'x' number of days defined by user, where the complete date (the date of when all items were received on the order) is less than or equal to the current date minus the days to hold.	30	PURGE	Integer
Days to Hold Completed Staging Records	Delete all records that have been processed successfully or deleted where the update date is less than or equal to the current date minus the days to hold for any records.	3	PURGE	Integer
Days to Hold Completed Stock Counts	Purges any records 'x' days after the last stock count event has occurred. In other words, when the schedule date is less than or equal to the current date the system will subtract the days to hold completed stock counts from the date and delete when this date is reached. The purging will occur when the stock count has a status of 'Complete'.	30	PURGE	Integer
Days to Hold Completed UINs	Indicates how long completed UINs are kept in the system. Completed UINs are defined as any UIN that is in one of the following statuses: Sold Shipped to Warehouse Shipped to Vendor Shipped to Finisher Removed from Inventory Customer Fulfilled	120	PURGE	Integer

Table 9-1 (Cont.) System Admin Parameters

Options	Description	Default Value	Topic	Type
Days to Hold Customer Orders	Indicates the number of days that Cancelled and Fulfilled Customer Orders will be held in the system before being purged.	60	PURGE	Integer
Days to Hold Expired User Roles	Values: 0-999 This will determine the number of days after which the expired roles will be purged from the system	30	PURGE	Integer
Days to Hold Expired item price	Indicates the number of days to hold the expired price changes in the system before being purged.	30	PURGE	Integer
Days to Hold In Progress Ad Hoc Stock Counts	Ad hoc stock counts that are In Progress will be deleted through the purge process. Any ad hoc count with a creation date/time stamp older than this parameter value will be deleted. For example, the default value of 1 would delete all in progress counts more than 24 hours old when the batch is run.	1	PURGE	Integer
Days to Hold Item Basket	Values: 1-999 This will determine the number of days to hold 'Canceled' and 'Completed' Item Baskets.	60	PURGE	Integer
Days to Hold Locking Records	Locking records will be purged through a batch process and the batch process will account for all locking activity across all functional areas. This is to determine the number of days to hold the locking records. The batch will delete all locking behavior around all functional areas where the lock date is less than or equal to the current business date minus the days to hold.	3	PURGE	Integer
Days to Hold Notifications	This parameter is used to purge notifications which are greater than or equal to this value.	14	PURGE	Integer
Days to Hold Price Change Worksheet Records	Records in the price change staging / worksheet table will be purged based upon this parameter.	30	PURGE	Integer
Days to Hold Price History	The 'Days to Hold Price History' parameter allows the user to keep records beyond the 4 most recent historical prices for 'x' number of days if desired. Prices in the future will not be deleted and will not be included as part of the four historical prices that will remain on the database.	90	PURGE	Integer
Days to Hold Received Shipment Records	Values: 0 - 999 Purge all PO and DSD Delivery records in 'Received' and 'Cancelled' status after 'x' number of days defined by user, where the inventory completed date is less than the current date minus the days to hold. There is a receipt record that will be deleted along with any record that is in 'Received' status.	30	PURGE	Integer
Days to Hold Related Items	To determine when a related item should be purged. Program will purge Related items that have an end date in the past. The system will purge the related items after 'x' number of days defined by user, where the related items End Date is less than the current date minus the days to hold.	60	PURGE	Integer

Table 9–1 (Cont.) System Admin Parameters

Options	Description	Default Value	Topic	Type
Days to Hold Resolved UIN Exceptions	Indicates how long resolved UIN exceptions are kept in the system. The date the exception was resolved is the date the system uses to determine if the exception is ready to be purged.	120	PURGE	Integer
Days to Hold RFID	Indicates how long the RFID data that are not present in the store is kept in the system.	999	PURGE	Integer
Days to Hold RFID History	Values: 0 - 999 This parameter will purge RFID history that is greater than or equal today's date minus the days to hold value.	120	PURGE	Integer
Days to Hold RTV	Values: 0 - 999 This parameter will decide that which RTV documents and Shipments need to be purged. The value in this parameter will decide the number of days after a RTV document or shipment gets into cancelled or completed status for document and cancelled or shipped for shipment	30	PURGE	Integer
Days to Hold Sales Posting	The audit trail for the sales posting will be purged on a periodic basis based on the specified parameter. The system will purge all records from the database after the configurable number of days, where the processed date is less than or equal to current date minus the days to hold	120	PURGE	Integer
Days to Hold Scan Lists	Purge any records in 'Complete' or 'Cancelled' status where the post date is less than or equal to the current date minus the days to hold	1	PURGE	Integer
Days to Hold Shelf Adjustment Lists	Purge any records in 'Complete' or 'Cancelled' status where the post date is less than or equal to the current date minus the days to hold	30	PURGE	Integer
Days to Hold Shelf Replenishments	Purge any records in 'Complete' or 'Cancelled' status where the post date is less than or equal to the current date minus the days to hold.	1	PURGE	Integer
Days to Hold Temporary UINs	To indicate how long the temporary UINs must stay in the system.	120	PURGE	Integer
Days to Hold Ticket History	To indicate how long the tickets that printed and persisted in the history table must stay.	60	PURGE	Integer
Days to Hold Transaction History	Determines the number of days after which store_item_stock_history records can be purged.	30	PURGE	Integer
Days to Hold Transfer Documents	Values: 0 -999 This parameter would decide the number of days after which a Transfer document, shipments, and deliveries can be purged.	30	PURGE	Integer
Days to Hold UIN Audit Information	Indicates how long UIN audit information is kept in the system. Audit information can be purged for a UIN within the system. The date the audit transaction was captured is used to determine if the record needs to be purged.	120	PURGE	Integer

Table 9-1 (Cont.) System Admin Parameters

Options	Description	Default Value	Topic	Type
Number of days to keep the SFTP Log file	To determine the number days to hold the SFTP log files.	7	PURGE	Integer
Display Item Image for RFID Locator	Values: Yes/No Yes: This parameter indicates if the item image will be displayed in the RFID Locator dialog in mobile application. No: The image will not be displayed.	No	RFID Locator	Boolean
Days to send Notification before not after date for return requests	Values: 0-999 RTV requests generated in an external system sometimes require the RTV to be dispatched to supplier before a certain date. This option prompts the recipient of the e-mail the specified number of days before the not after date is reached, if the RTV was not dispatched. Note: Email Alert - RTV Request Expiration Approaching , permission will be required to receive the alert.	2	RTV	Integer
Displays Item Image for RTV Requests	Values: Yes/No Yes: This parameter indicates if the item image will be displayed in that transaction. It is in the item list and the details of the transaction. No: Image will not be displayed in that functional area.	No	RTV	Boolean
DSD delivery supplier for RTV	Values: Yes/No This indicator will check to see if the DSD allowed indicator needs to be set in addition to the return allowed values when creating a supplier return. Yes - If the "DSD delivery supplier for RTV" system option is set to 'On', then the system needs to check both the DSD indicator (Indicator on Supplier table which determines whether or not a supplier can create a new Purchase Order) and the return allowed indicator (also an indicator on the supplier table). No - If the "DSD delivery supplier for RTV" system option is set to 'No', then only the return allowed indicator needs to be validated for supplier returns. Note: regardless of the indicator, the system should always be able to dispatch the RTV if it was created in an external system.	Yes	RTV	Boolean
RTV Unavailable Request Qty Notification	Values: Yes/No This system parameter will generate notification when "Auto Approve RTV request" parameter is set to On and the request has unavailable quantity greater than the stock.	Yes	RTV	Boolean
Displays Item Image for RTV Shipment	Values: Yes/No Yes: This parameter indicates if the item image will be displayed in that transaction. It is in the item list and the details of the transaction. No: Image will not be displayed in that functional area.	No	RTV_SHIPMENT	Boolean

Table 9–1 (Cont.) System Admin Parameters

Options	Description	Default Value	Topic	Type
Display Item Image for Replenishment Pick	<p>Values: Yes/No</p> <p>Yes: This parameter indicates if the item image will be displayed in the replenishment pick. It is in the item list and the details of the transaction.</p> <p>No: Image will not be displayed in that functional area.</p>	No	SHELF_REPLENISHMENT	Boolean
Display Item Image for Scan List	<p>Values: Yes/No</p> <p>Yes: This parameter indicates if the item image will be displayed in the scan list. It is in the item list and the details of the transaction.</p> <p>No: Image will not be displayed in that functional area.</p>	No	SHELF_REPLENISHMENT	Boolean
Display Item Image for Shelf Adjustment	<p>Values: Yes/No</p> <p>Yes: This parameter indicates if the item image will be displayed in the shelf adjustment. It is in the item list and the details of the transaction.</p> <p>No: Image will not be displayed in that functional area.</p>	No	SHELF_REPLENISHMENT	Boolean
Display Item Image for Stock Counts - Execution	<p>Values: Yes/No</p> <p>Yes: This parameter indicates if the item image will be displayed in the stock counts. It is in the item list and the details of the transaction.</p> <p>No: The image will not be displayed.</p>	No	STOCK_COUNTS	Boolean
Display Item Image for Stock Counts - Operations	<p>Values: Yes/No</p> <p>Yes: This parameter indicates if the item image will be displayed in the stock counts functionality in EICS.</p> <p>No: The image will not be displayed.</p>	No	STOCK_COUNTS	Boolean
Enable Adhoc Stock Count Locking	<p>This parameter will determine whether a stock count can be locked or not from adding additional item</p> <p>Yes: User will have the ability to lock an adhoc stock count. That is, the user will not be able to add additional items after the initial import.</p> <p>No: User will be able to add any number of items until the adhoc stock is completed.</p>	No	STOCK_COUNTS	Boolean
Stock Count Display Default Timeframe	<p>This parameter is to determine whether the system has to prompt the user to select to whether it is performed before store open or after store close.</p>	No	STOCK_COUNTS	Boolean
Stock Count Lockout Days	<p>Stock Count Lockout Days is used to determine when a Unit and Amount Stock Count can be generated. The system will take this value plus the system date and enforce a start date of the schedule to be greater than or equal to that date.</p> <p>Note: If the system is integrated with the merchandising system, the values in the two systems must be the same.</p>	1	STOCK_COUNTS	Integer

Table 9-1 (Cont.) System Admin Parameters

Options	Description	Default Value	Topic	Type
Stock Count Null Count Quantity = 0	<p>Values: Yes/No</p> <p>Yes: The system changes the quantity to zero for items not counted (null quantity to zero), which makes the items appear as though they were counted.</p> <p>No: The system does not change the quantity to zero for items not counted, but rather leaves the value as null. These items will still appear as though they were not counted.</p> <p>Note This parameter does not apply to Unit and Amount stock counts.</p>	No	STOCK_COUNTS	Boolean
Unguided Stock Count Allow Multiple Users	<p>Values: Yes/No</p> <p>This parameter controls whether more than one user can scan simultaneously again the same child stock count for an unguided count.</p> <p>Yes: The system will allow more than one user to access the same stock count, child count.</p> <p>No: The system will allow more than one user to access the same stock count, but only one user may access a child stock count at a time.</p>	Yes	STOCK_COUNTS	Boolean
Unguided Stock Counts Automatic Save	<p>Values: Yes/No</p> <p>Yes: The physical count timestamp and item count quantity are automatically saved when the next item on the count is scanned.</p> <p>No: The physical count timestamp and item count quantity are saved when the user manually saves the count. It is assumed with this option, the user frequently saves.</p> <p>Note: The physical count timestamp is taken when the user scans the item for the first time.</p>	No	STOCK_COUNTS	Boolean
Unit and Amount Stock Count Sales Processing	<p>Values: Timestamp Processing, Daily Sales Processing</p> <p>Timestamp Processing: This option is used when sales data is available near real-time with a date and time available on the transaction. The user is not prompted to select Before Store Open or After Store Close when starting the stock count since the sales timestamp will be used to compare with the timestamps taken during the stock count.</p> <p>Daily Sales Processing: This option is used when sales data is only available with a date and no time is provided and/or when integrated with RMFCS. The user is either prompted or the store parameter determines when the stock count is performed, (before store opens or after store close). The date is used to determine if a sale is late or not.</p> <p>Note:</p> <p>Unit and Amount stock counts require some dual processing in RMFCS for capturing the financial value. RMS is only capable of processing sales data on a daily bases and disregards the time value if included.</p>	Timestamp	STOCK_COUNTS	Integer

Table 9–1 (Cont.) System Admin Parameters

Options	Description	Default Value	Topic	Type
Unit Stock Count Sales Processing	<p>Values: Timestamp Processing, Daily Sales Processing</p> <p>Timestamp Processing: This option is used when sales data is available near real-time with a date and time available on the transaction. The user is not prompted to select Before Store Open or After Store Close when starting the stock count since the sales timestamp will be used to compare with the timestamps taken during the stock count.</p> <p>Daily Sales Processing: This option is used when sales data is only available with a date and no time is provided. The date is used to determine if a sale is late or not.</p>	Timestamp	STOCK_COUNTS	Integer
Updating Stock On Hand	<p>Values: All/Discrepant</p> <p>Discrepant Items only: The system will update only items identified as discrepant when the Update Auth Qty button is selected and when the stock count has been authorized, only the SOH is updated for the discrepant items only.</p> <p>All Items: The system will update all items regardless if they are discrepant or not when the Update Auth Qty button is selected and when the stock count has been authorized, the SOH is updated for all items, including the non-discrepant.</p> <p>Note: Discrepant items are defined as items having a counted to actual variance greater than the pre-configured allowed variance. Non-discrepant items have a difference between the counted and actual qty, but they are within a tolerated variance. Unit and Amount stock counts will disregard this setting since all items will always be updated for that type of stock count.</p>	1	STOCK_COUNTS	Integer
Carrier Service Refresh Rate Milliseconds	Determines the cache refresh rate for carrier service in milliseconds	3600000	System Settings	Integer
Carton Type Refresh Rate Milliseconds	Determines the cache refresh rate for carton type in milliseconds.	3600000	System Settings	Integer
Context Type Refresh Rate Milliseconds	Determines the cache refresh rate for context type in milliseconds	3600000	System Settings	Integer
Database Clock Refresh Rate Milliseconds	Determines the cache refresh rate for database clock in milliseconds.	10800000	System Settings	Integer
Default POS transaction max size	Determines the max size of pos transaction records that can be processed in one pos transaction webservice call.	1000	System Settings	Integer
JNDI Context Refresh Rate Milliseconds	Determines the cache refresh rate for JNDI context for RIB message publisher in milliseconds.	900000	System Settings	Integer
Merchandise Hierarchy Refresh Rate Milliseconds	Determines the cache refresh rate for merchandise hierarchy in milliseconds.	3600000	System Settings	Integer

Table 9–1 (Cont.) System Admin Parameters

Options	Description	Default Value	Topic	Type
POS Transaction Max. Size for Synchronous Processing	Determines the maximum processing size for pos transaction records. All pos transaction records above this value are staged first.	10	System Settings	Integer
Price History Refresh Rate Milliseconds	Determines the cache refresh rate for item price history in milliseconds.	3600000	System Settings	Integer
Price default extract size	Determines the default extract size for price change import file for Regular, Promotion and Clearance price change batch jobs.	1000	System Settings	Integer
Print Format Refresh Rate Milliseconds	Determines the cache refresh rate for print format types in milliseconds.	3600000	System Settings	Integer
Publish Non Inventory Items	Values: Yes/No This parameter indicates whether the non-inventory items will be published in the outgoing messages or not.	Yes	System Settings	Boolean
Serialization Label Refresh Rate Milliseconds	Indicates serialization label refresh rate in milliseconds.	3600000	System Settings	Integer
Shipment Reason Refresh Rate Milliseconds	Determines the cache refresh rate for finisher shipment reason in milliseconds.	3600000	System Settings	Integer
Store Shipment Reason Refresh Rate Milliseconds	Determines the cache refresh rate for store shipment reason in milliseconds.	3600000	System Settings	Integer
Supplier Refresh Rate Milliseconds	Determines the cache refresh rate for supplier in milliseconds.	3600000	System Settings	Integer
Supplier Shipment Reason Refresh Rate Milliseconds	Determines the cache refresh rate for supplier shipment reason in milliseconds.	3600000	System Settings	Integer
Translation Refresh Rate Milliseconds	Determines the cache refresh rate for locale and translations in milliseconds.	3600000	System Settings	Integer
Uda Details Refresh Rate Milliseconds	Determines the cache refresh rate for UDA details in milliseconds.	3600000	System Settings	Integer
User Authorization Cache Refresh Rate Milliseconds	Determines the cache refresh rate for user authorization cache in milliseconds.	600000	System Settings	Integer
Warehouse Refresh Rate Milliseconds	Determines the cache refresh rate for warehouse in milliseconds.	3600000	System Settings	Integer
Warehouse Shipment Reason Refresh Rate Milliseconds	Determines the cache refresh rate for warehouse shipment reason in milliseconds.	3600000	System Settings	Integer

Table 9–1 (Cont.) System Admin Parameters

Options	Description	Default Value	Topic	Type
Daily GMT Batch Run	<p>Values: Yes/No</p> <p>Yes: Program will only be run once a day. The server is running on GMT and the dates for processing are still stored in GMT. The batch will process everything for the GMT day the server is in, including future records for the same day as the server GMT day.</p>	Yes	TIME_ZONE	Boolean
Enable GMT for Customer Orders	<p>Values: Yes/No</p> <p>This is to determine whether the customer orders uploaded in the system are in GMT.</p>	No	TIME_ZONE	Boolean
Enable GMT for Dex/Nex	<p>Values: Yes/No</p> <p>This parameter will dictate whether or not the DEX/NEX data being loaded into the system is in GMT.</p>	No	TIME_ZONE	Boolean
Enable GMT for Direct Deliveries	<p>Values: Yes/No</p> <p>This parameter will dictate whether or not the Direct Delivery messages published by an external system should have dates in GMT or not.</p> <p>Yes: When publishing the Direct Delivery messages, it means that the dates in the message should be written in GMT. When subscribing to the purchase order messages, it means that the dates are coming in, in GMT time and no conversion needs to occur. When publishing a purchase order message, it means that the dates in the message should be written in GMT.</p> <p>No: When publishing the direct delivery messages, it means that the dates in the message should be converted from GMT and written in the store's local date/time. When subscribing to the purchase order message, it means that the dates are coming in, in are in the store's local date/time and must be converted to GMT prior to persisting the date in the database.</p> <p>When publishing the purchase order message, it means that the dates in the message should be converted from GMT and written in the store's local date/time.</p>	No	TIME_ZONE	Boolean
Enable GMT for Foundation Data	<p>Values: Yes/No</p> <p>This parameter will dictate whether or not any foundation data messages being loaded into the system are in GMT.</p>	No	TIME_ZONE	Boolean
Enable GMT for Inventory Adjustments	<p>Values: Yes/No</p> <p>This new system parameter will determine which date/time stamp is used in the inventory adjustment message when it is being published.</p> <p>Yes: When publishing the inventory adjustment message, it means that the dates in the message should be written in GMT.</p> <p>No: When publishing the inventory adjustment message, it means that the dates in the message should be converted from GMT and written in the store's local date/time.</p>	No	TIME_ZONE	Boolean

Table 9–1 (Cont.) System Admin Parameters

Options	Description	Default Value	Topic	Type
Enable GMT for POS sale import process	<p>Values: Yes/No</p> <p>This parameter will dictate whether or not the POS data being loaded into the system are in GMT.</p>	No	TIME_ZONE	Boolean
Enable GMT for Price Changes	<p>Values: Yes/No</p> <p>This parameter will dictate whether or not the price changes being subscribed to by the system are time zone sensitive.</p> <p>Yes: When subscribing to a price change, it means that the effective date is coming in GMT time and no conversion needs to occur.</p> <p>No: The effective date must be converted prior to storing the price change in the system.</p>	No	TIME_ZONE	Boolean
Enable GMT for RTVs	<p>Values: Yes/No</p> <p>This system parameter will dictate whether or not the RTV message being loaded into the system is in GMT. Likewise, if the system publishes any RTV message this will determine which date/time stamp is used on the message as well</p> <p>Yes: When subscribing to the RTV message, it means that the dates are coming in, in GMT time and no conversion needs to occur.</p> <p>When publishing the RTV message, it means that the dates in the message should be written in GMT.</p> <p>No: When subscribing to the RTV message, it means that the dates are in the store's local date/time and must be converted to GMT prior to persisting the date in the database.</p> <p>When publishing the RTV message, it means that the dates in the message should be converted from GMT and written in the store's local date/time</p>	No	TIME_ZONE	Boolean
Enable GMT for ReSA sale import process	<p>Values: Yes/No</p> <p>This parameter will dictate whether or not the ReSA data being loaded into the system are in GMT.</p>	No	TIME_ZONE	Boolean
Enable GMT for Receiving	<p>Values: Yes/No</p> <p>This parameter will dictate whether or not receiving messages need to be published in GMT or not.</p>	No	TIME_ZONE	Boolean
Enable GMT for Stock Counts	<p>Values: Yes/No</p> <p>This parameter will determine which date/time stamp is used in the stock count message when it is being published.</p> <p>Yes: When publishing the stock count message, it means that the dates in the message should be written in GMT.</p> <p>No: When publishing the stock count message, it means that the dates in the message should be converted from GMT and written in the store's local date/time.</p>	No	TIME_ZONE	Boolean

Table 9–1 (Cont.) System Admin Parameters

Options	Description	Default Value	Topic	Type
Enable GMT for Store Transfers	<p>Values: Yes/No</p> <p>This new system parameter will dictate whether or not the Transfer messages being loaded into the system from an external system has dates in GMT or not. ikewise, if the system publishes any Transfer messages to an external system this will determine which date/time stamp is used on the message as well.</p> <p>Yes - When subscribing to the Transfer messages, it means that the dates are coming in, in GMT time and no conversion needs to occur.</p> <p>When publishing a transfer message, it means that the dates in the message should be written in GMT.</p> <p>No - When subscribing to the transfer message, it means that the dates are coming in, in are in the store's local date/time and must be converted to GMT prior to persisting the date in the database.</p> <p>When publishing the transfer message, it means that the dates in the message should be converted from GMT and written in the store's local date/time.</p>	No	TIME_ZONE	Boolean
Enable GMT for Third Party Stock Counts	<p>Values: Yes/No his parameter will determine whether the date/time stamp in the Third party stock count file (DSL DAT) is in GMT or not.</p>	No	TIME_ZONE	Boolean
Enable GMT for Vendor ASN	<p>Values: Yes/No</p> <p>This parameter will dictate whether or not the Vendor ASN messages being loaded into the system have dates in GMT or not.</p>	No	TIME_ZONE	Boolean

Table 9-1 (Cont.) System Admin Parameters

Options	Description	Default Value	Topic	Type
Enable GMT for Warehouse Transfers	<p>Values: Yes/No</p> <p>This new system parameter will dictate whether or not the transfer messages being loaded into the system have GMT dates or not. Likewise, if the system publishes any transfer message to an external system this will determine which date/time stamp is used on the message as well.</p> <p>Yes: When subscribing to the transfer messages, it means that the dates are coming in, in GMT time and no conversion needs to occur.</p> <p>When retrieving transfer data, it means that the dates are in GMT time and no conversions needs to occur. This includes both reading and writing data.</p> <p>When publishing a transfer message, it means that the dates in the message should be written in GMT.</p> <p>No: When subscribing to the transfer message, it means that the dates are coming in, in are in the store's local date/time and must be converted to GMT prior to persisting the date in the database.</p> <p>When retrieving transfer data, it means that the dates are not in GMT time and must be converted to GMT. This includes both reading and writing data.</p> <p>When publishing the transfer message, it means that the dates in the message should be converted from GMT and written in the store's local date/time.</p>	No	TIME_ZONE	Boolean
Damaged Delivery Notification	<p>Values: Yes/No</p> <p>Yes: Sends a notification to the receiving store when damaged items are received on the delivery.</p> <p>No: No email alert is sent. This parameter generates a notification for transfers with items marked as damaged (Warehouse, Store, Finisher).</p>	Yes	TRANSFER_RECEIVING	Boolean
Days Shipped Delivery Overdue Notification	<p>Values: 1-999</p> <p>This parameter generates a notification when the delivery is overdue. The delivery will be considered overdue when the create date of the delivery plus the days from this parameter have passed. This will include only deliveries from source type store.</p>	7	TRANSFER_RECEIVING	Integer
Display Item Image for Transfer Receiving	<p>Values: Yes/No</p> <p>Yes: This parameter indicates if the item image will be displayed in that transaction. It is in the item list and the details of the transaction.</p> <p>No: Image will not be displayed in that functional area.</p>	No	TRANSFER_RECEIVING	Boolean

Table 9–1 (Cont.) System Admin Parameters

Options	Description	Default Value	Topic	Type
External Finisher UIN Qty Discrep Notification	<p>Values: Yes/No</p> <p>This system parameter will generate notification when there is a discrepancy with the number of UINs on the ASN and the UINs received when auto receiving with a Source Type of 'Finisher'.</p> <p>Yes: Whenever the transaction cannot be auto received, the system generates a notification when there is a discrepancy with the number of UINs on the Finisher Return and the UINs received.</p> <p>Auto Received by batch</p> <p>Auto Received thru RIB Injector.</p> <p>No: No email alert is generated.</p>	Yes	TRANSFER_RECEIVING	Boolean
Misdirected Container Notification	<p>Values: On / No</p> <p>Yes: Sends a notification when a location receives a container belonging to another location.</p> <p>No: No notification is sent.</p> <p>This system parameter will generate a notification when there is a misdirected container that has been received in another location.</p>	Yes	TRANSFER_RECEIVING	Boolean
Number of Days Received Transfer Deliveries can be Adjusted	<p>Values: 0-999</p> <p>This parameter controls the number of days a container can be adjusted within a receipt after (Warehouse, Store, Finisher) are received.</p> <p>0: no adjustment allowed</p> <p>1: allowed to adjust until the end of today</p> <p>2: allowed to adjust until the end of tomorrow</p> <p>X: allowed to adjust until x days starting from today</p>	0	TRANSFER_RECEIVING	Integer
Quick Receiving - Receive misdirected containers	<p>Values: Yes/No</p> <p>Yes: Enables the ability to receive misdirected containers.</p> <p>No: Disables the ability to receive misdirected containers.</p>	Not Allowed	TRANSFER_RECEIVING	Integer
Quick Receiving - Receive missing containers	<p>Values: Yes/No</p> <p>Yes: Enables the ability to receive missing containers.</p> <p>No: Disables the ability to receive missing containers.</p>	Yes	TRANSFER_RECEIVING	Boolean
Receive Entire Transfer	<p>Values: Yes/No</p> <p>Yes: User is ONLY allowed to receive the entire delivery. It is not allowed to add any items, only confirmation of the receipt is allowed (Warehouse, Store, Finisher).</p> <p>No: The user is not limited to only receiving the entire delivery.</p>	No	TRANSFER_RECEIVING	Boolean

Table 9-1 (Cont.) System Admin Parameters

Options	Description	Default Value	Topic	Type
Store Receiving Force Close Indicator	<p>Values: RL / SL / NL This parameter applies to deliveries with a Source Type of 'Store'.</p> <p>RL: (Receiver Loss) Any shipped quantity that was not received is a loss at the receiving store.</p> <p>SL: (Sending Loss) Any shipped quantity that was not received is a loss at the sending store.</p> <p>NL: (No Loss) Any shipped quantity that was not received does not affect the receiving or the sending store.</p>	Receiving Loss	TRANSFER_RECEIVING	Integer
Store Receiving Over/Under Notification	<p>Values: Yes / No</p> <p>This parameter generates a notification to the receiving store when items on a transfer receipt with a Source Type of 'Store' is greater than or less than the expected quantity or if the expected quantity is null or zero. A notification should not be sent in the case of a manually created container or a copied misdirected container.</p> <p>On: Sends a notification when the receiving store over or under receives goods.</p> <p>No: No email alert is sent.</p>	Yes	TRANSFER_RECEIVING	Boolean
Warehouse/Store UIN Qty Discrep Notification	<p>Values: Yes/No</p> <p>This system parameter will generate notification when there is a discrepancy with the number of UINs on the ASN and the UINs received when auto receiving a warehouse or store delivery with a Source Type of 'Warehouse' or 'Store'.</p> <p>Yes: Sends a notification when there is a discrepancy with UINs on the ASN. The number of UINs on the ASN and the Qty received do not match and cannot be auto received.</p> <p>Auto Received by batch (Store), (Warehouse) Auto Received thru RIB Injector</p> <p>No: No notification is generated.</p>	Yes	TRANSFER_RECEIVING	Boolean
Display Item Image for Transfer Shipment	<p>Values: Yes/No</p> <p>Yes: This parameter indicates if the item image will be displayed in that transaction. It is in the item list and the details of the transaction.</p> <p>No; Image will not be displayed in that functional area.</p>	No	TRANSFER_SHIPMENT	Boolean
Days to send Notification before not after date for transfer requests	<p>Values: 0-999</p> <p>For transfer requests generated in an external system (warehouse, store or finisher), his option sends a notification the specified number of days before the not after date is reached, if the transfer was not dispatched.</p>	2	TRANSFERS	Integer
Display Item Image for Transfer	<p>Values: Yes/No</p> <p>Yes: This parameter indicates if the item image will be displayed in that transaction. It is in the item list and the details of the transaction.</p> <p>No: Image will not be displayed in that functional area.</p>	No	TRANSFERS	Boolean

Table 9–1 (Cont.) System Admin Parameters

Options	Description	Default Value	Topic	Type
Transfer Request Approve Notification	<p>Values : Yes/No</p> <p>Yes: A notification will be generated when a requested transfer is approved.</p> <p>No: No notification will be generated.</p> <p>Note: The notification will only be generated for SIOCS initiated store to store requests.</p>	No	TRANSFERS	Boolean
Transfer Request Notification	<p>Values: Yes/No</p> <p>Yes: A notification will be generated when a transfer is requested.</p> <p>No: No notification will be generated.</p> <p>Note: he notification will only be generated for SIOCS initiated store to store requests.</p>	No	TRANSFERS	Boolean
Transfer Request Reject Notification	<p>Values: Yes/No</p> <p>Yes: A notification will be generated when a transfer is rejected.</p> <p>No: No notification will be generated.</p> <p>Note: The notification will only be generated for SIOCS initiated store to store requests.</p>	No	TRANSFERS	Boolean
Unavailable Qty Discrepancy Notification	<p>Values: Yes/No</p> <p>Yes: A notification will be generated when a transfer request fails auto-approval.</p> <p>No: No notification will be generated.</p> <p>Note: Auto Accept External Generated Request is set to On and Unavailable quantity requested is more than the sending store has.</p>	No	TRANSFERS	Boolean
Currency Default Type	Gives the default currency for EICS and SOCS.	USD	UI	String
Display Item Description	<p>Values: Short Description / Long Description</p> <p>Short Item Description: The description displayed everywhere will be the short item description.</p> <p>Note that when integrated with Oracle Retail's merchandising system, the short description of an item is a product of the first 20 characters of the long description.</p> <p>Long Item Description: The description displayed everywhere will be the long item description.</p> <p>Note that when integrated with Oracle Retail's merchandising system, the Merchandising system concatenates the diff descriptions with the long item description so the user is able to view all diff information. The diffs display in order from Diff 1 to Diff 4.</p>	Short Description	UI	Integer

Table 9-1 (Cont.) System Admin Parameters

Options	Description	Default Value	Topic	Type
Display Item Description Diffs	Values: Yes/No Yes: A second item description line for diffs will be used wherever an item description is displayed where applicable. No: The second line will not be displayed for the item description and the diffs will not be displayed separately.	Yes	UI	Boolean
Maximum Manual Quantity Entry	Values: 1-100,000,000 The value set here will be the maximum value a user can enter for a quantity via the Numeric Entry on the mobile.	999	UI	Integer
Problem Line UI Limit	Gives the recommended item count in product group component screen for problem line stock count product group.	1500	UI	Integer
Search Limit Default for Area	Values: 1-999 This parameter indicates the default search limit for the Area List screen on EICS.	50	UI	Integer
Search Limit Default for Container Lookup - Execution	Values: 1-999 Indicates the default search limit for Container Lookup on SOCS.	50	UI	Integer
Search Limit Default for Container Lookup - Operations	Valid values will be 1-999 This parameter will determine the number of records to be displayed on container lookup list screen. The default value on container lookup list screen should be set to the value for the system parameter.	50	UI	Integer
Search Limit Default for Customer Order Picking	Values: 1-999 Indicates the default search limit for Customer Order Picking.	50	UI	Integer
Search Limit Default for Customer Orders	Values: 1-999 Indicates the default search limit for Customer Orders.	50	UI	Integer
Search Limit Default for DSD Receiving	This is to determine the default search limit for DSD receiving list.	50	UI	Integer
Search Limit Default for Finisher Lookup	Values: 1-999 Indicates the default search limit for Finisher Lookup.	50	UI	Integer
Search Limit Default for Inventory Adjustments - Execution	Values: 1-999 Indicates the default search limit for Inventory Adjustments on SOCS.	50	UI	Integer
Search Limit Default for Inventory Adjustments - Operations	Values: 1-999 Indicates the default search limit for Inventory Adjustments on EICS.	50	UI	Integer

Table 9–1 (Cont.) System Admin Parameters

Options	Description	Default Value	Topic	Type
Search Limit Default for Item Baskets - Execution	Values: 0-999 Indicates the default search limit for Item Baskets on SOCS.	50	UI	Integer
Search Limit Default for Item Baskets - Operations	Values: 0-999 Indicates the default search limit for Item Baskets on EICS.	50	UI	Integer
Search Limit Default for Item Lookup - Execution	Values: 1-999 Indicates the default search limit for Item Lookup on SOCS.	50	UI	Integer
Search Limit Default for Item Lookup - Operations	Values: 1-999 Indicates the default search limit for Item Lookup on EICS.	50	UI	Integer
Search Limit Default for Item Scan Number Lookup	Valid Valued will be 1-999 This parameter will determine the number of records to be displayed on the Item Scan Number Lookup screen. The default value on the ISN Lookup search screen should be set to the value from this parameter.	500	UI	Integer
Search Limit Default for MPS Staged Messages	Values: 1-999 Indicates the default search limit for MPS staged messages on MPS staged message screen in EICS.	50	UI	Integer
Search Limit Default for Notifications	Values: 1-999 Indicates the default search limit for Notifications.	50	UI	Integer
Search Limit Default for Open Transaction	Values: 1-999 Indicates the default search limit for Open Transactions.	50	UI	Integer
Search Limit Default for Operational Views - Operations	Valid values will be 1-999 This parameter will determine the number of records to be displayed on various operational view screens. The default value on various operational views screens should be set to the value from the system parameter.	50	UI	Integer
Search Limit Default for Purchase Order	This parameter will determine the default number of records to be displayed on PO list screen.	50	UI	Integer
Search Limit Default for Replenishment Pick	Values: 1-999 Indicates the default search limit for shelf replenishment.	50	UI	Integer
Search Limit Default for RTV	Values: 1-999 Indicates the default search limit for Returns.	50	UI	Integer
Search Limit Default for Scan List	Values: 1-999 Indicates the default search limit for scan lists.	50	UI	Integer

Table 9-1 (Cont.) System Admin Parameters

Options	Description	Default Value	Topic	Type
Search Limit Default for Shelf Adjustment	Values: 1-999 Indicates the default search limit for shelf adjustments.	50	UI	Integer
Search Limit Default for Stock Count	Values: 1-999 Indicates the default search limit for Stock Counts.	50	UI	Integer
Search Limit Default for Supplier Lookup	Values: 1-999 Indicates the default search limit for Supplier Lookup.	50	UI	Integer
Search Limit Default for Supplier Lookup - Operations	Values:1-999 This parameter will determine the number of records to be displayed on supplier lookup list screen. The default value on supplier lookup list screen should be set to the value for the system parameter.	50	UI	Integer
Search Limit Default for Transaction History	Values: 1-999 Indicates the default search limit for Transaction History.	50	UI	Integer
Search Limit Default for Transfer Receipts	Values: 1-999 Indicates the default search limit for Transfer receipts.	50	UI	Integer
Search Limit Default for Transfer Shipment	Values: 1-999 Indicates the default search limit for Transfer shipments.	50	UI	Integer
Search Limit Default for Transfers	Values: 1-999 Indicates the default search limit for Transfer documents.	50	UI	Integer
Search Limit Default for Troubled Transaction List	Values: 1-999 Indicates the default search limit for Troubled Transactions	50	UI	Integer
Search Limit Default for UIN Lookup	Values: 1-999 Indicates the default search limit for UIN Lookup.	50	UI	Integer
Shelf Replenishment UI Limit	Gives recommended item count in product group component screen for shelf replenishment pick product groups.	1500	UI	Integer
Unit and Amount Count UI Limit	Gives the recommended item count in product group component screen for unit and amount stock count product group.	1500	UI	Integer
Unit Count UI Limit	Gives the recommended item count in product group component screen for unit stock count product group.	5000	UI	Integer
Allow Store UIN Relocation	Values: Yes/No Indicates whether UIN can be relocated from one store to another.	Yes	UIN	Boolean

Store Admin Parameters

Table 9–2 Store Admin Parameters

Options	Description	Default Value	Topic	Type
Manifest Weight UOM	<p>Values: List of UOMs from the Weight UOM table</p> <p>The UOM selected for this store admin will be used as the Weight UOM for the weight on the BOL in store to store transfer shipments, customer order deliveries and returns.</p>	LBS	ADMIN	String
SSCC Shipping Label ID Generation	<p>Values: Yes / No</p> <p>Yes: The system will generate an identifier for printing on the shipping label.</p> <p>No: The user will need to enter an identifier for printing on the shipping label.</p> <p>This store parameter will be used for RTV Shipping and Transfer Shipping.</p>	yes	ADMIN	Boolean
Use Extended Attribute Entry	<p>This will turn on and off the feature for editing transaction item level attributes, the capturing of Extended Attributes will be skipped.</p> <p>Values: Yes/No</p> <p>Yes: Extended Attributes will be captured in the functional areas in EICS and SOCS.</p> <p>No: Extended Attributes will be captured in the functional areas in EICS and SOCS. The Ext Attributes data entry screen will not be available.</p>	No	ADMIN	Boolean
Allow Picking By Area	<p>Values: Yes/No</p> <p>Yes: Picking by Area is allowed. The user will be able to select an Area when creating a pick if the Customer Order Fulfillment Restriction is set to 'Transaction Controlled'. The system will narrow down the customer order to those items within an area when creating the pick.</p> <p>No: Picking by Area is not allowed and the system will always look at all items on the customer order when creating a pick.</p>	Yes	CUSTOMER_ORDER	Boolean
Auto Pick Mixed Containers	<p>Values: Yes/No</p> <p>Yes: If a container has items in it that are for both customer orders and non-customer orders, the system will auto pick the container. It will mark those items that exist on the customer order as picked.</p> <p>No: If there is a mixed container of customer order and non-customer order items, it will not get auto picked and the picked quantities will not be updated.</p>	No	CUSTOMER_ORDER	Boolean

Table 9–2 (Cont.) Store Admin Parameters

Options	Description	Default Value	Topic	Type
Auto Pick On Receive - Direct Delivery	<p>Values : Yes/No</p> <p>Yes: The system will automatically fill in the pick quantities on the customer order when receiving. This can only happen if the customer order record has already come into the system. If there is no customer order, the auto picking will not happen at the time of receiving, rather it will occur when the customer order comes in.</p> <p>No: The system will not pick when receiving goods.</p>	No	CUSTOMER_ORDER	Boolean
Auto Pick On Receive - Transfer Receiving	<p>Values: Yes/No</p> <p>Yes: The system will automatically fill in the pick quantities on the customer order when receiving. This can only happen if the customer order record has already come into the system. If there is no customer order, the auto picking will not happen at the time of receiving, rather it will occur when the customer order comes in.</p> <p>No: The system will not pick when receiving goods in transfer receiving.</p>	No	CUSTOMER_ORDER	Boolean
Default Customer Order Picking Method	<p>Values: Bin / Store Customer Order</p> <p>This parameter is used to define the default picking method when creating a customer order pick, bin or store customer order.</p> <p>Note this is just a default and the user can still switch the picking method.</p>	Store Customer Order	CUSTOMER_ORDER	Integer
Default Number of Bins	<p>Values: 1-999</p> <p>This parameter will determine the number of bins to default into the 'Bin Qty' field if the user selects 'Bin' as the pick type when creating the pick.</p>	1	CUSTOMER_ORDER	Integer
Dispatch Validate	<p>Valid Values: Ship Direct, Ship Submit</p> <p>Ship Direct: System will control all processes. The user will be able to go from create/edit directly to dispatch. There will not be a submit option.</p> <p>Ship Submit: This option will require the user to press the Submit option, and require a specific press of the dispatch button.</p>	Ship Direct	CUSTOMER_ORDER	Integer
Generate Bins	<p>Values: System / Manual</p> <p>System: The system will automatically generate the bin IDs when the pick is created.</p> <p>Manual: The system will require the user to enter the bin IDs upon taking action on the created pick. This option removes the need for printing out labels since the labels already exist on the bin. For both System and Manual, the user will still have the option to print labels for the bins.</p>	Manual	CUSTOMER_ORDER	Integer

Table 9–2 (Cont.) Store Admin Parameters

Options	Description	Default Value	Topic	Type
Item Substitution - Store Discretion	<p>Values: Yes/No</p> <p>This store parameter is used to determine if the user can use their own discretion when doing substitute items in the picking process.</p> <p>Yes: The user can choose any item to be used as a substitute item.</p> <p>No: Only those items that are defined as substitutes can be substituted.</p>	No	CUSTOMER_ORDER	Boolean
Override Bin Quantity	<p>Values: Yes/No</p> <p>This store parameter determines whether the user is allowed to override the default bin quantity when creating a pick by bin. The Bin Quantity is defaulted based upon the store parameter for Default Number of Bins.</p>	No	CUSTOMER_ORDER	Boolean
Picking Required for Customer Orders	<p>Values: Yes/No</p> <p>Yes: Requires that manual picking be performed on the customer order prior to being able to create a delivery for it.</p> <p>No: Picking is not necessary in order to create a delivery.</p>	Yes	CUSTOMER_ORDER	Boolean
Pre-shipment Notification	<p>Values: Yes / No</p> <p>This parameter will drive the following functionality:</p> <p>Yes: The system will publish a pre-shipment message</p> <p>No: The system will not publish a pre-shipment message</p>	No	CUSTOMER_ORDER	Boolean
Reserve Customer Order Inventory Upon Receiving	<p>Values: Yes/No</p> <p>This store parameter will dictate when inventory for a web order customer order should be reserved.</p> <p>Yes: Inventory will be reserved upon receiving a delivery in the store which contains the customer order (Store to store transfer, DSD, Warehouse to Store transfer). If the retailer wishes to fulfill the customer orders from deliveries, for example getting the goods from the warehouse, then this option would be set to Yes to reserve upon receiving.</p> <p>No: Inventory will be reserved upon getting the customer order into the store. If the retailer chooses to mainly fulfill customer orders from within the stock in the store, this parameter would be set to No, thus reserving inventory right away when the customer order is received.</p>	No	CUSTOMER_ORDER	Boolean
Allow Multiple Deliveries against PO with No ASN	<p>Values: Yes/No</p> <p>Yes: The user is able to create more than one delivery for the same PO when the PO does not have an associated ASN.</p> <p>No: The user can only create a single delivery against a PO when the PO does not have an associated ASN. The PO will be closed when the delivery is confirmed.</p>	Yes	DSD_RECEIVING	Boolean
Auto close days after expected date	<p>Values: 0-999</p> <p>Number of days after the expected delivery date the ASN will be closed.</p>	5	DSD_RECEIVING	Integer

Table 9–2 (Cont.) Store Admin Parameters

Options	Description	Default Value	Topic	Type
DSD Receiving Auto Remove Damaged Quantity	<p>Values: Yes/No</p> <p>Yes: All damaged items on the delivery are removed automatically when confirming the transaction.</p> <p>No: All damaged items remain on the delivery when confirming the transaction.</p>	No	DSD_RECEIVING	Boolean
Direct Delivery Auto Remove Over Received Quantity	<p>Values: Yes/No</p> <p>Yes: If set to Yes, the user is allowed to add any quantity for the DSD, but any quantity above the expected quantity will be removed from the transaction. After the user confirms the transaction, they are prompted that any over received quantities will be removed. The user is able to create more than one delivery for the same PO when the PO does not have an associated ASN.</p> <p>No: The over received quantities will stay in the delivery transaction.</p>	No	DSD_RECEIVING	Boolean
Direct Delivery Default to ShopFloor Receiving	<p>Values: Yes/No</p> <p>This parameter determines whether the DSD receiving dialog will default to receive inventory into the shop floor instead of automatically receiving into the back room.</p> <p>Yes: The DSD Receiving Container workflow will default the option to receive inventory into the shop floor. The shop floor inventory bucket will be incremented instead of the backroom bucket. If a capacity is defined for the item, the maximum shop floor quantity will equal the capacity; otherwise, the shop floor will be updated to the entire receipt amount.</p> <p>No: The option will be defaulted to back room and all inventory will be automatically received into the back room or delivery bay.</p>	No	DSD_RECEIVING	Boolean
Direct Delivery Invoice Entry	<p>Values: Enabled/Disabled/Unique</p> <p>Enabled: This option allows the user to enter any value for the invoice number, including duplicates.</p> <p>Disabled: The Invoice Number and date fields are disabled. Unique: The Invoice Number field will allow entry, however, the user will not be able to enter a duplicate invoice number based upon the supplier.</p> <p>Upon entering an Invoice Number, the system will validate if the invoice already exists for the supplier defined on the DSD. If a duplicate exists, there will be an error. If no duplicate exists, the invoice number will be accepted.</p>	Enabled	DSD_RECEIVING	Integer

Table 9–2 (Cont.) Store Admin Parameters

Options	Description	Default Value	Topic	Type
Direct Delivery Receive Item Capacity	<p>Values: Yes/No</p> <p>This parameter determines whether the capacity will be considered while receiving the deliveries.</p> <p>Yes: While receiving, the capacity will be considered. For example: If capacity is 50, delivery is for 100, and Available SOH is 10 on the shop floor, if this parameter is on and receive in shop floor is checked, 40 (un-damaged) will be moved to shop floor and the rest to the backroom.</p> <p>No: While receiving, the capacity will not be considered. Damaged inventory will not move to the shop floor.</p>	No	DSD_RECEIVING	Boolean
Days Before Item Basket Expiration	<p>Values: 0-999</p> <p>This parameter will be used to add to the system date when defaulting the expiration date on an item basket. A value of 0 would set the expiration date to today. A value of 1 will set the expiration date to tomorrow (today + 1).</p>	1	ITEM_BASKET	Integer
Display Shopfloor/Backroom Quantity	<p>Values: Yes/No</p> <p>Yes: This parameter indicates if the shop floor and back room SOH should be displayed in the header and in the Inventory section of Item Detail screen.</p> <p>No: Shop floor and back room SOH will not be displayed in the header and Inventory section of Item Detail screen.</p>	No	ITEM_LOOKUP	Boolean
Auto Accept External Generated RTV Request	<p>Values: Yes/No</p> <p>This parameter determines whether system automatically approves the return request and defaults the requested quantity to the accepted quantity for externally generated RTV requests.</p>	No	RTV	Boolean
Not After Date Default days	<p>Values: 0-999</p> <p>This parameter would decide the number of days after which a RTV document can be closed After not after date is passed. All status documents would be marked cancelled once this criteria is met.</p>	30	RTV	Integer
Dispatch Validate	<p>Values: Ship Direct, Ship Submit</p> <p>Ship Direct: SIOCS will control all processes. The user will be able to go from create/edit directly to dispatch.</p> <p>Ship Submit: This option will require the user to press the Submit button, and require a specific press of the dispatch button. An additional option is that an external system will generate a dispatch message through a standard web service.</p>	Ship Direct	RTV_SHIPMENT	Integer
Pre-shipment Notification	<p>Values: Yes/No</p> <p>Yes: The system will publish a pre-shipment message.</p> <p>No: The system will not publish a pre-shipment message.</p>	No	RTV_SHIPMENT	Boolean

Table 9-2 (Cont.) Store Admin Parameters

Options	Description	Default Value	Topic	Type
RTV Shipment Carrier Default	<p>Values: Sender / Receiver / Third Party</p> <p>When creating a return the Carrier Type on the BOL will default initially based upon this parameter. The user can still change this value and if so, that will be the value used on the return.</p> <p>Sender: Sender will be selected for Carrier Type on BOL</p> <p>Receiver: Receiver will be selected for the Carrier type on BOL.</p> <p>Third Party: Third Party will be selected for the Carrier type on the BOL. The type (drop down) will be defaulted to "Other".</p>	Third Party	RTV_SHIPMENT	Integer
Display Sequence Fields	<p>Values: Yes/No</p> <p>This parameter is to determine whether the sequencing fields are displayed.</p>	No	SEQUENCING	Boolean
Replenishment - At Case Level	<p>Yes: The standard UOM will default to Cases on the shelf replenishment screens.</p> <p>No: The standard UOM will default to Units on the shelf replenishment screens.</p> <p>Note: This parameter will determine whether to replenish shelves at the Case or standard unit of measure. This will override the 'Default UOM' system parameter.</p>	Yes	SHELF_REPLENISHMENT	Boolean
Replenishment - Delivery Bay Inventory	<p>Values: Yes/No</p> <p>Yes: The delivery bay will be used for replenishment.</p> <p>No: The delivery bay will not be used.</p>	Yes	SHELF_REPLENISHMENT	Boolean
Replenishment - End of Day max. fill %	<p>This parameter will determine the percentage the stock can fall to before creating the end of day replenishment list.</p>	100	SHELF_REPLENISHMENT	Double
Replenishment - Item Substitution Store Discretion	<p>Values: Yes/No</p> <p>Yes: The user is allowed to choose any item to substitute. An item lookup feature will allow the user to search for an item to select.</p> <p>No: The user is restricted to scanning/entering an item that exists on the list of approved substitute items defined by the merchandising system.</p> <p>Note: If there are no items defined for item substitution, the dialogue will be displayed with the original item in the header with no substitutes.</p>	No	SHELF_REPLENISHMENT	Boolean
Replenishment - Within Day Max. fill %	<p>This parameter will determine the percentage the stock can fall to before creating the within day replenishment list.</p>	75	SHELF_REPLENISHMENT	Double

Table 9–2 (Cont.) Store Admin Parameters

Options	Description	Default Value	Topic	Type
Display Late Inventory Adjustment Message	<p>Yes: When the user is confirming a Stock Count in the Authorization phase and there are items on the stock count with In Progress Inventory Adjustments, the user may return to the stock count to complete the inventory adjustments or to continue and ignore the adjustments.</p> <p>When the user is approving an inventory adjustment with items on an open stock count, a message is displayed allowing the user to determine if further processing should be undertaken. Similar logic to how late sales are processed will be used for these adjustments.</p> <p>No: When the user is confirming a Stock Count in the Authorization phase and there are items on the stock count with In Progress Inventory Adjustments the system ignores the inventory adjustments and allows the user to complete the count.</p> <p>When the user is approving an inventory adjustment, there is no additional processing.</p> <p>Note: The system will process the inventory adjustment similar to how late sales are processed and determine if the stock count should be adjusted or not. The update to the stock count is not immediate but rather is at the time of authorization if there are reversing entries created.</p>	No	STOCK_COUNTS	Boolean
Stock Count Default Timeframe	<p>Valid Values: Before Store Open/ After Store Close</p> <p>This parameter defines when the stock count is performed in relation to the store opening hours for Daily Sales Processing. This value may be overridden at the time of the stock count, if the system is configured to allow the override. If an override is allowed, this setting will determine the default value displayed.</p> <p>Before Store Open: The stock count is performed before the opening of the store. All sales on the day of the stock count will only update SOH. It will not update any counted quantities.</p> <p>After Store Close: The stock count is performed after the closing of the store. All sales on the day of the stock count will update both SOH and any counted quantities. If using RMS, After Store Close must be selected.</p> <p>Note: Timestamp processing does not use this parameter.</p>	Before Store Open	STOCK_COUNTS	Integer

Table 9-2 (Cont.) Store Admin Parameters

Options	Description	Default Value	Topic	Type
Quick Item Price Events	<p>When an item is scanned, the system checks the store parameter 'Quick Item Price Events' setting to determine for what pricing event types it has to print the item price ticket.</p> <p>If the event type set is 'Clearance', the system checks whether the clearance event is active on that day for that item and if it is then the system generates the ticket and prints to the configured printer.</p> <p>If the event type set is 'All', the system prints the item price anyway with the current active price.</p> <p>If the event type set is 'Event', the system checks whether any event present and will only print if there is a change for the day (clearance, promo or regular, but no same day promotions)</p> <p>If the event type set is 'Regular', the system prints the regular price for the entered item.</p> <p>If the event type set is 'Promotion', the system prints the price only if the item is in active promotion for the day and prints the promotion price.</p>	All	TICKETING	string
Auto Accept External Generated Request	<p>Values: Yes/No</p> <p>This parameter automatically approves the requested transfer and defaults the requested quantity to the accepted quantity for externally generated requests.</p>	No	TRANSFERS	Boolean
Auto Accept Store Transfer Request	<p>Values: Yes/No</p> <p>This parameter automatically approves the requested transfer and defaults the requested quantity to the accepted quantity for store to store requests.</p>	No	TRANSFERS	Boolean
Not After Date Default Days	<p>Values: 0-999</p> <p>This parameter adds a value to the current date and uses the value to default the 'Not After Date' when creating a transfer or requesting a transfer. Documents will be closed via batch when this date is reached.</p>	30	TRANSFERS	Integer
Auto Close Receipt	<p>Values: 1-99</p> <p>0: close the receipt immediately</p> <p>1: close the receipt the end of day today</p> <p>2: close the receipt end of day tomorrow</p> <p>X: close end of day x days starting from today The batch program will auto close any transfer receipts, and marks all non-received containers to missing. Partially received containers will be marked as damaged.</p>	1	TRANSFER_RECEIVING	Integer
External Finisher Auto Receive	<p>Values: Not Allowed, External Message, Date Driven</p> <p>Not allowed will make the system work as today.</p> <p>External message will receive the full external finisher delivery with a Source Type of 'Finisher', the moment an ASN transaction arrives that indicates that the delivery needs to be auto received.</p> <p>Date Driven will look at a secondary store option (External Finisher Auto Receive number of Days) to determine how many days the transaction stays open before it is fully received. If it is set to 0, it will auto-receive on the ETA date.</p>	Not Allowed	TRANSFER_RECEIVING	Integer

Table 9–2 (Cont.) Store Admin Parameters

Options	Description	Default Value	Topic	Type
External Finisher Auto Receive Number of Days	<p>Values: 0-99</p> <p>A batch program will auto receive any external finisher deliveries with a Source Type of 'Finisher', that have not been closed x-days after the ETA date or the create date depending if the ETA date is set or not and if the auto receive external delivery parameter is set 0 means immediate receiving 1 means today (EOD) 2 means EOD tomorrow x means EOD x days starting from today</p>	0	TRANSFER_RECEIVING	Integer
Store Auto Receive	<p>Values: Not allowed / External message / Date Driven</p> <p>Not allowed: Auto receiving is not allowed for the store.</p> <p>External message: Receives the full store delivery the moment an ASN transaction arrives when the indicator on the ASN identifies this as an auto receive delivery and the Source Type is 'Store'. This parameter works with the Store Auto Receive screen.</p> <p>Date Driven: Receives the delivery automatically when the date is reached. A second options, 'Store Auto Receive Number of Days' is used to determine how many days the transaction stays open before it is fully received. If it is set to 0, it will receive immediately when the transfer is shipped. This parameter works with the Store Auto Receive screen.</p>	Not Allowed	TRANSFER_RECEIVING	Integer
Store Auto Receive Number of Days	<p>Values: 0-99</p> <p>0: immediate receiving</p> <p>1: end of day today</p> <p>2: end of day tomorrow</p> <p>X: end of day x days starting from today</p> <p>The batch program will auto receive any transfers with a Source Type of 'Store' not previously closed x-days after they have been shipped. This parameter is only used when the Store Auto Receive parameter is enabled.</p>	0	TRANSFER_RECEIVING	Integer
Store Transfer Default to ShopFloor Receive	<p>Values: Yes/No</p> <p>This parameter will determine whether the receiving will default to receive inventory into the shop floor instead of automatically receiving into the back room when the Source Type is 'Store'.</p> <p>Yes: The Transfer workflow will default to receive inventory into the shop floor when the Source Type is 'Store'. The shop floor inventory bucket will be incremented instead of the backroom bucket. If a capacity is defined for the item, the maximum shop floor quantity will equal the capacity; otherwise the shop floor will be updated to the entire receipt amount.</p> <p>No: This will default to back room and all inventory will be automatically received into the back room or delivery bay when Source Type is 'Store'. Note: With the proper permissions, the user will still have the option to receive onto the shop floor while receiving the delivery by changing the default to Shop Floor. Damaged inventory will not move to shop floor.</p>	No	TRANSFER_RECEIVING	Boolean

Table 9-2 (Cont.) Store Admin Parameters

Options	Description	Default Value	Topic	Type
Store Transfer Receive Item Capacity	<p>Values: Yes/No</p> <p>This parameter will determine whether the capacity will be considered while receiving the deliveries.</p> <p>Yes: If the value is set to YES, then while receiving and Source Type of 'Store', the capacity will be considered. For example: If capacity is 50, receipt is for 100 and Available SOH is 10 on shopfloor, then if this parameter is on and receive in shop floor is checked then 40 (un-damaged) will be moved to shop floor and rest to back room.</p> <p>No: If the value is set to NO, then while receiving the capacity will not be considered. Damaged inventory will not move to shop floor.</p>	No	TRANSFER_RECEIVING	Boolean
Warehouse Auto Receive	<p>Values: Not Allowed, External Message, Date Driven</p> <p>This parameter will drive the following functionality.</p> <p>Not Allowed will make the system work as today.</p> <p>External message will receive the full warehouse delivery the moment an ASN transaction arrives that indicates that the delivery needs to be auto received and the Source Type is 'Warehouse'.</p> <p>Date Driven will look at a secondary store option (Warehouse Auto Receive number of Days) to determine how many days the transaction stays open before it is fully received. If it is set to 0, it will auto-receive on the ETA date.</p>	Not Allowed	TRANSFER_RECEIVING	Integer
Warehouse Auto Receive Number of Days	<p>Values: 0-99</p> <p>0: immediate receiving</p> <p>1: end of day today</p> <p>2: end of day tomorrow</p> <p>X: end of day x days starting from today</p> <p>The batch program will auto receive any transfers with a Source Type of 'Warehouse' not previously closed x-days after they have been shipped. This parameter is only used when the Warehouse Auto Receive parameter is enabled.</p>	0	TRANSFER_RECEIVING	Integer

Table 9–2 (Cont.) Store Admin Parameters

Options	Description	Default Value	Topic	Type
Warehouse Default to ShopFloor Receive	<p>Values: Yes/No</p> <p>This parameter will determine whether the new receiving will default to receive inventory into the shop floor instead of automatically receiving into the back room when Source Type is 'Warehouse'.</p> <p>Yes: The Transfer Receiving workflow will default the check box to receive inventory into the shop floor when Source Type is 'Warehouse'. The shop floor inventory bucket will be incremented instead of the backroom bucket. If a capacity is defined for the item, the maximum shop floor quantity will equal the capacity; otherwise the shop floor will be updated to the entire receipt amount.</p> <p>No: The new check box will be defaulted to back room and all inventory will be automatically received into the back room or delivery bay when Source type is 'Warehouse'. Note: With the proper permissions, the user will still have the option to receive onto the shop floor while receiving the delivery by changing the default to Shop Floor. Damaged inventory will not move to shop floor.</p>	No	TRANSFER_RECEIVING	Boolean
Warehouse Receive Item Capacity	<p>Values: Yes/No</p> <p>This parameter will determine whether the capacity will be considered while receiving the deliveries.</p> <p>Yes: If the value is set to YES, then while receiving and Source Type of 'Warehouse', the capacity will be considered. For example: If capacity is 50, receipt is for 100 and Available SOH is 10 on shopfloor, then if this parameter is on and receive in shop floor is checked then 40 (un-damaged) will be moved to shop floor and rest to back room.</p> <p>No: If the value is set to NO, then while receiving the capacity will not be considered. Damaged inventory will not move to shop floor</p>	No	TRANSFER_RECEIVING	Boolean
Dispatch Validate	<p>Values: Ship Direct, Ship Submit</p> <p>Ship Direct: SIOCS will control all processes. The user will be able to go from create/edit directly to dispatch.</p> <p>Ship Submit: This option will require the user to press the Submit button, and require a specific press of the dispatch button. An additional option is that an external system will generate a dispatch message through a standard web service.</p>	Ship Direct	TRANSFER_SHIPMENT	Integer
Pre-shipment Notification	<p>Values: Yes/No</p> <p>This parameter will drive the following functionality:</p> <p>Yes: The system will publish a pre-shipment message.</p> <p>No: The system will not publish a pre-shipment message.</p>	No	TRANSFER_SHIPMENT	Boolean

Table 9-2 (Cont.) Store Admin Parameters

Options	Description	Default Value	Topic	Type
Ship to Finisher Carrier Default	<p>Values: Sender / Receiver / Third Party</p> <p>Sender: Sender will be selected for Carrier Type on BOL</p> <p>Receiver: Receiver will be selected for the Carrier type on BOL.</p> <p>Third Party: Third Party will be selected for the Carrier type on the BOL. The type (drop down) will be defaulted to "Other".</p> <p>When creating a store to Finisher transfer the Carrier Type on the BOL will default initially based upon this parameter. The user can still change this value and if so, that will be the value used on the transfer.</p>	Third Party	TRANSFER_SHIPMENT	Integer
Ship to Store Carrier Default	<p>Values: Sender / Receiver / Third Party</p> <p>Sender: Sender will be selected for Carrier Type on BOL</p> <p>Receiver: Receiver will be selected for the Carrier type on BOL.</p> <p>Third Party: Third Party will be selected for the Carrier type on the BOL. The type (drop down) will be defaulted to "Other".</p> <p>When creating a store to store transfer the Carrier Type on the BOL will default initially based upon this parameter. The user can still change this value and if so, that will be the value used on the transfer.</p>	Third Party	TRANSFER_SHIPMENT	Integer
Ship to Warehouse Carrier Default	<p>Values: Sender / Receiver / Third Party</p> <p>Sender: Sender will be selected for Carrier Type on BOL</p> <p>Receiver: Receiver will be selected for the Carrier type on BOL.</p> <p>Third Party: Third Party will be selected for the Carrier type on the BOL. The type (drop down) will be defaulted to "Other".</p> <p>When creating a store to WH transfer the Carrier Type on the BOL will default initially based upon this parameter. The user can still change this value and if so, that will be the value used on the transfer.</p>	Third Party	TRANSFER_SHIPMENT	Integer
Manifest Customer Order Deliveries	<p>Values: Yes/No</p> <p>Yes: The Manifesting system will be called.</p> <p>No: The Manifesting system will not be called.</p>	No	WEB_SERVICE_ENABLEMENT	Boolean
Manifest RTV to Supplier	<p>Values: Yes/No</p> <p>Yes: The Manifesting system will be called for return to supplier.</p> <p>No: The Manifesting system will not be called.</p> <p>Note: The interface will still need to be implemented; this just is to determine if it will be called.</p>	No	WEB_SERVICE_ENABLEMENT	Boolean
Manifest Transfer to Finisher	<p>Values: Yes/No</p> <p>Yes: The Manifesting system will be called for transfer to Finisher.</p> <p>No: The Manifesting system will not be called.</p> <p>Note: The interface will still need to be implemented; this just is to determine if it will be called.</p>	No	WEB_SERVICE_ENABLEMENT	Boolean

Table 9–2 (Cont.) Store Admin Parameters

Options	Description	Default Value	Topic	Type
Manifest Transfer to Store	<p>Values: Yes/No</p> <p>Yes: The Manifesting system will be called for transfer to store.</p> <p>No: The Manifesting system will not be called.</p> <p>Note: The interface will still need to be implemented; this just is to determine if it will be called.</p>	No	WEB_SERVICE_ENABLEMENT	Boolean
Manifest Transfer to Warehouse	<p>Values: Yes/No</p> <p>Yes: The Manifesting system will be called for transfer to warehouse</p> <p>No: The Manifesting system will not be called.</p> <p>Note: The interface will still need to be implemented; this just is to determine if it will be called.</p>	No	WEB_SERVICE_ENABLEMENT	Boolean
OMS Customer Order Delivery Validation	<p>Values: Yes/No</p> <p>Yes: When confirming the delivery, the system will make a call out to an external system (such as an OMS) to validate the delivery status and delivery quantities before completing the dispatch.</p> <p>No: external system will not be called.</p>	No	WEB_SERVICE_ENABLEMENT	Boolean
Send Event Alert External	<p>Values: Yes / No</p> <p>Yes: Notification event alerts (non ad hoc notifications) will be sent externally via web service.</p> <p>No: Notification event alerts (non ad hoc notifications) will not be sent externally. Web service is not called.</p>	No	WEB_SERVICE_ENABLEMENT	Boolean

Access Permissions

Table 9–3 Security Permissions

Permission	Topic	Usage
Access Ad Hoc Stock Count Tolerances	Admin	With this permission, the user will have access to the Ad hoc Stock Count Tolerance dialog.
Access Admin	Admin	With this permission, the user will have access to the Admin menu.
Access Auto-Receive Stores	Admin	With this permission, the user will have access to the Auto Receive Stores admin dialog.
Access Barcode Processor	Admin	With this permission, the user will have access to the Barcode Processor dialog.
Access Buddy Stores	Admin	With this permission, the user will have access to the Buddy Store dialog.
Access Carrier Services	Admin	With this permission, the user can access the Carrier Service dialog to add and edit the carrier service data.
Access Carriers	Admin	With this permission, the user can access the Carrier dialog to add or edit the carrier data.

Table 9–3 (Cont.) Security Permissions

Permission	Topic	Usage
Access Code Info	Admin	With this permission, the user can access the Code Info dialog to add, edit and delete code information.
Access Container Lookup	Admin	With this permission, the user will have access to the Container Lookups dialog.
Access Customer Order Delivery Attribute	Admin	With this permission, the user will have access to Customer Order Delivery Attributes.
Access Customer Order Picking Tolerances	Admin	With this permission, the user will have access to the Customer Order Picking Tolerance dialog.
Access Data Seed	Admin	With this permission the user will have the ability to start the data seeding job via the batch job admin.
Access Extended Attribute	Admin	With this permission, the Extended Attributes Menu option is displayed under Admin/Configuration and the user gets the ability to setup and assign extended attributes.
Access Extended Attribute Dept Assign	Admin	With this permission, the Assign Extended Attributes Menu option is displayed under Admin/Configuration and the user gets the ability to assign new extended attributes and also remove the existing assignments.
Access Extended Attribute Setup	Admin	With this permission, the Setup Extended Attributes Menu option is displayed under Admin/Configuration and the user gets the ability to view and edit extended attributes.
Access Finisher Lookup	Admin	With this permission, the user will have access to the Finisher Lookup functionality.
Access Flexible Attributes	Admin	With this permission, the user will have access to the Custom Flexible Attributes dialog and the ability to setup (Create) and maintain (Edit, Delete) flexible attributes.
Access Future Price Events	Admin	With this permission, the user will have access to Future Price Events.
Access Inventory Adjustment Reasons	Admin	With this permission, the user will have access to the Inventory Adjustment Reason admin dialog and the ability to setup and maintain inventory adjustment reason codes.
Access Inventory Management	Admin	With this permission, the user will have access to the Inventory Management.
Access Item CFAs	Admin	With this permission, the CFAs will be available on Item Detail in Item Lookup
Access Item Lookup	Admin	With this permission, the user will have access to the Item Lookup functionality.
Access Item Scan Number Lookup	Admin	With this permission, the user can access the Item Scan Number Lookup.
Access Job Admin	Admin	With this permission, the user can access the Job admin dialog.
Access Job Scheduler	Admin	With this permission, the user can access the Job scheduler dialog.

Table 9–3 (Cont.) Security Permissions

Permission	Topic	Usage
Access Lookup	Admin	With this permission, the user will have access to functionality within Lookups.
Access MPS Staged Messages	Admin	User must have this permission in order to access the MPS Staged Messages screen to view or edit the inbound and outbound messages.
Access MPS Work Types	Admin	User must have this permission in order to Access or Edit the Worker Type settings in MAF.
Access Operational Views menu	Admin	On EICS, with this permission, the operational views main menu is displayed and user is allowed to view the different operational views.
Access Package Size	Admin	With this permission the user will have access to the Package Size admin dialog.
Access Price Events	Admin	With this permission, 'View Price Events' button will be available in the Item Detail screen hence the user will be able to access to the Price History screen.
Access Printer Setup	Admin	With this permission, the user can access the printer setup dialog.
Access Product Group Schedules	Admin	With this permission the user will have access to the Product Group Schedule dialog.
Access Product Groups	Admin	With this permission, the user will have access to the admin Product Group and Product Group Component functionality
Access Quick Item Price Print	Admin	With this permission, the user can access the Print item dialog to print the tickets.
Access Reports	Admin	With this permission, the user can access the Reports dialog.
Access RFID Locator	Admin	With this permission, the user can access the RFID Locator dialog in mobile.
Access Shipment Reasons	Admin	With this permission, the user will have access to the Shipment Reason admin dialog and the ability to setup and maintain shipment reason codes.
Access Shipping Receiving	Admin	With this permission, the user will have access to functionality within Shipping/Receiving.
Access Store Administration	Admin	With this permission, the user will have access to Store Administration dialog.
Access Store Administration Default	Admin	With this permission, the user will have access to Store Administration default dialog.
Access Sub Buckets	Admin	With this permission, the user can access the Sub bucket dialog.
Access Supplier CFAs	Admin	With this permission, the CFAs will be available on Supplier Detail in Supplier Lookup.
Access Supplier Lookup	Admin	With this permission the user will have access to Supplier Lookup and the Supplier Lookup menu option will appear in the drawer (main menu).
Access System Administration	Admin	With this permission, the user will have access to the 'System Administration' dialog.
Access Technical Maintenance	Admin	With this permission, the user will have access to Technical Maintenance dialog.

Table 9–3 (Cont.) Security Permissions

Permission	Topic	Usage
Access Ticket List	Admin	With this permission, the user can access the Ticket List.
Access Transaction History	Admin	With this permission the user will have access to the Transaction History dialog.
Access Translation Setup	Admin	With this permission, the user can access the Translation Setup dialog.
Access Troubled Transaction	Admin	With this permission, the user can select the Troubled Transaction List from the Inventory Management menu.
Access UDAs	Admin	With this permission, in Item Lookup the user will be able to search for an item by a search type of UDA. Also, the UDAs will be available on Item Detail in Item Lookup.
Access Upload Ticket Templates	Admin	With this permission, the user can access the Upload Ticket Templates screen to upload the ticketing layout.
Access Warehouse Inventory	Admin	With this permission, the warehouse inventory details will be included in the Stock Locator Item Lookup section.
All Stores Product Groups	Admin	With this permission, Product Groups for All Stores can be created as well as edited. Without this permission, Product Groups cannot be created for all stores and they can only be viewed for all stores.
Allow Bulk Scan	Admin	With this permission, the user will have access to the Bulk Scan dialog. The Bulk Scan menu option will be in the footer menu of applicable transaction item list screens. The Bulk scan type will be available as a scan mode in the mode bar.
Allow Override Ticket Price	Admin	With this permission, the user can override the ticket price on the ticket detail screen.
Batch Execution Delete	Admin	With this permission, the user will be able to delete the issues in bulk Import, Transaction Execution and Data Purge tasks via Operational Issues Dialog.
Create Item Scan Number	Admin	With this permission, the user is allowed to create a new item scan number in the system.
Create Notes	Admin	With this permission, the user will be able to add notes within the notes dialog.
Create Product Group Schedules	Admin	With this permission, the user can create new Product Group Schedules.
Create Product Groups	Admin	With this permission, the user will be able to create a new Product Group.
Create Ticket	Admin	With this permission, the user is allowed to create a new ticket in the ticketing dialog.
Create Translations	Admin	With this permission, the user can create new translations.

Table 9–3 (Cont.) Security Permissions

Permission	Topic	Usage
Delete Item Scan Number	Admin	With this permission, the user is allowed to delete an existing Item Scan Number.
Delete MPS Staged Messages	Admin	User must have this permission in order to delete the inbound and outbound messages.
Delete Product Group Schedules	Admin	With this permission, the user can delete Product Group Schedules.
Delete Product Groups	Admin	With this permission, the user can delete a Product Group.
Delete Ticket	Admin	With this permission, the user is allowed to delete a ticket in the ticketing dialog.
Display Stock Locator	Admin	With this permission, the user will have access to Stock Locator within Item Lookup.
Edit Item Scan Number	Admin	With this permission, the user is allowed to edit an existing Item Scan Number. Applicable for webservice operation.
Edit Item Scan Number CDA	Admin	This is required for web service action to edit the Item Scan number CDAs.
Edit Job Schedules	Admin	With this permission the user can edit Job Schedules.
Edit Product Group Schedules	Admin	With this permission, the Product Group Schedule will be editable.
Edit Product Groups	Admin	With this permission, the user can Edit an existing Product Group which also includes adding and removing Product Group Components.
Edit Ticket	Admin	With this permission, the user can edit an existing ticket.
Operational Issues Admin access	Admin	With this permission, the user can access the Operational Issues dialog.
Print Ticket	Admin	With this permission, the user can print the tickets in the ticketing dialog.
Update Resolution Status	Admin	With this privilege the Resolve/Reset button on the Troubled Transactions List screen will be displayed and enabled.
Update UIN Status	Admin	With this permission, the user can update the status of the UIN from the history screen.
View UIN History	Admin	With this permission, the user will be able to access the UIN Lookup feature and view the history in EICS.
Access Area	Area	With this permission, the user will have access to the Area dialog.
Confirm Area	Area	With this permission, the user will be able to Confirm an Area.
Create Area	Area	With this permission, the user will be able to create Areas.
Delete Area	Area	With this permission, the user will be able to delete an Area.
Edit Area	Area	With this permission, the user will be able to edit active Areas.

Table 9–3 (Cont.) Security Permissions

Permission	Topic	Usage
Access Customer Details	Customer Order	With this permission the user will have access to the Customer Details (name, address, and so on) associated with the customer order.
Access Customer Order	Customer Order	With this permission, the user will have access to Customer Orders dialog.
Access Customer Order Delivery	Customer Order	With this permission, a user can access the Customer Order Delivery dialog.
Access Customer Order Management	Customer Order	With this permission, the user will have access to the Customer Order Management operations within the drawer/menu.
Access Customer Order Pick	Customer Order	With this permission, the user will have access to the Customer Order Picking dialog.
Access Customer Order Reverse Pick	Customer Order	With this permission, the user will have access to the Customer Order Reverse Picking dialog.
Cancel Submit Customer Order Delivery	Customer Order	With this permission, the user will be able to Cancel Submit a "Submitted" status Customer Order Delivery that is a "web order."
Confirm Customer Order Pick	Customer Order	With this permission, the user can Confirm a customer order pick.
Confirm Customer Order Reverse Pick	Customer Order	With this permission, the user will be able to Confirm a customer order reverse pick.
Create Customer Order Delivery	Customer Order	With this permission, the user can create a new delivery for a Customer Order that is a "web order". Used in conjunction with Edit Customer Order Delivery for Shipment or Edit Customer Order Delivery for Pickup permission.
Create Customer Order Pick	Customer Order	With this permission, the user will be able to create customer order picks. Picks can be created from within a Customer Order (for a single customer order pick). Picks can be created from within Customer Order Picking.
Create Customer Order Reverse Pick	Customer Order	With this permission, the user will be able to create customer order reverse picks.
Delete Customer Order Delivery	Customer Order	With this permission, the user will be able to delete a customer order delivery that is a "web order".
Delete Customer Order Pick	Customer Order	With this permission, the user will be able to delete a customer order pick.
Delete Customer Order Reverse Pick	Customer Order	With this permission, the user will be able to delete a customer order reverse pick.
Dispatch Customer Order Delivery	Customer Order	With this permission, the user can Dispatch a Customer Order Delivery that is a "web order".

Table 9–3 (Cont.) Security Permissions

Permission	Topic	Usage
Dispatch Incomplete Customer Order Delivery	Customer Order	<p>When dispatching a delivery that requires full delivery (Allow Partial Delivery = 'No'), the entire delivery must be delivered in full.</p> <p>With this permission, the user will get a warning message and will be able to continue the dispatch without full delivery.</p> <p>Without this permission the delivery must be in full.</p>
Edit Customer Order BOL	Customer Order	<p>With this permission, the user will be able to edit the details of the Bill of Lading associated with a customer order delivery. This is done in the Edit Delivery screen.</p> <p>User must also have Edit Customer Order Delivery permission.</p>
Edit Customer Order CFA	Customer Order	With this permission, the user will be able to capture CFAs for a customer order.
Edit Customer Order Delivery	Customer Order	With this permission, the user can edit an existing delivery for a Customer Order that is a "web order".
Edit Customer Order Delivery Attribute	Customer Order	With this permission, the user can edit the Customer Order Delivery Attributes.
Edit Customer Order Delivery CFA	Customer Order	With this permission, the user will be able to capture CFAs for a Customer Order Delivery
Edit Customer Order Delivery for Pickup	Customer Order	<p>With this permission, the user will be able to create Customer Order Deliveries which are of type store pickup.</p> <p>Used in conjunction with the Create Customer Order Delivery permission.</p>
Edit Customer Order Delivery for Shipment	Customer Order	<p>With this permission, the user will be able to create Customer Order Deliveries which are of type store shipment.</p> <p>Used in conjunction with the Create Customer Order Delivery permission.</p>
Edit Customer Order Pick	Customer Order	With this permission, the user will be able to edit active customer order picks.
Edit Customer Order Pick CFA	Customer Order	With this permission, the user will be able to capture CFAs for a Customer Order Pick.
Edit Customer Order Reverse Pick	Customer Order	With this permission, the user will be able to edit active reverse picks
Edit Customer Order Reverse Pick CFA	Customer Order	With this permission, the user will be able to capture CFAs for a Customer Order Reverse Pick
Edit Quantity Delivery	Customer Order	<p>With this permission, the user will be able to tap on the item quantity and the quantity widget will open to edit the quantity.</p> <p>User must also have Edit Customer Order Delivery permission as well.</p> <p>Without this permission, the quantity is not editable via the manual dialog and only scanning is allowed.</p>

Table 9–3 (Cont.) Security Permissions

Permission	Topic	Usage
Edit Quantity Picking	Customer Order	<p>With this permission, the user will be able to tap on the item quantity and the quantity widget will open to edit the quantity.</p> <p>User must also have Edit Customer Order Pick permission.</p> <p>Without this permission, the quantity is not editable via the manual dialog and only scanning is allowed.</p>
Edit Quantity Reverse Picking	Customer Order	<p>With this permission, the user will be able to tap on the item quantity and the quantity widget will open to edit the quantity.</p> <p>User must also have Edit Customer Order Reverse Pick permission.</p> <p>Without this permission, the quantity is not editable via the manual dialog and only scanning is allowed.</p>
Item Substitution For Picking	Customer Order	<p>With this permission, the user will have access to the Item Substitution dialog within Customer Order Picking.</p>
Reject Customer Order	Customer Order	<p>With this permission, the user will be able to Reject a Customer Order.</p>
Submit Customer Order Delivery	Customer Order	<p>With this permission, the user will be able to Submit a Customer Order Delivery that is a “web order”.</p> <p>Used in conjunction with Modify Customer Order Delivery permission.</p>
View Customer Order BOL	Customer Order	<p>With this permission, the user can access and view the details of the Bill of Lading associated with a customer order delivery.</p>
Access Adjust Container DSD Receiving	DSD Receiving	<p>With this permission, the user will be able to adjust the container in a delivery.</p>
Access Confirm Container DSD Receiving	DSD Receiving	<p>With this permission, the user can confirm the container receipt from the supplier.</p>
Access Confirm DSD Receipt	DSD Receiving	<p>With this permission, the user will be able to confirm the Direct store delivery.</p>
Access Create Container	DSD Receiving	<p>With this permission, the user can create a new container in the DSD receipt.</p>
Access Delete Container	DSD Receiving	<p>With this permission, the user can delete a container.</p>
Access Delete Receipt	DSD Receiving	<p>With this permission, the user will be able to delete a direct store delivery.</p>
Access Document DSD Receiving	DSD Receiving	<p>With this permission, the user will be able to select the PO to apply items on the receipt.</p> <p>User must also have Edit container and Modify container permissions in order to do this operation.</p>
Access DSD Receiving	DSD Receiving	<p>With this permission, the user will have access to the DSD Receiving dialog.</p>
Access DSD Receiving Ext. Attribute	DSD Receiving	<p>With this permission, the user will be able to access the DSD Receiving Ext. Attributes.</p>

Table 9–3 (Cont.) Security Permissions

Permission	Topic	Usage
Access Purchase Order	DSD Receiving	With this permission, the user will be able to access the Purchase Orders.
Access Reject Delivery	DSD Receiving	With this permission, the user will be able to reject a direct store delivery.
Activate Container Edits	DSD Receiving	User needs this permission combined with the other respective permission(s) to update any information on the container.
Add Unexpected Item	DSD Receiving	With this permission, the user will be able to add the unexpected items to the container.
Allow DSD Receiving With PO	DSD Receiving	With this permission, the user will be able to create a receipt against a PO but without ASN.
Allow DSD Receiving Without PO	DSD Receiving	With this permission, the user will be able to create a receipt without PO.
Allow Over Receiving for DSD Receiving	DSD Receiving	With this permission, the user will be able to do over receiving.
Allow Receiving Damages	DSD Receiving	With this permission, the user will be able to receive damaged items and make all remaining quantity to be received as damaged. User must also have Edit container and Modify container permissions in order to do this operation.
Default Qty in All Containers	DSD Receiving	With this permission, the user will be able to default the received quantity for all the containers in the delivery
Default Qty in Container	DSD Receiving	With this permission, the user will be able to default the received quantity with the remaining quantity in the container. User must also have permission to 'Modify container' in order to do this operation.
Display Expected Quantity	DSD Receiving	With this permission, the user will be able to view the expected quantity during the receipt.
Edit Container	DSD Receiving	With this permission, the user can edit the container line items, modify the line item quantities or delete the item. User must also have permission to 'Modify container' in order to do this operation.
Edit Container CFA	DSD Receiving	With this permission, the user will be able to capture CFAs for a Container in DSD Receiving.
Edit Container Info DSD Receiving	DSD Receiving	With this permission, the user will be able to edit the container information. User must also have permission to 'Modify container' in order to do this operation.
Edit Delivery CFA	DSD Receiving	With this permission, the user will be able to capture CFAs for a DSD.
Edit Delivery Info	DSD Receiving	With this permission, the user will be able to edit the delivery information.
Edit DSD Receiving Ext. Attribute	DSD Receiving	With this permission, the user will be able to edit the DSD Receiving Ext. Attributes.

Table 9–3 (Cont.) Security Permissions

Permission	Topic	Usage
Edit Quantity	DSD Receiving	With this permission, the user will be able to edit the quantity of the item in the delivery. User must also have Edit container and Modify container permissions in order to do this operation.
Override Not After Date Check	DSD Receiving	With this permission, the user can override the not after date check. This permission will allow the user to receive delivery where the receipt date passed the not after date in PO.
Override Supplier Discrepancies	DSD Receiving	With this permission, the user will be able to override the supplier discrepancies when quantity is validated.
Receive Direct Delivery on Shop Floor	DSD Receiving	With this permission, the user will be able to receive delivery on shop floor directly.
Access Inventory Adjustment	Inventory Adjustments	With this permission a user will have access to the Inventory Adjustment dialog.
Access Inventory Adjustment Attribute	Inventory Adjustments	With this permission a user will have access to the Inventory Adjustment Attributes.
Complete Inventory Adjustment	Inventory Adjustments	With this permission, the user can Confirm an inventory adjustment. User must also have data permissions for each adjustment reason on the adjustment.
Create Inventory Adjustment	Inventory Adjustments	With this permission, the user can create a new inventory adjustment. This permission must exist as well for a user to copy a “completed” inventory adjustment. User must also have data permissions for each adjustment reason on the adjustment.
Delete Inventory Adjustment	Inventory Adjustments	With this permission, the user will be able to delete an inventory adjustment. User must also have data permissions for each adjustment reason on the adjustment.
Edit Inventory Adjustment	Inventory Adjustments	With this permission, the user will be able to edit existing inventory adjustments. User must also have data permissions for each adjustment reason on the adjustment.
Edit Inventory Adjustment Attribute	Inventory Adjustments	With this permission, the user will be able to edit existing inventory adjustment attributes.
Edit Inventory Adjustment CFA	Inventory Adjustments	With this permission, the user will be able to capture CFAs for an inventory adjustment.
Edit Quantity	Inventory Adjustments	With this permission, the user will be able to tap on the item quantity and the quantity widget will open to edit the quantity. User must also have Edit Inventory Adjustment permission as well as data permissions for each adjustment reason on the adjustment.
Access Item Basket	Item Basket	With this permission, the user will have access to the Item Basket dialog.

Table 9–3 (Cont.) Security Permissions

Permission	Topic	Usage
All Stores Item Basket	Item Basket	<p>With this permission, Item Baskets for All Stores can be created as well as edited.</p> <p>Without this permission, Item Baskets cannot be created for all stores and they can only be viewed for all stores.</p>
Confirm Item Basket	Item Basket	With this permission, the user will be able to Confirm an Item Basket.
Create Item Basket	Item Basket	With this permission, the user will be able to create Item Baskets.
Delete Item Basket	Item Basket	With this permission, the user will be able to delete an Item Basket.
Edit Item Basket	Item Basket	With this permission, the user will be able to edit active Item Baskets.
Edit Item Basket CFA	Item Basket	With this permission, the user will be able to capture CFAs on an Item Basket.
Edit Quantity Item Basket	Item Basket	<p>With this permission, the user will be able to tap on the item quantity and the quantity widget will open to edit the quantity.</p> <p>User must also have Edit Item Basket permission.</p> <p>Without this permission, the quantity is not editable via the manual dialog and only scanning is allowed.</p>
Import Item Basket	Item Basket	With this permission, the user will have the Import Item Basket menu option within an Item Basket on mobile.
Investigate Item Basket	Item Basket	<p>With this permission, the investigate menu option in item lookup will be available and the user will be able to add an item to an existing item basket, or create a new item basket if one doesn't exist for investigation in item lookup.</p> <p>Without this permission, the investigate menu option in item lookup will not be available.</p>
Access Notifications	Notifications	<p>With this permission, the bell notification icon will be displayed in the drawer/menu as well as on the Open Transactions header.</p> <p>The view on the notification will also be displayed.</p>
Customer Order Pick Reminder	Notifications	With this permission, the user will be notified, if the pick list has been created but not actioned
Customer Order Receipt	Notifications	With this permission, the user will be notified when customer orders are received.
Customer Order Reminder	Notifications	With this permission, the user will be notified when the customer order has not been fulfilled.
Damaged Delivery	Notifications	With this permission, the user will be notified when the delivery includes damaged items.
Display Notification Warning	Notifications	With this permission, the user will receive a notification warning when a new notification is created / inserted into the system.
Finisher Delivery Unable to Auto-Receive	Notifications	With this permission, the user will receive a notification warning when a finisher delivery is not auto received.

Table 9–3 (Cont.) Security Permissions

Permission	Topic	Usage
Finisher UIN Discrepancy	Notifications	With this permission, the user will be notified when a finisher return received quantity does not match the number of serial numbers on the return. Without this permission, the user will not be notified.
Misdirected Container	Notifications	With this permission, the user will be notified when a container has been received in another location.
New Customer Order	Notifications	With this permission, the user will be notified when customer orders are created.
New Customer Order Reverse Pick	Notifications	With this permission, the user will be notified when a new cross channel customer order reverse picks arrives.
Over Received Quantity	Notifications	With this permission, the user will be notified when the number of pre-populated serial numbers exceeds the received quantity. Without this permission, the user will not be notified.
Receiving UIN Discrepancy	Notifications	With this permission, the user will be notified when the number of pre-populated serial numbers does not match the received quantity. Without this permission, the user will not be notified.
RTV Request Expiration Approaching	Notifications	With this permission, the user will be notified if the supplier return request expiration date is approaching.
RTV Unavailable request quantity	Notifications	With this permission, the user will be notified if there is not enough inventory in the unavailable bucket to send back to supplier from a return request.
Shipped Delivery Overdue	Notifications	With this permission, the user will be notified when the shipped delivery has not been received and has passed the expected date.
Store Delivery Unable to Auto-Receive	Notifications	With this permission, the user will be notified when a store delivery has discrepancies and cannot be auto received.
Store Receiving Over/Under	Notifications	With this permission, the user will be notified when a store transfer has over/under received quantities.
Transfer Request	Notifications	With this permission, the user will be notified when a transfer request is created.
Transfer Request Approved	Notifications	With this permission, the user will be notified when a transfer request is approved.
Transfer Request Expiration Approaching	Notifications	With this permission, the user will be notified when a transfer request has not been approved and the request is about to expire. This is based on the not after date set.
Transfer Request Rejected	Notifications	With this permission, the user will be notified when a transfer request is rejected.

Table 9–3 (Cont.) Security Permissions

Permission	Topic	Usage
Transfer Unavailable Request Quantity	Notifications	With this permission, the user will be notified when the requested quantity is no longer available at the requested source location.
UIN Items on Incoming ASN Failed	Notifications	With this permission, the user will be notified if an Auto Generated SN item is on the ASN with pre-generated numbers when processing thru the RIB. Without this permission, the user will not be notified.
Unexpected UIN (Store Changed)	Notifications	With this permission, the user will be notified when UINs are discovered at a store where they should not be. Without this permission, the user will not be notified.
Warehouse Delivery Unable to Auto-Receive	Notifications	With this permission, the user will be notified when the delivery includes pre-populated serial numbers and cannot be automatically received.
Send Transaction Notification	Open Transactions	With this permission the user will be able to send a notification. This is done from within the Open Transactions dialog; the user will be able to swipe an open transaction and send a notification.
View Transactions	Open Transactions	With this permission the user will have the potential to view all of the open transactions for the user's store (depending on data permissions). Without this permission, the Open Transactions dialog will still display (just without the transactions listed); however the list of open transactions will be empty.
Access Out of Stock Lookup	Operational Views	On EICS, with this permission, the Out of Stock operational view menu is displayed and user is allowed to view the out of stock operational view.
Access New Received Items	Operational Views	On EICS, with this permission the user will be able to access the Access New Items view in Operational Views.
Access Expiring Items Lookup	Operational Views	On EICS, with this permission the user will be able to access the Expiring Items view in Operational Views.
Access Stock Counts - Ready to Authorize	Operational Views	On EICS, with this permission the user will be able to access the Stock Counts - Ready to Authorize view in Operational Views.
Access Shopfloor Out of Stock	Operational Views	On EICS, with this permission the user will be able to access the Access Shopfloor Out of Stock view in Operational Views.
Accept RTV	RTV	With this permission, the user will be able to approve a return request. User must also have data permissions for each return reason on the return.
Access RTV	RTV	With this permission, a user will have access to the RTV dialog and the RTV menu option will appear in the Drawer.

Table 9–3 (Cont.) Security Permissions

Permission	Topic	Usage
Activate RTV Edits	RTV	User is required to have Activate RTV Edits permission in order for Edit RTV or Edit RTV Info to activate. That is, the changes made on the RTV, because the user had Edit RTV and Edit RTV Info permissions, cannot be committed unless the user has Activate RTV Edits permission.
Add Items To RTV	RTV	With this permission, the user will be able to add items to a return. User must also have Modify RTV and Edit RTV permissions as well as data permissions for each return reason on the RTV
Close RTV	RTV	With this permission, the user will be able to close an RTV. User must also have data permissions for each return reason on the return.
Create RTV	RTV	With this permission, the user can create a new return. User must also have data permissions for each return reason on the return.
Delete RTV	RTV	With this permission, the user can delete a return. User must also have data permissions for each return reason on the return.
Edit Quantity	RTV	With this permission, the user will be able to tap on the item quantity and the quantity widget will open to edit the quantity. User must also have Modify RTV and Edit RTV permissions as well as data permissions for each return reason on the RTV. Without this permission, the quantity is not editable via the manual dialog and only scanning is allowed.
Edit RTV	RTV	With this permission, the user will be able to edit existing RTV like line item details, qty, and so on. User must also have data permissions for each Return reason on the RTV.
Edit RTV CFA	RTV	With this permission, the user will be able to capture CFAs for an RTV document.
Edit RTV Info	RTV	With this permission, the user will be able to edit the header information of an RTV.
Reject RTV	RTV	With this permission, the user will be able to reject a return request. User must also have data permissions for each return reason on the return.
Access RTV Shipment	RTV Shipment	With this permission, the user can access shipments from RTV requests. Without this permission, the user will not be able to access the shipments from RTV requests.
Activate RTV Shipment Container Edits	RTV Shipment	With this permission, the user will be allowed to commit any changes made to the shipment.

Table 9–3 (Cont.) Security Permissions

Permission	Topic	Usage
Add Unexpected Items to RTV Shipment	RTV Shipment	With this permission, the user will be allowed to add items that are not present in the RTV Document, into the shipment. User must also have Modify Container and Edit Container permission as well as data permissions for each return reason on the container.
Adjust Carrier	RTV Shipment	With this permission, the user will be able to update the BOL details of a shipment even after at least one container has been confirmed.
Adjust Container RTV Shipment	RTV Shipment	With this permission, the user will be allowed to bring the container back to editable status. User must also have data permissions for each return reason on the container.
Allow over shipping RTV Shipment	RTV Shipment	With this permission, the user will be allowed to go over Approved quantity in the RTV document User must also have Modify Container and Edit Container permission as well as data permissions for each return reason on the container. Without this permission, the user will not be allowed to enter qty more than Approved qty.
Cancel Submit RTV Shipment	RTV Shipment	With this permission, the user can cancel submit RTV shipments.
Close RTV Shipment	RTV Shipment	With this permission, the user can close RTV shipments. Without this permission, the user will not be able to close RTV shipments.
Confirm RTV Shipment Container	RTV Shipment	With this permission, the user can confirm containers in the shipments. User must also have data permissions for each return reason on the container.
Create RTV Shipment	RTV Shipment	With this permission, the user can create shipments for RTV requests.
Create RTV Shipment Container	RTV Shipment	With this permission, the user will be allowed to create a container for the shipment.
Default Items to RTV Shipment	RTV Shipment	With this permission, the user will be allowed to add items from the RTV document into shipment. User must also have data permissions for each return reason on the shipment. Without this permission, the user will not be allowed to add items from the RTV document into shipment
Delete RTV Shipment	RTV Shipment	With this permission, the user can delete RTV shipments.
Delete RTV Shipment Container	RTV Shipment	With this permission, the user can delete containers in the shipments. User must also have data permissions for each return reason on the container.
Dispatch Shipment	RTV Shipment	With this permission, the user can dispatch RTV shipments.

Table 9–3 (Cont.) Security Permissions

Permission	Topic	Usage
Edit Container CFA	RTV Shipment	With this permission, the user will be able to capture CFAs for a container in RTV shipment.
Edit Container RTV Shipment	RTV Shipment	<p>With this permission, the user will be allowed to edit the line item details, update qty, remove item, restore item, cancel the current edits, and so on,</p> <p>User must also have Modify Container permission as well as data permissions for each return reason on the container.</p> <p>Without this permission, the user will not be allowed to edit any line item details, update qty, remove item, restore item, cancel the current edits, and so on.</p>
Edit Quantity	RTV Shipment	<p>With this permission, the user will be able to tap on the item quantity and the quantity widget will open to edit the quantity.</p> <p>User must also have Modify Container and Edit Container permission as well as data permissions for each return reason on the container.</p> <p>Without this permission, the quantity is not editable via the manual dialog and only scanning is allowed.</p>
Edit RTV Container Info	RTV Shipment	<p>With this permission, the user will be allowed to edit the container header details.</p> <p>User must also have Activate Container Edits permission.</p>
Edit RTV Shipment Attribute	RTV Shipment	With this permission, the user will be allowed to edit the RTV Shipment Attributes.
Edit RTV Shipment BOL	RTV Shipment	With this permission, the user will be allowed to edit the shipment BOL details.
Edit RTV Shipment Info	RTV Shipment	With this permission, the user will be allowed to edit the shipment header details.
Edit Shipment CFA	RTV Shipment	With this permission, the user will be able to capture CFAs on an RTV shipment.
Submit RTV Shipment	RTV Shipment	With this permission, the user can submit RTV shipments.
View RTV Shipment BOL	RTV Shipment	With this permission, the user will be allowed to view the shipment BOL details.
Access Role Maintenance	Security	User must have this permission in order for the Role Maintenance menu option to be available under Security in EICS.
Access Security	Security	With this permission the user will have access to the Security dialog in EICS.
Access User Maintenance	Security	User must have this permission in order for the User Assignment menu option to be available under Security in EICS.
Delete Role	Security	User must have this permission in order to delete roles.
Delete User	Security	User must have this permission in order to delete user profiles.

Table 9–3 (Cont.) Security Permissions

Permission	Topic	Usage
Edit User	Security	User must have this permission in order to assign roles and stores to a user.
Access Scan List	Shelf Replenishment	With this permission, the user will have access to Item Scan List dialog.
Access Shelf Adjustment	Shelf Replenishment	With this permission, the user will have access to Shelf Adjustment dialog.
Access Shelf Replenishment	Shelf Replenishment	With this permission, the user will have access to the in-store replenishment dialog.
Confirm Shelf Adjustment	Shelf Replenishment	With this permission, the user can confirm the shelf adjustment.
Confirm Shelf Replenishment	Shelf Replenishment	With this permission, the user can confirm the replenishment pick.
Create Scan List	Shelf Replenishment	With this permission, the user can create a new item scan list. User must also have data permissions for each scan list type to create a new scan list of that type.
Create Shelf Adjustment	Shelf Replenishment	With this permission, the user can create a new shelf adjustment.
Create Shelf Replenishment	Shelf Replenishment	With this permission, the user can create a new shelf replenishment pick. User must have the data permission for each shelf replenishment pick type to do this operation.
Default Shelf Replenishment Quantity	Shelf Replenishment	With this permission, the user can default the quantity on replenishment pick. The user must also have the Edit replenishment permission to do this operation.
Delete Scan List	Shelf Replenishment	With this permission, the user will be able to delete a scan list.
Delete Shelf Adjustment	Shelf Replenishment	With this permission, the user can delete the shelf adjustment.
Delete Shelf Replenishment	Shelf Replenishment	With this permission, the user can delete the shelf replenishment pick.
Edit Scan List	Shelf Replenishment	With this permission, the user will be able to edit and save the scan list.
Edit Scan List CFA	Shelf Replenishment	With this permission, the user will have the ability to capture CFAs for a Scan List.
Edit Scan List Quantity	Shelf Replenishment	With this permission, the user will be able to edit the quantity on the UI using the widget. User must also have the Edit Scan List permission to do this.
Edit Shelf Adjustment	Shelf Replenishment	With this permission, the user can edit and save the shelf adjustment.
Edit Shelf Adjustment CFA	Shelf Replenishment	With this permission, the user will have the ability to capture CFAs for a Shelf Adjustment.
Edit Shelf Adjustment Quantity	Shelf Replenishment	With this permission, the user can edit the quantity using the widget on the UI.

Table 9–3 (Cont.) Security Permissions

Permission	Topic	Usage
Edit Shelf Replenishment	Shelf Replenishment	With this permission, the user will be able to edit the existing shelf replenishment pick.
Edit Shelf Replenishment CFA	Shelf Replenishment	With this permission, the user will have the ability to capture CFAs for Replenishment Pick List.
Edit Shelf Replenishment Quantity	Shelf Replenishment	With this permission, the user can edit the quantity using the quantity widget on the UI. Without this permission, the quantity is not editable via the manual dialog and only scanning is allowed.
Replenishment Item Substitution	Shelf Replenishment	With this permission, the user can substitute the pick items. The user must also have the Edit replenishment permission to do this operation.
Access Stock Count	Stock Counts	With this permission, the user can access the Stock Counts dialog.
Access Stock Count Attribute	Stock Counts	With this permission, the Attributes tab on the Stock Counts - Item Detail screen is displayed and enabled.
Complete Child Stock Count	Stock Counts	With this permission, the user can complete the child stock count.
Confirm Authorization Stock Count	Stock Counts	With this permission, the user can confirm the authorization.
Create Ad Hoc Stock Count	Stock Counts	With this permission, the user can create a new adhoc stock count.
Delete Stock Count	Stock Counts	With this permission, the user can delete a stock count.
Edit Adhoc Stock Count	Stock Counts	With this permission, the user can edit the ad hoc stock count.
Edit Adhoc Stock Count Lock	Stock Counts	With this permission, the user will have the ability to enable and disable the Adhoc Stock count Lock for an adhoc stock count.
Edit Authorizaton Stock Count	Stock Counts	With this permission, the user can access the Stock count authorization dialog in the jet. Ability to apply late sales.
Edit Stock Count Attribute	Stock Counts	With this permission, extended attributes can be added/removed: Add Attributes and Remove Attributes (Trash can) buttons will be available on the Attributes tab of the Stock Counts - Item Detail screen.
Edit Stock Count CFA	Stock Counts	With this permission, the user will have the ability to capture CFAs in Stock Count and Recount.
Edit Stock Count Quantity	Stock Counts	With this permission, the user can edit the quantity using the quantity widget.
Edit Unit Amount Stock Count	Stock Counts	With this permission, the user is allowed to do update for the stock counts that are of type unit and amount
Edit Unit Stock Count	Stock Counts	With this permission, the user can update the stock count of unit or problem line stock count types.

Table 9–3 (Cont.) Security Permissions

Permission	Topic	Usage
Rejected Item Stock Count	Stock Counts	With this permission, the user will have access to the Rejected Items dialog.
Snapshot Stock Count	Stock Counts	With this permission, the user is allowed to take a snapshot at the master stock count level.
Snapshot Stock Count Child	Stock Counts	With this permission, the user is allowed to take the snapshot at the child stock count level.
Update Authorization Quantity	Stock Counts	With this permission, the user can update the authorization quantity and also default the last count quantity to authorized quantity while in the process of authorization.
Accept Transfer Request	Transfer	With this permission, the user will be able to accept a transfer request.
Access Transfer	Transfer	With this permission, a user will have access the transfers.
Access Transfer context	Transfer	With this permission, a user will be able to view the Context type details in a transfer.
Access Transfer Request	Transfer	With this permission, a user will have access to the Transfer dialog in the application
Approve Transfer	Transfer	With this permission, the user will be able to approve a transfer document.
Close Transfer	Transfer	With this permission, the user will be able to close a transfer.
Create Request	Transfer	With this permission, the user will be able to create a transfer request.
Create Transfer	Transfer	With this permission, the user will be able to create a transfer document.
Delete Request	Transfer	With this permission, the user will be able to delete a transfer request.
Delete Transfer	Transfer	With this permission, the user will be able to delete a transfer document.
Edit Quantity	Transfer	With this permission, the user will be able to tap on the item quantity and the quantity widget will open to edit the quantity. Without this permission, the quantity is not editable via the manual dialog and only scanning is allowed.
Edit Transfer	Transfer	With this permission, the user will be able to edit a transfer document.
Edit Transfer Request	Transfer	With this permission, the user will be able to edit a transfer request.
Edit Transfer Request CFA	Transfer	With this permission, the user will be able to capture CFAs in transfer request documents.
Reject Transfer Request	Transfer	With this permission, the user will be able to reject a transfer request.
Request Transfer	Transfer	With this permission, the user will be able to submit a transfer request.
Access Quick Receiving	Transfer Receiving	With this permission, a user will have access to Transfer Quick Receiving.

Table 9–3 (Cont.) Security Permissions

Permission	Topic	Usage
Access Transfer Receiving	Transfer Receiving	With this permission, a user will have access to Transfer Receiving.
Access Transfer Receiving Attribute	Transfer Receiving	With this permission, the Attributes tab on the Transfer Receiving Container - Item Detail screen is displayed and enabled.
Activate Container Edits	Transfer Receiving	With this permission, the user will be allowed to commit any changes made to the container. The user will be able to edit the details with the Edit permission however for the changes to be saved to the DB, the Activate Container Edits permission is needed.
Add Unexpected Item to Transfer Receiving	Transfer Receiving	<p>With this permission, the user will be allowed to receive items that are not present in the original delivery.</p> <p>User must also have Modify Container and Edit Container permission.</p> <p>Without this permission, the user will not be allowed to receive items that are not present in the original delivery.</p>
Adjust Container	Transfer Receiving	With this permission, the user will be able to bring back a confirmed container to editable status.
Confirm Container	Transfer Receiving	With this permission, the user will be able to confirm a container.
Confirm Receipt	Transfer Receiving	With this permission, the user will be able to confirm a transfer delivery.
Create Container	Transfer Receiving	With this permission, the user will be able to create a container.
Default Qty in All Containers	Transfer Receiving	With this permission, the user will be able to default the expected qty in received qty field in all the containers.
Default Quantity in Container	Transfer Receiving	<p>With this permission, the user will be able to default the expected qty in received qty field for the items in the container.</p> <p>User must also have Modify Container and Edit Container permission.</p>
Delete Container	Transfer Receiving	With this permission, the user will be able to delete a container.
Display Expected Qty	Transfer Receiving	With this permission, the user will be able to view Expected Qty of an item in the containers.
Edit Container	Transfer Receiving	<p>With this permission, the user will be allowed to edit the line item details, update qty, remove item, restore item, cancel the current edits, and so on.</p> <p>User must also have Modify Container permission in order for the changes to be committed to the DB.</p> <p>Without this permission, the user will not be allowed to edit any line item details, update qty, remove item, restore item, cancel the current edits, and so on.</p>

Table 9–3 (Cont.) Security Permissions

Permission	Topic	Usage
Edit Container CFA	Transfer Receiving	With this permission, the user will be allowed to capture CFAs in the containers of transfer deliveries.
Edit Container Info	Transfer Receiving	With this permission, the user will be allowed to edit the container header details. User must also have Modify Container permission in order for the changes to be committed to the DB.
Edit Delivery CFA	Transfer Receiving	With this permission, the user will be allowed to capture CFAs in the transfer deliveries.
Edit Quantity	Transfer Receiving	With this permission, the user will be able to tap on the item quantity and the quantity widget will open to edit the quantity. User must also have Modify Container and Edit Container permission. Without this permission, the quantity is not editable via the manual dialog and only scanning is allowed.
Edit Receiving Info	Transfer Receiving	With this permission, the user will be able to edit the header details of a transfer delivery
Edit Transfer Receiving Attribute	Transfer Receiving	With this permission, extended attributes can be added/removed: Add Attributes and Remove Attributes (Trash can) buttons will be available on the Attributes tab of the Transfer Receiving Container - Item Detail screen.
Misdirected Container	Transfer Receiving	With this permission, the user will be allowed to copy the items from a misdirected container.
Receive On Shop Floor	Transfer Receiving	With this permission, the user will be able to receive the container on the shopfloor. User must also have Modify Container and Edit Container Info permission. Without this permission, user will not be able to receive the container on the shopfloor.
Record Receipt Damages	Transfer Receiving	With this permission, the user will be able to receive damaged items in a transfer delivery.
Access Container Attribute	Transfer Shipment	With this permission, the Attributes tab on the Transfer Shipment Container - Item Detail screen is displayed and enabled.
Access Shipment	Transfer Shipment	With this permission, a user will have access to the Transfer Shipment dialog for the user in the application.
Activate Container Edits	Transfer Shipment	With this permission, the user will be allowed to commit any changes made to the shipment. The user will be able to edit the details with the Edit Container permission however for the changes to be saved to the DB, the Activate Container Edits permission is needed. Without this permission, the user will not be allowed to commit any changes made to the shipment.

Table 9–3 (Cont.) Security Permissions

Permission	Topic	Usage
Add Items with No Document	Transfer Shipment	<p>With this permission, the user will be allowed to create an adhoc document through Shipments and add items to it. This controls the visibility of 'No document' button on the Select Document screen.</p> <p>Without this permission, the user will not be allowed to create an adhoc document through shipments and add items to it.</p>
Add Unexpected Item to Transfer Shipment	Transfer Shipment	<p>With this permission, the user will be allowed to add items that are not present in the Transfer Document, into the shipment.</p> <p>User must also have Modify Container and Edit Container permissions.</p> <p>Without this permission, the user will not be allowed to add items that are not present in the Transfer document, into the shipment.</p>
Adjust Carrier	Transfer Shipment	<p>With this permission, the user will be able to update the BOL details of a shipment even after at least one container has been confirmed.</p> <p>Without this permission, the user will not be able to update the BOL details of a shipment after at least one container has been confirmed.</p>
Adjust Container	Transfer Shipment	<p>With this permission, the user will be allowed to bring the container back to editable status.</p>
Cancel Submit Shipment	Transfer Shipment	<p>With this permission, the user can cancel submit Transfer shipments.</p>
Confirm Container	Transfer Shipment	<p>With this permission, the user can confirm containers in the shipments.</p>
Create Shipment	Transfer Shipment	<p>With this permission, the user can create shipments for Transfer documents.</p> <p>Without this permission, the user will not be able to create shipments for Transfer documents.</p>
Delete Container	Transfer Shipment	<p>With this permission, the user can delete containers in the shipments.</p>
Delete Shipment	Transfer Shipment	<p>With this permission, the user can delete transfer shipments.</p>
Dispatch Shipment	Transfer Shipment	<p>With this permission, the user can dispatch shipments.</p>
Edit Container	Transfer Shipment	<p>With this permission, the user will be allowed to edit the line item details, update qty, remove item, restore item, cancel the current edits, and so on.,</p> <p>User must also have Modify Container permission.</p> <p>Without this permission, the user will not be allowed to edit any line item details, update qty, remove item, restore item, cancel the current edits, and so on.</p>

Table 9–3 (Cont.) Security Permissions

Permission	Topic	Usage
Edit Container Attribute	Transfer Shipment	With this permission, extended attributes can be added/removed: Add Attributes and Remove Attributes (Trash can) buttons will be available on the Attributes tab of the Transfer Shipment Container - Item Detail screen.
Edit Container CFA	Transfer Shipment	With this permission, the user will be able to capture CFAs in the containers of transfer shipments.
Edit Container Info	Transfer Shipment	With this permission, the user will be allowed to edit the container header details. User must also have Modify Container permission.
Edit Quantity	Transfer Shipment	With this permission, the user will be able to tap on the item quantity and the quantity widget will open to edit the quantity. User must also have Modify Container and Edit Container permission. Without this permission, the quantity is not editable via the manual dialog and only scanning is allowed.
Edit Shipment BOL	Transfer Shipment	With this permission, the user will be allowed to edit the shipment BOL details.
Edit Shipment CFA	Transfer Shipment	With this permission, the user will be able to capture CFAs in transfer shipments.
Edit Shipment Info	Transfer Shipment	With this permission, the user will be allowed to edit the shipment header details.
Select Container Document	Transfer Shipment	With this permission, the user will be allowed to select transfer documents to be added to the shipment. User must also have Modify Container and Edit Container permission.
Submit Shipment	Transfer Shipment	With this permission, the user can submit shipments.
Create UIN on the Fly	UIN	With this permission, the user is allowed to create a UIN on the fly when creating an inventory adjustment using a reason code of Disposition Movement from Out (Dist) to Available to Sell (ATS) = UIN Status in Stock. User must also have Edit Inventory Adjustment permission as well as data permissions for each adjustment reason on the adjustment.

Data Permissions

Data permissions need to be created for the following:

- Container Items Limited To
- Counting Method
- Display List Diff Types
- Inventory Adjustment Reason Code
- Item Basket Type
- Item Ticket Batch Reason
- Location Type
- Print Format Type
- Product Group Type
- Role Type
- RTV Reason Code
- RTV Shipment Reason Code
- Shelf Adjustment Type
- Shelf Replenishment Type
- Ticket Print Reason
- Transaction Type
- Transfer Shipment Reason Code

Operational Issues Screens

This chapter describes administration screens which users with System-Operator role, can view for operational issues.

The operational issues are divided into four categories.

Note: **Date search** range has been defaulted to last 14 days. Users can change the date range.

- [Bulk Data Import](#)

Scheduled background work tasks that handle importing mass data from external systems (through file or BDI). The issue counts the number of work tasks that failed.

Primary Tables: BATCH_EXECUTION, BATCH_ACTIVITY

- [Data Purge](#)

Scheduled background work tasks that archive and remove data from the database. The issue counts the number of work tasks that failed.

Primary Tables: BATCH_EXECUTION, BATCH_ACTIVITY

- [Message Processing](#)

Scheduled background work tasks that process asynchronous messages in a queue. The issue counts the number of messages that failed.

Primary Tables: MPS_STAGED_MESSAGE

- [Transactional Execution](#)

Scheduled background work tasks that execution business processes on transactional data. The issue counts the number of work tasks that failed.

Primary Tables: BATCH_EXECUTION, BATCH_ACTIVITY

Operational Issues List Screen

This screen displays the summary of operational issues for each categories.

Figure 10–1 Operational Issues List Screen

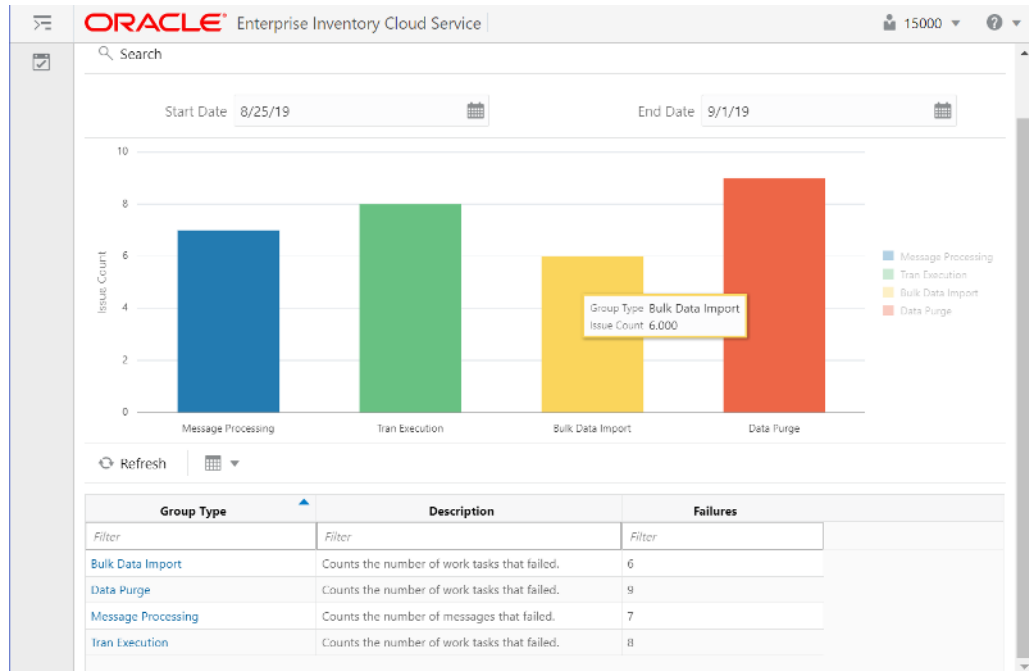

Note: On the bar graph, the **Issue Count** will be displayed when user moves the cursor to the bar graph

Operational Issues Review

This screen displays the operational issues for selected categories and date ranges. It provides following common actions in the operational issue review screens.

Operational Review Screen Actions

- **Search Filter**

Each Operational Review Screen has the Search filters.

The search filter fields would vary based on the operational groups.

The search filter fields are: Search Limit, date range.

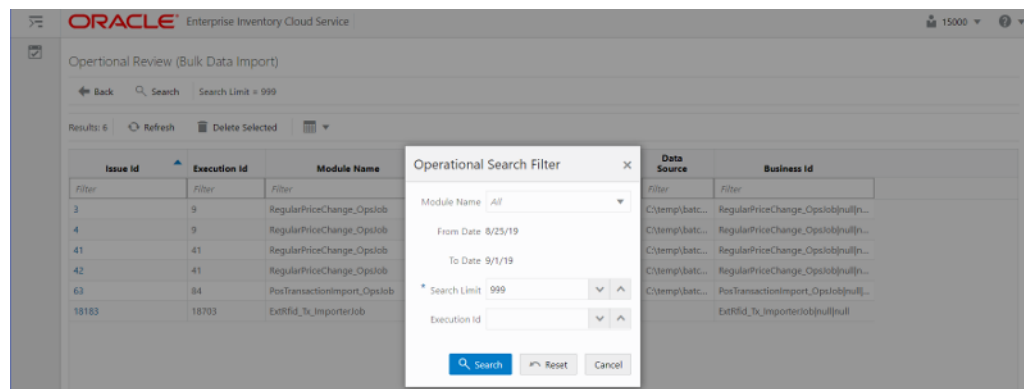
Figure 10–2 Search Filter

- **Issue Detail**

Click the Issue Link, the issue detail dialog will be displayed.

For example, the following screen shot displays the Bulk Data Import Issue Detail.

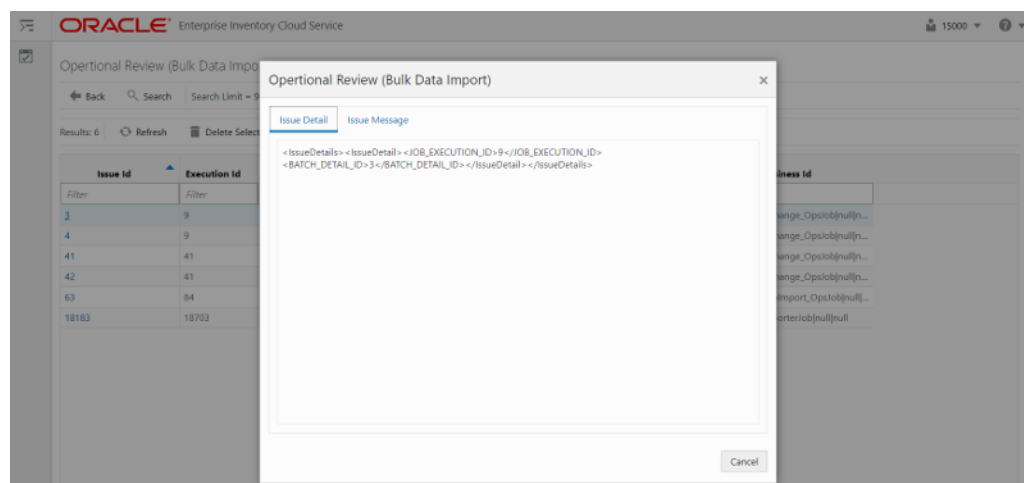
Figure 10–3 Issue Detail

- **Delete Button**

Mark the record as deleted, user needs to have **Batch Execution Delete** security permission to delete a record.

The following security permissions are required to perform delete actions.

Table 10–1 Security Permissions for Delete Actions

Operational Issue Category	Security Permissions
Bulk Data Import	Batch Execution Delete
Data Purge	Batch Execution Delete
Tran Execution	Batch Execution Delete
Message Processing	Delete MPS Staged Message

Bulk Data Import

This screen displays list of failed scheduled background work tasks that handle importing mass data from external system (through file or BDI).

Figure 10–4 Bulk Data Import Screen

Issue Id	Execution Id	Module Name	Create Date	Data Source	Business Id
3	9	RegularPriceChange_CpsJob	2019-08-26T17:32:37-05:00	C:\temp\batch\data\price-change\REG...	RegularPriceC...
4	9	RegularPriceChange_CpsJob	2019-08-26T17:32:37-05:00	C:\temp\batch\data\price-change\REG...	RegularPriceC...
41	41	RegularPriceChange_CpsJob	2019-08-26T17:32:37-05:00	C:\temp\batch\data\price-change\REG...	RegularPriceC...
42	41	RegularPriceChange_CpsJob	2019-08-26T17:32:37-05:00	C:\temp\batch\data\price-change\REG...	RegularPriceC...
63	64	PosTransactionImport_CpsJob	2019-08-26T17:32:37-05:00	C:\temp\batch\from-pos\SIMTLOG_052...	PosTransaction...
18183	18703	ExtRfd_Tx_ImporterJob	2019-08-26T17:32:37-05:00		ExtRfd_Tx_imp...

Data Purge

This screen displays a list of failed scheduled background work tasks that archive and remove data from the database.

Figure 10–5 Data Purge Screen

Issue Id	Execution Id	Module Name	Create Date	Data Source	Business Id
17787	18247	CompletedUln_PurgeJob	2019-08-26T17:32:37-05:00		CompletedUln_PurgeJob\null
17793	18253	TemporaryUln_PurgeJob	2019-08-26T17:32:37-05:00		TemporaryUln_PurgeJob\null
17794	18254	TemporaryUln_PurgeJob	2019-08-26T17:32:37-05:00		TemporaryUln_PurgeJob\null
17807	18267	TemporaryUln_PurgeJob	2019-08-26T17:32:37-05:00		TemporaryUln_PurgeJob\null
17808	18268	TemporaryUln_PurgeJob	2019-08-26T17:32:37-05:00		TemporaryUln_PurgeJob\null
17824	18284	TemporaryUln_PurgeJob	2019-08-26T17:32:37-05:00		TemporaryUln_PurgeJob\null
17825	18285	TemporaryUln_PurgeJob	2019-08-26T17:32:37-05:00		TemporaryUln_PurgeJob\null
17826	18286	TemporaryUln_PurgeJob	2019-08-26T17:32:37-05:00		TemporaryUln_PurgeJob\null
17827	18287	TemporaryUln_PurgeJob	2019-08-26T17:32:37-05:00		TemporaryUln_PurgeJob\null

Message Processing

This screen displays a list of failed background work tasks that process asynchronous messages in a queue.

Figure 10–6 Message Processing Screen

Issue Id	Execution Id	Module Name	Create Date	Data Source	Business Id
2	2	SlkCountSch	2019-08-18T06:12:35-05:00	SlkCountSch...	1
3	3	SlkCountSch	2019-08-18T06:12:35-05:00	SlkCountSch...	1
4	4	SlkCountSch	2019-08-18T06:12:35-05:00	SlkCountSch...	2
76772	76772	InvAdjust	2019-08-18T06:12:35-05:00	InvAdjustCre	SIM#76772
76773	76773	InvAdjust	2019-08-18T06:12:35-05:00	InvAdjustCre	SIM#76773

Transactional Execution

This screen displays a list scheduled background work tasks that execution business processes on transactional data.

Figure 10–7 Transactional Execution

Operational Review (Tran Execution)

Back Search Search Limit = 999

Results: 8 Refresh Delete Selected

Issue Id	Execution Id	Module Name	Create Date	Data Source	Business Id
Filter	Filter	Filter	Filter	Filter	Filter
17703	18123	GenerateUnitAmountStockCount_Opsl...	2019-08-26T17:32:37-05:00		GenerateUnitAmountStockCount...
17704	18123	GenerateUnitAmountStockCount_Opsl...	2019-08-26T17:32:37-05:00		GenerateUnitAmountStockCount...
17743	18183	GenerateUnitAmountStockCount_Opsl...	2019-08-26T17:32:37-05:00		GenerateUnitAmountStockCount...
18063	18543	GenerateUnitAmountStockCount_Opsl...	2019-08-26T17:32:37-05:00		GenerateUnitAmountStockCount...
18065	18546	GenerateUnitAmountStockCount_Opsl...	2019-08-26T17:32:37-05:00		GenerateUnitAmountStockCount...
18067	18549	GenerateUnitAmountStockCount_Opsl...	2019-08-26T17:32:37-05:00		GenerateUnitAmountStockCount...
18069	18552	GenerateUnitAmountStockCount_Opsl...	2019-08-26T17:32:37-05:00		GenerateUnitAmountStockCount...
18263	18783	GenerateUnitAmountStockCount_Opsl...	2019-08-26T17:32:37-05:00		GenerateUnitAmountStockCount...

Appendix: Run Importer Separately from EICS Job Admin

Run Data Seeding Importer Jobs

If you prefer import and load in separate processes, follow these steps:

1. EICS Disable Data Seed

Login Oracle Enterprise Inventory Cloud Service page as EICS System Ops user.

On Main Menu, Navigate to **Admin/Configuration/System Administration**.

Search for data seed on option field, change value and save the change.

Enabled Seed Foundation: set value to false

Enable Seed Store Data: set value to false

2. Start BDI Data Seeding Process Flow

Review process status.

3. Start EICS Data Seeding Importer Job

Once the BDI process flow is completed, you can load data from EICS inbound stage tables into the application tables.

To load stage data to application tables:

Login EICS as system ops user.

From Main Menu, navigate to **Admin/Technical Maintenance/Job Admin**.

Figure A–1 Job Admin

Execution ID	Job Name	Instance ID	Status	Start Time	End Time	User	Reviewed	Parameter
13045	Cleanup Shelf Replenishment Job	13045	Completed	10/15/18 1:03:51 AM	10/15/18 1:03:52 AM	<anonymous>	No	
13705	Cleanup Shelf Replenishment Job	13705	Completed	10/14/18 1:03:51 AM	10/14/18 1:03:52 AM	<anonymous>	No	
13581	Cleanup Shelf Replenishment Job	13581	Completed	10/13/18 1:03:51 AM	10/13/18 1:03:52 AM	<anonymous>	No	
13470	Cleanup Shelf Replenishment Job	13470	Completed	10/12/18 1:03:51 AM	10/12/18 1:03:52 AM	<anonymous>	No	
13355	Cleanup Shelf Replenishment Job	13355	Completed	10/11/18 1:03:51 AM	10/11/18 1:03:52 AM	<anonymous>	No	
13231	Cleanup Shelf Replenishment Job	13231	Completed	10/10/18 1:03:51 AM	10/10/18 1:03:52 AM	<anonymous>	No	
13105	Cleanup Shelf Replenishment Job	13105	Completed	10/9/18 1:03:51 AM	10/9/18 1:03:53 AM	<anonymous>	No	
13852	CleanupBatchDirectories_Opsjob	13852	Completed	10/15/18 1:03:52 AM	10/15/18 1:03:52 AM	<anonymous>	No	
13712	CleanupBatchDirectories_Opsjob	13712	Completed	10/14/18 1:03:53 AM	10/14/18 1:03:53 AM	<anonymous>	No	
13388	CleanupBatchDirectories_Opsjob	13388	Completed	10/13/18 1:03:52 AM	10/13/18 1:03:53 AM	<anonymous>	No	
13477	CleanupBatchDirectories_Opsjob	13477	Completed	10/12/18 1:03:53 AM	10/12/18 1:03:54 AM	<anonymous>	No	
13362	CleanupBatchDirectories_Opsjob	13362	Completed	10/11/18 1:03:53 AM	10/11/18 1:03:53 AM	<anonymous>	No	
13238	CleanupBatchDirectories_Opsjob	13238	Completed	10/10/18 1:03:53 AM	10/10/18 1:03:53 AM	<anonymous>	No	
13112	CleanupBatchDirectories_Opsjob	13112	Completed	10/9/18 1:03:52 AM	10/9/18 1:03:52 AM	<anonymous>	No	

On Job Admin Screen, click **Data Seed**. This will bring you to the Data Seed screen.

Figure A–2 Data Seed Screen

Start Job Cancel

* Job Name: Store

Seed Option: Seed

Store ID:

Data Set Id:

Select **Job Name** (for example Store). From Seed Option drop-down list, select **Seed**. Next, click **Start Job**.

Note: The store id input field is applicable to modules which contain store data.

To load all stores data, leave the store id as blank. To load data for a specific store, please enter the store id into the store Id field.

The Data Set Id is optional parameter for importer job to process the specified data set from bulk data interface table.

Review importer status in EICS Job Admin console.

Figure A–3 Importer Status

The screenshot shows the Oracle Enterprise Inventory Cloud Service Job Admin interface. The main content area displays a table of job execution records. The table has columns for Execution ID, Job Name, Instance ID, Status, Start Time, End Time, User, Reviewed, and Parameter. All jobs listed are in a 'Completed' status.

Execution ID	Job Name	Instance ID	Status	Start Time	End Time	User	Reviewed	Parameter
13845	Cleanup Shelf Replenishment Job	13845	Completed	10/15/18 1:03:51 AM	10/15/18 1:03:52 AM	<anonymous>	No	
13705	Cleanup Shelf Replenishment Job	13705	Completed	10/14/18 1:03:51 AM	10/14/18 1:03:52 AM	<anonymous>	No	
13581	Cleanup Shelf Replenishment Job	13581	Completed	10/13/18 1:03:51 AM	10/13/18 1:03:52 AM	<anonymous>	No	
13470	Cleanup Shelf Replenishment Job	13470	Completed	10/12/18 1:03:51 AM	10/12/18 1:03:52 AM	<anonymous>	No	
13355	Cleanup Shelf Replenishment Job	13355	Completed	10/11/18 1:03:51 AM	10/11/18 1:03:52 AM	<anonymous>	No	
13231	Cleanup Shelf Replenishment Job	13231	Completed	10/10/18 1:08:51 AM	10/10/18 1:08:52 AM	<anonymous>	No	
13105	Cleanup Shelf Replenishment Job	13105	Completed	10/9/18 1:03:51 AM	10/9/18 1:03:53 AM	<anonymous>	No	
13852	CleanupBatchDirectories_OpsJob	13852	Completed	10/15/18 1:03:52 AM	10/15/18 1:03:52 AM	<anonymous>	No	
13712	CleanupBatchDirectories_OpsJob	13712	Completed	10/14/18 1:03:53 AM	10/14/18 1:03:53 AM	<anonymous>	No	
13588	CleanupBatchDirectories_OpsJob	13588	Completed	10/13/18 1:03:52 AM	10/13/18 1:03:53 AM	<anonymous>	No	
13477	CleanupBatchDirectories_OpsJob	13477	Completed	10/12/18 1:03:53 AM	10/12/18 1:03:54 AM	<anonymous>	No	
13362	CleanupBatchDirectories_OpsJob	13362	Completed	10/11/18 1:03:53 AM	10/11/18 1:03:53 AM	<anonymous>	No	
13238	CleanupBatchDirectories_OpsJob	13238	Completed	10/10/18 1:08:53 AM	10/10/18 1:08:53 AM	<anonymous>	No	
13112	CleanupBatchDirectories_OpsJob	13112	Completed	10/9/18 1:03:52 AM	10/9/18 1:03:52 AM	<anonymous>	No	

BDI Transaction (TX) Importer Jobs

The following BDI Transaction Importer Jobs can be run as Ad hoc job if BDI process flowed failed on importer stage. The data set id is required. By default, the job schedules are setup in BDI job schedule admin console. The SIOCS/EICS job schedule for following importer jobs are disabled.

Table A–1 BDI Transaction (TX) Importer Jobs

Importer Job	Notes
Clearance Transaction Import	Clearance pricing data from producer system to receiver system. Run after initial data seed, recurring or as needed.
Price Change Transaction Import	Regular price change data from producer system to receiver system. Run after initial data seed, recurring or as needed.
Warehouse Avail Inventory Import	Current available inventory for items at warehouses from producer system to receiver system. Run after initial data seed, recurring or as needed.
Third Party Price Import	Item prices coming from an external pricing application to receiver system. Run after initial data seed, recurring or as needed.
Third Party RFID Import	RFID data coming from an external RFID application to receiver system. Run after initial data seed, recurring or as needed.

To Start an Adhoc Job, see [Batches](#) chapter [Start an Ad hoc Job](#) section for details.

Appendix: BDI Transmitter CLI Procedure - Load External Data File

Prerequisites

Following Server side installations must be installed by Oracle Retail Cloud Service Providers: EICS and BDI-SIM Edge App Job Admin.

Before you can load data files use BDI Transmitter CLI tool, you need install BDI Transmitter on Client machine. See following steps for installing BDI Transmitter CLI tools on Client side.

BDI Transmitter CLI Tool Setup

To prepare the tool for use, follow these steps.

- The bdi-cli-transmitter home directory (where the tool software package is extracted) contains 'conf' directory where the tool related configuration files will be present, and 'bin' directory where the executable to run the tool will be present.
- Configure conf/bdi-file-transmitter.properties. The following describes the properties to be configured. The properties file provides some sample values for reference to start with. The values specified in the properties file can be overridden using the command-line input options if required, when running the tool for file transmission.

Table B-1 *bdi-file-transmitter.properties*

Property	Description
source.system.name	The name of the source system or application that provides the source data to be transmitted. For example, <code>source.system.name=EXTERNAL</code>
<receiverAppName>.receiver.url	The Receiver REST service URL of the BDI Receiver application indicated by <receiverAppName> (should be in lower-case). When use BDI Transmitter CLI tool to integrate with EICS, need to set the <code>sim.receiver.url</code> . For example, if the BDI receiver application is SIM, then specify the property and value as: <code>sim.receiver.url=http://<bdi-sim-app-hostname>:<port>/sim-batch-job-admin/resources/receiver</code>

Table B-1 (Cont.) bdi-file-transmitter.properties

Property	Description
<receiverAppName>.receiver.url.useralias	Alias name for the credentials to be used to connect to the corresponding receiver service. The alias name with the credentials are stored in a wallet. <receiverAppName> should be in lowercase. Example: sim.receiver.url.useralias=simReceiverUrlUserAlias
<InterfaceModuleName>.receiver.appname	Name of the BDI receiver application for the interface module <InterfaceModuleName>. Specify the name in lowercase. Example: ExtPrice_Tx.receiver.appname=sim
<InterfaceModuleName>.dataset.type	The data set type of the data to be transmitted for the interface module identified by <InterfaceModuleName>. Valid value is FULL or PARTIAL. Example: ExtPrice_Tx.dataset.type=PARTIAL
<InterfaceModuleName>.interfaceShortNames	The interface name(s) for the corresponding interface module <InterfaceModuleName>. Multiple interface names can be specified (each separated by a comma) as multiple interfaces can be part of an interface module. The interface module name and interface names should be the same as expected by the BDI receiver application where the files are transmitted. Example: ExtPrice_Tx.interfaceShortNames=Ext_Price
<InterfaceModuleName>.<InterfaceShortName>.input.filepath	Specify the file location where the corresponding interface data files to be transmitted are present. Each interface in a interface module should have separate file locations. Example: ExtPrice_Tx.Ext_Price.input.filepath=/home/bdi/ext_price_tx/ext_price/files

Example B-1 bdi-file-transmitter.properties

```
source.system.name=ext-source

sim.receiver.url=https://<bdi-sim-app-hostname>:<port>/sim-batch-job-admin/resources/receiver

sim.receiver.url.useralias=simReceiverUrlUserAlias

interfaceModules=ExtPrice_Tx

ExtPrice_Tx.receiver.appname=sim

ExtPrice_Tx.dataset.type=PARTIAL

ExtPrice_Tx.interfaceShortNames=Ext_Price

ExtPrice_Tx.Ext_Price.input.filepath=/home/bdi/ext_price_tx/ext_price/files
```

- Run: `bdi-file-transmitter.sh -setup-credentials`.

Note: `bdi-file-transmitter.sh` will be in the 'bin' directory.

Run `-setup-credentials` to configure the BDI Receiver service user credentials. Running this command will prompt for the username and password for each of the `<receiverAppName>.receiver.url.useralias` specified in `bdi-file-transmitter.properties` file.

The credentials entered for each alias will be stored in a secure wallet and used to connect to the corresponding BDI Receiver service for transmission of files.

This is a prerequisite step to use the tool but usually a one-time setup before running `bdi-file-transmitter.sh` for transmission of files.

- Optionally, configure `conf/bdi-file-transmitter-runtime.properties` that contains parameters (described below) for performance tuning of the tool.

Start with default values as present in the properties file, analyze the performance and choose optimal values for the parameters for better performance if required. The tool will use default values for the parameters (mentioned below) when no values are specified in the properties file.

Property	Description
<code>multiple_files_process_limit</code>	The maximum number of files to process in parallel at any given time. Default value is 5.
<code>file_transmission_thread_limit</code>	The number of parallel threads to run to process a single file. Default value is 3.
<code>transmission_record_size</code>	The maximum number of records per block or chunk to transmit to the receiver service per service call. Default value is 20000.
<code>transmission_timeout</code>	The timeout in minutes for file transmission. The process will timeout and end when the file transmission is still not complete after the specified time. Default value is 300 minutes.

Tool Usage

The BDI CLI Transmitter tool is run using the shell script: `bdi-file-transmitter.sh` from the 'bin' directory.

The tool can be run in interactive and non-interactive modes.

- **Interactive Mode:** Run `bdi-file-transmitter.sh`

For user interactive mode where the program prompts for input, just run `bdi-file-transmitter.sh` with no options.

This will prompt for each input with descriptions which will be self-explanatory. The user can enter value as required or skip optional parameters. When no value is specified for optional parameters, the tool will try to use the default values as specified in the `bdi-file-transmitter.properties` file or stop executing when no default value is present.

- **Non-Interactive Mode:** Run `bdi-file-transmitter.sh [input]`

The tool can be run with the following inputs as described below.

Note: The only required input is interface module name, when the other input values are specified in `bdi-file-transmitter.properties` file.

Input	Description
<code>-m</code> or <code>--interfacemodule <interfaceModuleName></code>	(Required) The interface module name. Should be the same as the interface module name expected by the BDI receiver application.

Some examples of running the transmitter tool command-line:

```
bdi-file-transmitter.sh -m ExtPrice_Tx
```

File Processing

The BDI Transmitter tool supports transmission of flat files, for example, .csv files, in UTF-8 format. The BDI Receiver application supports only csv files. Hence the interface data files to be transmitted need to contain records with comma-separated field values.

The order of the fields in the file should be as expected by the BDI Receiver application, so that each value is inserted in the right columns of the destination interface tables. No header line should be present in the file (each line is treated as data record). Each record should be in a newline.

The interface module name and interface names for the files to be transmitted should be same as expected by the BDI Receiver application.

The transmitter tool can process a single file or a directory containing multiple files. But the tool does not process files recursively in subdirectories.

Files are processed and transmitted per interface module. Each run of processing of files of the interface module will be considered a transaction and a Transaction Id will be generated and associated to the transmission of files (at the interface module level). Files of multiple interfaces in an interface module will be part of the same transaction.

Each file transmission within a transaction will have a Transmission Id associated to it. The same transaction Id and transmission Id are sent to the BDI Receiver application, so the corresponding transmission details can be seen in the Job Admin console of the BDI Receiver application.

After successful transmission, the file will be moved to the archive directory:

```
<inputFileDirectory>/archive/<interfaceModuleName>/<transactionId>
```

For example, if the input file location is `'/home/bdi/interface/files'` and the interface module of the files is `'ExtPrice_Tx'`, and the transaction Id of the file transmission is `'Tx#1475858081837'`, then after successful transmission the file will be moved to the directory:

```
/home/bdi/interface/files/archive/ExtPrice_Tx/Tx#1475858081837.
```

Output Logs

The transmitter tool outputs messages and logs to the terminal console where the command is run.

The tool also creates a log file that contains detailed logs about the processing of files. The log will show the Transaction Id and Transmission Id of each file transmission among other details.

The log file is created in the logs directory under the tool home directory (bdi-cli-transmitter/logs).

The name of the log file will be in the format: bdi-file-transmitter_YYYY-MM-DD_HH:MM:SS, for example bdi-file-transmitter_2016-07-04_10:38:59.

Error Reprocessing

In case of any error in file processing, error in transmission of file to the receiver service, timeout of file transmission, or any other failure, the file will be moved to the 'failed' directory: <inputFileDirectory>/failed/<interfaceModuleName>/<transactionId>

For example, if the input file location is '/home/bdi/interface/files' and the interface module of the files is 'ExtPrice_Tx', and the transaction Id of the file transmission is 'Tx#1475858081837', then if the transmission of file fails, the file will be moved to the directory: /home/bdi/interface/files/failed/ExtPrice_Tx/Tx#1475858081837.

A properties file containing the input details corresponding to the failed file will be created. For example, if the file named 'ExtPrice_1.csv' has failed, then a file named 'ExtPrice_Tx_1.csv.properties' will be created in the 'failed' directory. This acts as the input context that will be used when the file is reprocessed. The user should not delete or modify this properties file, if the data file has to be re-processed with the original input context.

Due to parallel processing of files by the transmitter, there may be a scenario where some records in the file may have been transmitted successfully, but part of the file transmission may have failed. Even in this case, the entire file will be treated as failed and moved to the 'failed' directory.

Reprocessing will be at the file level and not at the block level where the transmission may have failed. In the case of partial transmission of file, the BDI Receiver application also marks the whole transmission as failed and hence the entire file can be retransmitted to be processed again by the receiver application.

To retry failed files (that did not get transmitted successfully in previous transmission) use the below command:

```
bdi-file-transmitter.sh -retry-failed <inputFileDir or inputFilePath>
```

```
For example, bdi-file-transmitter.sh -retry-failed
/home/bdi/interface/files/failed/ExtPrice_Tx/Tx#1475858081837
```

```
bdi-file-transmitter.sh -retry-failed /home/bdi/interface/files/failed/ExtPrice_
Tx/Tx#1475858081837/ExtPrice_1.csv
```

Once a file is successfully reprocessed, it will be renamed as <filename>-retransmitted. For example, ExtPrice_1.csv-retransmitted. And, the corresponding properties file will be deleted.

Schedule EICS Importer Jobs for Transmitter Loaded Data

1. Login in EICS and navigate to the Job Scheduler screen.
2. Select the desired job (for example, External Price TX Import or External RFID TX Import) from the list.
3. Edit the Job details on right panel.
4. Set required interval for execution and **Enabled** to **Yes**.
5. Click **Apply** to exit the edit mode.

6. For configuring multiple jobs on a go, repeat Step 2 for each job.
7. Click **Save** to save the current changes made on the screen.

View EICS Importer Jobs Execution Details

1. Launch EICS application, login EICS as System Ops user.
2. On Main Menu, select Admin/ Technical Maintenance/Job Admin.
3. To view detail record, select the record, then click hyperlink on the execution id. This will bring you to the Job Execution Detail screen.

Appendix: Report Formats

Reports

Table C-1 Reports

Report Name	Report Parameters
Customer Order Bin Label Report	bin_id, sim_customer_order_id, copies
Customer Order Delivery BOL Report	delivery_id, store_timezone, copies
Customer Order Delivery Report	delivery_id, store_timezone, copies
Customer Order Pick Discrepancy Report	store_timezone, pick_id, copies
Customer Order Pick Report	store_timezone, pick_id, copies
Customer Order Report	order_id, store_timezone, copies
Customer Order Reverse Pick Report	reverse_pick_id, store_timezone, copies
Direct Delivery Discrepant Items Report	receipt_id, store_timezone, copies
Direct Delivery Report	receipt_id, store_timezone, copies
Inventory Adjustment AGSN Report	Inv_Adjust_ID, copies
Inventory Adjustment Report	inv_adj_id, store_timezone, copies
Item Basket Report	Item_basket_id, store_timezone, copies
Item Detail Report	itemid, storeid, store_timezone, copies
Purchase Order Report	purchase_order_id, store_timezone, copies
Replenishment Gap Report	replenish_gap_id, copies, store_timezone, locale_id
RFID History Report	item_id, from_date, to_date, locale_id, copies
RTV Report	return_id, store_timezone, copies
Shelf Adjustment Report	shelf_adjust_id, copies, store_timezone
Shelf Replenishment Report	shelf_replenish_id, store_timezone, copies
Stock Count All Location Report	store_id, stock_count_id, copies
Stock Count Export Report [XML Format]	stock_count_id, copies
Stock Count Rejected Item Report	store_id, copies

Table C-1 (Cont.) Reports

Report Name	Report Parameters
Stock Count Report	stock_count_id, location_id, store_timezone, phase, copies
Transfer Delivery AGSN Report	carton_ID, copies
Transfer Delivery Exception Report	delivery_id
Transfer Delivery Label	carton_id
Transfer Delivery Report	delivery_id
Transfer Report	transfer_id, store_timezone, copies
Transfer Shipment BOL Report	shipment_id, store_timezone, copies
Transfer Shipment Carton Report	store_timezone, carton_id, copies
Transfer Shipment Report	shipment_id, copies, store_timezone
Transfer Shipping Label	carton_id
Vendor Delivery AGSN Report	carton_ID, copies
Vendor Delivery Label	carton_id, locale_id
Vendor Shipment BOL Report	store_timezone, ship_number, copies
Vendor Shipment Carton Report	store_timezone, carton_id, copies
Vendor Shipment Report	store_timezone, ship_number, copies
Vendor Shipment Label	carton_id, copies

Report Formats

The following section describes the report formats.

Figure C-1 Customer Order Bin Label Report

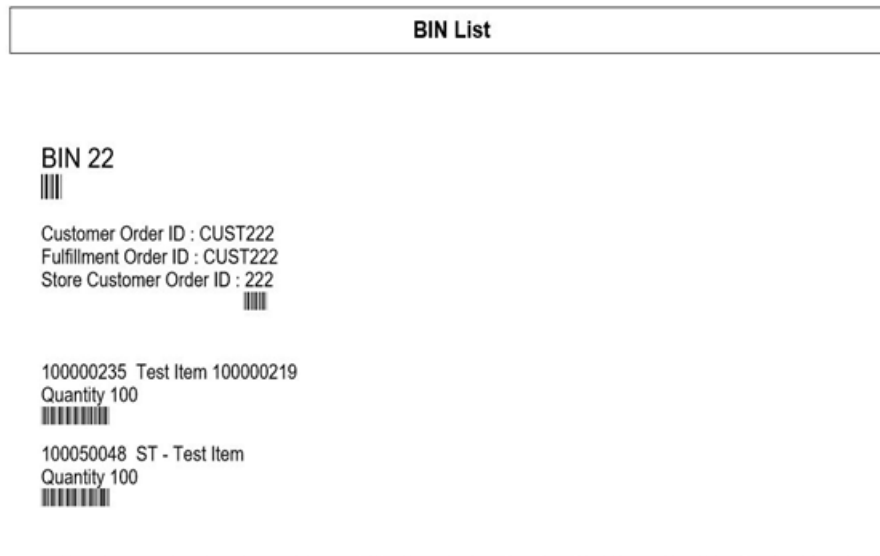

Figure C-2 Customer Order Delivery BOL Report

Customer Order Delivery BOL Report						
BOL ID:	1158	Create Date:	08/09/2017			
Delivery ID:	274					
Customer Order ID:	New					
Item	Description	Substitute	UOM	Qty	Price	Amount
SIM_107	SIM_107		EA	3	125	375
Delivery Charge					USD8.99	
Total Lines					1	
Legalase Fine Print						
Comments						
Printed: 1/8/2018			Page Number: 1			

Figure C-3 Customer Order Delivery Report

Customer Order Delivery Report						
Customer Order Id:	New	Reservation Type:	Web Order	Release Date:	08/08/2017	
		Comments:	Testing the External Comments. Do they work?	Delivery Date:	08/09/2017	
Item	Description	UOM	Order Qty	Delivered Qty	Canceled Qty	Substitute
SIM_107	SIM_107	EA	3	3	0	
Printed: 1/4/2018			Page Number: 1			

Figure C-4 Customer Order Pick Discrepancy Report

Customer Order Pick Discrepancy Report

Store: 1511 - Phoenix Pick Create Date: 12/19/2017
 Pick ID: 1086 Pick Create User: QAADMIN
 Pick Status: In Progress

Item	Description	Store Customer Order ID	Bin ID	Fulfillment ID	UOM	Pack Size	Old Pick Qty	Adjusted Pick Qty
100005016	Signal booster	301	142	LG1	EA	1	2	0

Printed: 1/4/2018 Page Number: 1

Figure C-5 Customer Order Pick Report

Customer Order Pick Report

Store: 1111 - Charlotte * Pick Create Date: 12/19/2017
 Pick ID: 1087 Pick Create User: qaadmin
 Pick Status: New Pick Complete Date:
 Pick Complete User:

Item	Description	Store Customer Order ID	Bin ID	Fulfillment ID	UOM	Pack Size	Suggested Pick Qty	Actual Pick Qty	Substitute
100005016	Signal booster	1486		PERF_CUS_E XT1486	EA	1	10		

Printed: 1/4/2018 Page Number: 1

Figure C-6 Customer Order Report

Customer Order Report									
Store:	1111	Create Date:	2017-07-19T13:29:	Delivery Type:	Ship To Customer				
Store Customer Order Id:	404	Release Date:	22.000-07:00	Carrier:	Other				
Customer Order Id:	test1	Delivery Date:	2017-08-13T13:13:	Service:	Other				
Fulfillment Order Id:	test1		12.000-07:00						
			2017-08-13T13:13:						
			12.000-07:00	Allow Partial Delivery:	Yes				
Status:	Completed								
Reservation Type:	Web Order								
Comments:	Testing the External Comments. Do they work?								

Item	Description	UOM	Order Qty	Picked Qty	Delivered Qty	Canceled Qty	Last Update Date	Comments	Substitute
100005016	Signal booster	EA	20	20	20	0	2017-08-11T10:14:00.000-07:00	I'm testing the item comments.	

Printed: 1/4/2018 Page Number: 1

Figure C-7 Customer Order Reverse Pick Report

Customer Order Reverse Pick Report									
Store:	1511	Order Status:	In Progress						
Reverse Pick ID:	501	Reverse Pick Status:	Canceled						
Store Customer Order ID:	63	Reservation Type:	Web Order	Comments:	Testing the External Comments. Do they work?				
Customer Order ID:	CC2	Reverse Pick Create Date:	2017-06-29T11:16:48.000-07:00						
Fulfillment Order ID:	CC2								

Item	Description	UOM	Order Qty	Picked Qty	Delivered Qty	Canceled Qty	Sugg. Reverse Qty	Qty	Substitute
100005013	Induction Test Item	EA	1	1	0	0	0	0	

Printed: 1/4/2018 Page Number: 1

Figure C-8 Direct Delivery Discrepant Items Report

Direct Delivery Discrepant Items Report
--

Supplier: 6100 - Local Grocery Supplier #2
Store: 1141 - Nashville
Delivery/ASN: DQ3
PO Number: 23456 ;

Container ID: 220						
Status: Received						
Item	Description	UOM	Pack Size	Expected	Quantity	Disposition
100350059	ncg item	LB	1	7	2	Damaged
100350059	ncg item	LB	1	7	2	Damaged
Totals:				14.00	4.00	

Driver Signature:

Employee Signature:

Figure C-9 Direct Delivery Report

Direct Delivery Report

Receipt Date: 05/09/2017
Supplier: 6100 - Local Grocery Supplier #2
Store: 1141 - Nashville
Delivery/ASN: DQ3
PO Number: 23456 ;
Status: Received
Invoice:
Invoice Date:
Notes:

Container ID: 220							
Status: Received							
<u>Item</u>	<u>Description</u>	<u>UOM</u>	<u>Pack Size</u>	<u>Expected</u>	<u>Received</u>	<u>Damaged</u>	<u>Unit Cost</u>
10035005 g	ncg item	LB	1	7	7	0	9.99
10035005 g	ncg item	LB	1	7	7	0	9.99
Totals				14.00	14.00	0.00	

Driver Signature:

Employee Signature:

Figure C-10 Inventory Adjustment AGSN Report

AGSN Label Report

SKU : 100000059
AGSN : 101
■■■

SKU : 100000059
AGSN : 102
■■■

SKU : 100000059
AGSN : 103
■■■

SKU : 100000059
AGSN : 104
■■■

SKU : 100000059
AGSN : 105
■■■

Figure C-11 Inventory Adjustment Report

Inventory Adjustment Report

Store: 1141
Adjustment Id: 1081
Create Date: 08/03/2017
Create User: QA_005
Approval Date:
Approval User:
Status: In Progress
Comment:

Item	Description	UOM	Pack Size	Qty	Reason	Sub-Bucket
100000008	Test Item 100000008	Cases	10	10	Stock Count In	

Printed: 1/4/2018

Page Number: 1

Figure C-12 Item Basket Report

Item Basket Report

Basket ID: 361
Alternate ID: 321
Basket Description: Basket
Basket Type: ^{AA}Gift Registry^{AA}

Figure C-13 Item Detail Report

Item Report			
Item	SIM_800	Item Description	SIM_800
Primary UPC		Primary Supplier Name	Fine Jewelry Supplier
VPN		Primary Supplier Number	1300
Item Status	Active	Ticket Type	
			Ranged Yes
			Merchandise Hierarchy
			Dept dept5600
			Class class5601
			Subclass subclass5602
			Differentiators:
Stock on Hand Units:		Ordering Attributes:	
Total Stock on Hand	0	Repl Method	
Pack Size		Reject Store Order	No
Available SOH	0	Next Delivery Date	null
Shop Floor			
Back Room	0		
Unavailable	0		
Transfer Reserved	0		
RTV Reserved	0		
Ordered Quantity	0		
Delivery Bay	0		
In Transit	0		
Received Today	0		
			Pricing:
			Current Retail USD100
			Pricing Status Permanent
			Promotional Type
Allocations:			
Sequencing:			

Figure C-14 Purchase Order Report

Purchase Order Report

Not Before Date:
Not After Date:
Supplier: 1200 - Fashion Importer (Euro)
PO Number:
To Location: 1141 - Nashville
Status: Completed

<u>Item</u>	<u>Descripti on</u>	<u>UO M</u>	<u>Pack Size</u>	<u>Expected</u>	<u>Received</u>	<u>Unit Cost</u>
SIM_ 125	SIM_125	LB	12	0	8	
Totals:				0.00	8.00	

Figure C-15 Replenishment Gap Report

Scan List Report

Store: 1511 - Phoenix
ID:
Type: Gap
Create Date/Time: 05/10/2017
Update Date/Time: 05/16/2017
User:
Status: Completed

SKU	Description	UOM	Pack Size	Qty
10000032	Test Item 10000032	Cases	10	1
100005016	Signal booster	Cases	1	1
100005017	Induction Test Item	Cases	1	1
SIM_125	SIM_125	Cases	1	1
SIM_400	SIM_400	Cases	1	3

Printed: 1/2/2018

Page Number: 1

Figure C-16 RFID History Report

RFID History Report

Item 100050056 - ST - Test Item

Date: 08/14/2019
EPC: EPC95278

Zone	Location	Transaction Type	Transaction ID	Observed
	Store 1311	POS Sale	1462	No

Date: 08/14/2019
EPC: 854126

Zone	Location	Transaction Type	Transaction ID	Observed
61	Store 1311	RFID	761	Yes

Date: 08/14/2019
EPC: 980403

Zone	Location	Transaction Type	Transaction ID	Observed
404	2	RFID	762	Yes

Figure C-17 RTV Report

RTV Report

RTV Number: 1584
 External ID: 1
 Authorization Number: RTVREG1
 Status: Canceled Request
 User: EXTERNAL
 Not After Date: 11/25/2017
 Approved Date: 11/23/2017
 Supplier: 1200
 Total SKUs: 2
 Return Type:

Item	Description	UOM	Pack Size	Reason Code	Req Qty	App Qty	Rem Qty	In-Ship Qty	Shipped Qty
SIM_125	SIM_125	Cases	1	Externally Initiated	2	2	2	0	
SIM_126	SIM_126 Short Desc	EA	1	Overstock	2				

Figure C-18 Shelf Adjustment Report

Shelf Adjustment List Report

Store: 1511 - Phoenix
ID: 623
Type: Move To Backroom
Create Date/Time: 2017-12-14T09:03:37.000-08:00
Update Date/Time: 2017-12-14T09:05:00.000-08:00
User: qa_004
Status: In Progress

SKU	Description	UOM	Pack Size	Qty
SIM_125	SIM_125	Cases	1	1
SIM_126	SIM_126 Short Desc	Cases	1	1

Printed: 1/2/2018

Page Number: 1

Figure C-19 Shelf Replenishment Report

Shelf Replenishment Report

Store: 1511 - Phoenix
ID: 1001
Shelf Replenishment Type: Capacity
Replenishment mode: End of Day
Product Group: SIM 125 126 140
Hierarchy:
Scan List:
Create Date/Time: 09/11/2017
User: qa_004
Status: Canceled
Quantity: 181

Item Id	Item Description	Pick From Area	Type	Selling Unit Of Measure	Pack Size	Qty	Actual Qty
SIM_125	Mobile Signal booster	Backroom	Capacity		1	100	
SIM_126	Wifi booster	Backroom	Capacity		1	81	
SIM_143	SIM_143	Backroom	Capacity		1	81	1
SIM_144	SIM_144	Backroom	Capacity		1	81	0

Figure C-20 Stock Count All Location Report

All Location Stock Count Report
--

Description: 125126 140
 Date: 10/22/2017
 Total Items: 1
 Stock Count User:
 Re-Count User:
 Authorization User:

Item	Item Description	Location	UOM	Count
SIM_140	SIM_140	No Location	EA	

Description: 125126 140
 Date: 10/22/2017
 Total Items: 2
 Stock Count User:
 Re-Count User:
 Authorization User:

Item	Item Description	Location	UOM	Count
SIM_125	SIM_125	Back Room1	LB	
SIM_126	SIM_126 Short Desc	Back Room1	EA	

Description: 125126 140
 Date: 10/22/2017
 Total Items: 2
 Stock Count User:
 Re-Count User:
 Authorization User:

Item	Item Description	Location	UOM	Count
SIM_125	SIM_125	Shop Floor1	LB	
SIM_126	SIM_126 Short Desc	Shop Floor1	EA	

Private and Confidential

Figure C-21 Stock Count Export Report [XML Format]

```

<STOCK_COUNT_EXPORT>
  <STOCK_COUNT>
    <COUNT_ID>862</COUNT_ID>
    <STORE_ID>1511</STORE_ID>
    <DESCRIPTION>125126 140</DESCRIPTION>
    <LIST_STOCK_COUNT_LINE_ITEM>
      <STOCK_COUNT_LINE_ITEM>
        <ITEM_ID>SIM_126</ITEM_ID>
        <ITEM_DESC>SIM_126 Short Desc</ITEM_DESC>
        <ITEM_SNAPSHOT></ITEM_SNAPSHOT>
        <LIST_UINS>
          <UINS>

          <UIN/>
        </UINS>
      </LIST_UINS>
    </STOCK_COUNT_LINE_ITEM>
    <STOCK_COUNT_LINE_ITEM>
      <ITEM_ID>SIM_125</ITEM_ID>
      <ITEM_DESC>SIM_125</ITEM_DESC>
      <ITEM_SNAPSHOT></ITEM_SNAPSHOT>
      <LIST_UINS>
        <UINS>

        <UIN/>
      </UINS>
    </LIST_UINS>
  </STOCK_COUNT_LINE_ITEM>
  <STOCK_COUNT_LINE_ITEM>
    <ITEM_ID>SIM_140</ITEM_ID>
    <ITEM_DESC>SIM_140</ITEM_DESC>
    <ITEM_SNAPSHOT></ITEM_SNAPSHOT>
    <LIST_UINS>
      <UINS>

      <UIN/>
    </UINS>
  </LIST_UINS>
</STOCK_COUNT_LINE_ITEM>
</LIST_STOCK_COUNT_LINE_ITEM>
</STOCK_COUNT>
</STOCK_COUNT_EXPORT>

```

Figure C-22 Stock Count Rejected Item Report

Rejected Items Report

Stock Count Description: Nithin Stk Cnt
 Stock Count Group: 41
 Schedule Date: 1/8/14
 Total Rejected Items: 1

SIM Item Id	Item Description	Rejected Item ID	Rejected UIN	Count Quantity	Count Location	Status	Comments
		100177107		1		Item Rejected	

Stock Count Description: TEST Schedule
 Stock Count Group: 141
 Schedule Date: 11/1/13
 Total Rejected Items: 5

SIM Item Id	Item Description	Rejected Item ID	Rejected UIN	Count Quantity	Count Location	Status	Comments
		100000657		2		Item Not On Count	
		100006021		2		Item Not On Count	
		1000006021		1		Item Rejected	

Private and Confidential

Figure C-23 Stock Count Report

Stock Count Report

Description: Sue Edit test avb : No Location
Date: 9/5/2017
Total Items: 1
Stock Count User: QA_001
Re-Count User:

Item	Description	Uom	Counted Qty
100050021	BS Flex Text Item1	EA	

Private and Confidential

Figure C-24 Transfer Delivery AGSN Report









AGSN Label Report		
SKU : 10000059 AGSN : 1906 		
SKU : 10000059 AGSN : 1907 		
SKU : 10000059 AGSN : 1908 		
SKU : 10000059 AGSN : 1909 		
SKU : 10000059 AGSN : 1910 		
SKU : 10000059 AGSN : 1911 		
SKU : 10000059 AGSN : 1912 		
SKU : 10000059 AGSN : 1913 		
SKU : 10000059 AGSN : 1914 		
<table border="1" style="width: 100%; border-collapse: collapse;"> <tr> <td style="width: 50%;">Printed: 10/3/2018</td> <td style="width: 50%;">Page Number: 1</td> </tr> </table>	Printed: 10/3/2018	Page Number: 1
Printed: 10/3/2018	Page Number: 1	

Figure C-25 Transfer Delivery Exception Report

Transfer Receiving Exception Report																																
Source: 1311 - Chicago* Destination: 1321 - Indianapolis Source Type: Store Delivery/ASN: 546 Status: New Expected Date: 06/29/2017																																
<table border="1" style="width: 100%; border-collapse: collapse;"> <tr> <td colspan="8">Container ID : 000132132011</td> </tr> <tr> <td colspan="8">Status: New</td> </tr> <tr> <th>Item</th> <th>Description</th> <th>UOM</th> <th>Pack Size</th> <th>Expected</th> <th>Received</th> <th>Damaged</th> <th>Difference</th> </tr> <tr> <td>SIM_3</td> <td>SIM_3</td> <td>Cases</td> <td>1</td> <td>1</td> <td>0</td> <td>0</td> <td>1</td> </tr> </table>	Container ID : 000132132011								Status: New								Item	Description	UOM	Pack Size	Expected	Received	Damaged	Difference	SIM_3	SIM_3	Cases	1	1	0	0	1
Container ID : 000132132011																																
Status: New																																
Item	Description	UOM	Pack Size	Expected	Received	Damaged	Difference																									
SIM_3	SIM_3	Cases	1	1	0	0	1																									
<table border="1" style="width: 100%; border-collapse: collapse;"> <tr> <td style="width: 50%;">Printed: 1/3/2018</td> <td style="width: 50%;">Page Number: 1</td> </tr> </table>	Printed: 1/3/2018	Page Number: 1																														
Printed: 1/3/2018	Page Number: 1																															

Figure C-26 Transfer Delivery Label

From Chicago* 123 Street Anytown Anycity MN 50250 US	To Indianapolis 123 Street Anytown Anycity MN 50250 US
(420) 50250 	Label Type TRNSFR
Label Reason : Reprint Reference Container Id : Number Of Items : 1	Dept #S 5555
Store (01) 1321 	Store 1321
SSCC -18  000132132011	

Figure C-27 Transfer Delivery Report

Transfer Receiving Report							
Source:		1311 - Chicago*					
Destination:		1321 - Indianapolis					
Source Type:		Store					
Delivery/ASN:		546					
Status:		New					
Expected Date:		06/28/2017					
Notes:							
Container ID : 000132132011							
Status: New							
Item	Description	UOM	Pack Size	Expected	Received	Damaged	Out of Stock
SIM_3	SIM_3	Cases	1	1	0	0	Yes

Printed: 1/3/2018 Page Number: 1

Figure C-28 Transfer Report

Transfer Report								
Transfer ID:		1462						
External ID:								
No of Items:		3						
Not After Date:								
Unavailable:		Yes			Approved Date:			
Customer Order Id:					Partial Delivery:		Yes	
Context Type:					Fulfillment Order Id:			
					Context Value:			
Source Type:		Store			Destination Type:		Store	
Source:		1311 - Chicago*			Destination:		1321 - Indianapolis	
Item	Description	Uom	Requested	Approved	In-Shipping	Shipped	Received	Damaged
SIM_1	SIM_1	Cases			1			
SIM_2	SIM_2	Cases			1			
SIM_3	SIM_3	Cases			1			

Printed: 1/3/2018 Page Number: 1

Figure C-29 Transfer Shipment BOL Report

Transfer Shipment BOL Report			
ASN: 561		Barcode: ■■■■	
BOL ID: 723		Shipment ID: 561	Motive: Bill of Lading Transfer New
Create Date: 2017-06-29		Create User: qa_007	
Sender 3111 - Montreal* 123 Street Anytown Anycity MN 50250 US		Receiver 3112 - Quebec 123 Street Anytown Anycity MN 50250 US	
Ship From 123 Street Anytown Anycity , MN 50250 US		Ship To Quebec 123 Street Anytown Anycity, MN 50250 US 312222473	
Carrier ◇ Sender ◇ Receiver ◇ Third Party Carrier Name: Parcel Test Requested Pick-Up Date: Carrier Signature: Dispatch Date: Carrier Address:			
Service: Parcel Test		Tax ID :	
Container ID	Weight (LBS)	Package Type	Tracking ID
11	11.00		
Notes			

Ship Container No: 11

Barcode: ■■■■

Item ID	EAN	Description	UOM	Quantity
100300166		100300166	Cases	1.00

Legalese fine print

Driver signature	Date	Receiver signature	Date
------------------	------	--------------------	------

Figure C-30 Transfer Shipment Carton Report

Transfer Shipment Container Report

Source: 1511 - Phoenix
 Destination: 1411 - Seattle*
 Destination Type: Store
 Ship Date:
 Shipment ID: 909
 Authorization Number:
 Status: In Progress
 User:
 Container: 950
 Container Status: In Progress

Document: 1506					
Item	Description	UOM	Pack Size	Ship Qty	Reason Code
SIM_125	SIM_125	Cases	1	1	
SIM_1	SIM_1	Cases	1	1	

Printed: 1/3/2018 Page Number: 1

Figure C-31 Transfer Shipment Report

Transfer Shipment Report

Source: 1511 - Phoenix
 Destination: 1411 - Seattle*
 Destination Type: Store
 Ship Date:
 Shipment ID: 909
 Authorization Number:
 Status: In Progress
 User:

Container ID : 950						
Item	Description	UOM	Document	Pack Size	Ship Qty	Reason Code
SIM_1	SIM_1	Cases	1506	1	1	

Printed: 1/3/2018 Page Number: 1

Figure C-32 Transfer Shipping Label



From Phoenix 123 Street Anytown Anycity MN 50250 US	To Seattle*
(420) Ship To Postal Code (420)50250 	Label Type <h1>Bill of Lading Transfer</h1>
Customer Order: No Number Of Items: 2 Context Value:	Dept #S 5555
Store (01)1411 	Store <h1>1411</h1>
SSCC -18 000141155106 	

Figure C-33 Vendor Delivery AGSN Report

AGSN Label Report	
SKU : 10000083 AGSN : 2353 ■■■■	
SKU : 10000083 AGSN : 2354 ■■■■	
SKU : 10000083 AGSN : 2355 ■■■■	
SKU : 10000083 AGSN : 2356 ■■■■	
SKU : 10000083 AGSN : 2357 ■■■■	
SKU : 10000083 AGSN : 2358 ■■■■	
SKU : 10000083 AGSN : 2359 ■■■■	
SKU : 10000083 AGSN : 2360 ■■■■	
SKU : 10000083 AGSN : 2361 ■■■■	
Printed: 10/3/2018	Page Number: 1

Figure C-34 Vendor Delivery Label

From Local Grocery Supplier #2 123 Main St Portland OR 83273 US	To Nashville 123 Street 123 Street Anycity MN 50250 US
(420) 50250 	Label Type DSD
Label Reason: Reprint Reference Container Id: REF123 Number Of Items: 3	Dept #S 1117
Store (01) 1141 	Store 1141
SSCC -18  DQ10	

Figure C-35 Vendor Shipment BOL Report



RTV Shipment BOL Report				
RTV: 1142		Barcode: 		
BOL ID: 1355		Shipment: 1130		Motive: RTV
Create Date: 08/24/2017		Create User: qa_004		
Sender 1511 - Phoenix 123 Street Anytown Anycity MN 50250 US		Receiver 1200 - Fashion Importer (Euro) 9999 9999 999 MN 89 US		
Ship From Phoenix 123 Street Anytown Anycity MN 50250 US		Ship To Fashion Importer (Euro) 9999 9999 999 MN 89 US Phone:		
Carrier ?Sender ?Receiver ?Third Party Carrier Name: Carrier Address:		Requested Pick-Up Date: Carrier Signature: Dispatch Date:		
Service:		Tax ID:		
Container ID	Weight (UOM)	Package Type	Tracking ID	
000120054129				
Legalese fine print				
Notes				
Ship Container No: 000120054129		Barcode : 		
EAN	Item	Description	UOM	Quantity
	SIM_13	SIM_13	Cases	2
Driver signature	Date	Receiver Signature	Date	

Figure C-36 Vendor Shipment Carton Report

RTV Shipment Container Report

Source: 1511 - Phoenix
Supplier: 1200 - Fashion Importer (Euro)
Ship Date:
Shipment Number: 1130
Authorization Number: 987878
Status: In Progress
User:
Not After Date: 08/23/2017
Container: 000120054129
Container Status: In Progress

Item	Description	UOM	Pack Size	Ship Qty	Reason Code
SIM_13	SIM_13	Cases	1	2	Overstock





Figure C-37 Vendor Shipment Report

RTV Shipment Report

Source: 1511 - Phoenix
Supplier: 1200 - Fashion Importer (Euro)
Ship Date:
Shipment Number: 1130
RTV Type:
Authorization Number: 987878
Status: In Progress
User:

Container ID: 000120054129		Status: In Progress			
Item	Description	UOM	Pack Size	Ship Qty	Reason Code
SIM_13	SIM_13	Cases	1	2	Overstock

Figure C-38 Vendor Shipment Label

From Phoenix 123 Street Anytown Anycity MN 50250 US	To Fashion Importer (Euro) gggg gggg MN 89 US
(420) Ship To Postal Code (420)89 	Label Type Return To Vendor
Return ID 8789 	
 (01)1200 	 1200
SSCC -18 000120058020 	

Appendix: Batch File Layout Specifications

This chapter describes the batch file layout specification.

Third Party Stock Count Parser Import File Layout Specification

Filename Format

<file prefix>_<date in YYYYMMDDHH24MISS format>_<loc id>.dat

Where file prefix value is STK and loc id is the store identifier. This allows file to be unique for every upload.

For each file, there need to be a .complete file present to job to process the file. The complete file can be any empty. This is to notify the job that uploading of data file is completed.

Example:

STK_20180129133250_1111.dat - Data File.

STK_20180129133250_1111.dat.complete - Complete File.

Zip Filename Format

<file prefix>_<date in YYYYMMDDHH24MISS format>.zip

Where file prefix value is STK. The zip file can contain one or more files from same or different stores. The complete file needs to be added for zip file for job to pick it for processing.

Example:

STK_20180129133250.zip - Zip File.

STK_20180129133250.zip.complete - Complete File.

Third Party Stock Count Import File Format

Pipe-delimited (|) file contains store count data for a store and stock count ID as shown in [Table D-1](#):

File Layout

Table D-1 Third Party Stock Count Import File

Record Name	Field Name	Field Type	Default Value	Description
FHEAD	Record Descriptor	Char(5)	FHEAD	File head marker
	Store Number	Char(10)		Store number file was uploaded for. It is assumed only one store is passed in per file. (Required)
	Stock Count ID	Number(12)		Unique identifier for item. Assumption is application will always take first stock count ID listed. (Required)
FDETL	Record Descriptor	Char(5)	FDETL	Detail record marker.
	Stock Count Date	Date(14)		Indicates date/time item was physically counted by the third party. (YYYYMMDDHH24MISS) For example, 20180129134600 (Required) Note: If not using timestamp, use 00 for time.
	Area Number	Char(10)		10-digit code indicating where in the store the item is located. (Optional)
	UPC or Item Number	Char(25)		25-digit universal product code. (Required)
	Count Quantity	Number(12,4)		Quantity counted for item, required. This field must allow for decimals when counting in UOM other than each. (Required)
	UIN(Item Serial Number)	Char(128)		Unique identification serial number for item, required if current item requires serial number.
FTAIL	Record Descriptor	Char(5)	FTAIL	File tail marker.

The following is a sample Third Party Stock Count Import File:

```
FHEAD|5000|1074|
FDETL|20180129235959|1|100665085|1|ItemSerialNum1234|
FDETL|201180129140000|1|100665085|1|ItemSerialNum9999|
FDETL|20180129000000|1|100665085|1||
FTAIL|
```

Clearance Price Change Import File Layout Specification

Filename Format

<event type>_<date in YYYYMMDDHH24MISS format>_<loc id>_<loc type>.dat

Where event type value is "CLRPC" (clearances), the loc type field would be either 'S' or 'W'.

For each file, there need to be a .complete file present to job to process the file. The complete file can be any empty. This is to notify the job that uploading of data file is completed.

Example:

CLRPC_20180129133250_1111_S.dat - Data File.

CLRPC_20180129133250_1111_S.dat.complete - Complete File.

Zip Filename Format

<event type>_<date in YYYYMMDDHH24MISS format>_<loc type>.zip

Where event type value is "CLRPC". The loc type field would be either 'S' or 'W'.

The zip file can contain one or more files from same or different stores. The complete file needs to be added for zip file for job to pick it for processing.

Example:

CLRPC_20180129133250_S.zip - Zip File.

CLRPC_20180129133250_S.zip.complete - Complete File.

File Record Types

- FHEAD (required): File identification, one line per file.
- FDETL (optional): Price Change Event (Create or Modify).
- FDELE (optional): Price Change Event (Delete).
- FTAIL (required): End of file marker, one line per file.

File Layout

Table D-2 Clearance Price Change File Layout

Record Name	Field Name	Field Type	Default Value	Description
FHEAD	Record Descriptor	Char(5)	FHEAD	File head marker
FHEAD	Line ID	Number(10)	1	Unique line ID
FHEAD	File Type	Char(5)	CLRPC	Clearance Price Changes
FHEAD	Export timestamp	Timestamp		System clock timestamp (YYYYMMDDHHMISS)
FHEAD	Location	Number(10)		Location identifier
FHEAD	Location Type	Char(1)		S = Store, W = Warehouse

Table D-2 (Cont.) Clearance Price Change File Layout

Record Name	Field Name	Field Type	Default Value	Description
FDETL	Record Descriptor	Char(5)	FDETL	File Detail Marker (one per clearance create or modify)
FDETL	Line ID	Number(10)		Unique line ID
FDETL	Event Type	Char(3)		CRE = Create MOD = Modify
FDETL	ID	Number(15)		Clearance identifier
FDETL	Item	Char(25)		Item identifier
FDETL	Effective Date	Date		Clearance Effective Date (YYMMDDHHMISS)
FDETL	Selling Retail	Number(20,4)		Selling retail with price change applied
FDETL	Selling Retail UOM	Char(4)		Selling retail unit of measure
FDETL	Selling Retail Currency	Char(3)		Selling retail currency
FDETL	Reset Clearance ID	Number(15)		ID of clearance reset
FDELE	Record Descriptor	Char(5)	FDELE	File Detail Delete Marker (one per clearance delete)
FDELE	Line ID	Number(10)		Unique line ID
FDELE	ID	Number(15)		Clearance identifier
FDELE	Item	Char(25)		Item identifier
FTAIL	Record Descriptor	Char(5)	FTAIL	File tail marker
FTAIL	Line ID	Number(10)		Unique line ID
FTAIL	Number of lines	Number(10)		Number of lines in file not counting FHEAD and FTAIL

Regular Price Change Import File Layout Specification

Filename Format

<event type>_<date in YYYYMMDDHH24MISS format>_<loc id>_<loc type>.dat

Where event type is "REGPC" (regular price changes). The loc type field would be either 'S' or 'W'.

For each file, there need to be a .complete file present to job to process the file. The complete file can be any empty. This is to notify the job that uploading of data file is completed.

Example:

REGPC_20180129133250_1111_S.dat - Data File.

REGPC_20180129133250_1111_S.dat.complete - Complete File.

Zip Filename Format

<event type>_<date in YYYYMMDDHH24MISS format>_<loc type>.zip

Where event type value is "REGPC". The loc type field would be either 'S' or 'W'.

The zip file can contain one or more files from same or different stores. The complete file needs to be added for zip file for job to pick it for processing.

Example:

REGPC_20180129133250_S.zip - Zip File.

REGPC_20180129133250_S.zip.complete - Complete File.

File Record Types

- FHEAD (required): File identification, one line per file.
- FDETL (optional): Price Change Event (Create or Modify).
- FDELE (optional): Price Change Event (Delete).
- FTAIL (required): End of file marker, one line per file.

File Layout

Table D-3 Regular Price Change File Layout

Record Name	Field Name	Field Type	Default Value	Description
FHEAD	Record Descriptor	Char(5)	FHEAD	File head marker
FHEAD	Line ID	Number(10)	1	Unique line ID
FHEAD	File Type	Char(5)	REGPC	Regular Price Changes
FHEAD	Export timestamp	Timestamp		System clock timestamp (YYYYMMDDHHMISS)
FHEAD	Location	Number(10)		Location identifier
FHEAD	Location Type	Char(1)		S = Store W = Warehouse
FDETL	Record Descriptor	Char(5)	FDETL	File Detail Marker (one per price change create or modify)
FDETL	Line ID	Number(10)		Unique line ID
FDETL	Event Type	Char(3)		CRE = Create MOD = Modify
FDETL	ID	Number(15)		Price Change identifier
FDETL	Item	Char(25)		Item identifier
FDETL	Effective Date	Date		Effective Date of price change (YYYYMMDDHHMISS)
FDETL	Selling Unit Change Ind	Number(1)		Did selling unit retail change with this price event (0 = no change, 1 = changed)

Table D-3 (Cont.) Regular Price Change File Layout

Record Name	Field Name	Field Type	Default Value	Description
FDETL	Selling Retail	Number(20,4)		Selling retail with price change applied
FDETL	Selling Retail UOM	Char(4)		Selling retail unit of measure
FDETL	Selling Retail Currency	Char(3)		Selling retail currency
FDETL	Multi-Unit Change Ind	Number(1)		Did multi unit retail change with this price event (0 = no change, 1 = changed)
FDETL	Multi-Units	Number(12,4)		Number Multi Units
FDETL	Multi-Unit Retail	Number(20,4)		Multi Unit Retail
FDETL	Multi-Unit UOM	Char(4)		Multi Unit Retail Unit Of Measure
FDETL	Multi-Unit Currency	Char(3)		Multi Unit Retail Currency
FDELE	Record Descriptor	Char(5)	FDELE	File Detail Delete Marker (one per price change delete)
FDELE	Line ID	Number(10)		Unique line ID
FDELE	ID	Number(15)		Price Change identifier
FDELE	Item	Char(25)		Item identifier
FTAIL	Record Descriptor	Char(5)	FTAIL	File tail marker
FTAIL	Line ID	Number(10)		Unique line ID
FTAIL	Number of lines	Number(10)		Number of lines in file not counting FHEAD and FTAIL

Promotion Price Change Import File Layout Specification

Filename Format

<event type>_<date in YYYYMMDDHH24MISS format>_<loc id>_<loc type>.dat

Where event type is "PRMPC" (promotional price change). The loc type field would be either 'S' or 'W'.

For each file, there need to be a .complete file present to job to process the file. The complete file can be any empty. This is to notify the job that uploading of data file is completed.

Example:

PRMPC_20180129133250_1111_S.dat - Data File.

PRMPC_20180129133250_1111_S.dat.complete - Complete File.

Zip Filename Format

<event type>_<date in YYYYMMDDHH24MISS format>_<loc type>.zip

Where event type value is "PRMPC". The loc type field would be either 'S' or 'W'.

The zip file can contain one or more files from same or different stores. The complete file needs to be added for zip file for job to pick it for processing.

Example:

PRMPC_20180129133250_S.zip - Zip File.

PRMPC_20180129133250_S.zip.complete - Complete File.

File Record Types

- FHEAD (required): File identification, one line per file.
- TMBPE (optional): Event Type.
- TPDTL (required): Promotion Component Detail.
- TPGRP (required): Promotion Group (one or more per TPDTL).
- TGLST (required): Promotion List (one or more per TPGRP).
- TLITM (required): Promotion Item (one or more per TGLST).
- TPDSC (required): Promotion Discount (one or more per TGLST).
- TPISR (optional): Promotion Item Selling retail (one or more per TPDTL).
- TPCDT (optional): Promotion Credit Detail (one or more per TPDTL).
- TTAIL (required): Transaction tail (one per promotion).
- TPCIL (optional): Promotion Cancel Item Location
- FPDEL (optional): Promotion Delete.
- FTAIL (required): End of file marker, one line per file.

File Layout

Table D-4 Promotion Price Change Output File Layout

Record Name	Field Name	Field Type	Default Value	Description
FHEAD	Record Descriptor	Char(5)	FHEAD	File head marker
FHEAD	Line ID	Number(10)	1	Unique line Identifier
FHEAD	File Type	Char(5)	PROMO	Promotions
FHEAD	Export timestamp	Timestamp		System clock timestamp (YYYYMMDDHHMISS)
FHEAD	Location	Number(10)		Location identifier
FHEAD	Location Type	Char(1)		S = Store, W = Warehouse
TMBPE	Record Descriptor	Char(5)	TMBPE	Promotion (transaction head)

Table D-4 (Cont.) Promotion Price Change Output File Layout

Record Name	Field Name	Field Type	Default Value	Description
TMBPE	Line ID	Number(10)		Unique line identifier
TMBPE	Event Type	Char(3)		CRE = Create MOD = Modify
TPDTL	Record Descriptor	Char(5)	TPDTL	Promotion Detail Component
TPDTL	Line ID	Number(10)		Unique line identifier
TPDTL	Promo ID	Number(10)		Promotion identifier
TPDTL	Promo Comp ID	Number(10)		Promotion Component ID
TPDTL	Promo Name	Char(160)		Promotion Header Name
TPDTL	Promo Desc	Char(640)		Promotion Header Description
TPDTL	Promo Comp Desc	Char(160)		Promotion Component Name
TPDTL	Promo Type	Number(2)		Valid values will be modified to be as follows: 0 - Multi-Buy Promotion; 1 - Simple Promotion; 2 - Threshold Promotion; 3 - Finance Promotion (formerly tied to a value of 6); 4 - Transaction Promotion
TPDTL	Promo Comp Detail ID	Number(10)		Promotion Component Detail identifier
TPDTL	Start Date	Date		Start Date of Promotion Component Detail (YYYYMMDDHH24MISS)
TPDTL	End Date	Date		End Date of Promotion Component Detail (YYYYMMDDHH24MISS)
TPDTL	Apply To Code	Number(1)		Holds the apply to code for the promotion detail. Determines if the promotion is applied to regular retail only (no clearances in effect), clearance retail only (only when a clearance is in effect) or both regular and clearance retail. Valid values are 0 - Regular Only; 1 - Clearance Only; 2 - Regular and Clearance.
TPDTL	Discount Limit	Number(3)		The number of times that the promotion that can be applied to a transaction.
TPDTL	Apply Order	Number(1)		Application Order of the Promotion
TPDTL	Threshold ID	Number(6)		Threshold identifier
TPDTL	Customer Type ID	Number(10)		Customer Type identifier
TPDTL	Threshold Qualification Type	Number(1)		The qualification type for the threshold. Will only be populated for threshold promotions. Valid values are 0 for item level and 1 for threshold level.

Table D-4 (Cont.) Promotion Price Change Output File Layout

Record Name	Field Name	Field Type	Default Value	Description
TPDTL	Exception Parent ID	Number(10)		The promotion component detail ID for the parent event that this event is a child to. Used only for transaction promotion detail exclusions to be able to connect the child exclusion to it's parent promotion detail.
TPGRP	Record Descriptor	Char(5)	TPGRP	Promotion Detail Group
TPGRP	Line ID	Number(10)		Unique line identifier
TPGRP	Group ID	Number(10)		Group Number
TGLIST	Record Descriptor	Char(5)	TGLIST	Promotion Group List
TGLIST	Line ID	Number(10)		Unique line identifier
TGLIST	List ID	Number(10)		List identifier
TGLIST	Reward Application	Number(1)		How this reward is applied to the promotion detail.
TGLIST	Description	Char(120)		Description
TGLIST	Price Range Min	Number (20,4)		Contains price range promotion minimum valid retail value.
TGLIST	Price Range Max	Number (20,4)		Contains price range promotion maximum valid retail value.
TLITM	Record Descriptor	Char(5)	TLITM	Promotion Group List
TLITM	Line ID	Number(10)		Unique line identifier
TLITM	Item ID	Char(25)		Transaction Item Identifier
TPDSC	Record Descriptor	Char(5)	TPDSC	Discount Detail for List
TPDSC	Line ID	Number(10)		Unique line identifier
TPDSC	Change Type	Number(2)		Change Type
TPDSC	Change Amount	Number(20,4)		Change Amount
TPDSC	Change Currency	Char(3)		Change Currency
TPDSC	Change Percent	Number(20,4)		Change Percent
TPDSC	Change Selling UOM	Char(4)		Change Selling UOM
TPDSC	Qual Type	Number(2)		Qualification Type
TPDSC	Qual Value	Number(2)		Qualification Value
TPDSC	Change Duration	Number(20,4)		Change Duration
TPISR	Record Descriptor	Char(5)	TPISR	Items in Promotion
TPISR	Line ID	Number(10)		Unique line identifier
TPISR	Item ID	Char(25)	TTAIL	Transaction Item Identifier
TPISR	Selling Retail	Number(20,4)		Selling retail of the item
TPISR	Selling UOM	Char(4)		Selling UOM of the item
TPISR	Effective Date	Date		Effective Date of the selling retail - YYYYMMDDHH24MISS
TPISR	Selling Retail Currency	Char(3)		Selling retail currency

Table D-4 (Cont.) Promotion Price Change Output File Layout

Record Name	Field Name	Field Type	Default Value	Description
TPISR	Referenced Promo Detail ID	Number(15)		Referenced promotion detail ID. This is an optional field.
TPCDT	Record Descriptor	Char(5)	TPCDT	Credit Detail
TPCDT	Credit Detail ID	Number(10)		Credit Detail ID
TPCDT	Line ID	Number(10)		Unique line ID
TPCDT	Credit Type	Char(40)		Credit Type
TPCDT	BinNumberFrom	Number(10)		BinNumber From
TPCDT	BinNumberTo	Number(10)		Bin Number To
TPCDT	Commission Rate	Number(10)		Commission Rate
TPCDT	Comments	Char(160)		Comments
TTAIL	Record Descriptor	Char(5)	TTAIL	Transaction Tail
TTAIL	Line ID	Number(10)		Unique line identifier
TPCIL	Record Descriptor	Char(5)	TPCIL	Cancel Item Loc
TPCIL	Line ID	Number(10)		Unique line identifier
TPCIL	Promo ID	Number(10)		The ID of the promotion
TPCIL	Promo Comp ID	Number(10)		Promotion Component ID
TPCIL	Promo Comp Detail ID	Number(10)		Promotion Component Detail identifier
TPCIL	Item ID	Char(25)		Transaction Item Identifier for item
TPCIL	Cancellation Date	Date		Cancellation effective date - YYYYMMDDHH24MISS
FPDEL	Record Descriptor	Char(5)	FPDEL	Delete Promotion
FPDEL	Line ID	Number(10)		Unique line identifier
FPDEL	Promo ID	Number(10)		The ID of the promotion
FPDEL	Promo Comp ID	Number(10)		Promotion Component ID
FPDEL	Promo Comp Detail ID	Number(10)		Promotion Component Detail ID
FPDEL	Group ID	Number(10)		Group Number
FPDEL	List ID	Number(10)		List ID
FPDEL	Item ID	Char(25)		Transaction Item Identifier for item
FTAIL	Record Descriptor	Char(5)	FTAIL	File tail marker
FTAIL	Line ID	Number(10)		Unique line identifier
FTAIL	Number of lines	Number(10)		Number of lines in file not counting FHEAD and FTAIL

POS Sale Transaction Import File Specification

Filename Format

<file prefix>_<date in YYYYMMDDHH24MISS format>_<loc id>.dat

Where file prefix value is "SIMTLOG" and loc id is the store identifier. This allows file to be unique for every upload.

For each file, there need to be a .complete file present to job to process the file. The complete file can be any empty. This is to notify the job that uploading of data file is completed.

Example:

SIMTLOG_20180129133250_1111.dat - Data File.

SIMTLOG_20180129133250_1111.dat.complete - Complete File.

Zip Filename Format

<file prefix>_<date in YYYYMMDDHH24MISS format>.zip

Where file prefix value is "SIMTLOG". The zip file can contain one or more files from same or different stores. The complete file needs to be added for zip file for job to pick it for processing.

Example:

SIMTLOG_20180129133250.zip - Zip File.

SIMTLOG_20180129133250.zip.complete - Complete File.

POS Sale Transaction Import File Format

The input file would be in Pipe ('|') delimited format.

File Layout

Table D-5 T-LOG File

Record Name	Field Name	Field Type	Default Value	Description
FILE HEADER	FILE HEADERFile Type Record Descriptor	VARCHAR2(5)	FHEAD	Identifies the File Record Type
FILE HEADER	Location Number	NUMBER(10)		Store Number
FILE HEADER	Business Date	VARCHAR2(14)		Business Date of transactions in YYYYMMDDHHSS format
FILE HEADER	File Creation Date	VARCHAR2(14)	SYSDATE	File Create Date in YYMMDDHHMSS format
TRANSACTION HEADER	File Type Record Descriptor	VARCHAR2 (5)	THEAD	Identifies the File Record Type
TRANSACTION HEADER	Transaction Number	VARCHAR2(128)		The unique transaction reference number generated by ORXPOS/OMS.

Table D-5 (Cont.) T-LOG File

Record Name	Field Name	Field Type	Default Value	Description
TRANSACTION HEADER	Transaction Date and Time	VARCHAR2(14)		Date transactions were processed in ORXPOS/OMS
TRANSACTION HEADER	Customer Order ID	VARCHAR2(128)		External customer order ID, if transaction is a customer order
TRANSACTION HEADER	Customer Order Comments	VARCHAR(512)		Comments on the customer order
TRANSACTION DETAIL	File Type Record Descriptor	VARCHAR2(5)	TDETL	Identifies the File Record Type
TRANSACTION DETAIL	Item ID	VARCHAR2(25)		ID number of the item.
TRANSACTION DETAIL	UIN	VARCHAR2(128)		This is the UNIQUE_ID value from RTLOG
TRANSACTION DETAIL	Item Quantity	NUMBER(12,4)		Quantity of the item on this transaction
TRANSACTION DETAIL	Selling UOM	VARCHAR2(4)		UOM at which this item was sold
TRANSACTION DETAIL	Reason Code	NUMBER(4)		Reason entered by cashier for some transaction types. Required for voids, returns, for example.
TRANSACTION DETAIL	Comments	VARCHAR(512)		Comments for this line item
TRANSACTION DETAIL	Transaction Code	VARCHAR2(25)		The type of sale represented by this line item. Valid value are SALE,RETURN,VOID_SALE,VOID_RETURN,ORDER_NEW,ORDER_FULFILL,ORDER_CANCEL,ORDER_CANCEL_FULFILL
TRANSACTION DETAIL	Reservation Type	VARCHAR(25)		Reservation type if POS transaction is a customer order. Valid values are SPECIAL_ORDER, WEB_ORDER, PICKUP_AND_DELIVERY,LAYAWAY
TRANSACTION DETAIL	Fulfillment Order Number	VARCHAR2(48)		Fulfillment Order Number from OMS
TRANSACTION DETAIL	Drop Ship Indicator	VARCHAR(1)		'P' if it is drop ship otherwise 'N'
TRANSACTION TAIL	File Record Type Descriptor	VARCHAR2(5)	TTAIL	Identifies the File Record Type
TRANSACTION TAIL	Transaction Record Counter	NUMBER(6)		Number of TDETL records in this transaction set.
FILE TAIL	File Record Type Descriptor	VARCHAR2(5)	FTAIL	Identifies the File Record Type
FILE TAIL	File Record Counter	NUMBER(10)		Number of records/transactions processed in current file (only records between head and tail)

Retail Sale Audit Import File Specification

Filename Format

<file prefix>_<date in YYYYMMDDHH24MISS format>_<loc id>.dat

Where file prefix value is "SIMT" and loc id is the store identifier. This allows file to be unique for every upload.

For each file, there need to be a .complete file present to job to process the file. The complete file can be any empty. This is to notify the job that uploading of data file is completed.

Example:

SIMT_20180129133250_1111.dat - Data File.

SIMT_20180129133250_1111.dat.complete - Complete File.

Zip Filename Format

<file prefix>_<date in YYYYMMDDHH24MISS format>.zip

Where file prefix value is "SIMT". The zip file can contain one or more files from same or different stores. The complete file needs to be added for zip file for job to pick it for processing.

Example:

SIMT_20180129133250.zip - Zip File.

SIMT_20180129133250.zip.complete - Complete File.

ReSA Transaction Import File Format

The input file would be in Pipe ('|') delimited format.

File Layout

Table D-6 ReSA File Layout

Record Name	Field Name	Field Type	Default Value	Description
FILE HEADER	FILE Type Record Descriptor	VARCHAR2(5)	FHEAD	Identifies the File Record Type
FILE HEADER	File Line ID	VARCHAR(10)		Sequential file line number
FILE HEADER	File Type Definition	VARCHAR2(4)	SIMT	Identifies the File Type
FILE HEADER	Location Number	NUMBER(10)		Store Number
FILE HEADER	Business Date	VARCHAR2(14)		Business Date of transactions in YYYYMMDDHHSS format
FILE HEADER	File Creation Date	VARCHAR2(14)	SYSDATE	File Create Date in YYYYMMDDHHMSS format
TRANSACTION HEADER	File Type Record Descriptor	VARCHAR2 (5)	THEAD	Identifies the File Record Type

Table D-6 (Cont.) ReSA File Layout

Record Name	Field Name	Field Type	Default Value	Description
TRANSACTION HEADER	File Line ID	VARCHAR(10)		Sequential file line number
TRANSACTION HEADER	Transaction Number	NUMBER(10)		The unique transaction reference number generated by ORXPOS/OMS
TRANSACTION HEADER	Register Number	NUMBER(10)		The register reference number generated by ORXPOS
TRANSACTION HEADER	Revision Number	NUMBER(3)		The version of the transaction being sent
TRANSACTION HEADER	Transaction Date and Time	VARCHAR2(14)		Date transactions were processed in ORXPOS/OMS
TRANSACTION HEADER	Transaction Type	VARCHAR2(14)		Transaction Type Code (for example, SALE, RETURN, SPLOD)
TRANSACTION HEADER	Pos created flag	VARCHAR2(1)		'Y' identifies that the transaction occurred at ORXPOS, 'N' identifies that the transaction was created in ReSA
TRANSACTION DETAIL	File Type Record Descriptor	VARCHAR2(5)	TDETL	Identifies the File Record Type
TRANSACTION DETAIL	File Line ID	VARCHAR(10)		Sequential file line number.
TRANSACTION DETAIL	Item Sequence Number	NUMBER(4)		The order in which items were entered during a transaction
TRANSACTION DETAIL	Item	VARCHAR2(25)		ID number of the item.
TRANSACTION DETAIL	Item Type	VARCHAR2(6)		Type of Item sold. Can be 'ITEM', 'REF', 'GCN', 'NMITEM'
TRANSACTION DETAIL	Reference Item	VARCHAR2(25)		Identified sub-transaction level merchandise item.
TRANSACTION DETAIL	Non-Merchandise Item	VARCHAR2(25)		Identifies non-merchandise item
TRANSACTION DETAIL	Item Status	VARCHAR2(6)		Status of the item within the transaction, V for item void, S for sold item, R for returned item, Layaway Initiate (LIN), Layaway Cancel, Layaway Complete (LCO), Order Initiate (ORI), Order Cancel (ORC) Order Complete (ORD)
TRANSACTION DETAIL	Serial Number	VARCHAR2(128)		This is the UNIQUE_ID value from RTLOG
TRANSACTION DETAIL	Pack Indicator	VARCHAR2(1)		Pack indicator of item sold or returned
TRANSACTION DETAIL	Catch Weight Indicator	VARCHAR2(1)		Indicates if item is a catchweight item
TRANSACTION DETAIL	Item Quantity Sign	VARCHAR2(1)		Determines if the Total Sale Quantity is positive or negative 'P' - Positive 'N' - Negative

Table D-6 (Cont.) ReSA File Layout

Record Name	Field Name	Field Type	Default Value	Description
TRANSACTION DETAIL	Item Quantity Value	NUMBER(20)		Total sales value of goods sold/returned (4 implied decimal places), for example, Total Quantity * 10000
TRANSACTION DETAIL	Standard UOM	VARCHAR2(4)		Standard UOM of the Item
TRANSACTION DETAIL	Selling UOM	VARCHAR2(4)		UOM at which this item was sold
TRANSACTION DETAIL	Wastage Type	VARCHAR2(6)		Wastage type of item sold or returned
TRANSACTION DETAIL	Wastage Percentage	NUMBER(12)		Wastage Percent*10000 (4 implied decimal places), wastage percent of item sold or returned
TRANSACTION DETAIL	Drop Ship Indicator	VARCHAR2(1)	N	This will always be N for Export
TRANSACTION DETAIL	Actual Weight Quantity	NUMBER(12)		Actual Weight Quantity*10000 (4 implied decimal places), the actual weight of the item, only populated if catchweight_ind = 'Y'
TRANSACTION DETAIL	Reason Code	VARCHAR2(6)		Reason entered by cashier for some transaction types
TRANSACTION DETAIL	Sale Value	NUMBER(20)		Total Sales Value * 10000 (4 implied decimal places), sales value, net sales value of goods sold
TRANSACTION DETAIL	Sales Sign	VARCHAR2(1)		Determines if the Total Sales Value is positive or negative 'P' - Positive 'N' - Negative
TRANSACTION DETAIL	Unit Retail	NUMBER(20,4)		Unit retail with 4 implied decimal places
TRANSACTION DETAIL	Sales Type	VARCHAR2(1)		Indicates if the line item is a Regular Sale, a CO serviced by OMS (External CO), or a CO serviced by Inventory management application (In-Store CO)
TRANSACTION DETAIL	Customer Order Number	VARCHAR2(50)		Customer Order Number
TRANSACTION DETAIL	Customer Order Type			Customer order type
TRANSACTION DETAIL	Fulfillment Order Number	VARCHAR2(50)		Fulfillment Order Number from OMS
TRANSACTION TAIL	File Record Type Descriptor	VARCHAR2(5)	TTAIL	Identifies the File Record Type
TRANSACTION TAIL	File Line ID	NUMBER(10)		Sequential file line number
TRANSACTION TAIL	Transaction Record Counter	NUMBER(6)		Number of TDETL records in this transaction set

Table D-6 (Cont.) ReSA File Layout

Record Name	Field Name	Field Type	Default Value	Description
FILE TAIL	File Record Type Descriptor	VARCHAR2(5)	FTAIL	Identifies the File Record Type
FILE TAIL	File Line ID	NUMBER(10)		Sequential file line number
FILE TAIL	File Record Counter	NUMBER(10)		Number of records/transactions processed in current file (only records between head and tail)

Stock Count Results Export File Specification

The stock count result export file is generated when unit amount stock count authorization completes. The stock count authorization process can be a manual authorization or invoked by third party stock count batch for an auto-authorized unit amount stock count. This export file can be uploaded to RMS by RMS file to update their inventory with the actual physical stock count.

Table D-7 Stock Count Export File

Record Name	Field Name	Field Type	Description
File Header	file type record descriptor	Char(5)	hardcode FHEAD
File Header	file line identifier	Number(10)	ID of current line being processed, hardcode 000000001
File Header	file type	Char(4)	hardcode STKU
File Header	file create date	Date(14)YYYYM MDDHHMISS	date written by convert program
File Header	stocktake_date	Date(14)YYYYM MDDHHMISS	take_head.stocktake_date
File Header	cycle count	Number(8)	stake_head.cycle_count
File Header	loc_type	Char(1)	hardcode W or S
File Header	location	Number(10)	stake_location.wh or stake_location.store
Transaction record	file type record descriptor	Char(5)	hardcode FDETL
Transaction record	file line identifier	Number(10)	ID of current line being processed, internally incremented
Transaction record	item type	Char(3)	hardcode ITM
Transaction record	item value	Char(25)	item ID
Transaction record	inventory quantity	Number(12,4)	total units or total weight
Transaction record	location description	Char(30)	Where in the location the item exists. For example, Back Stockroom or Front Window Display
File trailer	file type record descriptor	Char(5)	hardcode FTAIL
File trailer	file line identifier	Number(10)	ID of current line being processed, internally incremented
File trailer	file record count	Number(10)	Number of detail records

Store Sequence Data Parser Import File Layout Specification

Sequencing functionality provides users the ability to know the relative location of an item in a store. Sequencing a store improves store processes and reduces the time that employees spend looking for items. The retailer can sequence all items in the store and create unique locations to hold the items.

Sequencing defines how many items can be stored in a particular location, and allows the definition of a capacity for that item location combination. The capacity is used for in-store replenishment when generating the shelf replenishment pick list. Sequencing is used within Stock Counts, Customer Order Picking, Transfer Request, and Shelf Replenishment to aid the user in proceeding to the next item during the transaction for

efficiency. Lastly, the Sequencing Primary Location is displayed to the user on the Item Detail screen.

Filename Format

<file prefix>_<date in YYYYMMDDHH24MISS format>_<loc id>.dat

Where file prefix value is "SSEQ" and loc id is the store identifier. This allows file to be unique for every upload.

For each file, there need to be a .complete file present to job to process the file. The complete file can be any empty. This is to notify the job that uploading of data file is completed.

Example:

SSEQ_20180129133250_1111.dat - Data File.

SSEQ_20180129133250_1111.dat.complete - Complete File.

Zip Filename Format

<file prefix>_<date in YYYYMMDDHH24MISS format>.zip

Where file prefix value is "SSEQ". The zip file can contain one or more files from same or different stores. The complete file needs to be added for zip file for job to pick it for processing.

Example:

SSEQ_20180129133250.zip - Zip File.

SSEQ_20180129133250.zip.complete - Complete File.

Store Sequence Import File Format

The input file would be in pipe ('|') delimited format.

File Layout

Table D-8 Store Sequence Import File

Record Name	Field Name	FieldType	Description
File Header	file type record descriptor	Char(5)	hardcode FHEAD
File Header	Store ID	Number(10)	Store identifier
Sequence record	file type record descriptor	Char(5)	hardcode SHEAD
Sequence record	Area type	Number(9)	The Store Sequence Area. 0 = None, 1 = Shopfloor, 2 = Backroom
Sequence record	Child sequenced	Varchar2(1)	'Y' if child is sequenced, 'N' if not
Sequence record	Department ID	Number(12)	Department ID
Sequence record	Class ID	Number(12)	Class ID
Sequence record	Description	Varchar2(255)	Description of Store Sequence
Sequence record	Not sequenced	Varchar2(1)	The order the store sequence is in compared to other store sequences

Table D-8 (Cont.) Store Sequence Import File

Record Name	Field Name	FieldType	Description
Sequence record	Sequence Order	Number(20)	Y indicates a default sequence containing all items that have not been sequenced elsewhere
Sequence detail	file type record descriptor	Char(5)	hardcode SDETL
Sequence detail	Item ID	Varchar2(25)	Item ID
Sequence detail	Primary location	Varchar2(1)	Indicator if the location specified is the primary location for the item, Y if is primary location for item, N otherwise
Sequence detail	Item sequence order	Number(20)	Order of item within store sequence
Sequence detail	Capacity	Number(11,2)	The size of the location appropriate to unit of measure
Sequence detail	Ticket quantity	Number(11,2)	The quantity of tickets that need to be printed or used for the item inventory location
Sequence detail	Ticket format ID	Number(10)	Item ticket format identifier
Sequence detail	Uom mode	Number(2)	The Unit Of Measure display mode: 1 = Units, 2 = Cases
Sequence detail	Width	Number(12)	Width value to indicate how many items can fit across the width of the shelf
Sequence trailer	File type record descriptor	Char(5)	hardcode STAIL
File trailer	File type record descriptor	Char(5)	hardcode FTAIL

Warehouse Stock Import File Layout Specification

Filename Format

<file prefix>_<date in YYYYMMDDHH24MISS format>.dat

Where file prefix value is "WHIMS". The prefix and date combination allows file to be unique for every upload.

For each file, there need to be a .complete file present to job to process the file. The complete file can be any empty. This is to notify the job that uploading of data file is completed.

Example:

WHIMS_20180129133250_1111.dat - Data File.

WHIMS_20180129133250_1111.dat.complete - Complete File.

Zip Filename Format

<file prefix>_<date in YYYYMMDDHH24MISS format>.zip

Where file prefix value is "WHIMS". The zip file can contain one or more files. The complete file needs to be added for zip file for job to pick it for processing.

Example:

WHIMS_20180129133250.zip - Zip File.

WHIMS_20180129133250.zip.complete - Complete File.

Warehouse Stock Import File Format

The input file would be in Pipe ('|') delimited format.

File Layout

Table D-9 Warehouse Stock Import File

Record Name	Field Name	Field Type	Default Value	Description
1	Warehouse ID	Number(10)	NA	ID of the Warehouse, for example, 7000
2	Item ID	Varchar2(25)	NA	Item Identifier.
3	Stock On Hand	Number(12)	NA	Stock on hand of the item in the warehouse.
4	Status	Varchar2(2)	NA	Status code of the item. Example A - Active, D - Deleted, I - Inactive, C - Discontinued.

Inventory Extract Export File Specification

The file generated Inventory extract contains current available stock on hand for all the item in a store. Single file will contain inventory for single store, when executed for all stores job will create single file per store and zip all the file to single zip archive.

Filename Format

<file prefix>_<store id>_<date in YYYYMMDDHH24MISS format>.txt

Where file prefix value is "PRODUCT_LOCATION_INV" and the store id is unique store identifier.

<file prefix>_<date in YYYYMMDDHH24MISS format>.zip

Where file prefix value is "PRODUCT_LOCATION_INV".

Inventory Extract File Format

The first row will contain the placeholder information of the data on the file separated by pipe ('|').

Example:

```
system_cd | location_cd | product_cd | available_qty | next_po_qty | next_po_date | daily_sell_through_qty | sell_qty_multiple | minimum_sell_qty | shrink_rate | sales_velocity
```

The input file would be in Pipe ('|') delimited format.

File Layout

Table D-10 Inventory Extract File

Record Name	Field Name	Field Type	Default Value	Description
1	System Code	Varchar2	INV	This field will always hold default value that is, INV
2	Location Code	Number	NA	This field holds the store identifier.
3	Product Code	Varchar2	NA	This field hold the item identifier.
4	Available Quantity	Number	NA	This field holds the current available stock on hand for the item in store.
5	Next PO Quantity	Number	0	This field will hold next purchase order quantity.
6	Next PO Date	Varchar2	NA	This field hold the next purchase order date. This field is currently unused and will be empty.
7	Daily Sell Through Quantity	Number	NA	This field is currently unused and will be empty.
8	Sell Qty Multiple	Number	NA	This field is currently unused and will be empty.
9	Minimum Sell Qty	Number	NA	This field is currently unused and will be empty.
10	Shrink Rate	Number	NA	This field is currently unused and will be empty.
11	Sales Velocity	Number	NA	This field is currently unused and will be empty.

The following is a sample Inventory Extract File:

```
system_cd | location_cd | product_cd | available_qty | next_po_qty | next_po_
date | daily_sell_through_qty | sell_qty_multiple | minimum_sell_qty | shrink_
rate | sales_velocity
```

```
INV | 5000 | 100665050 | 10 | 0 | | | | |
```

```
INV | 5000 | 100665051 | 10 | 0 | | | | |
```

```
INV | 5000 | 100665052 | 10 | 0 | | | | |
```

Appendix: Setup Auto-Authorized Third-Party Stock Count

This section describe steps to setup an auto authorize third party stock count:

1. Set up a product group with counting method as **Third Party** and with auto-authorize flag checked.
2. Create a new product group schedule on the Product Group screen.
3. Add the desired item required for count or select All Department to add all items from Product Group Component Screen.
4. Create the product group schedule for the product group from Product Group Scheduler Screen.
5. Run the Generate Unit Stock Count and Generate Unit and Amount Stock Count jobs to generate the stock counts via Job Admin > Adhoc Job Screen.

Note: After the batch has completed, from the Main Menu go to Inventory Management > Stock Counts > Stock Count List screen on Mobile Application. Notice that a separate stock count record has been created for each department. The batch creates stock count groups for all items for all departments for the store, including items with SOH values of zero grouped by department. For each department record, the Stock Count Type and Status from the stock count list screen will be Type = Stock Count and Status = New.

6. Open the stock count and take a snapshot of the SOH on Stock Count Child List Screen.

The snapshot must be taken before uploading the third-party flat file.

Note: Selecting Take Snapshot takes a snapshot of the current SOH figure, and assigns this to every item in the stock count records. The snapshot button is displayed only if there is an extracted Third Party Stock Count or Unit and Amount stock count on the Stock Count List screen. You must first select at least one record from the Third Party Stock Count in order for the snapshot to be taken. Status of the stock count will change to In Progress. This will indicate that the snapshot has occurred. The user will not be able to access the stock count records until the file has been uploaded. If the user double-clicks one of the department stock counts on the list screen, the application will prompt with the message The stock count will not be accessible until the import process has completed. The user will not be able to drill into the detail screen if the third-party file has not yet been imported into the application.

7. Upload third-party count file:

Once counting is complete, run Third Party Stock Count Import job from Adhoc Jobs Screen to process the data file.

Appendix: Unit and Amount Stock Counts Export

Unit and Amount Stock count authorization generates export file which can be uploaded to external inventory system. The stock count authorization process can be started by user through stock count authorization screen or be invoked by third party stock count batch for an auto-authorized unit amount stock count. The export files can be uploaded to merchandising system (for example, RMS) to update merchandising inventory with the actual physical stock count.

Export File Layout

See the [Stock Count Results Export File Specification](#) for file layout details. The generated file will be zipped into an archive with same file naming standard followed for the file generation. A complete file is added once the generated file is been zipped.

Export File Location

Export file directory is created by application installer. Integration admin will need to move the export data files from the application server export directory to a shared upload network location.

Export File Name

STK_<store id>_<schedule id>_<date in YYYYMMDDHH24MISS format>.dat

STK_<store id>_<schedule id>_<date in YYYYMMDDHH24MISS format>.zip

STK_<store id>_<schedule id>_<date in YYYYMMDDHH24MISS format>.zip.complete

Appendix: UPC Barcode

UPC-E items compress a normal 12-digit UPC-A item into six digits. The application has the ability to decompress UPC-E barcodes to UPC-A. A seventh digit acts as a check digit for the UPC-E number. When the user scans the UPC-E barcode, the application finds the UPC-A barcode and displays the item ID associated with it.

Differences between UPC-A and UPC-E

UPC-E is also called zero suppressed UPC because UPC-E compresses a normal twelve-digit UPC-A number into a six-digit code by suppressing the number system digit, trailing zeros in the manufacturers code and leading zeros in the product identification part of the bar code message. A seventh check digit is encoded into a parity pattern for the six main digits. UPC-E can thus be uncompressed back into a standard UPC-A twelve-digit number.

Note: Most bar code readers can be configured to automatically convert six-digit UPC-E numbers to twelve-digit UPC-A numbers before they are transmitted to a host computer.

The main difference between a UPC-A symbol and a UPC-E symbol is the size. The following image presents a UPC-A bar code (left) and the same data encoded as a UPC-E bar code (right):

Figure G-1 *UPC-A and UPC-E Differences*



To convert between UPC-A and UPC-E bar code numbers, you can use the following table or try online UPC-E converter program. In the following, the number 0 and each of the letters (a, b, c, d and e) represent individual digits in the bar code message. The letter X represents the UPC check digit.

Table G-1 UPC Conversion Table

UPC-A Number	Equivalent UPC-E	Notes
0ab00000cdeX	abcde0X	Manufacturer code must have two leading digits with three trailing zeros and the item number is limited to three digits (000 to 999).
0ab10000cdeX	abcde1X	Manufacturer code must have three leading digits ending with 1 and two trailing zeros. The item number is limited to three digits.
0ab20000cdeX	abcde2X	Manufacturer code must have three leading digits ending with 2 and two trailing zeros. The item number is limited to three digits.
0abc00000deX	abcde3X	Manufacturer code must have three leading digits and two trailing zeros. The item number is limited to two digits (00 to 99).
0abcd00000eX	abcde4X	Manufacturer code must have four leading digits with one trailing zero and the item number is limited to one digit (0 to 9).
0abcde00005X	abcde5X	Manufacturer code has all five digits. The item number is limited to a single digit consisting of either 5, 6, 7, 8 or 9.
0abcde00006X	abcde6X	
0abcde00007X	abcde7X	
0abcde00008X	abcde8X	
0abcde00009X	abcde9X	

Conversion between UPC-A and UPC-E

Not all UPC-A numbers can be compressed to UPC-E. These codes with a corresponding UPC-E code must have at least four zeros. The requirements are:

1. If the manufacturer code ends with 000, 100, or 200, the UPC-E code consists of the first two characters of the manufacturer code, the last three characters of the product code, followed by the third character of the manufacturer code. In this case, the product code must be 00000 and 00999.
2. If the manufacturer code ends with 00 but does not meet the first requirement, the UPC-E code consists of the first three characters of the manufacturer code, the last two characters of the product code, followed by digit 3. The product code can only contain two digits (00000 to 00099).
3. If the manufacturer code ends in 0 but none of the previous qualifies, the UPC-E consists of the first four digits of the manufacturer code and the last digit of the product code, followed by the digit 4. The product code in this case can only contain one digit (00000 to 00009).
4. If the manufacturer code ends with non-zero digit, the UPC-E code consists of the manufacturer code and the last digit of the product code. In this case the product case can only be one from 00005 to 00009 because 0 through 4 has been used for the previous four cases.

Appendix: EICS Provided URLs

EICS web-client URL

Table H-1 EICS Application URL

URL	
EICS web-client	https://<eics_external_load_balanced_address>/sim-web-client

SOCS (connections config) URL

Table H-2 SOCS Connections URL

URL	
EICS (Connections Config)	https://<eics_external_load_balancer_address>/sim-mobile/oracle.retail.sim.mobile.client.SimMobile/connections.xml

EICS Web Service URLs

Table H-3 EICS Web Service URLs

URL	
SIM-WS RSB	https://<eics_external_load_balanced_address>/sim-StoreInventory-AppServiceDecorator/ProxyService/StoreInventoryAppServiceProxy?wsdl
	https://<eics_external_load_balanced_address>/sim-ActivityLock-AppServiceDecorator/ProxyService/ActivityLockAppServiceProxy?wsdl
	https://<eics_external_load_balanced_address>/sim-FulfillmentOrderDelivery-AppServiceDecorator/ProxyService/FulfillmentOrderDeliveryAppServiceProxy?wsdl
	https://<eics_external_load_balanced_address>/sim-FulfillmentOrder-Pick-AppServiceDecorator/ProxyService/FulfillmentOrderPickAppServiceProxy?wsdl
	https://<eics_external_load_balanced_address>/sim-FulfillmentOrderReversePick-AppServiceDecorator/ProxyService/FulfillmentOrderReversePickAppServiceProxy?wsdl

Table H-3 (Cont.) EICS Web Service URLs

URL
<code>https://<eics_external_load_balanced_address>/sim-ItemRequest-AppServiceDecorator/ProxyService/ItemRequestAppServiceProxy?wsdl</code>
<code>https://<eics_external_load_balanced_address>/sim-ItemBasket-AppServiceDecorator/ProxyService/ItemBasketAppServiceProxy?wsdl</code>
<code>https://<eics_external_load_balanced_address>/sim-POSTransaction-AppServiceDecorator/ProxyService/POSTransactionAppServiceProxy?wsdl</code>
<code>https://<eics_external_load_balanced_address>/sim-ProductGroupSchedule-AppServiceDecorator/ProxyService/ProductGroupScheduleAppServiceProxy?wsdl</code>
<code>https://<eics_external_load_balanced_address>/sim-ProductGroup-AppServiceDecorator/ProxyService/ProductGroupAppServiceProxy?wsdl</code>
<code>https://<eics_external_load_balanced_address>/sim-RfidInventory-AppServiceDecorator/ProxyService/RfidInventoryService?WSDL</code>
<code>https://<eics_external_load_balanced_address>/sim-ShelfAdjustment-AppServiceDecorator/ProxyService/ShelfAdjustmentAppServiceProxy?wsdl</code>
<code>https://<eics_external_load_balanced_address>/sim-ShelfReplenishment-AppServiceDecorator/ProxyService/ShelfReplenishmentAppServiceProxy?wsdl</code>
<code>https://<eics_external_load_balanced_address>/sim-SimInfrastructureManager-AppServiceDecorator/ProxyService/SimInfrastructureManagerAppServiceProxy?wsdl</code>
<code>https://<eics_external_load_balanced_address>/sim-StockCount-AppServiceDecorator/ProxyService/StockCountAppServiceProxy?wsdl</code>
<code>https://<eics_external_load_balanced_address>/sim-StoreFulfillmentOrder-AppServiceDecorator/ProxyService/StoreFulfillmentOrderAppServiceProxy?wsdl</code>
<code>https://<eics_external_load_balanced_address>/sim-StoreInventory-AppServiceDecorator/ProxyService/StoreInventoryAppServiceProxy?wsdl</code>
<code>https://<eics_external_load_balanced_address>/sim-StoreInventoryUin-AppServiceDecorator/ProxyService/StoreInventoryUinAppServiceProxy?wsdl</code>
<code>https://<eics_external_load_balanced_address>/sim-StoreInventoryIsn-AppServiceDecorator/ProxyService/StoreInventoryIsnAppServiceProxy?wsdl</code>
<code>https://<eics_external_load_balanced_address>/sim-StoreItemPrice-AppServiceDecorator/ProxyService/StoreItemPriceAppServiceProxy?wsdl</code>
<code>https://<eics_external_load_balanced_address>/sim-Store-AppServiceDecorator/ProxyService/StoreAppServiceProxy?wsdl</code>
<code>https://<eics_external_load_balanced_address>/sim-StoreShipmentManifest-AppServiceDecorator/ProxyService/StoreShipmentManifestAppServiceProxy?wsdl</code>

Table H-3 (Cont.) EICS Web Service URLs

URL
<a href="https://<eics_external_load_balanced_address>/sim-StoreShipmentReason-AppServiceDecorator/ProxyService/StoreShipmentReasonAppServiceProxy?wsdl">https://<eics_external_load_balanced_address>/sim-StoreShipmentReason-AppServiceDecorator/ProxyService/StoreShipmentReasonAppServiceProxy?wsdl
<a href="https://<eics_external_load_balanced_address>/sim-StoreTransfer-AppServiceDecorator/ProxyService/StoreTransferAppServiceProxy?wsdl">https://<eics_external_load_balanced_address>/sim-StoreTransfer-AppServiceDecorator/ProxyService/StoreTransferAppServiceProxy?wsdl
<a href="https://<eics_external_load_balanced_address>/sim-TransferDelivery-AppServiceDecorator/ProxyService/TransferDeliveryAppServiceProxy?wsdl">https://<eics_external_load_balanced_address>/sim-TransferDelivery-AppServiceDecorator/ProxyService/TransferDeliveryAppServiceProxy?wsdl
<a href="https://<eics_external_load_balanced_address>/sim-TransferShipment-AppServiceDecorator/ProxyService/TransferShipmentAppServiceProxy?wsdl">https://<eics_external_load_balanced_address>/sim-TransferShipment-AppServiceDecorator/ProxyService/TransferShipmentAppServiceProxy?wsdl
<a href="https://<eics_external_load_balanced_address>/sim-VendorDelivery-AppServiceDecorator/ProxyService/VendorDeliveryAppServiceProxy?wsdl">https://<eics_external_load_balanced_address>/sim-VendorDelivery-AppServiceDecorator/ProxyService/VendorDeliveryAppServiceProxy?wsdl
<a href="https://<eics_external_load_balanced_address>/sim-VendorReturn-AppServiceDecorator/ProxyService/VendorReturnAppServiceProxy?wsdl">https://<eics_external_load_balanced_address>/sim-VendorReturn-AppServiceDecorator/ProxyService/VendorReturnAppServiceProxy?wsdl
<a href="https://<eics_external_load_balanced_address>/sim-VendorShipment-AppServiceDecorator/ProxyService/VendorShipmentAppServiceProxy?wsdl">https://<eics_external_load_balanced_address>/sim-VendorShipment-AppServiceDecorator/ProxyService/VendorShipmentAppServiceProxy?wsdl

BDI Related URLs

Table H-4 BDI Related URLs

	URL
BDI SIM Job Admin	<a href="https://<eics_external_load_balanced_address>/bdi-sim-batch-job-admin">https://<eics_external_load_balanced_address>/bdi-sim-batch-job-admin
BDI Work Flow	<a href="https://<rics_external_load_balanced_address>/bdi-process-flow">https://<rics_external_load_balanced_address>/bdi-process-flow
BDI Scheduler	<a href="https://<rics_external_load_balanced_address>/bdi-scheduler">https://<rics_external_load_balanced_address>/bdi-scheduler

EICS-RICS Integration URLs

EICS-RICS Message Publishing

Publisher Web Service URL

The message publisher service (SIM -> RIB) is hosted by RIB-SIM. EICS installation takes in the message publisher service WSDL URLs and updates the DB system configuration table.

The WSDL URL can also be updated via EICS System Configuration UI post install.

Table H-5 RIB Message Publishing

Database CONFIG_SYSTEM	System Configuration UI
Name	Display Name
integration.rib.publisher.wsdl.url	Integration Publisher Web Service URL

Web Service User Management

Oracle RICS RIB manages the RIB publisher user.

The publisher user (for example ribadmin) is created as part of the RIB/RTG install.

EICS chef scripts takes the input to add to EICS credential stores.

EICS Install Properties

- input.sim.integration.rib.user.alias=rib-user
- This property is for SIM calling the ApplicationMessagePublishingService. The username and password for the alias should match the user which is created as part of RIB-SIM and belongs to ribAdminGroup.
- The alias name should be unique within the domain, and should not conflict with database data source user alias (for example, in some environment, the SIMRIBAlias is used for db user sim01_RIB, if that is case, choose a different alias for sim -> rib publishing user)

Setting Up RIB Message Injector

Injector Web Service URL

RIB Message Injector Service is hosted in EICS application server.

The WSDL URL is:

```
https://<sim_external_load_balanced_address>/
ApplicationMessageInjector-Bean/InjectorService?WSDL
```

Web Service User Management

The injector user (for example, sim_int) must belong to sim_integration_users group security group, the injector user need to be created as part of EICS provisioning process.

EICS Installation Properties

- input.sim.integration.rib.inject.user.alias
- This property is used for RIB-SIM -> SIM (RIB-SIM calling SIM's injector service), the user is hosted in SIM app and assign integrationRole (sim_integration_users group), the user is created as part of SIM install (for example, sim_int user)

See *Oracle® Retail Integration Bus Implementation Guide* Provisioning InjectorService URL

BI Related URL

Table H-6 BI Related URL

URL	
xmlpserver	https://<eics_external_load_balanced_address>/xmlpserver

ORDS (Apex Data Viewer) URL

Table H-7 ORDS (Apex Data Viewer) URL

URL	
ORDS (Apex Data Viewer)	https://<eics_external_load_balanced_address>/ords

Appendix: Data Seeding Process Flows

- [Data Seeding Process Flows from Merchandising to EICS](#)
- [Data Seeding Mapping Tables between SIOCS and BDI](#)

Data Seeding Process Flows from Merchandising to EICS

The following list shows the Data Seeding Process Flows from Merchandising to EICS with Groups.

Table I-1 Data Seeding Process Flow Dependencies List

Group#	Process Flow	Notes
1	MerchHier_Fnd_ProcessFlow_From_RMS	Merchandise Hierarchy foundation data seed from Merchandising Foundation Data System. Run once for initial full data seed.
1	Supplier_Fnd_ProcessFlow_From_RMS	Supplier foundation data seed from Merchandising Foundation Data System. Run once for initial full data seed.
1	SupplierAddr_Fnd_ProcessFlow_From_RMS	Supplier address foundation data seed from Merchandising Foundation Data System.
1	Partner_Fnd_ProcessFlow_From_RMS	Partner foundation data seed from Merchandising Foundation Data System.
1	PartnerAddr_Fnd_ProcessFlow_From_RMS	Partner address foundation data seed from Merchandising Foundation Data System.
1	Wh_Fnd_ProcessFlow_From_RMS	Run once for initial full warehouse foundation data seed from Merchandising Foundation Data System.
1	WhAddr_ProcessFlow_From_RMS	Run once for initial full warehouse address foundation data seed from Merchandising Foundation Data System.
2	PartOrgUnit_Fnd_ProcessFlow_From_RMS	Run once for initial full partner Org Unit foundation data seed from Merchandising Foundation Data System.
2	ItemHdr_Fnd_ProcessFlow_From_RMS	Run once for initial full item foundation data seed from Merchandising Foundation Data System.

Table I-1 (Cont.) Data Seeding Process Flow Dependencies List

Group#	Process Flow	Notes
2	Uda_Fnd_ProcessFlow_From_RMS	Run once for initial full User Defined Attribute (UDA) foundation data seed from Merchandising Foundation Data System.
2	DiffGrp_Fnd_ProcessFlow_From_RMS	Run once for initial full foundation data seed from Merchandising Foundation Data System.
2	CodeHead_Fnd_ProcessFlow_From_RMS	Run once for initial full Code Head foundation data seed from Merchandising Foundation Data System.
3	PckitemBrkout_Fnd_ProcessFlow_From_RMS	Run once for initial full Pack Item Breakout foundation data seed from Merchandising Foundation Data System.
3	RelatedItem_Fnd_ProcessFlow_From_RMS	Run once for initial full Related Item foundation data seed from Merchandising Foundation Data System.
4	ItemSupplier_Fnd_ProcessFlow_From_RMS	Run once for initial full Item Supplier foundation data seed from Merchandising Foundation Data System.
4	ItSupCtryDim_Fnd_ProcessFlow_From_RMS	Run once for initial full Item Supplier Country Dimension foundation data seed from Merchandising Foundation Data System.
4	ItSupCtry_Fnd_ProcessFlow_From_RMS	Run once for initial full Item Supplier Country foundation data seed from Merchandising Foundation Data System.
4	ItSupCtryManCtry_Fnd_ProcessFlow_From_RMS	Run once for initial full Item Supplier Manufacturing Country foundation data seed from Merchandising Foundation Data System.
4	ItemSuppUom_Fnd_ProcessFlow_From_RMS	Run once for initial full Item Supplier Unit of Measure foundation data seed from Merchandising Foundation Data System.
5	Store_Fnd_ProcessFlow_From_RMS	Run once for initial full store foundation data seed from Merchandising Foundation Data System.
5	StoreAddr_Fnd_ProcessFlow_From_RMS	Run once for initial full store address foundation data seed from Merchandising Foundation Data System.
6	ItemLoc_Fnd_ProcessFlow_From_RMS	Run once for initial full item location foundation data seed from Merchandising Foundation Data System.
6	InvAvailStore_Tx_ProcessFlow_From_RMS	Run once for initial full store available inventory foundation data seed from Merchandising Foundation Data System.
7	ReplItemLoc_Fnd_ProcessFlow_From_RMS	Run once for initial full replenishment item location inventory foundation data seed from Merchandising Foundation Data System.

Table I-1 (Cont.) Data Seeding Process Flow Dependencies List

Group#	Process Flow	Notes
7	PriceHist_Fnd_ProcessFlow_From_RMS	Run once for initial full item pricing history foundation data seed from Merchandising Foundation Data System.
8	ItemImage_Fnd_ProcessFlow_From_RMS	Run once for initial full item image foundation data seed from Merchandising Foundation Data System.
8	UomClass_Fnd_ProcessFlow_From_RMS	Run once for initial full Unit Of Measure foundation data seed from Merchandising Foundation Data System.
8	UdaItemDate_Fnd_ProcessFlow_From_RMS	Run once for initial full UDA Item Date foundation data seed from Merchandising Foundation Data System.
8	UdaItemFF_Fnd_ProcessFlow_From_RMS	Run once for initial full UDA Item Free Form foundation data seed from Merchandising Foundation Data System.
8	UdaItemLov_Fnd_ProcessFlow_From_RMS	Run once for initial full UDA Item LOV foundation data seed from Merchandising Foundation Data System.
8	UdaValues_Fnd_ProcessFlow_From_RMS	Run once for initial full UDA Values foundation data seed from Merchandising Foundation Data System.
9	CodeDetail_Fnd_ProcessFlow_From_RMS	Run once for initial full Code Detail foundation data seed from Merchandising Foundation Data System.
9	DeliverySlot_Fnd_ProcessFlow_From_RMS	Run once for initial full Delivery Slot foundation data seed from Merchandising Foundation Data System.
9	Diff_Fnd_ProcessFlow_From_RMS	Run once for initial full Differentiators foundation data seed from Merchandising Foundation Data System.
9	UomConversion_Fnd_ProcessFlow_From_RMS	Run once for initial full UOM Conversion foundation data seed from Merchandising Foundation Data System.

Data Seeding Mapping Tables between SIOCS and BDI

The table below specifies the Data Seeding Mapping tables Between SIOCS and BDI.

Table I-2 Data Seeding Mapping Tables between SIOCS and BDI

SIOCS Table	BDI Interface Table
ADDRESS	STORE_ADDR_IN PARTNER_ADDR_IN WH_ADDR_IN SUPPLIER_ADDR_IN
DIFFERENTIATOR	DIFF_IN
DIFFERENTIATOR_TYPE	DIFF_IN
ITEM	ITEM_HDR_IN
ITEM_COMPONENT	PACKITEM_BREAKOUT_IN

Table I-2 (Cont.) Data Seeding Mapping Tables between SIOCS and BDI

SIOCS Table	BDI Interface Table
ITEM_HIERARCHY	MERCH_HIER_IN
ITEM_IMAGE	ITEM_IMAGE_IN
ITEM_PRICE	ITEM_LOC_IN (LOC_TYPE = 'S')
ITEM_PRICE_HISTORY	PRICE_HIST_IN
ITEM_UDA	UDA_ITEM_LOV_IN UDA_ITEM_FF_IN UDA_ITEM_DATE_IN
PARTNER	PARTNER_IN
PARTNER_ITEM	ITEM_LOC_IN (LOC_TYPE = 'E')
RELATED_ITEM	RELATED_ITEM_IN
RELATED_ITEM_TYPE	RELATED_ITEM_TYPE
STORE	STORE_IN
STORE_ITEM	ITEM_LOC_IN (LOC_TYPE = 'S') REPL_ITEM_LOC_IN
STORE_ITEM_STOCK	INV_AVAIL_STORE_IN
STORE_TRANSFER_ZONE	STORE_IN
SUPPLIER	SUPS_IN
SUPPLIER_ITEM	ITEM_SUPPLIER_IN
SUPPLIER_ITEM_COUNTRY	ITEM_SUPP_COUNTRY_IN
SUPPLIER_ITEM_COUNTRY_DIM	ITEM_SUP_CTY_DIM_IN
SUPPLIER_ITEM_MANUFACTURE	ITEM_SUP_MAN_CTY_IN
SUPPLIER_ITEM_UOM	ITEM_SUPP_UOM_IN
SUPPLIER_ORGANIZATION	PARTNER_ORG_UNIT_IN
UDA	UDA_IN
UDA_LOV	UDA_VALUES_IN
UOM_CLASS	UOM_CLASS_IN
UOM_CONVERSION	UOM_CONVERSION_IN
WAREHOUSE	WH_IN
WAREHOUSE_ITEM	ITEM_LOC_IN (LOC_TYPE = 'W')

Appendix: Pricing Import with On-premise RPM

This section is only applicable for EICS to integration with customer have on-premise RPM, RPM pricing files are placed on EICS SFTP incoming locations, and the file import job processes each file from incoming directory when a corresponding completer file presents. The completer is a zero byte file which indicates file transfer is complete and ready for processing. The reject files will be pushed to outgoing for client review.

Note: Pricing file import from On-premise RPM will be phased out in future releases.

- [Clearance Price Change Import with On-premise RPM](#)
- [Promotion Price Change Import with On-premise RPM](#)
- [Regular Price Change Import with On-premise RPM](#)

Clearance Price Change Import with On-premise RPM

This batch imports the clearance price changes from flat file into item price table. Each file contains price change record for a single location. Files with location type of store (file name with suffix of "S") are relevant to EICS. The import process skips file with location type which are not store.

There are two phases involve in the batch process. The file load phase loads the file into price change worksheet table; the extract phase kicks off multiple threads to extract the approved worksheet records into item price table.

To optimize price change batch import process, admin user can change the system configuration parameter 'DAYS_TO_HOLD_PRICE_CHANGE_WORKSHEET' value to 0, the completed staged worksheet records will be deleted after price change records are extracted into item_price table.

File Specification

File Name Format: CLRPC_<date in YYYYMMDDHH24MISS format>_<loc type>

Where <loc type> can be S (store) or W (Warehouse), EICS only process files which have loc_type of S.

File Layout: See [Clearance Price Change Import File Layout Specification](#).

Batch Job Definition Name

ClearancePriceChange_OpsJob

Batch Job Parameters

<File name>

If not specified, then the data file in incoming directory are processed.

File Error Handling

The batch job will be marked as failed if the file staging fails. The staging process is all or none transaction so if an error occurs during the batch process, none of the transactions in the file will be staged. The user will need to rerun the same file again after resolving any errors.

Key Tables**Table J-1 Key Tables for Clearance Price Change with On-premise RPM**

Tables	Select	Insert	Update	Delete
batch_execution	Yes	Yes	Yes	
price_change_worksheet	Yes	Yes	Yes	Yes
Item_price	Yes	Yes	Yes	

Promotion Price Change Import with On-premise RPM

This batch imports the promotion price changes from flat file into item price table.

There are two phases involve in the batch process. The file load phase loads the file into price change worksheet table; the extract phase kicks off multiple threads to extract the approved worksheet records into item price table.

To optimize price change batch import process, admin user can change the system configuration parameter 'DAYS_TO_HOLD_PRICE_CHANGE_WORKSHEET' value to 0, the completed staged worksheet records will be deleted after price change records are extracted into item_price table.

File Specification

File Name format: PRMPC_<date in YYYYMMDDHH24MISS format>_<loc id>_<loc type>

Where <loc type> can be S (store) or W (Warehouse), EICS only process files which have loc_type of S.

File Layout: See [Promotion Price Change Import File Layout Specification](#).

Batch Job Definition Name

PromotionPriceChange_OpsJob

Batch Job Parameters

<File name>

If not specified, then the data file in incoming directory are processed.

File Error Handling

The batch job will be marked as failed if the file staging fails. The staging process is all or none transaction so if an error occurs during the batch process, none of the transactions in the file will be staged. The user will need to rerun the same file again after resolving any errors.

Key Tables**Table J-2 Key Tables for Promotion Price Change with On-premise RPM**

Tables	Select	Insert	Update	Delete
price_change_worksheet	Yes		Yes	Yes
Item_price	Yes	Yes	Yes	
config_store	Yes			
item_uda	Yes			
print_format_type	Yes			

Regular Price Change Import with On-premise RPM

This batch imports the regular price changes from flat file into item price table.

There are two phases involve in the batch process. The file load phase loads the file into price change worksheet table; the extract phase kicks off multiple threads to extract the approved worksheet records into item price table.

To optimize price change batch import process, admin user can change the system configuration parameter 'DAYS_TO_HOLD_PRICE_CHANGE_WORKSHEET' value to 0, the completed staged worksheet records will be deleted after price change records are extracted into item_price table.

File Specification

File Name format: REGPC_<date in YYYYMMDDHH24MISS format>_<loc id>_<loc type>

Where <loc type> can be S (store) or W (Warehouse), EICS only process files which have loc_type of S.

File Layout: See [Regular Price Change Import File Layout Specification](#).

Batch Job Definition Name

RegularPriceChange_OpsJob

Batch Job Parameters

<File name>

If not specified, then the data file in incoming directory are processed.

File Error Handling

The batch job will be marked as failed if the file staging fails. The staging process is all or none transaction so if an error occurs during the batch process, none of the transactions in the file will be staged. The user will need to rerun the same file again after resolving any errors.

Key Tables**Table J-3 Key Tables for Regular Price Change with On-premise RPM**

Tables	Select	Insert	Update	Delete
price_change_worksheet	Yes	Yes	Yes	Yes
Item_price	Yes	Yes	Yes	
config_store	Yes			

Table J-4 Key Tables for Regular Price Change Batch

Tables	Select	Insert	Update	Delete
item_uda	Yes			
print_format_type	Yes			
batch_execution	Yes	Yes	Yes	

Appendix: Open Transaction Seed

Overview

Merchandising Solution usually goes live prior to the SIOCS system. The integration layer supports the flow of foundation data via BDI (bulk data import) process or via RIB Messages. As the customer is currently in the transition phase that is, cutover from old system to Oracle Cloud Solution, the complete transaction freeze for the stores may not be achievable. There would be few transactions which would be currently in In-Progress states which means they are either not fully received, closed or cancelled. This data needs to be imported into SIOCS as these are open transactions.

Third Party Open TX data imports open transaction data for three main areas.

1. Purchase Order
2. Direct Store Deliveries from Supplier
3. Transfer / Allocations

Third party transaction import is considered to be one time activity before go live and not a practice for transactional data flow. The system would allow creating new transaction and updating existing transaction only if the sanity of the transaction i.e. the current state in SIOCS database is same.

As the transaction import is from external system the identifier generated for the transactions on the external system will also be mapped to the external identifier of SIOCS transactional data.

The complete integration of data import direct from Merchandising similar to foundation data import is currently not supported. The implementation team would be responsible for source this data via flat file via BDI CLI (command line interface).

The BDI CLI will process this data and post this to SIOCS BDI tables and return a unique generated data set identifier. This identifier can then be used to process this data further to SIOCS database.

The following Transaction Import batches are independent of each other and would be responsible for processing the transaction to SIOCS database.

Direct Delivery - Transaction Import

Imports the direct delivery transaction imported from Merchandising / Third Party System posted on SIOCS BDI table i.e. EXT_DSD_IN. The job supports only creation of the deliveries of ASN types. Data validation is also part of processing and proper error mechanism will log the error against each batch execution. This job do not support the importing UINs and Custom Attributes.

Transfer - Transaction Import

Imports the transfer and allocation records from Merchandising / Third Party System posted on SIOCS BDI table that is, EXT_TSF_IN. The job support creates the transfer / allocation records in SIOCS database and makes them accessible on UI for users to use them. The inventory in-transit calculation post the importing of transaction will also be taken care by this batch job. Data validation is also part of processing and proper error mechanism will log the error against each batch execution.

Purchase Order - Transaction Import

Import the purchase order records from Merchandising / Third Party System posted on SIOCS BDI table that is, EXT_PURCH_ORDER. This job creates the purchase order records in SIOCS database and makes them accessible on UI for users to use them. Data validation is also part of processing and proper error mechanism will log the error against each batch execution.

The job would be available for the Admin user who is authorized to access/run the Data Seeding batch processes via EICS user interface. User will need to navigate to following screen to access and run these batch processes.

1. Login to EICS via browser
2. On Navigation Menu select Admin - Technical Maintenance - Job Admin - Data Seed
3. User will be navigate to Data Seed Screen.
4. Select the above mention job and specify the data set identifier.
5. Click on Start Job.
6. User would be navigate to Job Admin Screen.

In case of failure the job will be listed to Job Admin Screen (as default filter criteria load the failed batch job records). User can click on the link and navigate to the detail screen to see the exact reason of failure.

Technical Design

The technical design for this requirement was made in considering that the data can be posted without any constraint being applied on the database level. This will be help speeding up the data being available for the SIOCS batch jobs to process them further.

The following are few key points for the technical design of transaction data import:

1. Flattening the database tables

Flattened database architecture makes the query execution much faster than the normalized form. Each row on the table would denote a line item with complete information of the transaction it belong to and what line item attribute values are.

This reduces the overhead cost of join and querying multiple tables to get the complete transaction detail identified by a particular identifier.

Each Column would mapped to the data column of the SIOCS transactional tables. Flatten tables on SIOCS BDI are mapped as follow:

Table K-1 Flattened Database Table Mapping

Flattened Table	SIOCS Transactional Tables
EXT_DSD_IN	DSD
	DSD_CARTON
	DSD_LINE_ITEM
	DSD_ADJUSTMENT
EXT_TSF_IN	TSF
	TSF_LINE_ITEM
	TSF_ALLOCATION
EXT_PURCH_ORDER_IN	PURCHASE_ORDER
	PURCHASE_ORDER_LINE_ITEM

For the detail column level mapping please refer to the [Data Mapping](#) section.

2. Data Validation

First and foremost step of the transaction import is validating the data against the values available. The transaction import batch processes would validate the complete data as the data would then be processed to the SIOCS transaction tables. The basic validations which would be performed are as follows:

- a. Is transaction for a valid store?
- b. Is transaction from a valid source? (store, warehouse, finisher or supplier)
- c. Is item identifier exist on item master table of SIOCS database?
- d. Is the status / types specified on data denotes valid information as per the SIOCS technical design?

Please refer to [Exception Handling](#) section for more details.

3. Parallel Processing

The batch process will split the data into partition by the transaction external identifiers to support the parallel processing of the transaction import. Each partition will contain the list of transaction identifiers which are to be processed. The number of partition in which the data would be divided is defined by an existing system admin configuration parameter (Batch Maximum Threads). The default value for this parameter is set to 5. Each thread would be assigned a partition to be processed.

So if there are 10000 transactions to be imported 5 separate thread processed would be instantiated to process a work load of 2000 transactions per thread.

The partition feature used here is as per JSR 352 specification defined for Java EE 7 and Java SE 6 platforms.

4. Data Import

The partitioned transaction external identifier will be validated against the existing transactions on the SIOCS database (if any exists). If the no matching transactions are found, a new transaction would be added to the respective transaction table. If the transaction identifier match to an existing record, then that

transaction would be updated the latest data from the flattened staging table. The data import process does not update the state of transaction.

The data import processes the data into chunks and failover mechanism is added to process the correct data and mark the invalid data as failed. This also helps improving the server performance as not all transactions on a partition are imported at one go. The chunk process will further break the partition in sub-lists and process the data in group of records reducing the server overhead and memory consumption.

5. Inventory Correction

The inventory correction logic is not applicable for purchase order processing as there are no inventory bucket to be updated.

For the transfer transaction which are currently approved, the transfer reserved bucket of the item's inventory at source store need to be corrected once the transaction is successfully imported into the system.

For the Direct Store Delivery transaction (if associated with customer order), picking quantity would need to be updated when the received delivery is created depending on a system parameter.

Below are the configuration parameter to be considered while processing the direct store delivery which has a container in Received status.

Table K-2 Configuration Parameters for DSD Received Status

Parameter Name	Description
Reserve Customer Order Inventory Upon Receiving	Update the customer order reserved bucket while creating a new transaction.
Auto Pick On Receive - Direct Delivery	Will update the picked quantity on customer order (if exists).
Auto Pick Mixed Containers	Will update the picked quantity on customer order (if exist) for a container which contains both customer order related items and normal items.

Technical Architecture

The diagram below depicts the high level architecture of Transaction Import Process Flow.

Figure K-1 Transaction Import Process Flow

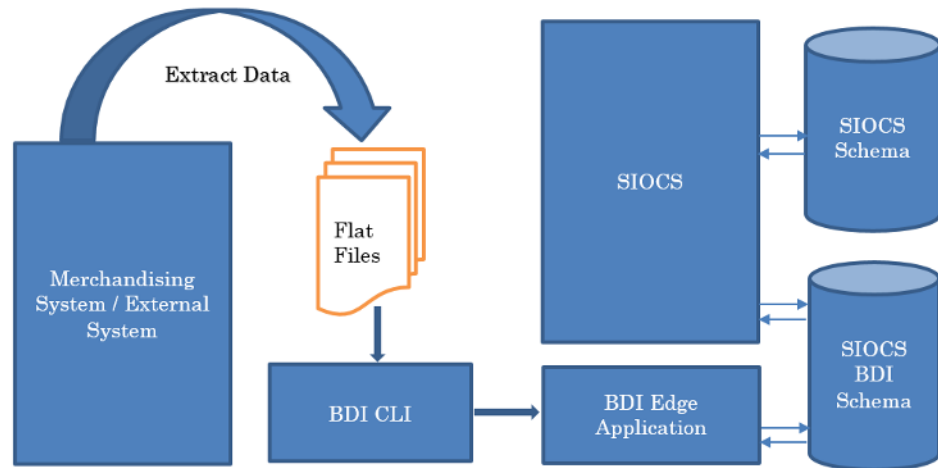

1. Merchandising System / External System

The Merchandising / External system is the source for transaction import data.

2. Extracting Data

System implementer / Consulting Team will be responsible to extract the transactions to be imported in SIOCS to flat files. This flat files are feed to the BDI command line interface to further process and import the data from files to the BDI Schema.

3. BDI Processing

BDI command line interface will read the data on the files and create the record on SIOCS BDI Schema _OUT table. This table maps to _IN (Flattened Table) on SIOCS BDI Schema. Once the records are created on the SIOCS BDI table, a control record for the module and interface will be added. The data control id would be returned to the user which can used on EICS to start the batch process.

4. SIOCS Batch Process

Using the control id generated by BDI process user will need to start the job to process the record from SIOCS BDI schema to SIOCS schema. To start the batch job user will need to login to EICS Application and navigate to:

Admin - Technical Maintenance - Job Admin - Data Seed

User can select the appropriate batch job from the drop down, enter the data control id and start the job.

Data Process Flow

The flow chart below shows the process of data flow for the Transaction Import Batch Process once the data is available in SIOCS BDI Tables.

Figure K-2 Transaction Import Batch Process Data Process Flow

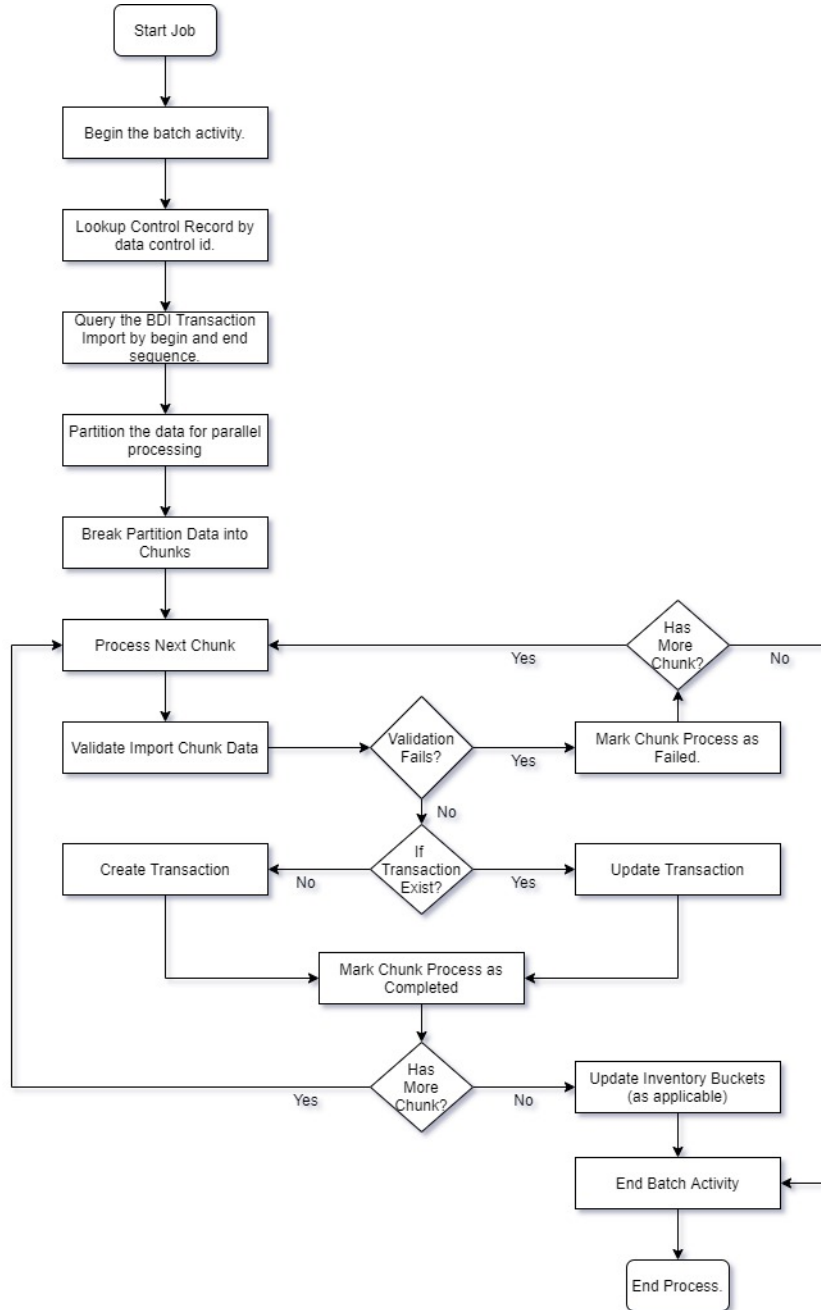

Exception Handling

This section describe the error message with which batch would be marked as failed due to the invalid data on transaction import file.

Each error message will be prefixed with following text to denote the error recorded is for which particular row value in respective BDI transaction import table.

Prefix Text: Validation failed for Row Sequence: <BDI_SEQ_ID>

Table K-3 1. Purchase Order

Error	Cause	Data Column with Error
Purchase Order:<PO_EXT_ID> has invalid store information.	Store identifier is not a valid store for a new purchase order.	PO_STORE
Purchase Order:<PO_EXT_ID> has invalid supplier information.	Supplier identifier is not a valid supplier for a new purchase order.	PO_SUPPLIER
Purchase Order:<PO_EXT_ID> has no status information.	Status is either null or not valid value for purchase order status for a new purchase order.	PO_STATUS
Purchase Order:<PO_EXT_ID> has no external status information.	External status is either null or not valid value for purchase order external status for a new purchase order.	PO_EXT_STATUS
Purchase Order:<PO_EXT_ID> has invalid store information that does not match to existing transaction.	Store identifier doesn't match to the existing purchase order.	PO_STORE
Purchase Order:<PO_EXT_ID> has invalid supplier information that does not match to existing transaction.	Supplier identifier doesn't match to the existing purchase order.	PO_SUPPLIER
Purchase Order:<PO_EXT_ID> has invalid status code.	Status is either null or not valid value for purchase order status for an existing purchase order.	PO_STATUS
Purchase Order:<PO_EXT_ID> has status which does not match the existing data.	Status is not same as that for the existing purchase order.	PO_STATUS
Purchase Order:<PO_EXT_ID> has external status information which is not valid for existing transaction.	External status is either null or not a valid value for an existing transaction.	PO_EXT_STATUS
Purchase Order:<PO_EXT_ID> Item:<ITEM_ID> is not ranged for store.	Item is not range to the store.	PO_LINE_ITEM PO_STORE
Purchase Order:<PO_EXT_ID> Item:<ITEM_ID> is not ranged for supplier.	Item is not ranged to the supplier.	PO_LINE_ITEM PO_SUPPLIER
Purchase Order:<PO_EXT_ID> Item:<ITEM_ID> has no supplier country information.	Item Supplier country information is not available on the SIOCS.	PO_LINE_ITEM PO_SUPPLIER PO_LINE_SUPP_COUNTRY

Table K-4 2. Transfer

Error	Cause	Data Column with Error
Transfer:<TSF_EXT_ID> has invalid source information.	Transfer source is not valid.	TSF_SRC
Transfer:<TSF_EXT_ID> has invalid destination information.	Transfer destination is not valid.	TSF_DEST
Transfer:<TSF_EXT_ID> is not a valid store transfer.	Transfer is not valid store transfer that is, both source and destination is not a store.	TSF_SRC_TYPE TSF_DEST_TYPE
Transfer:<TSF_EXT_ID> has invalid status information.	Transfer Status is null or not valid value.	TSF_STATUS
Transfer:<TSF_EXT_ID> has source identifier which does not match the existing data.	Transfer source identifier does not match to the existing transfer transaction on SIOCS.	TSF_SRC
Transfer:<TSF_EXT_ID> has destination identifier which does not match the existing data.	Transfer destination identifier does not match to the existing transfer transaction on SIOCS.	TSF_DEST
Transfer:<TSF_EXT_ID> has status which does not match the existing data.	Transfer status does not match to the existing transaction state on SIOCS.	TSF_STATUS
Transfer:<TSF_EXT_ID> is already approved and use available flag value doesn't match existing data.	Use available flag is changed for the existing approved transfer transaction.	TSF_USE_AVAILABLE
Transfer:<TSF_EXT_ID> has no source type information.	Transfer source type is either null or an invalid value.	TSF_SRC_TYPE
Transfer:<TSF_EXT_ID> has no destination type information.	Transfer destination type is either null or an invalid value.	TSF_DEST_TYPE
Transfer:<TSF_EXT_ID> Item:<ITEM_ID> is not ranged for source.	Item is not ranged for the source.	TSF_LINE_ITEM TSF_SRC
Transfer:<TSF_EXT_ID> Item:<ITEM_ID> is not ranged for destination.	Item is not ranged for the destination.	TSF_LINE_ITEM TSF_DEST

Table K-5 3. Allocation

Error	Cause	Data Column with Error
Allocation:<TSF_ALLOCATION_ID> has source information which does not match existing data.	Allocation source is not valid for the existing transaction.	TSF_SRC
Allocation:<TSF_ALLOCATION_ID> has invalid source information.	Allocation source is either null or not a valid value.	TSF_SRC
Allocation:<TSF_ALLOCATION_ID> has invalid destination information.	Allocation destination is either null or not a valid value.	TSF_DEST

Table K-5 (Cont.) 3. Allocation

Error	Cause	Data Column with Error
Allocation:<TSF_ALLOCATION_ID> Item:<ITEM_ID> is not ranged for source.	Item is not ranged to the allocation source.	TSF_LINE_ITEM TSF_SRC
Allocation:<TSF_ALLOCATION_ID> Item:<ITEM_ID> is not ranged for destination.	Item is not ranged to the allocation destination.	TSF_LINE_ITEM TSF_DEST
Allocation:<TSF_ALLOCATION_ID> has invalid status code.	Allocation status is not valid.	TSF_STATUS
Allocation:<TSF_ALLOCATION_ID> has status which does not match the existing data.	Allocation status does not match to the existing transaction status.	TSF_STATUS
Allocation:<TSF_ALLOCATION_ID> has no expected quantity.	Allocation quantity is null.	TSF_LINE_EXPECTED

Table K-6 4. Direct Store Delivery (DSD)

Error	Cause	Data Column with Error
DSD ASN is null.	DSD ASN is null.	DSD_ASN
DSD:<ASN> has invalid store identifier.	Store identifier is either null or not a valid store.	DSD_STORE
DSD:<ASN> has invalid supplier identifier.	Supplier identifier is either null or not a valid supplier.	DSD_SUPPLIER
DSD:<ASN> has invalid status code.	Delivery status is either null or not a valid status value.	DSD_STATUS
DSD:<ASN> has invalid carrier type code.	Specified Carrier Type value is not valid.	DSD_CARRIER_TYPE
DSD:<ASN> has store identifier which doesn't matches to existing delivery.	Store identifier does not match to the existing delivery transaction.	DSD_STORE
DSD:<ASN> has supplier identifier which doesn't matches to existing delivery.	Supplier identifier does not match to the existing delivery transaction.	DSD_SUPPLIER
DSD:<ASN> has invalid status code for existing delivery.	Status code is either null or an invalid value for an existing delivery.	DSD_STATUS
DSD:<ASN> has status which does not match the existing data.	Status code does not match the current status of the existing delivery transaction.	DSD_STATUS
DSD:<ASN> is in <DELV_STATUS> status and has one or more container in open state.	Delivery is currently is received status however few container record are in open state on import data.	DSD_STATUS DSD_CARTON_STATUS

Table K-6 (Cont.) 4. Direct Store Delivery (DSD)

Error	Cause	Data Column with Error
DSD:<ASN> is in <DELV_STATUS> status and has one or more container in open or completed state.	Delivery is in cancel/rejected status however few of the containers on delivery are either completed or open.	DSD_STATUS DSD_CARTON_STATUS
DSD:<ASN> Container Identifier is null or invalid.	Container identifier is either null or an invalid value.	DSD_CARTON_EXT_ID
DSD Container:<CARTON_EXT_ID> has invalid status code.	Container status is either null or invalid value for status.	DSD_CARTON_STATUS
DSD Container:<CARTON_EXT_ID> has invalid store identifier.	Container store is either null or not a valid store.	DSD_CARTON_STORE
DSD Container:<CARTON_EXT_ID> has store identifier which doesn't match to delivery information.	Container store does not match the delivery store identifier.	DSD_CARTON_STORE DSD_STORE
DSD Container:<CARTON_EXT_ID> has store identifier which doesn't matches to existing carton.	Container store does not matches to the store identifier for an existing container.	DSD_CARTON_STORE
DSD Container:<CARTON_EXT_ID> has invalid status code.	Container status value is either null or not a valid status value.	DSD_CARTON_STATUS
DSD Container:<CARTON_EXT_ID> has status which does not match the existing data.	Container status does not match the status of existing container.	DSD_CARTON_STATUS
DSD Container:<CARTON_EXT_ID> has invalid order related code.	Order Related flag has an invalid code.	DSD_CARTON_CUST_ORD_RELATED
DSD Line Item:<ITEM_ID> is not ranged for store.	Item is not ranged to the store.	DSD_LINE_ITEM DSD_LINE_STORE
DSD Line Item:<ITEM_ID> is not ranged for supplier.	Item is not ranged to the supplier.	DSD_LINE_ITEM DSD_SUPPLIER
DSD Line Item:<ITEM_ID> has invalid store identifier.	Store identifier for line item is either null or not a valid store.	DSD_LINE_ITEM DSD_LINE_STORE
DSD Line Item:<ITEM_ID> has store identifier which does not match to carton information.	Store identifier for line item does not matches to the container store identifier.	DSD_LINE_STORE DSD_CARTON_STORE
DSD Line Item:<ITEM_ID> has invalid purchase order identifier.	Purchase Order external identifier for line item is not valid.	DSD_LINE_PO_EXT_ID
DSD Line Item:<ITEM_ID> has store identifier which does not match to existing line item information.	Store identifier for line item does not matches the store identifier for an existing line item.	DSD_LINE_STORE
DSD Adjustment Item:<ITEM_ID> is not ranged for store.	Adjustment Item is not ranged to the store.	DSD_ADJ_ITEM DSD_STORE

Table K-6 (Cont.) 4. Direct Store Delivery (DSD)

Error	Cause	Data Column with Error
DSD Adjustment Item:<ITEM_ID> is not ranged for supplier.	Adjustment Item is not ranged to the supplier.	DSD_ADJ_ITEM DSD_SUPPLIER
DSD Adjustment Item:<ITEM_ID> has invalid purchase order external identifier.	Adjustment Item has an invalid purchase order identifier.	DSD_ADJ_PO_EXT_ID
DSD Adjustment Item:<ITEM_ID> has invalid adjustment date.	Adjustment data is set to null.	DSD_ADJ_DATE
DSD Adjustment Item:<ITEM_ID> has invalid adjustment quantity.	Adjustment quantity is not specified.	DSD_ADJ_QUANTITY

Data Mapping

The table below specifies the database column mapping for the each functional area.

1. Direct Store Delivery from Supplier (DSD Receiving)

BDI Transaction Import Table: EXT_DSD_IN

BDI Column	Mapped Column	Mapped Column Table
DSD_ASN	ASN_ID	DSD
DSD_STORE	STORE_ID	DSD
DSD_SUPPLIER	SUPPLIER_ID	DSD
DSD_STATUS	STATUS	DSD
DSD_EXPECTED_DATE	EXPECTED_DATE	DSD
DSD_CREATE_DATE	CREATE_DATE	DSD
DSD_UPDATE_DATE	UPDATE_DATE	DSD
DSD_RECEIVED_DATE	RECEIVED_DATE	DSD
DSD_INVOICE	INVOICE_ID	DSD
DSD_INVOICE_DATE	INVOICE_DATE	DSD
DSD_CREATE_USER	CREATE_USER	DSD
DSD_CUST_ORD_ID	CUST_ORDER_ID	DSD
DSD_FUL_ORD_EXT_ID	FUL_ORD_EXTERNAL_ID	DSD
DSD_CARRIER_ENTITY	CARRIER_ENTITY	DSD
DSD_CARRIER_TYPE	CARRIER_TYPE	DSD
DSD_CARRIER_CODE	CARRIER_CODE	DSD
DSD_COUNTRY_CODE	COUNTRY_CODE	DSD
DSD_SOURCE_ADDRESS	SOURCE_ADDRESS	DSD
DSD_LICENSE_PLATE	LICENSE_PLATE	DSD
DSD_FREIGHT_ID	FREIGHT_ID	DSD

BDI Column	Mapped Column	Mapped Column Table
DSD_CURRENCY_CODE	CURRENCY_CODE	DSD
DSD_INVOICE_COST	INVOICE_COST_VALUE	DSD
DSD_RECEIVED_USER	RECEIVED_USER	DSD
DSD_UPDATE_USER	UPDATE_USER	DSD
DSD_BOL_EXT_ID	BOL_EXTERNAL_ID	DSD
DSD_ADJ_PO_EXT_ID	PURCHASE_ORDER_EXT_ID	DSD_ADJUSTMENT
DSD_ADJ_ITEM	ITEM_ID	DSD_ADJUSTMENT
DSD_ADJ_DATE	ADJUSTMENT_DATE	DSD_ADJUSTMENT
DSD_ADJ_QUANTITY	ADJUSTMENT_QUANTITY	DSD_ADJUSTMENT
DSD_CARTON_EXT_ID	EXTERNAL_ID	DSD_CARTON
DSD_CARTON_STATUS	STATUS	DSD_CARTON
DSD_CARTON_STORE	STORE_ID	DSD_CARTON
DSD_CARTON_REFERENCE_ID	REFERENCE_ID	DSD_CARTON
DSD_CARTON_DAMAGED_REASON	DAMAGED_REASON	DSD_CARTON
DSD_CARTON_SERIAL_CODE	SERIAL_CODE	DSD_CARTON
DSD_CARTON_TRACKING_NUMBER	TRACKING_NUMBER	DSD_CARTON
DSD_CARTON_DAMAGE_REMAINING	DAMAGE_REMAINING	DSD_CARTON
DSD_CARTON_CREATE_USER	CREATE_USER	DSD_CARTON
DSD_CARTON_UPDATE_USER	UPDATE_USER	DSD_CARTON
DSD_CARTON_RECEIVE_USER	RECEIVE_USER	DSD_CARTON
DSD_CARTON_CREATE_DATE	CREATE_DATE	DSD_CARTON
DSD_CARTON_UPDATE_DATE	UPDATE_DATE	DSD_CARTON
DSD_CARTON_RECEIVE_DATE	RECEIVE_DATE	DSD_CARTON
DSD_CARTON_UIN_REQUIRED	UIN_REQUIRED	DSD_CARTON
DSD_CARTON_RCV_AT_SHOP_FLOOR	RECEIVE_AT_SHOP_FLOOR	DSD_CARTON
DSD_CARTON_QUALITY_CONTROL	QUALITY_CONTROL	DSD_CARTON
DSD_CARTON_EXTERNAL_CREATE	EXTERNAL_CREATE	DSD_CARTON
DSD_CARTON_ADJUSTED	ADJUSTED	DSD_CARTON
DSD_CARTON_CUST_ORD_RELATED	CUSTOMER_ORDER_RELATED	DSD_CARTON
DSD_LINE_ITEM	ITEM_ID	DSD_LINE_ITEM
DSD_LINE_CASE_SIZE	CASE_SIZE	DSD_LINE_ITEM
DSD_LINE_EXPECTED	QUANTITY_EXPECTED	DSD_LINE_ITEM
DSD_LINE_RECEIVED	QUANTITY_RECEIVED	DSD_LINE_ITEM
DSD_LINE_DAMAGED	QUANTITY_DAMAGED	DSD_LINE_ITEM
DSD_LINE_UNIT_COST_CURR	UNIT_COST_CURRENCY	DSD_LINE_ITEM

BDI Column	Mapped Column	Mapped Column Table
DSD_LINE_UNIT_COST_VAL	UNIT_COST_VALUE	DSD_LINE_ITEM
DSD_LINE_OVRD_UNIT_COST_CURR	OVERRIDE_UNIT_COST_CURRENCY	DSD_LINE_ITEM
DSD_LINE_OVRD_UNIT_COST_VAL	OVERRIDE_UNIT_COST_VALUE	DSD_LINE_ITEM
DSD_LINE_STORE	STORE_ID	DSD_LINE_ITEM
DSD_LINE_PO_EXT_ID	PURCHASE_ORDER_EXT_ID	DSD_LINE_ITEM
DSD_LINE_CUST_ORD_ID	CUST_ORDER_ID	DSD_LINE_ITEM
DSD_LINE_FUL_ORD_EXT_ID	FUL_ORD_EXTERNAL_ID	DSD_LINE_ITEM
DSD_LINE_VPN	VENDOR_PRODUCT_NUMBER	DSD_LINE_ITEM
DSD_LINE_RECEIVED_OVER	QUANTITY_RECEIVED_OVER	DSD_LINE_ITEM
DSD_LINE_DAMAGED_OVER	QUANTITY_DAMAGED_OVER	DSD_LINE_ITEM
DSD_LINE_PREV_RECEIVED	PREVIOUS_RECEIVED	DSD_LINE_ITEM
DSD_LINE_PREV_DAMAGED	PREVIOUS_DAMAGED	DSD_LINE_ITEM

2. Transfers

BDI Transaction Import Table: EXT_TSF_IN

Column TSF_DOC_TYPE = T denotes the transaction is transfer.

BDI Column	Mapped Column	Mapped Column Table
TSF_EXT_ID	EXTERNAL_ID	TSF
TSF_SRC_TYPE	SOURCE_TYPE	TSF
TSF_SRC	SOURCE_ID	TSF
TSF_DEST_TYPE	DESTINATION_TYPE	TSF
TSF_DEST	DESTINATION_ID	TSF
TSF_STATUS	STATUS	TSF
TSF_CREATE_USER	CREATE_USER	TSF
TSF_UPDATE_USER	UPDATE_USER	TSF
TSF_APPROVAL_USER	APPROVAL_USER	TSF
TSF_CREATE_DATE	CREATE_DATE	TSF
TSF_UPDATE_DATE	UPDATE_DATE	TSF
TSF_APPROVAL_DATE	APPROVAL_DATE	TSF
TSF_CONTEXT_ID	CONTEXT_ID	TSF
TSF_CONTEXT_VALUE	CONTEXT_VALUE	TSF
TSF_CUST_ORD_ID	CUST_ORD_EXTERNAL_ID	TSF
TSF_FUL_ORD_EXT_ID	FUL_ORD_EXTERNAL_ID	TSF

BDI Column	Mapped Column	Mapped Column Table
TSF_PARTIAL_DELIVERY_IND	ALLOW_PARTIAL_DELIVERY	TSF
TSF_AUTH_CODE	AUTHORIZATION_CODE	TSF
TSF_NOT_AFTER_DATE	NOT_AFTER_DATE	TSF
TSF_REQUEST_DATE	REQUEST_DATE	TSF
TSF_REQUEST_USER	REQUEST_USER	TSF
TSF_USE_AVAILABLE	USE_AVAILABLE	TSF
TSF_LINE_ITEM	ITEM_ID	TSF_LINE_ITEM
TSF_LINE_CASE_SIZE	CASE_SIZE	TSF_LINE_ITEM
TSF_LINE_REQUESTED	QUANTITY_REQUESTED	TSF_LINE_ITEM
TSF_LINE_APPROVED	QUANTITY_APPROVED	TSF_LINE_ITEM
TSF_LINE_SHIPPING	QUANTITY_SHIPPING	TSF_LINE_ITEM
TSF_LINE_SHIPPED	QUANTITY_SHIPPED	TSF_LINE_ITEM
TSF_LINE_RECEIVED	QUANTITY_RECEIVED	TSF_LINE_ITEM
TSF_LINE_DAMAGED	QUANTITY_DAMAGED	TSF_LINE_ITEM
TSF_LINE_PREFERRED_UOM	PREFERRED_UOM	TSF_LINE_ITEM

3. Transfer Allocations

BDI Transaction Import Table: EXT_TSF_IN

Column TSF_DOC_TYPE = A denotes the transaction is transfer allocation.

BDI Column	Mapped Column	Mapped Column Table
TSF_EXT_ID	EXTERNAL_ID	TSF_ALLOCATION
TSF_DELIVERY_DATE	DELIVERY_DATE	TSF_ALLOCATION
TSF_LINE_ITEM	ITEM_ID	TSF_ALLOCATION
TSF_DEST	STORE_ID	TSF_ALLOCATION
TSF_DELV_SLOT_ID	DELIVERY_SLOT_ID	TSF_ALLOCATION
TSF_SRC	SOURCE_ID	TSF_ALLOCATION
TSF_SRC_TYPE	SOURCE_TYPE	TSF_ALLOCATION
TSF_CONTEXT_VALUE	CONTEXT_VALUE	TSF_ALLOCATION
TSF_LINE_DIST_PARENT_ID	DISTRIBUTION_PARENT_ID	TSF_ALLOCATION
TSF_STATUS	STATUS	TSF_ALLOCATION
TSF_LINE_EXPECTED	QUANTITY_EXPECTED	TSF_ALLOCATION
TSF_LINE_RECEIVED	QUANTITY_RECEIVED	TSF_ALLOCATION
TSF_LINE_DAMAGED	QUANTITY_DAMAGED	TSF_ALLOCATION
TSF_CONTEXT_ID	CONTEXT_ID	TSF_ALLOCATION

4. Purchase Order

BDI Transaction Import Table: EXT_PURCH_ORDER_IN

BDI Column	Mapped Column	Mapped Column Table
PO_EXT_ID	EXTERNAL_ID	PURCHASE_ORDER
PO_STORE	STORE_ID	PURCHASE_ORDER
PO_SUPPLIER	SUPPLIER_ID	PURCHASE_ORDER
PO_STATUS	STATUS	PURCHASE_ORDER
PO_NOT_BEFORE_DATE	NOT_BEFORE_DATE	PURCHASE_ORDER
PO_NOT_AFTER_DATE	NOT_AFTER_DATE	PURCHASE_ORDER
PO_CREATE_DATE	CREATE_DATE	PURCHASE_ORDER
PO_UPDATE_DATE	UPDATE_DATE	PURCHASE_ORDER
PO_COMPLETE_DATE	COMPLETE_DATE	PURCHASE_ORDER
PO_USER	USER_ID	PURCHASE_ORDER
PO_COMMENTS	COMMENTS	PURCHASE_ORDER
PO_CUST_ORD_ID	CUST_ORDER_ID	PURCHASE_ORDER
PO_FUL_ORD_EXT_ID	FUL_ORD_EXTERNAL_ID	PURCHASE_ORDER
PO_EXT_STATUS	EXTERNAL_STATUS	PURCHASE_ORDER
PO_LINE_ITEM	ITEM_ID	PURCHASE_ORDER_LINE_ITEM
PO_LINE_SUPP_COUNTRY	SUPPLIER_COUNTRY_ID	PURCHASE_ORDER_LINE_ITEM
PO_LINE_CASE_SIZE	CASE_SIZE	PURCHASE_ORDER_LINE_ITEM
PO_LINE_EXPECTED	QUANTITY_EXPECTED	PURCHASE_ORDER_LINE_ITEM
PO_LINE_RECEIVED	QUANTITY_RECEIVED	PURCHASE_ORDER_LINE_ITEM
PO_LINE_UNIT_COST_CURRENCY	UNIT_COST_CURRENCY	PURCHASE_ORDER_LINE_ITEM
PO_LINE_UNIT_COST_VALUE	UNIT_COST_VALUE	PURCHASE_ORDER_LINE_ITEM
PO_LINE_PREFERRED_UOM	PREFERRED_UOM	PURCHASE_ORDER_LINE_ITEM
PO_LINE_PUBLISHED	PUBLISHED	PURCHASE_ORDER_LINE_ITEM

Appendix: Third Party Pricing Integration

Overview

By default EICS integrate with RPCS clearance and regular price change via BDI process flow.

EICS does not integrate with Promotion Offer interface due to it does not provide pricing at item/date level, so there is nothing for SIOCS to consume.

As an alternative, SIOCS does have a generic pricing interface for the retailer to integrate promotion price into.

Third Party Pricing Import provides a generic pricing interfaces for retailer which can provide pricing data for EICS pricing imports from third party. This third party pricing import provides an alternative for import promotion data into EICS.

BDI Implementation Considerations

To load third party data into EICS via BDI, external system need to provide data sourcing implementations.

There are two approaches for data sourcing implementations, Integration Implementer may choose the data provider implementations based on their need.

Option A: Third Party Pricing Integration Via BDI External Process Flow Implementation

Figure L-1 BDI Process Flow Process



The BDI process:

- An Extractor extracts data from a data producing system into an outgoing intermediate integration interface table.
- A Downloader and transporter services data to receiver service.
- An Uploader uploads the data to an incoming intermediate integration interface tables.

- An Importer imports the data from the interface stage tables into SIOCS application tables.

For more information about data seeding, see [Data Seeding](#).

With this approach, the BDI Ext Process Flow will move the data from sourcing system to destination system's application table. BDI process flow provides BDI job scheduling, end to end data transportation from sourcing system's database table into destination application's tables.

Customer need to implement the BDI Ext-EdgeApp to move data into the BDI outbound interface table.

BDI Process Flow: ExtPrice_Tx_ProcessFlow_From_EXTERNAL

See Oracle Retail Enterprise Integration Overview Guide: BDI Third Party Integrations.

Option B: Third Party Pricing Integration Via BDI CLI File Transmitter

BDI CLI File Transmitter is a client command line tool, is applicable for smaller data file size which does not require concurrent processing.

BDI CLI file transmitter only transport data files from sourcing systems to destination system's interface tables. It does not provide end to end data transportation. If you choose BDI CLI File transmitter for load third party data into EICS application table, it would require three steps:

Figure L-2 BDI CLI File Transmitter

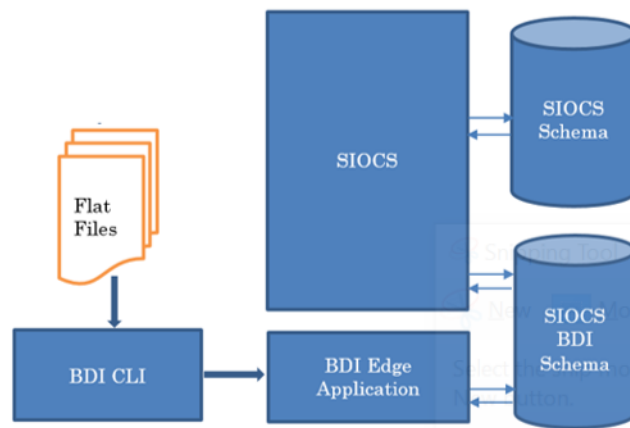

- Download BDI CLI File Transmitter and install on customer's system.
- Run BDI CLI Transmitter batch to load data file from sourcing system into destination system's interface table.
- Once the data are loaded into receiver app's inbound interface tables, EICS's importer job will move the data from inbound interface table into EICS app tables.

Note: By default, batch scheduler Third Party Price Import in EICS is disabled; this job should only be enabled if you choose to use BDI CLI File transmitter for data sourcing provider.

See [Integration](#).

This section provides BDI CLI File Transmitter as an implementation to describe how to import third party pricing into EICS via BDI CLI File Transmitter.

Third Party Pricing Import via BDI CLI File Transmitter

Each file contains price records for a single store, store/item/action date uniquely identify a pricing record.

1. BDI CLI File Transmitter Process

The BDI CLI Transmitter process load data files to an intermediate BDI inbound tables in SIOCS BDI Schema.

Once the records are created on the SIOCS BDI table, BDI process also create a control record for the module and interface for importer to process. The module interface along with the data set id will be used by importer to identify the records to be imported into the EICS in importer process.

See [Appendix: BDI Transmitter CLI Procedure - Load External Data File](#) for details on how to run BDI CLI File Transmitter.

2. EICS Importer Process

Once the file data is loaded into the SIOCS BDI inbound interface table, the importer process will process the BDI interface tables into SIOCS application tables. You can setup SIOCS Batch job schedule to import data from inbound interface tables into EICS application tables. For importer details, see Third Party Pricing Import in batch chapter for details.

3. Job Scheduling

You can schedule EICS job scheduler to start the third party price TX importer job automatically, or You can run importer as adhoc job.

By default, EICS batch scheduling for third party pricing TX import job is disabled, as for customers who choose BDI External Process Flow for third party pricing end to end integration, the BDI Job scheduler should be used.

4. Error Handling and Logging

When the job execution failed, only the failed record reference ids are stored in the BATCH_DATA_DETAIL table, the data which are successfully processed are removed from the BDI inbound table. Sys ops user can view the batch detail errors via EICS Job admin console. The number of maximum errors (for example 10 errors) per partition are logged for each batch/partition run.

EXT_PRICE_IN

Field Name	Description	Required	Type
BDI_SEQ_ID	Bulk Data Integration data sequence.	Yes	NUMBER(19)
BDI_APP_NAME	Bulk Data Integration Application Name.	Yes	VARCHAR2(50)
BDI_DATASET_TYPE	Bulk Data Integration Data Set Type, valid values are FULL, or PARTIAL.	Yes	VARCHAR2(20)

Field Name	Description	Required	Type
BDI_DATASET_ACTION	EICS only support REPLACE OR DELETE as dataset action for third party pricing, UPDATE type is not supported, use replace for updating a record.	Yes	VARCHAR2(20)
ITEM_ID	The unique alphanumeric value for the transaction level item.	Yes	VARCHAR2(25)
STORE_ID	The number that uniquely identifies the store.	Yes	Number(10)
EFFECTIVE_DATE	The date on which the price change went effect.	Yes	Date
END_DATE	Promotion or clearance price end date. For price change with an end date, if the clearance indicator is 'Y', the end date is for clearance end date; otherwise the end date is promotional ending date.	No	Date
PRICE_TYPE	The item price type. Valid values: 200- Clearance 201- Promotional 202- Regular	Yes	NUMBER(3)
PROMOTION_NAME	Promotion name.	No	VARCHAR2(160)
SELLING_UNIT_RETAIL	Contains the current single unit retail in the selling unit of measure.	Yes	NUMBER(20,4)
SELLING_UOM	Contains the selling unit of measure for an items single-unit retail.	Yes	VARCHAR2(4)
SELLING_UNIT_RETAIL_CURRENCY	Contains the selling unit retail currency.	Yes	VARCHAR2(3)
MULTI_UNITS	Contains the current multi-units. If the record is being written as a result of a change in the multi-unit retail, then this field contains the new multi-units.	No	NUMBER(12,4)
MULTI_UNIT_RETAIL	Contains the current multi-unit retail in the selling unit of measure.	No	NUMBER(20,4)
MULTI_UNIT_RETAIL_CURRENCY	Contains the multi-unit retail currency.	No	VARCHAR2(3)
MULTI_UNIT_SELLING_UOM	Contains the selling unit of measure for an items multi-unit retail.	No	VARCHAR2(4)
CREATE_DATETIME	Contains the record creation date.	No	Date
REC_ID	The id of the record.	Yes	NUMBER(15)
RETAIL_CHANGE_IND	Indicates whether the retail changed with this price change. Valid values are: 0 - retail price not changed 1 - retail price changed	No	NUMBER(6)

Field Name	Description	Required	Type
MULTI_UNIT_IMPACT	Indicates if the Price Change has impact to Multi Unit retail. Valid value are: AU - Multi Unit information is added or updated R - Multi Unit information is removed N - Multi unit information is not changed.	Yes	VARCHAR2(4)
PRICE_EVENT_ID	The id of the price event.	No	NUMBER(15)

External Price CSV File Fields

The CSV data fields matches the non-BDI heading columns in EXT_PRICE_IN (four BDI heading columns are: BDI_SEQ_ID, BDI_APP_NAME, BDI_DATASET_TYPE, BDI_DATASET_ACTION).

For example, the first fields in the file would matches the fifth column in EXT_PRICE_IN table, the second field in the file matches the sixth column in the table.

Sample CSV File:

ext_price_<YYYYMMDDHHMMSS>.csv

```
"100637113",5000,2018-07-03T00:00:00,,202,"",49.99,"USD","EA",,,
,"",2018-10-12 12:00:00.000000000
```

```
"100637148",5000,2018-07-03T19:00:00,,202,"",49.99,"USD","EA",,,
,"",2018-10-12 12:00:00.000000000
```

File Contents Explanation

- Create CSV file: ext_price_<YYYYMMDDHHMMSS>.csv
- It is expected that the pricing provider to ensure the record uniqueness (A unique record is identified by store/item/effective date time), within a file, each record must be unique. The record action is denoted by action type, only a dataset action is allowed for unique store/item/date, for example, for store 5000, item A, a price on date 2018 Dec 10 00:00:00 record in the file can be one of the (REPLACE, DELETE), the same record with more than one dataset action will be rejected. EICS only support REPLACE OR DELETE as dataset action for third party pricing, UPDATE type is not supported, use replace for updating a record.
- To end clearance price: To end a clearance price for a store/item, the pricing provider can either include the end date on the clearance item record; or sending a new price record (regular or promotional).
- The same file can't have two records with this combination store/item/effective with different price type, if clearance need to be on today, then this file should only have a single record for clearance type; to end the clearance (for example, tomorrow), the file need either mark the end date for that clearance or need to include a regular price record with a different effective date (for example, tomorrow).
- In EICS, there is no client UI which needed the prom id, clearance id or price change id. For data import integration backend processing, the record is uniquely identified by item/store/effective date time and price type external pricing change

identifier has no meaning to our system. Promotion name is used in EICS as context type, therefore include in the integration interface.

- **Split the Data into Multiple Files**

EICS loads the data in parallel from multiple files. Loading files from multiple files in parallel provides performance advantage than loading from a single file. It is recommended to file provider to split the data into multiple files to load data efficiently in parallel loading, each file contains single store is recommended.

- **Compress the data files**

If data file contains large datasets, it is recommended that compress the load files individually, when load the data file. Use EICS System Configuration Console to specify the file suffix (for example, gzip, or zip).