

Entities User Guide

## **Oracle FLEXCUBE Investor Servicing**

Release 14.4.0.3.0

Part Number F32763-01

May 2021

Entities User Guide  
May 2021  
Oracle Financial Services Software Limited

Oracle Park

Off Western Express Highway  
Goregaon (East)  
Mumbai, Maharashtra 400 063  
India  
Worldwide Inquiries:  
Phone: +91 22 6718 3000  
Fax: +91 22 6718 3001  
[www.oracle.com/financialservices/](http://www.oracle.com/financialservices/)

Copyright © 2007, 2021, Oracle and/or its affiliates.

Oracle and Java are registered trademarks of Oracle and/or its affiliates. Other names may be trademarks of their respective owners.

U.S. GOVERNMENT END USERS: Oracle programs (including any operating system, integrated software, any programs embedded, installed or activated on delivered hardware, and modifications of such programs) and Oracle computer documentation or other Oracle data delivered to or accessed by U.S. Government end users are "commercial computer software" or "commercial computer software documentation" pursuant to the applicable Federal Acquisition Regulation and agency-specific supplemental regulations. As such, the use, reproduction, duplication, release, display, disclosure, modification, preparation of derivative works, and/or adaptation of i) Oracle programs (including any operating system, integrated software, any programs embedded, installed or activated on delivered hardware, and modifications of such programs), ii) Oracle computer documentation and/or iii) other Oracle data, is subject to the rights and limitations specified in the license contained in the applicable contract. The terms governing the U.S. Government's use of Oracle cloud services are defined by the applicable contract for such services. No other rights are granted to the U.S. Government.

This software or hardware is developed for general use in a variety of information management applications. It is not developed or intended for use in any inherently dangerous applications, including applications that may create a risk of personal injury. If you use this software or hardware in dangerous applications, then you shall be responsible to take all appropriate failsafe, backup, redundancy, and other measures to ensure its safe use. Oracle Corporation and its affiliates disclaim any liability for any damages caused by use of this software or hardware in dangerous applications.

This software and related documentation are provided under a license agreement containing restrictions on use and disclosure and are protected by intellectual property laws. Except as expressly permitted in your license agreement or allowed by law, you may not use, copy, reproduce, translate, broadcast, modify, license, transmit, distribute, exhibit, perform, publish or display any part, in any form, or by any means. Reverse engineering, disassembly, or decompilation of this software, unless required by law for interoperability, is prohibited.  
The information contained herein is subject to change without notice and is not warranted to be error-free. If you find any errors, please report them to us in writing.

This software or hardware and documentation may provide access to or information on content, products and services from third parties. Oracle Corporation and its affiliates are not responsible for and expressly disclaim all warranties of any kind with respect to third-party content, products, and services. Oracle Corporation and its affiliates will not be responsible for any loss, costs, or damages incurred due to your access to or use of third-party content, products, or services.

---

# Table of Contents

<b>1.</b>	<b>About this Manual .....</b>	<b>1-1</b>
1.1	Introduction.....	1-1
1.2	Related Documents.....	1-1
1.3	Audience.....	1-1
1.4	Organization .....	1-1
1.5	Conventions followed in this Manual .....	1-1
	1.5.1 General Conventions.....	1-2
	1.5.2 Keyboard Conventions .....	1-2
1.6	Glossary of Icons.....	1-2
1.7	Abbreviations and Acronyms.....	1-2
1.8	Getting Help.....	1-3
<b>2.</b>	<b>Maintaining Customer Information .....</b>	<b>2-1</b>
2.1	Customer Maintenance Detail Screen.....	2-1
	2.1.1 Invoking Customer Maintenance Detail Screen .....	2-2
	2.1.2 Individual Dtls Tab .....	2-4
	2.1.3 Corporate Dtls Tab .....	2-6
	2.1.4 Corr.Address Dtls Tab .....	2-10
	2.1.5 Permanent/Registration Address Tab .....	2-11
	2.1.6 Client Preferences Tab.....	2-12
	2.1.7 Identification Dtls Tab .....	2-14
	2.1.8 Alternate Language Dtls Tab.....	2-17
2.2	Customer Maintenance Summary Screen.....	2-18
	2.2.1 Retrieving CIF Profile in Customers Maintenance Summary Screen.....	2-19
	2.2.2 Editing CIF Profile before Authorization .....	2-20
	2.2.3 Viewing CIF Profile before Authorization .....	2-21
	2.2.4 Deleting CIF Profile before Authorization .....	2-21
	2.2.5 Authorizing CIF Profile for Customer.....	2-21
	2.2.6 Amending CIF Profile for Customer.....	2-22
	2.2.7 Authorizing Amended CIF Profile for Customer .....	2-22
	2.2.8 Saving CIF Profile in Customers Screen .....	2-23
2.3	Service Location Maintenance Screen .....	2-23
	2.3.1 Invoking Service Location Maintenance Screen.....	2-24
2.4	Service Location Maintenance Summary Screen.....	2-24
	2.4.1 Retrieving Service Location Record .....	2-25
	2.4.2 Editing Service Location Record .....	2-26
	2.4.3 Viewing Service Location Record.....	2-26
	2.4.4 Deleting Service Location Record .....	2-27
	2.4.5 Authorizing Service Location Record .....	2-27
	2.4.6 Amending Service Location Record .....	2-27
	2.4.7 Authorizing Amended Service Location Record .....	2-28
2.5	CIF Address Maintenance Screen.....	2-28
	2.5.1 Invoking CIF Address Maintenance Screen .....	2-28
2.6	CIF Address Summary Screen.....	2-30
	2.6.1 Retrieving CIF Address Record.....	2-30
	2.6.2 Editing CIF Address Record before Authorization .....	2-31
	2.6.3 Viewing CIF Address Record before Authorization .....	2-31

2.6.4	<i>Deleting CIF Address Record before Authorization</i> .....	2-32
2.6.5	<i>Authorizing CIF Address Record for Customer</i> .....	2-32
2.6.6	<i>Amending CIF Address Record for Customer</i> .....	2-32
2.6.7	<i>Authorizing Amended CIF Address Record for Customer</i> .....	2-33
2.7	CIF Address - Fund Maintenance Details.....	2-33
2.7.1	<i>Invoking CIF Address - Fund Maintenance Details Screen</i> .....	2-33
2.8	CIF Address Fund Summary Screen.....	2-35
2.8.1	<i>Retrieving CIF Address – Fund Record</i> .....	2-35
2.8.2	<i>Editing CIF Address – Fund Record before Authorization</i> .....	2-37
2.8.3	<i>Viewing CIF Address – Fund Record before Authorization</i> .....	2-37
2.8.4	<i>Deleting CIF Address – Fund Record before Authorization</i> .....	2-37
2.8.5	<i>Authorizing CIF Address – Fund Record for Customer</i> .....	2-37
2.8.6	<i>Amending CIF Address – Fund Record for Customer</i> .....	2-38
2.8.7	<i>Authorizing Amended CIF Address – Fund Record for Customer</i> .....	2-38
2.9	CIF-UH Mapping Detail .....	2-38
2.9.1	<i>Invoking CIF-UH Mapping Detail Screen</i> .....	2-39
2.10	CIF-UH Mapping Summary .....	2-40
2.10.1	<i>Retrieving CIF-UH Mapping Record</i> .....	2-40
2.10.2	<i>Editing CIF-UH Mapping Record</i> .....	2-41
2.10.3	<i>Viewing CIF-UH Mapping Record</i> .....	2-41
2.10.4	<i>Delete CIF-UH Mapping Record</i> .....	2-42
2.10.5	<i>Authorizing CIF-UH Mapping Record</i> .....	2-42
2.10.6	<i>Amending CIF-UH Mapping Record</i> .....	2-42
2.10.7	<i>Authorizing an Amended CIF-UH Mapping Record</i> .....	2-43
2.11	CIF Merge Change Hierarchy Detail .....	2-43
2.11.1	<i>Invoking CIF Merge Change Hierarchy Detail Screen</i> .....	2-43
2.12	CIF Merge Change Hierarchy Summary .....	2-46
2.12.1	<i>Retrieving CIF Merge Change Hierarchy Record</i> .....	2-46
2.12.2	<i>Editing CIF Merge Change Hierarchy Record</i> .....	2-47
2.12.3	<i>Viewing CIF Merge Change Hierarchy Record</i> .....	2-47
2.12.4	<i>Delete CIF Merge Change Hierarchy Record</i> .....	2-47
2.12.5	<i>Authorizing CIF Merge Change Hierarchy Record</i> .....	2-48
2.12.6	<i>Amending CIF Merge Change Hierarchy Record</i> .....	2-48
2.12.7	<i>Authorizing an Amended CIF Merge Change Hierarchy Record</i> .....	2-48
2.13	Customer Find Screen Detail .....	2-49
2.13.1	<i>Invoking Customer Find Detail Screen</i> .....	2-50
2.14	Customer Log Details .....	2-53
2.14.1	<i>Invoking Customer Log Details Screen</i> .....	2-53
2.15	CIF Accessibility Mapping Detail Screen.....	2-54
2.15.1	<i>Invoking CIF Accessibility Mapping Detail Screen</i> .....	2-54
2.15.2	<i>Fields in CIF Accessibility Mapping Detail Screen</i> .....	2-54
2.16	CIF Accessibility Mapping Summary Screen.....	2-56
2.16.1	<i>Retrieving CIF Accessibility Mapping Record</i> .....	2-56
2.16.2	<i>Viewing CIF Accessibility Mapping Record</i> .....	2-57
2.16.3	<i>Delete CIF Accessibility Mapping Record</i> .....	2-57
2.16.4	<i>Authorizing CIF Accessibility Mapping Record</i> .....	2-57
2.17	CIF Conversion Maintenance Detail Screen .....	2-58
2.17.1	<i>Invoking CIF Conversion Maintenance Detail Screen</i> .....	2-58
2.17.2	<i>Pre Check Tab</i> .....	2-60
2.17.3	<i>Linked Entities Tab</i> .....	2-61



2.17.4	<i>Related Entities Tab</i> .....	2-62
2.17.5	<i>UH Details Tab</i> .....	2-62
2.18	CIF Conversion Maintenance Summary .....	2-67
2.18.1	<i>Retrieving CIF Conversion Maintenance Record</i> .....	2-68
2.18.2	<i>Editing CIF Conversion Maintenance Record</i> .....	2-69
2.18.3	<i>Viewing CIF Conversion Maintenance Record</i> .....	2-69
2.18.4	<i>Delete CIF Conversion Maintenance Record</i> .....	2-69
2.18.5	<i>Authorizing CIF Conversion Maintenance Record</i> .....	2-70
2.18.6	<i>Amending CIF Conversion Maintenance Record</i> .....	2-70
2.18.7	<i>Authorizing an Amended CIF Conversion Maintenance Record</i> .....	2-70
2.19	CIF Conversion Execution Screen .....	2-70
2.19.1	<i>Invoking CIF Conversion Execution Screen</i> .....	2-70
<b>3.</b>	<b>Managing Investor Accounts</b> .....	<b>3-1</b>
3.1	Customer Information .....	3-1
3.1.1	<i>Maintaining Customer Information</i> .....	3-1
3.1.2	<i>Maintaining Investor Accounts</i> .....	3-2
3.1.3	<i>Identifying Unit Holder Account in System</i> .....	3-3
3.1.4	<i>Specifying Mandatory Information for New Account</i> .....	3-3
3.1.5	<i>Defaulting of Information for CIF Unit Holder Accounts</i> .....	3-5
3.1.6	<i>Specifying Additional Information for New Account</i> .....	3-5
3.1.7	<i>Choosing Template for Automatic Replication</i> .....	3-6
3.1.8	<i>Maintaining Stop Status on Unit Holder Account</i> .....	3-7
3.1.9	<i>Maintaining IRS Notifications on Unit Holder Account</i> .....	3-9
3.1.10	<i>Saving New Account</i> .....	3-9
3.2	Unit Holder Maintenance Details Screen .....	3-9
3.2.1	<i>Invoking Unit Holder Maintenance Details Screen</i> .....	3-10
3.2.2	<i>Account Details tab</i> .....	3-13
3.2.3	<i>Individual Dtls Tab</i> .....	3-15
3.2.4	<i>Corporate Dtls Tab</i> .....	3-18
3.2.5	<i>Contact Dtls Tab</i> .....	3-19
3.2.6	<i>Client Preferences Tab</i> .....	3-24
3.2.7	<i>ID Details Tab</i> .....	3-35
3.2.8	<i>Bank Dtls Tab</i> .....	3-40
3.2.9	<i>Intermediary Dtls Tab</i> .....	3-45
3.2.10	<i>KYC Details Tab</i> .....	3-48
3.2.11	<i>Document Dtls Tab</i> .....	3-52
3.2.12	<i>Add Info Tab</i> .....	3-53
3.2.13	<i>UH Signature Tab</i> .....	3-54
3.2.14	<i>Related Parties Tab</i> .....	3-55
3.2.15	<i>FATCA Audit Log Tab</i> .....	3-57
3.2.16	<i>UH KIID Compliance Tab</i> .....	3-58
3.2.17	<i>Delivery Dtls Button</i> .....	3-59
3.2.18	<i>Beneficiary Dtls Button</i> .....	3-60
3.2.19	<i>Joint Holder Dtls Button</i> .....	3-63
3.2.20	<i>Nominee Dtls Button</i> .....	3-67
3.2.21	<i>Member Dtls Button</i> .....	3-70
3.2.22	<i>Alternate Language Dtls Button</i> .....	3-71
3.2.23	<i>Director Details Tab</i> .....	3-74
3.2.24	<i>Tax Compliance Button</i> .....	3-77
3.2.25	<i>Multiple Tax Details Button</i> .....	3-78

3.2.26	<i>Subscription button</i> .....	3-79
3.3	Unit Holder Maintenance Summary Screen .....	3-79
3.3.1	<i>Retrieving Unitholder Account</i> .....	3-80
3.3.2	<i>Editing New Accounts</i> .....	3-81
3.3.3	<i>Modifying Account through Editing</i> .....	3-81
3.3.4	<i>Viewing New Accounts</i> .....	3-82
3.3.5	<i>Deleting New Accounts</i> .....	3-82
3.3.6	<i>Authorizing New Account</i> .....	3-82
3.3.7	<i>Amending Authorized Account through Information Change</i> .....	3-83
3.3.8	<i>Authorizing Amended Unitholder Accounts</i> .....	3-84
3.4	Unit Holder Find Options .....	3-84
3.4.1	<i>Invoking Unit Holder Find Options Screen</i> .....	3-84
3.5	UH Category Parameter Screen.....	3-88
3.5.1	<i>Invoking UH Category Parameter Screen</i> .....	3-88
3.6	UH Category Parameter Summary Screen .....	3-89
3.6.1	<i>Retrieving UH Category Parameter</i> .....	3-89
3.6.2	<i>Editing UH Category Parameter Details</i> .....	3-90
3.6.3	<i>Deleting UH Category Parameter Details</i> .....	3-91
3.6.4	<i>Authorizing UH Category Parameter Details</i> .....	3-91
3.7	Account Type Maintenance Details Screen.....	3-92
3.7.1	<i>Invoking Account Type Maintenance Details Screen</i> .....	3-92
3.8	Account Type Maintenance Summary Screen .....	3-95
3.8.1	<i>Retrieving Account Type in Account Type Maintenance Summary Screen</i> .....	3-95
3.8.2	<i>Editing Account Type Record</i> .....	3-96
3.8.3	<i>Viewing Account Type Record</i> .....	3-97
3.8.4	<i>Deleting Account Type Record</i> .....	3-97
3.8.5	<i>Authorizing Account Type Record</i> .....	3-97
3.8.6	<i>Amending Account Type Record</i> .....	3-98
3.9	Financial Intelligence Centre Act (FICA) .....	3-98
3.9.1	<i>Maintaining Financial Intelligence Centre Act</i> .....	3-98
3.10	Escheatment Tracking.....	3-102
3.10.1	<i>Tracking Escheatment Process</i> .....	3-102
3.11	Export of Unit Holder Information .....	3-104
3.11.1	<i>Exporting Unit Holder Account Information</i> .....	3-104
3.12	KYC Chasing Details .....	3-104
3.12.1	<i>Invoking KYC Chasing Details Screen</i> .....	3-104
3.13	KYC Chasing Summary.....	3-105
3.13.1	<i>Retrieving KYC Chasing Record in KYC Chasing Summary Screen</i> .....	3-105
3.13.2	<i>Editing KYC Chasing Record</i> .....	3-107
3.13.3	<i>Viewing KYC Chasing Record</i> .....	3-107
3.13.4	<i>Deleting KYC Chasing Record</i> .....	3-107
3.13.5	<i>Authorizing KYC Chasing Record</i> .....	3-108
3.13.6	<i>Amending KYC Chasing Record</i> .....	3-108
3.13.7	<i>Authorizing Amended KYC Chasing Record</i> .....	3-108
3.14	Unit Holder Currency of Expression .....	3-108
3.14.1	<i>Invoking Unit Holder Currency of Expression Screen</i> .....	3-108
3.15	Unit Holder Currency of Expression Summary.....	3-110
3.15.1	<i>Retrieving Unit Holder Currency of Expression Details</i> .....	3-111
3.15.2	<i>Editing Unit Holder Currency of Expression Details</i> .....	3-112
3.15.3	<i>Viewing Unit Holder Currency of Expression Details</i> .....	3-112

3.15.4	<i>Deleting Unit Holder Currency of Expression Details</i> .....	3-113
3.15.5	<i>Authorizing Unit Holder Currency of Expression Details</i> .....	3-113
3.15.6	<i>Amending Unit Holder Currency of Expression Details</i> .....	3-113
3.15.7	<i>Authorizing Amended Unit Holder Currency of Expression Details</i> .....	3-113
<b>4.</b>	<b>Setting up Investor Preferences</b> .....	<b>4-1</b>
4.1	Income Distribution Setup Screen .....	4-2
4.1.1	<i>Maintaining Investor Distribution Setup Details</i> .....	4-2
4.1.2	<i>Invoking Income Distribution Setup Screen</i> .....	4-2
4.1.3	<i>Payment Details Tab</i> .....	4-7
4.1.4	<i>Reinvestment Details Tab</i> .....	4-10
4.1.5	<i>Routing Details Tab</i> .....	4-12
4.2	Income Distribution Setup Summary Screen .....	4-14
4.2.1	<i>Retrieving Income Distribution Setup Record</i> .....	4-14
4.2.2	<i>Editing Income Distribution Setup Record</i> .....	4-16
4.2.3	<i>Viewing Income Distribution Setup Record</i> .....	4-16
4.2.4	<i>Deleting Income Distribution Setup Record</i> .....	4-17
4.2.5	<i>Authorizing Income Distribution Setup</i> .....	4-17
4.2.6	<i>Amending Income Distribution Setup</i> .....	4-17
4.2.7	<i>Authorizing Amended Income Distribution Setup Details</i> .....	4-18
4.3	Unitholder Deal Maintenance Detail Screen .....	4-18
4.3.1	<i>Setting Up Deal for Investor</i> .....	4-18
4.3.2	<i>Invoking Unitholder Deal Maintenance Detail Screen</i> .....	4-20
4.4	Unitholder Deal Summary Screen .....	4-25
4.4.1	<i>Retrieving Deals for Investors</i> .....	4-26
4.4.2	<i>Editing Deals for Investors</i> .....	4-27
4.4.3	<i>Viewing Deals for Investors</i> .....	4-27
4.4.4	<i>Deleting Deals for Investors</i> .....	4-28
4.4.5	<i>Authorizing Deals for Investors</i> .....	4-28
4.4.6	<i>Amending Deals for Investors</i> .....	4-28
4.4.7	<i>Authorizing Amended Deals for Investors</i> .....	4-29
4.5	LOI Adjust Proc Screen .....	4-29
4.5.1	<i>Defining Letters of Intent</i> .....	4-29
4.5.2	<i>Non-fulfilling of Letter of Intent</i> .....	4-31
4.6	Setting up Letter of Intent Options for Investor .....	4-31
4.6.1	<i>Invoking Unit Holder LOI Setup Detail Screen</i> .....	4-31
4.7	Unit Holder LOI Setup Summary Screen .....	4-34
4.7.1	<i>Retrieving LOI Setup Options for Investor</i> .....	4-34
4.7.2	<i>Editing LOI Setup Options for Investor</i> .....	4-36
4.7.3	<i>Viewing LOI Setup Options for Investor</i> .....	4-36
4.7.4	<i>Deleting LOI Setup Options for Investor</i> .....	4-37
4.7.5	<i>Authorizing LOI Setup Options for Investor</i> .....	4-37
4.7.6	<i>Amending LOI Setup Options for Investor</i> .....	4-37
4.7.7	<i>Authorizing Amended LOI Setup Options for Investor</i> .....	4-38
4.8	LOI Adjust Proc Screen .....	4-38
4.8.1	<i>Invoking LOI Adjust Proc Screen</i> .....	4-38
4.9	UH Non Tax Limits Detail Screen .....	4-40
4.9.1	<i>Setting Up Non-Tax Limits for Eligible Investors</i> .....	4-40
4.9.2	<i>Processing of Non-Tax Limits for Investors</i> .....	4-41
4.9.3	<i>Invoking UH Non Tax Limits Detail Screen</i> .....	4-41
4.10	UH Non Tax Limits Summary Screen .....	4-46

4.10.1	<i>Retrieving Non-Tax Limits for Investor</i>	4-46
4.10.2	<i>Editing Non-Tax Limits for Investor</i>	4-48
4.10.3	<i>Viewing Non-Tax Limits for Investor</i>	4-48
4.10.4	<i>Deleting Non-Tax Limits for Investor</i>	4-48
4.10.5	<i>Authorizing Non-Tax Limits for Investor</i>	4-49
4.10.6	<i>Amending Non-Tax Limits for Investor</i>	4-49
4.10.7	<i>Authorizing Amended Non-Tax Limits for Investor</i>	4-50
4.11	Unit Holder IRRF Preference Detail Screen	4-51
4.11.1	<i>Setting up IRRF Preferences for a Unit Holder</i>	4-51
4.11.2	<i>Invoking Unit Holder IRRF Preference Detail Screen</i>	4-52
4.12	Unit Holder IRRF Preference Summary Screen	4-54
4.12.1	<i>Retrieving IRRF Preferences for Investors</i>	4-54
4.12.2	<i>Editing IRRF Preferences for Investors</i>	4-56
4.12.3	<i>Viewing IRRF Preferences for Investors</i>	4-56
4.12.4	<i>Deleting IRRF Preferences for Investors</i>	4-57
4.12.5	<i>Authorizing IRRF Preferences for Investors</i>	4-57
4.12.6	<i>Amending IRRF Preferences for Investors</i>	4-57
4.12.7	<i>Authorizing Amended IRRF Preferences for Investors</i>	4-57
4.13	Unit Holder NPI Preference Detail Screen	4-58
4.13.1	<i>Invoking Unit Holder NPI Preference Detail Screen</i>	4-58
4.14	Unit Holder NPI Preference Summary Screen	4-59
4.14.1	<i>Retrieving NPI Payment Preferences for Investors</i>	4-59
4.14.2	<i>Editing NPI Payment Preferences for Investors</i>	4-60
4.14.3	<i>Viewing NPI Payment Preferences for Investors</i>	4-61
4.14.4	<i>Deleting NPI Payment Preferences for Investors</i>	4-61
4.14.5	<i>Authorizing NPI Payment Preferences for Investors</i>	4-61
4.14.6	<i>Amending NPI Payment Preferences for Investors</i>	4-62
4.14.7	<i>Authorizing Amended NPI Payment Preferences for Investors</i>	4-62
4.15	Fund UH Category Minimum Holding Period Details Screen	4-62
4.15.1	<i>Invoking Fund UH Category Minimum Holding Period Details Screen</i>	4-62
4.16	Fund UH Category Minimum Holding Period Summary Screen	4-65
4.16.1	<i>Retrieving/Viewing minimum holding period at Fund/UH category/transaction level</i>	4-66
4.16.2	<i>Editing Minimum Holding period at Fund/UH Category/Transaction Level</i>	4-67
4.16.3	<i>Deleting Minimum Holding Period at Fund/UH Category/Transaction Level</i>	4-67
4.16.4	<i>Authorizing Minimum Holding Period at Fund/UH Category/Transaction Level</i>	4-68
4.16.5	<i>Amending Minimum Holding Period at Fund/UH Category/Transaction Level</i>	4-68
4.17	UH Status Change Detail Screen	4-68
4.17.1	<i>Closing an Unit Holder Account</i>	4-68
4.17.2	<i>Invoking UH Status Change Detail Screen</i>	4-69
4.18	Unit Holder Status Change Summary Screen	4-70
4.18.1	<i>Retrieving Status Change</i>	4-71
4.18.2	<i>Editing Status Change</i>	4-72
4.18.3	<i>Viewing Status Change</i>	4-72
4.18.4	<i>Deleting Status Change</i>	4-73
4.18.5	<i>Authorizing Status Change</i>	4-73
4.18.6	<i>Amending Status Change</i>	4-73
4.18.7	<i>Authorizing Amended Status Change</i>	4-74
4.19	Auth Rep Maintenance Detail Screen	4-74
4.19.1	<i>Invoking Auth Rep Maintenance Detail Screen</i>	4-74

4.20	Auth Rep Maintenance Summary.....	4-78
	4.20.1 Retrieving a Record in Auth Rep Maintenance Summary Screen.....	4-78
	4.20.2 Editing Auth Rep Maintenance Record .....	4-79
	4.20.3 Viewing Auth Rep Maintenance Record .....	4-79
	4.20.4 Deleting Auth Rep Maintenance Record .....	4-80
	4.20.5 Authorizing Auth Rep Maintenance Record .....	4-80
	4.20.6 Amending Auth Rep Maintenance Record .....	4-80
	4.20.7 Authorizing an Amended Auth Rep Maintenance Record .....	4-81
4.21	NotePad of Entities Detail Screen .....	4-81
	4.21.1 Invoking NotePad of Entities Detail Screen.....	4-81
4.22	NotePad of Entities Summary Screen .....	4-82
	4.22.1 Retrieving Entity NotePad Information .....	4-82
	4.22.2 Editing Entity NotePad Information.....	4-84
	4.22.3 Viewing Entity NotePad Information .....	4-84
	4.22.4 Deleting Entity NotePad Information .....	4-84
	4.22.5 Authorizing Entity NotePad Information.....	4-85
	4.22.6 Amending Entity NotePad Information .....	4-85
	4.22.7 Authorizing Amended Entity NotePad Information .....	4-85
4.23	Agency Branch Account Officer Maintenance Detail.....	4-85
	4.23.1 Invoking Agency Branch Account Officer Maintenance Detail Screen .....	4-86
4.24	Agency Branch Account Officer Maintenance Summary.....	4-87
	4.24.1 Retrieving a Record in Agency Branch Account Officer Maintenance Summary .....	4-87
Screen		
	4.24.2 Editing Agency Branch Account Officer Maintenance Record .....	4-89
	4.24.3 Viewing Agency Branch Account Officer Maintenance Record.....	4-89
	4.24.4 Deleting Agency Branch Account Officer Maintenance Record .....	4-89
	4.24.5 Authorizing Agency Branch Account Officer Maintenance Record .....	4-90
	4.24.6 Amending Agency Branch Account Officer Maintenance Record .....	4-90
	4.24.7 Authorizing Amended Agency Branch Account Officer Maintenance Record .....	4-90
4.25	Account Officer IFA Maintenance Detail.....	4-90
	4.25.1 Invoking Account Officer IFA Maintenance Detail Screen.....	4-91
4.26	Account Officer IFA Maintenance Summary .....	4-92
	4.26.1 Retrieving a Record in Account Officer IFA Maintenance Summary Screen .....	4-92
	4.26.2 Editing Account Officer IFA Maintenance Record .....	4-94
	4.26.3 Viewing Account Officer IFA Maintenance Record.....	4-94
	4.26.4 Deleting Account Officer IFA Maintenance Record .....	4-94
	4.26.5 Authorizing Account Officer IFA Maintenance Record .....	4-95
	4.26.6 Amending Account Officer IFA Maintenance Record .....	4-95
	4.26.7 Authorizing Amended Account Officer IFA Maintenance Record.....	4-95
4.27	Agent Price Basis Detail .....	4-95
	4.27.1 Invoking Agent Price Basis Detail Screen .....	4-96
4.28	Agent Price Basis Summary.....	4-97
	4.28.1 Retrieving a Record in Agent Price Basis Summary Screen.....	4-98
	4.28.2 Editing Agent Price Basis Record.....	4-99
	4.28.3 Viewing Agent Price Basis Record .....	4-99
	4.28.4 Deleting Agent Price Basis Record .....	4-99
	4.28.5 Authorizing Agent Price Basis Record.....	4-100
	4.28.6 Amending Agent Price Basis Record .....	4-100
	4.28.7 Authorizing Amended Agent Price Basis Record .....	4-100
4.29	AMC Agent SLA Maintenance Summary .....	4-100

4.29.1	<i>Invoking AMC Agent SLA Maintenance Summary Screen</i> .....	4-101
4.30	Tax Credit.....	4-102
4.30.1	<i>Invoking Tax Credit Screen</i> .....	4-102
<b>5.</b>	<b>Managing Brokers</b> .....	<b>5-1</b>
5.1	Broker Type Detail Screen .....	5-1
5.1.1	<i>Creating Broker Groups</i> .....	5-2
5.1.2	<i>Invoking Broker Type Details Screen</i> .....	5-2
5.2	Broker Type Summary Screen .....	5-6
5.2.1	<i>Retrieving Broker Type in Broker Type Summary Screen</i> .....	5-6
5.2.2	<i>Editing Broker Types</i> .....	5-8
5.2.3	<i>Viewing Broker Types</i> .....	5-8
5.2.4	<i>Deleting Broker Types</i> .....	5-8
5.2.5	<i>Authorizing Broker Types</i> .....	5-9
5.2.6	<i>Amending Broker Types</i> .....	5-9
5.2.7	<i>Authorizing Amended Broker Types</i> .....	5-9
5.3	Broker Maintenance Detail Screen.....	5-10
5.3.1	<i>Maintaining Individual Brokers</i> .....	5-10
5.3.2	<i>Specifying Mandatory Information for Creating Broker Record</i> .....	5-11
5.3.3	<i>Saving Broker Record</i> .....	5-12
5.3.4	<i>Invoking Broker Maintenance Detail Screen</i> .....	5-13
5.3.5	<i>Broker Details Tab</i> .....	5-13
5.3.6	<i>Broker Contact Info Tab</i> .....	5-22
5.3.7	<i>Broker Bank Details Tab</i> .....	5-25
5.3.8	<i>Broker Legacy Details Tab</i> .....	5-29
5.3.9	<i>Broker Preference Tab</i> .....	5-30
5.3.10	<i>Related Parties Tab</i> .....	5-31
5.3.11	<i>Broker Add Info Tab</i> .....	5-33
5.4	Broker Maintenance Summary Screen.....	5-33
5.4.1	<i>Retrieving Broker Records in Broker Maintenance Summary Screen</i> .....	5-34
5.4.2	<i>Editing Broker Records</i> .....	5-36
5.4.3	<i>Viewing Broker Records</i> .....	5-36
5.4.4	<i>Deleting Broker Records</i> .....	5-37
5.4.5	<i>Authorizing Broker Records</i> .....	5-37
5.4.6	<i>Amending Broker Records</i> .....	5-37
5.4.7	<i>Authorizing Amended Broker Records</i> .....	5-38
5.4.8	<i>Amending Broker Details after Transaction Unitization</i> .....	5-43
5.5	Transaction Broker Amendment Screen .....	5-43
5.5.1	<i>Invoking Transaction Broker Amendment Screen</i> .....	5-43
5.6	Broker Payment Currency Preference Detail Screen .....	5-44
5.6.1	<i>Invoking Payment Currency Preference Screen</i> .....	5-44
5.7	FCIS Broker Payment Currency Preference Summary Screen.....	5-46
5.7.1	<i>Retrieving Broker Payment Currency Preference Summary</i> .....	5-46
5.7.2	<i>Editing Broker Payment Currency Preference</i> .....	5-47
5.7.3	<i>Viewing Broker Payment Currency Preference</i> .....	5-48
5.7.4	<i>Deleting Broker Payment Currency Preference</i> .....	5-48
5.7.5	<i>Authorizing Broker Payment Currency Preference</i> .....	5-48
5.7.6	<i>Amending Broker Payment Currency Preference</i> .....	5-48
5.7.7	<i>Authorizing Amended Broker Payment Currency Preference</i> .....	5-49
5.8	Broker Migration Screen.....	5-49
5.8.1	<i>Processing Broker Merger</i> .....	5-49

5.8.2	<i>Invoking Broker Migration Screen</i>	5-50
5.9	Broker Migration Summary Screen	5-51
5.9.1	<i>Retrieving Broker Migration Summary</i>	5-51
5.9.2	<i>Viewing Broker Migration</i>	5-52
5.10	Broker Journal Detail Screen	5-52
5.10.1	<i>Maintaining Accounting Journal for Broker</i>	5-53
5.10.2	<i>Invoking Broker Journal Detail Screen</i>	5-53
5.11	Broker Journal Summary Screen	5-57
5.11.1	<i>Retrieving Journal Entry in Broker Journal Summary Screen</i>	5-58
5.11.2	<i>Editing Journal Entry</i>	5-59
5.11.3	<i>Viewing Journal Entry</i>	5-59
5.11.4	<i>Deleting Journal Entry</i>	5-60
5.11.5	<i>Authorizing Journal Entry</i>	5-60
5.12	Income Distribution Setup Screen	5-60
5.12.1	<i>Setting Up Income Distribution Options for Brokers</i>	5-61
5.12.2	<i>Invoking Income Distribution Setup Screen</i>	5-61
5.13	Raise Broker Commission Screen	5-62
5.13.1	<i>Invoking Raise Broker Commission</i>	5-63
5.13.2	<i>Calculating VAT Amount</i>	5-64
5.14	FCIS Broker Authorization	5-65
5.14.1	<i>Invoking FCIS Broker Authorization Screen</i>	5-65
5.15	Commission Payment Status Change Screen	5-66
5.15.1	<i>Invoking Commission Payment Status Change Screen</i>	5-66
5.15.2	<i>Search Results Tab</i>	5-69
5.15.3	<i>Exchange Rate Source Tab</i>	5-70
5.15.4	<i>Exchange Rate Maintenance Tab</i>	5-71
5.16	Commission Payment Status Change Summary	5-72
5.16.1	<i>Retrieving Commission Payment Status Change Summary Screen</i>	5-72
5.16.2	<i>Editing Commission Payment Status Change Record</i>	5-73
5.16.3	<i>Viewing Commission Payment Status Change Record</i>	5-73
5.16.4	<i>Deleting Commission Payment Status Change Record</i>	5-73
5.16.5	<i>Authorizing Commission Payment Status Change Record</i>	5-73
5.16.6	<i>Amending Commission Payment Status Change Record</i>	5-74
5.16.7	<i>Authorizing Amended Commission Payment Status Change Record</i>	5-74
5.17	Broker Commission Payment Screen	5-74
5.17.1	<i>Invoking Broker Commission Payment Screen</i>	5-74
5.18	Minimum Commission Payment Amount Maintenance Screen	5-75
5.18.1	<i>Invoking Minimum Commission Payment Amount Maintenance</i>	5-75
5.19	Minimum Commission Payment Amount Maintenance Summary Screen	5-76
5.19.1	<i>Retrieving Minimum Commission Payment Amount Maintenance Summary</i>	5-77
5.19.2	<i>Editing Minimum Commission Payment Amount</i>	5-78
5.19.3	<i>Viewing Minimum Commission Payment Amount</i>	5-78
5.19.4	<i>Deleting Minimum Commission Payment Amount</i>	5-78
5.19.5	<i>Authorizing Minimum Commission Payment Amount</i>	5-79
5.19.6	<i>Amending Minimum Commission Payment Amount</i>	5-79
5.19.7	<i>Authorizing Amended Minimum Commission Payment Amount</i>	5-79
5.20	Entity Commission Payment Inquiry Detail	5-80
5.20.1	<i>Invoking Entity Commission Payment Inquiry Detail Screen</i>	5-80
5.20.2	<i>Payable Tab</i>	5-82
5.20.3	<i>Accrual Tab</i>	5-83

5.21	FSA Registration Maintenance Detail.....	5-83
5.21.1	<i>Invoking FSA Registration Maintenance Detail Screen.....</i>	<i>5-84</i>
5.22	FSA Registration Maintenance Summary .....	5-85
5.22.1	<i>Retrieving FSA Registration Maintenance Summary Record.....</i>	<i>5-86</i>
5.22.2	<i>Editing FSA Registration Maintenance Record .....</i>	<i>5-87</i>
5.22.3	<i>Viewing FSA Registration Maintenance Record.....</i>	<i>5-87</i>
5.22.4	<i>Deleting FSA Registration Maintenance Record .....</i>	<i>5-87</i>
5.22.5	<i>Authorizing FSA Registration Maintenance Records .....</i>	<i>5-88</i>
5.22.6	<i>Amending FSA Registration Maintenance Record .....</i>	<i>5-88</i>
5.22.7	<i>Authorizing Amended FSA Registration Maintenance Records .....</i>	<i>5-88</i>
<b>6.</b>	<b>Function ID Glossary .....</b>	<b>6-1</b>



---

# 1. About this Manual

## 1.1 Introduction

Welcome to Oracle FLEXCUBE Investor Servicing™, a comprehensive mutual funds automation software from Oracle Financial Servicing Software Ltd. ©.

This Oracle FLEXCUBE Investor Servicing (FC-IS) User Manual helps you use the system to achieve optimum automation of all your mutual fund investor Servicing processes. It contains guidelines for specific tasks, descriptions of various features and processes in the system and general information.

## 1.2 Related Documents

The User Manual is organized in to various parts, each discussing a component of the Oracle FLEXCUBE Investor Servicing system.

## 1.3 Audience

This Agency Branch User Manual is intended for users that perform any of the business roles in the Asset Management Company (AMC).

## 1.4 Organization

This volume of the Agency Branch user manual is organized under the following chapter sequence:

Chapter	Description
Chapter 1	<i>About this Manual</i> explains the use, structure, audience and organization of this manual for FC-IS.
Chapter 2	<i>Entities – Maintaining Customer Information</i> explains the maintenance of customer accounts for CIF customers.
Chapter 3	<i>Entities – Managing Investor Accounts</i> explains the setting up of investor accounts and the management of these accounts.
Chapter 4	<i>Entities – Setting up Investor Preferences</i> explains about setting up of income distribution options, specifying the applicability of the Letter of Intent facility, setting up a negotiated deal, specifying non-tax- limits for exemption eligible investors.
Chapter 5	<i>Entities – Managing Brokers</i> explains all aspects of the maintenance of brokers in the system.
Chapter 6	<i>Function ID Glossary</i> has alphabetical listing of Function/Screen IDs used in the module with page references for quick navigation.

## 1.5 Conventions followed in this Manual

Before you begin using this User Manual, it is important to understand the typographical conventions used in it.

### 1.5.1 General Conventions





Convention	Type of Information
<i>Italic type</i>	Functional/ foreign terms Validations for fields on a screen References to related Headings/Users Manuals For emphasis
Numbered Bullet	Step by step procedures

### 1.5.2 Keyboard Conventions

Convention	Type of Information
Keys	All keys of the keyboard are represented in capital letters. For example, <CTRL>.
Shortcut keys	All short cut keys are contained in brackets. For example, <ALT+SHIFT>.

## 1.6 Glossary of Icons

This User Manual may refer to all or some of the following icons.

Icons	Function
	Exit
	Add Row
	Delete Row
	Option List

## 1.7 Abbreviations and Acronyms

The following acronyms and abbreviations are adhered to in this User Manual:

Abbreviation / Acronym	Meaning
ADMIN	User Administrator
AGY	The Agency Branch component of the system
AMC	Asset Management Company
BOD	Beginning of Day
CIF	Customer Information File

<b>Abbreviation / Acronym</b>	<b>Meaning</b>
EOD	End of Day
FC-IS	Oracle FLEXCUBE Investor Servicing
FMG	The Fund Manager component of the system
FPADMIN	Oracle FLEXCUBE Administrator
GTA	Global Transfer Agency
ID	Identification
IHPP	Inflation Hedged Pension Plan
IPO	Initial Public Offering
LEP	Life and Endowment Products
LOI	Letter of Intent
NAV	Net Asset Value
REG	The Registrar component of the system
ROA	Rights of Accumulation
ROI	Return on Investment
SI	Standing Instructions
SMS	Security Management System
URL	Uniform Resource Locator

## **1.8 Getting Help**

Online help is available for all tasks. You can get help for any function by clicking the help icon provided on the relevant screen.

---

## 2. Maintaining Customer Information

Oracle FLEXCUBE Investor Servicing provides the facility of maintaining information profiles for customers of your bank. The profile consists of personal as well as business information.

A customer may also wish to invest in the funds of the AMC. In such a case, you can create and maintain one or more investor accounts for the customer in the AMC FC-IS database.

This chapter deals with the maintenance of customer profiles and creation of investor accounts for your customers in the AMC FC-IS database.

This chapter contains the following sections:

- [Section 2.1, "Customer Maintenance Detail Screen"](#)
- [Section 2.2, "Customer Maintenance Summary Screen"](#)
- [Section 2.3, "Service Location Maintenance Screen"](#)
- [Section 2.4, "Service Location Maintenance Summary Screen"](#)
- [Section 2.5, "CIF Address Maintenance Screen"](#)
- [Section 2.6, "CIF Address Summary Screen"](#)
- [Section 2.7, "CIF Address - Fund Maintenance Details"](#)
- [Section 2.8, "CIF Address Fund Summary Screen"](#)
- [Section 2.9, "CIF-UH Mapping Detail"](#)
- [Section 2.10, "CIF-UH Mapping Summary"](#)
- [Section 2.11, "CIF Merge Change Hierarchy Detail"](#)
- [Section 2.12, "CIF Merge Change Hierarchy Summary"](#)
- [Section 2.13, "Customer Find Screen Detail"](#)
- [Section 2.14, "Customer Log Details"](#)
- [Section 2.15, "CIF Accessibility Mapping Detail Screen"](#)
- [Section 2.16, "CIF Accessibility Mapping Summary Screen"](#)
- [Section 2.16, "CIF Accessibility Mapping Summary Screen"](#)
- [Section 2.17, "CIF Conversion Maintenance Detail Screen"](#)
- [Section 2.19, "CIF Conversion Execution Screen"](#)

### 2.1 Customer Maintenance Detail Screen

This section contains the following topics:

- [Section 2.1.1, "Invoking Customer Maintenance Detail Screen"](#)
- [Section 2.1.2, "Individual Dtls Tab"](#)
- [Section 2.1.3, "Corporate Dtls Tab"](#)
- [Section 2.1.4, "Corr.Address Dtls Tab"](#)
- [Section 2.1.5, "Permanent/Registration Address Tab"](#)
- [Section 2.1.6, "Client Preferences Tab"](#)
- [Section 2.1.7, "Identification Dtls Tab"](#)
- [Section 2.1.8, "Alternate Language Dtls Tab"](#)

## 2.1.1 Invoking Customer Maintenance Detail Screen

When you authorize a CIF profile for a customer in the Customers screen, the following events take place:

- The CIF record is now effective in the database as an authorized record.
- More importantly, a single, initial unit holder account is created for the CIF customer in the FC-IS database. The details of the unit holder account are defaulted from the investment details entered for the CIF profile, as well as from the default information maintained for the FCC Bulk Client Code in the Bulk Clients Defaults Maintenance record in FC-IS. The unit holder account is created as an unauthorized or an authorized account, depending upon the specification for the same in the Bulk Clients Defaults Maintenance.

This initial unit holder account may need to be altered subsequently. If it is created as an unauthorized account, you can edit it through the Unit Holder New Account Summary screen. If it is created as an authorized account, you can perform an information change through the Unit Holder Information Change menu option.

In either case, the Unit Holder record must be authorized after it is edited or changed through an info change, to take effect.

After the creation of the first unit holder account for the CIF profile, you can create as many unit holder accounts as necessary for the same CIF profile, through the UH New Account screen.

You can invoke the 'Customer Maintenance Detail' screen by typing 'UTDCUST' in the field at the top right corner of the Application tool bar and clicking on the adjoining arrow button.

Customer Maintenance Detail

Enter Query

Customer Maintenance

Customer No.

Customer Category\*  Customer Type

Customer Category Description  Joint Account\*

Fee Category  Joint Holder Type

Fee Sub Category  Protected Investor Level

Individual Dtls Corporate Dtls Corr.Address Dtls Permanent/Registration Address Client Preferences Identification Dtls Alternate Language Dtls

Customer individual

Title  Sex

First Name  Date Of Birth

Middle Name  Country of Birth

Last Name  Country of Birth Description

Input by  DateTime  Mod No  Record Status

Authorized by  DateTime  Authorization Status

Exit

Select 'New' from the Actions menu in the Application tool bar or click new icon to enter the details of the Customer Maintenance Screen.

## **Customer Maintenance Section**

### **Customer No**

#### *Display Only*

The customer number that you specified for the new CIF customer, in the New Customer No screen, is displayed here.

### **Customer Category**

#### *Alphanumeric; 10 Characters; Mandatory*

Specify the investor tax category corresponding to the CIF customer. Use the option list to make your choice.

### **Description**

#### *Display*

The system displays the description for the selected customer category.

### **Customer Type**

#### *Optional*

Indicate whether the customer is an individual, corporate or bank customer from the drop-down list.

### **Fee Category**

#### *Alphanumeric; 3 Characters; Optional*

From the list provided, select the fee category to be deemed applicable for the customer whose account you are creating.

**Fee Sub Category**

*Alphanumeric; 6 Characters; Optional*

From the list provided, select the fee subcategory to be deemed applicable for the customer whose account you are creating.

**Joint Account**

*Mandatory*

Select 'Yes' to indicate that the customer is a joint account holder. If you select 'Yes', you must indicate whether the customer is a Primary or Secondary joint account holder.

**Joint Holder Type**

*Optional*

From the drop-down list, select whether Primary or Secondary joint account holder.

---

**Note**

After authorization, the Identification Details (Identification Type, Identification Number and Place of Issue) of a Joint-Secondary customer alone can be modified in the Customer Information Screen.

---

**Protected Investor Level**

*Optional*

Select protected investor level from the drop-down list. The list displays the following values:

- Classified
- Unclassified

With Right to Access Classified Information, you can create CIF with Classified and Unclassified protection level.

With No Right to Access Classified Information, you can create CIF only with Unclassified protection level.

---

**Note**

If the CIF is created through FCUBS-FCIS integration, the system will default 'Protected Investor Level' depending upon the user mapped in the maintenance. If user mapped has Right to Access Classified Information then the system will default it to Classified else it will be defaulted to Unclassified.

---

Protected Investor Level field can be modified till record is authorized once. Once authorized, Protected Investor Level is not amendable.

**2.1.2 Individual Dtls Tab**

Click 'Individual Dtls' tab to enter the details.

**Title**

*Alphanumeric; 15 Characters; Optional*

Select the title of the customer.

**First Name**

*Alphanumeric; 105 Characters; Optional*

Specify the first name of the customer.

**Middle Name and Last Name**

*Alphanumeric; 105 Characters; Optional*

Specify the middle and last names of the customer.

**Minor**

*Optional*

Select 'Yes' from drop-down list to indicate that the customer is a minor. Else select 'No'.

**Guardian Name**

*Alphanumeric; 105 Characters; Mandatory for minor customers*

Specify the name of the guardian for the minor customer.

**Marital Status**

*Alphanumeric; 1 Character; Optional*

Specify the marital status of the customer.

**Marital Status Description**

*Display*

The system displays the description for the selected marital status.

**Sex**

*Optional*

Select the sex of the customer from the drop-down list

**Date of Birth**

*Date format; Mandatory only for minor customers*

Specify the date of birth of the customer.

**Country of Birth**

*Alphanumeric; 3 Characters; Optional*

Select the country of birth from the adjoining option list.

**Country of Birth Description**

*Display*

The system displays the description for the selected country of birth.

**Father/ Spouse Name**

*Alphanumeric; 105 Characters; Optional*

Enter the name of the customer's father or spouse.

**Beneficiary**

*Alphanumeric; 105 Characters; Optional*

Specify the name of the preferred beneficiary of the individual customer.

**Relationship**

*Alphanumeric; 20 Characters; Optional*

Specify the relationship between the beneficiary and the customer.

**Relationship Description**

*Display*

The system displays the description for the selected relationship status.



### 2.1.3 Corporate Dtls Tab

Click Corporate Details Tab in the Customer Maintenance Detail screen:

Customer Maintenance Detail

Enter Query

**Customer Maintenance**

Customer No.

Customer Category \*  Customer Type

Customer Category Description  Joint Account \*

Fee Category  Joint Holder Type

Fee Sub Category  Protected Investor Level

Individual Dtls **Corporate Dtls** Corr.Address Dtls Permanent/Registration Address Client Preferences Identification Dtls Alternate Language Dtls

**Corporate Details**

Corporation Name  National ID

Incorporation Date  Net Worth

Capital  Incorporation Country

Business Description  Contact Name

Input by  DateTime  Mod No  Record Status

Authorized by  DateTime  Authorization Status

**Exit**

Customer Maintenance Detail

Enter Query

**Customer Maintenance**

Customer No.

Customer Category \*  Customer Type

Customer Category Description  Joint Account \*

Fee Category  Joint Holder Type

Fee Sub Category  Protected Investor Level

Individual Dtls **Corporate Dtls** Corr.Address Dtls Permanent/Registration Address Client Preferences Identification Dtls Alternate Language Dtls

Corporation Type Description

**Signature Details**

1 of 1

<input type="checkbox"/>	Sequence Number *	Director ID	Director Name	Designation	Date Of Birth	Gender	ID Type	Address L

Input by  DateTime  Mod No  Record Status

Authorized by  DateTime  Authorization Status

**Exit**

This section is enabled only for 'Corporate' type of customer. The following are the fields in this section:

### **Corporate Details**

#### **Corporate Name**

*Alphanumeric; 105 Characters; Optional*

Specify the name of the corporation here.

#### **Incorporation Date**

*Date Format; Optional*

Specify the date on which the company was incorporated.

#### **Capital**

*Numeric; 22 Characters; Optional*

Enter the Capital (amount) of the corporation.

#### **Business Description**

*Alphanumeric; 255 Characters; Optional*

Specify the business description.

#### **National ID**

*Alphanumeric; 20 Characters; Optional*

Specify the National ID of the customer.

#### **Net Worth**

*Numeric; 22 Characters; Optional*

Specify the Net Worth of the corporation.

#### **Incorporation Country**

*Alphanumeric; 3 Characters; Optional*

Specify the country of incorporation for the customer.

#### **Contact Name**

*Alphanumeric; 105 Characters; Optional*

Specify the name of the contact person for the corporation.

#### **Base Currency**

*Alphanumeric; 3 Characters; Optional*

Specify the base currency of operation for the customer.

#### **Corporation Type**

*Alphanumeric; 3 Characters; Optional*

Indicate the corporate type for the customer. The system displays the description.

#### **Corporation Type Description**

*Display*

The system displays the description for the selection corporation type.

### **Signature Details**

#### **Sequence Number**

*Alphanumeric; 3 Characters; Mandatory*

Specify the order of sequence.

**Director ID**

*Alphanumeric; 12 Characters; Optional*

Specify the director identification from the adjoining option list.

**Director Name**

*Display*

The system displays the name of the corresponding director.

**Designation**

*Alphanumeric; 100 Characters; Mandatory*

Specify the designation.

**Date of Birth**

*Date Format; Optional*

Specify the date of birth.

**Gender**

*Optional*

Select the gender from the adjoining drop-down list.

**ID Type**

*Alphanumeric; 3 Characters; Optional*

Select the identification type from the adjoining option list.

**Address Line 1**

*Alphanumeric; 255 Characters; Optional*

Specify the contact address.

**Address Line2**

*Alphanumeric; 255 Characters; Optional*

Specify the contact address.

**City**

*Alphanumeric; 105 Characters; Optional*

Select the city from the adjoining option list.

**State**

*Alphanumeric; 105 Characters; Optional*

Select the state from the adjoining option list.

**Country**

*Alphanumeric; 3 Characters; Optional*

Select the country from the adjoining option list.

**Zip Code**

*Alphanumeric; 10 Characters; Optional*

Specify the zip code.

**Email**

*Alphanumeric; 255 Characters; Optional*

Specify the email ID.

**Contact Person**

*Alphanumeric; 160 Characters; Optional*

Specify the contact person.

**Bank**

*Alphanumeric; 12 Characters; Optional*

Select the bank from the adjoining option list.

**Branch**

*Alphanumeric; 12 Characters; Optional*

Select the branch from the adjoining option list.

**Account Type**

*Alphanumeric; 1 Character; Optional*

Select the account type from the adjoining option list.

**Account Currency**

*Alphanumeric; 3 Characters; Optional*

Select the currency of the account from the adjoining option list.

**Account Number**

*Alphanumeric; 20 Characters; Optional*

Specify the account number.

**Account Name**

*Alphanumeric; 100 Characters; Optional*

Specify the name in the account.

**IBAN**

*Alphanumeric; 40 Characters; Optional*

Specify the IBAN number.

**Percentage Holding**

*Numeric; 5 Characters; Optional*

Specify the percentage of holding.

**FATCA Classification**

*Display*

The system displays the FATCA classification type.

**US Indicia Available**

*Display*

On saving the record, the system defaults 'US Indicia Available' as Yes or No depending on the following values:

- The nationality is US
- The dual nationality is US
- The substantial stay is in US
- The country of birth is US
- The country of domicile is US
- The country of incorporation is US
- The country of correspondence or alternate address is US

- The country code of the telephone number is 01

## FATCA Status

### Display

The system defaults the FATCA Status as Compliant/ Recalcitrant/ Pending Classification/ Not Applicable based on the FATCA maintenance.

## 2.1.4 Corr.Address Dtls Tab

Click 'Corr.Address Dtls' tab to enter the details.

The screenshot shows the 'Customer Maintenance Detail' window. The 'Corr.Address Dtls' tab is selected and highlighted in red. The form contains the following fields and controls:

- Customer Maintenance Section:**
  - Customer No. (text input)
  - Customer Category\* (text input)
  - Customer Category Description (text input)
  - Fee Category (text input)
  - Fee Sub Category (text input)
  - Customer Type (dropdown menu, currently set to 'Individual')
  - Joint Account\* (dropdown menu, currently set to 'No')
  - Joint Holder Type (dropdown menu, currently set to '-Select-')
  - Protected Investor Level (dropdown menu, currently set to 'Unclassified')
- Navigation Tabs:** Individual Dtls, Corporate Dtls, **Corr.Address Dtls**, Permanent/Registration Address, Client Preferences, Identification Dtls, Alternate Language Dtls
- Address and Contact Information Section:**
  - Address Line 2 (text input)
  - City (text input)
  - Country\* (text input)
  - Country Description (text input)
  - Telephone (text input)
  - Int. Dialing Code + (text input)
  - Fax Number (text input)
  - E-Mail (text input)
- Footer Section:**
  - Input by (text input)
  - Authorized by (text input)
  - Date Time (text input)
  - Mod No (text input)
  - Record Status (text input)
  - Authorization Status (text input)
  - Cancel button (blue button)

## Address Details Section

### Address Line 1

*Alphanumeric; 105 Characters; Mandatory*

Enter the address details of the customer.

### Address Line 2

*Alphanumeric; 105 Characters; Optional*

Specify the address details.

### City

*Alphanumeric; 105 Characters; Optional*

You can select the city name. The available options depend on the values defined at the params maintenance. If the city is not available in the list, you can specify the city in the field provided alongside.

### Country

*Alphanumeric; 3 Characters; Mandatory*

Specify the country code.

## Country Description

*Display*

The system displays the description of the selected country code.

## Int. Dialing Code +

*Alphanumeric; 10 Characters; Optional*

Specify the international dialing code for telephone.

## Telephone

*Numeric; 60 Characters; Optional*

Enter the telephone number of the customer.

## Int. Dialing Code +

*Alphanumeric; 10 Characters; Optional*

Specify the international dialing code for faxing.

## Fax Number

*Numeric; 60 Characters; Optional*

Enter the fax number of the customer.

## E-Mail

*Alphanumeric; 255 Characters; Optional*

Enter the E-mail ID of the customer.

## 2.1.5 Permanent/Registration Address Tab

Click 'Permanent/Registration Address' tab to enter the details.

The screenshot shows the 'Customer Maintenance Detail' window. The 'Permanent/Registration Address' tab is highlighted in red. The form contains the following fields and controls:

- Execute Query
- Customer Maintenance section:
  - Customer No. (text field)
  - Customer Category \* (text field)
  - Customer Category Description (text field)
  - Fee Category (text field)
  - Fee Sub Category (text field)
  - Customer Type (dropdown menu, value: Individual)
  - Joint Account \* (dropdown menu, value: No)
  - Joint Holder Type (dropdown menu, value: -Select-)
  - Protected Investor Level (dropdown menu, value: Unclassified)
- Navigation tabs: Individual Dtls, Corporate Dtls, Corr.Address Dtls, **Permanent/Registration Address**, Client Preferences, Identification Dtls, Alternate Language Dtls
- Address Line 2 (text field)
- City (text field)
- Country \* (text field)
- Country Description (text field)
- Footer section:
  - Input by (text field)
  - Authorized by (text field)
  - DateTime (text field)
  - Mod No (text field)
  - Record Status (text field)
  - Authorization Status (text field)
  - Cancel button

## Permanent/Registration Address

### Address Line 1 and 2

*Alphanumeric; 105 Characters; Mandatory*

Enter the address details of the customer. You can select the city from the drop down list provided. The available options depend on the values defined at the params maintenance. If the city is not available in the list, you can specify the city in the field provided alongside.

## City

Alphanumeric; 105 Characters; Optional

Specify the city details of the customer.

## Country

Alphanumeric; 3 Characters; Mandatory

Specify the country details of the customer.

## Country Description

Display

The system displays the description for the selected country code.

## 2.1.6 Client Preferences Tab

Click 'Client Preferences' tab to enter the details.

The screenshot shows the 'Customer Maintenance Detail' form with the 'Client Preferences' tab selected. The form is divided into several sections:

- Customer Maintenance:** Includes fields for Customer No., Customer Category (with a red asterisk), Customer Category Description, Fee Category, Fee Sub Category, Customer Type (Individual), Joint Account (No), Joint Holder Type (-Select-), and Protected Investor Level (Unclassified).
- Navigation:** A row of tabs includes Individual Dtls, Corporate Dtls, Corr.Address Dtls, Permanent/Registration Address, Client Preferences (highlighted in red), Identification Dtls, and Alternate Language Dtls.
- Client Preferences:** Includes fields for Account Currency (with a red asterisk), Residency Status (Resident), Allow ROA at CIF Level (No), Language (with a red asterisk), Nationality (with a red asterisk), Dual Nationality, Default Broker, Country Of Domicile (with a red asterisk), Nationality Description, Dual Nationality Description, Broker Name, and Country Of Domicile.
- Footer:** A table with columns: Input by, Authorized by, DateTime, Mod No, Record Status, Authorization Status, and a Cancel button.

This screenshot is identical to the one above, showing the 'Customer Maintenance Detail' form with the 'Client Preferences' tab selected. The fields visible in this view are:

- Client Preferences:** Language (with a red asterisk), Language Description, Country Of Domicile (with a red asterisk), Substantial Stay in US (No), Service Location, Country Of Domicile Description, and Service Location Description.
- Footer:** The same table and Cancel button as in the previous screenshot.

## **Client Preferences**

### **Account Currency**

*Alphanumeric; 3 Characters; Mandatory*

From the option list, select the default account currency for the CIF customer.

### **Resident Status**

*Optional*

Specify whether the customer is a resident or a foreigner from the drop-down list.

### **Allow ROA at CIF Level**

*Mandatory*

Select if Rights of Accumulation must be made applicable to all unit holders that will have an account under this CIF customer record.

### **Language**

*Alphanumeric; 12 Characters; Mandatory*

Specify the preferred language of the customer.

### **Language Description**

*Display*

The system displays the description for the selected language code.

### **External Reference Number**

*Alphanumeric; 50 Characters; Optional; Amendable*

Enter the External Reference number and it is an informational field.

### **Nationality**

*Alphanumeric; 3 Characters; Mandatory*

From the option list, select the nationality of the customer.

### **Nationality Description**

*Display*

The system displays the description for the selected nationality code.

### **Dual Nationality**

*Alphanumeric; 3 Characters; Optional*

Select the dual nationality from the adjoining option list.

### **Dual Nationality Description**

*Display*

The system displays the description for the selected dual nationality code.

### **Default Broker**

*Alphanumeric; 9 Characters; Optional*

From the option list, select the default broker for the CIF customer.

### **Broker Name**

*Display*

The system displays the broker name for the selected default broker.

### **Country of Domicile**

*Alphanumeric; 3 Characters; Optional*

Select the country of domicile of the customer.



## Country of Domicile Description

### Display

The system displays the description for the selected country of domicile.

## Substantial Stay in US

### Optional

Indicate your substantial stay in US from the adjoining drop-down list. the options available are:

- Yes
- No

## Service Location

*Alphanumeric; 50 Characters; Optional; Amendable*

Specify the Service Location of the customer. Alternatively, you can select Service Location from the LOV. The list displays all the valid Service Location of the customer maintained in the system.

## Service Location Description

### Display

The system displays the description for the selected service location.

## 2.1.7 Identification Dtls Tab

Click 'Identification Dtls' tab to enter the details.

The screenshot shows the 'Customer Maintenance Detail' window with the 'Identification Dtls' tab selected. The form contains the following fields and controls:

- Customer Maintenance**
  - Customer No. (text input)
  - Customer Category \* (text input)
  - Customer Category Description (text input)
  - Fee Category (text input)
  - Fee Sub Category (text input)
  - Customer Type (dropdown menu: Individual)
  - Joint Account \* (dropdown menu: No)
  - Joint Holder Type (dropdown menu: -Select-)
  - Protected Investor Level (dropdown menu: Unclassified)
- Identification Dtls**
  - Identification Type \* (text input)
  - Identification Type Description (text input)
  - Identification Number \* (text input)
  - Date of Issue (text input)
  - Tax Deducted at Source \* (dropdown menu: No)
  - Tax ID (text input)
  - Employer ID Number (EIN) (text input)
  - Tax Circle (text input)
- Footer**
  - Input by (text input)
  - Authorized by (text input)
  - Date Time (text input)
  - Mod No (text input)
  - Record Status (text input)
  - Authorization Status (text input)
  - Cancel button

### Identification Type

*Alphanumeric; 15 Characters; Mandatory*

From the list, select the type of identification that is being provided by the customer. The identification type is the mode in which the unit holder will furnish an identification document or proof, and could be a Personnel ID, License, Birth Certificate, etc. This is used for identifying the unit holder during all subsequent transactions.

### Identification Type Description

*Display*

The system displays the description for the selected identification type.

### Identification Number

*Alphanumeric; 50 Characters; Mandatory*

Specify the number or ID of the identification document or proof that is furnished by the unit holder.

### Date of Issue

*Date Format; Optional*

Specify the date of issue of the identification document or proof that is furnished by the unit holder.

The date of issue that you specify here must not be later than the date of opening the account.

### Date of Expiry

*Date Format; Optional*

Specify the date of expiry of the identification document or proof. It must be later than the date of issue and the application date.

### Place of Issue

*Alphanumeric; 3 Characters; Mandatory*

From the option list, select the place of issue of the identification type. Once authorized, this field cannot be modified.

### **Place of Issue Description**

#### *Display*

The system displays the description for the selected place of issue.

### **US Indicia Available**

#### *Display*

The system defaults US Indicia Available as Yes or No depending on the following:

- The nationality is US
- The dual nationality is US
- The substantial stay in US
- The country of birth is US
- The country of domicile is US
- The country of incorporation is US
- The country of correspondence or alternate address is US
- The country code of the telephone number is 01

### **FATCA Status**

#### *Display*

The system displays the FATCA Status based on the FATCA maintenance.

### **FATCA Classification**

#### *Display*

The system displays the FATCA classification type.

### **FATCA Classification Description**

#### *Display*

The system displays the description for the selected FATCA classification.

### **Tax Deducted at Source**

#### *Mandatory*

Select 'Yes' if tax has to be deducted at source for the customer.

If you select 'Yes', you can specify the following information:

- The tax ID of the customer, in the Tax ID field
- The tax circle that corresponds to the customer, in the Tax Circle field
- The tax category that corresponds to the customer, in the Category field

### **Tax ID**

*Alphanumeric; 50 Characters; Optional*

Specify the tax identification number or tax ID for the customer.

### **Employer ID Number (EIN)**

*Alphanumeric; 50 Characters; Optional*

Specify the employer identification number.

### **Tax Circle**

*Alphanumeric; 15 Characters; Optional*

Specify the tax circle to which the unit holder belongs.

### Tax Category

Alphanumeric; 10 Characters; Optional

Select the tax category under which the customer will be placed in the system.

### Tax Category Description

Display

The system displays the description for the selected tax category.

### Tax Certificate Effective Date

Date Format; Optional

Specify the date from which the tax certificate is effective.

### Tax Certificate Expiry Date

Date Format; Optional

Specify the expiry date of the tax certificate.

### Portfolio Manager ID

Alphanumeric; 16 Characters; Optional

Specify the portfolio manager's ID here.

## 2.1.8 Alternate Language Dtls Tab

Click 'Alternate Language Dtls' tab to enter the details:

The screenshot shows a web application window titled "Customer Maintenance Detail". At the top, there is a "Save" button. Below it, the "Customer Maintenance" section contains several input fields: "Customer No.", "Customer Category\*" (with a red asterisk), "Description", "Fee Category", and "Fee Sub Category". To the right of these fields are several dropdown menus: "Customer Type" (set to "Individual"), "Joint Account\*" (set to "No"), "Joint Holder Type" (set to "Primary"), and "Protected Investor Level" (set to "Unclassified").

Below the input fields is a horizontal tab bar with the following tabs: "Individual Dtls", "Corporate Dtls", "Corr.Address Dtls", "Permanent/Registration Address", "Client Preferences", "Identification Dtls", and "Alternate Language Dtls" (which is highlighted in red). Below the tabs, the "Alternate Language Dtls" section is visible, containing three sub-sections: "Individual Details" with fields for "First name", "Last Name", and "Middle Name"; "Correspondence Address" with fields for "Address Line 1", "City", and "Address Line 2"; and "Registration Address" with fields for "Address Line 1", "City", and "Address Line 2".

At the bottom of the window, there is a footer area with labels for "Input by", "Authorized by", "DateTime", "Mod No", "Open", and "Authorized". A "Cancel" button is located in the bottom right corner.

## **Individual Details**

### **First Name**

*Alphanumeric; 105 Characters; Optional*

Specify the first name of the customer in the desired alternate language if the customer is an individual. If the customer is a corporate, then specify the corporate name.

### **Middle Name**

*Alphanumeric; 105 Characters; Optional*

Specify the middle name of the customer if the customer is an individual in the desired alternate language.

### **Last Name**

*Alphanumeric; 105 Characters; Optional*

Specify the last name of the customer if the customer is an individual in the desired alternate language.

## **Correspondence Address**

### **Address Line 1 & 2**

*Alphanumeric; 105 Characters; Optional*

Enter the correspondence address details of the customer in the alternate language.

### **City**

*Alphanumeric; 105 Characters; Optional*

Specify the city details.

## **Registration Address**

### **Address Line 1 & 2**

*Alphanumeric; 105 Characters; Optional*

Enter the permanent address details of the customer if the customer is an individual. In case of corporate customer, enter the registration address details in the alternate language.

### **City**

*Alphanumeric; 105 Characters; Optional*

Specify the city details.

## **2.2 Customer Maintenance Summary Screen**

This section contains the following topics:

- [Section 2.2.1, "Retrieving CIF Profile in Customers Maintenance Summary Screen"](#)
- [Section 2.2.2, "Editing CIF Profile before Authorization "](#)
- [Section 2.2.3, "Viewing CIF Profile before Authorization"](#)
- [Section 2.2.4, "Deleting CIF Profile before Authorization"](#)
- [Section 2.2.5, "Authorizing CIF Profile for Customer"](#)
- [Section 2.2.6, "Amending CIF Profile for Customer"](#)
- [Section 2.2.7, "Authorizing Amended CIF Profile for Customer"](#)
- [Section 2.2.8, "Saving CIF Profile in Customers Screen"](#)

## 2.2.1 Retrieving CIF Profile in Customers Maintenance Summary Screen

You can retrieve a previously entered record in the Customer Maintenance Summary screen, as follows:

- Invoke the 'Customer Maintenance Summary' screen by typing 'UTSCUST' in the field at the top right corner of the Application tool bar and clicking on the adjoining arrow button. Specify any or all of the following details in the corresponding fields:
- The status of the record in the Authorized field. If you choose the "Blank Space" option, then all the transactions that involve the specified unit holder are retrieved.
- The status of the record in the Open field. If you choose the "Blank Space" option, then all the records that involve the specified unit holder are retrieved.
- Customer No.
- Customer Name
- Customer Type
- Customer Category
- Identification Number
- Identification Type
- Country of Domicile
- External Reference Number

Click 'Search' button to view the records. All records with the specified details are retrieved and displayed in the lower portion of the screen.

---

### **Note**

You can also retrieve the individual record detail from the Customer Maintenance detail screen by doing query in the following manner:

- Press F7
  - Input the Identification Number
  - Press F8
- 

You can perform Edit, Delete, Amend, Authorize, Reverse, Confirm operation by selecting from the Action list.

You can also search the record by using combination of % and alphanumeric value.

### **Example**

You can search the record for Identification Number by using the combination of % and alphanumeric value as follows:

- Search by A%: System will fetch all the records whose Identification Number starts from Alphabet 'A'. For Example: AGC17, AGVO6, AGC74 and so forth.
- Search by %7: System will fetch all the records whose Identification Number ends by numeric value '7'. For Example: AGC17, GSD267, AGC77 and so forth.

- Search by %17%: System will fetch all the records whose Identification Number contains the numeric value 17. For Example: GSD217, GSD172, AGC17 and so forth.

## 2.2.2 Editing CIF Profile before Authorization

You can modify the details of customer maintenance parameters that you have already entered into the system, provided it has not been subsequently authorized. You can perform this operation as follows:

- Invoke the Customer Maintenance Summary screen from the Browser.
- Select the status of the record that you want to retrieve for modification in the Authorized field. You can only modify records that are unauthorized. Accordingly, choose the Unauthorized option.
- Specify any or all of the details in the corresponding fields to retrieve the record that is to be modified. All unauthorized records with the specified details are retrieved and displayed in the lower portion of the screen.
- Double click the record that you want to modify in the list of displayed records. The Customer Maintenance Detail screen is displayed.
- Select Unlock Operation from Action list to modify the record. Modify the necessary information.
- Click Save to save your changes. Customer Maintenance Detail screen is closed and the changes made are reflected in the Customer Maintenance Summary screen.

### **2.2.3 Viewing CIF Profile before Authorization**

To view a record that you have previously entered, you must retrieve the same in the Customer Maintenance Summary screen, as follows:

- Invoke the Customer Maintenance Summary Screen from the Browser.
- Select the status of the record that you want to retrieve for viewing in the Authorized field. You can also view all records that are either unauthorized or authorized only, by choosing the Unauthorized / Authorized option.
- Specify any or all of the details of the record in the corresponding fields on the screen, and click 'Search' button. All records with the specified details are retrieved and displayed in the lower portion of the screen.
- Double click the record that you want to view in the list of displayed records. The Customer Maintenance Detail screen is displayed in View mode.

### **2.2.4 Deleting CIF Profile before Authorization**

You can delete only unauthorized records in the system. To delete a record that you have previously entered:

- Invoke the Customer Maintenance Summary screen from the Browser.
- Select the status of the record that you want to retrieve for deletion.
- Specify any or all of the details and click 'Search' button. All records with the specified details are retrieved and displayed in the lower portion of the screen.
- Double click the record that you want to delete. The Customer Maintenance Detail screen is displayed.
- Select Delete operation from the Action list. The system prompts you to confirm the deletion, and the record is deleted physically from the system database.

### **2.2.5 Authorizing CIF Profile for Customer**

An unauthorized Customer Maintenance must be authorized in the system for it to be processed. To authorize a record:

- Invoke the Customer Maintenance Summary screen from the Browser.
- Retrieve the record so that it is displayed in the lower portion of the screen.
- Click the 'Authorize' button. The Maintenance Authorization Details screen is displayed. The detail of each modification that was made to the record, in the sequence of occurrence is shown in this screen. For each modification, the following details are displayed:
  - The sequence number for the modification, in the Modification Number field.
  - The record status of the modification, in the Open field.
  - The user that effected the modification, in the Maker ID field.
  - The date at which the modification occurred, in the Maker Date Stamp field.

In the Field Details in the lower grid portion, the changed values for each modification are displayed.

You can authorize any of the modified records, or all of them.

When you have marked the required modifications for authorization, click the OK button to effect the authorization. The Maintenance Authorization Details screen is closed, and you are returned to the Customers main screen.



## 2.2.6 Amending CIF Profile for Customer

After a Customer Maintenance is authorized, it can be modified using the Unlock operation from Action list. To make changes to a record after authorization:

- Invoke the Customer Maintenance Summary screen from the Browser.
- Select the status of the record that you wish to retrieve for amendment. You can only amend only authorized records.
- Specify any or all of the details of the Customer Maintenance in the screen. All records with the specified details are retrieved and displayed in the lower portion of the screen.
- Double click the record that you want to amend. The Customer Maintenance Detail screen is displayed in Amendment mode. Click the Unlock operation from the Action list to amend the record.
- Amend the necessary information. Click the Save button to save the changes.

## 2.2.7 Authorizing Amended CIF Profile for Customer

An amended Customer Maintenance record must be authorized for the amendment to be made effective in the system. The authorization of amended records can only be done from Fund Manager Module and Agency branch Module.

The process of authorization is subsequently the same as that for normal transactions.

The Customers screen consists of the following parts:

### **The Result section**

A list of customer records retrieved by the most recent search operation is displayed in this section. To view the details of any record in this list, double click on the record, where a new screen will be opened with the details of the record.

### **The Button Row**

The row of buttons on the right side of the screen is as follows:

- Advanced
- Reset
- Query
- Refresh

### **The Advanced section**

This section is a row in the middle of the screen, with the 'Advanced Search' button at the right -hand side of the screen. Click 'Advanced Search' button for advanced level of query where records can be retrieved based on specific fields.

### **The Reset section**

This section is a row in the middle of the screen, with the Reset button at the right -hand side of the screen. Click 'Reset' button, so that the entire search criteria will be cleared for a new level of search

### **The Query section**

This section is a row in the middle of the screen, with the Query button at the right -hand side of the screen. Click 'Search' button to retrieve a record for viewing, use this section.

### **The Refresh section**

This section is a row in the middle of the screen, with the Refresh button at the right -hand side of the screen. Click 'Advanced Search' button, so that the search criteria will be refreshed based on existing criteria.

### **The view section**

Any record that you select for viewing is displayed in the lowest portion of the screen, below the button row.

## **2.2.8 Saving CIF Profile in Customers Screen**

To set up a CIF customer and enable the creation of a mutual fund investor account in the Customers screen,

- Click the Add button. The New Customer No. screen is opened. Specify a unique identifier in the Customer Code field for the CIF customer for whom you are setting up a profile, and click OK.
- The basic details screen is displayed, in readiness for you to enter the details for a new CIF customer. In this screen, specify the following as mandatory information:
- In the Customer Maintenance section - Indicate whether the customer is an individual customer or corporate customer by choosing the appropriate option in the Customer Type field.
- Indicate the investor tax category corresponding to the CIF customer in the field Customer Category.
- Indicate the fee category and sub category in the respective fields.
- In the Customer Details section specify the following details:
  - The name of the customer in the fields First Name, Middle Name and Last Name.
  - The title of the customer in the field Title.
  - Indicate whether the customer is a minor, in the field Minor. If the customer is a minor, enter the name of the guardian in the field Legal Guardian.
  - The marital status of the customer.
  - The gender of the customer.
  - Indicate the date of birth of the customer. This is mandatory if the customer is a minor.
  - Indicate the name of the father or spouse of the customer.
  - The name of the beneficiary of the customer and his/her relationship with the customer.
- In the Address Details section, enter the correspondence and permanent address details.
- In the Client Preferences section, specify the following details:
  - The account currency of the customer.
  - The preferred language of the customer.
  - The resident status of the customer, his/her nationality and country of domicile.
  - The default broker and whether the customer has rights of accumulation.
- In the Identification Details section, specify the identification type of the customer and the details of the same. Also specify whether tax is to be deducted at source.
- In the Account Operation Details section, specify whether the customer is a joint account holder.
- In the Alternate Language Details section, specify the customer details in the desired alternate language.
- Click the Save button to save the profile of your customer.

## **2.3 Service Location Maintenance Screen**

This section contains the following topic:

- [Section 2.3.1, "Invoking Service Location Maintenance Screen"](#)

### 2.3.1 Invoking Service Location Maintenance Screen

You can maintain time zone for a particular service location using Service Location Maintenance Screen (UTDSERLC). It is available in FMG module. You can invoke this screen by typing 'UTDSERLC' in the field at the top right corner of the Application tool bar and clicking on the adjoining arrow button.

Input by	DateTime	Mod No	Record Status
Authorized by	DateTime		Authorization Status

If Service Location time zone is not available then module level time zone will get defaulted as Order Received Time Zone in Transaction screen.

Select 'New' from the Actions menu in the Application tool bar or click new icon to enter the details of the Service Location Maintenance screen.

#### **Service Location**

*Alphanumeric; 50 Characters; Mandatory*

Specify the service location of the customer.

#### **Service Location Description**

*Alphanumeric; 255 Characters; Mandatory*

Specify the service location description of the customer.

#### **Time Zone**

*Alphanumeric; 12 Characters; Optional*

Specify the time zone as maintained in the Time Zone Maintenance screen. Alternatively, you can also select time zone from the LOV list.

#### **Time Zone Description**

*Display*

The system displays the description of the time zone maintained.

## 2.4 Service Location Maintenance Summary Screen

This section contains the following topics:

- [Section 2.4.1, "Retrieving Service Location Record"](#)
- [Section 2.4.2, "Editing Service Location Record "](#)

- [Section 2.4.3, "Viewing Service Location Record"](#)
- [Section 2.4.4, "Deleting Service Location Record"](#)
- [Section 2.4.5, "Authorizing Service Location Record"](#)
- [Section 2.4.6, "Amending Service Location Record"](#)
- [Section 2.4.7, "Authorizing Amended Service Location Record"](#)

## 2.4.1 Retrieving Service Location Record

You can retrieve a previously entered record in the Service Location Maintenance Summary screen, as follows:

Invoke the Service Location Maintenance Summary screen by typing 'UTSSERLC' in the field at the top right corner of the Application tool bar and clicking on the adjoining arrow button. Specify any or all of the following details in the corresponding fields:

- The status of the transaction in the Authorized field. If you choose the "Blank Space" option, then all the records that involve the specified unit holder are retrieved.
- The status of the record in the Open field. If you choose the "Blank Space" option, then all the records that involve the specified unit holder are retrieved.
- Time Zone
- Service Location

Click 'Advanced Search' button for advanced level of query where records can be retrieved based on specific fields. Click 'Reset' button, so that the entire search criteria will be cleared for a new level of search. Click 'Search' button to view the records. All records with the specified details are retrieved and displayed in the lower portion of the screen. Click 'Refresh' button, so that the search criteria will be refreshed based on existing criteria.

---

### Note

You can also retrieve the individual record detail from the Service Location Maintenance screen by doing query in the following manner:

- Press F7
  - Input the Service Location/Time Zone
  - Press F8
- 

You can perform Edit, Delete, Amend, Authorize, Close and Re-open operation by selecting the operation from the Action list. To edit and amend a record, a user has to click unlock button under Action menu. If service location of the customer is already linked with UH, then the user cannot use the close operation.

You can also search the record by using combination of % and alphanumeric value.

Service Location Maintenance Summary

Search Advanced Search Reset Clear All

Search Is Case Sensitive

Authorization Status  Record Status

Service Location  Time Zone

Records per page 15 1 of 1 Go Lock Columns 0

Authorization Status	Record Status	Service Location	Service Location Description	Time Zone
----------------------	---------------	------------------	------------------------------	-----------

Exit

## 2.4.2 Editing Service Location Record

You can modify the details of Service Location Maintenance parameters that you have already entered into the system, provided it has not been subsequently authorized. You can perform this operation as follows:

- Invoke the Service Location Maintenance Summary screen from the Browser.
- Select the status of the record that you want to retrieve for modification in the Authorized field. You can only modify records that are unauthorized. Accordingly, choose the Unauthorized option.
- Specify any or all of the details in the corresponding fields to retrieve the record that is to be modified. All unauthorized records with the specified details are retrieved and displayed in the lower portion of the screen.
- Double click the record that you want to modify in the list of displayed records. The Service Location Detail screen is displayed.
- Select Unlock Operation from Action list to modify the record. Modify the necessary information.
- Click Save to save your changes. The Service Location Detail screen is closed and the changes made are reflected in the Service Location Maintenance Summary screen.

## 2.4.3 Viewing Service Location Record

To view a record that you have previously entered, you must retrieve the same in the Service Location Maintenance Summary screen, as follows:

- Invoke the Service Location Maintenance Summary Screen from the Browser.
- Select the status of the record that you want to retrieve for viewing in the Authorized field. You can also view all records that are either unauthorized or authorized only, by choosing the Unauthorized / Authorized option.
- Specify any or all of the details of the record in the corresponding fields on the screen, and click 'Search' button. All records with the specified details are retrieved and displayed in the lower portion of the screen.

- Double click the record that you want to view in the list of displayed records. The Service Location Maintenance Detail screen is displayed in View mode.

#### **2.4.4 Deleting Service Location Record**

You can delete only unauthorized records in the system. To delete a record that you have previously entered:

- Invoke the Service Location Maintenance Summary screen from the Browser.
- Select the status of the record that you want to retrieve for deletion.
- Specify any or all of the details and click 'Search' button. All records with the specified details are retrieved and displayed in the lower portion of the screen.
- Double click the record that you want to delete. The Service Location Maintenance Detail screen is displayed.
- Select Delete operation from the Action list. The system prompts you to confirm the deletion, and the record is deleted physically from the system database.

#### **2.4.5 Authorizing Service Location Record**

An unauthorized record must be authorized in the system for it to be processed. To authorize a record:

- Invoke the Service Location Maintenance Summary screen from the Browser.
- Select the status of the record that you want to retrieve for authorization. Typically, choose the Unauthorized option.
- Specify any or all of the details of the record in the corresponding fields on the screen. Click 'Search' button. All records with the specified details that are pending authorization are retrieved and displayed in the lower portion of the screen.
- Double click the transaction that you wish to authorize. The Service Location Maintenance Detail screen is displayed. Select Authorize operation from Action.

When the checker authorizes a transaction, details of validations, if any, that were overridden by the maker of the transaction during the Save operation, are displayed. If any of these overrides results in an error, the checker must reject the transaction.

#### **2.4.6 Amending Service Location Record**

After a record is authorized, it can be modified using the Unlock operation from Action list. To make changes to a transaction after authorization:

- Invoke the Service Location Maintenance Summary screen from the Browser.
- Select the status of the record that you wish to retrieve for amendment. You can amend only authorized records.
- Specify any or all of the details of the Service Location maintenance in the screen. All records with the specified details are retrieved and displayed in the lower portion of the screen.
- Double click the record that you want to amend. The Service Location Maintenance Detail screen is displayed in Amendment mode. Click the Unlock operation from the Action list to amend the record.
- Amend the necessary information. Click the Save button to save the changes.

## 2.4.7 Authorizing Amended Service Location Record

An amended service location record must be authorized for the amendment to be made effective in the system. The authorization of amended records can only be done from Fund Manager Module.

## 2.5 CIF Address Maintenance Screen

This section contains the following topic:

- [Section 2.5.1, "Invoking CIF Address Maintenance Screen"](#)

### 2.5.1 Invoking CIF Address Maintenance Screen

You can maintain as many addresses as required for a given CIF; you are also allowed to specify the media for the address. This can be done through the 'CIF Address Detail' screen. You can invoke this screen by typing 'UTDCADD' in the field at the top right corner of the Application tool bar and clicking on the adjoining arrow button.

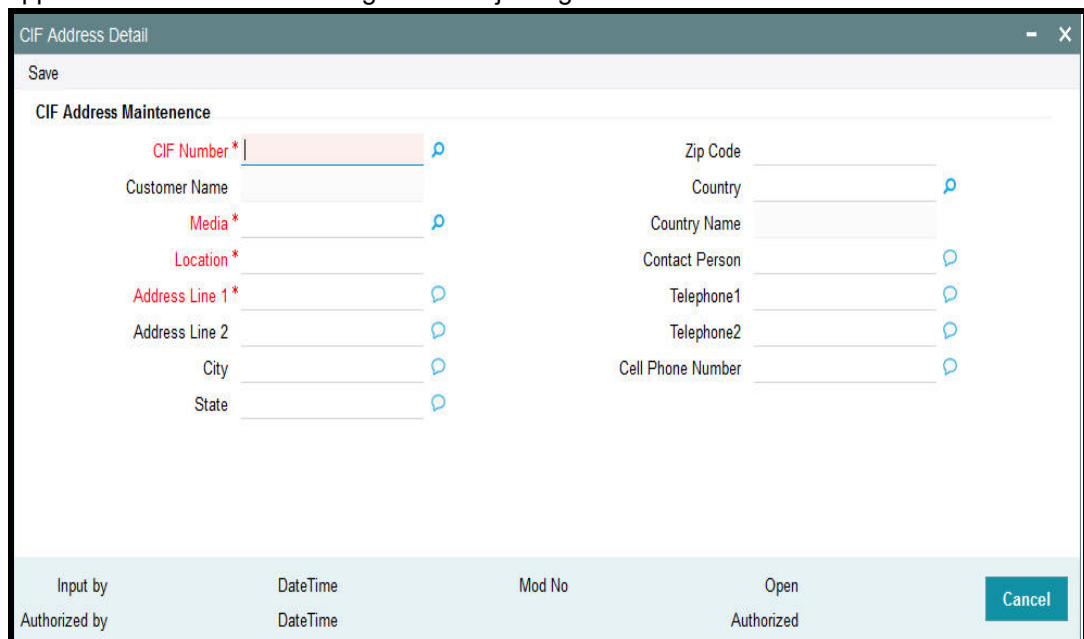

The screenshot shows the 'CIF Address Detail' window with a 'Save' button at the top left. The main area is titled 'CIF Address Maintenance' and contains the following fields:

CIF Number *	<input type="text"/>	Zip Code	<input type="text"/>
Customer Name	<input type="text"/>	Country	<input type="text"/>
Media *	<input type="text"/>	Country Name	<input type="text"/>
Location *	<input type="text"/>	Contact Person	<input type="text"/>
Address Line 1 *	<input type="text"/>	Telephone 1	<input type="text"/>
Address Line 2	<input type="text"/>	Telephone 2	<input type="text"/>
City	<input type="text"/>	Cell Phone Number	<input type="text"/>
State	<input type="text"/>		

At the bottom, there is a table for user information and a 'Cancel' button:

Input by	DateTime	Mod No	Open	Cancel
Authorized by	DateTime		Authorized	

Select 'New' from the Actions menu in the Application tool bar or click new icon to enter the details of the CIF Address screen.

### CIF Address Maintenance

#### **CIF Number**

*Alphanumeric; 12 Characters; Mandatory*

Specify the CIF number of the unit holder.

#### **Customer Name**

*Display*

The system displays the name of the customer for the selected CIF number.

#### **Media**

*Alphanumeric; 15 Characters; Mandatory*

Indicate the medium of communication you wish to avail, from the drop-down list. You could choose the Mail media. The List of values in drop down are parameterized in System Parameters under 'CIFMEDIA'.

**Location**

*Alphanumeric; 15 Characters; Mandatory*

Specify the location for correspondence with the unit holder.

**Address Line 1-2**

*Alphanumeric; 105 Characters; Mandatory*

Specify the postal address that is to be used for correspondence with the unit holder.

**City**

*Alphanumeric; 105 Characters; Optional*

Specify the name of the city of residence of the unit holder.

**State**

*Alphanumeric; 105 Characters; Optional*

Specify the state in which the city of residence of the unit holder is located.

**Zip Code**

*Alphanumeric; 10 Characters; Optional*

Specify the zip code of the specified city of residence of the unit holder.

**Country**

*Alphanumeric; 3 Characters; Optional*

Select the country in which the investor is domiciled, from the drop-down list.

**Country Name**

*Display*

The system displays the name of the country for the selected country code.

**Contact Person**

*Alphanumeric; 160 Characters; Optional*

Specify the name of the contact person at the unit holder's residence.

**Telephone Number 1-2**

*Alphanumeric; 60 Characters; Optional*

Enter the contact telephone numbers of the unit holder.

**Cell Phone Number**

*Alphanumeric; 105 Characters; Optional*

Specify the cell phone number of the unit holder.

---

**Note**

If customer Address is maintained for any CIF at FMG, then only the same CIF address can be accessed in respective branches.

---

## 2.6 CIF Address Summary Screen

This section contains the following topics:

- [Section 2.6.1, "Retrieving CIF Address Record"](#)
- [Section 2.6.2, "Editing CIF Address Record before Authorization "](#)
- [Section 2.6.3, "Viewing CIF Address Record before Authorization"](#)



- [Section 2.6.4, "Deleting CIF Address Record before Authorization"](#)
- [Section 2.6.5, "Authorizing CIF Address Record for Customer"](#)
- [Section 2.6.6, "Amending CIF Address Record for Customer"](#)
- [Section 2.6.7, "Authorizing Amended CIF Address Record for Customer"](#)

## 2.6.1 Retrieving CIF Address Record

You can retrieve a previously entered record in the CIF Address Summary screen, as follows:

Invoke the CIF Address Summary screen by typing 'UTSCADD' in the field at the top right corner of the Application tool bar and clicking on the adjoining arrow button. Specify any or all of the following details in the corresponding fields:

- The status of the transaction in the Authorized field. If you choose the "Blank Space" option, then all the records that involve the specified unit holder are retrieved.
- The status of the record in the Open field. If you choose the "Blank Space" option, then all the records that involve the specified unit holder are retrieved.
- CIF Number
- Media
- Location

Click 'Advanced Search' button for advanced level of query where records can be retrieved based on specific fields. Click 'Reset' button, so that the entire search criteria will be cleared for a new level of search. Click 'Search' button to view the records. All records with the specified details are retrieved and displayed in the lower portion of the screen. Click 'Refresh' button, so that the search criteria will be refreshed based on existing criteria.

---

### Note

You can also retrieve the individual record detail from the CIF Address detail screen by doing query in the following manner:

- Press F7
  - Input the CIF Number
  - Press F8
- 

You can perform Edit, Delete, Amend, Authorize, Reverse, Confirm operation by selecting from the Action list. To edit and amend a record a user has to click unlock button under Action menu.

You can also search the record by using combination of % and alphanumeric value.

### Example

You can search the record for CIF Number by using the combination of % and alphanumeric value as follows:-

- Search by A%: System will fetch all the records whose CIF Number starts from Alphabet 'A'. For Example: AGC17, AGVO6, AGC74 and so forth.
- Search by %7: System will fetch all the records whose CIF Number ends by numeric value '7'. For Example: AGC17, GSD267, AGC77 and so forth.

- Search by %17%: System will fetch all the records whose CIF Number contains the numeric value 17. For Example: GSD217, GSD172, AGC17 and so forth.

## 2.6.2 Editing CIF Address Record before Authorization

You can modify the details of CIF Address parameters that you have already entered into the system, provided it has not been subsequently authorized. You can perform this operation as follows:

- Invoke the CIF Address Summary screen from the Browser.
- Select the status of the record that you want to retrieve for modification in the Authorized field. You can only modify records that are unauthorized. Accordingly, choose the Unauthorized option.
- Specify any or all of the details in the corresponding fields to retrieve the record that is to be modified. All unauthorized records with the specified details are retrieved and displayed in the lower portion of the screen.
- Double click the record that you want to modify in the list of displayed records. The CIF Address Detail screen is displayed.
- Select Unlock Operation from Action list to modify the record. Modify the necessary information.
- Click Save to save your changes. The CIF Address Detail screen is closed and the changes made are reflected in the Customer Maintenance Summary screen.

## 2.6.3 Viewing CIF Address Record before Authorization

To view a record that you have previously entered, you must retrieve the same in the CIF Address Summary screen, as follows:

- Invoke the CIF Address Summary Screen from the Browser.
- Select the status of the record that you want to retrieve for viewing in the Authorized field. You can also view all records that are either unauthorized or authorized only, by choosing the Unauthorized / Authorized option.

- Specify any or all of the details of the record in the corresponding fields on the screen, and click 'Search' button. All records with the specified details are retrieved and displayed in the lower portion of the screen.
- Double click the record that you want to view in the list of displayed records. The CIF Address Detail screen is displayed in View mode.

#### **2.6.4 Deleting CIF Address Record before Authorization**

You can delete only unauthorized records in the system. To delete a record that you have previously entered:

- Invoke the CIF Address Summary screen from the Browser.
- Select the status of the record that you want to retrieve for deletion.
- Specify any or all of the details and click 'Search' button. All records with the specified details are retrieved and displayed in the lower portion of the screen.
- Double click the record that you want to delete. The CIF Address Detail screen is displayed.
- Select Delete operation from the Action list. The system prompts you to confirm the deletion, and the record is deleted physically from the system database.

#### **2.6.5 Authorizing CIF Address Record for Customer**

An unauthorized CIF Address record must be authorized in the system for it to be processed. To authorize a record:

- Invoke the CIF Address Summary screen from the Browser.
- Select the status of the record that you want to retrieve for authorization. Typically, choose the Unauthorized option.
- Specify any or all of the details of the record in the corresponding fields on the screen. Click 'Search' button. All records with the specified details that are pending authorization are retrieved and displayed in the lower portion of the screen.
- Double click the transaction that you wish to authorize. The CIF Address Detail screen is displayed. Select Authorize operation from Action.

When the checker authorizes a transaction, details of validations, if any, that were overridden by the maker of the transaction during the Save operation, are displayed. If any of these overrides results in an error, the checker must reject the transaction.

#### **2.6.6 Amending CIF Address Record for Customer**

After a CIF Address is authorized, it can be modified using the Unlock operation from Action list. To make changes to a transaction after authorization:

- Invoke the CIF Address Summary screen from the Browser.
- Select the status of the record that you wish to retrieve for amendment. You can only amend only authorized records.
- Specify any or all of the details of the CIF Address in the screen. All records with the specified details are retrieved and displayed in the lower portion of the screen.
- Double click the record that you want to amend. The CIF Address Detail screen is displayed in Amendment mode. Click the Unlock operation from the Action list to amend the record.
- Amend the necessary information. Click the Save button to save the changes.

## 2.6.7 Authorizing Amended CIF Address Record for Customer

An amended CIF Address record must be authorized for the amendment to be made effective in the system. The authorization of amended records can only be done from Fund Manager Module and Agency branch Module.

The process of authorization is subsequently the same as that for normal transactions.

## 2.7 CIF Address - Fund Maintenance Details

This section contains the following topic:

- [Section 2.7.1, "Invoking CIF Address - Fund Maintenance Details Screen"](#)

### 2.7.1 Invoking CIF Address - Fund Maintenance Details Screen

You can map the list of funds in which the unit holder has invested to the addresses that have been maintained for a given CIF. Provided the unit holder specifies the valid combination of the CIF Number, Media and Location as already maintained in the CIF Address Maintenance screen, you will allowed to select all or a list of funds for which this combination would be applicable. You can invoke the 'CIF Address – Fund Maintenance Detail' screen by typing 'UTDCFNMP' in the field at the top right corner of the Application tool bar and clicking on the adjoining arrow button.

The screenshot shows a software application window titled "CIF Address - Fund Maintenance Detail". At the top left, there is a "Save" button. Below it, the window is divided into two main sections. The first section, "CIF Address - Details", contains several input fields: "CIF Number \*" (with a search icon), "Location \*" (with a search icon), "MEDIA \*" (with a search icon), "Customer Name", "Address Line 1", "City", "Zip Code", "Contact Person", "Telephone 1", "Address Line 2", "State", "Country", "Telephone 2", and "Cellphone Number". The second section, "CIF Address - Fund Mapping", contains three input fields: "Fund ID \*" (with a search icon), "Fund Name", and "Fund Identification Number". At the bottom of the window, there is a table with columns for "Input by", "Authorized by", "DateTime", "Mod No", "Open", and "Authorized". A "Cancel" button is located at the bottom right of the window.

Select 'New' from the Actions menu in the Application tool bar or click new icon to enter the details of the CIF Address – Fund screen.

## **CIF Address - Details**

### **CIF Number**

*Alphanumeric; 12 Characters; Mandatory*

Select the CIF number of the unit holder for the adjoining list.

All enabled addresses of customer will be listed along with location and Media and maintained from FCC.

### **Media**

*Alphanumeric; 15 Characters; Mandatory*

Specify the media of communication as maintained in the CIF Address Maintenance screen. Alternatively, you can also select media of communication from the option list.

### **Location**

*Display*

The system displays the location for correspondence with the unit holder as maintained in the CIF Address Maintenance screen.

### **Customer Name**

*Display*

The system displays the name of the customer for the selected CIF number.

### **Address1-2**

*Display*

The system displays the postal address that is to be used for correspondence with the unit holder.

### **City**

*Display*

The system displays the name of the city of residence of the unit holder.

### **State**

*Display*

The system displays the state in which the city of residence of the unit holder is located.

### **Zip Code**

*Display*

The system displays the zip code of the specified city of residence of the unit holder.

### **Country**

*Display*

The system displays the country in which the investor is domiciled, from the drop-down list.

### **Contact Person**

*Display*

The system displays the name of the contact person at the unit holder's residence.

### **Cell Phone Number**

*Display*

The system displays the cell phone number of the unit holder.

## **TelephoneNumber1-2**

*Display*

The system displays the contact telephone numbers of the unit holder.

## **CIF Address – Fund Mapping**

You can select the Fund IDs for which you wish the specified address details to be applicable. Once you select the fund ID, the system displays the fund name and the fund identification number.

### **Fund ID**

*Alphanumeric; 6 Characters; Mandatory*

Specify the fund ID.

### **Fund Name**

*Display*

The system displays the name of the fund for the selected fund ID.

### **Fund Identification Number**

*Display*

The system displays the fund identification number.

---

### **Note**

If customer Address is maintained for any CIF and mapped to fund at FMG, then only the same CIF address fund mapping details can be accessed in respective branches.

---

## **2.8 CIF Address Fund Summary Screen**

This section contains the following topics:

- [Section 2.8.1, "Retrieving CIF Address – Fund Record"](#)
- [Section 2.8.2, "Editing CIF Address – Fund Record before Authorization "](#)
- [Section 2.8.3, "Viewing CIF Address – Fund Record before Authorization"](#)
- [Section 2.8.4, "Deleting CIF Address – Fund Record before Authorization"](#)
- [Section 2.8.5, "Authorizing CIF Address – Fund Record for Customer"](#)
- [Section 2.8.6, "Amending CIF Address – Fund Record for Customer"](#)
- [Section 2.8.7, "Authorizing Amended CIF Address – Fund Record for Customer"](#)

### **2.8.1 Retrieving CIF Address – Fund Record**

You can retrieve a previously entered record in the CIF Address – Fund Summary screen, as follows:

- Invoke the CIF Address - Fund Summary screen by typing 'UTSCFNMP' in the field at the top right corner of the Application tool bar and clicking on the adjoining arrow button. Specify any or all of the following details in the corresponding fields:
- The status of the transaction in the Authorized field. If you choose the "Blank Space" option, then all the records that involve the specified unit holder are retrieved.
- The status of the record in the Open field. If you choose the "Blank Space" option, then all the records that involve the specified unit holder are retrieved.
- CIF Number

- Media
- Location
- Fund ID

Click 'Search' button to view the records. All records with the specified details are retrieved and displayed in the lower portion of the screen.

---

**Note**

You can also retrieve the individual transaction detail from the CIF Address detail screen by doing query in the following manner:

- Press F7
  - Input the CIF Number
  - Press F8
- 

You can perform Edit, Delete, Amend, Authorize, Reverse, Confirm operation by selecting from the Action list.

You can also search the record by using combination of % and alphanumeric value.

**Example**

You can search the record for CIF Number by using the combination of % and alphanumeric value as follows:-

- Search by A%: System will fetch all the records whose CIF Number starts from Alphabet 'A'. For Example: AGC17, AGVO6, AGC74 and so forth.
- Search by %7: System will fetch all the records whose CIF Number ends by numeric value '7'. For Example: AGC17, GSD267, AGC77 and so forth.
- Search by %17%: System will fetch all the records whose CIF Number contains the numeric value 17. For Example: GSD217, GSD172, AGC17 and so forth.

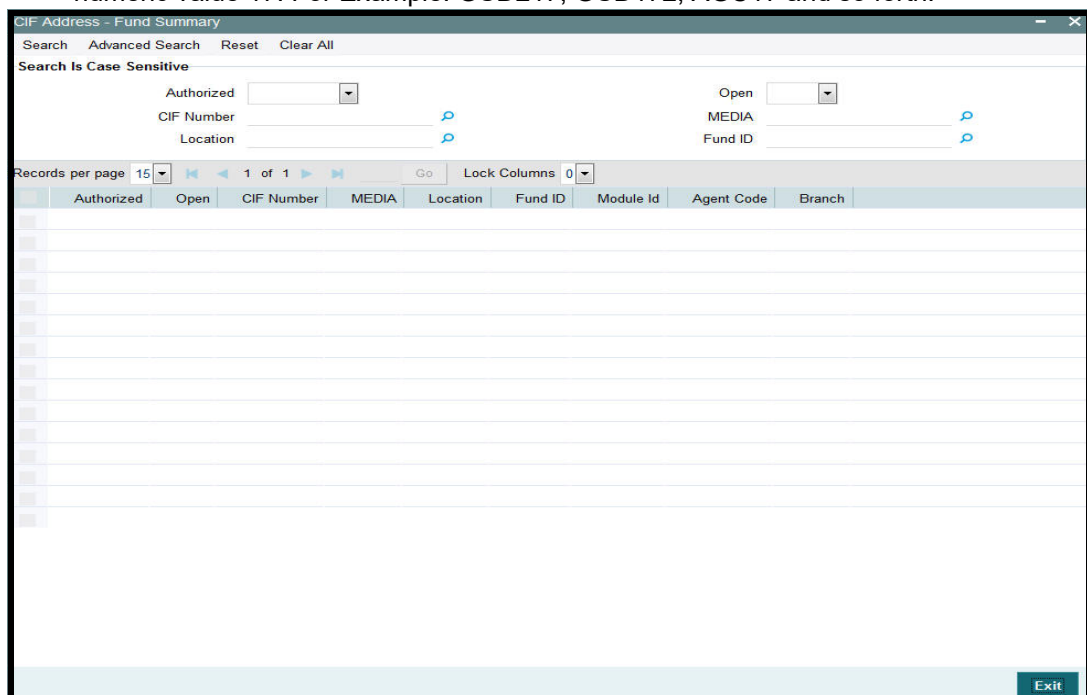

## **2.8.2 Editing CIF Address – Fund Record before Authorization**

You can modify the details of CIF Address – Fund parameters that you have already entered into the system, provided it has not been subsequently authorized. You can perform this operation as follows:

- Invoke the CIF Address – Fund Summary screen from the Browser.
- Select the status of the record that you want to retrieve for modification in the Authorized field. You can only modify records that are unauthorized. Accordingly, choose the Unauthorized option.
- Specify any or all of the details in the corresponding fields to retrieve the record that is to be modified. All unauthorized records with the specified details are retrieved and displayed in the lower portion of the screen.
- Double click the record that you want to modify in the list of displayed records. The CIF Address – Fund Detail screen is displayed.
- Select Unlock Operation from Action list to modify the record. Modify the necessary information.
- Click Save to save your changes. The CIF Address – Fund Detail screen is closed and the changes made are reflected in the CIF Address – Fund Summary screen.

## **2.8.3 Viewing CIF Address – Fund Record before Authorization**

To view a record that you have previously entered, you must retrieve the same in the CIF Address – Fund Summary screen, as follows:

- Invoke the CIF Address – Fund Summary Screen from the Browser.
- Select the status of the record that you want to retrieve for viewing in the Authorized field. You can also view all records that are either unauthorized or authorized only, by choosing the Unauthorized / Authorized option.
- Specify any or all of the details of the record in the corresponding fields on the screen, and click 'Search' button. All records with the specified details are retrieved and displayed in the lower portion of the screen.
- Double click the record that you want to view in the list of displayed records. The CIF Address – Fund Detail screen is displayed in View mode.

## **2.8.4 Deleting CIF Address – Fund Record before Authorization**

You can delete only unauthorized records in the system. To delete a record that you have previously entered:

- Invoke the CIF Address – Fund Summary screen from the Browser.
- Select the status of the record that you want to retrieve for deletion.
- Specify any or all of the details and click 'Search' button. All records with the specified details are retrieved and displayed in the lower portion of the screen.
- Double click the record that you want to delete. The CIF Address – Fund Detail screen is displayed.
- Select Delete operation from the Action list. The system prompts you to confirm the deletion, and the record is deleted physically from the system database.

## **2.8.5 Authorizing CIF Address – Fund Record for Customer**

An unauthorized CIF Address – Fund record must be authorized in the system for it to be processed. To authorize a record:

- Invoke the CIF Address – Fund Summary screen from the Browser.



- Select the status of the record that you want to retrieve for authorization. Typically, choose the Unauthorized option.
- Specify any or all of the details of the record in the corresponding fields on the screen. Click 'Search' button. All records with the specified details that are pending authorization are retrieved and displayed in the lower portion of the screen.
- Double click the transaction that you wish to authorize. The CIF Address – Fund Detail screen is displayed. Select Authorize operation from Action.

When the checker authorizes a transaction, details of validations, if any, that were overridden by the maker of the transaction during the Save operation, are displayed. If any of these overrides results in an error, the checker must reject the transaction.

### **2.8.6 Amending CIF Address – Fund Record for Customer**

After a CIF Address – Fund is authorized, it can be modified using the Unlock operation from Action list. To make changes to a record after authorization:

- Invoke the CIF Address – Fund Summary screen from the Browser.
- Select the status of the record that you wish to retrieve for amendment. You can only amend only authorized records.
- Specify any or all of the details of the CIF Address – Fund in the screen. All records with the specified details are retrieved and displayed in the lower portion of the screen.
- Double click the record that you want to amend. The CIF Address – Fund Detail screen is displayed in Amendment mode. Click the Unlock operation from the Action list to amend the record.
- Amend the necessary information. Click the Save button to save the changes.

### **2.8.7 Authorizing Amended CIF Address – Fund Record for Customer**

An amended CIF Address – Fund record must be authorized for the amendment to be made effective in the system. The authorization of amended records can only be done from Fund Manager Module and Agency branch Module.

The process of authorization is subsequently the same as that for normal transactions.

## **2.9 CIF-UH Mapping Detail**

This section contains the following topics:

- [Section 2.9.1, "Invoking CIF-UH Mapping Detail Screen"](#)

## 2.9.1 Invoking CIF-UH Mapping Detail Screen

You can map customer unit holder using 'CIF-UH Mapping Detail' screen. You can invoke this screen by typing 'UTDCIFUH' in the field at the top right corner of the Application tool bar and clicking on the adjoining arrow button.

The screenshot shows a software window titled "CIF-UH Mapping Detail". At the top left is a "Save" button. The main area is divided into three sections: "Customer Unit Holder Mapping" with a "Reference Number" input field; "Unit Holder Details" with "Unit Holder ID \*" and "Unit Holder Name" input fields, a "CIF Number" input field, and a blue "UH FIND" button; and "Re-Mapping Details" with "New CIF Number \*" and "Customer Name" input fields, and a blue "Find CIF" button. At the bottom, there are fields for "Input by", "Authorized by", "DateTime", "Mod No", "Open", and "Authorized", along with "Ok" and "Cancel" buttons.

You can specify the following details:

### **Customer Unit Holder Mapping**

#### **Reference Number**

*Display*

The system displays the reference number.

### **Unit Holder Details**

#### **Unit Holder ID**

*Alphanumeric; 12 Characters; Mandatory*

Specify the unit holder ID.

#### **Unit Holder Name**

*Display*

The system displays the name of the specified unit holder ID.

#### **CIF Number**

*Display*

The system displays the CIF number based on the unit holder selected.

You can also search for unit holder by clicking 'UH Find' button.

### **Re-Mapping Details**

#### **New CIF Number**

*Alphanumeric; 12 Characters; Mandatory*

Specify the new CIF number that needs to be re-mapped.

## Customer Name

### Display

The system displays the name of the customer for the selected new CIF number.

You can also search for CIF number by clicking 'Find CIF' button.

---

### Note

The system will validate to restrict the UH mapping to new CIF will happen only when the UH Protection level and CIF protection level are same.

---

## 2.10 CIF-UH Mapping Summary

This section contains the following topics:

- [Section 2.10.1, "Retrieving CIF-UH Mapping Record"](#)
- [Section 2.10.2, "Editing CIF-UH Mapping Record"](#)
- [Section 2.10.3, "Viewing CIF-UH Mapping Record"](#)
- [Section 2.10.4, "Delete CIF-UH Mapping Record"](#)
- [Section 2.10.5, "Authorizing CIF-UH Mapping Record"](#)
- [Section 2.10.6, "Amending CIF-UH Mapping Record"](#)
- [Section 2.10.7, "Authorizing an Amended CIF-UH Mapping Record"](#)

### 2.10.1 Retrieving CIF-UH Mapping Record

You can invoke the 'CIF-UH Mapping Summary' screen by typing 'UTSCIFUH' in the field at the top right corner of the Application tool bar and clicking on the adjoining arrow button.

The screenshot shows the 'CIF-UH Mapping Summary' application window. The window title is 'CIF-UH Mapping Summary'. The interface includes a search bar with 'Search', 'Advanced Search', 'Reset', and 'Clear All' options. Below the search bar, there are two dropdown menus labeled 'Authorized' and 'Open'. There are also two input fields for 'Unit Holder ID' and 'New CIF Number', each with a magnifying glass icon. The main area contains a table with columns: Authorized, Open, Reference Number, Unit Holder ID, New CIF Number, and CIF Number. The table is currently empty. At the bottom right, there is an 'Exit' button.

To retrieve a previously entered third party entity record:

- Invoke the CIF-UH Mapping Summary screen and specify the following:
  - The authorization status of the CIF-UH Mapping record in the Authorized field. If you choose the “Blank Space” option, then all the records are retrieved.
  - The status of the CIF-UH Mapping records in the Open field. If you choose the “Blank Space” option, then all the records are retrieved.
  - Unit Holder ID
  - New CIF Number
- After you have specified the required details, click 'Search'. All records with the specified details are retrieved and displayed in the lower portion of the screen.

You can also retrieve an CIF-UH Mapping detail from the Detail screen by doing query in the following manner:

- Press F7
- Input the Unit Holder ID
- Press F8

You can perform Edit, Delete, Amend, Authorize, operation by selecting from the Action list.

You can also search the record by using combination of % and alphanumeric value.

### **2.10.2 Editing CIF-UH Mapping Record**

You can modify the details of a CIF-UH mapping record that you have already entered into the system, provided it has not been subsequently authorized. You can perform this operation as follows:

1. Invoke the CIF-UH Mapping Summary screen from the Browser.
2. Select the authorization status of the records that you want to retrieve for modification in the Authorized field. You can only modify records that are unauthorized. Accordingly, choose the Unauthorized option from the drop-down list.
3. Specify any or all of the search parameters for retrieving the records.
4. Click 'Search'. All unauthorized CIF-UH mapping records with the specified details are retrieved and displayed in the lower portion of the screen.
5. Double click the record that you want to modify. The CIF-UH Mapping Detail screen is displayed.
6. Select Unlock Operation from Action list to modify the record. Modify the necessary information.
7. Click Save to save the changes. The CIF-UH Mapping Detail screen is closed and the changes made are reflected in the CIF-UH Mapping Summary screen.

### **2.10.3 Viewing CIF-UH Mapping Record**

To view the CIF-UH mapping details that you have previously entered:

1. Invoke the CIF-UH Mapping Summary Screen from the Browser.
2. Select the authorization status of the CIF-UH mapping records that you want to retrieve for viewing in the Authorized field. You can also view all the CIF-UH mapping records that are either unauthorized or authorized only, by choosing the Unauthorized / Authorized option.

3. Specify any or all of the search parameters for retrieving the records.
4. Click 'Search'. All records with the specified details are retrieved and displayed in the lower portion of the screen.
5. Double click the record that you want to view. The CIF-UH Mapping screen Detail is displayed in view mode.

#### **2.10.4 Delete CIF-UH Mapping Record**

You can delete only unauthorized records in the system. To delete CIF-UH mapping record:

1. Invoke the CIF-UH Mapping Summary screen from the Browser.
2. Select the status of the record that you want to retrieve for deletion.
3. Specify any or all of the search parameters in the corresponding fields on the screen.
4. Click 'Search'. All records with the specified details are retrieved and displayed in the lower portion of the screen.
5. Double click the record that you want to delete. The CIF-UH Mapping Detail screen is displayed.
6. Select Delete operation from the Action list. The system prompts you to confirm the deletion, and the record is deleted physically from the system database.

#### **2.10.5 Authorizing CIF-UH Mapping Record**

An unauthorized CIF-UH mapping record must be authorized in the system for it to come into effect. To authorize CIF-UH mapping record:

1. Invoke the CIF-UH Mapping Summary screen from the Browser.
2. Select the status of CIF-UH mapping record that you want to retrieve for authorization. Typically, choose the unauthorized option from the drop-down list.
3. Specify any or all of the search parameters in the corresponding fields on the screen.
4. Click 'Search'. All records with the specified details that are pending authorization are retrieved and displayed in the lower portion of the screen.
5. Double click the record that you wish to authorize. The CIF-UH Mapping screen displayed. Select Authorize operation from Action.

When the checker authorizes CIF-UH mapping details, details of validations, if any, that were overridden by the maker of the CIF-UH mapping details during the Save operation, are displayed. If any of these overrides results in an error, the checker must reject the maintenance.

#### **2.10.6 Amending CIF-UH Mapping Record**

After CIF-UH mapping entity record is authorized, it can be modified using the Unlock operation from Action list. To make changes to CIF-UH mapping record after authorization, you must invoke the Unlock operation which is termed as Amend Operation.

1. Invoke the CIF-UH Mapping Summary screen from the Browser.
2. Select the status of the record that you wish to retrieve for amendment. You can only amend records that are authorized.
3. Specify any or all of the search parameters in the corresponding fields on the screen.
4. Click 'Search'. All records with the specified details are retrieved and displayed in the lower portion of the screen.

5. Double click the record that you want to amend. The CIF-UH Mapping Detail screen is displayed in Amendment mode.
6. Click the Unlock operation from the Action list to amend the record.
7. Amend the necessary information. Click the Save button to save the changes

## 2.10.7 Authorizing an Amended CIF-UH Mapping Record

An amended CIF-UH mapping record must be authorized for the amendment to be made effective in the system. The process of authorization is the same as the process of normal authorization.

## 2.11 CIF Merge Change Hierarchy Detail

This section contains the following topics:

- [Section 2.11.1, "Invoking CIF Merge Change Hierarchy Detail Screen"](#)

### 2.11.1 Invoking CIF Merge Change Hierarchy Detail Screen

You can maintain CIF Merge or hierarchy change details using 'CIF Merge Change Hierarchy Detail' screen. You can invoke this screen by typing 'UTDCMHCH' in the field at the top right corner of the Application tool bar and clicking on the adjoining arrow button.

You can specify the following details:

## **CIF Merge Change Hierarchy**

### **Operation Type**

*Mandatory*

Select the type of operation from the drop-down list. The list displays the following values:

- Hierarchy Change
- CIF Merge

### **Serial Number**

*Display*

The system displays the serial number by clicking the 'Populate' button.

### **From CIF Number**

*Alphanumeric; 12 Characters; Mandatory*

Specify the From CIF number.

### **To CIF ID**

*Alphanumeric; 12 Characters; Mandatory*

Specify the To CIF number.

You can also search for 'From CIF Number' and 'To CIF ID' by clicking 'Find' button.

---

#### **Note**

In case of CIF merger, From CIF and To CIF should be of the same protection level.

---

### **Level of Hierarchy Change**

*Optional*

Select the level of hierarchy change from the drop-down list. The list displays the following values:

- Agent
- Agent Branch
- Account Officer
- IFA

### **Close Account Post Merge**

*Optional*

Select if the account has to be closed post merge operation or not from the drop-down list. The list displays the following values:

- Yes
- No

### **Merge Change/Hierarchy Status**

*Optional*

Select the merge change or hierarchy status from the drop-down list. The list displays the following values:

- Generated
- Reversed

After specifying all the necessary details, click 'Populate' button. The system displays the following values:

- Unit Holder ID
- Fund ID
- Unit Balance
- Product ID
- Policy Number
- Agent Code
- Branch
- Account Officer
- IFA
- Merge Or Not?
- To Agent Code
- To Branch Code
- To Account Officer
- To IFA

**To UnitHolder ID**

*Alphanumeric; 16 Characters; Optional*

Specify the To unit holder ID. You can also select To Unit Holder ID by selecting 'Find UH' button.

**Merger or Not**

*Optional*

Check this box if the details has to be merged.

**To Agent Code**

*Alphanumeric; 12 Characters; Optional*

Specify the To agent code.

**To Branch Code**

*Alphanumeric; 12 Characters; Optional*

Specify the To branch code.

**To Account Officer**

*Alphanumeric; 12 Characters; Optional*

Specify the To account officer details.

**To IFA**

*Alphanumeric; 12 Characters; Optional*

Specify the To IFA details.

---

**Note**

CIF Merge cannot be combined with distributor change. This would mean that during CIF Merge operation, the distributor details for the 'From Hierarchy' and 'To Hierarchy' would be the same.

---



## 2.12 CIF Merge Change Hierarchy Summary

This section contains the following topics:

- [Section 2.12.1, "Retrieving CIF Merge Change Hierarchy Record"](#)
- [Section 2.12.2, "Editing CIF Merge Change Hierarchy Record"](#)
- [Section 2.12.3, "Viewing CIF Merge Change Hierarchy Record"](#)
- [Section 2.12.4, "Delete CIF Merge Change Hierarchy Record"](#)
- [Section 2.12.5, "Authorizing CIF Merge Change Hierarchy Record"](#)
- [Section 2.12.6, "Amending CIF Merge Change Hierarchy Record"](#)
- [Section 2.12.7, "Authorizing an Amended CIF Merge Change Hierarchy Record"](#)

### 2.12.1 Retrieving CIF Merge Change Hierarchy Record

You can invoke the 'CIF Merge Change Hierarchy Summary' screen by typing 'UTSCMHCH' in the field at the top right corner of the Application tool bar and clicking on the adjoining arrow button.

The screenshot displays the 'FCIS CIF Merge Change Hierarchy Summary' application window. The interface includes a search bar at the top with options for 'Search', 'Advanced Search', 'Reset', and 'Clear All'. Below the search bar, there are input fields for 'Authorized', 'Serial Number', and 'CIF Number', each with a magnifying glass icon. To the right, there are 'Open' and 'Operation Type' dropdown menus. A table below shows columns for 'Authorized', 'Open', 'Status', 'Serial Number', 'Operation Type', 'Level of Hierarchy Change', 'CIF Number', 'To CIF Number', and 'Merge Change'. The table is currently empty. At the bottom, there are 'Delete', 'Authorize', and 'Find UH' buttons, and an 'Exit' button in the bottom right corner.

To retrieve a previously entered third party entity record:

- Invoke the CIF Merge Change Hierarchy Summary screen and specify the following:
  - The authorization status of the CIF Merge Change Hierarchy record in the Authorized field. If you choose the "Blank Space" option, then all the records are retrieved.
  - The status of the CIF Merge Change Hierarchy records in the Open field. If you choose the "Blank Space" option, then all the records are retrieved.
  - Serial Number
  - CIF Number
  - Operation Type
- After you have specified the required details, click 'Search'. All records with the specified details are retrieved and displayed in the lower portion of the screen.

You can also retrieve an individual CIF Merge Change Hierarchy detail from the Detail screen by doing query in the following manner:

- Press F7
- Input the CIF Number
- Press F8

You can perform Edit, Delete, Amend, Authorize, operation by selecting from the Action list.

You can also search the record by using combination of % and alphanumeric value.

### **2.12.2 Editing CIF Merge Change Hierarchy Record**

You can modify the details of a CIF Merge Change Hierarchy record that you have already entered into the system, provided it has not been subsequently authorized. You can perform this operation as follows:

1. Invoke the CIF Merge Change Hierarchy Summary screen from the Browser.
2. Select the authorization status of the records that you want to retrieve for modification in the Authorized field. You can only modify records that are unauthorized. Accordingly, choose the Unauthorized option from the drop-down list.
3. Specify any or all of the search parameters for retrieving the records.
4. Click 'Search'. All unauthorized CIF Merge Change Hierarchy records with the specified details are retrieved and displayed in the lower portion of the screen.
5. Double click the record that you want to modify. The CIF Merge Change Hierarchy Detail screen is displayed.
6. Select Unlock Operation from Action list to modify the record. Modify the necessary information.
7. Click Save to save the changes. The CIF Merge Change Hierarchy Detail screen is closed and the changes made are reflected in the CIF Merge Change Hierarchy Summary screen.

### **2.12.3 Viewing CIF Merge Change Hierarchy Record**

To view the CIF Merge Change Hierarchy details that you have previously entered:

1. Invoke the CIF Merge Change Hierarchy Summary Screen from the Browser.
2. Select the authorization status of the CIF Merge Change Hierarchy records that you want to retrieve for viewing in the Authorized field. You can also view all the CIF Merge Change Hierarchy records that are either unauthorized or authorized only, by choosing the Unauthorized / Authorized option.
3. Specify any or all of the search parameters for retrieving the records.
4. Click 'Search'. All records with the specified details are retrieved and displayed in the lower portion of the screen.
5. Double click the record that you want to view. The CIF Merge Change Hierarchy Detail is displayed in view mode.

### **2.12.4 Delete CIF Merge Change Hierarchy Record**

You can delete only unauthorized records in the system. To delete CIF Merge Change Hierarchy record:

1. Invoke the CIF Merge Change Hierarchy Summary screen from the Browser.

2. Select the status of the record that you want to retrieve for deletion.
3. Specify any or all of the search parameters in the corresponding fields on the screen.
4. Click 'Search'. All records with the specified details are retrieved and displayed in the lower portion of the screen.
5. Double click the record that you want to delete. The CIF Merge Change Hierarchy Detail screen is displayed.
6. Select Delete operation from the Action list. The system prompts you to confirm the deletion, and the record is deleted physically from the system database.

### **2.12.5 Authorizing CIF Merge Change Hierarchy Record**

An unauthorized CIF Merge Change Hierarchy record must be authorized in the system for it to come into effect. To authorize CIF Merge Change Hierarchy record:

1. Invoke the CIF Merge Change Hierarchy Summary screen from the Browser.
2. Select the status of CIF Merge Change Hierarchy record that you want to retrieve for authorization. Typically, choose the unauthorized option from the drop-down list.
3. Specify any or all of the search parameters in the corresponding fields on the screen.
4. Click 'Search'. All records with the specified details that are pending authorization are retrieved and displayed in the lower portion of the screen.
5. Double click the record that you wish to authorize. The CIF Merge Change Hierarchy screen displayed. Select Authorize operation from Action.

When the checker authorizes CIF Merge Change Hierarchy details, details of validations, if any, that were overridden by the maker of the CIF Merge Change Hierarchy details during the Save operation, are displayed. If any of these overrides results in an error, the checker must reject the maintenance.

### **2.12.6 Amending CIF Merge Change Hierarchy Record**

After CIF Merge Change Hierarchy is authorized, it can be modified using the Unlock operation from Action list. To make changes to CIF Merge Change Hierarchy record after authorization, you must invoke the Unlock operation which is termed as Amend Operation.

1. Invoke the CIF Merge Change Hierarchy Summary screen from the Browser.
2. Select the status of the record that you wish to retrieve for amendment. You can only amend records that are authorized.
3. Specify any or all of the search parameters in the corresponding fields on the screen.
4. Click 'Search'. All records with the specified details are retrieved and displayed in the lower portion of the screen.
5. Double click the record that you want to amend. The CIF Merge Change Hierarchy Detail screen is displayed in Amendment mode.
6. Click the Unlock operation from the Action list to amend the record.
7. Amend the necessary information. Click the Save button to save the changes

### **2.12.7 Authorizing an Amended CIF Merge Change Hierarchy Record**

An amended CIF Merge Change Hierarchy record must be authorized for the amendment to be made effective in the system. The process of authorization is the same as the process of normal authorization.

---

**Note**

In case of batch screen or batch activity, there will be no restriction on fetching protected UH/CIF.

---

Screen or Process where there will be no restriction applicable are as follows:

<b>Batch Activity</b>	<b>Function ID</b>
EOD activity	UTDEODEX
Mini EOD activity	UTDEODMI
Pre EOD check	UTDPREOD
Branch Sign Off/On	UTDBSNOF
Process Dividend Payment	UTDDIPMT
Process Dividend Reinvestments	UTDPRRIN
Mock Dividend	UTDMOCKD
Mock Dividend Execute	UTDMCKDV
Mass Amendment	UTDMASAM
Selected UH Dividend Reversal	UTDSELUH
Dividend Reversal/Mass Reprocess	UTDMASRE

## **2.13 Customer Find Screen Detail**

This section contains the following topics:

- [Section 2.13.1, "Invoking Customer Find Detail Screen"](#)

## 2.13.1 Invoking Customer Find Detail Screen

You can query for customer details using 'Customer Find Screen Detail' screen. You can invoke this screen by typing 'UTCCIFND' in the field at the top right corner of the Application tool bar and clicking on the adjoining arrow button.

The screenshot shows the 'Customer Find Screen Detail' application window. It features a search interface with the following sections:

- Quick find Options:** A grid of search criteria including CIF Number, External Reference Number, Date Of Birth, Incorporation Date, Country Of Domicile, First name, Last Name, Middle Name, Company Name, and Nationality.
- Advanced Find Options:** A section for Address Line 1 and Country.
- Find Results:** A table with columns for Investor Type, First name, Last Name, Middle Name, and Company Name. The table shows 1 of 1 results.

You can specify the following details:

### **Quick Find Options**

Specify the nationality of the customer.

#### **CIF Number**

*Alphanumeric; 9 Characters; Optional*

Specify the CIF number of the customer.

#### **External Reference Number**

*Alphanumeric; 50 Characters; Optional*

Specify the External Reference Number of the customer.

#### **Date Of Birth**

*Date Format; Optional*

Select the date of birth of the customer from the adjoining calendar.

#### **Incorporation Date**

*Date Format; Optional*

Select the date of incorporation from the adjoining calendar.

**Country Of Domicile**

*Alphanumeric; 3 Characters; Optional*

Specify the country of domicile of the customer.

**First Name**

*Alphanumeric; 105 Characters; Optional*

Specify the first name of the customer.

**Last Name**

*Alphanumeric; 105 Characters; Optional*

Specify the last name of the customer.

**Middle Name**

*Alphanumeric; 105 Characters; Optional*

Specify the middle name of the customer.

**Company Name**

*Alphanumeric; 105 Characters; Optional*

Specify the Company name.

**Nationality**

*Alphanumeric; 3 Characters; Optional*

Specify the nationality of the customer.

**Investor Type**

*Optional*

Select the type of investor from the drop-down list. The list displays the following values:

- Individual
- Corporate
- Both

**Tax ID**

*Alphanumeric; 50 Characters; Optional*

Specify the Tax ID number.

**National ID**

*Alphanumeric; 3 Characters; Optional*

Specify the National ID of the customer.

**Identification Number**

*Alphanumeric; 50 Characters; Optional*

Specify the identification number.

**Advanced Find Options****Address Line 1**

*Alphanumeric; 35 Characters; Optional*

Specify the Address Line 1 of the customer.

**Country**

*Alphanumeric; 3 Characters; Optional*

Specify the country name of the customer.

## Employer Identification Number

*Alphanumeric; 50 Characters; Optional*

Specify the Employer Identification Number of the customer.

## Find Results

The screenshot displays the 'Customer Find Screen Detail' window. It features a 'Quick find Options' section with input fields for CIF Number, External Reference Number, Date Of Birth, Incorporation Date, Country Of Domicile, First name, Last Name, Middle Name, Company Name, Nationality, Investor Type (a dropdown menu set to 'Both'), Tax ID, National ID, and Identification Number. A 'Find' button is located below these fields. Below the quick options is an 'Advanced Find Options' section with fields for Address Line 1, Country, and Employer Identification Number. At the bottom, there is a 'Find Results' section with a table header containing the following columns: IdentificationNumber, Country Of Domicile, Date Of Birth, Incorporation Date, National ID, Address Line 1, Country, Nationality, Employer Identification Number, and External Reference Number. The table body is currently empty. A 'Go' button is located to the left of the table header, and an 'Exit' button is in the bottom right corner of the window.

The system displays the following values:

- Investor Type
- First name
- Last Name
- Middle Name
- Company Name
- Customer No.
- Tax ID
- Identification Number
- Country Of Domicile
- Date Of Birth
- Incorporation Date
- National ID
- Address Line 1
- Country
- Nationality

- Employer Identification Number
- External Reference Number

## 2.14 Customer Log Details

This section contains the following topics:

- [Section 2.14.1, "Invoking Customer Log Details Screen"](#)

### 2.14.1 Invoking Customer Log Details Screen

You can view the status of the CIF moving from FCUBS to FCIS when integration is enabled. You can invoke 'Customer Log Details' screen by typing 'UTDCIFLG' in the field at the top right corner of the Application tool bar and clicking on the adjoining arrow button.

You can specify the following details:

#### **Customer No**

*Alphanumeric; 11 Characters; Mandatory*

Specify the customer number. Alternatively, you can select customer number from the option list. The list displays all valid customers moving from UBS to IS.

After specifying the customer number, click 'Search' button. The system displays the following values:

#### **Error Code**

*Display*

The system displays the error code for the customer number if any error occurs while customer is moving from UBS to IS.



### **Error Description**

#### *Display*

The system displays the description of the error code.

## **2.15 CIF Accessibility Mapping Detail Screen**

This section contains the following topics:

- [Section 2.15.1, "Invoking CIF Accessibility Mapping Detail Screen"](#)
- [Section 2.15.2, "Fields in CIF Accessibility Mapping Detail Screen"](#)

### **2.15.1 Invoking CIF Accessibility Mapping Detail Screen**

You can map customer number to AGY modules using 'CIF Accessibility Mapping Detail' screen. It is available only in the FMG Module and it should be used only in GTA setup. You can invoke this screen by typing 'UTDCIFAC' in the field at the top right corner of the Application tool bar and clicking on the adjoining arrow button.

### **2.15.2 Fields in CIF Accessibility Mapping Detail Screen**

You can specify the following details:

#### **CIF Number**

*Alphanumeric; 9 Characters; Mandatory*

Specify the CIF number of the unit holder.

#### **From Module ID**

*Alphanumeric; 30 Characters; Mandatory*

Specify the module ID. Alternatively, you can select module ID from the LOV. The list displays the module ID maintained in the system.

#### **AGY Module Mapping**

AGY Module mapping is used to map customer with one or more AGY. It includes the following fields.

- AGY Module ID
- Agent Code
- Branch Code

Customer Accessibility Mapping Detail
✖

Save

From Module ID \*  
CIF Number \*

**AGY Module Mapping**

1 of 1
Go
+ - ☰

AGY Module ID *	Agent Code	Branch Code	

Input byDateTimeMod NoRecord Status

Authorized byDateTimeAuthorization Status

Cancel

**AGY Module ID**

*Alphanumeric; 30 Characters; Mandatory*

The system displays the AGY Module ID.

**Agent Code**

*Display; Optional*

The system displays the default agent code for the selected Module ID.

**Branch Code**

*Display; Optional*

The system displays the default branch code for the selected Module ID.

---

**Note**

PII information of the associated Investor will be masked while displaying in LOV.

Field name	Data Masking Pattern
Beneficiary Name	Except First two characters remaining characters will be masked.
Date of birth	Date and month will be masked. Date will be masked as 01 and month will be 01.
Address Line1, Address Line 2, City, Email	Except First two characters remaining characters will be masked.
US indicia Available	Always will be defaulted to No.
Country of Domicile, Country of Birth, Country	Except First character remaining characters will be masked.

## 2.16 CIF Accessibility Mapping Summary Screen

This section contains the following topics:

- [Section 2.16.1, "Retrieving CIF Accessibility Mapping Record"](#)
- [Section 2.16.2, "Viewing CIF Accessibility Mapping Record"](#)
- [Section 2.16.3, "Delete CIF Accessibility Mapping Record"](#)
- [Section 2.16.4, "Authorizing CIF Accessibility Mapping Record"](#)

### 2.16.1 Retrieving CIF Accessibility Mapping Record

You can invoke the 'CIF Accessibility Mapping Summary' screen by typing 'UTSCIFAC' in the field at the top right corner of the Application tool bar and clicking on the adjoining arrow button.

The screenshot shows the 'Customer Accessibility Mapping Summary' application window. At the top, there is a search bar with 'Search', 'Advanced Search', 'Reset', and 'Clear All' options. Below the search bar, there is a section for search criteria: 'Search Is Case Sensitive' (checkbox), 'Authorization Status' (dropdown), 'Record Status' (dropdown), 'From Module ID' (text input with a search icon), and 'CIF Number' (text input with a search icon). A table below the search criteria shows the results, with columns for 'Authorization Status', 'Record Status', 'From Module ID', and 'CIF Number'. The table is currently empty. At the bottom right of the window, there is an 'Exit' button.

To retrieve a previously entered record:

- Invoke the CIF Accessibility Mapping Summary screen and specify the following:
  - The authorization status of the CIF Accessibility Mapping record in the Authorized field. If you choose the "Blank Space" option, then all the records are retrieved.
  - The status of the CIF Accessibility Mapping records in the Open field. If you choose the "Blank Space" option, then all the records are retrieved.
  - From Module ID
  - CIF Number
- After you have specified the required details, click 'Search'. All records with the specified details are retrieved and displayed in the lower portion of the screen.

You can also retrieve an CIF Accessibility Mapping detail from the Detail screen by doing query in the following manner:

- Press F7
- Input From Module ID and CIF Number
- Press F8

You can also search the record by using combination of % and alphanumeric value.

---

**Note**

- The 'New' operation is supported only for individual customer.
  - During CIF Accessibility maintenance to other 'AGY Modules', by default CIF accessibility mapping will be provided for the 'From AGY Module'.
- 

### **2.16.2 Viewing CIF Accessibility Mapping Record**

To view the CIF Accessibility Mapping details that you have previously entered:

- Invoke the CIF Accessibility Mapping Summary Screen from the Browser.
- Select the authorization status of the CIF Accessibility mapping records that you want to retrieve for viewing in the Authorized field. You can also view all the CIF Accessibility mapping records that are either unauthorized or authorized only, by choosing the Unauthorized / Authorized option.
- Specify any or all of the search parameters for retrieving the records.
- Click 'Search'. All records with the specified details are retrieved and displayed in the lower portion of the screen.
- Double click the record that you want to view. The CIF Accessibility Mapping screen Detail is displayed in view mode.

### **2.16.3 Delete CIF Accessibility Mapping Record**

You can delete only unauthorized records in the system. To delete CIF Accessibility Mapping record:

- Invoke the CIF Accessibility Mapping Summary screen from the Browser.
- Select the status of the record that you want to retrieve for deletion.
- Specify any or all of the search parameters in the corresponding fields on the screen.
- Click 'Search'. All records with the specified details are retrieved and displayed in the lower portion of the screen.
- Double click the record that you want to delete. The CIF Accessibility Mapping Detail screen is displayed.
- Select Delete operation from the Action list. The system prompts you to confirm the deletion, and the record is deleted physically from the system database.

### **2.16.4 Authorizing CIF Accessibility Mapping Record**

An unauthorized CIF Accessibility Mapping record must be authorized in the system for it to come into effect. To authorize CIF Accessibility Mapping record:

- Invoke the CIF Accessibility Mapping Summary screen from the Browser.
- Select the status of CIF Accessibility Mapping record that you want to retrieve for authorization. Typically, choose the unauthorized option from the drop-down list.
- Specify any or all of the search parameters in the corresponding fields on the screen.

- Click 'Search'. All records with the specified details that are pending authorization are retrieved and displayed in the lower portion of the screen.
- Double click the record that you wish to authorize. The CIF Accessibility Mapping screen is displayed. Select Authorize operation from Action.

## **2.17 CIF Conversion Maintenance Detail Screen**

This section contains the following topics:

- [Section 2.17.1, "Invoking CIF Conversion Maintenance Detail Screen"](#)
- [Section 2.17.2, "Pre Check Tab"](#)
- [Section 2.17.3, "Linked Entities Tab"](#)
- [Section 2.17.4, "Related Entities Tab"](#)
- [Section 2.17.5, "UH Details Tab"](#)

### **2.17.1 Invoking CIF Conversion Maintenance Detail Screen**

Conversion of 'From AGY Module ID' investors to 'To AGY Module ID' investors can be considered as a two-step process:

- The first step is CIF Conversion maintenance. CIF Details which need to undergo CIF Conversion process is captured in this step and this step will also identify and list out pending business for the CIF to user.
- The second step involves the actual conversion process.

For CIF Conversion maintenance, follow the steps given below:

- Click on Find CIF button.
- Input or Choose CIF Number.
- Choose 'To AGY Module ID' from LOV List.
- Click on 'Fetch Pre Check Details' button, the system will identify the pending business for the Customer /underlying UH in the 'From AGY Module ID' and will display the results to the user in all three tabs.

You can invoke the 'CIF Conversion Maintenance Detail' screen by typing 'UTDCIFCM' in the field at the top right corner of the Application tool bar and clicking on the adjoining arrow button.

The screenshot shows the 'CIF Conversion Maintenance Detail' application window. The window title is 'CIF Conversion Maintenance Detail'. The interface includes a 'Save' button at the top left. The main form area contains several input fields: 'Reference Number' with the value 'RF20150060048120', 'From AGY Module ID', 'CIF Number' (with a red asterisk), 'To AGY Module ID' (with a red asterisk), and 'CIF Name'. There are also buttons for 'Find CIF' and 'Fetch Pre Check Details'. A 'Status' dropdown menu is set to 'Not Started'. Below the form is a navigation bar with tabs: 'Pre Check' (highlighted in red), 'Linked Entities', 'Related Entities', and 'UH Details'. A table header is visible with columns: 'Serial Number', 'Description', 'Mandatory', 'Record Count', and 'Detail'. At the bottom, there is a footer area with fields for 'Input by', 'DateTime', 'Mod No', 'Record Status', 'Authorized by', 'DateTime', and 'Authorization Status', along with 'Ok' and 'Cancel' buttons.

Select 'New' from the Actions menu in the Application tool bar or click new icon to enter the details of the CIF Conversion Maintenance Screen.

### Reference Number

#### Display

It is the number auto generated during click of New button.

### CIF Number

*Alphanumeric; 9 Characters; Mandatory*

Specify the CIF number to be promoted.

### Find CIF Button

Click on 'Find CIF' button to find the CIF Number and CIF Name.

### CIF Name

#### Display

The system displays the name of the CIF.

### From AGY Module ID

#### Display

The system displays the created module ID of the CIF.

### To AGY Module ID

*Alphanumeric; 30 Characters; Mandatory*

Specify the target Module ID. Alternatively, you can select the Module ID from the option list. The list displays all valid Module IDs maintained in the system.

## **Status**

By default, the status displays as 'Not Started'. However, you can select the status from the drop-down list.

The list displays the following values:

- Not Started
- Readiness checks pending
- Ready for conversion
- Conversion successful
- Conversion Failure

## **Fetch Pre Check Details Button**

Click on 'Fetch Pre Check Details' button to identify the pending business for the CIF.

### **2.17.2 Pre Check Tab**

The system will list out the pending business available in the system for the CIF in this tab.

Click 'Pre Check' tab to view the following details.

#### **Serial Number**

*Display*

The system displays the Serial Number.

#### **Description**

*Display*

The system displays the description for the respective serial number.

#### **Mandatory**

*Display*

Pending checks have been classified as Mandatory/Optional. The user has to clear all the Mandatory checks to proceed with the 'Ready for conversion' Status.

#### **Record Count**

*Display*

This will list the number of records available for each Pre-check sequence.

#### **Detail**

click on the 'Details' button to get more information on the records.

## 2.17.3 Linked Entities Tab

Linked Entities refers to Entities available Locally in the particular branch alone. The system will identify and list out all the entities linked to the particular CIF in this tab.

The screenshot displays the 'CIF Conversion Maintenance Detail' window. At the top, there is a 'Save' button. Below it, the 'Reference Number' is set to 'RF20150060048125'. The 'From AGY Module ID' field is empty, and the 'To AGY Module ID' field is also empty. A 'Find CIF' button is located below the 'CIF Number' field. The 'Status' is set to 'Not Started'. A 'Fetch Pre Check Details' button is visible in the top right corner. Below the input fields, there are three tabs: 'Pre Check', 'Linked Entities' (which is selected and highlighted in red), 'Related Entities', and 'UH Details'. A pagination bar shows '1 of 1' records. Below the pagination bar is a table with the following columns: 'Serial Number', 'Description', 'Record Count', and 'Detail'. The table is currently empty. At the bottom of the window, there are fields for 'Input by', 'Authorized by', 'DateTime', 'Mod No', 'Record Status', and 'Authorization Status'. 'Ok' and 'Cancel' buttons are located in the bottom right corner.

The following details are displayed,

### **Serial Number**

*Display*

The system displays the Serial Number.

### **Description**

*Display*

The system displays the description for the selected category.

### **Record Count**

*Display*

This will list the number of records available for each Pre-check sequence.

### **Detail**

click on the 'Details' button to get more information on the records.



## 2.17.4 Related Entities Tab

Related Entities displays the details where the promoted CIF is a linked entity for other CIF/ UH. System will identify and list out all the related entities to the particular CIF in this tab.

CIF Conversion Maintenance Detail

Save

Reference Number RF20150060048125 From AGY Module ID Fetch Pre Check Details

CIF Number\* To AGY Module ID\* Find CIF

CIF Name Status Not Started

Pre Check Linked Entities **Related Entities** UH Details

1 of 1 Go

Serial Number	Description	Record Count	Detail
---------------	-------------	--------------	--------

Input by DateTime Mod No Record Status  
Authorized by DateTime Authorization Status Ok Cancel

The following details are displayed,

### **Serial Number**

*Display*

The system displays the Serial Number.

### **Description**

*Display*

The system displays the description for the selected category.

### **Record Count**

*Display*

This will list the number of records available for each Pre-check sequence.

### **Detail**

click on the 'Details' button to get more information on the records.

## 2.17.5 UH Details Tab

Click on 'Fetch UH' button to fetch the From Unitholder ID and From Unitholder Name for the CIF to be promoted.

The screenshot shows a web application window titled "CIF Conversion Maintenance Detail". At the top, there is a "Save" button. Below it, there are several input fields: "Reference Number", "From AGY Module ID", "CIF Number" (with a red asterisk), "To AGY Module ID" (with a red asterisk), and "Status" (a dropdown menu currently showing "Not Started"). There are also "Find CIF" and "Fetch Pre Check Details" buttons. Below the input fields, there are tabs for "Pre Check", "Linked Entities", "Related Entities", and "UH Details" (which is highlighted in red). A "Fetch UH" button is located below the tabs. At the bottom of the window, there is a navigation bar with "1 of 1" and a "Go" button. Below the navigation bar, there is a table with columns: "From Unitholder ID", "From Unitholder Name", "To Unitholder ID", "Find UH", and "To Unitholder Name". At the very bottom, there are fields for "Input by", "Authorized by", "DateTime", "Mod No", "Record Status", and "Authorization Status", along with "Ok" and "Cancel" buttons.

The following details are displayed,

#### **From Unitholder ID**

##### *Display*

The system displays the From Unitholder ID.

#### **From Unitholder Name**

##### *Display*

The system displays the From Unitholder Name.

#### **To Unitholder ID**

Specify the 'To Unitholder ID' from Find UH button or it can be given manually.

#### **To Unitholder Name**

##### *Display*

The system displays the To Unitholder Name.

---

#### **Note**

- New Unitholder cannot be created for the CIF in Normal AGY branch.
  - Underlying UH for the CIF in Normal AGY branch cannot be amended.
  - Transaction cannot be captured for Underlying UH in Normal AGY branch.
  - Existing Transactions belonging to UH cannot be reversed in Normal AGY branch.
  - To Unitholder ID Cannot be Duplicated.
  - From Unitholder ID and To Unitholder ID cannot be same.
-

### Pre-Checklist

SERIAL NUMBER	DESCRIPTION	Mandatory /Optional	Tab Name
1	Number of Unauthorized Transactions for the Unitholders	Mandatory	Pre Check
2	Number of Unallotted/Unsettled Transactions for the Unitholders	Mandatory	Pre Check
3	Number of Redemptions due for confirmation	Mandatory	Pre Check
4	Number of Ungenerated Pseudo Switch Transactions	Mandatory	Pre Check
5	Number of Ungenerated BnB Switch Transactions	Mandatory	Pre Check
6	Number of Ungenerated Twitch Transactions	Mandatory	Pre Check
7	Number of Block Transactions available for the unitholder	Mandatory	Pre Check
8	Number of Transactions which are yet to be completed	Mandatory	Pre Check
9	Number of Unprocessed dividend reinvestments	Mandatory	Pre Check
10	Number of Periodic Load commission record for which Transactions is yet to be generated	Mandatory	Pre Check
11	Number of Multiswitch Transactions for which residual is yet to be generated	Mandatory	Pre Check
12	Number of Unauthorized CIFMerge/HierarchyChange	Mandatory	Pre Check
13	Number of Unitholder's Fund not mapped to Destination Branch	Mandatory	Pre Check
14	Number of Unitholder's Fund in book closing period for Corporate Actions	Mandatory	Pre Check
15	Number of Active Standing Instruction for the unitholder	Mandatory	Pre Check
16	Number of Local Entities Linked to underlying Unitholder as Transaction Intermediary Agents	Mandatory	Pre Check
17	Number of Local Entities Linked to underlying Unitholder as Transaction Intermediary BranchCode	Mandatory	Pre Check

18	Number of Local Entities Linked to underlying Unitholder as Transaction Intermediary AccountOfficer	Mandatory	Pre Check
19	Number of Local Entities Linked to underlying Unitholder as Transaction Intermediary IFA	Mandatory	Pre Check
20	Number of Deals in which the Unitholder or CIF is Linked	Optional	Pre Check
21	Number of LOI setup in which the Unitholder or CIF is Linked	Optional	Pre Check
22	Number of IDS setup in which the Unitholder is Linked	Optional	Pre Check
23	Number of Limit orders for Unitholder which is setup but not executed	Optional	Pre Check
24	Number of Reinvestment setup in which the Unitholder is Linked	Optional	Pre Check
25	Number of Unitholder COE setup in which the Unitholder is Linked	Optional	Pre Check
26	Number of Unitholder NPI setup in which the Unitholder is Linked	Optional	Pre Check
27	Number of Unit Holder Non Tax Limits setup in which the Unitholder is Linked	Optional	Pre Check
28	Number of Unit Holder IRRF Preference setup in which the Unitholder is Linked	Optional	Pre Check
29	Number of Unit Holder Dividend Component Override setup in which the Unitholder is Linked	Optional	Pre Check
30	Number of Unprocessed dividends for the Unitholder's Fund for which freezeholding is done	Optional	Pre Check
31	Number of Standing Instruction paused for the unitholder	Optional	Pre Check
32	Number of Standing instruction with DRSP enabled for Unitholder	Optional	Pre Check
33	Number of Standing instruction with RIS enabled for Unitholder	Optional	Pre Check
34	Number of Standing Instruction which are going to be generated the next day	Optional	Pre Check
35	Number of Local Entities Linked to underlying Unitholder as Banks	Optional	Linked Entities

36	Number of Local Entities Linked to underlying Unitholder as Branches	Optional	Linked Entities
37	Number of Local Entities Linked to underlying Unitholder Intermediaries as Agents	Optional	Linked Entities
38	Number of Local Entities Linked to underlying Unitholder Intermediaries as Branches	Optional	Linked Entities
39	Number of Local Entities Linked to underlying Unitholder Intermediaries as Account Officer	Optional	Linked Entities
40	Number of Local Entities Linked to underlying Unitholder Intermediaries as IFA	Optional	Linked Entities
41	Number of Local Entities Linked to underlying Unitholder as Nominees	Optional	Linked Entities
42	Number of Local Entities Linked to underlying Unitholder as Joint Holders	Optional	Linked Entities
43	Number of Local Entities Linked to underlying Unitholder as Beneficiaries	Optional	Linked Entities
44	Number of Local Entities Linked to underlying Unitholder as Related parties	Optional	Linked Entities
45	Number of Local Entities Linked to underlying Unitholder as Directors	Optional	Linked Entities
46	Number of Local Entities Linked to underlying Unitholder as Legal Entities in KYC section	Optional	Linked Entities
47	Number of Local Entities Linked to underlying Unitholder as AMC	Optional	Linked Entities
48	Number of Local Entities Linked to Promoted CIF as Directors	Optional	Linked Entities
49	Number of Unitholders having Conversion CIF as Nominee	Optional	Related Entities
50	Number of Unitholders having Conversion CIF as Joint Holder	Optional	Related Entities
51	Number of Unitholders having Conversion CIF as Related Entity	Optional	Related Entities
52	Number of Unitholders having Conversion CIF as Beneficiary	Optional	Related Entities

53	Number of Unitholders having Conversion CIF as Directors	Optional	Related Entities
----	--	----------	------------------

User will find the following error messages on validations:

Sl. No.	Validation	Error Message
1	When user tries to provide same From AGY Module ID and To AGY Module ID	From AGY Module ID and To AGY Module ID cannot be same
2	When user tries to provide same 'From UnitHolder ID' and 'To UnitHolder ID'	From Unitholder ID and To Unitholder ID cannot be same
3	When user tries to provide same 'To UnitHolder ID' for multiple From Unitholders	To unitholder id should not be duplicated
4	When user tries to provide 'To UnitHolder' ID having Fund UnitBalance	To unitholder is having fund unitbalance, CIF conversion not allowed
5	When user tries to provide To UnitHolder's CIF is having other than mentioned UnitHolders	To unitholder's CIF linked with other unitholder(s), CIF conversion not allowed

## 2.18 CIF Conversion Maintenance Summary

This section contains the following topics:

- [Section 2.18.1, "Retrieving CIF Conversion Maintenance Record"](#)
- [Section 2.18.2, "Editing CIF Conversion Maintenance Record"](#)
- [Section 2.18.3, "Viewing CIF Conversion Maintenance Record"](#)
- [Section 2.18.4, "Delete CIF Conversion Maintenance Record"](#)
- [Section 2.18.5, "Authorizing CIF Conversion Maintenance Record"](#)
- [Section 2.18.6, "Amending CIF Conversion Maintenance Record"](#)
- [Section 2.18.7, "Authorizing an Amended CIF Conversion Maintenance Record"](#)

## 2.18.1 Retrieving CIF Conversion Maintenance Record

You can invoke the 'CIF Conversion Maintenance Summary' screen by typing 'UTSCIFCM' in the field at the top right corner of the Application tool bar and clicking on the adjoining arrow button.

CIF Conversion Maintenance Summary

Search Advanced Search Reset Clear All

Search Is Case Sensitive

Authorization Status  Record Status

Reference Number  CIF Number

From AGY Module ID  To AGY Module ID

Status

Records per page 15 1 of 1 Go Lock Columns 0

Authorization Status	Record Status	Reference Number	CIF Number	From AGY Module ID	To AGY Module ID	Status
----------------------	---------------	------------------	------------	--------------------	------------------	--------

Exit

To retrieve a previously entered record:

- Invoke the CIF Conversion Maintenance Summary screen and specify the following:
  - The authorization status of the CIF Conversion Maintenance record in the Authorized field. If you choose the "Blank Space" option, then all the records are retrieved.
  - The status of the CIF Conversion Maintenance records in the Open field. If you choose the "Blank Space" option, then all the records are retrieved.
  - CIF Number
  - Reference Number
  - From AGY Module ID
  - To AGY Module ID
  - Status
- After you have specified the required details, click 'Search'. All records with the specified details are retrieved and displayed in the lower portion of the screen.

You can also retrieve an CIF Conversion Maintenance detail from the Detail screen by doing query in the following manner:

- Press F7
- Input the Reference Number
- Press F8

You can perform Edit, Delete, Query, Amend, Authorize, Close and Re-open operations by selecting from the Action list.

You can also search the record by using combination of % and alphanumeric value.

## **2.18.2 Editing CIF Conversion Maintenance Record**

You can modify the details of a CIF Conversion Maintenance record that you have already entered into the system, provided it has not been subsequently authorized. You can perform this operation as follows:

- Invoke the CIF Conversion Maintenance Summary screen from the Browser.
- Select the authorization status of the records that you want to retrieve for modification in the Authorized field. You can only modify records that are unauthorized. Accordingly, choose the Unauthorized option from the drop-down list.
- Specify any or all of the search parameters for retrieving the records.
- Click 'Search'. All unauthorized CIF Conversion Maintenance records with the specified details are retrieved and displayed in the lower portion of the screen.
- Double click the record that you want to modify. The CIF Conversion Maintenance Detail screen is displayed.
- Select Unlock Operation from Action list to modify the record. Modify the necessary information.
- Click Save to save the changes. The CIF Conversion Maintenance Detail screen is closed and the changes made are reflected in the CIF Conversion Maintenance Summary screen.

## **2.18.3 Viewing CIF Conversion Maintenance Record**

To view the CIF Conversion Maintenance details that you have previously entered:

- Invoke the CIF Conversion Maintenance Summary Screen from the Browser.
- Select the authorization status of the CIF Conversion Maintenance records that you want to retrieve for viewing in the Authorized field. You can also view all the CIF Conversion Maintenance records that are either unauthorized or authorized only, by choosing the Unauthorized / Authorized option.
- Specify any or all of the search parameters for retrieving the records.
- Click 'Search'. All records with the specified details are retrieved and displayed in the lower portion of the screen.
- Double click the record that you want to view. The CIF Conversion Maintenance screen Detail is displayed in view mode.

## **2.18.4 Delete CIF Conversion Maintenance Record**

You can delete only unauthorized records in the system. To delete CIF Conversion Maintenance record:

- Invoke the CIF Conversion Maintenance Summary screen from the Browser.
- Select the status of the record that you want to retrieve for deletion.
- Specify any or all of the search parameters in the corresponding fields on the screen.
- Click 'Search'. All records with the specified details are retrieved and displayed in the lower portion of the screen.
- Double click the record that you want to delete. The CIF Conversion Maintenance Detail screen is displayed.



- Select Delete operation from the Action list. The system prompts you to confirm the deletion, and the record is deleted physically from the system database.

### **2.18.5 Authorizing CIF Conversion Maintenance Record**

An unauthorized CIF Conversion Maintenance record must be authorized in the system for it to come into effect. To authorize CIF Conversion Maintenance record:

- Invoke the CIF Conversion Maintenance Summary screen from the Browser.
- Select the status of CIF Conversion Maintenance record that you want to retrieve for authorization. Typically, choose the unauthorized option from the drop-down list.
- Specify any or all of the search parameters in the corresponding fields on the screen.
- Click 'Search'. All records with the specified details that are pending authorization are retrieved and displayed in the lower portion of the screen.
- Double click the record that you wish to authorize. The CIF Conversion Maintenance screen displayed. Select Authorize operation from Action.

### **2.18.6 Amending CIF Conversion Maintenance Record**

After CIF Conversion Maintenance record is authorized, it can be modified using the Unlock operation from Action list. To make changes to CIF Conversion Maintenance record after authorization, you must invoke the Unlock operation which is termed as Amend Operation.

- Invoke the CIF Conversion Maintenance Summary screen from the Browser.
- Select the status of the record that you wish to retrieve for amendment. You can only amend records that are authorized.
- Specify any or all of the search parameters in the corresponding fields on the screen.
- Click 'Search'. All records with the specified details are retrieved and displayed in the lower portion of the screen.
- Double click the record that you want to amend. The CIF Conversion Maintenance Detail screen is displayed in Amendment mode.
- Click the Unlock operation from the Action list to amend the record.
- Amend the necessary information. Click the Save button to save the changes

### **2.18.7 Authorizing an Amended CIF Conversion Maintenance Record**

An amended CIF Conversion Maintenance record must be authorized for the amendment to be made effective in the system. The process of authorization is the same as the process of normal authorization.

## **2.19 CIF Conversion Execution Screen**

This section contains the following topics:

- [Section 2.19.1, "Invoking CIF Conversion Execution Screen"](#)

### **2.19.1 Invoking CIF Conversion Execution Screen**

CIF Conversion involves moving the CIF from Source branch to Destination Branch and also transferring holdings of Underlying UH from Source AGY module ID to Destination AGY module ID. This screen is used to trigger CIF conversion process.

You can invoke the 'CIF Conversion Execution' screen by typing 'UTDCIFEX' in the field at the top right corner of the Application tool bar and clicking on the adjoining arrow button.

The screenshot shows the 'CIF Conversion Execution' application window. It includes a 'Save' bar, input fields for 'Reference Number', 'From AGY Module ID', 'CIF Number', and 'To AGY Module ID', a 'Process' dropdown menu set to 'Yes', and 'Populate' and 'Submit' buttons. Below the form is a table with columns: Reference Number, CIF Number, CIF Name, From AGY Module ID, To AGY Module ID, and Process. The table is currently empty. At the bottom right is a 'Cancel' button.

Select 'New' from the Actions menu in the Application tool bar or click new icon to enter the details of the CIF Conversion Execution screen.

Input either any of the values or all values.

Click on 'Populate' button to view the listed values.

### **Reference Number**

*Alphanumeric; 16 Characters; Optional*

Specify the Reference Number of the CIF Conversion maintenance for the customer.

### **From AGY Module ID**

*Optional*

Specify the current module ID of the CIF.

### **Process**

Select if records to be processed or not from the drop-down list. The list displays the following values:

- Yes
- No

### **CIF Number**

*Alphanumeric; 9 Characters; Optional*

Specify the CIF number of the unit holder.

## To AGY Module ID

### *Optional*

Specify the target Module ID. Alternatively, you can select the Module ID from the option list. The list displays all valid Module IDs maintained in the system.

You can input any of the above Filter criteria. Click on 'Populate' button.

CIF conversion records having status as 'Ready for Conversion' and 'Conversion Failure' will be eligible for listing in this screen. The following values are displayed:

- Reference Number
- CIF Number
- CIF Name
- From AGY Module ID
- To AGY Module ID
- Process

Before clicking submit Button, user needs to select the process as 'yes' for at least one record.

On click of 'Submit Button' in CIF Conversion Execution screen, Below is the process Flows:

- Calculate Transaction wise Unutilized balances to be carried forward to 'To AGY Module ID'.
  - At the high-level, transactions are grouped at LinkTransactionNumber and LinkTransactionDate to derive Unutilized balance. Additional Grouping criteria are derived based on one or more parameter like Aging Policy, RDR category, Unit classification and Hierarchy Intermediaries, etc.,
- Post Adjustment Subscription for newly created UH in 'To AGY Module ID' and allocation entries also.
- Post Adjustment redemption in 'From AGY Module ID' for Unutilized balances and allocation entries.
- Unprocessed Limit order transactions will be marked as cancelled in the source branch.
- Unprocessed dividend records in which freezeholding is completed at source branch, will be processed for the corresponding unitholders mapped at the destination branch module.
- For equalization enabled funds, source branch equalization details(G1 units and G2 units) will be carried forward to the respective transactions of destination branch.
- The ISA Limit utilization details for the source branch investor will be carried forward to the respective investor account created in the destination branch.
- Newly Created Unitholders in 'To AGY Module ID' will be linked to the promoted CIF.
- Close the 'From AGY Module ID' Unitholder linked to CIF with remarks "CIF Conversion".
- CIF will be Linked to 'To AGY Module ID'.
- Grant CIF Accessibility to 'From AGY Module ID' on promoted CIF(Reverse Mapping).
- On successful completion of CIF Conversion, the system will update status to 'Conversion Success'.
- In case of Failures during CIF Conversion, the system will update status to 'Conversion Failure'.

---

**Note**

- CIF Conversion Subscription transaction will have Transaction Type as 02 and Ref Type as 93.
  - CIF Conversion Redemption transaction will have Transaction Type as 03 and Ref Type as 93.
-

---

## 3. Managing Investor Accounts

This chapter contains the following sections:

- [Section 3.1, "Customer Information"](#)
- [Section 3.2, "Unit Holder Maintenance Details Screen"](#)
- [Section 3.3, "Unit Holder Maintenance Summary Screen"](#)
- [Section 3.4, "Unit Holder Find Options"](#)
- [Section 3.5, "UH Category Parameter Screen"](#)
- [Section 3.6, "UH Category Parameter Summary Screen"](#)
- [Section 3.7, "Account Type Maintenance Details Screen"](#)
- [Section 3.8, "Account Type Maintenance Summary Screen"](#)
- [Section 3.9, "Financial Intelligence Centre Act \(FICA\)"](#)
- [Section 3.10, "Escheatment Tracking"](#)
- [Section 3.11, "Export of Unit Holder Information"](#)
- [Section 3.12, "KYC Chasing Details"](#)
- [Section 3.13, "KYC Chasing Summary"](#)
- [Section 3.14, "Unit Holder Currency of Expression"](#)
- [Section 3.15, "Unit Holder Currency of Expression Summary"](#)

### 3.1 Customer Information

This section contains the following topics:

- [Section 3.1.1, "Maintaining Customer Information"](#)
- [Section 3.1.2, "Maintaining Investor Accounts"](#)
- [Section 3.1.3, "Identifying Unit Holder Account in System"](#)
- [Section 3.1.4, "Specifying Mandatory Information for New Account"](#)
- [Section 3.1.5, "Defaulting of Information for CIF Unit Holder Accounts"](#)
- [Section 3.1.6, "Specifying Additional Information for New Account"](#)
- [Section 3.1.7, "Choosing Template for Automatic Replication"](#)
- [Section 3.1.8, "Maintaining Stop Status on Unit Holder Account"](#)
- [Section 3.1.9, "Maintaining IRS Notifications on Unit Holder Account"](#)
- [Section 3.1.10, "Saving New Account"](#)

#### 3.1.1 Maintaining Customer Information

Each individual or company that transacts with your bank becomes your customer. In the Oracle FLEXCUBE Investor Servicing (FCIS) system, a customer information file (or CIF) is maintained for each customer.

A customer may desire to invest in the funds of the AMC, and have an investment account. In such a case, an investment account known as a unit holder account is maintained for such customers. A customer can have more than one investment account.

A customer account or a CIF account is created in the FC-IS system in either of the following ways:

1. At installations where the Oracle FLEXCUBE Corporate (FCC) and Oracle FLEXCUBE Retail (FCR) applications are also present, an interface is defined between either (or both) of these applications and FC-IS. The CIF account for the customer is created in either of these applications. Whenever a CIF account is authorized with investment details in either FCC or FCR systems, the interface propagates the details of the CIF account to the FC-IS system, where an initial, single unit holder account is created for the CIF account. The unit holder ID created in FC-IS will be identical to the account number in FCC. Subsequently, any number of unit holder accounts may be created in FC-IS for the CIF account. If a CPNJ number is linked to a CIF in FCC, then a unitholder of the type 'Corporate' will be created in FCIS for that customer. Similarly, if a CPF number is linked to a CIF in FCC, then a unitholder of the type 'Individual' will be created in FCIS for that customer. Any modification to the customer account details in FCC will be propagated to FCIS.
2. At installations where FCC and FCR are both not present, a CIF account for a customer can be created in FC-IS through the Customer Maintenance menu in the Browser. An initial, single unit holder account is created for the CIF account. Again, subsequently, any number of unit holder accounts may be created in FC-IS for the CIF account. Edition and Amendment (through Information Change) of the unit holder accounts can only be performed through the FC-IS system.

For a fuller discussion of how CIF accounts are created in FC-IS system, refer the chapter *"Maintaining Customer Information"*

After a CIF account is created along with a single, initial unit holder account, in either of the ways described above, you can create any number of unit holder accounts for the CIF account in the FC-IS system.

### **3.1.2 Maintaining Investor Accounts**

Any individual or company that invests capital in any investment avenue with a view to receive greater returns and appreciation of invested capital is known as an investor.

When an investor invests in a mutual fund or any of the funds floated by an AMC, the fund gives the investor a certain number of investment units that are indicative of the investor's stake in the fund money pool. The investor is known as a unit holder and is said to have holdings in the fund.

In Oracle FLEXCUBE Investor Servicing, all details regarding each unit holder that invests in the AMC are maintained in the system database, in the account created for the unit holder. This account is known as the unit holder account, and it is the single repository in the system database from where any information regarding the unit holder can be queried for, retrieved as well as updated.

Though a single account can be typically created for each unit holder, multiple accounts can also be maintained for Customer Information File (CIF) customers of your bank or AMC.

This chapter deals with all aspects of the creation and maintenance of unit holder and CIF unit holder accounts in the FC-IS system.

After you open a unit holder account for a new investor, you can perform any of the following maintenance operations:

- Authorize the account
- Make changes to the account in any way
- Close the account
- Query the database for any information regarding the account at any time
- Set up different investment preferences for the investor, as and when requested

Whenever an investor requests for a transaction, the system uses the unit holder account as the identification for the investor, while putting the transaction through. The effect of the transaction on the balance holdings of the investor in a fund is also reflected in the account.

### **3.1.3 Identifying Unit Holder Account in System**

The unit holder account that is maintained for an investor in the system database can be uniquely identified in the system by the following two identifiers:

#### **The Reference Number**

The reference number is a unique alphanumeric identifier for the account. It could be the serial number that is given on the application form through which the investor has invested in the AMC. It could also be any alphanumeric value given by the AMC or the investor, to identify the account.

The reference number can be used to query the database for information regarding the account.

#### **The Unit Holder ID (or Number)**

Like the reference number, the unit holder ID is also a unique alphanumeric identifier for the account. Either you can specify the unit holder ID or it can be generated by the system when you create the account and enter all the necessary details into the system. The unit holder ID has a generation logic that can be defined by the AMC for each of its branches. Thus, the unit holder ID is the most important identifier for the account in the system.

Like the reference number, the unit holder ID can also be used to query the database regarding the account.

Before you begin to set up any new unit holder accounts for investors that are desirous of investing in the funds of the AMC, you must ensure that the following static information sets have already been set up and entered into the system database and the required authorizations done:

- All necessary CIF accounts have been created in the system, either through the interface with FCC or FCR, or through the Customer Maintenance.
- All reference data that is typically defined in the Data Entry menu item in the Fund Manager component. This includes:
- All static information such as required entities (agents, branches, agency branches, brokers, AMCs, registrars, trustees), countries, corporation types, investor categories, occupation types, identification types, banks and their branches, mode of payment types, currencies, additional information heads, fee categories and subcategories.
- Authorized funds with all the necessary fund rules, agency branches, brokers, countries of domicile, account types, currencies and so on.

For a detailed account of this information, refer to the Fund Manager.

### **3.1.4 Specifying Mandatory Information for New Account**

In the UH New Account Detail screen, you must specify the following details about the investor as mandatory information when you are creating a new unit holder account:

- The CIF Number of the customer for whom the unit holder account is being created, in the CIF Number field. This is mandatory information for all unit holder accounts.

---

**Note**

If you wish to copy the unit holder details from that of an existing unit holder account, use the Copy UH link alongside the CIF Number field.

---

- For a non-CIF investor, the reference number for the unit holder account, in the Reference Number field.
- The ID of the AMC/ Distributor, the funds of which the investor has chosen to invest in, in the AMC ID field.
- The type of investor for whom the account is being created, (either Individual or Corporate) in the Investor Type field.
- The date on which the account is to be created, in the Account Opening Date field. By default, this is deemed by the system to be the application date, but you can specify an earlier date.
- The option of dealing with the AMC either through self or an authorized representative. If dealing through an authorized representative, specify the same in the Dealing Type field, and select an authorized representative, as mandatory information, in the Auth Rep ID field. If you are maintaining a depositary as a unit holder, you must select 'Depositary' as the dealing type.
- For individual investors, specify the following details as mandatory information:
  - The name of the investor. You must specify at least the first name of the investor in the First Name field.
  - The Fee Category in the Fee Category field.
  - The gender of the investor, in the Sex field.
  - The option chosen by the investor of operating the account either singly or as a joint account, in the Account Operation Type field. If the account is to be a joint account, you must specify the name of at least one of the joint unit holders, in the Joint CIF Details section. In this screen you can specify the Joint Holder's ID, Joint Type and Address details. Once authorized, this field cannot be modified.
- For corporate investors, specify the following details as mandatory information:
  - The name of the company, in the Company Name field.
  - The type of corporation, in the Corporation Type field.
  - The contact address of the investor, in the Address field under the Default Address header.
  - The type of identification, number of the identification document and its place of issue provided by the investor, in the fields Identification Type, Identification Number and Place of Issue respectively. Once authorized, these fields cannot be modified.
- Specifying the details of a bank account for an investor is not mandatory. If you wish to indicate them, any number of bank accounts can be designated, for each currency. You can also indicate a default bank account for each currency. During transaction entry, the payment bank account to be used for the unit holder will be picked up based on the transaction currency. The default bank account defined for the unit holder, for the transaction currency, is used.
- The code of at least one intermediary designated for the investor, in the Intermediary field in the Intermediary Details section. You must also specify the commission percentage that the intermediary is to receive, in the Split Percent field. The sum of all split percentages for the specified intermediaries must not exceed one hundred percent. The broker details and the split percentages are used as default information during the entry of transactions for the investor.



### **3.1.5 Defaulting of Information for CIF Unit Holder Accounts**

As mentioned earlier, when a CIF account is authorized in either FCC or FCR at an installation, a single, initial unit holder account is created in FC-IS for the CIF account. The following information is defaulted for the unit holder account in FC-IS:

- The account operation type is deemed to be single.
- The dealing type for the unit holder is deemed to be 'Self'.
- The account is deemed for an initial investor.
- For corporate investors, the minimum number of corporate signatories is deemed by default to be 1.
- The unit holder is not deemed to be a minor.
- The account is created as an open and enabled account and not as a closed one.
- The account is created without a specification for YTD account statements.
- The account is created as an unauthorized account in the FC-IS system.
- The ID assigned to the unit holder in the FC-IS system will be identical to the FCC account number.
- The FCC account details will be the default bank details of the of unit holder account in FC-IS.
- The identification number submitted by the unit holder.

These default specifications cannot be changed when the first, initial unit holder account is created for the CIF account in the FC-IS system. To change any of these details, an information change must be done. However, you cannot change the defaulted identification number.

Subsequently, after the creation of the first, initial unit holder, whenever you create another unit holder account for the CIF in FC-IS in the UH New Account screen, the specifications that were used as defaults for the creation of the first account, as shown above, are defaulted again. However, these can be changed at the time of creation of a new unit holder. Depending on the specifications at the FCC installation, you can add the FCC account details as unit holder account bank details in FC-IS or create another unit holder account for the CIF in FC-IS.

Whenever an FCC account undergoes number modification, FC-IS will perform an information change to the unit holder account record. On FCC account closure, the status of the unit holder account will be changed to 'Pending for Closure' and no outflows will be allowed from the account.

### **3.1.6 Specifying Additional Information for New Account**

After you have specified all the mandatory information, you are ready to save your specifications so that the account can be entered into the database.

You can, additionally, specify any of the following information as applicable before you actually save the record:

- Any personal details for an individual investor, such as the name of the father or spouse, the date of birth, the marital status, and any beneficiary designated for the investor. You can also specify whether the investor is a minor and also specify the designated guardian for the same.
- To make these specifications, click the Individual Details link in the screen, and enter the details in the corresponding fields.
- For a corporate investor, the name of a contact person as well as authorized signatories for the company.

- To make these specifications, click the Corporate Details link in the screen, and enter the details in the corresponding fields.
- Any contact details such as alternative addresses, city, state, zip code, as well as telephone or fax numbers, and E-mail IDs, if any.
- To make these specifications, click the Contact Details link in the screen, and enter the details in the corresponding fields.
- If you designate that tax is deemed to be deducted at source for the unit holder, the tax details applicable for the investor, such as the tax ID, tax circle and tax category. You can specify the PAN of the investor.
- To make these specifications, click the Identification Details link in the screen, and enter the details in the corresponding fields.
- Preferences opted for by the investor, concerning any or all of the following:
  - Currency, both for transactions and for account statements
  - Frequency of receiving account statements
  - The nationality, country of domicile, language and resident status
  - Preferred mode of mailing
  - Default mode of receiving redemption payments
  - Applicability of Rights of Accumulation benefits
  - Registration details
  - Applicability of making redemption and switch requests over telephone
  - Applicability of indexation for the computation of capital gains income
  - KYC Details
- To make these specifications, click the Client Preferences link in the screen, and enter the details in the corresponding fields.
- You can also indicate whether check writing facility is allowed for the investor, and specify the signatories for check writing. The investor can avail of check book facility in any fund in which the investor holds unit balances.
- Any additional information under the heads defined for the AMC. Click the Additional Information link in the screen, and enter the details in the corresponding fields.
- If the account is a retirement type of account, additional details for the individual investor, such as the retirement age, date of retirement and if the investor has expired; the date and cause of death.

To make these specifications, click the Member Details link in the screen, and enter the details in the corresponding fields.

### **3.1.7 Choosing Template for Automatic Replication**

Modifications made to a unit holder account under a CIF, through an Information Change operation, might require to be replicated to all unit holder accounts under the CIF. Oracle FLEXCUBE Investor Servicing provides the facility of configuring the system so that automatic replication could be achieved, through automatic replication templates.

When an information change to a unit holder account under a CIF is authorized, a template for automatic replication could be chosen. Any changes that have been made through Information Change, to any of the fields defined in the template, are replicated to all unit holder accounts belonging to the CIF, when the Information Change is authorized. The replication occurs at the level defined for the template – CIF level (changes made to CIF fields are replicated) or Identification Type level (changes made to Identification Type fields are replicated)

## Template ID

### *Optional*

Select the automatic replication template that is to be used for replication of changes made to the unit holder account through Information Change, to all unit holder accounts belonging to the CIF.

Any changes that have been made through Information Change, to any of the fields defined in the template, are replicated to all unit holder accounts belonging to the CIF, when the Information Change is authorized. The replication occurs at the level defined for the template – CIF level (changes made to CIF fields are replicated) or Identification Type level (changes made to Identification Type fields are replicated)

## 3.1.8 **Maintaining Stop Status on Unit Holder Account**

A stop could be placed on a unit holder account for a number of reasons. Such a stop typically results in restrictions being placed on the account, in terms of inflows and outflows, with regard to the following events:

- Any inflow and outflow transactions
- Standing instructions
- Tax deduction
- Dividend payment

A unit holder account can be rendered as restricted in an operation through a stop, due to any of the following:

- An IRS notification on the account. This could be due either to non-payment of tax, or incorrect reporting of the Tax ID.
- An Stop Code being assigned to the account, for escheatment tracking.

### **Specifying a Stop Instruction**

You can place a stop on an account in the system by performing an information change and specifying the following information in the Client Preferences field:

- The IRS Notification assigned to the account, if any, in the IRS Notification field
- The Stop Code assigned to the account, if any, in the Stop Code field.
- The date of release of the account from the stop status.

For details, refer the sections Maintaining IRS Notifications and Escheatment Tracking, found later in this chapter.

When you specify this information, the system marks the account with a 'stop' status. The Stop Account box in the Client Preferences section is checked, and the stop account code is assigned by the system, using the information provided.

### **The Stop Account Code**

When you specify a stop instruction through an information change, the system automatically assigns a 20-character code that indicates the stop instruction status of the account, known as the Stop Account Code. Any account that has a stop account code assigned to it due to a stop instruction, is restricted in operation.

To recall, an account can be rendered restricted in operation due to any of the following:

- An IRS notification on the account. This could also be for notifications such as Sections 54E (A) or 54E (B)
- An Stop Code being assigned to the account

Both IRS notifications as well as Stop Codes can be assigned to an account through an information change.

The stop account code consists of 20 characters or 'bits'. Each character denotes a restriction on any of the following operations:

- Bit 1 is for IPO Subscription Transactions. Bit 2 is for Redemption Transactions.
- Bit - 13 for Redemption Payment Restrictions
- Bit - 14 for Dividend Payment Restrictions
- Block and unblock transactions (Bit 3)
- Standing instructions (Bit 4)
- Tax deduction (Bit 5)
- Dividend payment (Bit 6)
- Subscription transactions (Bit 7)
- Switch Out transactions (Bit 8)
- Transfer Out transactions (Bit 9)
- Switch In transactions (Bit 10)
- Transfer transactions (Bit 11)
- Dividend payment (Bit 12)

Each character could have a value of 0,1 or 2. The values are interpreted as follows:

Stop account bit position	Interpretation		
	When bit value = 0	When bit value = 1	When bit value = 2
1	Allow all IPO Subscription Transactions	Stop all IPO Subscription Transactions	Warning
2	Allow all Redemption Transactions	Stop all Redemption Transactions	Warning
3	Unblock all transactions	Block all transactions	Warning
4	Pause all standing instructions		
5	Deduct all dividend tax		
6	Dividend reinvestment only		
7	Allow all subscription transactions	Stop all subscription transactions	Warning
8	Allow all Switch Out transactions	Stop all Switch Out Transactions	Warning
9	Allow all Transfer Out transactions	Stop all Transfer Out transactions	Warning
10	Allow all Switch In transactions	Stop all Switch In transactions	Warning
11	Allow all Transfer In transactions	Stop all Transfer In transactions	Warning

12	Dividend payout only. The 6 <sup>th</sup> bit will take precedence over the 12 <sup>th</sup> bit if the value of both is specified as 1.
----	--

The remaining 8 characters in the stop account code are not currently used, and are reserved for future usage.

### 3.1.9 **Maintaining IRS Notifications on Unit Holder Account**

An IRS notification is typically issued on a unit holder account in the event of non-payment of tax or due to incorrect reporting of the Tax ID.

You can capture the IRS notification by performing an information change on the unit holder account. In the Client Preferences section, select the notification that is applicable, in the IRS Notification field.

If the notification pertains to an incorrect reporting of Tax ID, select it from the drop down list. If the notification pertains to non-payment of tax, select the option 'Under Reporting'. When this notification is chosen, all outflows from the account are frozen, but inflows due to standing instructions are allowed. Also, dividend is compulsorily reinvested, and tax is compulsorily deducted, regardless of the TDS setup.

### 3.1.10 **Saving New Account**

After you have specified all the information that is mandatory for the account, (and any further information, if any, as applicable) click the Save link at the bottom of the Detail screen to save your specifications. The system validates all the information and saves the record into the database. The unit holder ID for the account is generated and displayed if you have not specified it. In case you have input the unit holder ID, the system validates it.

Along with the confirmation details, links to Subscription and IPO transaction screens are also displayed. If you invoke the transaction screens directly from here, the new Unit holder ID will be defaulted in the transaction screens. Transactions thus saved will be unauthorized and have to be manually authorized. However, if the user has Auto -Authorization roles enabled when a new Unit holder is created and when a transaction is done, both, Unit holder record and transaction will be authorized automatically.

The unit holder account has now been created successfully in the system database. You can now perform any of the following operations:

- Accept a transaction request for the investor immediately and enter it into the system, without authorizing the account.
- Edit any of the details that you have specified for the account, before it is authorized.
- You can have a different user authorize the account.

## 3.2 **Unit Holder Maintenance Details Screen**

This section contains the following topics:

- [Section 3.2.1, "Invoking Unit Holder Maintenance Details Screen"](#)
- [Section 3.2.2, "Account Details tab"](#)
- [Section 3.2.3, "Individual Dtls Tab"](#)
- [Section 3.2.4, "Corporate Dtls Tab"](#)
- [Section 3.2.5, "Contact Dtls Tab"](#)
- [Section 3.2.6, "Client Preferences Tab"](#)

- Section 3.2.7, "ID Details Tab"
- Section 3.2.8, "Bank Dtls Tab"
- Section 3.2.9, "Intermediary Dtls Tab"
- Section 3.2.10, "KYC Details Tab"
- Section 3.2.11, "Document Dtls Tab"
- Section 3.2.12, "Add Info Tab"
- Section 3.2.13, "UH Signature Tab"
- Section 3.2.14, "Related Parties Tab"
- Section 3.2.15, "FATCA Audit Log Tab"
- Section 3.2.16, "UH KIID Compliance Tab"
- Section 3.2.17, "Delivery Dtls Button"
- Section 3.2.18, "Beneficiary Dtls Button"
- Section 3.2.19, "Joint Holder Dtls Button"
- Section 3.2.20, "Nominee Dtls Button"
- Section 3.2.21, "Member Dtls Button"
- Section 3.2.22, "Alternate Language Dtls Button"
- Section 3.2.23, "Director Details Tab"
- Section 3.2.24, "Tax Compliance Button"
- Section 3.2.25, "Multiple Tax Details Button"
- Section 3.2.26, "Subscription button"

### 3.2.1 Invoking Unit Holder Maintenance Details Screen

To create a new unit holder account in the FC-IS system for an investor, use the 'Unit Holder Maintenance Detail' screen. You can invoke this screen by typing 'UTDUH/ UTDFH' in the field at the top right corner of the Application tool bar and clicking on the adjoining arrow button.

The screenshot displays the 'Unit Holder Maintenance Detail' application window. At the top, there is a 'Save' button. Below it, several input fields are arranged in a grid:

- Unit Holder ID (text field)
- Reference Number (text field)
- CIF Number (text field)
- First / Company Name \* (text field)
- AMC ID \* (text field)
- AMC Description (text field)
- Investor Type \* (dropdown menu, currently set to 'Individual')
- Find UH (button)
- Find CIF (button)
- Copy CIF (button)
- Copy UH without KYC (button)

A horizontal tab bar is located below the input fields, with 'Account Details' selected. Other tabs include Individual Dtls, Corporate Dtls, Contact Dtls, Client Preferences, ID Details, Bank Dtls, Intermediary Dtls, KYC Details, Document Dtls, Add Info, UH Signature, Related Parties, and FATCA Audit Log. Below the tabs, there are more input fields:

- Dealing Type \* S (text field)
- Dealing Type Desc Self (text field)
- A/C Opening Date \* 2015-01-05 (calendar icon)
- Segment ID (text field)
- Template ID (text field)
- Auth Rep ID (text field)
- Auth Rep ID Desc (text field)
- UH Category \* (text field)
- Category Description (text field)
- Protected Investor Level (dropdown menu, currently set to 'Unclassified')
- Fee Category (text field)
- Fee Category Desc (text field)
- Fee Sub Category (text field)
- Fee Sub Category Desc (text field)
- Remarks (text field)

At the bottom of the screen, there is a status bar with fields for Input by, Authorized by, DateTime, Mod No, Record Status, and Authorization Status. A 'Cancel' button is located in the bottom right corner.

In the Unit Holder Maintenance Detail screen, you create the account by:

- Specifying information that will form a profile of the investor. This includes, first, all the mandatory information that is required, and then, any further specifications you might want to make.

---

**Note**

You can also copy the details of an existing unit holder, and then modify the copied details as required, by using the Copy UH link.

---

- Saving your specifications.

Select 'New' from the Actions menu in the Application toolbar or click new icon to enter the details of the Unit Holder Maintenance screen. The Unit Holder Maintenance Detail screen has the following fields for data entry:

**Unit Holder ID***Display*

The system displays the unique number assigned to each unit holder account.

In case you have input the unit holder ID, the system checks if:

- The number of characters in the value input is less than 12
- The value specified is unique
- The last 2 characters (which are the check digits) of the value input are valid using the check digit algorithm for generating unit holder ID.

If you input the last two characters as '04', the system displays an error message and you are required to input a new value for the unit holder ID.

In the case of system-generated ID, the automatic generation of unit holder ID takes place after you have specified all mandatory details for a new account, and clicked the Save button at the bottom of the Client Information Section (or at the bottom of the Detail screen).

All your specifications are validated, and upon successful validation, the generated unit holder ID for the account is displayed.

The logic governing the generation of unit holder ID's would have been defined for the agency branch where you have created the account, in the agency branch maintenance record.

This field is not visible when you are creating a new account in the Detail screen. If you are viewing, editing, deleting or amending a previously created unit holder record, then the ID of the account is displayed here, and is non-editable.

If the unit holder account is being created for a CIF account in FCC, then the unit holder number will be identical to the FCC account number.

---

**Note**

You should define the following System Parameters to enable the generation and validation of unit holder ID:

- WEIGHTFACTOR
  - MODULAR
  - UHPREFIX
-

**Reference Number**

*Alphanumeric; 12 Characters; Optional*

Specify the reference number.

**CIF Number**

*Alphanumeric; 9 Characters; Optional*

Specify the CIF number of the customer for whom you are creating a unit holder account.

You can also query for CIF number by clicking 'Find UH' button.

When you specify the CIF Number, the name of the corresponding CIF customer is retrieved from the database and displayed alongside the field. Also, the default information from the initial unit holder account created for the CIF account is displayed in the fields of this screen. You can override any of these if necessary, and make necessary specifications.

**First / Company Name**

*Alphanumeric; 105 Characters; Mandatory*

Enter the First or Company name.

**AMC ID**

*Alphanumeric; 12 Characters; Mandatory*

Select the code of the AMC/ Distributor in whose funds the investor wishes to invest, from the list provided. You capture this information for the purpose of identifying the AMC/ Distributor to which the unit holder belongs, and in whose database the unit holder account will reside.

**AMC Description**

*Display*

The system displays the description for the selected AMC ID.

**Investor Type**

*Mandatory*

Select the type of investor from the drop-down list and the default value displayed is Individual. The list displays the following values:

- Individual
- Corporate

**Find UH**

Click 'Find UH' button to search for Unit Holder ID.

**Find CIF**

Click 'Find CIF' button to search for CIF number.

**The Copy CIF Button**

If you wish to copy the unit holder details from that of an existing unit holder account, click the Copy CIF button alongside the CIF Number field. The Unit Holder Find screen is opened, and you can select the unit holder whose details you wish to copy. When you have selected the required unit holder, the details of the selected account are written into the respective fields in the UH New Account Detail screen. You can make changes to the copied details, if required, and save your changes to create the unit holder account. This feature can only be invoked in the New Mode.

While creating a unit holder account using the Copy UH link, the system will not copy the KYC details. You need to provide new KYC details as per category selected.



### **Copy UH Without KYC button**

This button will be enabled upon query operation. If you click this the system will copy the previous unit holder along with KYC details. When the KYC details are copied from the parent UH the 'All requested KYC documentation has been received' field will be defaulted to "No".

If you want to copy the UH but not KYC details of the previous UH then click 'Copy UH without KYC'. The system will not copy the KYC from the parent UH.

## **3.2.2 Account Details tab**

### **Dealing Type**

*Alphanumeric, 1 Character; Mandatory*

Indicate whether the investor wishes to deal with the AMC either directly (as self) or through a designated authorized representative, by choosing the appropriate option from the option list.

If you choose the authorized representative option here, then you must specify the ID of the designated authorized representative in the Auth Rep ID field as mandatory information for the account.

If you are maintaining a depository as a unit holder in the system, you must select the dealing type as 'Depository'.

### **Dealing Type Desc**

*Display*

The system displays the description for the selected dealing type.

### **A/C Opening Date**

*Date Format, Mandatory*

Specify the date on which you are creating the account.

The application date is displayed here by default, and will be reckoned as the opening date for the account if you do not specify any other date in this field. You can specify an earlier date, if necessary.

### **Segment ID**

*Alphanumeric; 12 Characters; Optional; Non Amendable*

Specify the segment ID. Alternatively, you can select segment ID from the LOV. The list displays all the valid segment ID of current Installation maintained in the system.

The segment ID maintenance should be done as following,

- For Non-Global Transfer Agency Setup, Segment ID should not be maintained.
- For Global Transfer Agency Setup, Branch without cross branching and Segment ID will be defaulted as per Defaults maintenance and cannot be modified.
- For Global Transfer Agency Setup, Branch with cross branching and Segment ID should be selected by the User from LOV.

### **Template ID**

*Alphanumeric; 6 Characters; Optional*

Specify the template ID. Alternatively, you can select template ID from the option list. The list displays all valid template ID maintained in the system.

On modify operation, if the template ID is given a override message as 'Auto-information change will happen for underlined unitholders for CIF/ Identification based on the template ID' will be shown and on authorization informations will be replicated. On New operation, if the

template ID is given, the system display an error message as 'Template ID should be entered only during modification'.

*In this field, indicate the reasons for which the account is being created, if necessary.*

#### **Auth Rep ID**

*Alphanumeric; 12 characters; Mandatory only for unit holders dealing through authorized representative*

For investors dealing through authorized representative, select the ID of the preferred representative using the list button alongside.

#### **Auth Rep ID Desc**

*Display*

The system displays the description for the selected fee category.

#### **UH Category**

*Alphanumeric; 2 Characters; Mandatory*

Specify the unit holder category.

#### **Category Description**

*Display*

The system displays the description for the selected UH category.

#### **Protected Investor Level**

*Optional*

Select protected investor level from the drop-down list. The list displays the following values:

- Classified
- Unclassified

#### **Fee Category**

*Alphanumeric; 3 Characters; Optional*

From the list provided, select the fee category to be deemed applicable for the investor whose account you are creating.

#### **Fee Category Desc**

*Display*

The system displays the description for the selected fee category.

#### **Fee Sub Category**

*Alphanumeric, 6 Characters; Optional*

From the list provided, select the fee subcategory to be deemed applicable for the investor whose account you are creating.

#### **Fee Sub Category Desc**

*Display*

The system displays the description for the selected fee category.

#### **Remarks**

*Alphanumeric; 255 Characters; Optional*

Specify any narrative, or descriptive text, if any, concerning the account.

### 3.2.3 Individual Dtls Tab

In this section, specify the personal details for individual investors. You can access it by clicking 'Individual Dtls' tab.

The screenshot shows the 'Unit Holder Maintenance Detail' form with the 'Individual Dtls' tab selected. The form is divided into several sections:

- Top Section:** Includes fields for Unit Holder ID, Reference Number, and CIF Number. It also has fields for First / Company Name\*, AMC ID\*, AMC Description, and Investor Type\* (set to Individual). There are buttons for Find UH, Find CIF, Copy CIF, and Copy UH without KYC.
- Navigation Tabs:** Account Details, Individual Dtls (selected), Corporate Dtls, Contact Dtls, Client Preferences, ID Details, Bank Dtls, Intermediary Dtls, KYC Details, Document Dtls, Add Info, UH Signature, Related Parties, FATCA Audit Log, JH KIID Compliance.
- Personal Details Section:** Includes Last Name, Middle Name, Title (Mr.), Initials, Minor (No), Guardian Name, Relationship, and Description. Other fields include Sex (M), Guardian PAN/GIR No., Guardian MFIN, Health Status, Father / Spouse Name, Date Of Birth, Beneficiary, Marital Status (M), Marital Status Description (Married), Occupation, Occupation Description, A/C Operation Type (S), Account Operation Type (Single), and Guardian Form 60161 Available? (Yes).
- Footer Section:** Includes fields for Input by, Authorized by, DateTime, Mod No, Record Status, and Authorization Status. A Cancel button is present.

#### Note

After you have specified the details in this section for an individual investor, all your specifications will be lost if you change the investor type from "Individual" to 'Corporate'.

Click 'Individual Dtls' tab to enter the details.

#### Last Name

*Alphanumeric; 105 Characters; Optional*

Specify the last name.

#### Middle Name

*Alphanumeric; 105 Characters; Optional*

Specify the middle name of the individual investor.

#### Title

*Alphanumeric; 15 Characters; Optional*

Select the applicable title for the name of the individual investor from the list provided. If you do not find the option you are looking for in the list, maintain the same in the System Parameters Maintenance Screen.

For further information refer to the chapter "Maintaining System Parameters".

**Initials**

*Alphanumeric; 10 Characters; Optional*

The system uses the first character in the First Name and Middle Name of the Unit Holder and displays it as Initials. You can however, change the initials if required.

**Example**

Consider the investors with names 'Lee-Ann Burrows' and 'Shawn David James Burrows'.

The table below illustrates how the system arrives at the Initials for the above two names:

First Name	Middle Name	Last Name	Initials
Lee-Ann		Burrows	L
Shawn	David James	Burrows	SDJ

**Minor**

*Optional*

Select 'Yes' to indicate that the investor is a minor. If so, you must specify the following as mandatory information for such an investor:

- The date of birth for the same, in the Date of Birth field.
- The name of the designated guardian, in the Guardian field.
- The relationship of the designated guardian with the investor, in the Relationship field.

**Guardian Name**

*Alphanumeric; 105 Characters; Optional*

Specify the name of the designated guardian for the minor investor.

**Relationship**

*Alphanumeric; 70 Characters; Optional*

Specify the relationship between the designated guardian and the minor investor.

**Description**

*Display*

The system displays the description for the selected relationship status.

**Sex**

*Alphanumeric; 1 Character; Optional*

Indicate the gender of the individual investor by choosing either the Male or Female option, as applicable.

The default option displayed in this field is Male, and will be considered to be the gender of the investor if you do not select an option.

**Guardian PAN/GIR No.**

*Alphanumeric; 15 Characters; Optional*

Enter PAN/ GIR number.

**Guardian MFIN**

*Alphanumeric; 15 Characters; Optional*

In case the unit holder is a minor and the client country parameter is set to "SHOWPANINFO" for your bank, specify the MFIN details of the unit holder's guardian here.

**Health Status**

*Alphanumeric; 1 Character; Optional*

Specify the health status. Alternatively, you can select health status from the option list. The list displays all valid health status maintained in the system.

**Father/ Spouse Name**

*Alphanumeric; 105 Characters; Optional*

Specify the name of the father or spouse of the individual investor.

**Date of Birth**

*Date Format; Optional (Mandatory for minor investors)*

Specify the date of birth of the investor. Although you need not specify this as mandatory information for non-minor investors, it is recommended that you do so.

You must specify the date of birth as mandatory information for investors that are minors.

**Beneficiary**

*Alphanumeric; 105 Characters; Optional*

Specify the name of the preferred beneficiary of the individual investor.

**Marital Status**

*Alphanumeric; 1 Character; Optional*

Indicate the marital status of the individual investor by choosing either the Single or Married option, as applicable.

The default option displayed in this field is Single, and will be considered to be the marital status of the investor if you do not select an option.

**Marital Status Description**

*Display*

The system displays the description for the selected marital status.

**Occupation**

*Alphanumeric; 1 Character; Optional*

Indicate the occupation of the individual investor by selecting the applicable option from the list provided.

**Occupation Description**

*Display*

The system displays the occupation description for the selected occupation code.

**A/c Operation Type**

*Alphanumeric; 1 Character; Optional*

Indicate the manner in which the investor wishes to operate the account, from the options in the list provided.

The investor may choose to operate the account in any of the following ways:

- Single
- Joint
- Either or Survivor

If you choose the Joint option, then you must specify the name of at least one of the preferred joint unit holders in the Joint CIF Details section in this screen, you are also allowed to specify the details of the joint account holders in the Joint UnitHolder Details screen which can be

invoked by clicking the Joint UnitHolder Details hyperlink which appears once the Joint option is selected. You can modify the account operation type after authorization.

### Account Operation Type

#### Display

The system displays the type of account operation.

### Guardian Form 60/61 Available?

#### Optional

If you want Guardian Form 60/61 to be available, select 'Yes'. Else select 'No'.

## 3.2.4 Corporate Dtls Tab

In this section, specify the company details for corporate investors. You can access it by clicking 'Corporate Dtls' tab.

The screenshot shows the 'Unit Holder Maintenance Detail' form with the 'Corporate Dtls' tab selected. The form includes a 'Save' button at the top left. The main form area contains several input fields: 'Unit Holder ID', 'Reference Number', 'CIF Number', 'First / Company Name \*', 'AMC ID \*', 'AMC Description', and 'Investor Type \*' (set to 'Corporate'). There are also buttons for 'Find UH', 'Find CIF', 'Copy CIF', and 'Copy UH without KYC'. A navigation bar below the main form lists various tabs: 'Account Details', 'Individual Dtls', 'Corporate Dtls', 'Contact Dtls', 'Client Preferences', 'ID Details', 'Bank Dtls', 'Intermediary Dtls', 'KYC Details', 'Document Dtls', 'Add Info', 'UH Signature', 'Related Parties', and 'FATCA Audit Log'. Below the navigation bar, there are fields for 'Authorized Signatory 1', 'Authorized Signatory 2', and 'Authorized Signatory 3', along with 'Min No. of Signatories', 'Corporation Type', 'Country Of Incorporation', and 'Description'. At the bottom, there is a metadata section with fields for 'Input by', 'Authorized by', 'DateTime', 'Mod No', 'Record Status', and 'Authorization Status', and a 'Cancel' button.

### Authorized Signatory 1, 2 and 3

*Alphanumeric; 105 Characters; Optional*

Specify the names of any authorized signatories that must be deemed as valid for the company.

### Minimum No of Signatories

*Numeric; 22 Characters; Optional*

Specify the minimum number of signatories.

### Corporation Type

Alphanumeric; 3 Characters; Optional

Select the type of the corporation that the company is to be deemed, from the list provided.

### Description

Display

The system displays the description for the selected corporation type.

### Country of Incorporation

Alphanumeric; 3 Characters; Optional

Specify the incorporation country from the adjoining option list.

---

### Note

After you have specified the details in this section for a corporate investor, all your specifications will be lost if you change the investor type from 'Corporate' to 'Individual'.

---

### Description

Display

The system displays the description for the selected country code.

## 3.2.5 Contact Dtls Tab

In this section, specify the means of communication with the investor for whom you are creating the account. You can access this section by clicking 'Contact Dtls' tab.

You can specify at least two addresses, and designate one as the default mailing address to be used for correspondence with the investor, and the other as the alternate address. Specify the default address under the Default Address head, and the alternate address under the Alternate Address head. You can also maintain the SWIFT Address for the unit holder, in the SWIFT Address tab.

The screenshot shows the 'Unit Holder Maintenance Detail' form with the 'Contact Dtls' tab selected. The form includes fields for Unit Holder ID, Reference Number, CIF Number, First/Company Name, AMC ID, AMC Description, and Investor Type (set to Individual). It features two address sections: 'Correspondence Address' and 'Alternate Address', each with fields for address lines, city, state, country, telephone numbers, and fax numbers. A navigation bar at the bottom contains various tabs like 'Account Details', 'Individual Dtls', 'Corporate Dtls', 'Client Preferences', etc. A 'Save' button is at the top left, and a 'Cancel' button is at the bottom right.

## **Correspondence Address Section**

The following fields comprise the correspondence address information, in the Correspondence Address section:

### **Address Lines 1-2**

*Alphanumeric; 105 Characters; Mandatory*

Specify the default postal address that is to be used for correspondence with the investor.

### **City**

*Alphanumeric; 105 Characters; Optional*

Specify the name of the city of residence of the investor. You can select the city from the drop down list provided. The available options depend on the values defined at the params maintenance. If the city is not available in the list, you can specify the city in the field provided alongside.

The list of cities available in the system will be a one time upload into the system.

### **Use State Maintenance**

*Optional*

You can select one of the two values from the drop-down list:

- Yes
- No

If you select 'Yes', then only the system can accept US state code in 'State'.

If you select 'No', then system can accept any value for 'State'.

By default, the system displays 'No'.

### **State**

*Alphanumeric; 80 Characters; Optional*

Specify the state in which the city of residence of the investor is located. You can select the state of residence from the drop down list provided. The available options depend on the values defined at the params maintenance. If the state is not available in the list, you can specify the city in the field provided alongside.

### **Country**

*Alphanumeric; 3 Characters; Optional*

Select the country in which the investor is domiciled, from the drop-down list.

When you specify the address of the investor, the country (if any) indicated in the address is displayed here by default

### **Int. Dialing Code +**

*Alphanumeric; 10 Characters; Optional*

Specify the international dialling code.

### **Telephone 1**

*Alphanumeric; 60 Characters; Optional*

Enter the contact telephone numbers of the investor.



**Zip Code**

*Alphanumeric; 10 Characters; Optional*

Specify the zip code of the specified city of residence of the investor.

**E-Mail**

*Alphanumeric; 255 Characters; Optional*

Specify the Email address of the investor.

**Contact Person**

*Alphanumeric; 160 Characters; Optional*

For corporate investors, enter the name of the contact person at the unit holder office.

**Int. Dialing Code +**

*Alphanumeric; 10 Characters; Optional*

Specify the international dialling code.

**Telephone 2**

*Alphanumeric; 60 Characters; Optional*

Enter the contact telephone numbers of the investor.

**Int. Dialing Code +**

*Alphanumeric; 10 Characters; Optional*

Specify the international dialling code.

**Cell Phone Number**

*Numeric; 60 Characters; Optional*

Specify the cell phone number of the investor.

**Int. Dialing Code +**

*Alphanumeric; 10 Characters; Optional*

Specify the international dialling code.

**Fax Number**

*Numeric; 60 Characters; Optional*

Specify the fax number of the investor.

**Alternate Address Section**

The Alternate Address section captures the same details as the Correspondence Address tab (as detailed above). However, you can specify a date range within which the alternate address would be in effect:

**Address Line 1-2**

*Alphanumeric; 105 Characters; Mandatory*

Specify the default postal address that is to be used for correspondence with the investor.

**City**

*Alphanumeric; 105 Characters; Optional*

Specify the name of the city of residence of the investor. You can select the city from the drop down list provided. The available options depend on the values defined at the params maintenance. If the city is not available in the list, you can specify the city in the field provided alongside.

The list of cities available in the system will be a one time upload into the system.

**Use State Maintenance**

*Optional*

You can select one of the two values from the drop-down list:

- Yes
- No

If you select 'Yes', then only the system can accept US state code in 'State'.

If you select, 'No', then system can accept any value for 'State'.

By default, the system displays 'No'.

**State**

*Alphanumeric; 80 Characters; Optional*

Specify the state in which the city of residence of the investor is located. You can select the state of residence from the option list provided. The available options depend on the values defined at the params maintenance. If the state is not available in the list, you can specify the city in the field provided alongside.

**Country**

*Alphanumeric; 3 Characters; Optional*

Select the country in which the investor is domiciled, from the option list.

**Zip Code**

*Alphanumeric; 10 Characters; Optional*

Specify the zip code of the specified city of residence of the investor.

**Effective From Date**

*Date Format, Optional*

Specify the date that marks the beginning of the period for which the specified alternate address is in effect.

**Effective To Date**

*Date Format, Optional*

Specify the date that marks the end of the period for which the specified alternate address is in effect.

**E-Mail**

*Alphanumeric; 255 Characters; Optional*

Specify the E-mail address of the investor.

**Int. Dialing Code +**

*Alphanumeric; 10 Characters; Optional*

Specify the international dialling code.

**Telephone 1**

*Alphanumeric; 60 Characters; Optional*

Enter the contact telephone numbers of the investor.

**Int. Dialing Code +**

*Alphanumeric; 10 Characters; Optional*

Specify the international dialling code.

**Telephone 2**

*Alphanumeric; 60 Characters; Optional*

Enter the contact telephone numbers of the investor.

**Int. Dialing Code +**

*Alphanumeric; 10 Characters; Optional*

Specify the international dialling code.

**Fax Number**

*Alphanumeric; 60 Characters; Optional*

Enter the fax number of the investor.

**SWIFT Address Section**

The following fields comprise the SWIFT address information, in the SWIFT Address section:

**Address Lines 1-2**

*Alphanumeric; 105 Characters; Optional*

Enter the SWIFT address of the investor. You can enter up to 4 lines of address information.

**City**

*Alphanumeric; 105 Characters; Optional*

Specify the city of the SWIFT address for the investor.

**Country**

*Alphanumeric; 3 Characters; Optional*

Specify the country of the SWIFT address for the investor.

**Country Name**

*Display*

The system displays the name of the country for the selected country code.

**BICCODE**

*Alphanumeric; 16 Characters; Optional*

Specify the Bank Identifier Code (BIC) of the investor.

### 3.2.6 Client Preferences Tab

In this section, you specify any preferences indicated by the investor for the purpose of investment and transaction processing. You can access this section by clicking 'Client Preference' tab.

#### Mandatory Section

##### Preferred Currency

*Alphanumeric; 3 Characters; Optional*

From the list, select the currency in which the investor prefers to transact with the AMC.

The preferred currency is the currency in which the investor or unit holder prefers to make any payments involving transactions or receive any dividend income payments. The currency you select here will be deemed as the default currency for all payments from or to the investor. If the 'Payment Mode' chosen is 'Transfer', the system allows you to successfully save the unit holder details only if you maintain a bank account for the preferred currency or multi-currency.

You can also choose 'Fund Base Currency' (FBC) as your preferred currency (for unit holders only). In this case, you will be allowed to proceed with saving unit holder details without maintaining an account for 'FBC'.

You can save transactions for unit holders with 'FBC' as preferred currency, but these transactions will be marked incomplete. You can complete such transactions by specifying unit holder Bank details for the unit holder and for the transactions (in the 'Payments Details' section).

The system processes payments on the basis of the currency for each fund for the 'FBC' option. In case an account exists for the FBC, the system picks it up for payments or else it picks up the default multi-currency account for the unit holder. If neither is available, the system displays an error message.

The investor can, if need be, choose to transact in a currency different from the one you specify here, for any transaction.

---

**Note**

When you specify the country in which the investor is domiciled, in the Country of Domicile field, the currency associated with the specified country is retrieved from the Country Currency Maintenance record in the system and displayed in this field by default. If you do not select any currency here, then the displayed default currency will be deemed as the preferred currency for the investor.

---

**Base Currency Desc***Display*

The system displays the description for the selected base currency.

**A/C Statement Currency***Alphanumeric; 3 Characters; Optional*

Select the currency for account statements for the investor, from the drop-down list.

If you do not make any selection, this will be deemed as the account statement currency for the unit holder.

**Accnt Stmt Currency***Display*

The system displays the account statement currency for the selected account statement currency.

**A/C Statement Frequency***Alphanumeric; 1 Character; Mandatory*

From the list, select the frequency at which the investor wishes to receive periodic statement of accounts from the AMC – this could be monthly, daily, yearly, half-yearly, biweekly, quarterly or weekly.

**Account Statement Frequency***Display*

The system displays the account statement frequency.

**A/C Type***Alphanumeric; 2 Characters; Optional*

From the list, specify whether the account is to be a Voluntary account or a Retired account. Once authorized, this field cannot be modified.

**Account Type***Display*

The system displays the type of account for the selected account type.

**Preferred Mailing Mode***Alphanumeric; 2 Characters; Mandatory*

From the list, select the mailing mode in which the investor prefers to receive correspondence from the AMC.

If you wish to suppress the printing of contract notes in respect of the unit holder during execution of End of Day processes, you must select the 'File' option in this field.

### **Preferred Mailing Mode Description**

#### *Display*

The system displays the description for the selected preferred mailing mode.

### **NRI**

#### *Optional*

Select if the investor is NRI or not from the drop-down list. The list displays the following values:

- Yes
- No

### **Nationality**

#### *Alphanumeric; 15 Characters; Mandatory*

From the list, select the nationality of the investor for whom you are creating the account.

When you specify the country in which the investor is domiciled, in the Country of Domicile field, the nationality of the specified country is displayed in this field by default. If you do not make any selection in this field, then the displayed default nationality will be deemed as the nationality of the investor.

### **Nationality**

#### *Display*

The system displays the nationality description.

### **Country of Domicile**

#### *Alphanumeric; 3 Characters; Mandatory*

From the list provided, select the country where the investor is domiciled.

If you do not make a selection, then this default country of domicile is reckoned for the investor account in the database.

### **Country Of Domicile Description**

#### *Display*

The system displays the description for the selected country of domicile.

### **Preferred Language**

#### *Alphanumeric; 12 Characters; Mandatory*

From the list, select the language preferred by the investor for correspondence and communication.

### **Preferred Language Desc**

#### *Display*

The system displays the description for the selected preferred language.

### **Resident Status**

#### *Alphanumeric; 1 Character; Mandatory*

Indicate whether the investor resides in the selected country of domicile or not, by selecting either the Resident or the Non-Resident option.

### **Resident Status**

#### *Display*

The system displays the description for the selected resident status.

### **Redemption Payment**

*Alphanumeric; 1 Character; Optional*

Select the default mode of payment that is to be used for paying out the proceeds of any redemption transactions for the investor.

The two modes of payment supported in the system are Check and Transfer.

### **Redemption Pymt Default**

*Display*

The system displays the description for the selected redemption payment.

### **Dual Nationality**

*Alphanumeric; 3 Characters; Optional*

Select the dual nationality from the adjoining option list.

### **Dual Nationality Description**

*Display*

The system displays the description for the selected dual nationality.

### **Substantial Stay in US**

*Optional*

Indicate your substantial stay in US from the adjoining drop-down list. The options available are:

- Yes
- No

### **Investor Risk Level**

*Numeric; 3 Characters; Optional*

Select the investor risk level from the option list. Alternatively, you can select Investor Risk Level from the option list. The system displays all valid investor risk status maintained in the system.

If investor with any risk level (including null) tries to invest in a fund with Restricted fund as 'Yes', then the system will display warning message as 'Fund is restricted for investment from selected transaction type/ref type combination'. The error message will be displayed based on 'Restriction applicable' field, based on ref types mapped into 'Fund Restriction' screen.

---

#### **Note**

You can configure Fund risk level and investor risk level at param maintenance for FUNDRISKPROFILE and INVRISKPROFILE param codes respectively. The system will validate the fund risk for an investor in 'Investor Fund Risk Rating Mapping' screen.

---

This validation is also applied to electronic deals (bulk upload/SWIFT/gateway), light weight screens and bulk transaction screens. For light weight screen and bulk upload, the warning/error messages will be logged and cannot be viewed on the screen.

The warning messages will be generated during the 'Save', 'Edit' and 'Modify' operations for the transactions captured manually.

If the SI ref type is mapped, the system will generate warning message on the RSP transaction while saving.

During authorization, the warning messages will appear for confirmation and the checker will have to accept the warnings to complete the transaction authorization.

---

**Note**

The above validations are also applicable for transactions that are uploaded through FCIS Bulk Upload, SWIFT and gateway services.(Create/ Modify for IPO Subscription/ Subscription/ Switch/ Transfer).

---

**Investor Risk Level Description***Display*

The system displays the description for the selected investor risk level.

**Risk Expiry Date***Date Format; Optional*

Select the expiry for the risk rating captured for the UH from the adjoining calendar.

When investor or guardian of minor account reaches 70 years old, the system will automatically update investor risk level to '10' ['conservative/ low'] and expiry date field will not be updated.

This check and risk profile updating will be handled by a BOD batch job. This job will be sequenced before SI generation job. Age at which the risk profile defaults to 10 is configurable in 'Parameter Maintenance Screen' with Param Code as 'RISKPROFILEEXPIRYAGE'. This job for resetting risk profile can be scheduled as part of mini EOD for the required AMC's also.

When expiry date is crossed, the system will consider the investor risk level as '10' [Low] irrespective of the investor risk level maintained. The system will not update the investor risk level field to '10' [Low] in this case.

**Latest Assessment Date***Date Format; Optional*

Select the date on which investor risk profile was last assessed from the adjoining calendar.



## Optional

The screenshot displays the 'Unit Holder Maintenance Detail' form. At the top, there is a 'Save' button and a navigation bar with tabs: Account Details, Individual Dtls, Corporate Dtls, Contact Dtls, Client Preferences (highlighted), ID Details, Bank Dtls, Intermediary Dtls, KYC Details, Document Dtls, Add Info, UH Signature, Related Parties, FATCA Audit Log, and UH KIID Compliance. Below the navigation bar, there are input fields for Unit Holder ID, Reference Number, and CIF Number. To the right, there are fields for First / Company Name, AMC ID, AMC Description, and Investor Type (set to Individual). There are also buttons for 'Find UH', 'Find CIF', 'Copy CIF', and 'Copy UH without KYC'. The 'Optional' section is expanded, showing fields for Check Writing Facility (No), Telephone Redemption (No), Telephone Switch (No), Registration Type, Registration Type Desc, Place Of Birth, Dispatch Date, Trail Commission Preference (Select One), Preferred Fund ID for Redemption, Transaction Delivery Preferences, Cert Delivery Preference, Registration Name, Pay by FEDWIRE / ACH (No), Apply Indexation on CST?, Country Of Birth, Country Of Birth Description, Returned Date, All Signatories Sign Required (No), ROA Investor (No), Country Type, Country Type Description, and Campaign Code. Below the Optional section is the 'Stop Account' section with a navigation bar: Delivery Dtls, Beneficiary Details, Joint Holder Dtls, Nominee Dtls, Member Dtls, Alternate Language Dtls, Director Details, Tax Compliance, Multiple Tax Details, and Subscription. At the bottom, there is a footer with fields for Input by, Date/Time, Mod No, Record Status, Authorized by, Date/Time, Authorization Status, and a 'Cancel' button.

### Check Writing Facility

#### Optional

You can use this field to indicate that the investor is allowed to avail check writing facility on any funds of the AMC in which the investor holds unit balances.

Typically, in money market funds, investors could be issued deposit slips for subsequent purchases. They could also write checks to any external entity/ individual, which are reckoned as redemption from the investor account, when produced by the external entity individual, to the AMC.

### Telephone Redemption

#### Optional

Select 'Yes' to indicate that telephonic requests from the investor for redemption transactions must be accepted.

### Telephone Switch

#### Optional

Select 'Yes' to indicate that telephonic requests from the investor for switch transactions must be accepted.

---

### Note

If you select both Telephone Redemption and Telephone Switch fields as 'Yes', then the system will accept redemption and switch transaction requests with 'telephone' as the means of purchase.

---

### **Registration Type**

*Alphanumeric; 2 Characters; Optional*

For investors requesting NSCC or Wire Order transactions, indicate whether the registration of certificates issued, if any, must be in the investor's name (Individual Name) or registration name specified for the broker dealer (Street Name).

### **Registration Type Desc**

*Display*

The system displays the description for the selected registration type.

### **Place of Birth**

*Alphanumeric; 80 Characters; Optional*

Enter the place of birth of the investor. This is mandatory if you have not specified the Tax ID.

### **Dispatch Date**

*Date Format; Optional*

Enter the dispatch date.

### **Trail Commission Preference**

*Optional*

Select the trail commission preference from the drop-down list. The list displays the following values:

- Payout
- Reinvestment

### **Preferred Fund ID**

*Alphanumeric; 6 Characters; Optional*

The fund you select in this field will be the one from which management fee will be recovered and into which any incentives will be credited.

When an incentive is being credited, the system will first consider the fund you have selected here, in the field 'Preferred Fund'. If you have selected a fund here, the incentive will be credited into this fund. If you have not selected a fund, the incentive will be credited into the fund for which a fund-load mapping has been done.

Consider the following cases during the redemption of a fee:

#### **Case 1 – Periodic Fee maintained at the product level**

If the periodic load is maintained at the product level, redemption will happen from the fund indicated here, only if the fund has sufficient balance. If the fund does not have sufficient balance, the system will consider the funds that you have selected through the Management Fee Applicability screen. For further information on the Management Fee Applicability screen, refer to the chapter **Management Fee** in the **LEP User Manual**.

#### **Case 2 – Period Fee maintained at the fund level**

If the periodic load is maintained at the fund level, the redemption will happen in the following manner:

The system will first consider the fund you have selected here, in the field 'Preferred Fund'. If there is sufficient balance, the redemption will happen from this fund. If the balance is not sufficient, or you have not selected a fund (this field being optional), the system will consider the fund for which a fund-load mapping has been done. If there is sufficient balance in this fund, the redemption will be carried out from this fund. If, in this fund, the balance is not sufficient, the system will carry out the redemption from any other fund that the Unit Holder has invested into, in the appropriate ratio.

The funds, from which the fee amount is redeemed, may not be in the same currency. If the funds have different base currencies, the mid rate will be used as the exchange rate to arrive at the amount to be redeemed, in the fee currency.

---

**Note**

If the fee needs to be accrued in a certain currency, the transaction will need to be generated in the same currency. Hence, if the base currency of a certain fund is not that particular currency and it does not allow any transaction in that currency, the fund will not be considered for redemption of the fee amount. This can be illustrated with the following example:

---

**Example**

The base currency of the fund where the fee is accrued is RAND. After apportioning, the system will generate a redemption transaction in three funds with base currency and the restrictions as follows:

F1: Base Currency – RAND; Allowed Currencies: RAND, USD and GBP

F2: Base Currency – USD; Allowed Currencies: USD, INR and GBP

F3: Base Currency – GBP; Allowed Currencies: USD and GBP

In this case since the fee is accrued in RAND, the redemption transactions need to be generated in RAND. In the above case, F2 does not allow a RAND transaction. The system in such a case will raise an error.

**Transaction Delivery Preferences**

*Alphanumeric; 1 Character; Optional*

Select the transaction delivery preferences from the option list.

**Cert Delivery Preference**

*Display*

The system displays the certificate delivery details for the selected transaction delivery preferences.

**Registration Name**

*Alphanumeric; 50 Characters; Optional*

For street name registrations, specify the registration name to be displayed on the certificates. Typically, this is the dealer name of the corresponding broker dealer.

**Pay by FEDWIRE / ACH**

*Optional*

Select 'Yes' to indicate that payment by FEDWIRE or ACH is to be accepted for the investor.

**Apply Indexation on CGT?**

*Optional*

You can use this field to indicate whether indexation is to be applied on capital gains tax computation, for the investor. Select this option to indicate application of indexation. Leave it unchecked to indicate that indexation is not applicable.

To indicate application of indexation, you must also specify it as applicable for the capital gains load, when you associate the load with a fund in the Fund Load Setup. Indexation is applied only if it is specified *both* in this Unit Holder New Account screen (for the investor's profile) as well as in the Fund Load Setup, for the fund.

**Country of Birth**

*Alphanumeric; 3 Characters; Optional*

From the list, select the country of birth of the investor. This is mandatory if you have not specified the Tax ID.

**Country of Birth Description**

*Display*

The system displays the description for the selected country code.

**Returned Date**

*Date Format; Optional*

Enter the returned date.

**All Signatories Sign Required**

*Mandatory if check writing is allowed*

For joint accounts in which the unit holder is availing the check-writing facility, use this field to indicate whether the signatures of all joint unit holders must be required on issued checks.

**ROA Investor**

*Optional*

Select 'Yes' to indicate that the investor prefers to avail of the Rights of Accumulation facility.

**Country Type**

*Alphanumeric; 1 Character; Optional*

Specify the country type. The adjoining option list displays all valid county codes maintained in the system. You can choose the appropriate one.

**Country Type Description**

*Display*

The system displays the description for the selected country type code.

**Campaign Code**

*Alphanumeric; 6 Characters; Optional*

You can link the campaign to the unit holder. Specify the campaign to be mapped. You can also select the campaign code from the option list. The campaign codes with the start and the end date in between the unit holder account opening date is displayed in the option list. You can modify the campaign even after the authorisation.

**Stop Account****IRS Notification on A/C**

*Alphanumeric; 10 Characters; Mandatory*

Specify IRS notification details on account. The adjoining option list displays all valid IRS Notification ID maintained in the system. You can choose the appropriate one.

**IRS Notification**

*Display*

The system displays the description for the selected IRS Notification ID.

**Stop Code**

*Alphanumeric; 25 Characters; Optional*

Specify the stop code. The adjoining option list displays all valid stop code maintained in the system. You can choose the appropriate one.

If multiple Stop codes are mapped to the Unit Holder, the highest Stop Account Restriction will be considered for the Unit Holder Status and the system will display the warning message as 'Unit Holder is mapped with the Stop Account code' at transaction level.

### **Stop Code Description**

*Display*

The system displays the description for the selected stop code.

### **Stop Account Reason**

*Alphanumeric; 255 Characters; Optional*

Specify the reason for stopping an account.

### **Stop Account Effective Date**

*Date Format; Optional*

Specify the effective date to stop an account.

The Stop Code effective date can be a future date. However, the system will validate only those Stop codes which have the effective date less than or equal to the application date and lesser than release date for current transactions. The system will not validate the Stop codes which have an effective date greater than the application date.

For backdated transactions,

- In case of single Stop Code for the UH, the system will pick up the Stop account restriction applicable for that period of time. However, in case of multiple Stop codes, based on the transaction type (whether IPO, Subscription, Redemption etc), the system will check each bit for the respective Stop codes available for that time and will take the highest preference stop account restriction.
- For both single and multiple Stop codes, the system will pick up the stop account restriction if the transaction date is greater than or equal to the Stop Account effective date but less than the Stop Account release date.

The system will not allow you to add any Stop Code effective date for the backdated and display an error message as 'Stop Code effective date cannot be a backdated'.

### **Stop Account Release Date**

*Date Format; Optional*

Specify the stop account release date.

---

#### **Note**

Stop code will remain available in the system and will not be made to null

---

### **Stop Account**

*Optional*

Select stop account status from the adjoining drop-down list. Following are the options available:

- Yes
- No

### **Stop Account Restrictions**

*Display*

The stop account restrictions box gets populated with according to the stop code mapped to UH.

## **Client Communication Restrictions**

### **Contract Notes**

#### *Optional*

Select if contract notes are applicable or not from the adjoining drop-down list. Following are the options available:

- Applicable
- Not Applicable

### **Account Statement**

#### *Optional*

Select if account statement is applicable or not from the adjoining drop-down list. Following are the options available:

- Applicable
- Not Applicable

## **Communication Mode Restrictions**

### **Communication Mode**

#### *Alphanumeric; 2 Characters; Optional*

Specify the communication mode. The adjoining option list displays all valid communication mode maintained in the system. You can choose the appropriate one.

For Communication Mode, the system will restrict the Param value to the length of 2 characters.

The system will validate the applicable communication mode in UH screen against the communication mode in the transaction screen.

### **Communication Mode Description**

#### *Display*

The system displays the description for the selected communication mode.

### **Restriction**

#### *Optional*

Select if restriction is applicable or not from the adjoining drop-down list. Following are the options available:

- Applicable
- Not Applicable

Once the communication mode is restricted, the system will not allow you to enter the trades using the specific communication mode including Uploads and will display an error message as 'The communication mode is restricted for the UH'.

If you try to map the restricted communication mode again to the UH then the system will display an error message as 'Communication mode is already restricted for the UH'.

If you try to capture the transaction for the UH where the defined communication mode is restricted, then the system will display an error message as 'Communication mode is restricted for the UH'.

## Beneficiary Payout

You can direct redemption and dividend proceeds to beneficiaries by specifying the following preferences:

### Redemption Payout

#### Optional

Check this option to indicate that the proceeds of a redemption transaction should be transferred to the beneficiaries mentioned. If you select this option, you need to maintain a minimum of one beneficiary along with the percentage to be awarded for the beneficiary in the 'Beneficiary Dtls' screen. It is also essential that the beneficiary be an existing Unit Holder and not a third party beneficiary.

### Dividend Payout

#### Optional

Check this option to indicate that dividends should be transferred to the beneficiaries specified. If you select this option, you need to maintain a minimum of one beneficiary along with the percentage to be awarded for the beneficiary in the 'Beneficiary Dtls' screen. It is also essential that the beneficiary be an existing Unit Holder and not a third party beneficiary.

When you have multiple beneficiaries for a payout (dividend or redemption), you can amend the percentage to be given to each, as and when required. If the total percentage awarded to the beneficiaries does not add up to 100%, the remaining payout will be done to the primary unit holder. The amount paid out to the beneficiary will be net of withholding tax, which will be derived on the basis of the tax for the Unitholder – Beneficiary Country combination.

## 3.2.7 ID Details Tab

In this section, you specify details of any identification provided by the investor. You also indicate the applicability of tax being deducted at source for the investor and the required tax details.

Click 'ID Details' tab to enter the details.

The screenshot shows the 'Unit Holder Maintenance Detail' form with the 'ID Details' tab selected. The form is divided into several sections:

- Unit Holder Information:** Unit Holder ID, Reference Number, CIF Number, First / Company Name, AMC ID, AMC Description, Investor Type (set to Individual).
- Identification Details:** Identification Type, Description, Identification Number, Date of Issue, Date of Expiry, EUSD Options, Place of Issue, Place Of Issue Description, UH BIC Code, Recover CGT?, FATCA Classification, Description.
- Tax Details:** Tax ID, Tax Deducted at Source (Yes/No), Tax Certificate Effective Date, Tax Certificate Expiry Date, Form 60/61 Available?, Tax Exempted, Tax Circle, MFIN, US India Available, FATCA Status, FATCA De Minimis Check.
- Secondary Identification:** Secondary Identification Type, Secondary Identification Description, Secondary Identification Number, Date Of Issue, Date Of Expiry, Place Of Issue, Place Of Issue Description, MIFID Applicability, MIFID Classification, MIFID Classification Description.

At the bottom of the form, there are fields for 'Input by', 'Authorized by', 'DateTime', 'Mod No', 'Record Status', and 'Authorization Status', along with a 'Cancel' button.

**Identification Type**

*Alphanumeric; 20 Characters; Mandatory*

From the list, select the type of identification that is being provided by the investor. The identification type is the mode in which the unit holder will furnish an identification document or proof, and could be a Personnel ID, License, Birth Certificate, etc. This is used for identifying the unit holder during all subsequent transactions.

You can capture 'NRIC Number' as the identification type for a unit holder account. If you have selected NRIC Number as the Identification Type for the account, you can specify the applicable NRIC Number as the Identification Number. Once authorized, this field cannot be modified.

**Description**

*Display*

The system displays the description for the selected identification type.

**Identification Number**

*Alphanumeric; 50 Character; Mandatory*

Specify the number or ID of the identification document or proof that is furnished by the unit holder. Once authorized, this field cannot be modified.

**Date of Issue**

*Date Format, Optional*

Specify the date of issue of the identification document or proof that is furnished by the unit holder.

The date of issue that you specify here must not be later than the date of opening the account.

**Date of Expiry**

*Date Format; Optional*

Specify the date of expiry of the identification document or proof. It must be later than the date of issue and the application date.

**EUSD Option**

*Optional*

Select the EUSD (European Union Savings Directive) option from the drop-down list. The list displays the following values:

- With Holding Tax
- Exchange of Information
- Tax Exemption Certificate

---

**Note**

If EUSD option is not applicable at the segment level, then you will not be allowed to specify any option here.

---

**Place of Issue**

*Alphanumeric; 3 Characters; Mandatory*

From the option list, select the place of issue of the identification type. Once authorized, this field cannot be modified.



**Place of Issue**

*Display*

The system displays the description for the selected place of issue.

**UH BIC Code**

*Display*

The system displays the Bank Identification Code (BIC) of the unit holder, in case of financial institutional unit holders.

**Recover CGT?**

*Optional*

Select 'Yes' option, if the tax on capital gain has to be deducted from the transaction (Redemption, Transfer and Switch).

**FATCA Classification**

*Display*

If the ID selected is an existing entity in the system then system displays FATCA Classification type.

**Description**

*Display*

The system displays the description of FATCA classification.

**Tax ID**

*Alphanumeric; 50 Characters; Optional (Mandatory if tax is specified to be deducted at source)*

Specify the tax identification number or tax ID for the investor.

You can use this field to capture the PAN Number of the unit holder. For any transactions entered into by the unit holder in any fund, which involve volumes that exceed the Minimum Amount for Tax ID specified in the fund rules, the system validates the availability of the PAN Number.

**Tax Deducted at Source**

*Mandatory*

Select 'Yes' to indicate that tax must be deducted at source for the investor.

If you select 'Yes' at source, then you must specify the following mandatory information:

- The tax ID of the investor, in the Tax ID field.
- The tax circle that corresponds to the investor, in the Tax Circle field.
- The tax category that corresponds to the investor, in the Category field.

**Tax Certificate Effective Date**

*Date Format; Optional*

Specify the date from when the tax certificate is effective.

**Tax Certificate Expiry Date**

*Date Format; Optional*

Specify the date on which the tax certificate expires. It is mandatory for you to specify the expiry date if you chosen 'Tax Exemption Certificate' as the EUSD option.

### **Form 60/ 61 Available?**

*Optional*

If form 60/ 61 is available, select 'Yes'. Else select 'No'.

### **Tax Exempted**

*Optional*

You can use this field to indicate that the investor is the recipient of a special exemption from tax. Check this box to indicate such an exemption. If you have maintained any tax details for such an investor, they will be disabled, and not used.

### **Tax Circle**

*Alphanumeric; 15 Characters; Optional (Mandatory if tax is specified to be deducted at source).*

Specify the tax circle to which the unit holder belongs.

### **MFIN**

*Alphanumeric; 15 Characters; Optional*

Specify the MFIN details of the unit holder, provided the client country parameter is set to "SHOWPANINFO" for your bank. You will however not be allowed to enter the MFIN details if the unit holder is a minor.

### **US Indicia Available**

*Display*

The system defaults US Indicia Available as Yes or No depending on the following:

- The nationality is US
- The Dual Nationality is US
- The country of birth is US
- The country of domicile is US
- The country of incorporation is US
- The substantial stay in US is true.
- The country of correspondence or alternate address is US
- The country code of the telephone number is 01
- The country code of the bank branch address is US

### **FATCA Status**

*Display*

The system displays the FATCA Status based on the FATCA maintenance.

On authorization, the system will validate all FATCA related validations and update the FATCA status accordingly, provided, the FATCA client country is 'Yes'.

### **FATCA DiMinimus Check**

*Display*

The system checks this field for investors having US Indicia but whose investments are below a certain maintainable threshold amount.

This field will be unchecked for investors having US Indicia but whose investments are above a certain maintainable threshold amount.

FATCA DiMinimus batch will check and uncheck this field.

**Secondary Identification Type**

*Alphanumeric; 12 Characters; Optional*

Specify the secondary identification type. you can also select the valid secondary identification details from the adjoining option list.

**Secondary Identification Description**

*Display*

The system displays the description for the selected secondary identification type.

**Secondary Identification Number**

*Alphanumeric; 50 Characters; Optional*

Specify the secondary identification number.

**Date of Issue**

*Date Format; Optional*

Specify the date of issue of the second identification document or proof that is furnished by the unit holder.

The date of issue that you specify here must not be later than the date of opening the account.

**Date of Expiry**

*Date Format; Optional*

Specify the date of expiry of the second identification document or proof. It must be later than the date of issue and the application date.

**Place of Issue**

*Alphanumeric; 3 Characters; Optional*

Specify the place of issue of the second identification type. You can also select the valid place of issue of the identification type from the adjoining option list, Once authorized, this field cannot be modified.

**Place of Issue Description**

*Display*

The system displays the place of issue description for the selected place of issue.

**MIFID Applicability**

*Optional*

Select the MIFID applicability status from the drop-down list. The list displays the following values:

- Yes
- No

**MIFID Classification**

*Alphanumeric; 2 Characters; Optional*

Specify the MIFID classification details.

**MIFID Classification Description**

*Display*

The system displays the description for the selected MIFID classification.

### 3.2.8 Bank Dtls Tab

In this section, you specify details of any bank accounts operated by the investor, which are preferred for transacting with the AMC. You can access this section through the Bank Dtls tab.

You can specify any number of preferred bank accounts for an investor, for each currency, but you must designate one of these to be used by the investor as the default bank account for making or receiving payments for a combination of payment mode, transaction type, fund id and transaction currency.

You can also specify the bank details for a combination of payment mode, fund, transaction type and currency for each unit holder maintained in the system. In addition, you can also maintain the routing details for the combination.

During transaction entry, the payment bank details to be used for the unit holder will be picked up based on the combination of payment mode, fund, transaction type and transaction currency.

Click 'Bank Dtls' tab to enter the details.

The screenshot shows the 'Unit Holder Maintenance Detail' form with the 'Bank Dtls' tab selected. The form is titled 'Save' and contains several input fields and buttons. The 'Bank Dtls' tab is highlighted in red in the navigation bar. The form includes fields for Unit Holder ID, Reference Number, CIF Number, First / Company Name, AMC ID, AMC Description, Investor Type, Fund ID, Transaction Type, Bank, Branch, Account Type, Account Type Description, Account Number, Account Name, Account Currency, Account Currency Description, Initials, UH BIC Code, and IBAN. There are also buttons for 'Find UH', 'Find CIF', 'Copy CIF', and 'Copy UH without KYC'. The form is divided into sections: 'Fund ID', 'Transaction Type', 'Bank Details', and 'Bank Details'. The 'Bank Details' section is expanded, showing fields for Account Type, Account Type Description, Account Number, Account Name, Account Currency, Account Currency Description, Initials, UH BIC Code, and IBAN. The form also includes a 'Validate' button and a 'Cancel' button.

For each bank account in each currency, specify the following details:

#### Fund ID

*Alphanumeric; 6 Characters; Optional*

Select the ID of the fund.

#### Transaction Type

*Alphanumeric; 3 Characters; Optional (Mandatory if Fund ID is specified)*

Specify the type of transaction. Alternatively, you can select the transaction type from the option list. The list displays all valid transaction type maintained in the system.

---

**Note**

If no IDS is maintained for the Unit Holder then system will take the banking instructions for dividend payment maintained at Unit Holder screen (UTDUH).

If no Dividend Payment banking instructions is maintained for the Unit Holder in Unit Holder Maintenance Detail screen (UTDUH) then the system will take the banking instructions for 'All' transaction types/funds.

---

**Bank**

*Alphanumeric; 12 Characters; Mandatory*

From the list, select the name of the bank in which the account is held.

**Branch**

*Alphanumeric; 12 Characters; Mandatory*

From the list, select the name of the branch of the bank in which the account is held.

**Default**

*Mandatory*

Use this check box to identify the bank account that is to be reckoned as the default bank account for the investor in the system. In the desired row, check this box.

---

**Note**

For HSBC customers, accounts for a specific currency and payment type combination can be marked as default accounts only if they are maintained for 'All' funds and 'All' transaction types. Also, for a currency where the default has already been specified, other accounts maintained for specific funds and specific transaction types for the same currency cannot be designated as the default account for that currency.

---

In case the default account for a particular payment type and currency combination has not been maintained and you designate an account maintained for a specific fund and transaction type as the default account, the system displays the following message (at the time of saving unit holder details) "Default accounts can be maintained only for fund 'All' and transaction type 'All'".

**Example**

Consider the following table which shows the default account maintenance for various currency and payment type combinations.

<b>Payment Mode</b>	<b>Fund ID</b>	<b>Transaction Type</b>	<b>Currency</b>	<b>Default Account?</b>
Transfer	ALL	ALL	HKD	Yes
Transfer	ALL	ALL	MCY	Yes
Payment Mode	Fund ID	Transaction Type	Currency	Default Account?
Transfer	Fund 1	02	HKD	No
Transfer	Fund1	02	MCY	No

Here, for the currencies HKD and MCY and payment mode transfer, you can maintain different accounts as the default account (for the 'All' funds and 'All' transaction type combination).

You cannot, however, maintain the account specified for 'Fund 1' and Transaction type '02' as the default account for the currencies MCY and HKD and Payment mode 'Transfer'.

### **Direct Debit Applicable**

*Optional*

Select 'Yes' to indicate if whether direct debits are allowed for the account.

### **Bank Details**

#### **Account Type**

*Alphanumeric; 1 Character; Mandatory*

From the list, select the nature of the account held by the investor. The list provides all account types that have been set up in the Account Type Maintenance records.

#### **Account Type Description**

*Display*

The system displays the description for the selected account type.

#### **Account Number**

*Alphanumeric; 20 Characters; Mandatory*

Specify the number of the account held by the unit holder in the selected bank.

#### **Payment Type**

*Optional*

You can select the payment type whether it is 'Self' or 'Third Party' from the drop-down list.

#### **Last Name**

*Alphanumeric; 105 Characters; Optional*

If you select the 'Account Category' field as 'Self' then the 'Last Name' and 'Initials' will be defaulted.

#### **Identification Type**

*Alphanumeric; 20 Characters; Optional*

Select the identification type from the option list.

#### **Identification Number**

*Alphanumeric; 50 Characters; Optional*

Specify the identification number of the identification type

#### **Relationship**

*Alphanumeric; 40 Characters; Optional*

The system displays the relationship status.

#### **Description**

*Display*

The system displays the description for the selected relationship status.

#### **IBAN**

*Alphanumeric; 40 Characters; Optional*

Specify the IBAN (International Bank Account Number) of the account holder.

---

**Note**

If you select the 'Account Category' field as 'Third Party', the system will not verify the third party bank accounts using the details such as Initials, Identification Number and so forth.

---

**Account Name**

*Alphanumeric; 100 Characters; Mandatory*

Specify the name in which the investor holds the specified bank account.

By default, the system reckons this to be the specified name of the unit holder, and the same is displayed here. It will be accepted into the database as the account holder's name if you do not specify any other.

**Account Currency**

*Alphanumeric; 3 Characters; Mandatory*

Select the currency of the bank accounts that you are designating for the unit holder. You can maintain any number of accounts in each currency; however, you must designate one default bank account for each currency.

The system also allows you to maintain Multi-Currency (MCY) accounts for unit holders/agents. The system uses this account if payment currency account is not available. As with accounts in other currencies, you can have multiple accounts for MCY. You should, however, specify one as the default one to be used for payments.

**Account Currency Description**

*Display*

The system displays the description for the selected account currency.

**Initials**

*Alphanumeric; 10 Characters; Optional*

Specify the initials of the unit holder.

**UH BIC Code**

*Alphanumeric; 24 Characters; Optional*

Specify the UH BIC code.

**Routing Details**

FCIS provides the option to capture the bank routing details as well while maintaining the bank details. At the time of transaction input, the routing details specified here are picked up for the combination of fund, transaction type and transaction currency.

**Swift Format**

*Optional*

Select the format of the Swift message from the drop-down list. The options are:

- MT 103
- MT 202

**Bank Charged**

*Optional*

Indicate whether the bank charges must be levied upon the beneficiary, the remitter or must be shared between the two.

## **Beneficiary Account Category**

### **Beneficiary**

*Alphanumeric; 35 Characters; Optional*

Specify the beneficiary details.

### **Beneficiary Address1-3**

*Alphanumeric; 105 Characters; Optional*

Enter beneficiary address.

### **Beneficiary IBAN**

*Alphanumeric; 40 Characters; Optional*

Specify the beneficiary IBAN details.

### **Beneficiary BIC Code**

*Alphanumeric; 24 Characters; Optional*

Enter beneficiary BIC Code.

### **Beneficiary Account Number**

*Alphanumeric; 34 Characters; Optional*

Enter beneficiary Account Number.

### **Beneficiary Code**

*Alphanumeric; 24 Characters; Optional*

Enter beneficiary code.

### **Beneficiary Info**

*Alphanumeric; 100 Characters; Optional*

Enter beneficiary information.

## **Intermediary Details**

### **Intermediary**

*Alphanumeric; 35 Characters; Optional*

Enter the intermediary details.

### **Intermediary Address 1-3**

*Alphanumeric; 105 Characters; Optional*

Enter intermediary address.

### **Intermediary IBAN**

*Alphanumeric; 40 Characters; Optional*

Enter intermediary IBAN details.

### **Intermediary BIC Code**

*Alphanumeric; 24 Characters; Optional*

Enter intermediary BIC Code.

### **Intermediary Account Number**

*Alphanumeric; 34 Characters; Optional*

Enter intermediary Account Number.



**Intermediary Code**

*Alphanumeric; 24 Characters; Optional*

Enter intermediary code.

**Intermediary Info**

*Alphanumeric; 100 Characters; Optional*

Enter intermediary information.

**Further Credit Details****Further Credit Name**

*Alphanumeric; 35 Characters; Optional*

Enter further credit name.

**Further Credit Account Number**

*Alphanumeric; 35 Characters; Optional*

Enter further credit account number.

**Reference Section****Reference 1-2**

*Alphanumeric; 35 Characters; Optional*

Enter the reference details.

**3.2.9 Intermediary Dtls Tab**

At the time of saving the investor's account, if the client country parameter 'Verification of Bank Accounts' is applicable, the system will save the account with the status "Un-Verified". If the client country parameter is not applicable, the account will be saved as "Verified".

If the client country parameter 'Third Party Bank Details' is applicable, the system will not allow you to capture random bank details.

In this section, specify the intermediaries (with the respective hierarchies) that will represent the investor in transactions with the AMC. You can also specify applicable commission percentages that each is to receive.

Click 'Intermediary Dtls' tab to enter the details.

The screenshot shows the 'Unit Holder Maintenance Detail' form. The 'Intermediary Dtls' tab is selected. The form contains the following fields and sections:

- Save** button at the top left.
- Fields: Unit Holder ID, Reference Number, CIF Number, First / Company Name \*, AMC ID \*, AMC Description, and Investor Type \* (set to Individual).
- Buttons: Find UH, Find CIF, Copy CIF, and Copy UH without KYC.
- Navigation tabs: Account Details, Individual Dtls, Corporate Dtls, Contact Dtls, Client Preferences, ID Details, Bank Dtls, **Intermediary Dtls**, KYC Details, Document Dtls, Add Info, UH Signature, Related Parties, FATCA Audit Log, UH KIID Compliance.
- Broker Details** section containing a table:
 

Broker ID	Broker Name	Parent Broker Name	Split Percentage *	Default	Advise Mode
<input checked="" type="checkbox"/>				Yes	Select One
- Intermediary** section with sub-tabs: Delivery Dtls, Beneficiary Details, Joint Holder Dtls, Nominee Dtls, Member Dtls, Alternate Language Dtls, Director Details, Tax Compliance, Multiple Tax Details, Subscription.
- Footer fields: Input by, Authorized by, DateTime, Mod No, Record Status, Authorization Status, and a **Cancel** button.

## **Broker Details Section**

### **Broker ID**

*Alphanumeric; 12 Characters; Optional*

Select the broker ID preferred by the investor, from the list. The corresponding information regarding the Broker Name and Parent Broker Name will automatically be populated in the adjoining fields on selection of the Intermediary.

Broker can be selected by specifying the broker code or the name (or part of the name) and click on the adjacent option list. System will search for Brokers with Broker code or name having the given search string. In addition system will have a search option based on the Legacy Code in the option list.

### **Broker Name**

*Display*

The system displays the broker name for the selected broker ID.

### **Parent Broker Name**

*Display*

The system displays the parent broker name for the selected broker ID.

### **Split Percentage**

*Numeric; 5 Characters; Mandatory if you select any broker in the Intermediary field.*

Specify the percentage of the commission that the selected broker is entitled to receive on any transactions put through for the investor.

This percentage must not exceed one hundred percent.

---

**Note**

If you specify more than one broker in this section, then the split percentages for all brokers, when summed up, must not exceed or fall below one hundred percent.

---

**Default**

*Optional*

Select 'Yes' to identify the broker that is to be reckoned as the default broker for the investor in the system. In the desired row, check this box.

**Advise Mode**

*Optional*

Select the mode of advise from the adjoining drop-down list. Following are the options available:

- Select One
- Independent
- Advised

**Intermediary Details**

If the client country parameter 'TXNBROKERS' is set to false for your installation, you can enter agent-agency branch as intermediary. You can select at least one set of Agent, Agency branch, Account Officer and IFA combination as part of unit holder.

The intermediaries maintained during unit holder creation get defaulted during Transaction, Bulk Transactions and Standing Instruction maintenance and can be overridden.

**Entity Type**

*Alphanumeric; 1 Character; Optional*

Select the entity type that has been identified as the intermediary for the transaction.

**Entity ID**

*Alphanumeric; 12 Characters; Optional*

For each entity type, specify the intermediary in this field. The name of the selected intermediary is displayed in the Entity Name field.

While entering a transaction, system will default the intermediary specified here. However, you can override the defaulted value.

**Entity Name**

*Display*

The system displays the name of the entity for the selected entity ID.

**Split Percentage**

*Numeric; 5 Characters; Optional*

Specify the percentage of the commission that the selected intermediary is entitled to receive on any transactions put through for the investor.

**Default**

*Optional*

Select 'Yes' to identify the intermediary that is to be reckoned as the default intermediary for the investor in the system.

## Advise Mode

### Optional

Select the advise mode from the drop-down list. The list displays the following values:

- Advised Business
- Independent

## 3.2.10 KYC Details Tab

Depending on the type of country marked for the investor and the investor category, Unit Holder KYC list maintained for that type of country and investor category is displayed. If you have maintained a document list for a specific country, the system defaults the documents based on the country, country type and investor category combination. You can check the documents received from the investor and link the KYC list to the unit holder being created.

The screenshot shows the 'Unit Holder Maintenance Detail' window with the 'KYC Details' tab selected. The form includes the following elements:

- Save** button at the top left.
- Fields for: Unit Holder ID, Reference Number, CIF Number, First/Company Name\*, AMC ID\*, AMC Description, and Investor Type\* (set to Individual).
- Buttons: Find UH, Find CIF, Copy CIF, and Copy UH without KYC.
- Navigation tabs: Account Details, Individual Dtls, Corporate Dtls, Contact Dtls, Client Preferences, ID Details, Bank Dtls, Intermediary Dtls, **KYC Details**, Document Dtls, Add Info, UH Signature, Related Parties, FATCA Audit Log, UH KIID Compliance.
- Default KYC** button.
- + KYC Details** section containing:
  - Chasing Date, Chased By, Chased Method, Additional Comments, Review By, Last Reviewed Date, and Chasing History button.
  - Checkboxes: Retain Trade Acknowledgements, Retain Contract Notes, and Outstanding KYC requirements not to be reported on Trade Acknowledgements.
  - Dropdowns: All the Requested KYC Documentation has been received (Yes), KYC Purchase Limit, KYC Annual Debit Order Limit, and Due diligence level (Simplified).
- Name Check Search** section with a search bar.
- Bottom navigation: Delivery Dtls, Beneficiary Details, Joint Holder Dtls, Nominee Dtls, Member Dtls, Alternate Language Dtls, Director Details, Tax Compliance, Multiple Tax Details, Subscription.
- Footer: Input by, Authorized by, DateTime, Mod No, Record Status, Authorization Status, and a **Cancel** button.

Click 'Default KYC' button to default the KYC details.

## KYC Details

### Chasing Date

*Date Format; Optional*

Specify the chasing date.

Chasing date can be backdated.

### Chased By

*Alphanumeric; 255 Characters; Optional*

Specify the user ID if chasing date is maintained.

**Chased Method**

*Optional*

Select the chased method from the adjoining drop-down list. Following are the options available:

- EM: for E-mail
- FA: for FAX
- TL: Telephone

**Additional Comments**

*Alphanumeric; 255 Characters; Optional*

Specify additional comments, if any.

**All the Requested KYC Documentation has been received**

*Optional*

Select if all the requested KYC documentation has been received or not from the adjoining drop-down list. Following are the options available:

- Yes
- No

**KYC Purchase Limit**

*Numeric; 30 Characters; Optional*

Specify the KYC purchase limits.

**KYC Annual Debit Order Limit**

*Numeric; 30 Characters; Optional*

Specify KYC annual debit order limit details.

**Due Diligence Level**

*Optional*

Select due diligence level from the adjoining drop-down list. Following are the options available:

- Simplified
- Standard
- Enhanced

**Review By**

*Alphanumeric; 255 Characters; Optional*

Specify the details of the reviewer.

**Last Reviewed Date**

*Date Format; Optional*

Specify the last reviewed date.

**Retain Trade Acknowledgements**

*Optional*

Check this box to retain trade acknowledgements.

**Retain Contract Notes**

*Optional*

Check this box to retain contract notes.

**Outstanding KYC requirements not to be reported on Trade Acknowledgements.**

*Optional*

Check this box if outstanding KYC requirements are not to be reported on trade acknowledgements.

**Names Check Search**

**Options**

*Optional*

Select one of the options available for checking the names from the adjoining drop-down list. Following are the options available:

- No Match
- Yes
- Yes (PEP, SCC)

**Comments**

*Alphanumeric; 255 Characters; Optional*

Specify comments, if any.

---

**Note**

Documents defaulted from KYC maintenance cannot be deleted. However, Additional documents added during UH creation can be deleted before checking the 'All the requested KYC documents has been received' option.

---

Clicking on 'Chasing History' button, the system will display KYC Chasing History details.

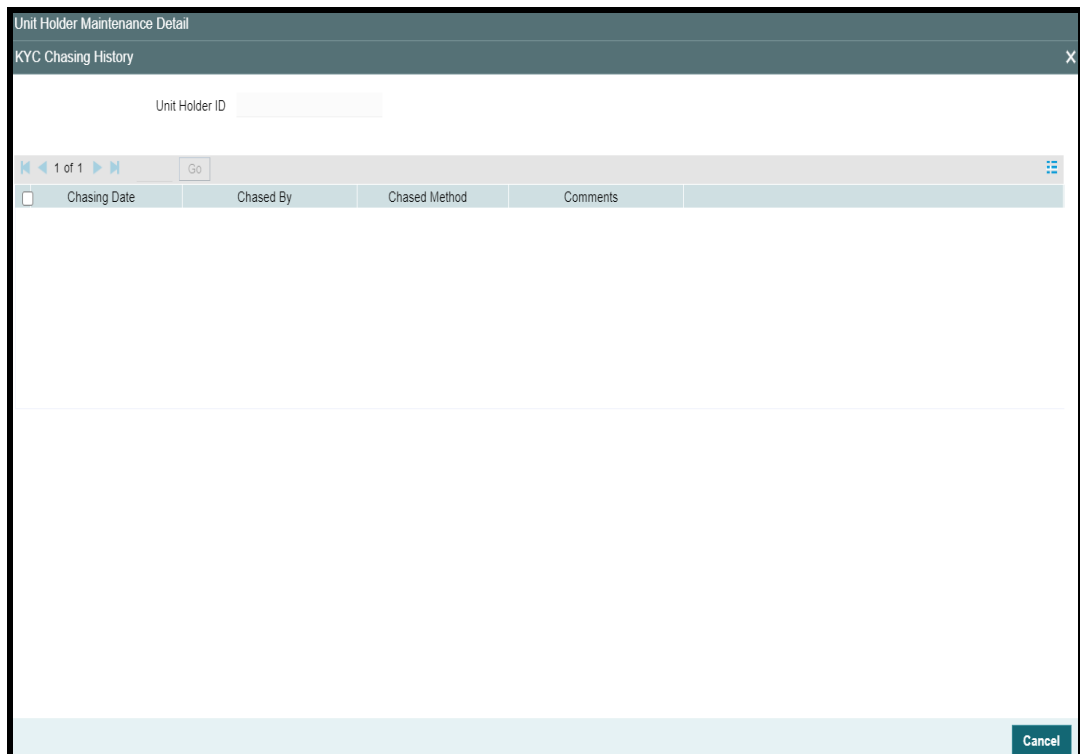

The following details will be displayed:

- Unit Holder ID
- 'Chasing Date'
- 'Chased By' which will display the user ID
- The chased method such as e-mail, Fax and Phone
- Comments

### **Application Form Details**

You can differentiate between legal entities and share classes for the KYC documents. The system will track whether application form is received at fund family, legal entity or fund level at the maintenance level. The application form can be mapped to multiple funds, multiple fund families and multiple legal entities.

You can specify the following details:

#### **Applicable Level**

*Optional*

Select the applicable level from the adjoining drop-down list. Following are the options available:

- Legal Entity
- Fund Family
- Fund

#### **Applicable Entity ID**

*Alphanumeric; 12 Characters; Optional*

Specify the applicable entity ID.

#### **Copy Received**

*Optional*

Check this box if copy of application form is received.

#### **Original Received**

*Optional*

Check this box if original details are received,

If 'Original Received' field is unchecked and the transaction is captured in the fund/fund family/ legal entity for which 'Application Form' mapping is done, then the system will display warning message as 'Missing Application Form applicable for Fund/Fund Family/Legal Entity'. This warning message is raised for Subscription, Redemption, Transfers, IPO, Normal Switch, Pseudo Switch transactions, if the original Application Form is not received at any of the levels (Fund/Fund Family/Legal Entity) for which the Application Form mapping is done

The system will perform the following validations:

- The system will first check if the maintenance is done for Fund Level (i.e. application form shows as applicable to Fund). If yes, system will check if the Original Application form has been received. If it is not received, then the system will display warning message as 'Missing Application Form applicable for Fund/Fund Family/Legal Entity'. No further checks will be performed.
- If there is no maintenance done for Fund Level, the system will check if a maintenance is done for Fund Family Level. If yes, then check if the Original Application form has been received. If it is not received, then the system will display warning message as 'Missing Application Form applicable for Fund/Fund Family/Legal Entity'. No further checks will be performed.

- If there is no maintenance done for Fund and Fund Family Level, the system will check if a maintenance is done for Legal Entity Level. If yes, then check if the Original Application form has been received. If it is not received, then the system will display warning message as 'Missing Application Form applicable for Fund/Fund Family/Legal Entity'. No further checks will be performed. You can override the warning message and continue with the transaction.

Application form validation will be applied to both 'From Fund' and 'To Fund' in case of Normal Switch and Pseudo Switch.

For bulk upload and gateway, the same validations will take place as mentioned above. Transaction will be created as Authorized/ Unauthorized depending on maintenance in the system and during the view of the transaction in the 'Transaction Summary' screen. The warning messages attached to the transaction can be viewed through override warning button available in the summary screen.

Upon save, the system will check the Fund structure applicable and Auto settle switch transaction fields are applicable only for Entity type AMC. This field will not be available for user input for other entity types.

### 3.2.11 Document Dtls Tab

Document Management System or DMS is used to scan and store documents like Account Opening form, Transaction form, Identity Proof etc. In this section, you can specify the document type for the unit holder. The document types can be maintained in the System Parameters Maintenance screen.

*For further information on maintenance of system parameters, refer to the chapter Maintaining System Parameters*

Click 'Document Dtls' tab to enter the details.

The screenshot shows the 'Unit Holder Maintenance Detail' window. The 'Document Dtls' tab is selected. The table below the menu is currently empty.

Document ID	Document Type



## Document ID

*Alphanumeric; 25 Characters; Mandatory*

You can either enter the document id in this field or choose the document id from the option list.

## Document Type

*Alphanumeric; 4 Characters; Mandatory*

Specify the document ID.

### 3.2.12 Add Info Tab

If the AMC has designated any additional information heads for investors, you can indicate the relevant information applicable to the investor under each head, in this section. Click 'Add Info' tab to enter the details.

The screenshot displays the 'Unit Holder Maintenance Detail' form. At the top, there is a 'Save' button. Below it, several input fields are arranged in two columns: 'Unit Holder ID', 'Reference Number', and 'CIF Number' on the left; 'First / Company Name \*', 'AMC ID \*', 'AMC Description', and 'Investor Type \*' on the right. The 'Investor Type' dropdown is set to 'Individual'. To the right of these fields are buttons for 'Find UH', 'Find CIF', 'Copy CIF', and 'Copy UH without KYC'. A horizontal navigation bar contains tabs for 'Account Details', 'Individual Dtls', 'Corporate Dtls', 'Contact Dtls', 'Client Preferences', 'ID Details', 'Bank Dtls', 'Intermediary Dtls', 'KYC Details', 'Document Dtls', 'Add Info' (highlighted in red), 'UH Signature', 'Related Parties', 'FATCA Audit Log', and 'UH KIID Compliance'. Below this is the 'Additional Information Details' section, which includes a pagination control showing '1 of 1' and a table with two columns: 'Other Info Field' and 'Field Value'. At the bottom, a status bar contains fields for 'Input by', 'Authorized by', 'DateTime', 'Mod No', 'Record Status', and 'Authorization Status', with a 'Cancel' button on the far right.

## Other Info Field

*Display*

Display the other info field

## Field Value

*Alphanumeric; 60 Characters; Optional*

Select the field value from the option list.

### 3.2.13 UH Signature Tab

You can upload the document containing unit holder's signature's signature using the UH Signature tab in the Unit Holder Maintenance screen.

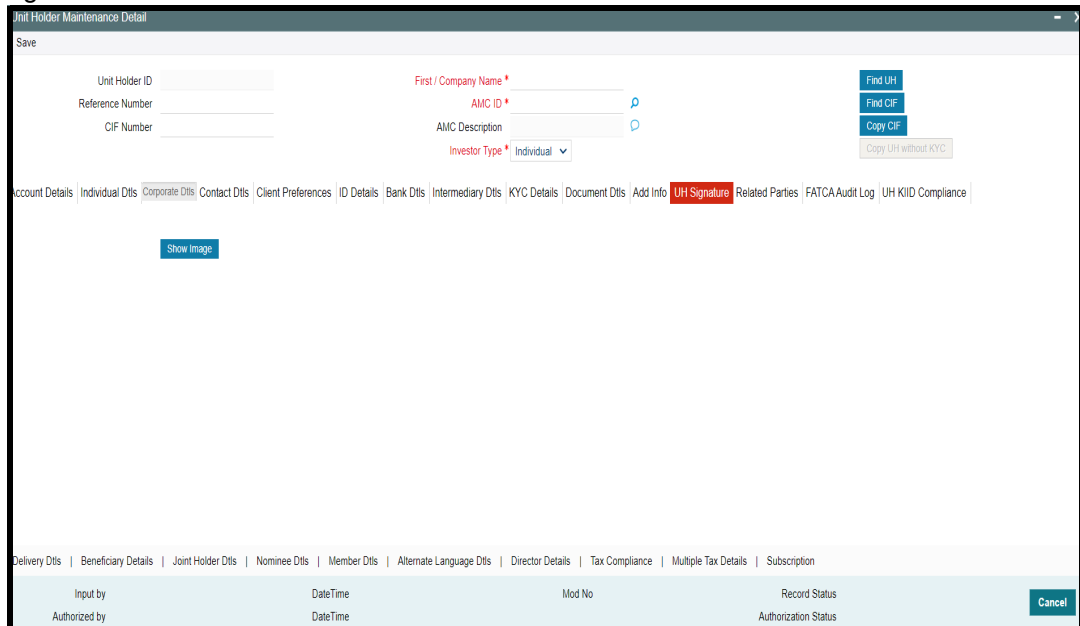

The screenshot shows the 'Unit Holder Maintenance Detail' window. At the top, there is a 'Save' button. Below it, there are input fields for 'Unit Holder ID', 'Reference Number', and 'CIF Number'. To the right, there are fields for 'First / Company Name \*', 'AMC ID \*', 'AMC Description', and 'Investor Type \*' (set to 'Individual'). There are also 'Find UH', 'Find CIF', and 'Copy CIF' buttons. A 'Show Image' button is visible in the center. The bottom of the window has a navigation bar with various tabs, including 'UH Signature' which is highlighted. At the very bottom, there are fields for 'Input by', 'Authorized by', 'DateTime', 'Mod No', 'Record Status', and 'Authorization Status', along with a 'Cancel' button.

Upon clicking the UH Signature tab, you will find the following two buttons:

- Show Image

Click on the Show image button to invoke the 'Image Upload' screen. Click 'Upload' button to invoke the image upload screen.

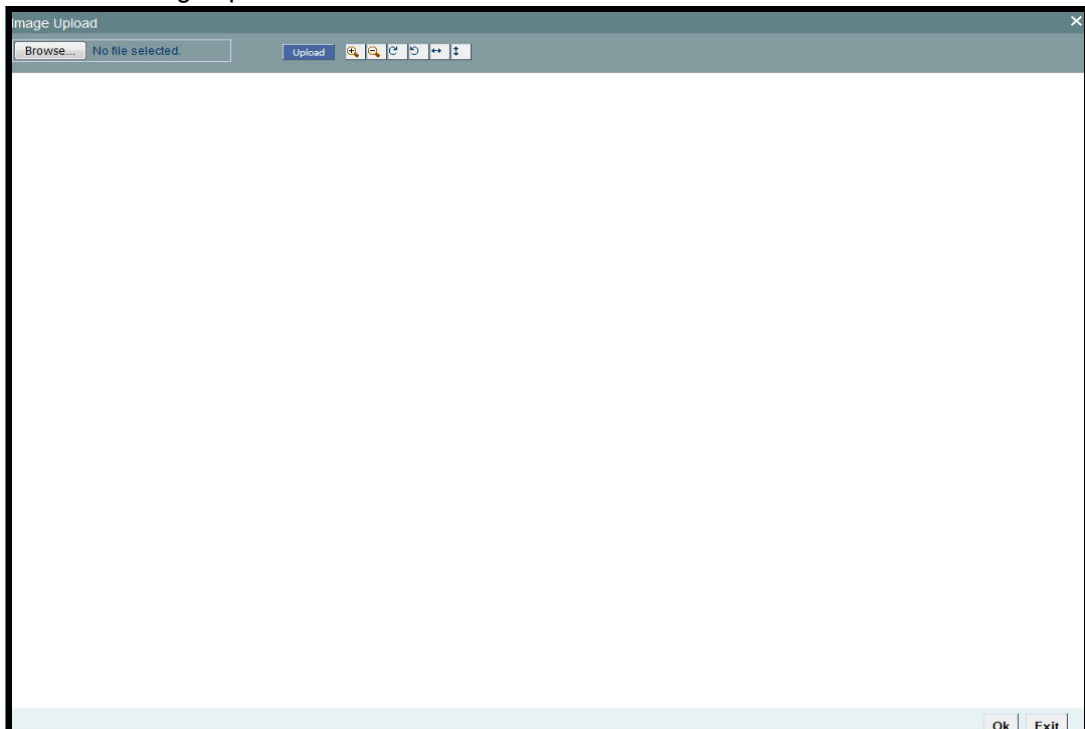

The screenshot shows the 'Image Upload' window. It has a 'Browse...' button and a text field that says 'No file selected.'. There is an 'Upload' button and a toolbar with icons for file operations. At the bottom right, there are 'OK' and 'Exit' buttons.

In the image upload screen you can browse for the required document or image and click upload button. After uploading the document, click OK to exit.

### 3.2.14 Related Parties Tab

You can link authorized 'Related Parties' entity with unit holder at the time of Unitholder creation. Click 'Related Parties' tab in the Unitholder Maintenance screen. You can link multiple 'Related parties' and add, modify or delete the linked related parties. These details are used to send unit holder reports to the linked entities. The report sent is based on the reporting level selected while creating unitholder.

#### Note

Related Parties are captured for informational purpose only and no processing impact is associated.

The screenshot displays the 'Unit Holder Maintenance Detail' interface. At the top, there is a 'Save' button. Below it are several input fields: 'Unit Holder ID', 'Reference Number', 'CIF Number', 'First / Company Name \*', 'AMC ID \*', 'AMC Description', and 'Investor Type \*' (set to 'Individual'). There are also buttons for 'Find UH', 'Find CIF', 'Copy CIF', and 'Copy UH without KYC'. A navigation bar includes tabs for 'Account Details', 'Individual Dtls', 'Corporate Dtls', 'Contact Dtls', 'Client Preferences', 'ID Details', 'Bank Dtls', 'Intermediary Dtls', 'KYC Details', 'Document Dtls', 'Add Info', 'UH Signature', 'Related Parties' (highlighted), 'FATCA Audit Log', and 'UH KIID Compliance'. Below the navigation bar is a table with one row of data. The table has columns: Entity Type, Entity Type Description, Entity ID, Entity Name, Relationship, Reporting Level, Preferred Mailing Mode, and Link Notes. At the bottom, there is a metadata section with fields for 'Input by', 'Authorized by', 'DateTime', 'Mod No', 'Record Status', and 'Authorization Status', along with a 'Cancel' button.

Entity Type	Entity Type Description	Entity ID	Entity Name	Relationship	Reporting Level	Preferred Mailing Mode	Link Notes

The following details are entered for maintaining related parties:

#### Entity Type

*Alphanumeric; 2 Characters; Mandatory*

Select the entity type. Alternatively, you can select entity type from the option list. The list displays all valid entity types maintained in the system.

#### Entity Type Description

*Display*

The system displays the description for the selected entity type.

**Entity ID**

*Alphanumeric; 12 Characters; Mandatory*

Select the entity ID from the option list. These entities are based on the Entity Type chosen.

**Entity Name**

*Display*

The entity name gets displayed on selection of entity ID.

**Relationship**

*Alphanumeric; 10 Characters; Optional*

Specify the relationship status.

**Reporting Level**

*Alphanumeric; 1 Character; Mandatory*

Select the reporting level from the list. The following are the reporting levels:

- A: All Reports
- C: Contract notes and trade acknowledgement
- V: Valuations and statements
- N: No Reporting

By default, the system defaults Reporting Level as 'ALL'.

**Preferred Mailing Mode**

*Alphanumeric; 1 Character; Mandatory*

Select the preferred mailing mode from the option list. The following are the preferred mailing modes:

- Mail
- E-Mail
- Fax
- SWIFT

**Link Notes**

*Alphanumeric; 255 Characters; Optional*

The link notes stores free format text which is used to explain the reason for linking the entity with the unit holder.

---

**Note**

Related Parties are captured for informational purpose only and no processing impact is associated.

---

**Related Party Level**

*Mandatory*

Select the related party level from the adjoining drop-down list. Following are the options available:

- All
- Fund
- Fund Family
- Legal Entity
- AMC

## Related Party Value

*Alphanumeric; 12 Characters; Mandatory*

Specify the related party value. The adjoining option list displays all valid related party values maintained in the system. You can choose the appropriate one.

If you select 'All' in 'Related Party Level' field, then you need to select 'All' from the adjoining option list in 'Related Party Value' field as well. The system will not allow any more records to be added if ALL has been selected in the 'Related Party Level' field for a particular entity ID and entity type combination.

The system will consider the correspondence address for all the entities for report generation.

### 3.2.15 FATCA Audit Log Tab

You can view various FATCA related updated for a unit holder during FATCA Classification maintenance, during batch run and Unit holder authorization. Click 'FATCA Audit Log' tab in the 'Unitholder Maintenance' screen.

The screenshot displays the 'Unit Holder Maintenance Detail' window. At the top, there is a 'Save' button. Below it, several input fields are visible: 'Unit Holder ID', 'Reference Number', 'CIF Number', 'First / Company Name', 'AMC ID', 'AMC Description', and 'Investor Type' (set to 'Individual'). There are also buttons for 'Find UH', 'Find CIF', 'Copy CIF', and 'Copy UH without KYC'. A navigation bar contains tabs for 'Account Details', 'Individual Dtls', 'Corporate Dtls', 'Contact Dtls', 'Client Preferences', 'ID Details', 'Bank Dtls', 'Intermediary Dtls', 'KYC Details', 'Document Dtls', 'Add Info', 'UH Signature', 'Related Parties', 'FATCA Audit Log' (highlighted in red), and 'UH KIID Compliance'. Below the navigation bar, the 'FATCA Audit Log' section is active, showing a table with columns: 'Log Date', 'Logging Reason', 'Criteria Matched', 'US Indicia Updated', and 'FATCA Status'. The table is currently empty. At the bottom, there are fields for 'Input by', 'Authorized by', 'DateTime', 'Mod No', 'Record Status', and 'Authorization Status', along with a 'Cancel' button.

The system will display the data in the descending order of date logged latest one first.

#### **Log Date**

*Display*

The system displays the date on which the customer record was logged for further checking.

#### **Logging Reason**

*Display*

The system displays the reason for logging the record.

### Criteria Matched

#### Display

The system displays the US Indicia satisfying matching criteria for the customer. From the list of several criteria defined for identifying the US indicia of a customer, the system will record one of the matching criteria which establishes the presence of US Indicia for the customer

### US Indicia Updated

#### Display

The system displays the US Indicia updated status.

### FATCA status

#### Display

The system displays the FATCA status

## 3.2.16 UH KIID Compliance Tab

You can specify UCITS fund mapping details by clicking on 'UH KIID Compliance' tab in the 'Unitholder Maintenance' screen.

The screenshot shows the 'Unit Holder Maintenance Detail' screen. At the top, there is a 'Save' button. Below it, there are several input fields: 'Unit Holder ID', 'Reference Number', 'CIF Number', 'First/Company Name \*', 'AMC ID \*', 'AMC Description', and 'Investor Type \*' (set to 'Individual'). There are also buttons for 'Find UH', 'Find CIF', 'Copy CIF', and 'Copy UH without KYC'. A navigation bar at the bottom of the form area includes tabs for 'Account Details', 'Individual Dtls', 'Corporate Dtls', 'Contact Dtls', 'Client Preferences', 'ID Details', 'Bank Dtls', 'Intermediary Dtls', 'KYC Details', 'Document Dtls', 'Add Info', 'UH Signature', 'Related Parties', 'FATCA Audit Log', and 'UH KIID Compliance' (which is highlighted in red). Below the navigation bar is a section titled 'UCITS Fund Mapping Details' with a table. The table has columns for 'Fund ID', 'Fund Name', and 'Effective Date'. There is a 'Go' button and a '1 of 1' indicator. At the bottom of the screen, there is a footer area with fields for 'Input by', 'Date Time', 'Mod No', 'Record Status', 'Authorized by', 'Date Time', and 'Authorization Status', along with a 'Cancel' button.

### UCITS Fund Mapping Details

#### Fund ID

*Alphanumeric; 6 Characters; Optional*

Specify the fund ID. This adjoining option list displays all function ID maintained in the system. You can choose the appropriate one.

#### Fund Name

#### Display

The system displays the fund name for the selected fund ID.

### Effective Date

*Date Format; Optional*

Specify the effective date.

Effective date can be less than or equal to system date.

### 3.2.17 Delivery Dtls Button

You can capture the delivery details by clicking 'Delivery Dtls' button in the Unit Holder - Maintenance screen.

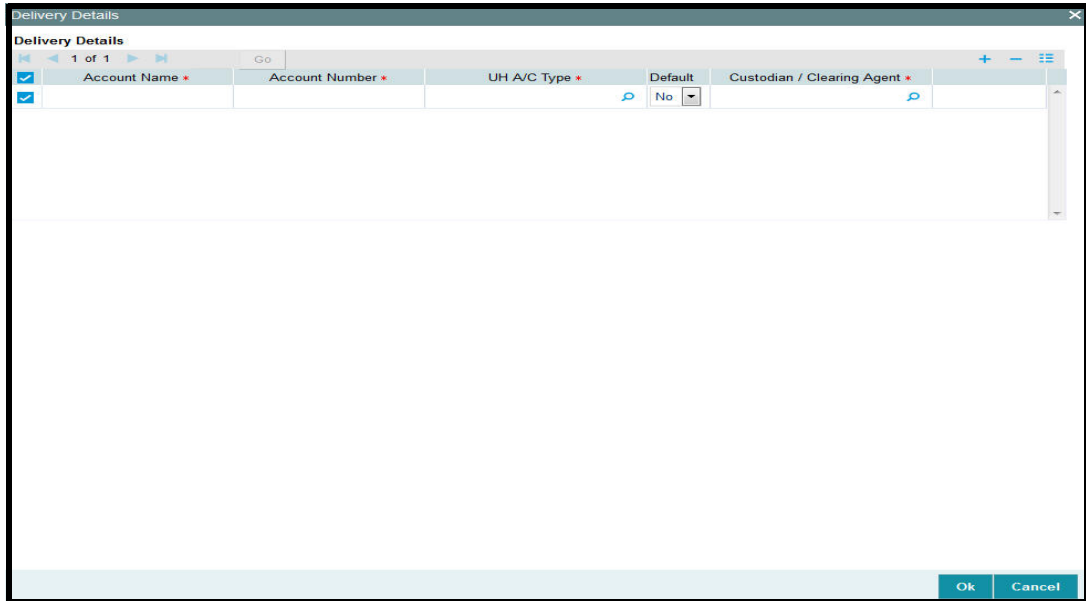

The screenshot shows a window titled "Delivery Details" with a table containing the following columns: Account Name, Account Number, UH A/C Type, Default, and Custodian / Clearing Agent. The "Default" column has a dropdown menu with "No" selected. There are "Ok" and "Cancel" buttons at the bottom right of the window.

The following are the fields under Delivery section:

#### **Account Name**

*Alphanumeric; 105 Characters; Mandatory*

Specify the account name.

#### **Account Number**

*Alphanumeric; 20 Characters; Mandatory*

Specify the account number.

#### **UH A/C Type**

*Alphanumeric; 1 Character; Mandatory*

Specify the unit holder account type.

#### **Default**

*Optional*

Select the default option from the drop-down list.

#### **Custodian/Clearing Agent**

*Alphanumeric; 105 Characters; Mandatory*

Specify the custodian or clearing agent details.

### 3.2.18 Beneficiary Dtls Button

You can capture the details of one or more beneficiaries, if any, for the unit holder. A beneficiary could be an existing Unit Holder in the system or could be an external entity. You can access it by clicking 'Beneficiary Dtls' button..

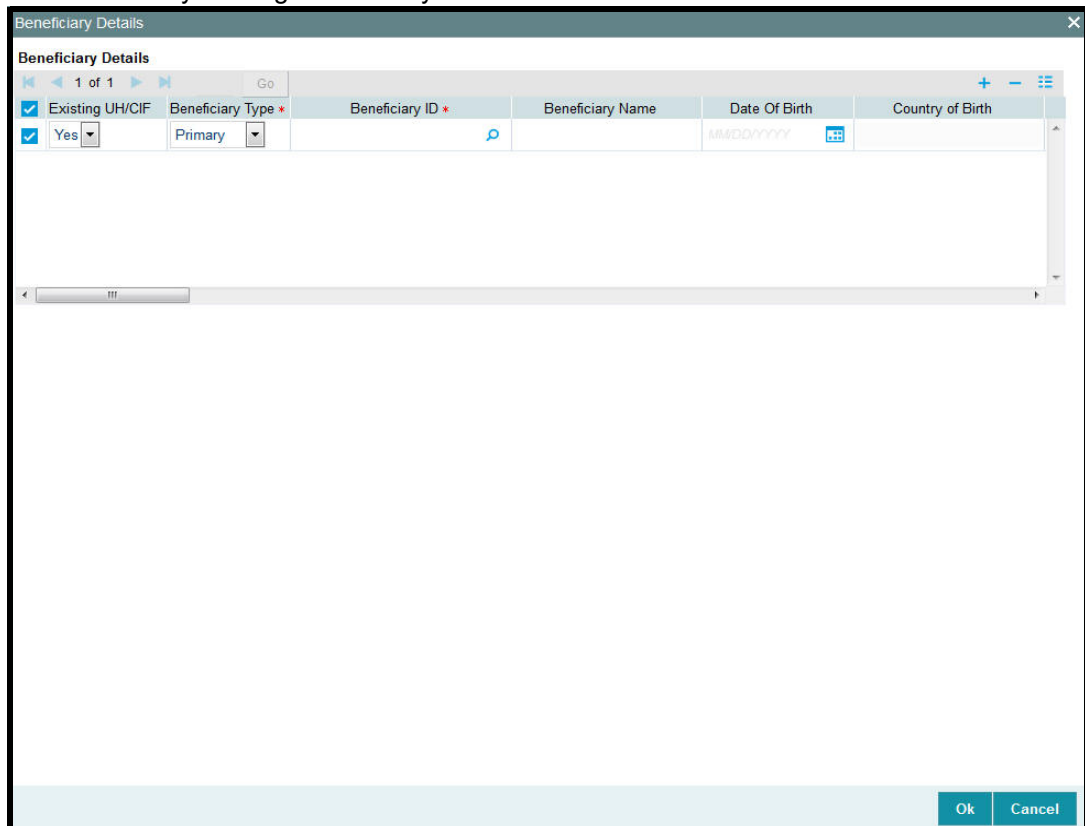

The screenshot shows a window titled "Beneficiary Details" with a table containing one row of data. The table has the following columns: Existing UH/CIF, Beneficiary Type, Beneficiary ID, Beneficiary Name, Date Of Birth, and Country of Birth. The values in the row are: Yes, Primary, (empty), (empty), MMDD/YYYY, and (empty). The window also includes a search icon in the Beneficiary ID column and "Ok" and "Cancel" buttons at the bottom right.

Existing UH/CIF	Beneficiary Type *	Beneficiary ID *	Beneficiary Name	Date Of Birth	Country of Birth
<input checked="" type="checkbox"/> Yes	Primary			MMDD/YYYY	

#### **Existing UH/ CIF**

*Optional*

Select if the unit holder or CIF is existing or not from the drop-down list. The list displays the following values:

- Yes
- No

#### **Beneficiary Type**

*Mandatory*

Specify whether the beneficiary is a primary or secondary holder.

#### **Beneficiary ID**

*Alphanumeric; 12 Characters; Mandatory*

If the beneficiary is an existing unit holder, you can invoke the 'Find Options' screen to specify the desired unit holder, by using the search criteria. Else, specify the same.

#### **Beneficiary Name**

*Display*

The system displays the name of the beneficiary.



**Date of Birth**

*Date format, Optional*

Enter the beneficiary's date of birth.

**Country of Birth**

*Display*

The system displays the country of birth of beneficiary.

**Gender**

*Optional*

Select the gender of the beneficiary from the drop-down list. The list displays the following values:

- Male
- Female

**ID Type**

*Alphanumeric; 3 Characters; Optional*

Select the identification type of the beneficiary from the drop-down list. If the beneficiary is a valid Unit Holder, the identification type will be displayed.

**ID Number**

*Alphanumeric; 50 Characters; Optional*

Specify the identification number of the identification type of the beneficiary. If the beneficiary is a valid Unit Holder, the identification number will be displayed.

**Relation**

*Alphanumeric; 70 Characters; Optional*

Specify the relationship of the beneficiary with the unit holder. If the beneficiary is a valid Unit Holder, the relationship will be displayed.

**Award %**

*Alphanumeric; 5 Characters; Optional*

Specify the percentage of the unit holder's holdings that belongs to the beneficiary. The award should sum up to 100.

**Country Of Domicile**

*Alphanumeric; 5 Characters; Optional*

Specify the country of domicile details.

**Address Line 1 - 2**

*Alphanumeric; 105 Characters; Optional*

Specify the contact address of the beneficiary.

**City**

*Alphanumeric; 105 Characters; Optional*

Specify the city name of the beneficiary.

**State**

*Alphanumeric; 5 Characters; Optional*

Specify the state name of the beneficiary.

**Country**

*Alphanumeric; 3 Characters; Optional*

Specify the country name of the beneficiary.

**Zip Code**

*Alphanumeric; 3 Characters; Optional*

Specify the zip code.

**Email**

*Alphanumeric; 255 Characters; Optional*

Specify the e-mail details of the beneficiary.

**Contact Person**

*Alphanumeric; 60 Characters; Optional*

Specify the contact person details.

**Bank**

*Alphanumeric; 12 Characters; Optional*

Specify the bank code of the beneficiary's bank. You can select the same from the option list, if the bank code is a valid code in the system.

**Branch**

*Alphanumeric; 12 Characters; Optional*

Specify the branch of the bank that you have selected. You can select the same from the option list, if the branch is a valid one in the system.

**Account Type**

*Alphanumeric, 1 Character; Optional*

From the list, select the nature of the account held by the beneficiary.

**Account Currency**

*Alphanumeric; 3 Characters; Optional*

Select the currency of the bank accounts that you are designating for the beneficiary.

**Account Number**

*Alphanumeric; 20 Characters; Optional*

Specify the number of the account held by the beneficiary in the selected bank.

**Account Name**

*Alphanumeric; 105 Characters; Optional*

Specify the name in which the beneficiary holds the specified bank account.

**IBAN**

*Alphanumeric; 40 Characters; Optional*

Specify the IBAN (International Bank Account Number) of the account holder.

**US Indicia**

*Display*

The system defaults US Indicia Available as Yes if any of the below mentioned values are true:

- The nationality is US
- The dual nationality is US
- The substantial stay is in US

- The country of birth is US
- The country of domicile is US
- The country of incorporation is US
- The country of correspondence or alternate address is US
- The country code of the telephone number is 01
- The Bank Branch address Country code is US
- The Director % of holding is more than 10%

If the primary UH has linked entities like Joint holder/joint holders, Auth rep, related party (Auth Rep, Nominee and Joint Holder), beneficiary and for any one of them US Indicia Available is 'YES', and if the primary UH US Indicia Available is 'No' then the system will display the following message:

US Indicia Available is 'No' for Unit Holder but US Indicia Available is 'Yes' at Joint Holder/ Auth Rep/Beneficiary/Related Party(Auth Rep, Nominee and Joint Holder) (any one)".

The system will change the US Indicia available as 'Yes' and save the record automatically.

#### **FATCA Classification**

##### *Display*

If the beneficiary selected is an existing entity in the system, then system displays FATCA Classification type.

#### **FATCA Status**

##### *Display*

If the beneficiary selected is an existing entity in the system, then the system displays FATCA Status based on FATCA maintenance.

### **3.2.19 Joint Holder Dtls Button**

You can specify the names of any joint unit holders to be considered for joint unit holder accounts, or 'Either' or 'Survivor' accounts.

For accounts with the operation type as either Joint or Either or Survivor, you must specify the name of at least one joint unit holder for such an account, as mandatory information.

You can access this section by clicking 'Joint Holder Dtls' button in the Unit Holder - Maintenance screen.

The screenshot shows a window titled "Joint Holder Details" with a table containing one row of data. The table has the following columns and values:

Existing UH/CIF	Joint Holder Type *	Joint Holder ID *	Joint Holder Name	Date Of Birth	Country of Birth
Yes	First			MM/DD/YYYY	

At the bottom right of the window, there are "Ok" and "Cancel" buttons.

### Existing UH/ CIF

*Optional*

Select if the unit holder or CIF is existing or not from the drop-down list. The list displays the following values:

- Yes
- No

### Joint Holder Type

*Mandatory*

Select the Type of joint account from the drop-down list. The list displays the following values:

- First
- Second
- Third

### Joint Holder ID

*Alphanumeric; 12 Characters; Mandatory*

Select the ID of the joint account holder from the list of IDs available.

**Joint Holder Name**

*Display*

The system displays the name of the Joint Holder.

**Date of Birth**

*Date format, Optional*

Enter the joint account holder's date of birth.

**Country of Birth**

*Display*

The system displays the country of birth mapped for the UH.

**Gender**

*Optional*

Specify the gender of the joint account holders.

**PAN/GIR Number**

*Alphanumeric; 15 Characters; Optional*

Specify the Permanent Account Number (PAN) of the joint account holders in the respective text boxes.

**Form 60/61 Available?**

*Optional*

Indicate whether Form 60/61 is available for the joint holders in case they don't have a PAN.

**MFIN**

*Alphanumeric; 15 Characters; Optional*

Specify the MFIN of the joint account holder.

**Recover CGT?**

*Optional*

Select 'Yes' option, if the tax on capital gain has to be deducted from the transaction (Redemption, Transfer and Switch).

**Country of Domicile**

*Alphanumeric; 3 Characters; Optional*

Select the country of domicile from the option list provided; these details are maintained as part of Country Maintenance.

**Address Line 1 and Address Line 2**

*Alphanumeric; 105 Characters; Optional*

Click on the 'Address Details' link to view the 'Address' text box. Here you can enter the address of the joint account holder.

**City**

*Alphanumeric; 105 Characters; Optional*

Specify the city name of the joint holder.

**State**

*Alphanumeric; 5 Characters; Optional*

Specify the state name of the joint holder.

**Zip Code**

*Alphanumeric; 3 Characters; Optional*

Specify the zip code.

**Country**

*Alphanumeric; 3 Characters; Optional*

Specify the country name of the joint holder.

**Email**

*Alphanumeric; 255 Characters; Optional*

Specify the e-mail details of the joint holder.

**Contact Person**

*Alphanumeric; 60 Characters; Optional*

Specify the contact person details.

**Telephone 1 and 2**

*Alphanumeric; 60 Characters; Optional*

Specify the telephone number.

**Cellphone Number**

*Alphanumeric; 60 Characters; Optional*

Specify the cellphone number.

**Fax**

*Alphanumeric; 60 Characters; Optional*

Specify the fax number.

**US Indicia**

*Display*

The system defaults the US Indicia Available as Yes or No based on the existing UH/CIF maintained.

If the existing UH/CIF is Yes then the system defaults the US Indicia available.

If the existing UH/CIF is No then the system derives the US Indicia available based on the country, country of domicile and bank branch country.

**FATCA Classification**

*Display*

If the joint selected is an existing entity in the system, then system displays FATCA Classification type.

**FATCA Status**

*Display*

If the joint selected is an existing entity in the system, then system displays FATCA Status based on FATCA maintenance.

---

**Note**

The fields 'PAN/GIR Number', 'MFIN' and 'Form 60/61' will be displayed only if the client country option 'SHOWPANINFO' is set to 'True' for your bank.

---

### 3.2.20 Nominee Dtls Button

You can specify the details of one or more nominees, if any, for the unit holder. A nominee could be an existing Unit Holder in the system or could be an external entity.

You can capture the nominee details by clicking 'Nominee Dtls' button in the Unit Holder - Maintenance screen.

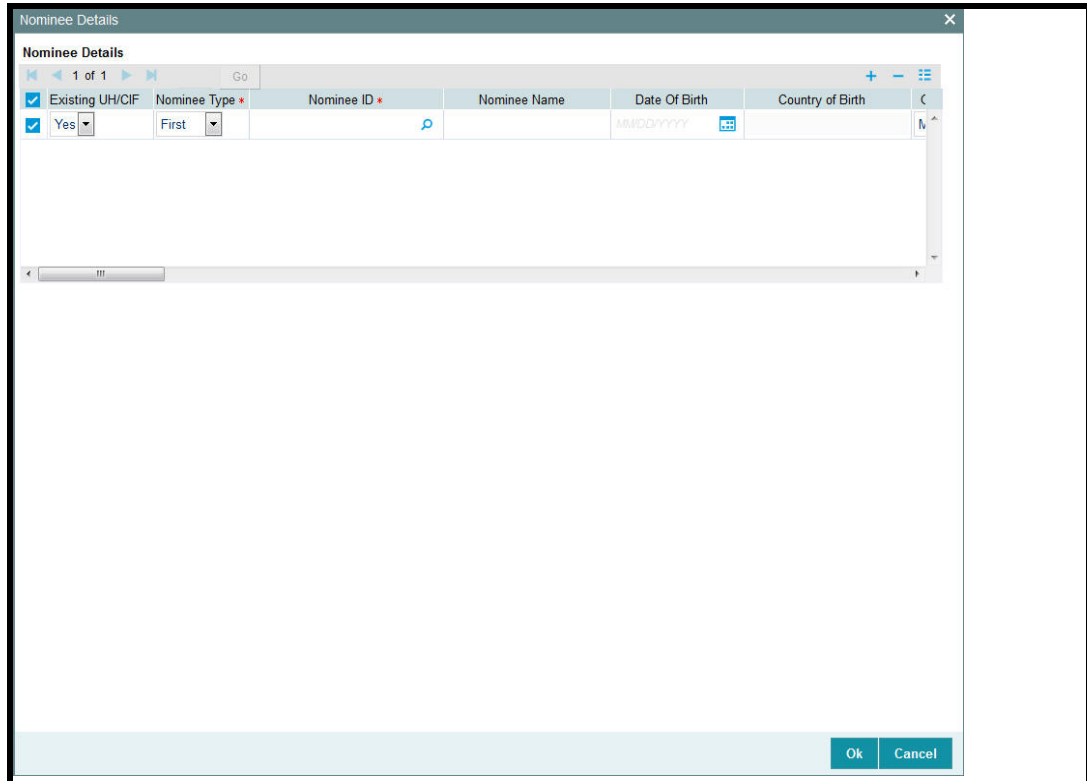

The screenshot shows a window titled "Nominee Details" with a table containing the following columns: Existing UH/CIF, Nominee Type, Nominee ID, Nominee Name, Date Of Birth, and Country of Birth. The "Existing UH/CIF" column has a checked checkbox and a dropdown menu with "Yes" selected. The "Nominee Type" column has a dropdown menu with "First" selected. The "Date Of Birth" column has a date input field with the format MM/DD/YYYY and a calendar icon. The "Country of Birth" column has a dropdown menu with "M" selected. The table is currently empty. At the bottom right of the window, there are "Ok" and "Cancel" buttons.

#### **Existing UH/ CIF**

*Optional*

Select if the unit holder or CIF is existing or not from the drop-down list. The list displays the following values:

- Yes
- No

#### **Nominee Type**

*Mandatory*

Select the type of nominee from the drop-down list. The list displays the following values:

- First
- Second
- Third
- Others

#### **Nominee ID**

*Alphanumeric; 12 Characters; Mandatory*

Specify the nominee ID

**Nominee Name**

*Alphanumeric; 105 Characters; Optional*

Specify the name of the nominee.

**Date of Birth**

*Date Format; Optional*

Specify the date of birth of the designated nominee.

**Country of Birth**

*Display*

The system displays the country of birth mapped for the UH.

**Gender**

*Optional*

Select the gender of the nominee from the option-down list. The list displays the following values:

- Male
- Female

**ID Type**

*Alphanumeric; 3 Characters; Optional*

Specify the identification type of the nominee. If the nominee is a valid Unit Holder, the identification type will be displayed.

**ID Number**

*Alphanumeric; 50 Characters; Optional*

Specify the identification number of the identification type of the nominee. If the nominee is a valid Unit Holder, the identification ID will be displayed.

**PAN/GIR Number**

*Alphanumeric; 15 Characters; Optional*

Specify the Permanent Account Number (PAN) of the nominees in the respective text boxes.

**Form 60/61 Available?**

*Optional*

Indicate whether Form 60/61 is available for the nominees in case they don't have a PAN.

**Relation**

*Alphanumeric; 70 Characters; Optional*

Specify the relationship of the nominee with the unit holder. If the nominee is a valid Unit Holder, the relationship will be displayed.

**Award %**

*Numeric; 5 Characters; Optional*

Specify the percentage of the investor's holdings that belongs to the nominee. The award should sum up to 100.

**Country Of Domicile**

*Alphanumeric; 3 Characters; Optional*

Specify the country of domicile.



**Address Line 1 and 2**

*Alphanumeric; 105 Characters; Optional*

Enter the address of the nominee.

**City**

*Alphanumeric; 105 Characters; Optional*

Specify the city name of the joint holder.

**State**

*Alphanumeric; 5 Characters; Optional*

Specify the state name of the joint holder.

**Zip Code**

*Alphanumeric; 3 Characters; Optional*

Specify the zip code.

**Country**

*Alphanumeric; 3 Characters; Optional*

Specify the country name of the joint holder.

**Email**

*Alphanumeric; 255 Characters; Optional*

Specify the e-mail details of the joint holder.

**Contact Person**

*Alphanumeric; 160 Characters; Optional*

Enter the contact person's name.

**Bank**

*Alphanumeric; 12 Characters; Optional*

Specify the bank details.

**Branch**

*Alphanumeric; 12 Characters; Optional*

Specify the branch code.

**Account Type**

*Alphanumeric; 1 Character; Optional*

Specify the type of account.

**Account Currency**

*Alphanumeric; 3 Characters; Optional*

Specify the account currency code.

**Account Number**

*Alphanumeric; 20 Characters; Optional*

Specify the account number details.

**Account Name**

*Alphanumeric; 100 Characters; Optional*

Specify the name of the account holder.

## **IBAN**

*Alphanumeric; 40 Characters; Optional*

Specify the IBAN (International Bank Account Number) of the account holder.

## **US Indicia**

*Display*

The system defaults the US Indicia Available as Yes or No based on the existing UH/CIF maintained.

If the existing UH/CIF is Yes then the system defaults the US Indicia available.

If the existing UH/CIF is No then the system displays the US Indicia available based on the country, country of domicile and bank branch country.

## **FATCA Classification**

*Display*

The system displays the FATCA classification type.

## **FATCA Status**

*Display*

The system displays the FATCA Status based on the FATCA maintenance.

### **3.2.21 Member Dtls Button**

If the account is of type 'Retirement', you need to capture additional investor details pertaining to retirement accounts in the Member Details screen:

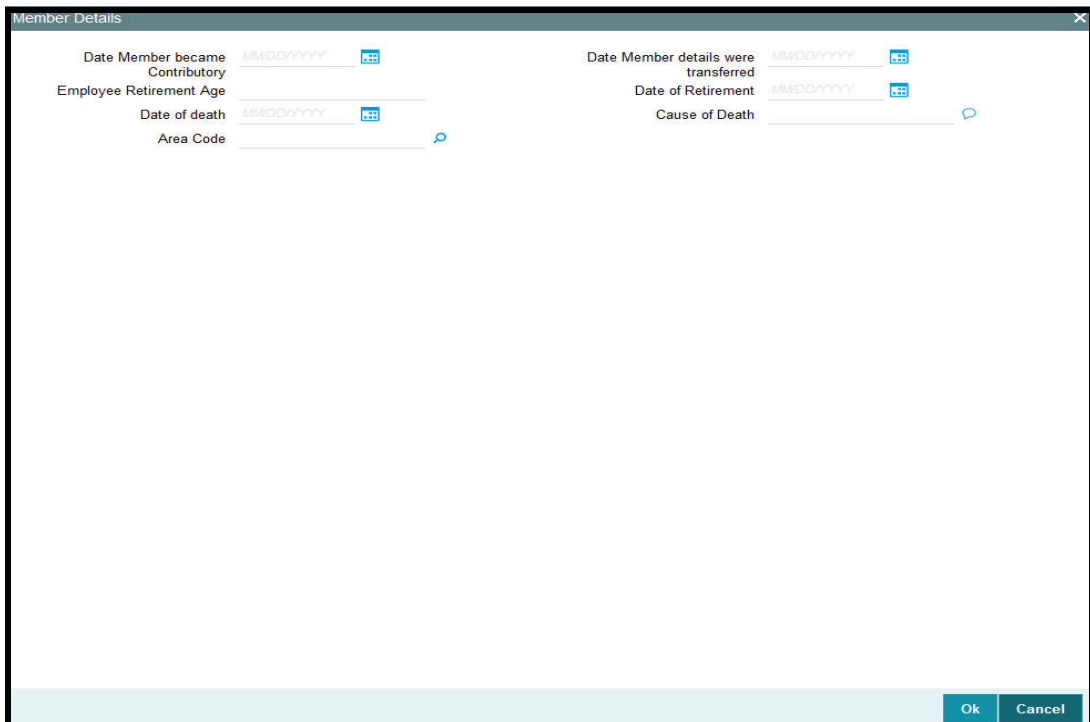

The screenshot shows a window titled "Member Details" with the following fields:

Date Member became Contributory	MMDD/YYYY	Date Member details were transferred	MMDD/YYYY
Employee Retirement Age		Date of Retirement	MMDD/YYYY
Date of death	MMDD/YYYY	Cause of Death	
Area Code			

At the bottom right of the window are "Ok" and "Cancel" buttons.

#### **Date Member became Contributory**

*Date Format; Optional*

Enter the date on which the investment account was created, i.e., the date on which the investor made the first contribution towards the retirement plan.

**Date Member details were transferred**

*Date Format; Optional*

If the retirement account was transferred from a different AMC, then specify the date of account transfer.

**Employee Retirement Age**

*Numeric; 5 Characters; Optional*

Specify the age that will be considered as retirement age for this unit holder.

**Date of Retirement**

*Date Format; Optional*

Specify the date of retirement of an investor.

**Date of Death**

*Date Format; Optional*

If the unit holder is deceased, enter the date on which the unit holder died.

**Cause of Death**

*Alphanumeric; 250 Characters; Optional*

If the investor is deceased, then specify the cause of death here.

**Area Code**

*Alphanumeric; 10 Characters; Optional*

If the unit holder is deceased, select the area code of the unit holder's residence from the available list of values. The list displays all the values maintained for the parameter AREACODE in the Parameters Maintenance.

---

**Note**

You are allowed to invoke the Member Details screen only if the client country parameter 'RETIREMENTCHK' has been set to true for your bank.

---

**3.2.22 Alternate Language Dtls Button**

You can specify the customer details and customer contact details in the desired alternate language. You can capture the alternate language details by clicking 'Alternate Language Dtls' button in the Unit Holder - Maintenance screen.

In case of individual customers the following fields are displayed:

Alternate Language Details

**Alternate Language Dtls**

First / Company Name \_\_\_\_\_ Middle Name \_\_\_\_\_  
Last Name \_\_\_\_\_ Authorized Signatory 1 \_\_\_\_\_  
Authorized Signatory 2 \_\_\_\_\_ Authorized Signatory 3 \_\_\_\_\_

**Correspondence Address**

Contact Person \_\_\_\_\_ Address Line 2 \_\_\_\_\_  
Address Line 1 \_\_\_\_\_ State \_\_\_\_\_  
City \_\_\_\_\_

**Alternate Address**

Address Line 1 \_\_\_\_\_ Address Line 2 \_\_\_\_\_  
City \_\_\_\_\_ State \_\_\_\_\_

Ok Cancel

### **Alternate Language Dtls**

#### **First/ Company Name**

*Alphanumeric; 105 Characters; Optional*

Specify the first name of the individual investor or company name for the corporate account.

#### **Middle Name**

*Alphanumeric; 105 Characters; Optional*

Specify the middle name of the individual investor in the desired alternate language.

#### **Last Name**

*Alphanumeric; 105 Characters; Optional*

Specify the last name of the individual investor in the desired alternate language.

In case of a corporate customer, you need to enter the following information instead of the investor name:

#### **Authorized Signatory 1, 2, 3**

*Alphanumeric; 70 Characters; Optional*

Specify the names of any authorized signatories that must be deemed as valid for the company in the desired alternate language.

## **Correspondence Address**

### **Address Lines 1-2**

*Alphanumeric; 105 Characters; Optional*

Specify the default postal address that is to be used for correspondence with the investor in the desired alternate language.

### **City**

*Alphanumeric; 105 Characters; Optional*

Specify the name of the city of residence of the investor in the desired alternate language.

### **State**

*Alphanumeric; 80 Characters; Optional*

Specify the state in which the city of residence of the investor is located in the desired alternate language.

## **Alternate Address**

### **Contact Person**

*Alphanumeric; 160 Characters; Optional*

Specify the name of the contact person for the company in the desired alternate language.

### **Address Lines 1-2**

*Alphanumeric; 105 Characters; Optional*

Specify the alternate postal address that is to be used for correspondence with the investor in the desired alternate language.

### **City**

*Alphanumeric; 105 Characters; Optional*

Specify the name of the city of residence of the investor in the desired alternate language.

### **State**

*Alphanumeric; 80 Characters; Optional*

Specify the state in which the city of residence of the investor is located in the desired alternate language.

### 3.2.23 Director Details Tab

You can maintain the details of boards of directors for a corporate unit holder in this tab. You can capture the details by clicking 'Director Details' tab in the Unit Holder - Maintenance screen.

Existing UH/CIF	Director ID *	Director Name	Designation	Date Of Birth	Country of Birth
<input checked="" type="checkbox"/> Yes				MM/DD/YYYY	

You can capture the following in this screen:

#### **Existing UH/CIF**

*Optional*

Indicate whether you are existing UH/CIF.

#### **Director ID**

*Alphanumeric; 12 Characters; Mandatory*

Select the director identification from the adjoining option list. This is applicable only if you are an existing UH/CIF.

#### **Director Name**

*Alphanumeric; 105 Characters; Optional*

The system displays the name of the director for the selected director ID. However, you can amend this value.

#### **Designation**

*Alphanumeric; 100 Characters; Optional*

Specify the designation.

#### **Date of Birth**

*Date Format; Optional*

Specify the date of birth.

**Country of Birth***Display*

The system displays the country of birth mapped for the UH.

**Gender***Optional*

Select the gender from the adjoining drop-down list.

**ID Type***Alphanumeric; 3 Characters; Optional*

Select the identification type of the director from the option list.

**ID Number***Alphanumeric; 50 Characters; Optional*

Specify the identification number of the director.

**Address Line 1***Alphanumeric; 105 Characters; Optional*

Specify the contact address of the director.

**Address Line 2***Alphanumeric; 105 Characters; Optional*

Specify the contact address of the director.

**City***Alphanumeric; 105 Characters; Optional*

Specify the city details.

**State***Alphanumeric; 80 Characters; Optional*

Select the state from the adjoining option list.

**Country***Alphanumeric; 3 Characters; Optional*

Select the country from the adjoining option list.

**Zip Code***Alphanumeric; 10 Characters; Optional*

Specify the zip code.

**Email***Alphanumeric; 255 Characters; Optional*

Specify the e-mail ID.

**Contact Person***Alphanumeric; 160 Characters; Optional*

Specify the contact person.

**Bank***Alphanumeric; 12 Characters; Optional*

Select the bank from the adjoining option list.

**Branch**

*Alphanumeric; 12 Characters; Optional*

Select the branch from the adjoining option list.

**Account Type**

*Alphanumeric; 1 Character; Optional*

Select the account type from the adjoining option list.

**Account Currency**

*Alphanumeric; 3 Characters; Optional*

Select the currency of the account from the adjoining option list.

**Account Number**

*Alphanumeric; 20 Characters; Optional*

Specify the account number.

**Account Name**

*Alphanumeric; 105 Characters; Optional*

Specify the name in the account.

**IBAN**

*Alphanumeric; 40 Characters; Optional*

Specify the IBAN number.

**Country of Domicile**

*Alphanumeric; 3 Characters; Optional*

Select the country of domicile from the adjoining option list.

**Percentage Holding**

*Numeric; 5 Characters; Optional*

Specify the percentage of holding.

**US Indicia**

*Display*

The system defaults the US Indicia Available as Yes or No based on the existing UH/CIF maintained.

If the existing UH/CIF is Yes then the system defaults the US Indicia available.

If the existing UH/CIF is No then the system displays the US Indicia available based on the country, country of domicile, bank branch country and the director percentage of holding.

The UH will be US Indicia as Yes, if the percentage of holdings is greater than maintained for the system parameter 'FATCAMINPCNTHLDG'.

---

**Note**

For Corporate UH, if address or the country code or telephone number of the Director is maintained as US and the director percentage of holding is greater than or equal to the percentage maintained at system parameter, then the Corporate UH is marked as US indicia 'Yes'.

---



### **FATCA Classification**

*Display*

If the director selected is an existing entity in the system then system displays FATCA Classification type.

### **FATCA Status**

*Display*

If the director selected is an existing entity in the system then system displays FATCA Status based on the FATCA maintenance.

### **Controlling Person**

*Optional*

Select if the director is an active entity or not from the drop-down list. The list displays the following values:

- Yes
- No

## **3.2.24 Tax Compliance Button**

Once a new unit holder is created in the system, and on saving the unit holder; indicia checks are triggered. If Indicia are identified for the unit holder, the details are updated in 'Tax Compliance' screen. If indicia is not triggered for the unit holder created then this sub screen will be blank.

Click 'Tax Compliance' button to invoke 'Tax Compliance' screen.

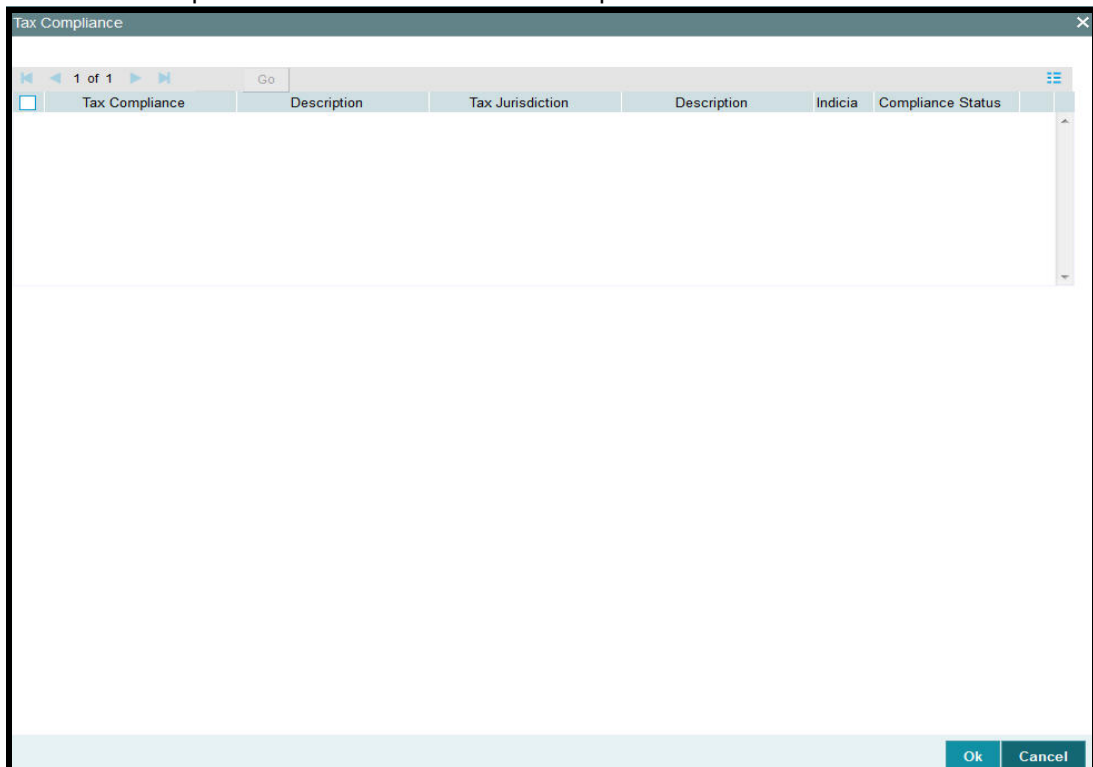

You can view the following details:

### **Tax Compliance**

*Display*

The system displays the tax compliance for which the indicia is identified.

### **Description**

*Display*

The system displays the description of the tax compliance.

### **Tax Jurisdiction**

*Display*

The system displays the country code for which indicia attributes are identified.

### **Description**

*Display*

The system displays the country name.

### **Indicia**

*Display*

The system displays the indicia value as Yes.

### **Compliance Status**

*Display*

The system displays the tax compliance status of the account for the TAX jurisdiction where indicia identified.

---

#### **Note**

If indicia is found for a unit holder then the Tax jurisdiction for indicia is identified will be updated with indicia as Yes and 'Compliance Status' field value will be set to 'Reportable'.

---

### **3.2.25 Multiple Tax Details Button**

Click 'Multiple Tax Details' button to invoke 'Multiple Tax Details' screen.

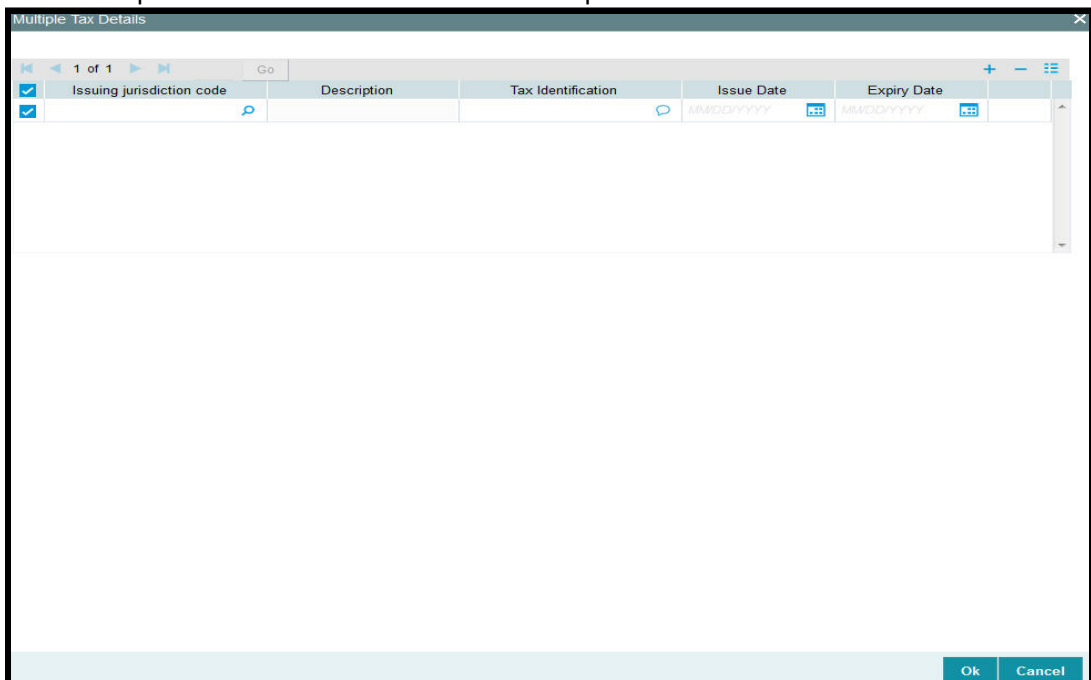

You can specify the following details:

#### **Issuing Jurisdiction Code**

*Alphanumeric; 3 Characters; Optional*

Specify the issuing jurisdiction code. Alternatively, you can select issuing jurisdiction code from the option list. The list displays all issuing jurisdiction code maintained in the system.

#### **Description**

*Display*

The system displays the description for the selected issuing jurisdiction code.

#### **Tax Identification**

*Alphanumeric; 50 Characters; Optional*

Specify the tax identification code.

#### **Issue Date**

*Date Format; Optional*

Select the issue date from the adjoining calendar.

#### **Expiry Date**

*Date Format; Optional*

Select the expiry date from the adjoining calendar.

### **3.2.26 Subscription button**

Click 'Subscription' button and the transaction detail screen for subscription transaction is displayed.

*Refer to the Processing transaction requests chapter of the Transaction User Manual for a detailed discussion of the subscription transaction detail.*

## **3.3 Unit Holder Maintenance Summary Screen**

This section contains the following topics:

- [Section 3.3.1, "Retrieving Unitholder Account"](#)
- [Section 3.3.2, "Editing New Accounts"](#)
- [Section 3.3.3, "Modifying Account through Editing"](#)
- [Section 3.3.4, "Viewing New Accounts"](#)
- [Section 3.3.5, "Deleting New Accounts"](#)
- [Section 3.3.6, "Authorizing New Account"](#)
- [Section 3.3.7, "Amending Authorized Account through Information Change"](#)
- [Section 3.3.8, "Authorizing Amended Unitholder Accounts"](#)

### 3.3.1 Retrieving Unitholder Account

Invoke the 'Unit Holder Maintenance Summary' screen by typing 'UTSUH/ UTSFH' in the field at the top right corner of the Application tool bar and clicking on the adjoining arrow button.

The screenshot shows the 'Unit Holder Maintenance Summary' application window. It features a search form at the top with the following fields: CF Number, Reference Number, First Name, Tax ID, Last Name, Auth Rep ID, Segment ID, Unit Holder ID, IdentificationNumber, Investor Type, Middle Name, Stop Account, and A/C Opening Date. Below the search form is a table with the following columns: Name, Last Name, Stop Account, Auth Rep ID, AMC ID, Address Line 1, Type Closed, Country Of Domicile, Place of Issue, Identification Type, A/C Opening Date, and Segment ID. The table is currently empty. At the bottom of the screen, there are buttons for Authorize, Delete, Find UH, Override, and Exit.

You can retrieve a previously entered record in the Unitholder Summary screen, as follows:

- Specify any or all of the following details in the Unitholder Summary screen:
  - The status of the record in the Authorization Status field. If you choose the “Blank Space” option, then all the records that involve the specified unit holder are retrieved.
  - The status of the record in the Open field. If you choose the “Blank Space” option, then all the records that involve the specified unit holder are retrieved.
  - CIF Number
  - Reference Number
  - First Name
  - Tax ID
  - Last Name
  - Auth Rep ID
  - Unit Holder ID
  - IdentificationNumber
  - Investor Type
  - Middle Name
  - Stop Account
  - A/C Opening Date

- Segment ID
- Click 'Search' button to view the records. All records with the specified details are retrieved and displayed in the lower portion of the screen.

---

**Note**

You can also retrieve the individual record detail from the detail screen by doing query in the following manner:

- Press F7
  - Input the Unit Holder ID
  - Press F8
- 

You can perform Edit, Delete, Amend, Authorize, Reverse, Confirm operation by selecting from the Action list.

You can also search the record by using combination of % and alphanumeric value.

**Example**

You can search the record for Unit Holder ID by using the combination of % and alphanumeric value as follows:

- Search by A%: System will fetch all the records whose Unit Holder ID starts from Alphabet 'A'. For Example: AGC17, AGVO6, AGC74 and so forth.
- Search by %7: System will fetch all the records whose Unit Holder ID ends by numeric value '7'. For Example: AGC17, GSD267, AGC77 and so forth.
- Search by %17%: System will fetch all the records whose Unit Holder ID contains the numeric value 17. For Example: GSD217, GSD172, AGC17 and so forth.

### **3.3.2 Editing New Accounts**

You can modify the details of Unitholder parameters that you have already entered into the system, provided it has not been subsequently authorized. You can perform this operation as follows:

- Invoke the UNITHOLDER Summary screen from the Browser.
- Select the status of the record that you want to retrieve for modification in the Authorized field. You can only modify records that are unauthorized. Accordingly, choose the Unauthorized option.
- Specify any or all of the details in the corresponding fields to retrieve the record that is to be modified. All unauthorized records with the specified details are retrieved and displayed in the lower portion of the screen.
- Double click the record that you want to modify in the list of displayed record. The UNITHOLDER Detail screen is displayed.
- Select Unlock Operation from Action list to modify the record. Modify the necessary information.
- Click Save to save your changes. The Unitholder Detail screen is closed and the changes made are reflected in the Unitholder Summary screen.

### **3.3.3 Modifying Account through Editing**

When you retrieve a unit holder account for the purpose of editing, it is displayed in the Unit holder Maintenance Detail screen, in edit mode. All the non-editable field values are displayed as labels, while the editable fields are enabled for data entry changes.

---

**Note**

If you change a previously designated individual investor to a corporate investor, all the details specific to individual investors that you had specified earlier will be lost, and cannot be retrieved, or vice versa.

---

When you save the changes you make, the system saves the changed record into the database, with the same unit holder ID. No new ID is generated.

You can edit a unit holder account as many times as necessary before you authorize it.

### **3.3.4 Viewing New Accounts**

To view a record that you have previously entered, you must retrieve the same in the Unitholder Summary screen, as follows:

- Invoke the Unitholder Summary Screen from the Browser.
- Select the status of the record that you want to retrieve for viewing in the Authorization Status field. You can also view all records that are either unauthorized or authorized only, by choosing the Unauthorized/ Authorized option.
- Specify any or all of the details of the record in the corresponding fields on the screen, and click 'Search' button. All records with the specified details are retrieved and displayed in the lower portion of the screen.
- Double click the record that you want to view in the list of displayed records. The Unitholder Detail screen is displayed in View mode.

### **3.3.5 Deleting New Accounts**

You can delete only unauthorized records in the system. To delete a record that you have previously entered:

- Invoke the Unitholder Summary screen from the Browser.
- Select the status of the record that you want to retrieve for deletion.
- Specify any or all of the details and click 'Search' button. All records with the specified details are retrieved and displayed in the lower portion of the screen.
- Double click the record that you want to delete. The Unitholder Detail screen is displayed.
- Select Delete operation from the Action list. The system prompts you to confirm the deletion, and the record is deleted physically from the system database.

### **3.3.6 Authorizing New Account**

An unauthorized unitholder record must be authorized in the system for it to be processed. To authorize a record:

- Invoke the Unitholder Summary screen from the Browser.
- Select the status of the record that you want to retrieve for authorization. Typically, choose the Unauthorized option.
- Specify any or all of the details of the record in the corresponding fields on the screen. Click 'Search' button. All record with the specified details that are pending authorization are retrieved and displayed in the lower portion of the screen.
- Double click the transaction that you wish to authorize. The Unitholder Detail screen is displayed. Select Authorize operation from Action.

When the checker authorizes a transaction, details of validations, if any, that were overridden by the maker of the transaction during the Save operation, are displayed. If any of these overrides results in an error, the checker must reject the transaction. You can authorize more than one account at a time.

### **3.3.6.1 Information Change**

The event of making changes to an authorized unit holder account is known as an information change in the system. A unit holder account that has undergone an information change in this manner is reverted back to the unauthorized status, with the changed information, in the database. You must authorize the information change by subsequently authorizing the changed account, for the changed information to be effectively reflected in the system database.

Consider the following example:

You have created an individual unit holder account in the system for Mr. Philip Green, identifying Messrs. ABF Finance as the designated intermediary. At the time of creation, the system saved the account with the unit holder ID generated as 700700000034.

Subsequently, this account number 700700000034 was authorized by the Supervisor user (or a user other than you, who has authorization rights in the user profile).

After this, Mr. Philip requested that the designated intermediary on his account be changed to Far Eastern Finance.

You will perform an information change to the account 700700000034, through the UNITHOLDER SUMMARY screen, and change the intermediary to Far Eastern Finance, and save your changes.

The system now maintains the status of the account number 700700000034, unit holder Mr. Philip Green, as an unauthorized account with the designated intermediary as Far Eastern Finance.

Now, the Supervisor user must authorize the information change that you made to account 700700000034 in the UH Info Change Summary field, for it to be reflected as an authorized record in the database.

### **3.3.7 Amending Authorized Account through Information Change**

After a unitholder record is authorized, it can be modified using the Unlock operation from Action list. To make changes to a transaction after authorization:

- Invoke the Unitholder Summary screen from the Browser.
- Select the status of the record that you wish to retrieve for amendment. You can only amend only authorized records.
- Specify any or all of the details of the Unitholder in the screen. All records with the specified details are retrieved and displayed in the lower portion of the screen.
- Double click the record that you want to amend. The Unitholder Detail screen is displayed in Amendment mode. Click the Unlock operation from the Action list to amend the record.
- Amend the necessary information. Click the Save button to save the changes.

When you retrieve a unit holder account for the purpose of making an information change, it is displayed in the Unit Holder Maintenance Detail screen, in Amend mode. All the non-editable field values are displayed as labels, while the editable fields are enabled for data entry changes.

### 3.3.8 Authorizing Amended Unitholder Accounts

An amended Unitholder record must be authorized for the amendment to be made effective in the system. The authorization of amended records can only be done from Fund Manager Module and Agency branch Module.

The process of authorization is subsequently the same as that for normal transactions.

During an information change, you can allow the check writing facility for an investor. If already allowed, you can disallow it through an information change. If the check writing facility is disallowed, any checks presented after the information change has been authorized will not be processed.

If you need to make changes to the signatories for check writing that have been specified for an investor, you can do so through an information change.

## 3.4 Unit Holder Find Options

This section contains the following topic:

- [Section 3.4.1, "Invoking Unit Holder Find Options Screen"](#)

### 3.4.1 Invoking Unit Holder Find Options Screen

You can invoke this screen by typing 'UTCUHFND' in the field at the top right corner of the Application tool bar and clicking on the adjoining arrow button. The screen is displayed below:

**UnitHolder Find Options**

**Quick Find Options**

Unit Holder ID	_____	First Name	_____
Reference Number	_____	Last Name	_____
CIF Number	_____	Middle Name	_____
Auth Rep ID	_____	Date Of Birth	_____

**Advanced Find Options**

Auth Status	Both	Investor Type	Both
A/C Opening From Date	_____	Category	_____
A/C Opening To Date	_____	Corporation Type	_____
Country Of Domicile	_____	A/C Operation Type	Not Selected
Occupation	_____	Investment Type	_____
Joint UnitHolder Name	_____	US Indicia Available	Not Selected
Signatory Name	_____	Stop Account	Not Selected

**Find Results**

1 of 1

<input type="checkbox"/>	CIF Number	Unit Holder ID	Identification Number	Reference Number	Unit Holder Name	Address
--------------------------	------------	----------------	-----------------------	------------------	------------------	---------



You can specify the following details:

### **Quick Find Options**

#### **Unit Holder ID**

*Alphanumeric; 12 Characters; Optional*

Specify the unit holder ID.

#### **Reference Number**

*Alphanumeric; 12 Characters; Optional*

Specify the reference number.

#### **CIF Number**

*Alphanumeric; 12 Characters; Optional*

Specify the CIF number.

#### **Auth Rep ID**

*Alphanumeric; 12 Characters; Optional*

Specify the auth rep ID.

#### **First Name**

*Alphanumeric; 100 Characters; Optional*

Specify the first name.

#### **Last Name**

*Alphanumeric; 40 Characters; Optional*

Specify the last name.

#### **Middle Name**

*Alphanumeric; 40 Characters; Optional*

Specify the middle name.

#### **Date Of Birth**

*Date Format; Optional*

Specify the date of birth.

#### **Tax ID**

*Alphanumeric; 50 Characters; Optional*

Specify the tax ID.

#### **Identification Type**

*Alphanumeric; 3 Characters; Optional*

Specify the identification type.

#### **Identification Number**

*Alphanumeric; 50 Characters; Optional*

Specify the identification number.

### **Advanced Find Options**

#### **Auth Status**

*Optional*

Select the authorization status and the default value been displayed as both. The list displays the following values:

- Authorized
- Unauthorized
- Both

**A/C Opening From Date**

*Date Format; Optional*

Specify the account opening from date.

**A/C Opening To Date**

*Date Format; Optional*

Specify the account opening to date.

**Country Of Domicile**

*Alphanumeric; 3 Characters; Optional*

Specify the country of domicile details.

**Occupation**

*Alphanumeric; 3 Characters; Optional*

Specify the occupation.

**Joint UnitHolder Name**

*Alphanumeric; 60 Characters; Optional*

Specify the joint unit holder name.

**Signatory Name**

*Alphanumeric; 70 Characters; Optional*

Specify the signatory name.

**Investor Type**

*Optional*

Select the investor type from the drop-down list and the default value been displayed as Both. The list displays the following values:

- Individual
- Corporate
- Both

**Category**

*Alphanumeric; 2 Characters; Optional*

Specify the category details.

**Corporation Type**

*Alphanumeric; 3 Characters; Optional*

Specify the corporation type.

**A/C Operation Type**

*Optional*

Select the account operation type. The default value that has been displayed as Not Selected. The list displays the following values:

- Single
- Joint
- Either/Survivor

**Investment Type**

*Alphanumeric; 2 Characters; Optional*

Specify the investment type.

**US Indicia Available**

*Optional*

Select if US Indicia is available or not from the drop-down list and the default value been displayed as Not Selected. The list displays the following values:

- Yes
- No

**Stop Account**

*Optional*

Select if account has to be stopped or not from the drop-down list and the stop account by default is Not Selected. The list displays the following values:

- Yes
- No

**AMC ID**

*Alphanumeric; 12 Characters; Optional*

Specify the AMC ID.

**Module ID**

*Alphanumeric; 30 Characters; Optional*

Specify the module ID.

**Find Type**

*Optional*

Select the find type from the drop-down list and the default value been displayed as Not Selected. The list displays the following values:

- Local
- Global

**Account Number**

*Alphanumeric; 16 Characters; Optional*

Specify the account number.

**IBAN**

*Alphanumeric; 40 Characters; Optional*

Specify the IBAN number.

**Broker**

*Alphanumeric; 12 Characters; Optional*

Specify the broker code.

After specifying the necessary details, click 'Find' button. The system displays the following values:

- CIF Number
- Unit Holder ID
- Identification Number
- Reference Number

- Unit Holder Name
- Address
- Investor Type
- Status
- Type Closed

## 3.5 UH Category Parameter Screen

This section contains the following topic:

- [Section 3.5.1, "Invoking UH Category Parameter Screen"](#)

### 3.5.1 Invoking UH Category Parameter Screen

An investor account can be closed automatically if the accounts remain inactive without any transactions being processed for a defined period of time. The status of the investor accounts will be changed from Active to Inactive/close automatically after the defined period.

You can define the maximum number of calendar days a user can remain inactive in the system using the 'UH Category Parameter' screen. You can invoke this screen by typing 'UTDUHPRD' in the field at the top right corner of the Application tool bar and clicking on the adjoining arrow button. The screen is displayed below:

#### **UH Category**

*Alphanumeric; 2 Characters; Mandatory*

Select the unit holder category from the adjoining option list. The option list displays all the valid UH categories maintained in the system.

#### **Category Description**

*Display*

The system displays the description for the selected UH category code.

**Inactive**

*Numeric; 5 Characters; Mandatory*

Specify the number of days an investor belongs to the specified UH category can remain inactive in the system.

**Reminder Period**

*Numeric; 5 Characters; Mandatory*

Specify the number of calendar days the system should log a warning message, before actually closing the account.

The warning message is logged into the system based on the following:

Units balance = zero

(Maximum Inactive period limit – Reminder Period) >= (App Date – Last transaction Date for the unit holder)

All the unit holder accounts that violating the criteria maintained in this screen will be closed automatically while executing the 'Automatic Account Closure of Inactive Unit holders' batch,

## **3.6 UH Category Parameter Summary Screen**

This section contains the following topics:

- [Section 3.6.1, "Retrieving UH Category Parameter"](#)
- [Section 3.6.2, "Editing UH Category Parameter Details"](#)
- [Section 3.6.3, "Deleting UH Category Parameter Details"](#)
- [Section 3.6.4, "Authorizing UH Category Parameter Details"](#)

### **3.6.1 Retrieving UH Category Parameter**

After entering the details in the 'UH Category Parameter' screen, another user must authorize it so that it would be effective in the system.

You can edit the transaction any number of times before authorization. You can also delete the content maintained.

After authorization, you can only make changes to the transaction.

The 'UH Category Parameter Summary' screen can be used for the following operations:

- Retrieving unauthorized record
- Editing unauthorized record
- Deleting unauthorized record
- Authorizing unauthorized record

You can invoke the 'UH Category Parameter Summary' screen by typing 'UTSUHPRD' in the field at the top right corner of the Application tool bar and clicking on the adjoining arrow button.

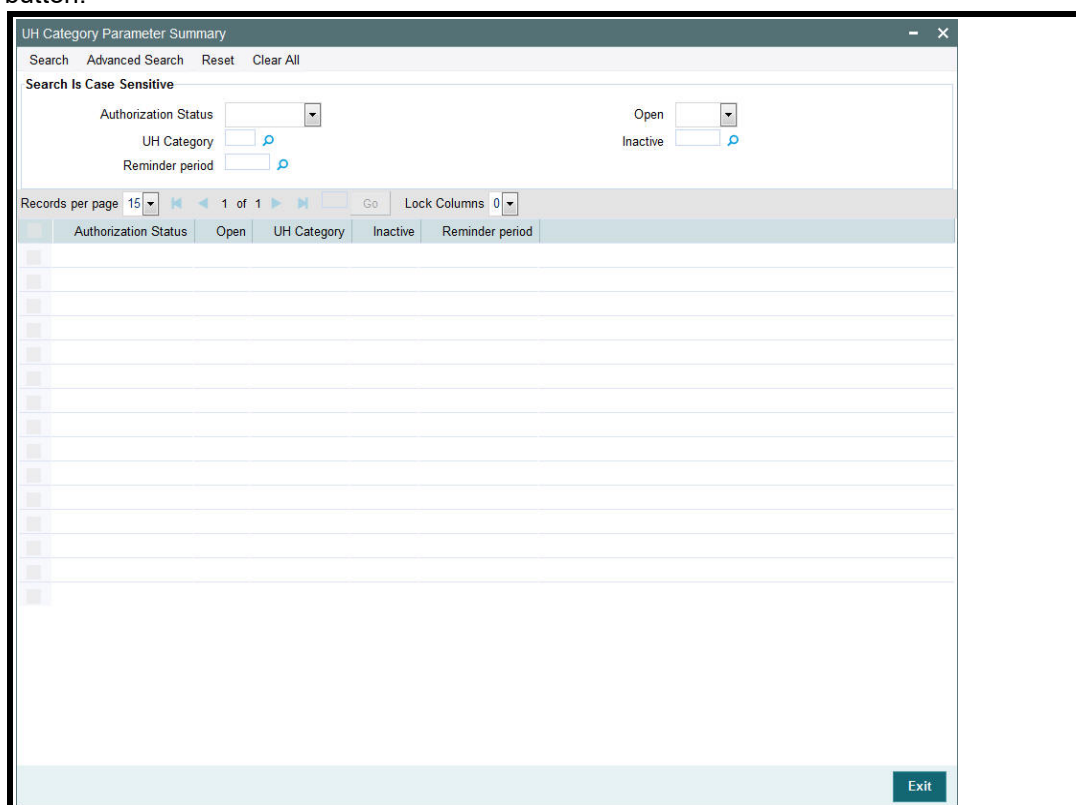

You can retrieve/view the UH category parameter details as follows:

- Specify any or all of the following details in the screen:
  - The status of the transaction in the 'Authorization Status' field. If you choose the blank space, then both the authorized and the unauthorized status records will be retrieved for the specified criteria.
  - The status of the records in the 'Open field. If you choose the blank space, then all the records are retrieved.
  - The category of the unit holder in 'UH Category' field. If you choose the blank space, then all the records are retrieved.
  - The inactive period of the investor account in 'Inactive' field. If you choose the blank space, then all the records are retrieved.
  - The reminder period of the investor account in 'Reminder Period' field. If you choose the blank space, then all the records are retrieved.
- Click 'Search' button to view the records. All records with the specified details are retrieved and displayed in the lower portion of the screen.
- Double click the record that you want to view in the list of displayed records. The 'UH Category Parameter' screen is displayed.

### 3.6.2 Editing UH Category Parameter Details

You can modify the details that you have already entered into the system, provided it has not been subsequently authorized. You can perform this operation as follows:

- Invoke the 'UH Category Parameter Summary' screen from the Browser.

- Specify any or all of the following details in the screen:
  - The status of the transaction in the 'Authorized' field. If you choose the blank space, then both the authorized and the unauthorized status records will be retrieved for the specified criteria.
  - The status of the records in the 'Open' field. If you choose the blank space, then all the records are retrieved.
  - The category of the unit holder. If you choose the blank space, then all the records are retrieved.
  - The inactive period of the investor account. If you choose the blank space, then all the records are retrieved.
  - The reminder period of the investor account. If you choose the blank space, then all the records are retrieved.
- Click 'Search' button to view the records. All records with the specified details are retrieved and displayed in the lower portion of the screen.
- Double click the record that you want to view in the list of displayed records. The 'UH Category Parameter' screen is displayed.
- Select Unlock operation from the Action list to modify the record. Modify the necessary information.
- Click Save to save your changes. The 'UH Category Parameter' screen is closed and the changes made are reflected in the 'UH Category Parameter Summary' screen.

### **3.6.3 Deleting UH Category Parameter Details**

You can delete only unauthorized records in the system. To delete a record that you have previously entered:

- Invoke the 'UH Category Parameter Summary' screen from the Browser.
- Specify any or all of the following details in the screen:
  - The status of the transaction in the 'Authorized' field. If you choose the blank space, then both the authorized and the unauthorized status records will be retrieved for the specified criteria.
  - The status of the records in the 'Open' field. If you choose the blank space, then all the records are retrieved.
  - The category of the unit holder. If you choose the blank space, then all the records are retrieved.
  - The inactive period of the investor account. If you choose the blank space, then all the records are retrieved.
  - The reminder period of the investor account. If you choose the blank space, then all the records are retrieved.
- Click 'Search' button to view the records. All records with the specified details are retrieved and displayed in the lower portion of the screen.
- Double click the record that you want to view in the list of displayed records. The 'UH Category Parameter' screen is displayed.
- Select Delete operation from the Action list. The system prompts you to confirm the deletion, and the record is deleted physically from the system database.

### **3.6.4 Authorizing UH Category Parameter Details**

Apart from the maker, someone else must authorize an unauthorized broker deal in the system for it to be processed. To authorize a record:

- Invoke the 'UH Category Parameter Summary' screen from the Browser.

- 'The status of the transaction in the 'Authorized' field. Choose the 'Unauthorized' status.
- Click 'Search' button to view the records. All the records with the specified details that are pending authorization are retrieved and displayed in the lower portion of the screen.
- Select the Authorization operation from the Action list to authorize the selected record.

## 3.7 Account Type Maintenance Details Screen

This section contains the following topic:

- [Section 3.7.1, "Invoking Account Type Maintenance Details Screen"](#)

### 3.7.1 Invoking Account Type Maintenance Details Screen

You can capture account type level rules/limits. You can maintain preferences for account type using 'Account Type Maintenance Details' screen. You can invoke this screen by typing 'UTDACTYP' in the field at the top right corner of the Application tool bar and clicking on the adjoining arrow button.

You can specify the following details:

#### **Account Type**

*Alphanumeric; 2 Characters; Mandatory*

Specify the account type. This adjoining option list displays all valid account type maintained in the system. You can choose the appropriate one.

#### **Account Description**

*Display*

The system displays the description for the selected account type.

#### **Effective Date**

*Date Format; Mandatory*

Specify the date from which the setup is applicable.



**Min Age In Years**

*Numeric; 3 Characters; Optional*

Specify minimum age validated during UH creation for individuals. This adjoining option list displays the minimum age in years options maintained in the system. You can choose the appropriate one.

The minimum age maintained will be validated during account creation.

**Max Age In Years**

*Numeric; 3 Characters; Optional*

Specify maximum age validated during inflow transaction for individuals. This adjoining option list displays the maximum age in years options maintained in the system. You can choose the appropriate one.

**Joined Holding Allowed**

*Optional*

Select if the joined holding is allowed or not from the adjoining drop-down list. Following are the options available:

- Yes
- No

**Non residents Allowed**

*Optional*

Select if the non residents are allowed or not from the adjoining drop-down list. Following are the options available:

- Yes
- No

**Investor Type**

*Optional*

Select the investor type from the drop-down list. The list displays the following values:

- Individual
- Corporate
- Both

**Details****Investor Type**

*Optional*

Select the investor type from the drop-down list. The list displays the following values:

- Individual
- Corporate

**From Date**

*Date Format; Optional*

Specify from date.

**To Date**

*Date Format; Optional*

Specify to date.

The investment amounts maintained here will be validated against the total investment made using this account type between From and To date.

Once this account is created, you will not be able to open another account with same account type under CIF within the From and To date range.

However, you can map to another joint account, either, secondary or third holder.

This field will be validated only for first holder.

### **Currency**

*Alphanumeric; 3 Characters; Optional*

Specify the currency details. This adjoining option list displays the valid currency code maintained in the system. You can choose the appropriate one.

### **Min Inv Amt**

*Alphanumeric; 30 Characters; Optional*

Specify minimum investment amount validated during inflow transactions applicable for date range between from and to date.

### **Max Inv Amt**

*Alphanumeric; 30 Characters; Optional*

Specify maximum investment amount validated during inflow transactions applicable for date range between from and to date.

### **Min RSP Amount**

*Alphanumeric; 30 Characters; Optional*

Specify minimum RSP amount validated during RSP transactions applicable for date range between from and to date.

### **No of Accounts Permitted**

*Numeric; 22 Characters; Optional*

Specify the number of accounts that can be opened between from and to date range.

Select one of the following options to select if ref type should be included or not:

- Exclude
- Include

## **Applicable Inflow and Outflow Ref Types**

### **Transaction Type**

*Alphanumeric; 2 Characters; Mandatory*

Specify the transaction type to be considered for limit check. This adjoining option list displays the valid transaction type maintained in the system. You can choose the appropriate one.

### **Transaction Type Description**

*Display*

The system displays the description for the selected transaction type.

### **Ref Type**

*Alphanumeric; 2 Characters; Mandatory*

Specify the ref type to be considered for limit check. This adjoining option list displays the valid ref type maintained in the system. You can choose the appropriate one.

## Ref Type Description

### Display

The system displays the description for the selected ref type.

## 3.8 Account Type Maintenance Summary Screen

You can perform following operations in this screen:

- [Section 3.8.1, "Retrieving Account Type in Account Type Maintenance Summary Screen"](#)
- [Section 3.8.2, "Editing Account Type Record"](#)
- [Section 3.8.3, "Viewing Account Type Record"](#)
- [Section 3.8.4, "Deleting Account Type Record"](#)
- [Section 3.8.5, "Authorizing Account Type Record"](#)
- [Section 3.8.6, "Amending Account Type Record"](#)

### 3.8.1 Retrieving Account Type in Account Type Maintenance Summary Screen

You can retrieve a previously entered record in the Summary Screen, as follows:

Invoke the 'Account Type Maintenance Summary' screen by typing 'UTSACTYP' in the field at the top right corner of the Application tool bar and clicking on the adjoining arrow button.

Account Type Maintenance Summary

Search Advanced Search Reset Clear All

Search Is Case Sensitive

Authorization Status  Open

Account Type  Effective Date

Joint Holding Allowed  Non Residents Allowed

Investor Type

Records per page 15 1 of 1 Go Lock Columns 0

Authorization Status	Open	Account Type	Effective Date	Joint Holding Allowed	Non Residents Allowed	Min Age In Years	Max Age
----------------------	------	--------------	----------------	-----------------------	-----------------------	------------------	---------

View Changes

Exit

Specify any or all of the following details in the corresponding fields:

- The status of the record in the Authorization Status field. If you choose the 'Blank Space' option, then all the records are retrieved.

- The status of the record in the Open field. If you choose the “Blank Space” option, then all the records that involve the specified unit holder are retrieved.
- Account Type
- Effective Date
- Joint Holding Allowed
- Non Residents Allowed
- Investor Type

Click ‘Search’ button to view the records. All the records with the specified details are retrieved and displayed in the lower portion of the screen.

---

#### **Note**

You can also retrieve the individual record detail from the detail screen by querying in the following manner:

- Press F7
  - Input the Account Type
  - Press F8
- 

You can perform Edit, Delete, Amend, Authorize, Confirm operations by selecting the operation from the Action list. You can also search a record by using a combination of % and alphanumeric value.

#### **Example**

You can search the record for Account Type by using the combination of % and alphanumeric value as follows:

- Search by A%: The system will fetch all the records whose Account Type starts from Alphabet ‘A’. For example, AGC17, AGVO6, AGC74 and so forth.
- Search by %7: The system will fetch all the records whose Account Type ends by numeric value ‘7’. For example, AGC17, GSD267, AGC77 and so forth.
- Search by %17%: The system will fetch all the records whose Account Type contains the numeric value 17. For example, GSD217, GSD172, AGC17 and so forth

### **3.8.2 Editing Account Type Record**

You can modify the details of a account type that you have already entered into the system, provided it has not been subsequently authorized. You can perform this operation as follows:

- Invoke the ‘Account Type Maintenance Summary’ screen from the Browser.
- Select the status of the record that you want to retrieve for modification in the Authorized field. You can only modify records that are unauthorized. Accordingly, choose the unauthorized option.
- Specify any or all of the details in the corresponding fields to retrieve the record that is to be modified.
- Click ‘Search’ button. All unauthorized records with the specified details are retrieved and displayed in the lower portion of the screen.
- Double click the record that you want to modify in the list of displayed records. The ‘Account Type Maintenance Detail’ screen is displayed.
- Select Unlock Operation from the Action list to modify the record. Modify the necessary information.

- Click Save to save your changes. The 'Account Type Maintenance Summary' screen is closed and the changes made are reflected in the 'Account Type Maintenance Summary' screen.

### **3.8.3 Viewing Account Type Record**

To view a record that you have previously input, you must retrieve the same in the 'Account Type Maintenance Summary' screen as follows:

- Invoke the 'Account Type Maintenance Summary' screen from the Browser.
- Select the status of the record that you want to retrieve for viewing in the Authorization Status field.
- Specify any or all of the details of the record in the corresponding fields on the screen.
- Click 'Search' button. All records with the specified fields are retrieved and displayed in the lower portion of the screen.
- Double click the record that you want to view in the list of displayed records. The 'Account Type Maintenance Detail' screen is displayed in View mode.

### **3.8.4 Deleting Account Type Record**

You can delete only unauthorized records in the system. To delete a record that you have previously entered:

- Invoke the 'Account Type Maintenance Summary' screen from the Browser.
- Select the status of the record that you want to retrieve for deletion.
- Specify any or all of the details in the corresponding fields on the screen.
- Click 'Search' button. All records with the specified fields are retrieved and displayed in the lower portion of the screen.
- Double click the record that you want to delete in the list of displayed records. The 'Account Type Maintenance Detail' screen is displayed.
- Select Delete Operation from the Action list. The system prompts you to confirm the deletion and the record is physically deleted from the system database.

### **3.8.5 Authorizing Account Type Record**

An unauthorized account type must be authorized in the system for it to be processed. To authorize a record:

- Invoke the 'Account Type Maintenance Summary' screen from the Browser.
- Select the status of the record that you want to retrieve for authorization. Typically, choose the unauthorized option.
- Specify any or all of the details in the corresponding fields on the screen.
- Click 'Search' button. All records with the specified details that are pending authorization are retrieved and displayed in the lower portion of the screen.
- Double click the record that you wish to authorize. The 'Account Type Maintenance Detail' screen is displayed. Select Authorize operation from the Action List.

When a checker authorizes a transaction, details of validation, if any, that were overridden by the maker of the transaction during the Save operation are displayed. If any of these overrides results in an error, the checker must reject the transaction.

### **3.8.6 Amending Account Type Record**

After a Account Type is authorized, it can be modified using the Unlock operation from the Action List. To make changes to a record after authorization:

- Invoke the 'Account Type Maintenance Summary' screen from the Browser.
- Select the status of the record that you want to retrieve for authorization. You can only amend authorized records.
- Specify any or all of the details in the corresponding fields on the screen.
- Click 'Search' button. All records with the specified details that are pending authorization are retrieved and displayed in the lower portion of the screen.
- Double click the record that you wish to authorize. The 'Account Type Maintenance Detail' screen is displayed in amendment mode. Select Unlock operation from the Action List to amend the record.
- Amend the necessary information and click on Save to save the changes.

## **3.9 Financial Intelligence Centre Act (FICA)**

This section contains the following topic:

- [Section 3.9.1, "Maintaining Financial Intelligence Centre Act"](#)

### **3.9.1 Maintaining Financial Intelligence Centre Act**

The Financial Intelligence Centre Act (FICA) came into full operation on 30 June 2003. FICA enforces the fund houses to produce identity to their customers. The identity can be produced based on the information given by the customer such as some identification document, residential address via utility bills or any other legal rental/ lease agreements and so forth.

The non-FICA customers are constrained to only certain transactions. Following are the list of transactions that are restricted to non-FICA customers.

#### **3.9.1.1 Subscription Transaction Rule**

As per Subscription Transaction rule, the following conditions are applied:

1. Individual subscription/purchase transaction value should not exceed 50,000 ZAR.
2. In case of recurring premiums/ debit order setups should not exceed 25,000 ZAR per year.

#### **3.9.1.2 Redemption Transaction Rule**

As per Redemption Transaction rule, the following conditions are applied.

1. If the first investment is done within a year from the redemption transaction date, then the redemption transaction will not be allowed for the non-FICA customers.
2. If the purchase transaction exceeds FICA limit 50k ZAR or any debit order captured exceeds the limit of 25k ZAR p.a., then the redemption transaction will not be allowed for the non-FICA customers.

### **3.9.1.3 Transfer Transaction Rule**

There are two transactions in the Transfer Transaction rule, namely, Transfer Out and Transfer In. As per the Transfer Transaction rule, Transfer Out follows 'Redemption Transaction Rule' and Transfer In follows 'Subscription Transaction Rule'.

During the Unit Holder Amendment, if you change the Correspondence address or the last name, the system would reset the KYC. You need to manually set it again. However, a warning message will be put up before resetting.

The following information needs to be entered in the 'KYC Dtls' in the UH Maintenance screen:

- KYC Purchase Limit
- KYC Annual Debit Order Limit

### 3.9.1.4 System Validations

Type of Transaction	System Validation
Policy Capture	<p>If Initial Investment is available within the KYC Redemption Period, then warning message will be displayed, else the conditions specified below should be checked:</p> <p>If there are any top ups exceeding the KYC Purchase Limit, warning message will be displayed.</p> <p>If there is any active Policy Premium whose annualized amount exceeds KYC Annual Debit Order Limit, then warning message will be displayed?</p>
Policy Top Up	If the client is not KYC compliant and Product is KYC applicable, Top Up Investment $\leq$ KYC Purchase Limit.
Policy SI Generation	No Validation and premium/ annuities would generate irrespective of the KYC checks.
Subscription	If client is not KYC compliant, Subscription Amount $\leq$ KYC Purchase Limit.
Switch	No Validation
Transfer	This mode will follow Redemption validation for the 'From Unit Holder' and Subscription for the 'To Unit Holder'.
Subscription Debit Order Generation	No Validation
Policy surrender	<p>If Client is KYC compliant, no validation will take place</p> <p>If Client is Not KYC Compliant and Product Level if KYC is applicable, validation is true.</p> <p>If any initial investment is applicable within the KYC Redemption period, the transaction capture is not allowed; else the following conditions will be checked:</p> <p>If the KYC Purchase Limit within KYC Redemption period exceeds the top ups, then transaction capture will not be allowed.</p> <p>If the Start Date of the new Policy Premium is within the KYC Redemption Period, and the annual amount exceeds the KYC Annual Debit Order Limit, transaction capture is not allowed.</p> <p>Pseudo switch in transactions will be ignored for validation.</p>



Type of Transaction	System Validation
Redemption	Pseudo switch transactions to be ignored for validation Flow of validations: Clients is KYC compliant – No validation Client is not KYC compliant If any Initial Investment (Identified by Transaction Sub Type) is available within the KYC Redemption Period, then a warning message will be displayed, else the conditions specified below should be checked: If there is any subscription that exceeds the KYC Purchase Limit, then a warning message will be displayed. If there is any new debit order whose annualized amount exceeds KYC Annual Debit Order Limit, then a warning message will be displayed.

**Example**

Let, KYC Purchase Limit = R 50000

KYC Annual Debit Order Limit = R 25000

KYC Redemption Period (In months) = 12

Assuming UH1 is not KYC Compliant and Product OMPR1 is KYC Applicable.

**Case 1:**

User tries to capture policy with initial investment of R 55000 for UH1 in OMPR1 – System would restrict this as it breaches the limit of R 50000

**Case 2:**

User tries to capture initial investment of R 45000 for UH1 in OMPR1 with premium amount as R 2500 per month – System would restrict this as the annualized premium amount i.e. R 2500 \* 12 = R 30000 exceeds the KYC Annual Debit Order Limit.

**Case 3:**

UH1 is KYC compliant and below are the transaction details:

Date	Transaction Type	Product	Amount
1/1/2007	Initial Investment	OMGR1	45000
1/4/2007	Top Up	OMGR1	55000

On 1<sup>st</sup> Jun 2007 user changes clients name which makes the client KYC Non compliant.

User tries to capture surrender transaction on 1/Sep/2007 for UH1 in OMPR1 for R 40000. This operation would fail as there is a Top Up transaction within the KYC Redemption Period of 12 months that breaches the limit of R 50000.

**Case 4:**

UH1 is KYC compliant and below are the transaction details:

Date	Transaction Type	Product	Amount
1/1/2007	Initial Investment	OMGR1	45000

There is a monthly premium starting from 1<sup>st</sup> Feb 2007 and ending on 1<sup>st</sup> Feb 2009 for R 3000

On 1<sup>st</sup> Jun 2007 user changes clients name which makes the client KYC Non compliant.

User tries to capture surrender transaction on 1/Sep/2007 for UH1 in OMPR1 for R 40000. This operation would fail as there is a policy premium that is captured within the KYC Redemption Period for which annualized amount is R 36000 and this exceeds the KYC Annual Debit Order Limit.

**Case 5:**

UH1 is KYC compliant and below are the transaction details:

Date	Transaction Type	Product	Amount
1/1/2006	Initial Investment	OMGR1	45000

There is a monthly premium starting from 1<sup>st</sup> Feb 2006 and ending on 1<sup>st</sup> Feb 2009 for R 3000

On 1<sup>st</sup> Jun 2007 user changes clients name which makes the client KYC Non compliant.

User tries to capture surrender transaction on 1/Sep/2007 for UH1 in OMPR1 for R 40000. This operation would be allowed as there is no Top Up or Policy Premium captured within the KYC Redemption Period i.e. 1<sup>st</sup> Sep 2006 onwards.

Basis date for the validations would be transaction date.

## 3.10 Escheatment Tracking

This section contains the following topic:

- [Section 3.10.1, "Tracking Escheatment Process"](#)

### 3.10.1 Tracking Escheatment Process

Escheatment tracking is the process by which a unit holder who is inaccessible is located. In such a case, the contact information of the unit holder does not reflect the current location, which is not known. In such a case, an Stop Code must be assigned to the unit holder account, and certain stop instructions are also placed on the account.

To assign an Stop Code for escheatment tracking, you must perform an information change on the unit holder account. In the Client Preferences section, select the appropriate Stop Code, in the Stop Code field.

The implications of assigning either an IRS Notification or an Stop Code to the account are shown below:

Account Characteristics (in Client Preferences)	Value	Inflow	Outflow	Standing Instructions status	Tax	Dividend payment
Stop code	StopCode1	Allowed	Not allowed	Paused	Based on TDS	Based on Income Distribution Setup
Stop code	StopCode2	Not allowed	Not allowed	Paused	Tax deducted	Reinvestment
IRS notification	Incorrect reporting of Tax ID	Allowed	Not allowed	---	Tax deducted	Reinvestment only
IRS Notification	Under Reporting	Allowed	Not allowed	---	Tax deducted	Reinvestment only

For an IRS Notification or an Stop Code, you must specify the date up to which the stop status on the account will prevail. The BOD process on the next business date after this date will unlock the account and revoke its frozen status.

In case of multiple stop codes mapped to the Unit Holder as per below scenario where both Forced Dividend Reinvestment and Forced Dividend Payout are 'Applicable' then Forced Dividend Reinvestment will have preference over Forced Dividend Payout:

Stop Code	Restriction
Stop Code 1	Forced Dividend Reinvestment - Applicable
Stop Code 2	Forced Dividend Payment – Applicable

In case of multiple stop codes mapped to the Unit Holder as per below scenario where both Forced Dividend Reinvestment and Forced Dividend payout are 'Not Applicable' then system will consider the UH IDS and if no UH IDS available for the UH, then system will consider the Fund:.

Stop Code	Restriction
Stop Code 1	Forced Dividend Reinvestment – Not Applicable
Stop Code 2	Forced Dividend Payment – Not Applicable

## 3.11 Export of Unit Holder Information

This section contains the following topics:

- [Section 3.11.1, "Exporting Unit Holder Account Information"](#)

### 3.11.1 Exporting Unit Holder Account Information

Oracle FLEXCUBE Investor Servicing provides interfaces that would enable export of unit holder account master information in respect of all valid unit holders in the system as on a given date, to external agencies. The interfaces facilitate the export of the following information:

- Complete and exhaustive unit holder account information for all valid unit holders as on the export date, which would comprise all fields in the New Account Detail screen
- Complete information for all valid unit holders, whose accounts have been modified and then authorized, on the export date

The implementers at your installation configure these interfaces according to your requirements. To execute these interfaces and perform the export, you can use the Online Execution of Interfaces menu item in the Batch menu.

## 3.12 KYC Chasing Details

This section contains the following topic:

- [Section 3.12.1, "Invoking KYC Chasing Details Screen"](#)

### 3.12.1 Invoking KYC Chasing Details Screen

You can override the chasing details mentioned in 'Unit Holder Maintenance – KYC Details' screen (UTDUH) using 'KYC Chasing Details' screen even when Unit Holder is at unauthorized stage. For any modification of KYC details at 'Unit Holder Maintenance' screen, the system will create a new KYC chasing details in 'KYC Chasing Detail' screen.

If any un-authorized chasing information already exists in 'KYC Chasing Detail' screen, you cannot create a new chasing information. The system will display 'Unauthorized chasing information record already exists' error message.

You can invoke this screen by typing 'UTDKYCCD' in the field at the top right corner of the Application tool bar and clicking on the adjoining arrow button.

Input by	Authorized by	DateTime	Mod No	Open	Authorized
----------	---------------	----------	--------	------	------------

You can specify the following details:

**Unit Holder ID**

*Alphanumeric; 12 Characters; Mandatory*

Specify the unit holder ID.

Click 'Find UH' button to query unit holder ID.

**Chasing Date**

*Date Format; Mandatory*

Specify the chasing date. Chasing Date can be backdated.

**Chased By**

*Alphanumeric; 255 Characters; Mandatory*

Specify the user ID.

**Chased Method**

*Mandatory*

Select the chased method from the adjoining drop-down list. Following are the options available:

- Fax
- E-mail
- Phone

**Comments**

*Alphanumeric; 255 Characters; Optional*

Specify comments, if any.

## **3.13 KYC Chasing Summary**

This section contains the following topic:

- [Section 3.13.1, "Retrieving KYC Chasing Record in KYC Chasing Summary Screen"](#)
- [Section 3.13.2, "Editing KYC Chasing Record"](#)
- [Section 3.13.3, "Viewing KYC Chasing Record"](#)
- [Section 3.13.4, "Deleting KYC Chasing Record"](#)
- [Section 3.13.5, "Authorizing KYC Chasing Record"](#)
- [Section 3.13.6, "Amending KYC Chasing Record"](#)
- [Section 3.13.7, "Authorizing Amended KYC Chasing Record"](#)

### **3.13.1 Retrieving KYC Chasing Record in KYC Chasing Summary Screen**

You can retrieve a previously entered record in the Summary Screen, as follows:

Invoke the 'KYC Chasing Summary' screen by typing 'UTSKYCCD' in the field at the top right corner of the Application tool bar and clicking on the adjoining arrow button and specify any or all of the following details in the corresponding details.

- The status of the record in the Authorized Status field. If you choose the 'Blank Space' option, then all the records are retrieved.

- The status of the record in the Open field. If you choose the “Blank Space” option, then all the records that involve the specified unit holder are retrieved.
- Unit Holder ID

Click ‘Search’ button to view the records. All the records with the specified details are retrieved and displayed in the lower portion of the screen.

---

**Note**

You can also retrieve the individual record detail from the detail screen by querying in the following manner:

- Press F7
  - Input Unit Holder ID
  - Press F8
- 

You can perform Edit, Delete, Amend, Authorize, Reverse, Confirm operations by selecting the operation from the Action list. You can also search a record by using a combination of % and alphanumeric value.

For example:

You can search the record for Unit Holder ID by using the combination of % and alphanumeric value as follows:-

- Search by A% :- System will fetch all the records whose Unit Holder ID starts from Alphabet ‘A’. For example:- AGC17,AGVO6,AGC74 etc.
- Search by %7 :- System will fetch all the records whose Unit Holder ID ends by numeric value ‘7’. For example: AGC17, GSD267, AGC77 etc.
- Search by %17%:- System will fetch all the records whose Unit Holder ID contains the numeric value 17. For example: GSD217, GSD172, AGC17 etc.

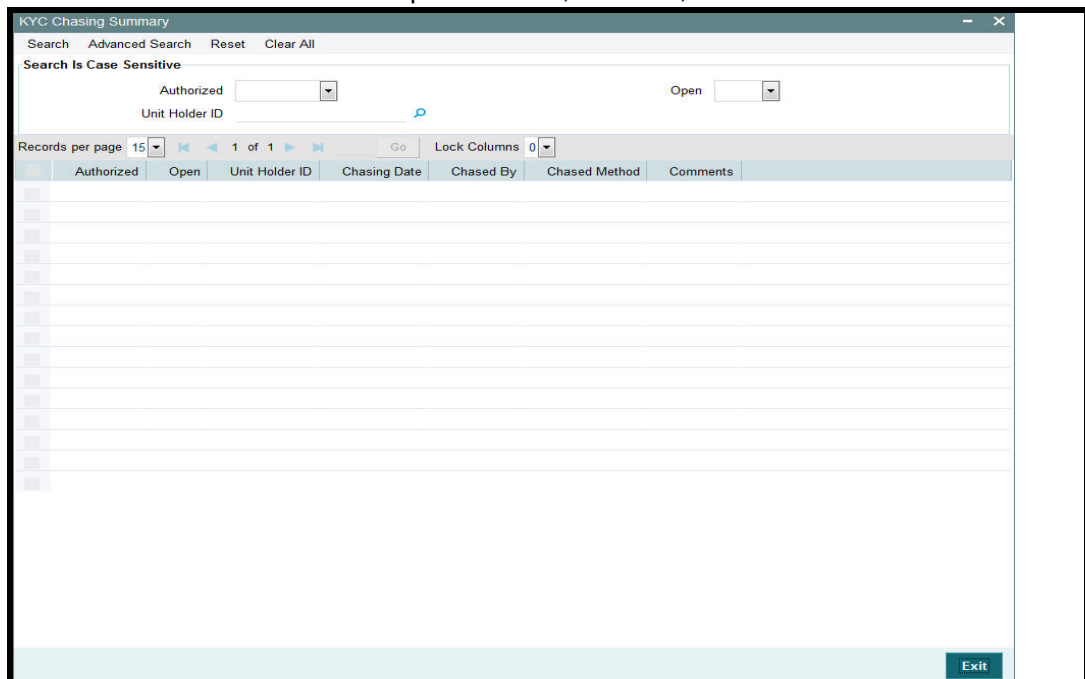

### **3.13.2 Editing KYC Chasing Record**

You can modify the details of KYC Chasing record that you have already entered into the system, provided it has not subsequently authorized. You can perform this operation as follows:

- Invoke the 'KYC Chasing Summary' screen from the Browser.
- Select the status of the record that you want to retrieve for modification in the Authorization Status field. You can only modify records that are unauthorized. Accordingly, choose the Unauthorized option.
- Specify any or all of the details in the corresponding fields to retrieve the record that is to be modified.
- Click 'Search' button. All unauthorized records with the specified details are retrieved and displayed in the lower portion of the screen.
- Double click the record that you want to modify in the list of displayed records. The KYC Chasing Detail screen is displayed.
- Select Unlock Operation from the Action list to modify the record. Modify the necessary information.

Click Save to save your changes. The KYC Chasing Detail screen is closed and the changes made are reflected in the KYC Chasing Summary screen.

### **3.13.3 Viewing KYC Chasing Record**

To view a record that you have previously input, you must retrieve the same in the KYC Chasing Summary screen as follows:

- Invoke the KYC Chasing Summary screen from the Browser.
- Select the status of the record that you want to retrieve for viewing in the Authorization Status field. You can also view all records that are either unauthorized or authorized only, by choosing the unauthorized / Authorized option.
- Specify any or all of the details of the record in the corresponding fields on the screen.
- Click 'Search' button. All records with the specified fields are retrieved and displayed in the lower portion of the screen.
- Double click the record that you want to view in the list of displayed records. The KYC Chasing Detail screen is displayed in View mode.

### **3.13.4 Deleting KYC Chasing Record**

You can delete only unauthorized records in the system. To delete a record that you have previously entered:

- Invoke the KYC Chasing Summary screen from the Browser.
- Select the status of the record that you want to retrieve for deletion.
- Specify any or all of the details in the corresponding fields on the screen.
- Click 'Search' button. All records with the specified fields are retrieved and displayed in the lower portion of the screen.
- Double click the record that you want to delete in the list of displayed records. The KYC Chasing Detail screen is displayed.
- Select Delete Operation from the Action list. The system prompts you to confirm the deletion and the record is physically deleted from the system database.

### **3.13.5 Authorizing KYC Chasing Record**

- An unauthorized KYC Chasing record must be authorized in the system for it to be processed. To authorize a record:
- Invoke the KYC Chasing Summary screen from the Browser.
- Select the status of the record that you want to retrieve for authorization. Typically, choose the unauthorized option.
- Specify any or all of the details in the corresponding fields on the screen.
- Click 'Search' button. All records with the specified details that are pending authorization are retrieved and displayed in the lower portion of the screen.
- Double click the record that you wish to authorize. The KYC Chasing Detail screen is displayed. Select Authorize operation from the Action List.

When a checker authorizes a record, details of validation, if any, that were overridden by the maker of the record during the Save operation are displayed. If any of these overrides results in an error, the checker must reject the record.

### **3.13.6 Amending KYC Chasing Record**

After a KYC Chasing record is authorized, it can be modified using the Unlock operation from the Action List. To make changes to a record after authorization:

- Invoke the KYC Chasing Summary screen from the Browser.
- Select the status of the record that you want to retrieve for authorization. You can only amend authorized records.
- Specify any or all of the details in the corresponding fields on the screen.
- Click 'Search' button. All records with the specified details that are pending authorization are retrieved and displayed in the lower portion of the screen.
- Double click the record that you wish to authorize. The KYC Chasing Detail screen is displayed in amendment mode. Select Unlock operation from the Action List to amend the record.
- Amend the necessary information and click on Save to save the changes

### **3.13.7 Authorizing Amended KYC Chasing Record**

An amended KYC Chasing record must be authorized for the amendment to be made effective in the system. The authorization of amended records can be done only from Fund Manager Module and Agency Branch module.

The subsequent process of authorization is the same as that for normal transaction

## **3.14 Unit Holder Currency of Expression**

This section contains the following topics:

- [Section 3.14.1, "Invoking Unit Holder Currency of Expression Screen"](#)

### **3.14.1 Invoking Unit Holder Currency of Expression Screen**

You can specify the currency of expression for the unit holder fund combination by selecting the fund price currency/Fund base currency as UH Currency of Expression. Uh Currency of Expression will default on authorization of Transactions of COE funds.

This maintenance is a multi grid and you can maintain multiple funds and the corresponding fund price currency as currency of expression for a unit holder.



You can invoke 'Unit Holder Currency of Expression' screen by typing 'UTDUHCOE' in the field at the top right corner of the Application tool bar and clicking on the adjoining arrow button.

You can specify the following details:

### **Unit Holder ID**

*Alphanumeric; 12 Characters; Mandatory*

Specify the unit holder ID. Alternatively, you can select unit holder ID by clicking 'Find UH' button.

### **Unit Holder Name**

*Display*

The system displays the unit holder name.

### **Fund ID**

*Alphanumeric; 6 Characters; Mandatory*

Specify the fund ID. Alternatively, you can select fund ID from the option list. The list displays all valid COE enabled fund ID maintained in the system.

Based on the Fund ID selected corresponding list of currencies will be displayed in the option list. (Fund Base Currency and Fund Price Currency for the fund selected).

### **Fund Name**

*Display*

The system displays the fund name for the selected fund ID.

## Currency of Expression

*Alphanumeric; 3 Characters; Mandatory*

Specify the currency of expression ID. Alternatively, you can select currency of expression from the option list. The list displays all valid currency of expression ID maintained in the system.

You can maintain only one currency, i.e., either Fund Base currency or any of the fund price currencies for that fund as currency of expression for a UH- Fund combination. The record can be modified or deleted post maintenance

The system will validate this while saving and displays an error message as 'Only Fund Base Currency or Fund Price Currency can be selected'.

## Currency Name

*Display*

The system displays the currency name for the selected currency of expression ID.

After maintaining the Unit holder currency of expression, if one of the FPC is removed and that currency is UHCOE for a UH, then defaulting at Transaction capture will happen but the price currency/COE logic will not happen for the fund, it will be a case where TBC≠FBC or FPC. At the UHCOE maintenance this can be operationally controlled.

---

### Note

If there is no UH Currency of Expression maintained, then the system will default a currency for the UH and Fund combination.

---

## 3.15 Unit Holder Currency of Expression Summary

This section contains the following topics:

- [Section 3.15.1, "Retrieving Unit Holder Currency of Expression Details"](#)
- [Section 3.15.2, "Editing Unit Holder Currency of Expression Details"](#)
- [Section 3.15.3, "Viewing Unit Holder Currency of Expression Details"](#)
- [Section 3.15.4, "Deleting Unit Holder Currency of Expression Details"](#)
- [Section 3.15.5, "Authorizing Unit Holder Currency of Expression Details"](#)
- [Section 3.15.6, "Amending Unit Holder Currency of Expression Details"](#)
- [Section 3.15.7, "Authorizing Amended Unit Holder Currency of Expression Details"](#)

### 3.15.1 Retrieving Unit Holder Currency of Expression Details

You can view Unit Holder balances summary using 'UH Currency of Expression' Summary screen. You can invoke this screen by typing 'UTSUHCOE' in the field at the top right corner of the Application tool bar and clicking on the adjoining arrow button.

The screenshot shows a software application window titled "UH Currency of Expression". At the top, there are search options: "Search", "Advanced Search", "Reset", and "Clear All". Below this, there is a section for search criteria with the heading "Search Is Case Sensitive". This section includes two dropdown menus labeled "Authorized" and "Open", and two text input fields labeled "Unit Holder ID" and "Unit Holder Name". Below the search criteria, there is a table with the following columns: "Authorized", "Open", "Unit Holder ID", "Unit Holder Name", "Fund ID", "Fund Name", and "Currency of Expression". The table is currently empty. At the bottom right of the window, there is an "Exit" button.

You can retrieve a previously entered record in the 'UH Currency of Expression Summary' screen, as follows:

- Specify any or all of the following details in the UH Currency of Expression Summary screen:
- The status of the transaction in the Authorized field. If you choose the "Blank Space" option, then all the transactions that involve the specified unit holder are retrieved.
- The status of the Transaction in the Open field. If you choose the "Blank Space" option, then all the transactions that involve the specified unit holder are retrieved.
- Unit Holder ID
- Unit Holder Name

Click 'Search' button to view the records. All records with the specified details are retrieved and displayed in the lower portion of the screen.

---

#### Note

You can also retrieve the individual record detail from the detail screen by doing query in the following manner:

- Press F7
  - Input the Unit Holder ID
  - Press F8
-

You can perform Edit, Delete, Amend, Authorize operation by selecting from the Action list.

You can also search the record by using combination of % and alphanumeric value.

**Example**

You can search the record for Unit Holder ID by using the combination of % and alphanumeric value as follows:

Search by A%: System will fetch all the records whose Unit Holder ID starts from Alphabet 'A'. For example: AGC17, AGVO6, AGC74 and so forth.

Search by %7: System will fetch all the records whose Unit Holder ID ends by numeric value '7'. For example: AGC17, GSD267, AGC77 and so forth.

Search by %17%: System will fetch all the records whose Unit Holder ID contains the numeric value 17. For Example: GSD217, GSD172, AGC17 and so forth.

### **3.15.2 Editing Unit Holder Currency of Expression Details**

You can modify the details of Unit Holder Currency of Expression parameters that you have already entered into the system, provided it has not been subsequently authorized. You can perform this operation as follows:

- Invoke the UH Currency of Expression Summary screen from the Browser.
- Select the status of the record that you want to retrieve for modification in the Authorization Status field. You can only modify records that are unauthorized. Accordingly, choose the Unauthorized option.
- Specify any or all of the details in the corresponding fields to retrieve the record that is to be modified. All unauthorized records with the specified details are retrieved and displayed in the lower portion of the screen.
- Double click the record that you want to modify in the list of displayed records. The Unit Holder Currency of Expression Detail screen is displayed.
- For editing, click the 'Unlock Action' at the upper left end of the required row in the result list. The selected closure record is displayed in edit mode in the 'Unit Holder Currency of Expression' detail screen. All editable value fields are enabled for modification, and the values for all non-editable fields appear as labels. Make your changes and Save the record.
- Click Save to save your changes. The Unit Holder Currency of Expression Detail screen is closed and the changes made are reflected in the UH Currency of Expression Summary screen.

### **3.15.3 Viewing Unit Holder Currency of Expression Details**

To view a record that you have previously entered, you must retrieve the same in the UH Currency of Expression Summary screen, as follows:

- Invoke the UH Currency of Expression Summary Screen from the Browser.
- Select the status of the record that you want to retrieve for viewing in the Authorization Status field. You can also view all records that are either unauthorized or authorized only, by choosing the Unauthorized / Authorized option.
- Specify any or all of the details of the record in the corresponding fields on the screen, and click 'Search' button. All records with the specified details are retrieved and displayed in the lower portion of the screen.
- Double click the record that you want to view in the list of displayed records. The Unit Holder Currency of Expression Detail screen is displayed in View mode.

### **3.15.4 Deleting Unit Holder Currency of Expression Details**

You can delete only unauthorized records in the system. To delete a record that you have previously entered:

- Invoke the UH Currency of Expression Summary screen from the Browser.
- Select the status of the record that you want to retrieve for deletion.
- Specify any or all of the details and click 'Search' button. All records with the specified details are retrieved and displayed in the lower portion of the screen.
- Double click the record that you want to delete. The Unit Holder Currency of Expression Detail screen is displayed.
- Select Delete operation from the Action list. The system prompts you to confirm the deletion, and the record is deleted physically from the system database.

### **3.15.5 Authorizing Unit Holder Currency of Expression Details**

An unauthorized Unit Holder Currency of Expression record must be authorized in the system for it to be processed. To authorize a record:

- Invoke the UH Currency of Expression Summary screen from the Browser.
- Select the status of the record that you want to retrieve for authorization. Typically, choose the Unauthorized option.
- Specify any or all of the details of the record in the corresponding fields on the screen. Click 'Search' button. All transactions with the specified details that are pending authorization are retrieved and displayed in the lower portion of the screen.
- Double click the transaction that you wish to authorize. The Unit Holder Currency of Expression Detail screen is displayed. Select Authorize operation from Action.

When the checker authorizes a transaction, details of validations, if any, that were overridden by the maker of the transaction during the Save operation, are displayed. If any of these overrides results in an error, the checker must reject the transaction.

### **3.15.6 Amending Unit Holder Currency of Expression Details**

After a Unit Holder Currency of Expression Detail record is authorized, it can be modified using the Unlock operation from Action list. To make changes to a record after authorization:

- Invoke the UH Currency of Expression Summary screen from the Browser.
- Select the status of the record that you wish to retrieve for amendment. You can only amend only authorized records.
- Specify any or all of the details of the Unit Holder Currency of Expression in the screen. All records with the specified details are retrieved and displayed in the lower portion of the screen.
- Double click the record that you want to amend. The Unit Holder Currency of Expression Detail screen is displayed in Amendment mode. Click the Unlock operation from the Action list to amend the record.
- Amend the necessary information. Click the Save button to save the changes.

### **3.15.7 Authorizing Amended Unit Holder Currency of Expression Details**

An amended Unit Holder Currency of Expression Detail record must be authorized for the amendment to be made effective in the system. The authorization of amended records can only be done from Agency branch Module.

The process of authorization is subsequently the same as that for normal transactions.

---

## 4. Setting up Investor Preferences

After you have created an authorized unit holder account for an investor, you can set up any or all of the following investment preferences for the same, as and when requested.

- Setting up of income distribution options for a combination of funds, policy and products the investor has invested in.
- Specifying the applicability of the Letter of Intent facility, at the investor's behest.
- Setting up a negotiated deal for the investor.
- Specifying non-tax- limits for exemption eligible investors.

You set up these preferences at the investor's behest, and these will govern the maintenance of the investor's account and processing aspects of any transactions requested by the investor.

This chapter contains the following sections:

- [Section 4.1, "Income Distribution Setup Screen"](#)
- [Section 4.2, "Income Distribution Setup Summary Screen"](#)
- [Section 4.3, "Unitholder Deal Maintenance Detail Screen"](#)
- [Section 4.4, "Unitholder Deal Summary Screen"](#)
- [Section 4.5, "LOI Adjust Proc Screen"](#)
- [Section 4.6, "Setting up Letter of Intent Options for Investor"](#)
- [Section 4.7, "Unit Holder LOI Setup Summary Screen"](#)
- [Section 4.8, "LOI Adjust Proc Screen"](#)
- [Section 4.9, "UH Non Tax Limits Detail Screen"](#)
- [Section 4.10, "UH Non Tax Limits Summary Screen"](#)
- [Section 4.11, "Unit Holder IRRF Preference Detail Screen"](#)
- [Section 4.12, "Unit Holder IRRF Preference Summary Screen"](#)
- [Section 4.13, "Unit Holder NPI Preference Detail Screen"](#)
- [Section 4.14, "Unit Holder NPI Preference Summary Screen"](#)
- [Section 4.15, "Fund UH Category Minimum Holding Period Details Screen"](#)
- [Section 4.16, "Fund UH Category Minimum Holding Period Summary Screen"](#)
- [Section 4.17, "UH Status Change Detail Screen"](#)
- [Section 4.18, "Unit Holder Status Change Summary Screen"](#)
- [Section 4.19, "Auth Rep Maintenance Detail Screen"](#)
- [Section 4.20, "Auth Rep Maintenance Summary"](#)
- [Section 4.21, "NotePad of Entities Detail Screen"](#)
- [Section 4.22, "NotePad of Entities Summary Screen"](#)
- [Section 4.23, "Agency Branch Account Officer Maintenance Detail"](#)
- [Section 4.24, "Agency Branch Account Officer Maintenance Summary"](#)
- [Section 4.25, "Account Officer IFA Maintenance Detail"](#)
- [Section 4.26, "Account Officer IFA Maintenance Summary"](#)
- [Section 4.27, "Agent Price Basis Detail"](#)
- [Section 4.28, "Agent Price Basis Summary"](#)
- [Section 4.29, "AMC Agent SLA Maintenance Summary"](#)
- [Section 4.30, "Tax Credit"](#)

## **4.1 Income Distribution Setup Screen**

This section contains the following topics:

- [Section 4.1.1, "Maintaining Investor Distribution Setup Details"](#)
- [Section 4.1.2, "Invoking Income Distribution Setup Screen"](#)
- [Section 4.1.3, "Payment Details Tab"](#)
- [Section 4.1.4, "Reinvestment Details Tab"](#)
- [Section 4.1.5, "Routing Details Tab"](#)

### **4.1.1 Maintaining Investor Distribution Setup Details**

When investors put their capital into any funds of the AMC, they derive earnings out of any dividend declared by the fund at any juncture.

Also, an intermediary (such as a broker) designated for a fund derives commission earnings from the transactions in the fund.

Investors may wish to choose the manner in which they could use the dividend income. Similarly, brokers could wish to choose the manner in which they could use their commission earnings.

They could wish to:

- Receive the entire earnings, dividend or commission, as payment, either entirely through checks or account transfer, or a combination of both.
- Not receive the earnings by way of payment, but invest the earnings back into the funds of the AMC. This is known as reinvestment. The earnings could be reinvested either back into the same fund, or different funds. Also, the reinvestment could be made into any other investor's account too.
- Receive a portion of the earnings by way of payment, and reinvest the remaining portion.

The option chosen by the investor to use dividend or commission earnings, as the case may be, is known as the Income Distribution Setup option or the IDS option for the investor or broker.

Income distribution options can be set up for both; UT transactions and Policy transactions. You can capture this option for any investor or broker for a combination of fund, policy and product in the Oracle FLEXCUBE Investor Servicing system.

### **4.1.2 Invoking Income Distribution Setup Screen**

You can setup the income distribution setup option for an investor using 'Income Distribution Setup Detail' screen. You can invoke the 'Income Distribution Setup Detail' screen by typing 'UTDUHIDS'/ 'UTDFHIDS' in the field at the top right corner of the Application tool bar and

clicking on the adjoining arrow button. Select 'New' from the Actions menu in the Application tool bar or click new icon to enter the details of the Income Distribution Setup screen.

In this screen, you set up the IDS option by:

- Specifying the investor for whom the option is being set up, by indicating the CIF account associated with the unit holder, or the unit holder ID.

### Note

Income distribution options are only set up at a unit holder account level, and not at a CIF account level.

- Specifying the fund for which the option is applicable, in the Fund ID field. You can also specify the ISIN Code for the fund. For LEP transactions, you can specify a combination of fund, policy and product, for which the option is applicable. The option you will set up will be applied only for dividend earnings on the fund/ combination of fund, product and policy you select here.
- Specifying the mode of distribution, in the Distribution Mode field.
- Specifying the percentages that represent the portions of dividend earnings to be paid and reinvested, as desired by the investor, in the Payment Percentage and Reinvestment Percentage fields.



- Specifying the payment details for the paid portion, in the Payment Details section, and the reinvestment details, for the reinvestment portion, in the Reinvestment Details section.
  - Saving your changes.
- 

## **Client Information**

In this section, select the ID of the unit holder for whom you are creating an income distribution setup record.

### **Unit Holder**

*Alphanumeric; 12 Characters; Mandatory*

From the list, select the CIF unit holder for whom you are creating an income distribution setup record.

### **CIF Number**

*Display*

The system displays the number of the CIF Account under which the unit CIF Number is displayed when you select/ locate a Unit Holder by clicking 'Find UH' button.

### **UH Name**

*Display*

The system displays name of the unit holder.

Click 'Find UH' button to query for unit holder details.

### **Rule Effective Date**

*Date Format; Mandatory*

Select rule effective date from the adjoining calendar.

## **Details**

In this section, you can indicate the fund, policy and product, the income earnings from which will be distributed according to the IDS options you are creating for the selected unit holder.

Various combinations at which the Unitholder IDS options can be set up, in order of preference are:

- Product + Policy + Fund level
- Product + Fund level

In case of LEP transactions, if the UH IDS is not available, the dividend earnings will be reinvested into the default reinvestment fund maintained for the product in the Product Maintenance Details screen. However, if the reinvestment fund is not defined, then the dividend is reinvested into the source fund itself.

You can also indicate the manner in which the income must be distributed.

### **Fund ID**

*Alphanumeric; 6 Characters; Mandatory*

Select the ID of the fund from which the selected investor derives income, which will be distributed according to the IDS options you are creating in this screen.

If the selected investor receives income from many funds, then you must create the IDS options for the income from each fund in this screen as applicable, if so requested by the investor.

When you specify the ID of the fund, the ISIN Code of the fund is displayed in the ISIN Code field.

### **ISIN Code**

*Display*

ISIN Code will be displayed for the selected Fund ID.

### **Product ID**

*Alphanumeric; 10 Characters; Optional*

Select the ID of product from which the investor derives income, which will be distributed according to the IDS options you are creating in this screen.

This field is not applicable if you are setting up IDS options for UT transactions.

### **Product Name**

*Display*

The system displays the name of the product for the selected product ID.

### **Policy Number**

*Alphanumeric; 16 Characters; Optional*

Select the policy from which the investor derives income, which will be distributed according to the IDS options you are creating in this screen.

This field is not applicable if you are setting up IDS options for UT transactions.

### **Distribution Mode**

*Mandatory*

From the list, indicate the manner in which the selected investor prefers to avail of income earned in the selected fund. This could be any of the following:

- **Full Payment:** Choose this option to indicate that the investor prefers to receive the entire income derived from an income distribution cycle in the selected fund as a payment.

Further, the investor can choose to avail of payment either in the form of a check, or an account transfer.

- **Full Reinvestment:** Choose this option to indicate that the investor prefers to reinvest the entire income derived from an income distribution cycle in the selected fund into another fund.

In such a case, the fund into which the earned income is reinvested must belong to the same fund family as the fund from which the income was earned.

Further, the investor can choose to have the income reinvested either in the investor's own unit holder account or the account of another investor. In the latter case, the investor in whose account the reinvestment is proposed (i.e., the Reinvestment Unit Holder) must belong to the same AMC as the source investor.

- **Both:** Choose this option to indicate that the investor prefers to have the income derived from an entire income distribution cycle in the selected fund divided into two portions, receive one portion as payment, and reinvest the remaining portion.

---

**Note**

- In some funds in which reinvestment is not allowed, according to the Corporate Action profile for the fund, the investor cannot choose to have income earnings reinvested. In such cases, this field is validated with the “Full Payment” option displayed as a non-editable default option. Also, the Payment Percentage field is locked with a default, non-editable value of one hundred percent displayed, and the Reinvestment Percentage field is locked with a default, non-editable value of zero percent displayed.
  - If you have chosen the distribution mode in this field as ‘Full Reinvestment’ or “Both”, and the reinvestment fund has a restriction on the nationality of the investor as maintained in the Fund Residency Restriction list, then reinvestment is not allowed at all.
- 

For some funds, the option of allowing the investor to decide the income distribution mode is restricted. The default distribution mode specified in the fund rules is considered for such funds, and an investor cannot decide the same at account level by making a specification in this field.

**Payment Percentage**

*Numeric; 5 Characters; Optional (Mandatory if distribution mode is either Both or Full Payment)*

Specify the percentage of income earned that the investor prefers to receive by way of payment.

- If the distribution mode chosen is Both, specify a percentage that is below one hundred percent.
- If the distribution mode chosen is Full Payment, this field contains one hundred percent as a default value. If so, you cannot specify any other value.
- If the distribution mode chosen is Full Reinvestment, and the reinvestment is disallowed for the selected fund, this field contains one hundred percent as a default value. If so, you cannot change it.

**Reinvestment Percentage**

*Display*

The system displays the percentage of income earned that the investor prefers to reinvest into another fund.

- If the distribution mode chosen is Both, the system displays a percentage that is below one hundred percent.
- If the distribution mode chosen is Full Reinvestment, this field contains one hundred percent as a default value. If so, you cannot specify any other value.
- If the distribution mode chosen is Full Reinvestment, and the reinvestment is disallowed for the selected fund, this field contains zero as a default value. If so, you cannot change it.

**Payment Currency**

*Alphanumeric; 3 Characters; Optional*

Select the currency in which the unit holder wishes the payment to be made. All currencies maintained in the system are available for selection.

In case Payment mode is transfer then the system looks for a bank account in the opted payment currency for the unit holder. If such an account does not exist, you can choose (in Transfer Details section) any multi-currency account maintained for the unit holder subject to the following conditions:

- The Distribution mode is 'Full Payment/ Both'
- Mode of Payment is 'Transfer'
- Payment Type is 'Self'

Also the fund should have a bank account in this currency. In the event of failure of any one of the two criteria an error will be displayed.

---

**Note**

The default value here would be the unit holder base currency.

---

**Currency Name***Display*

The system displays the name of the currency for the selected payment currency.

---

**Note**

If client country 'UHFUNDRESTRICT' is turned on, the system will validate

- The investor for whom income distribution setup is done (Unit Holder) must belong to the same AMC as the fund from which income is derived.
  - The investor in whose account the reinvestment is proposed (i.e., the Reinvestment Unit Holder) must belong to the same AMC as the fund from which income is derived.
- 

### 4.1.3 **Payment Details Tab**

In this section, you can define the option in which the investor can receive income earnings in the form of payment. The investor can receive the payment income either in the form of checks or through account transfers.

If you have chosen either Both or Full Payment as the distribution mode, you must specify all information in this section.

Click 'Payment Details' tab to enter the details.

**Payment Mode***Optional*

From the drop-down list, select the mode in which the investor prefers to receive the paid portion of the income earned – either in the form of a check or an account transfer. The list displays the following values:

- Cheque-Cheque
- Transfer-Transfer

**Payment Type***Optional*

From the drop-down list, indicate whether the check payment instrument must be addressed to the investor (self) or a third party. The list displays the following values:

- Self
- Third Party
- Entity

You can also indicate that the payment check must be addressed to a broker, by selecting the Entity option. If you choose this option, you must indicate the broker to which the payment must be made.

From the list, indicate whether the account transfer payment must be made to one of the investor's preferred bank accounts (self) or to the bank account of a third party. You can also indicate that the transfer payment must be made to the bank account of a designated broker, by selecting the Entity option in this field

If you select the Self option in this field, all the preferred bank accounts specified for the investor in the unit holder account are listed in the Select Bank Account field. The default designated account is displayed in the bank account fields, and will be reckoned as the account to which the transfer payment must be made. You can choose any of these preferred bank accounts, as requested by the investor.

If you select the Third Party option in this field, then you must specify the bank account details of the third party account to which the transfer must be made, in the bank account fields in this section.

If you select the Entity option, specify the broker into whose bank account the transfer payment must be made, in the Broker field.

### **Third Party Details**

---

#### **Note**

The payment of income to a third party (i.e. a bank account that is not the investor account or a check that is not in favor of the investor) can be made only if such an installation level option is available.

---

#### **Third Party Reference**

*Alphanumeric; 255 Characters; Mandatory for 'Third Party' payment*

Specify the name or reference of the third party for which the check instrument must be made out.

#### **Address**

*Alphanumeric; 255 Characters; Mandatory for 'Third Party' payment*

Specify the address of the third party for which the check instrument must be made out.

#### **City**

*Alphanumeric; 20 Characters; Mandatory for 'Third Party' payment*

Select the city of residence of the third party for which the check instrument must be made out.

#### **US State/Non-US State**

*Alphanumeric; 20 Characters; Mandatory for 'Third Party' payment*

Select the state of residence of the third party for which the check instrument must be made out, if the state is a US state.

#### **Zip Code**

*Alphanumeric; 20 Characters; Mandatory for 'Third Party' payment*

Specify the zip code of the city of residence of the third party for which the check instrument must be made out.

## **Entity Details**

### **Entity Type**

*Optional*

Select the entity type from the drop-down list. The list displays the following values:

- Broker

### **Entity ID**

*Alphanumeric; 12 Characters; Optional*

If you have indicated that the payment (check or transfer) is to be made to a broker, specify the broker in this field. The name of the selected broker is displayed in the Entity Name field.

### **Entity Name**

*Display*

The entity name will be displayed for the Entity Type selected.

## **Transfer Details**

### **Bank**

*Alphanumeric; 12 Characters; Mandatory for Self payment type*

Select the bank account to which the transfer payment of the income must be made.

The details of the account you select are displayed in the bank account details fields.

You must select a bank account for which the currency is a valid fund bank account currency so that the income payment transfer can be affected.

If the payment type is 'Self', the bank account associated with the investor is defaulted from the unit holder level.

If you have chosen 'Third Party' as the payment type, select the name of the bank in which the transfer account is present, from the drop down list.

### **Branch**

*Alphanumeric; 12 Characters; Mandatory for Third Party transfer payment*

If the payment type is 'Self', the branch associated with the investor account is defaulted from the unit holder level.

If you have chosen 'Third Party' as the payment type, Specify the branch name of the bank in which the transfer account is present.

### **A/c Type**

*Alphanumeric; 1 Character; Mandatory for Third Party transfer payment*

Select the account type (Fixed, Savings or Current) of the transfer account.

### **A/c No**

*Alphanumeric; 16 Characters; Mandatory for Third Party transfer payment*

Specify the number of the transfer account.

### **A/c Ccy**

*Alphanumeric; 3 Characters; Mandatory for Third Party transfer payment*

Specify the currency of the transfer account

The currency specified here must be a valid fund bank account currency.

### A/c Holder Name

*Alphanumeric; 100 Characters; Mandatory for Third Party transfer payment*

Specify the name of the holder of the third party account.

### IBAN

*Alphanumeric; 40 Characters; Optional*

Specify the IBAN (International Bank Account Number) of the account holder.

## 4.1.4 Reinvestment Details Tab

Click 'Reinvestment Details' tab to enter the details.

The screenshot displays the 'Income Distribution Setup Detail' window. The 'Client Information' section includes fields for 'Unit Holder \*', 'CIF Number', 'UH Name', and a 'Find UH' button. The 'Rule Effective Date \*' is set to '03/14/2016'. The 'DETAILS' section contains fields for 'Fund ID \*', 'Product ID', 'Policy Number', 'ISIN Code', 'Product Name', 'Distribution Mode \*', 'Payment Percentage', 'Payment Currency', 'Reinvestment Percentage', and 'Currency Name'. Below these fields are tabs for 'Payment Details', 'Reinvestment Details', and 'Routing Details'. The 'Reinvestment Details' tab is active, showing a table with the following columns: 'Reinvestment Unit Holder ID \*', 'Reinvestment Unit Holder Name', 'Reinvestment Fund ID \*', and 'Split Percentage \*'. The table has one row with a blue checkmark in the first column. The bottom of the window features a status bar with fields for 'Input by', 'Authorized by', 'DateTime', 'Mod No', 'Open', and 'Authorized', and a 'Cancel' button.

### Reinvestment Unit Holder ID

*Alphanumeric; 12 Characters; Mandatory*

Specify the ID of the unit holder in whose account the income is to be reinvested. When you select the ID of the reinvestment unit holder, the name of the unit holder is displayed in the Reinvestment Unit Holder Name field.

### Reinvestment Unit Holder Name

*Display*

The system displays the reinvestment unit holder name for the selected reinvestment unit holder ID.

## Reinvestment Fund ID

*Alphanumeric; 6 Characters; Mandatory*

Select the ID of the fund in which the income is to be reinvested. The fund that you select here should be part of the same fund family as the fund from which the income was derived.

## Split Percentage

*Numeric; 5 Characters; Mandatory*

Specify the percentage of the derived income that is to be reinvested in the specified reinvestment unit holder's account, in the specified reinvestment fund. You can make any number of such entries, specifying a percentage for each combination. The sum total of all split percentages for all reinvestment unit holder – reinvestment fund ID combinations you have specified must be equal to one hundred percent.

In this section, you can define the option in which the investor can reinvest income earnings from the selected fund. The investor can reinvest earned income in any of the following ways:

- Reinvest either in the investor's own unit holder account, or another investor's account. In the latter case, the investor in whose account the reinvestment is proposed (that is, the Reinvestment Unit Holder) must belong to the same AMC as the source investor.
- Reinvest the income in any other fund. If the investor desires to do this, the reinvestment fund must belong to the same fund family as the fund from which the income is derived.
- Reinvest the income in as many target fund/unit holder combinations, subject to the constraints expressed above. This is again subject to the consideration that the sum of the percentages of reinvestment in all these combinations must be equal to 100.

---

### Note

Reinvestment is only allowed into or out of a fund if so designated in the Corporate Actions profile for the fund and corporate action type.

---

If you have chosen either Both or Full Reinvestment as the distribution mode, you must specify all information in this section mandatory.

---

### Note

In GTA setup and in Reinvestment Case:

In AGY without cross branching, Fund ID and Reinvestment Fund ID fields can have funds selected only within same segment. Unitholder ID and Reinvestment Unitholder ID fields can have UH selected only within same segment.

In AGY with cross branching, Fund ID and Reinvestment Fund ID fields can have funds selected across segments. Unitholder ID and Reinvestment Unitholder ID fields can have UH selected only within same segment.

---



## 4.1.5 Routing Details Tab

FCIS provides the option to capture the bank routing details. At the time of transaction input, the routing details specified here are picked up for the combination of fund, transaction type and transaction currency. You can specify the routing details by clicking on 'Routing Details'.

The screenshot shows the 'Income Distribution Setup Detail' window with the 'Routing Details' tab selected. The form is divided into several sections:

- Client Information:** Unit Holder \*, CIF Number, UH Name, and a 'Find UH' button.
- DETAILS:** Rule Effective Date \* (03/14/2016), Fund ID \*, Product ID, Policy Number, Distribution Mode \* (dropdown), Payment Percentage, Payment Currency, Reinvestment Percentage, and Currency Name.
- Payment Details:** Swift Format and Bank Charged.
- Beneficiary Details:** Beneficiary, Beneficiary Add1, Add2, Add3, Beneficiary BIC Code, Beneficiary Acct No, Beneficiary Code, Beneficiary Info, and Beneficiary IBAN.
- Intermediary Details:** Intermediary, Intermediary Add1, Intermediary BIC Code, and Intermediary Acct No.

At the bottom, there are fields for 'Input by', 'Authorized by', 'DateTime', 'Mod No', 'Open', and 'Authorized', along with a 'Cancel' button.

You need to maintain the following details:

### Swift Format

*Optional*

At the time of transaction input, the routing details specified here are picked up for the combination of fund, transaction type and transaction currency. The drop-down list displays the following values:

- MT103
- MT202

### Bank Charged

*Optional*

Indicate whether the bank charges must be levied upon the beneficiary, the remitter or must be shared between the two. The drop-down list displays the following values:

- Shared
- Remit
- Beneficiary

## **Beneficiary Details**

### **Beneficiary**

*Alphanumeric; 35 Characters; Optional*

Specify the beneficiary name.

### **Beneficiary Add 1, 2, 3**

*Alphanumeric; 105 Characters; Optional*

Specify the beneficiary address. There are three lines available for the same.

### **Beneficiary BIC Code**

*Alphanumeric; 24 Characters; Optional*

Specify the BIC code of the beneficiary.

### **Beneficiary Acct No**

*Alphanumeric; 34 Characters; Optional*

Specify the account number of the beneficiary.

### **Beneficiary Code**

*Alphanumeric; 24 Characters; Optional*

Specify the code of the beneficiary.

### **Beneficiary Info**

*Alphanumeric; 100 Characters; Optional*

Enter more information about the beneficiary.

### **Beneficiary IBAN**

*Alphanumeric; 40 Characters; Optional*

Specify beneficiary IBAN details.

## **Intermediary Details**

### **Intermediary**

*Alphanumeric; 35 Characters; Optional*

Specify the intermediary detail.

### **Intermediary Add 1, 2, 3**

*Alphanumeric; 105 Characters; Optional*

Specify the intermediary address. There are three lines available for the same

### **Intermediary BIC Code**

*Alphanumeric; 24 Characters; Optional*

Specify the BIC code of the Intermediary.

### **Intermediary Acct No**

*Alphanumeric; 34 Characters; Optional*

Specify the account number of the Intermediary.

### **Intermediary Code**

*Alphanumeric; 24 Characters; Optional*

Specify the code of the Intermediary.

**Intermediary Info**

*Alphanumeric; 100 Characters; Optional*

Enter more information about the Intermediary.

**Intermediary IBAN**

*Alphanumeric; 40 Characters; Optional*

Specify intermediary IBAN details.

**Further Credit Details****Further Credit Name**

*Alphanumeric; 35 Characters; Optional*

Specify further credit name.

**Further Credit Acct No**

*Alphanumeric; 35 Characters; Optional*

Specify further credit account number.

**Reference****Reference1**

*Alphanumeric; 35 Characters; Optional*

Specify the reference details.

**Reference2**

*Alphanumeric; 35 Characters; Optional*

Specify the reference details.

Save all the details to proceed or click cancel button to cancel the operation.

---

**Note**

Only Query option is available for 'UTDFHIDS (Income Distribution Setup Detail)' screen.

---

## **4.2 Income Distribution Setup Summary Screen**

This section contains the following topics:

- [Section 4.2.1, "Retrieving Income Distribution Setup Record"](#)
- [Section 4.2.2, "Editing Income Distribution Setup Record"](#)
- [Section 4.2.3, "Viewing Income Distribution Setup Record"](#)
- [Section 4.2.4, "Deleting Income Distribution Setup Record"](#)
- [Section 4.2.5, "Authorizing Income Distribution Setup"](#)
- [Section 4.2.6, "Amending Income Distribution Setup"](#)
- [Section 4.2.7, "Authorizing Amended Income Distribution Setup Details"](#)

### **4.2.1 Retrieving Income Distribution Setup Record**

After you set up the IDS options for an investor in the UH IDS Setup Detail screen, you can perform any of the operations before the record is authorized:

- Edit the specified options in the setup. At this stage, you can alter any of the details, other than the fund and the unit holder ID.

- Delete the setup.

To perform either operation, use the 'Income Distribution Setup Summary' screen. You can invoke this screen by typing 'UTSUHIDS/ UTSFHIDS' in the field at the top right corner of the Application tool bar and clicking on the adjoining arrow button.

You can retrieve a previously entered record in the Income Distribution Setup Summary screen, as follows:

- Specify any or all of the following details in the Income Distribution Setup Summary screen:
- The status of the transaction in the Authorization Status field. If you choose the "Blank Space" option, then all the transactions that involve the specified unit holder are retrieved.
- The status of the record in the Open field. If you choose the "Blank Space" option, then all the records that involve the specified unit holder are retrieved.
- Unit Holder
- Entity Type
- Product ID
- Policy Number
- Fund ID
- Rule Effective Date
- Latest Rule

Click 'Search' button to view the records. All records with the specified details are retrieved and displayed in the lower portion of the screen.

You can also retrieve the individual record detail from the detail screen by doing query in the following manner:

- Press F7
- Input the Product ID
- Press F8

You can perform Edit, Delete, Amend, Authorize, Reverse, Confirm operation by selecting from the Action list.

You can also search the record by using combination of % and alphanumeric value.

### **Example**

You can search the record for Product ID by using the combination of % and alphanumeric value as follows:

- Search by A%: System will fetch all the records whose Product ID starts from Alphabet 'A'. For Example: AGC17, AGVO6, AGC74 and so forth.
- Search by %7: System will fetch all the records whose Product ID ends by numeric value '7'. For Example: AGC17, GSD267, AGC77 and so forth.
- Search by %17%: System will fetch all the records whose Product ID contains the numeric value 17. For Example: GSD217, GSD172, AGC17 and so forth.

## **4.2.2 Editing Income Distribution Setup Record**

You can modify the details of Income Distribution Setup parameters that you have already entered into the system, provided it has not been subsequently authorized. You can perform this operation as follows:

- Invoke the Income Distribution Setup Summary screen from the Browser.
- Select the status of the record that you want to retrieve for modification in the Authorized field. You can only modify records that are unauthorized. Accordingly, choose the Unauthorized option.
- Specify any or all of the details in the corresponding fields to retrieve the record that is to be modified. All unauthorized records with the specified details are retrieved and displayed in the lower portion of the screen.
- Double click the record that you want to modify in the list of displayed record. The Income Distribution Setup Detail screen is displayed.
- Select Unlock Operation from Action list to modify the record. Modify the necessary information.
- Click Save to save your changes. The Income Distribution Setup Detail screen is closed and the changes made are reflected in the Income Distribution Setup Summary screen.

## **4.2.3 Viewing Income Distribution Setup Record**

To view a record that you have previously entered, you must retrieve the same in the Income Distribution Setup Summary screen, as follows:

- Invoke the Income Distribution Setup Summary Screen from the Browser.
- Select the status of the transaction that you want to retrieve for viewing in the Authorized field. You can also view all records that are either unauthorized or authorized only, by choosing the Unauthorized/ Authorized option.
- Specify any or all of the details of the transaction in the corresponding fields on the screen, and click 'Search' button. All records with the specified details are retrieved and displayed in the lower portion of the screen.

- Double click the record that you want to view in the list of displayed records. The Income Distribution Setup Detail screen is displayed in View mode.

#### **4.2.4 Deleting Income Distribution Setup Record**

You can delete only unauthorized records in the system. To delete a record that you have previously entered:

- Invoke the Income Distribution Setup Summary screen from the Browser.
- Select the status of the record that you want to retrieve for deletion.
- Specify any or all of the details and click 'Search' button. All records with the specified details are retrieved and displayed in the lower portion of the screen.
- Double click the record that you want to delete. The Income Distribution Setup Detail screen is displayed.
- Select Delete operation from the Action list. The system prompts you to confirm the deletion, and the record is deleted physically from the system database.

#### **4.2.5 Authorizing Income Distribution Setup**

An unauthorized Income Distribution Setup must be authorized in the system for it to be processed. To authorize a record:

- Invoke the Income Distribution Setup Summary screen from the Browser.
- Select the status of the record that you want to retrieve for authorization. Typically, choose the Unauthorized option.
- Specify any or all of the details of the record in the corresponding fields on the screen. Click 'Search' button. All transactions with the specified details that are pending authorization are retrieved and displayed in the lower portion of the screen.
- Double click the transaction that you wish to authorize. The Income Distribution Setup Detail screen is displayed. Select Authorize operation from Action.

When the checker authorizes a record, details of validations, if any, that were overridden by the maker of the transaction during the Save operation, are displayed. If any of these overrides results in an error, the checker must reject the transaction.

#### **4.2.6 Amending Income Distribution Setup**

After an Income Distribution Setup is authorized, it can be modified using the Unlock operation from Action list. To make changes to a transaction after authorization:

- Invoke the Income Distribution Setup Summary screen from the Browser.
- Select the status of the transaction that you wish to retrieve for amendment. You can only amend only authorized records.
- Specify any or all of the details of the Income Distribution Setup in the screen. All records with the specified details are retrieved and displayed in the lower portion of the screen.
- Double click the record that you want to amend. The Income Distribution Setup Detail screen is displayed in Amendment mode. Click the Unlock operation from the Action list to amend the record.
- Amend the necessary information. Click the Save button to save the changes.

When you retrieve an IDS setup record for the purpose of amendment in this screen, it is displayed in the Income Distribution Setup Detail screen, in Amend mode. All the non-editable field values are displayed as labels, while the editable fields are enabled for data entry changes.

---

**Note**

When you make changes to any authorized record in the system database through the amendment operation, the record with the amended information is saved as an unauthorized record in the system. For your amendment changes to be effective, the amended record must be subsequently authorized. When it is authorized, it is saved in the system database as an authorized record with the amendment information, and is effective.

---

#### **4.2.7 Authorizing Amended Income Distribution Setup Details**

An amended Income Distribution Setup record must be authorized for the amendment to be made effective in the system. The authorization of amended records can only be done from Agency branch Module.

The process of authorization is subsequently the same as that for normal records.

### **4.3 Unitholder Deal Maintenance Detail Screen**

This section contains the following topics:

- [Section 4.3.1, "Setting Up Deal for Investor"](#)
- [Section 4.3.2, "Invoking Unitholder Deal Maintenance Detail Screen"](#)

#### **4.3.1 Setting Up Deal for Investor**

When you map a charge (or load) to a fund, or a load group, the loads are applied to transactions requested by all investors that transact in the fund or load group subject to the evaluated criteria of the loads matching the unit holder and the transaction.

In some cases, the AMC may wish to offer a special, unique load option to be applied on all transactions involving a specific CIF Account or unit holder. This could also be at the request of the investor. This special load option would override the existing load option mapped to the fund or load group. Such a load option is called a 'deal' for an investor.

The deal consists of specifying a new return value for any or all of the loads mapped to the fund or load group. You specify the new return value against an existing return value that is based on a percentage or a fixed amount for the load.

You can set up a deal:

- For a specific unit holder under a CIF customer account.
- For all unit holders under a CIF account.
- For a single, non-CIF unit holder.
- To be applicable to all transactions of the selected unit holder/ CIF unit holder in a specific fund.
- To be applicable to all transactions of the selected unit holder/ CIF unit holder in any or all of the funds under a specific load group.
- To be applicable on a specific load that has been mapped to a fund or load group.

The usage of a negotiated deal is different from an over-the-counter load override. Negotiated deals are generally done for special customers with pre-defined business agreements that are exceptional to the normal business rules.

To set up a deal for an investor, you use the 'Unitholder Deal Maintenance Detail' screen. You can invoke this screen by typing 'UTDUHDEL' in the field at the top right corner of the Application tool bar and clicking on the adjoining arrow button.

In the UH Deal Setup Detail screen, set up the deal as follows:

- Select the investor (or CIF Account) for whom the deal is being setup, in the CIF Number or the Unit Holder ID field.
- Select the level at which the deal is to be applied.
- To set a deal as applicable to all unit holders under a CIF, check the Apply at CIF Level check box.
- To set a deal as applicable at either a load level, fund/product level or load group level, choose the desired option in the Apply At field.
- Specify the period, during which the deal is applicable, by indicating the start and end dates, in the Start Date and End Date fields.
- If the deal is applicable for a fund, select the desired fund in the Fund field, and the ISIN Code of the fund, in the ISIN Code field.
- If the deal is applicable for a load group, select the desired load group in the Load Group field.
- If the deal is applicable for a specific load that is mapped to the selected fund or load group, select the desired load in the Load field.
- In the Load Details section, specify the overridden return value that is to be deemed applicable for the required slab, in the Override To field.
- Save your changes.



## 4.3.2 Invoking Unitholder Deal Maintenance Detail Screen

Invoke the 'Unitholder Deal Maintenance Detail' screen by typing 'UTDUHDEL' in the field at the top right corner of the Application tool bar and clicking on the adjoining arrow button.

The screenshot displays the 'Unitholder Deal Maintenance Detail' application window. It is divided into several sections: 'Client Information' with a search for 'Unit Holder / CIF Number' and a 'Name' field; 'Deal Details' with various input fields including 'Deal Transaction Number', 'Apply At CIF Level', 'Apply Deal At', 'Fund ID', 'Fund Name', 'Policy Number', 'Effective Start Date', 'Tax Type', 'Amount Or Percentage', 'Status', 'Product ID', 'Product Name', 'Deal Based On', 'Description', 'Effective End Date', 'Group ID', 'Load Description', and 'Load Calculation Method'; and 'Load Details' which contains a table with columns for 'Slab Sequence No', 'From Date', 'To Date', 'From Amount', 'To Amount', 'From Units', and 'To Units'. A 'Save' button is located at the top left, and a 'Cancel' button is at the bottom right. The bottom status bar includes fields for 'Input by', 'Authorized by', 'DateTime', 'Mod No', 'Open', and 'Authorized'.

Select 'New' from the Actions menu in the Application tool bar or click new icon to enter the details of the 'Unitholder Deal Maintenance' screen.

### Client Information

In this section, select the ID of the unit holder for whom you are specifying deal options.

You can create deals for both authorized and unauthorized unit holders/CIF. If a deal is created for an unauthorized unit holder, the unit holder/CIF record must be authorized before the deal authorization process is put through. Else, the unit holder deal cannot be authorized.

### **Unit Holder/ CIF Number**

*Alphanumeric; 12 Characters; Mandatory*

From the list, select the unit holder or CIF account number for whom you are creating the deal options.

When you specify the CIF Number, the name of the corresponding CIF Account is retrieved from the database and displayed alongside the field.

### **Name**

*Display*

The system displays the name of the ID of the non-CIF unit holder for whom you are setting up the deal in this screen.

You can search unit holder or CIF number by clicking 'Find Unit Holder' button.

## **Deal Details**

In this section, specify the level at which the deal must be applied for the selected unit holder.

### **Deal Transaction Number**

#### *Display*

The system displays the deal transaction number of the deal while saving.

### **Status**

#### *Mandatory*

By default, the status of all newly created deals in this screen is Active. However, you can select the status from the drop-down list. The list displays the following values:

- Active
- Cancelled

### **Apply at CIF Level**

#### *Mandatory*

Select 'Yes' to indicate that the deal options you are setting up must be applicable to all unit holder accounts under the selected CIF customer account.

---

#### **Note**

When the deal is applied at CIF level, a similar set up is not possible at unit holder account level for the same fund / group and load, and vice versa.

---

### **Apply Deal At**

#### *Mandatory*

From the list, select and indicate whether the deal must be applied on a single load (Load Level), a particular load for a fund (Fund Level), all funds in a load group (Load Group Level) or a Product (Product Level). The options in the drop-down list are as follows:

- Load Level
- Load Group Level
- Fund Level
- Product Level

---

#### **Note**

If you select the option 'Product Level' or 'Fund Level', the fields 'Fund' and 'ISIN Code' will be displayed. These two fields are explained below.

---

### **Product ID**

*Alphanumeric; 10 Characters; Optional*

Specify the Product for which the deal is to be applied.

### **Product Name**

#### *Display*

The system displays the name of the product for the selected product ID.

**Fund ID**

*Alphanumeric; 6 Characters; Optional if 'Product Level', Mandatory if 'Fund Level'*

This field will be displayed only if you have selected the option 'Product Level' or 'Fund Level' against the field 'Apply At'.

If you have selected the option 'Product Level', you can set up a deal for the investor at the Product level. You have the option of specifying a particular fund to which the 'Load' that you select applies. If you do not select a fund, the load that you select will be applicable to all funds mapped to the Product.

If you have selected the option 'Fund Level', from the list, select the fund for which the deal would apply, for the selected unit holder.

**Fund Name**

*Display*

The system displays the name of the fund for the selected fund ID.

**Deal Based On**

*Alphanumeric; 1 Character; Optional*

Select the deal based on from the following options maintained:

- Inclusion Percentage, then the calculation of taxes are as follows:
  - Basis Annual Tax = Gross Annualized Amount \* Load Return Value
  - Annual Tax = Apply the Product With Holding Tax slab basis load on Basis Annual Tax
- Flat Rate Percentage, then the annual tax is calculated as:
  - Annual Tax = Policy Annuity Value \* Load Return Value
- Flat Rate Amount, then the annual tax is calculated as:
  - Basis Amount = Load Return Value \* 12 and
  - Effective Rate = Basis Amount \* 100 / Gross Annualized Amount
  - Annual Tax = (Gross Annualized Amount \* Effective Rate) / 100

---

**Note**

An option "All" is also available to map a load across all the Products for a Policy Holder. If 'All' is selected then the Funds cannot be selected.

---

**Description**

*Display*

The system displays the description for the selected deal based on details.

**Policy Number**

*Alphanumeric; 16 Characters; Optional*

Specify the Policy for which the deal is to be applied.

**Effective Start Date**

*Date Format, Mandatory*

Enter the date from which the deal is to be effective

Specify the date on and following which, the deal options must be applied for transactions for the selected unit holder, in the manner indicated in this record.

## Effective End Date

*Date Format, Mandatory*

Enter the date to which the deal is to be effective.

Specify the last date on which, the deal options must be applied for transactions for the selected unit holder, in the manner indicated in this record.

## Tax Type

*Optional*

You will be able to select the tax type only if you have selected 'Apply At' as 'Product Level'.

The investor will be charged for tax and the tax rate will be calculated based on the method of tax calculation you specify. Following are the options available in the adjoining drop-down list:

- Directives
- Instructions
- Aggregation

## Directives

Tax Directives is the tax rate provided by the SARS to the investors. The investors, in turn will instruct the tax that has to be deducted. Accordingly, the system will deduct the tax rate specified by the investor instead of the tax slab that is maintained in the 'Withholding Tax Setup' screen.

*Refer to the chapter 'Maintaining Reference Information' for details on maintaining tax slabs.*

Based on the tax directive submitted by the investor at the UH level, the UH deal for the tax load will be maintained.

## Instructions

Tax Instructions is the tax rate suggested by the investors to deduct the tax. However, the system will compare the suggested tax rate with that of the tax slabs maintained. If the value of the suggested tax rate is lower than the maintained tax slab, the system can apply the higher value of the tax rate.

---

### Note

The tax directive or the tax instruction is at the policy level and not at the UH level.

---

## Aggregation

This is allowed only if 'Tax Aggregation' is allowed at product level. If Product ID is selected as 'All' in UH deal then the system will look at those products where 'Tax Aggregation' is checked for the product.

If tax directive is maintained in UH-Deal then tax instruction or tax aggregation will not be allowed to maintain for the same deal effective period. Tax instruction and tax directive are mutually exclusive.

When a tax directive is maintained in UH-Deal then existing tax instruction or tax aggregation (for the same UH/product/policy/deal effective period), if any, will be marked as cancelled. You cannot maintain multiple directives/instructions/aggregation for the same deal effective period.

When directive is maintained in UH deal, the system will directly use this value to compute WHT. When tax instruction or aggregated value is maintained then system will project WHT based on Tax-instruction and aggregation, higher of these will be used for WHT deduction.

Internally, the system will track whether slab or directive or instruction or Aggregation was applied for each annuity.

When deal is based on flat rate amount, then it needs to apply directly to the Annuity irrespective of the frequency. The return value would be tax amount payable per annuity frequency and not the annualized value.

If both Tax Aggregation and Instructions are maintained then the system will take the rate with higher tax outgo.

In Product maintenance if 'Annuity Tax Computation basis' is 'Policy', then rebate also will be at Policy level.

In case of any UH deal (Directive/Aggregation/Instruction) rebate will not be given. It will be applied only on Default slab.

If Unit Holder has multiple policies under one product and the deal based on is selected as Flat rate percentage and UH Deal Tax Type is Directive then the annuity tax must be calculated at each Policy gross annualized annuity amount level.

For instance, If POL1 and POL2 are two policies under a UH, with 3000 and 2000 as respective annuities and assuming 10% is the flat rate deal maintained at the UH deal level, then the system should charge an annuity tax of 300 and 200 respectively each month.

When Annuity Tax Computation Basis at product Level is 'Policy Holder' and the UH Deal Tax type is 'Directive' (deal based on is selected as Flat Rate), the system calculates the annual tax on each policy's gross annualized annuity amount, if UH has many policies under the same product.

Multiple deals for same deal type/ UH/Product/policy combination will not be supported.

---

**Note**

Unit Holder can have multiple policies under one product and if the UH Deal Tax type is directive (deal based on is selected as Flat Rate), the system will compute annuity tax on each policy's gross annualized annuity amount.

---

**Group ID**

*Alphanumeric; 16 Characters; Optional*

From the list, select the load for which you want to specify the new return value as required for the deal. For all transactions for the selected unit holder in the selected fund, that occur between the deal start and end dates, for which the selected load is applicable, the deal will be applied.

**Load ID**

*Numeric, 5 Characters; Mandatory if the deal is to be applied for all funds in a load group (Load Group Level)*

From the list, select the load group for which the deal would apply, for the selected unit holder. For all transactions for the selected unit holder in any fund belonging to this load group, that occur between the deal start and end dates, the deal will be applied on the selected load.

**Load Description**

*Display*

The system displays the description for the selected load ID.

### **Load Calculation Method**

#### *Display*

The system displays the Load method that is used for calculating the Load when you choose the load ID.

### **Amount or Percentage**

#### *Display*

This field is defaulted depending on whether the Load ID selected is an amount based load or a percentage based load.

### **Load Details**

In this section, you can specify the altered return value for the selected load that is applicable as required for the deal.

The Load details that are maintained gets defaulted in this tab, when the button 'Default Load Details' is clicked. For each load that you select in the Load field in the Deal Details section, the following details are displayed in this section, in display mode:

- Slab Sequence No, if any and their applicable boundaries.
- From Date
- To Date
- From Amount
- To Amount
- From Units
- To Units
- From Period
- To Period
- Return Value: The original Return Value for the load.
- Override To

#### **Derived Load Details**

- Load ID
- Description
- Load Percentage: Amount or Percentage (this is the basis on which the return value for the selected load is derived)
- Override To

In the Override To field, specify the new return value applicable for the load, as required for the deal, and click 'Exit' button.

## **4.4 Unitholder Deal Summary Screen**

This section contains the following topics:

- [Section 4.4.1, "Retrieving Deals for Investors"](#)
- [Section 4.4.2, "Editing Deals for Investors "](#)
- [Section 4.4.3, "Viewing Deals for Investors "](#)
- [Section 4.4.4, "Deleting Deals for Investors "](#)
- [Section 4.4.5, "Authorizing Deals for Investors"](#)
- [Section 4.4.6, "Amending Deals for Investors"](#)
- [Section 4.4.7, "Authorizing Amended Deals for Investors"](#)

## 4.4.1 Retrieving Deals for Investors

After you set up the Deal options for an investor in the UH Deal Setup Detail screen, you can perform any of the following operations before the record is authorized:

- Edit the specified options in the setup. At this stage, you can alter any of the details.
- Delete the setup.

To perform either operation, use the 'Unitholder Deal Summary' screen. You can invoke this screen by typing 'UTSUHDEL' in the field at the top right corner of the Application tool bar and clicking on the adjoining arrow button.

Unitholder Deal Summary

Search Advanced Search Reset Clear All

Search Is Case Sensitive

Authorization Status

Unit Holder / CIF Number 000000401617

Apply Deal At Not Selected

Effective Start Date MM/DD/YYYY

Open

Apply At CIF Level

Load ID

Effective End Date MM/DD/YYYY

Records per page 15 1 of 1 Go Lock Columns 0

Authorization Status	Open	Status	Deal Transaction Number	Unit Holder / CIF Number	First Name	Apply At CIF Level	Apply Deal
----------------------	------	--------	-------------------------	--------------------------	------------	--------------------	------------

Authorize

Exit

You can retrieve a previously entered record in the Unitholder Deal Summary screen, as follows:

1. Specify any or all of the following details in the Unitholder Deal Summary screen:
  - The status of the record in the Authorization Status field. If you choose the "Blank Space" option, then all the records that involve the specified unit holder are retrieved.
  - The status of the record in the Open field. If you choose the "Blank Space" option, then all the records that involve the specified unit holder are retrieved.
  - Unit Holder/ CIF Number
  - Apply At CIF Level
  - Apply Deal At
  - Load ID
  - Effective Start Date
  - Effective End Date

Click 'Search' button to view the records. All records with the specified details are retrieved and displayed in the lower portion of the screen.

---

**Note**

You can also retrieve the individual transaction detail from the detail screen by doing query in the following manner:

- Press F7
  - Input the Load ID
  - Press F8
- 

You can perform Edit, Delete, Amend, Authorize, Reverse, Confirm operation by selecting from the Action list.

You can also search the record by using combination of % and alphanumeric value.

**Example**

You can search the record for Load ID by using the combination of % and alphanumeric value as follows:

- Search by A%: System will fetch all the records whose Load ID starts from Alphabet 'A'. For example: AGC17, AGVO6, AGC74 and so forth.
- Search by %7: System will fetch all the records whose Load ID ends by numeric value '7'. For Example: AGC17, GSD267, AGC77 and so forth.
- Search by %17%: System will fetch all the records whose Load ID contains the numeric value 17. For Example: GSD217, GSD172, AGC17 and so forth.

**4.4.2 Editing Deals for Investors**

You can modify the details of Unitholder Deal parameters that you have already entered into the system, provided it has not been subsequently authorized. You can perform this operation as follows:

- Invoke the Unitholder Deal Summary screen from the Browser.
- Select the status of the record that you want to retrieve for modification in the Authorized field. You can only modify records that are unauthorized. Accordingly, choose the Unauthorized option.
- Specify any or all of the details in the corresponding fields to retrieve the record that is to be modified. All unauthorized records with the specified details are retrieved and displayed in the lower portion of the screen.
- Double click the record that you want to modify in the list of displayed records. The Unitholder Deal Detail screen is displayed.
- Select Unlock Operation from Action list to modify the record. Modify the necessary information.
- Click Save to save your changes. The Unitholder Deal Detail screen is closed and the changes made are reflected in the Unitholder Deal Summary screen.

**4.4.3 Viewing Deals for Investors**

To view a record that you have previously entered, you must retrieve the same in the Unitholder Deal Summary screen, as follows:

- Invoke the Unitholder Deal Summary Screen from the Browser.
- Select the status of the transaction that you want to retrieve for viewing in the Authorized field. You can also view all records that are either unauthorized or authorized only, by choosing the Unauthorized/ Authorized option.



- Specify any or all of the details of the transaction in the corresponding fields on the screen, and click 'Search' button. All records with the specified details are retrieved and displayed in the lower portion of the screen.
- Double click the record that you want to view in the list of displayed records. The Unitholder Deal Detail screen is displayed in View mode.

#### **4.4.4 Deleting Deals for Investors**

You can delete only unauthorized records in the system. To delete a record that you have previously entered:

- Invoke the Unitholder Deal Summary screen from the Browser.
- Select the status of the record that you want to retrieve for deletion.
- Specify any or all of the details and click 'Search' button. All records with the specified details are retrieved and displayed in the lower portion of the screen.
- Double click the record that you want to delete. The Unitholder Deal Detail screen is displayed.
- Select Delete operation from the Action list. The system prompts you to confirm the deletion, and the record is deleted physically from the system database.

#### **4.4.5 Authorizing Deals for Investors**

An unauthorized Unitholder Deal records must be authorized in the system for it to be processed. To authorize a record:

- Invoke the Unitholder Deal Summary screen from the Browser.
- Select the status of the record that you want to retrieve for authorization. Typically, choose the Unauthorized option.
- Specify any or all of the details of the record in the corresponding fields on the screen. Click 'Search' button. All transactions with the specified details that are pending authorization are retrieved and displayed in the lower portion of the screen.
- Double click the transaction that you wish to authorize. The Unitholder Deal Detail screen is displayed. Select Authorize operation from Action.

When the checker authorizes a transaction, details of validations, if any, that were overridden by the maker of the transaction during the Save operation, are displayed. If any of these overrides results in an error, the checker must reject the transaction.

#### **4.4.6 Amending Deals for Investors**

After an Unitholder Deal record is authorized, it can be modified using the Unlock operation from Action list. To make changes to a record after authorization:

- Invoke the Unitholder Deal Summary screen from the Browser.
- Select the status of the record that you wish to retrieve for amendment. You can only amend only authorized records.
- Specify any or all of the details of the Unitholder Deal in the screen. All records with the specified details are retrieved and displayed in the lower portion of the screen.
- Double click the record that you want to amend. The Unitholder Deal Detail screen is displayed in Amendment mode. Click the Unlock operation from the Action list to amend the record.
- Amend the necessary information. Click the Save button to save the changes.

## 4.4.7 Authorizing Amended Deals for Investors

An amended Unitholder Deal record must be authorized for the amendment to be made effective in the system. The authorization of amended records can only be done from Fund Manager Module and Agency branch Module.

The process of authorization is subsequently the same as that for normal transactions.

When you retrieve a deal record for the purpose of amendment in this screen, it is displayed in the UH Deal Setup Detail screen, in Amend mode. All the non-editable field values are displayed as labels, while the editable fields are enabled for data entry changes.

---

### Note

When you make changes to any authorized record in the system database through the amendment operation, the record with the amended information is saved as an unauthorized record in the system. For your amendment changes to be effective, the amended record must be subsequently authorized. When it is authorized, it is saved in the system database as an authorized record with the amendment information, and is effective.

---

You can cancel an existing negotiated deal by changing the status to cancel. When you authorize this change, the deal set up is nullified.

## 4.5 LOI Adjust Proc Screen

This section contains the following topics:

- [Section 4.5.1, "Defining Letters of Intent"](#)
- [Section 4.5.2, "Non-fulfilling of Letter of Intent"](#)

### 4.5.1 Defining Letters of Intent

An investor may promise to invest a certain volume of capital in the funds of the AMC within a certain period. Sometimes, the AMC offers the investor a reduced commission or charge for such investment. Such indemnification from the investor is known as a Letter of Intent.

Any investor that chooses to invest using a Letter of Intent is known as an LOI investor in the system.

#### Example

An investor, Mrs. Frances Smith, promises to bring in investment worth 500000 USD to the Terry Wynan Growth Fund floated by your AMC, within the space of 3 months dating from 5<sup>th</sup> May 2003. She indemnifies this through a Letter of Intent. On 5<sup>th</sup> May 2003, she makes her first investment of 100000 USD.

This means that by the 4<sup>th</sup> of August, 2003, Mrs. Smith promises to invest the remaining indemnified amount (i.e., 500000 USD – 100000 USD = 400000 USD) in the said fund. She could do so in one transaction worth 400000 USD, or a series of transactions cumulatively worth 400000 USD.

Let us suppose the following charge option for the Terry Wynan Growth Fund, as defined by your AMC for normal investment:

Slab	From Amount	To Amount	Charge percentage per transaction
1	0	100000	5

2	100000	200000	4
3	200000	300000	3
4	300000	400000	2
5	400000	500000	1

Let us suppose that Mrs. Smith fulfills her Letter of Intent investment in the pattern specified below after 5<sup>th</sup> May 2003.

Transaction Reference Number	Transaction Date	Transaction Amount
LOIREF1	05-05-2003	100000
LOIREF2	20-05-2003	100000
LOIREF3	05-06-2003	100000
LOIREF4	20-06-2003	100000
LOIREF5	05-07-2003	100000

For the transaction LOIREF1, the charge percentage actually applied would be as follows:

Slab for LOIREF1, as a normal transaction: Slab 1

Charge Percentage for normal investment transaction, as per charge setup: 5%

LOI Amount: 500000 USD

Slab for LOI Amount: Slab 5.

Charge Percentage actually applied for LOIREF1: 1% of transaction amount = 1% of 100000 USD.

Similarly, the applicable charge percentages for each of the LOI fulfillment transactions are derived, and they are displayed below:

Transaction Reference Number	Transaction Date	Transaction Amount	Charge actually applied
LOIREF1	05-05-2003	100000	1%
LOIREF2	20-05-2003	100000	1%
LOIREF3	05-06-2003	100000	1%
LOIREF4	20-06-2003	100000	1%
LOIREF5	05-07-2003	100000	1%

Each investment made by Mrs. Smith after 5<sup>th</sup> May 2003 into the fund, will reduce the Letter of Intent amount remaining to be fulfilled. The amount remaining to be fulfilled is known as the 'used up' amount.

With the last investment on 5<sup>th</sup> July 2003, the Letter of Intent amount is fulfilled, or is said to be 'used up'.

An investor that has opted to invest through a Letter of Intent can reduce the used up Letter of Intent amount within the defined period, by any of the following transactions:

- IPO or subscription transactions
- Standing instructions that result in subscription, switch or redemption transactions.
- Switch transactions

- Redemption transactions
- Transactions resulting from reinvestment of income.

## 4.5.2 Non-fulfilling of Letter of Intent

If an investor does not bring in the investment amount promised in a letter of intent, before the expiry of the letter of intent, it constitutes non-fulfilment, and the AMC can recover the applicable commission that would have been due without the letter of intent.

The system monitors the fulfilment of letters of intent. The following facilities are available in the system:

### **Prior Warning Report**

On the date that marks the beginning of the start of the lead time period for the load group, a prior warning report is generated by the system during the Beginning of Day (BOD) process. This report contains information about those letters of intent that have not been fulfilled as on that date.

For instance, if the letter of intent expires on 15<sup>th</sup> June 2002 and the lead-time specified for the load group is 10 days, a BOD process is executed on 5<sup>th</sup> June 2002 to ascertain whether the investor has satisfied the letter of intent amount agreed upon. This verification is performed for all letters of intent.

The report identifies and displays the following information for each letter of intent for any investor which is unfulfilled as on the date that marks the beginning of the lead time period:

- LOI Number
- LOI start date
- LOI end date (expiry date)
- LOI amount
- Amount fulfilled or used up as on the current date
- Amount remaining unfulfilled as on the current date. This is computed as the difference between the LOI amount and the Amount Used Up as on the current date
- The Load Group to which the fund belongs, for which the LOI has been set up for the investor
- The lead time period specified for the load group

### **Post-Adjustment Report**

In the event of non-fulfilment of a letter of intent, you can obtain a report (known as the post adjustment report) that displays the actual commission that would have been due on any transactions entered into by the investor, had the letter of intent not been applied.

## 4.6 Setting up Letter of Intent Options for Investor

This section contains the following topics:

- [Section 4.6.1, "Invoking Unit Holder LOI Setup Detail Screen"](#)

### 4.6.1 Invoking Unit Holder LOI Setup Detail Screen

In Oracle FLEXCUBE Investor Servicing, you can set up any or all of the following options for investors who choose to invest through a Letter of Intent, at the investor's behest:

- The period during which the Letter of Intent will be fulfilled
- The amount indemnified in the Letter of Intent

- The load group in which the investor seeks to invest, through a Letter of Intent.
- The applicability of standing instruction transactions as a means of fulfilling Letters of Intent (i.e., reducing the LOI used up amount).
- The applicability of transactions put through earlier than the Letter of Intent period start date, as a means of reducing the Letter of Intent used up amount. Any period earlier than the start date is known as a prior period.
- The duration of a prior period, if applicable.
- For an LOI investor, you can designate any transaction requested by the investor as an LOI transaction, at the investor's request. By so doing, the transaction will be taken into account to reduce the used up Letter of Intent amount.

---

### Note

For an investor, you can only set up one Letter of Intent options record for a load group.

---

To set up the options requested by the investor for a Letter of Intent, use the 'Unit Holder LOI Setup Detail' screen. You can invoke this screen by typing 'UTDUHLOI/ UTDUHLOA' in the field at the top right corner of the Application tool bar and clicking on the adjoining arrow button.

In the UH LOI Detail screen, you must specify all the following details to set up the Letter of Intent option for an investor:

### Apply At

#### Mandatory

Select the applicability of the Letter of Intent setup to all unit holders under a CIF Account from the drop-down list. The list displays the following values:

- UH Level
- CIF Level

**First Name**

*Display*

The system displays the first name of the unit holder.

**UHID/CIF No.**

*Alphanumeric; 12 Characters; Mandatory*

From the list, select the CIF unit holder for whom you are creating the Letter of Intent options.

When you specify the CIF Number, the name of the corresponding CIF Account is retrieved from the database and displayed alongside the field.

All the unit holder accounts under the CIF Account that you have selected are listed in the option list in the Unit Holders for CIF field.

**LOI Number**

*Alphanumeric; 12 Characters; Optional*

Specify the LOI number.

**LOI End Date**

*Date Format; Mandatory*

Indicate the latest date by which the investor would fulfill the amount indemnified in the Letter of Intent.

**LOI Start Date**

*Date Format; Mandatory*

Indicate the date on which the period of the Letter of Intent commences. Following this date, the investor will have to fulfill the Letter of Intent.

If a prior period is applicable, then the duration of the prior period is reckoned from the date you specify here.

**Prior Period Applicable**

*Mandatory*

Select if prior period is applicable or not from the drop-down list. The list displays the following values:

- Yes
- No

**Prior Period Duration**

*Numeric; 3 Characters; Mandatory*

Specify the duration of the prior period (in days), to be reckoned from the Letter of Intent period start date.

If a prior period is specified, the used up amount on an LOI must be updated during authorization, based on the transactions that have been allocated before the LOI start date, within the prior period.

**LOI Currency**

*Alphanumeric; 3 Characters; Mandatory*

Specify the LOI currency in which the Letter of Intent amount will be deemed.

**Currency Name**

*Display*

The system displays the name of the currency for the selected LOI currency code.

**LOI Amount**

*Numeric; 18 Characters; Mandatory*

Specify the LOI amount.

**Include Standing Instructions**

*Mandatory*

Select the applicability of standing instruction transactions as a means of reducing the Letter of Intent used up amount from the drop-down list. The list displays the following values:

- Yes
- No

**Group ID**

*Alphanumeric; 6 Characters; Mandatory*

Specify the load group in which the investor seeks to invest, through the Letter of Intent.

**LOI Status**

*Mandatory*

Select the LOI status from the drop-down list. The list displays the following values:

- Active
- Cancel

**Remarks**

*Alphanumeric; 255 Characters; Optional*

Specify remarks, if any.

**Used-up Amount**

*Numeric; 30 Characters; Optional*

On any given date after the LOI Start Date, specify the amount that reflects the portion of the Letter of Intent amount that the investor has already fulfilled as on that date.

When you are creating the Letter of Intent options for the investor for the first time, this field contains a 'zero' value.

After making your specifications, save your changes by clicking the Save button. This setup must be authorized for it to be effective.

## **4.7 Unit Holder LOI Setup Summary Screen**

This section contains the following topics:

- [Section 4.7.1, "Retrieving LOI Setup Options for Investor"](#)
- [Section 4.7.2, "Editing LOI Setup Options for Investor"](#)
- [Section 4.7.3, "Viewing LOI Setup Options for Investor"](#)
- [Section 4.7.4, "Deleting LOI Setup Options for Investor"](#)
- [Section 4.7.5, "Authorizing LOI Setup Options for Investor"](#)
- [Section 4.7.6, "Amending LOI Setup Options for Investor"](#)
- [Section 4.7.7, "Authorizing Amended LOI Setup Options for Investor"](#)

### **4.7.1 Retrieving LOI Setup Options for Investor**

After you set up the Letter of Intent options for an investor in the UH LOI Setup Detail screen, you can perform any of the following operations before the record is authorized:

- Edit the specified options in the setup. At this stage, you can alter any of the details.
- Delete the setup.

To perform either operation, use the 'Unit Holder LOI Setup Summary' screen. You can invoke this screen by typing 'UTSUHLOI/ UTSUHLOA' in the field at the top right corner of the Application tool bar and clicking on the adjoining arrow button.

You can retrieve a previously entered record in the UH LOI Summary screen, as follows:

2. Specify any or all of the following details in the UH LOI Summary screen:

- The status of the transaction in the Authorized field. If you choose the "Blank Space" option, then all the records that involve the specified unit holder are retrieved.
- The status of the record in the Open field. If you choose the "Blank Space" option, then all the records that involve the specified unit holder are retrieved.
- Unit Holder / CIF Number
- Apply At
- LOI Start Date
- LOI End Date
- LOI Currency
- The Group ID

Click 'Search' button to view the records. All records with the specified details are retrieved and displayed in the lower portion of the screen.

You can also retrieve the individual transaction detail from the detail screen by doing query in the following manner:



- Press F7
- Input the Group ID
- Press F8

You can perform Edit, Delete, Amend, Authorize, Reverse, Confirm operation by selecting from the Action list.

You can also search the record by using combination of % and alphanumeric value.

### **Example**

You can search the record for Group ID by using the combination of % and alphanumeric value as follows:

- Search by A%: System will fetch all the records whose Group ID starts from Alphabet 'A'. For example: AGC17, AGVO6, AGC74 and so forth.
- Search by %7: System will fetch all the records whose Group ID ends by numeric value '7'. For example: AGC17, GSD267, AGC77 and so forth.
- Search by %17%:- System will fetch all the records whose Group ID contains the numeric value. For example: GSD217, GSD172, AGC17 and so forth.

## **4.7.2 Editing LOI Setup Options for Investor**

You can modify the details of UH LOI parameters that you have already entered into the system, provided it has not been subsequently authorized. You can perform this operation as follows:

- Invoke the UH LOI Summary screen from the Browser.
- Select the status of the record that you want to retrieve for modification in the Authorized field. You can only modify records that are unauthorized. Accordingly, choose the Unauthorized option.
- Specify any or all of the details in the corresponding fields to retrieve the record that is to be modified. All unauthorized records with the specified details are retrieved and displayed in the lower portion of the screen.
- Double click the record that you want to modify in the list of displayed records. The UH LOI Detail screen is displayed.
- Select Unlock Operation from Action list to modify the record. Modify the necessary information.
- Click Save to save your changes. The UH LOI Detail screen is closed and the changes made are reflected in the UH LOI Summary screen.

## **4.7.3 Viewing LOI Setup Options for Investor**

To view a record that you have previously entered, you must retrieve the same in the UH LOI Summary screen, as follows:

- Invoke the UH LOI Summary Screen from the Browser.
- Select the status of the record that you want to retrieve for viewing in the Authorized field. You can also view all records that are either unauthorized or authorized only, by choosing the Unauthorized / Authorized option.
- Specify any or all of the details of the record in the corresponding fields on the screen, and click 'Search' button. All records with the specified details are retrieved and displayed in the lower portion of the screen.
- Double click the record that you want to view in the list of displayed records. The UH LOI Detail screen is displayed in View mode.

#### 4.7.4 Deleting LOI Setup Options for Investor

You can delete only unauthorized records in the system. To delete a record that you have previously entered:

- Invoke the UH LOI Summary screen from the Browser.
- Select the status of the record that you want to retrieve for deletion.
- Specify any or all of the details and click 'Search' button. All records with the specified details are retrieved and displayed in the lower portion of the screen.
- Double click the record that you want to delete. The UH LOI Detail screen is displayed.
- Select Delete operation from the Action list. The system prompts you to confirm the deletion, and the record is deleted physically from the system database.

#### 4.7.5 Authorizing LOI Setup Options for Investor

An unauthorized UH LOI record must be authorized in the system for it to be processed. To authorize a record:

- Invoke the UH LOI Summary screen from the Browser.
- Select the status of the record that you want to retrieve for authorization. Typically, choose the Unauthorized option.
- Specify any or all of the details of the record in the corresponding fields on the screen. Click 'Search' button. All record with the specified details that are pending authorization are retrieved and displayed in the lower portion of the screen.
- Double click the transaction that you wish to authorize. The UH LOI Detail screen is displayed. Select Authorize operation from Action.

When the checker authorizes a transaction, details of validations, if any, that were overridden by the maker of the transaction during the Save operation, are displayed. If any of these overrides results in an error, the checker must reject the transaction.

#### 4.7.6 Amending LOI Setup Options for Investor

After an UH LOI record is authorized, it can be modified using the Unlock operation from Action list. To make changes to a transaction after authorization:

- Invoke the UH LOI Summary screen from the Browser.
- Select the status of the transaction that you wish to retrieve for amendment. You can only amend only authorized records.
- Specify any or all of the details of the UH LOI in the screen. All records with the specified details are retrieved and displayed in the lower portion of the screen.
- Double click the record that you want to amend. The UH LOI Detail screen is displayed in Amendment mode. Click the Unlock operation from the Action list to amend the record.
- Amend the necessary information. Click the Save button to save the changes.

When you retrieve an LOI record for the purpose of amendment in this screen, it is displayed in the UH LOI Detail screen, in Amend mode. All the non-editable field values are displayed as labels, while the editable fields are enabled for data entry changes.

---

#### **Note**

When you make changes to any authorized record in the system database through the amendment operation, the record with the amended information is saved as an unauthorized record in the system. For your amendment changes to be effective, the amended re-

cord must be subsequently authorized. When it is authorized, it is saved in the system database as an authorized record with the amendment information, and is effective.

---

### **The Effect of Amending Letter of Intent Options**

You can amend an LOI setup record for an investor even after the LOI amount fulfilment has begun. During the amendment, if you change the LOI amount, then the charges applicable as well as the used up LOI amount are reckoned from the new, amended LOI amount.

### **The Effect of Amending a Letter of Intent Fulfilment Transaction**

If you amend the amount involved in an LOI transaction for an investor, then the used up LOI amount is computed using the amended transaction amount.

---

#### **Note**

Once a transaction for an LOI investor is designated as an LOI transaction and subsequently authorized, it cannot be re-designated as a non-LOI transaction during amendment.

---

### **Cancelling the Letter of Intent Options during Amendment**

When you amend the Letter of Intent options for an investor, you can 'cancel' the applicability of the options by choosing the Cancel option in the LOI Status field, and saving your changes. If you do so, then the Letter of Intent is invalid and will not be validated for during subsequent transactions for the investor.

## **4.7.7 Authorizing Amended LOI Setup Options for Investor**

An amended UH LOI record must be authorized for the amendment to be made effective in the system. The authorization of amended records can only be done from Agency branch Module.

The process of authorization is subsequently the same as that for normal transactions.

## **4.8 LOI Adjust Proc Screen**

This section contains the following topics:

- [Section 4.8.1, "Invoking LOI Adjust Proc Screen"](#)

### **4.8.1 Invoking LOI Adjust Proc Screen**

To obtain such a report, you must trigger the computation and storing of the actual commission data, from the system database. You can use the 'LoI Adjust Proc' screen for this. You can invoke this screen by typing 'UTDLOIPR' in the field at the top right corner of the

Application tool bar and clicking on the adjoining arrow button. The 'LoI Adjust Proc' screen is displayed.

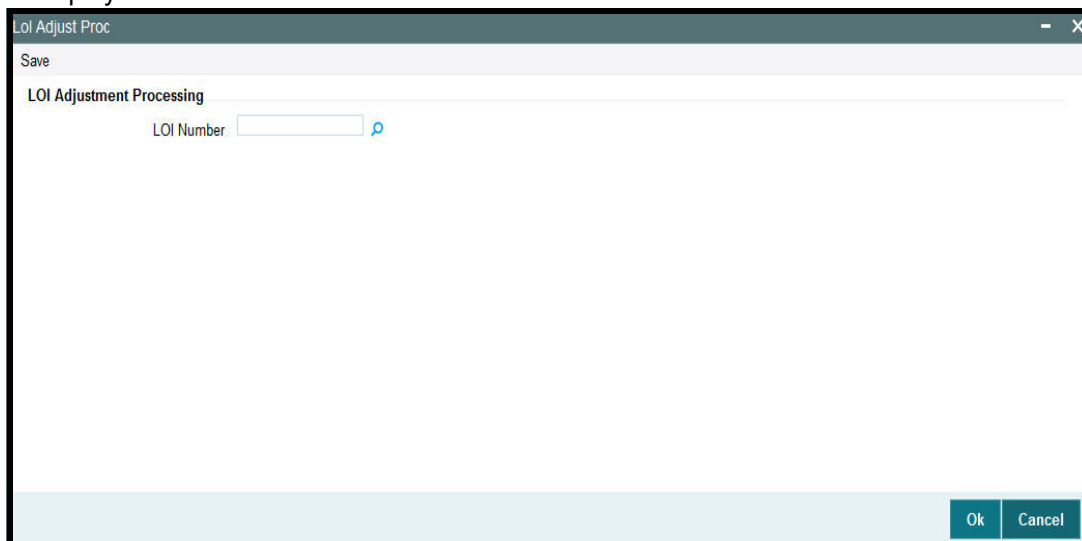

### **LOI Number**

*Alphanumeric; 25 Characters; Optional*

Specify the LOI number of the corresponding letter of intent, on the next business date after the expiry date of the letter of intent.

Alternatively, if you do not specify the number, you can trigger the computation of commission data for all such letters of intent that are unfulfilled, after the expiry date.

After you have triggered the computation of commission data, in the LOI Adjustment Processing screen, you can use the LOI Non-Fulfilment menu item in the Batch menu to obtain the actual report.

This report contains details of the actual commission due on each of the transactions without considering the letter of intent. This amount must be recovered from the unit holder by the AMC.

The following details are displayed in the report for each letter of intent for any investor which is unfulfilled as on the next business date after the expiry date:

- LOI Number
- Letter of intent amount agreed (LOI amount).
- Letter of intent amount fulfilled (used up amount).
- ID of the load group to which the fund belongs, for which the LOI was set up for the investor.
- The funds in the load group.
- Transaction number, for each transaction designated as an LOI transaction.
- Commission collected for the transaction.
- Actual commission that should have been collected had there been no letter of intent.
- The loss borne by the AMC, which is computed as the difference between the commission collected and commission that should have been collected had there been no LOI.

The commission for each of the LOI transactions entered into during the LOI period is recomputed as if there had been no letter of intent. For each transaction, the actual

commission collected and the commission that should have been collected without the LOI is displayed. The sum of the commissions will be subtracted from the actual commission collected and the difference is reported through the report.

LOI investors have the option of designating any single transaction they enter into, as a Letter of Intent transaction. If so designated, the transaction amount in such transactions will reduce the Letter of Intent used up amount.

## **4.9 UH Non Tax Limits Detail Screen**

This section contains the following topics:

- [Section 4.9.1, "Setting Up Non-Tax Limits for Eligible Investors"](#)
- [Section 4.9.2, "Processing of Non-Tax Limits for Investors"](#)
- [Section 4.9.3, "Invoking UH Non Tax Limits Detail Screen"](#)

### **4.9.1 Setting Up Non-Tax Limits for Eligible Investors**

In some cases, investors can avail of tax exemption on their holdings in funds, up to certain prescribed limits, based on their eligibility for these exemptions. The limits would apply to holdings in both accumulated and non-accumulated funds. Whenever the prescribed limits are exceeded, the excess holdings would be subject to taxation.

#### **Example**

Let us suppose that an investor, Mr. Robert Brown, is eligible for exemption on tax to a limit of 100000 USD, on all his holdings in the AMC, in the following pattern:

Limit in accumulated funds: 20000 USD

Limit in non-accumulated funds:: 80000 USD

Mr. Brown is eligible up to the following limits in the following accumulated funds:

Carey Bugle Memorial Fund :10000 USD

Eastern Capital Income Fund :10000 USD

This would mean that if his investment holdings in any of these funds exceed these prescribed limits, the spillover holdings would attract taxation.

In Oracle FLEXCUBE Investor Servicing, you can maintain any such limits for eligible investors. By maintaining these limits and validating them whenever a transaction request is received from such an eligible investor, you can maintain the investor's taxable and non-taxable holdings separately.

To set up the limits in this screen,

- Select the unit holder for whom you want to set up the non-tax limits, in the Client Information section.
- Specify the total tax-exemption limit applicable for the investor, in all funds both accumulative and non-accumulative, in the Total Sanctioned Limit field.
- Specify the identification document for the non-tax limits that are being set up.
- If the eligibility document for the non-tax limits option has been received, select the Maruyu Eligibility Status option in the Change Information Status field, and specify the date on which the document was received, in the Document Received Date field. Typically, the Document Received Date is defaulted to the application date.

- Specify the break up of the total limit that would be applicable, in accumulated and non-accumulated funds.
- In the Non-Taxable Limits for Non-Accumulated Funds section, indicate the limit for such funds.
- In the Non-Taxable Limits for Accumulated Funds section, select each of the funds for which the limit must be applicable in the Fund field, and specify the limit for each in the Allowed Limit field.
- Save your specifications.

## **4.9.2 Processing of Non-Tax Limits for Investors**

If you have set up tax-exemption limits for eligible investors, the system maintains the taxable and non-taxable holdings of such investors separately.

In Oracle FLEXCUBE Investor Servicing, you can give investors the option of designating each transaction request to be validated against the non-tax limits, if any, set up for them. This means that even in the event of the limits not being used up, the investors can indicate that the proceeds of a transaction be classified as taxable, or non-taxable.

If, on an investor's request, you classify the transaction as a non-taxable one, then the transaction amount is validated against the investor's remaining limit for tax exemption.

When in the course of a transaction designated as non-taxable the limits are exceeded, the spillover proceeds are maintained in the system as taxable holdings for the investor.

The non-tax limits maintained for an investor are also reduced when dividend earned in accumulated funds is reinvested.

For more information on how you can configure funds to maintain taxable and non-taxable holdings for investors, refer the chapter "*Setting up Fund Rules*" in *Fund Manager User Manual*.

For more information on how to designate a transaction as taxable or non-taxable for eligible investors, refer the chapter "*Processing Transaction Requests*".

## **4.9.3 Invoking UH Non Tax Limits Detail Screen**

To set up the prescribed limits for taxable holdings for an eligible investor, you can use the 'UH Non Tax Limits Detail' screen. You can invoke this screen by typing 'UTDUHNTX/

UTDURATX' in the field at the top right corner of the Application tool bar and clicking on the adjoining arrow button.

Select 'New' from the Actions menu in the Application tool bar or click new icon to enter the details of the UH Non-Tax Limits screen.

## **Client Information**

In this section, select the ID of the unit holder for whom you are specifying non-tax limit options.

### **Unit Holder ID**

*Alphanumeric; 12 Characters; Mandatory*

Enter the CIF unit holder ID for whom you are creating the non-tax limit options.

### **First Name**

*Display*

Specify the ID of the non-CIF unit holder for whom you are setting up the non-tax limit options in this screen. The name of the unit holder that you select is displayed alongside the field.

### **CIF Number**

*Alphanumeric; 12 Characters; Mandatory for setting up non-tax limit options for a unit holder under a CIF Account*

Select or specify the number of the CIF Account under which the unit holder for whom you are creating the non-tax limit options is found.

When you specify the CIF Number, the name of the corresponding CIF Account is retrieved from the database and displayed alongside the field.

All the unit holder accounts under the CIF Account that you have selected are listed in the drop down list in the Unit Holders for CIF field.

You can query unit holder ID and CIF number by clicking 'Find' button.

### **System Limit**

#### **Limit Currency**

*Alphanumeric; 3 Characters; Mandatory*

This is parameterized at the system level. However, you can amend this value.

#### **Limit Amount**

*Numeric; 22 Characters; Mandatory*

This is parameterized at the system level. However, you can amend this value.

### **Basic Details**

In this section, you can indicate the total sanctioned limit across all funds for the investor.

#### **Allowed Limit**

*Numeric; 28 Characters; Mandatory*

Specify the total non-tax limit that is applicable for investments in the selected accumulated fund, for the investor. This amount must not be higher than the total sanctioned limit across all funds, which you specified in the Basic Details section in this screen.

The sum of the allowed limits for each accumulated fund must not exceed that portion of the total sanctioned limit available for accumulated funds.

#### **Identification Details**

*Alphanumeric; 3 Characters; Mandatory*

Select the type of identification document that is being provided for the non-tax limits option being set up for the unit holder. The system displays the description in the adjacent field.

The identification could be provided as any of the following documents:

- Nominee Document
- Handicap Document
- Death Certificate

#### **Sanction Status**

*Mandatory*

At any given date after you set up the non-tax limits for an investor in this screen, select the sanction status from the drop-down list. The list displays the following values:

- Active
- Cancel

When you are creating the non-tax limit options for the investor for the first time, the 'Active' option is displayed in this field.

If you have cancelled the non-tax limit through an amendment, the 'Cancel' option is displayed in this field. In this state, the limit is no longer valid and will not be validated for during any transactions of the investor.

You cannot alter the status displayed in this field at any juncture.

#### **UH Info Change Status**

*Numeric; 1 Character; Mandatory*



Specify the UH info change status. The system displays the description in the adjacent field.

The Maruyu Eligibility Status option is mandatory while setting up a new non-tax record.

While setting up a new non-tax limits record in this screen, you must select the Maruyu Eligibility Status option and specify the date on which the eligibility status document was received, as mandatory information. This date is typically defaulted to the application date. The system displays the description in the adjacent field.

While specifying any changes to the non-tax limits record during an amendment in this screen, you can select the type of change document that has been received, from the list. The following options are available:

- **Change Limit Status:** Select this option to indicate that the non-tax limit has been legally revised, and the document for the change has been received. The changed limit must also be specified in the Sanctioned Limit field.

---

**Note**

When a transfer transaction is entered for a unit holder with a non-tax limits record, the limit tracking for the amount is done based on the Average Cost and not the Transaction Base Price. Therefore, there could be a residual value for the non-taxable holdings, even if the actual number of units has come down to zero.

---

Only transfer by units (All Units) and percentage (by 100%) transactions may be entered for unit holders with non-tax limits records. Transfer transactions by amount cannot be entered for such unit holders in the case of change in status.

- **Stop Using Status:** Select this option to indicate that the non-tax limit has been withdrawn or stopped for the investor and the corresponding document to this effect this has been received. The available limit must be set to zero, in the Sanctioned Limit field. Authorization of this status change will result in an automatic transfer of non-taxable holdings to taxable holdings, for the concerned unit holder.
- **Loss of Eligibility Status:** Select this option to indicate that the investor has been legally made ineligible to avail of the non-tax limit, and the corresponding document to this effect has been received. The available limit must be set to zero, in the Sanctioned Limit field. Authorization of this status change will result in an automatic transfer of non-taxable holdings to taxable holdings, for the concerned unit holder.
- **Death Status:** Select this option to indicate that the non-tax limit has been withdrawn or stopped for the investor, due to death of the investor and the corresponding document to this effect this has been received. The available limit must be set to zero, in the Sanctioned Limit field.

When an information change has been effected to the unit holder account for which the non-tax limits are being set up, the system prompts you to confirm the change for the non-tax limit investor, and to confirm the receipt of the supporting document. Based on this, it also updates the option in this field as Change Information Status option, and defaults the Document Received Date as the application date of the change.

**Document Received Date**

*Date Format; Mandatory*

Specify the date on which the following documents are received:

- For a new non-tax limits record, the Maruyu Eligibility Status.
- For a non-tax limit amendment, the Change Limit Status, Stop Using Status, Loss of Eligibility Status or Death Status.

By default, the application date is reckoned as the date on which the corresponding document is received.

You must specify this date as mandatory information for either a new non-tax limits record or during amendment.

### **Date of Death**

*Date Format, Mandatory if the Death Status option is chosen in the Change Information Status field.*

During amendment, if you are entering the change information as Death Status in the Change Information Field, specify the date of death in this field.

## **Non-Taxable Limits for Accumulated Funds**

In this section, you specify the portion of the total non-taxable limit that is applicable for investments in accumulated funds, for the unit holder. You can define individual limits for individual funds.

### **Fund ID**

*Alphanumeric; 6 Characters; Optional*

Select the fund for which you want to indicate a non-taxable limit for the investor.

### **Allowed Limit**

*Numeric; 28 Characters; Optional*

Specify the total non-tax limit that is applicable for investments across all non-accumulated funds, for the investor. This amount must not be higher than the total sanctioned limit across all funds that you specified in the previous section in this screen.

### **Utilized Limit**

*Display*

At any given date after you have created the non-taxable limit for a unit holder, the value displayed in this field reflects the portion of the limit defined for the selected accumulated fund that has been used up, as on the date, in investments in the fund. You cannot change this value at any juncture.

### **Fund Base Currency**

*Display*

The value displayed in this field reflects the portion of the limit, in fund base currency, defined for the selected accumulated fund that has been used up, as on the date of viewing, in investments in the fund. You cannot change this value at any juncture.

## **Non-Taxable Limits for Non-Accumulated Funds**

In this section, you specify the portion of the total non-taxable limit that is applicable for investments in non-accumulated funds, for the unit holder.

### **NonAcc Allowed Limit**

*Numeric; 22 Characters; Mandatory*

Specify the non accumulated allowed limit.

### **Utilized Amount**

*Display Only*

At any given date after you have created the non-taxable limit for a unit holder, the value displayed in this field reflects the portion of the limit defined for non-accumulated funds that

have been used up, as on the date, in investments in non-accumulated funds. You cannot change this value at any juncture.

## **4.10 UH Non Tax Limits Summary Screen**

This section contains the following topics:

- [Section 4.10.1, "Retrieving Non-Tax Limits for Investor"](#)
- [Section 4.10.2, "Editing Non-Tax Limits for Investor"](#)
- [Section 4.10.3, "Viewing Non-Tax Limits for Investor"](#)
- [Section 4.10.4, "Deleting Non-Tax Limits for Investor"](#)
- [Section 4.10.5, "Authorizing Non-Tax Limits for Investor"](#)
- [Section 4.10.6, "Amending Non-Tax Limits for Investor"](#)
- [Section 4.10.7, "Authorizing Amended Non-Tax Limits for Investor"](#)

### **4.10.1 Retrieving Non-Tax Limits for Investor**

After you set up the tax-exemption limits for an investor in the 'UH Non Tax Limits Setup Detail' screen, you can perform any of the following operations before the record is authorized:

- Edit the specified limits in the setup.
- Delete the setup.

To perform either operation, use the 'UH Non Tax Limits Summary' screen. You can invoke this screen by typing 'UTSUHNTX/ UTSURATX' in the field at the top right corner of the Application tool bar and clicking on the adjoining arrow button.

You can retrieve a previously entered record in the UH Non-Tax Limits Summary screen, as follows:

- Specify any or all of the following details in the UH Non-Tax Limits Summary screen:
- The status of the transaction in the Authorized field. If you choose the "Blank Space" option, then all the transactions that involve the specified unit holder are retrieved.
- The status of the Transaction in the Open field. If you choose the 'Blank Space' option, then all the records that involve the specified unit holder are retrieved.
- Unit Holder ID

Click 'Search' button to view the records. All records with the specified details are retrieved and displayed in the lower portion of the screen.

---

**Note**

You can also retrieve the individual transaction detail from the detail screen by doing query in the following manner:

- Press F7
  - Input the Unit Holder ID
  - Press F8
-

You can perform Edit, Delete, Amend, Authorize, Reverse, Confirm operation by selecting from the Action list.

You can also search the record by using combination of % and alphanumeric value.

### **Example**

You can search the record for Unit Holder ID by using the combination of % and alphanumeric value as follows:

- Search by A%: System will fetch all the records whose Unit Holder ID starts from Alphabet 'A'. For example: AGC17, AGVO6, AGC74 and so forth.
- Search by %7: System will fetch all the records whose Unit Holder ID ends by numeric value '7'. For example: AGC17, GSD267, AGC77 and so forth.
- Search by %17%: System will fetch all the records whose Unit Holder ID contains the numeric value 17. For example: GSD217, GSD172, AGC17 and so forth.

## **4.10.2 Editing Non-Tax Limits for Investor**

You can modify the details of UH Non-Tax Limits parameters that you have already entered into the system, provided it has not been subsequently authorized. You can perform this operation as follows:

- Invoke the UH Non-Tax Limits Summary screen from the Browser.
- Select the status of the record that you want to retrieve for modification in the Authorized field. You can only modify records that are unauthorized. Accordingly, choose the Unauthorized option.
- Specify any or all of the details in the corresponding fields to retrieve the record that is to be modified. All unauthorized records with the specified details are retrieved and displayed in the lower portion of the screen.
- Double click the record that you want to modify in the list of displayed transactions. The UH Non-Tax Limits Detail screen is displayed.
- Select Unlock Operation from Action list to modify the record. Modify the necessary information.
- Click Save to save your changes. The UH Non-Tax Limits Detail screen is closed and the changes made are reflected in the UH Non-Tax Limits Summary screen.

## **4.10.3 Viewing Non-Tax Limits for Investor**

To view a record that you have previously entered, you must retrieve the same in the UH Non-Tax Limits Summary screen, as follows:

- Invoke the UH Non-Tax Limits Summary Screen from the Browser.
- Select the status of the records that you want to retrieve for viewing in the Authorization Status field. You can also view all records that are either unauthorized or authorized only, by choosing the Unauthorized/ Authorized option.
- Specify any or all of the details of the records in the corresponding fields on the screen, and click 'Search' button. All records with the specified details are retrieved and displayed in the lower portion of the screen.
- Double click the record that you want to view in the list of displayed records. The UH Non-Tax Limits Detail screen is displayed in View mode.

## **4.10.4 Deleting Non-Tax Limits for Investor**

You can delete only unauthorized records in the system. To delete a record that you have previously entered:

- Invoke the UH Non-Tax Limits Summary screen from the Browser.
- Select the status of the record that you want to retrieve for deletion.
- Specify any or all of the details and click 'Search' button. All records with the specified details are retrieved and displayed in the lower portion of the screen.
- Double click the record that you want to delete. The UH Non-Tax Limits Detail screen is displayed.
- Select Delete operation from the Action list. The system prompts you to confirm the deletion, and the record is deleted physically from the system database.

#### **4.10.5 Authorizing Non-Tax Limits for Investor**

An unauthorized UH Non-Tax Limits record must be authorized in the system for it to be processed. To authorize a record:

- Invoke the UH Non-Tax Limits Summary screen from the Browser.
- Select the status of the record that you want to retrieve for authorization. Typically, choose the Unauthorized option.
- Specify any or all of the details of the record in the corresponding fields on the screen. Click 'Search' button. All record with the specified details that are pending authorization are retrieved and displayed in the lower portion of the screen.
- Double click the transaction that you wish to authorize. UH Non-Tax Limits Detail screen is displayed. Select Authorize operation from Action.

When the checker authorizes a transaction, details of validations, if any, that were overridden by the maker of the transaction during the Save operation, are displayed. If any of these overrides results in an error, the checker must reject the transaction.

#### **4.10.6 Amending Non-Tax Limits for Investor**

After a UH Non-Tax Limits record is authorized, it can be modified using the Unlock operation from Action list. To make changes to a record after authorization:

- Invoke the UH Non-Tax Limits Summary screen from the Browser.
- Select the status of the transaction that you wish to retrieve for amendment. You can only amend only authorized records.
- Specify any or all of the details of the UH Non-Tax Limits in the screen. All records with the specified details are retrieved and displayed in the lower portion of the screen.
- Double click the record that you want to amend. The UH Non-Tax Limits Detail screen is displayed in Amendment mode. Click the Unlock operation from the Action list to amend the record.
- Amend the necessary information. Click the Save button to save the changes.

When you retrieve a non-tax limits record for the purpose of amendment in this screen, it is displayed in the UH Non-Tax Limits Setup Detail screen, in Amend mode. All the non-editable field values are displayed as labels, while the editable fields are enabled for data entry changes.

---

#### **Note**

When you make changes to any authorized record in the system database through the amendment operation, the record with the amended information is saved as an unauthorized record in the system. For your amendment changes to be effective, the amended record must be subsequently authorized. When it is authorized, it is saved in the system database as an authorized record with the amendment information, and is effective.

If you change the non-tax limits at any level during amendment, the altered value must not fall below the utilized portion of the limits, as on the date of amendment. At any level, the utilized portion of the limits as on the date of viewing or amendment, are displayed in the Utilized Limit (or Amount) field on the screen.

---

### **Change of Information for a Non-Tax Limit Record through Amendment**

Changes to the non-tax limit record will be necessary in the following situations:

- The unit holder's non-tax limit has changed.
- The unit holder has been made legally ineligible for the non-tax limit, or the eligibility has been legally stopped or withdrawn.
- The death of the unit holder.

During amendment, you can specify the change that has been made, in the Change Information Status field. You must also specify the date on which the supporting documents for the change were received, in the Document Received Date field.

If the unit holder has been made legally ineligible to avail the non-tax limit, or the eligibility has been legally stopped, you must specify the non-tax limit to zero, in the Total Sanctioned Limit field.

#### **4.10.7 Authorizing Amended Non-Tax Limits for Investor**

When an amendment is made to a non-tax limits record for a unit holder, it must be authorized for the information change to take effect in the system and for the resultant processes to be initiated.

When an amendment resulting from the unit holder's non-tax limit being brought down to zero (i.e., the unit holder has been made legally ineligible or the eligibility has been stopped or withdrawn) is being authorized, the system displays a message stating that the non-taxable holdings of the unit holder will be converted to taxable holdings.

If the authorization is confirmed, the system triggers transactions that will convert the non-taxable units to taxable units. If any provisional holdings are present, the system forces the user to either confirm or reject the same. Redemptions will go through the normal taxation.

#### **The Inheritance Process (Return of Death Status)**

In the event of the death of the unit holder for whom a non-tax limit is in operation, you must specify the death, date of death and the receipt of the death certificate in the non-tax limits record, through an amendment. The date of death must be specified as mandatory information.

In the event of death of a unit holder with a non-tax limits record, you must manually enter redemption transactions or transfer transactions, before you specify the return of death status in the non-tax limits record. By this process, the non-taxable units held by the deceased unit holder are either redeemed, or transferred to the account of the legal heir, through a normal transfer transaction. If transferred, the system checks for the non-tax limit eligibility of the transferee unit holder. If the resulting transfer transaction exceeds the non-tax limit specified for the transferee unit holder, the spillover balance is added to the transferee's taxable holdings.

Redemptions will go through the normal taxation.

## 4.11 Unit Holder IRRF Preference Detail Screen

This section contains the following topics:

- [Section 4.11.1, "Setting up IRRF Preferences for a Unit Holder"](#)
- [Section 4.11.2, "Invoking Unit Holder IRRF Preference Detail Screen"](#)

### 4.11.1 Setting up IRRF Preferences for a Unit Holder

IRRF is equivalent of the income tax, and is paid as the percentage of the profit made post the application of IOF which is a tax paid for the profit made by the Unitholder, if a Unitholder redeems the funds within a stipulated time. Unit Holder IRRF preferences are applicable only for pension funds.

IRRF is usually paid on the last working day of May and November. Apart from paying IRRF on these fixed dates, IRRF is also paid during redemption. Any advance IRRF paid by the customer are adjusted while calculating the IRRF during redemption.

You can opt for optional IRRF load only within the stipulated number of days as specified in PARAMS maintenance. If the IRRF preferences have not been setup from the date of first subscription for a given combination of unit holder and fund within the stipulated number of days, default IRRF will be considered. Whenever judicial blocking or redemption occurs before the preferences have been setup in the system, default IRRF load will be considered for IRRF calculation and you will not be allowed to maintain the preferences then on.

---

#### **Note**

This feature is only available if your installation has requested for it.

---



## 4.11.2 Invoking Unit Holder IRRF Preference Detail Screen

To set up unit holder preferences for the IRRF component, use the 'Unit Holder IRRF Preference Detail' screen. You can invoke this screen by typing 'UTDUHIOF' in the field at the top right corner of the Application tool bar and clicking on the adjoining arrow button.

Unit Holder IRRF Preference Detail

Save

Client Information

Unit Holder ID \*      Unit Holder Name

CIF Number      Find UH

IRRF Details

Fund ID \*      ISIN Code

Fund Name      Load ID \*

Load Description      Load Details

Load Details

Load Calculation Method      Amount Or Percentage

Load Details

Slab Sequence No	From Period	To Period	Period basis	Return Value
<input checked="" type="checkbox"/>				

Input by      DateTime      Mod No      Open

Authorized by      DateTime      Authorized      Cancel

Select 'New' from the Actions menu in the Application tool bar or click new icon to enter the details of the Unit Holder IRRF Preference screen.

### **Client Information**

#### **Unit Holder ID**

*Alphanumeric; 12 Characters; Mandatory*

Specify the ID of the unit holder ID for whom IRRF details are being maintained.

#### **Unitholder Name**

*Display*

The name of the unit holder is defaulted here once the unit holder ID is provided.

#### **CIF Number**

*Display*

The system displays the CIF number of the customer for the selected unit holder ID.

You can query unit holder ID by clicking 'Find UH' button.

## **IRRF Details Section**

### **Fund ID**

*Alphanumeric; 6 Characters; Mandatory*

Specify the fund ID. All the pension funds with a valid fund ID maintained through the General Operating Rules screen for IOF / IRRF Ageing based funds are displayed in the option list.

### **Fund Name**

*Display*

The system displays the name of the fund for the selected fund ID.

### **ISIN Code**

*Display*

The system displays the ISIN Code of the selected fund.

### **Load ID**

*Numeric; 5 Characters; Mandatory*

Select the IRRF Load id from the option list which displays all the IRRF Loads which mapped to the fund.

### **Load Description**

*Display*

On selection of the Fund ID Code, the system automatically displays the description of the fund.

On Selection of the IRRF Load the Load Details Section is displayed.

---

### **Note**

You are allowed to opt for optional IRRF load only within the stipulated number of days as specified in PARAMS maintenance.

---

## **Load Details**

Click 'Load Details' button to view the following details.

### **Load Calculation Method**

*Display*

The system displays the load maintained.

This is same as one available in Load section in FMG and it defaults from the load maintained.

### **Amount Or Percentage**

*Display*

The system displays the amount or percentage value.

This is same as one available in Load section in FMG and it defaults from the load maintained.

The Load Details Section displays the following

- Slab Sequence No
- From Period
- To Period
- Period Basis

- Return Value

---

**Note**

You cannot amend the unit holder IRRF preferences once it is maintained in the system.

---

## **4.12 Unit Holder IRRF Preference Summary Screen**

This section contains the following topics:

- [Section 4.12.1, "Retrieving IRRF Preferences for Investors"](#)
- [Section 4.12.2, "Editing IRRF Preferences for Investors"](#)
- [Section 4.12.3, "Viewing IRRF Preferences for Investors"](#)
- [Section 4.12.4, "Deleting IRRF Preferences for Investors"](#)
- [Section 4.12.5, "Authorizing IRRF Preferences for Investors"](#)
- [Section 4.12.6, "Amending IRRF Preferences for Investors"](#)
- [Section 4.12.7, "Authorizing Amended IRRF Preferences for Investors"](#)

### **4.12.1 Retrieving IRRF Preferences for Investors**

After you setup Unit Holder IRRF Preference for an investor, in the 'IRRF Unit Holder Preferences' screen, you can perform any of the following operations before the record is authorized:

- Edit the preferences.
- Delete the record.

To perform either of the operation, use the 'Unit Holder IRRF Preference Summary' screen. You can invoke this screen by typing 'UTSUHIOF' in the field at the top right corner of the Application tool bar and clicking on the adjoining arrow button.

You can retrieve a previously entered record in the 'Unit Holder IRRF Preference Summary' screen, as follows:

- Specify any or all of the following details in the Unit Holder IRRF Preference Summary screen:
- The status of the Unit Holder IRRF Preference in the Authorized field. If you choose the "Blank Space" option, then all the Unit Holder IRRF Preference that involves the specified unit holder are retrieved.
- The status of the Unit Holder IRRF Preference in the Open field. If you choose the "Blank Space" option, then all the Unit Holder IRRF Preference that involves the specified unit holder are retrieved.
- The Unit Holder ID
- The Fund ID
- The Load ID

Click 'Search' button to view the records. All records with the specified details are retrieved and displayed in the lower portion of the screen.

---

#### Note

You can also retrieve the individual Unit Holder IRRF Preference detail from the detail screen by doing query in the following manner:

- Press F7

- Input the Unit Holder ID
  - Press F8
- 

You can perform Edit, Delete, Amend, Authorize, Reverse, Confirm operation by selecting from the Action list.

You can also search the record by using combination of % and alphanumeric value.

### **Example**

You can search the record for Unit Holder ID by using the combination of % and alphanumeric value as follows:

- Search by A%: System will fetch all the records whose Unit Holder ID starts from Alphabet 'A'. For Example: AGC17, AGVO6, AGC74 and so forth.
- Search by %7: System will fetch all the records whose Unit Holder ID ends by numeric value '7'. For Example: AGC17, GSD267, AGC77 and so forth.
- Search by %17%: System will fetch all the records whose Unit Holder ID contains the numeric value 17. For Example: GSD217, GSD172, AGC17 and so forth.

## **4.12.2 Editing IRRF Preferences for Investors**

You can modify the details of Unit Holder IRRF Preference parameters that you have already entered into the system, provided it has not been subsequently authorized. You can perform this operation as follows:

- Invoke the Unit Holder IRRF Preference Summary screen from the Browser.
- Select the status of the record that you want to retrieve for modification in the Authorized field. You can only modify records that are unauthorized. Accordingly, choose the Unauthorized option.
- Specify any or all of the details in the corresponding fields to retrieve the record that is to be modified. All unauthorized records with the specified details are retrieved and displayed in the lower portion of the screen.
- Double click the record that you want to modify in the list of displayed record. The Unit Holder IRRF Preference Detail screen is displayed.
- Select Unlock Operation from Action list to modify the record. Modify the necessary information.
- Click Save to save your changes. Unit Holder IRRF Preference Detail screen is closed and the changes made are reflected in the Unit Holder IRRF Preference Summary screen.

## **4.12.3 Viewing IRRF Preferences for Investors**

To view a record that you have previously entered, you must retrieve the same in the Unit Holder IRRF Preference Summary screen, as follows:

- Invoke the Unit Holder IRRF Preference Summary Screen from the Browser.
- Select the status of the Unit Holder IRRF Preference that you want to retrieve for viewing in the Authorized field. You can also view all records that are either unauthorized or authorized only, by choosing the Unauthorized/ Authorized option.
- Specify any or all of the details of the record in the corresponding fields on the screen, and click 'Search' button. All records with the specified details are retrieved and displayed in the lower portion of the screen.
- Double click the record that you want to view in the list of displayed records. The Unit Holder IRRF Preference Detail screen is displayed in View mode.

#### **4.12.4 Deleting IRRF Preferences for Investors**

You can delete only unauthorized records in the system. To delete a record that you have previously entered:

- Invoke the Unit Holder IRRF Preference Summary screen from the Browser.
- Select the status of the record that you want to retrieve for deletion.
- Specify any or all of the details and click 'Search' button. All record with the specified details are retrieved and displayed in the lower portion of the screen.
- Double click the record that you want to delete. The Unit Holder IRRF Preference Detail screen is displayed.
- Select Delete operation from the Action list. The system prompts you to confirm the deletion, and the record is deleted physically from the system database.

#### **4.12.5 Authorizing IRRF Preferences for Investors**

An unauthorized Unit Holder IRRF Preference record must be authorized in the system for it to be processed. To authorize a record:

- Invoke the Unit Holder IRRF Preference Summary screen from the Browser.
- Select the status of the record that you want to retrieve for authorization. Typically, choose the Unauthorized option.
- Specify any or all of the details of the record in the corresponding fields on the screen. Click 'Search' button. All records with the specified details that are pending authorization are retrieved and displayed in the lower portion of the screen.
- Double click the transaction that you wish to authorize. Unit Holder IRRF Preference Detail screen is displayed. Select Authorize operation from Action.

When the checker authorizes a Unit Holder IRRF Preference, details of validations, if any, that were overridden by the maker of the transaction during the Save operation, are displayed. If any of these overrides results in an error, the checker must reject the Unit Holder IRRF Preference.

#### **4.12.6 Amending IRRF Preferences for Investors**

After an Unit Holder IRRF Preference record is authorized, it can be modified using the Unlock operation from Action list. To make changes to a transaction after authorization:

- Invoke the Unit Holder IRRF Preference Summary screen from the Browser.
- Select the status of the Unit Holder IRRF Preference that you wish to retrieve for amendment. You can only amend only authorized records.
- Specify any or all of the details of the Unit Holder IRRF Preference in the screen. All records with the specified details are retrieved and displayed in the lower portion of the screen.
- Double click the record that you want to amend. The Unit Holder IRRF Preference Detail screen is displayed in Amendment mode. Click the Unlock operation from the Action list to amend the record.
- Amend the necessary information. Click the Save button to save the changes.

#### **4.12.7 Authorizing Amended IRRF Preferences for Investors**

An amended Unit Holder IRRF Preference record must be authorized for the amendment to be made effective in the system. The authorization of amended records can only be done from Fund Manager Module and Agency branch Module.

The process of authorization is subsequently the same as that for normal Unit Holder IRRF Preference.

## 4.13 Unit Holder NPI Preference Detail Screen

This section contains the following topics:

- [Section 4.13.1, "Invoking Unit Holder NPI Preference Detail Screen"](#)

### 4.13.1 Invoking Unit Holder NPI Preference Detail Screen

As per *Shariah* principle of 'cleansing' the fund of 'impure' income the earnings derived out of any dividend exceeding a certain benchmark cannot be reinvested. This portion of the earnings is classified as Non Permissible Income (NPI). The investor can either choose to receive the NPI component as income or pay the same to a trust.

To set up a Unit Holder NPI payment preference use the 'Unit Holder NPI Preference Detail' screen. You can invoke this screen by typing 'UTDUHNPI' in the field at the top right corner of the Application tool bar and clicking on the adjoining arrow button.

Input by	DateTime	Mod No	Open
Authorized by	DateTime		Authorized

Select 'New' from the Actions menu in the Application tool bar or click new icon to enter the details of the Unit Holder NPI Preference screen.

#### Unit Holder Dividend NPI Preference

##### **Unit Holder ID**

*Alphanumeric; 12 Characters; Mandatory*

Specify the ID of the unit holder for whom you are maintaining the NPI preferences in this screen. You can also query for unit holder ID by clicking 'Find UH' button.

##### **CIF Number**

*Display*

The system displays the CIF number.

##### **Unit Holder Name**

*Display*

The system displays the name of CIF unit holder for the selected unit holder ID.

## NPI Payment

### Mandatory

If the investor opts to receive the NPI component as income, then select 'Pay to Unit Holder' from drop-down list.

### Remarks

*Alphanumeric; 255 Characters; Optional*

You can enter any applicable narrative or descriptive text here.

## 4.14 Unit Holder NPI Preference Summary Screen

This section contains the following topics:

- [Section 4.14.1, "Retrieving NPI Payment Preferences for Investors"](#)
- [Section 4.14.2, "Editing NPI Payment Preferences for Investors"](#)
- [Section 4.14.3, "Viewing NPI Payment Preferences for Investors"](#)
- [Section 4.14.4, "Deleting NPI Payment Preferences for Investors"](#)
- [Section 4.14.5, "Authorizing NPI Payment Preferences for Investors"](#)
- [Section 4.14.6, "Amending NPI Payment Preferences for Investors"](#)
- [Section 4.14.7, "Authorizing Amended NPI Payment Preferences for Investors"](#)

### 4.14.1 Retrieving NPI Payment Preferences for Investors

After you setup the NPI preferences for an investor, in the NPI UnitHolder Preferences screen, you can perform any of the following operations before the record is authorized:

- Edit the preferences
- Delete the record

To perform either of the operation, use the 'Unit Holder NPI Preference Summary' screen. You can invoke this screen by typing 'UTSUHNPI' in the field at the top right corner of the Application tool bar and clicking on the adjoining arrow button.

The screenshot shows a web application window titled "Unit Holder NPI Preference Summary". At the top, there are search and navigation options: "Search", "Advanced Search", "Reset", and "Clear All". Below this, there is a section for search criteria, including a "Search Is Case Sensitive" checkbox, dropdown menus for "Authorized" and "Open", and a text input field for "Unit Holder ID". A table with the following columns is displayed: "Authorized", "Open", "Unit Holder ID", "CIF Number", and "NPI Payment". The table contains several empty rows. At the bottom right of the window, there is an "Exit" button.



You can retrieve a previously entered record in the UH NPI Preference Summary screen, as follows:

- Specify any or all of the following details in the UH NPI Preference Summary screen:
- The status of the transaction in the Authorized field. If you choose the “Blank Space” option, then all the record that involves the specified unit holder are retrieved.
- The status of the Transaction in the Open field. If you choose the “Blank Space” option, then all the transactions that involve the specified unit holder are retrieved.
- The Unit Holder ID

Click ‘Search’ button to view the records. All records with the specified details are retrieved and displayed in the lower portion of the screen.

---

#### **Note**

You can also retrieve the individual record detail from the detail screen by doing query in the following manner:

- Press F7
  - Input the Unit Holder ID
  - Press F8
- 

You can perform Edit, Delete, Amend, Authorize, Reverse, Confirm operation by selecting from the Action list.

You can also search the record by using combination of % and alphanumeric value.

#### **Example**

You can search the record for Unit Holder ID by using the combination of % and alphanumeric value as follows:

- Search by A%: System will fetch all the records whose Unit Holder ID starts from Alphabet ‘A’. For example: AGC17, AGVO6, AGC74 and so forth.
- Search by %7: System will fetch all the records whose Unit Holder ID ends by numeric value ‘7’. For Example: AGC17, GSD267, AGC77 and so forth.
- Search by %17%:- System will fetch all the records whose Unit Holder ID contains the numeric value 17. For Example: GSD217, GSD172, AGC17 and so forth.

### **4.14.2 Editing NPI Payment Preferences for Investors**

You can modify the details of UH NPI Preference parameters that you have already entered into the system, provided it has not been subsequently authorized. You can perform this operation as follows:

- Invoke the UH NPI Preference Summary screen from the Browser.
- Select the status of the record that you want to retrieve for modification in the Authorization Status field. You can only modify records that are unauthorized. Accordingly, choose the Unauthorized option.
- Specify any or all of the details in the corresponding fields to retrieve the record that is to be modified. All unauthorized records with the specified details are retrieved and displayed in the lower portion of the screen.
- Double click the record that you want to modify in the list of displayed transactions. The UH NPI Preference Detail screen is displayed.

- Select Unlock Operation from Action list to modify the record. Modify the necessary information.
- Click Save to save your changes. The UH NPI Preference Detail screen is closed and the changes made are reflected in the UH NPI Preference Summary screen.

#### **4.14.3 Viewing NPI Payment Preferences for Investors**

To view a record that you have previously entered, you must retrieve the same in the UH NPI Preference Summary screen, as follows:

- Invoke the UH NPI Preference Summary Screen from the Browser.
- Select the status of the transaction that you want to retrieve for viewing in the Authorization Status field. You can also view all records that are either unauthorized or authorized only, by choosing the Unauthorized / Authorized option.
- Specify any or all of the details of the record in the corresponding fields on the screen, and click 'Search' button. All records with the specified details are retrieved and displayed in the lower portion of the screen.
- Double click the record that you want to view in the list of displayed records. The UH NPI Preference Detail screen is displayed in View mode.

#### **4.14.4 Deleting NPI Payment Preferences for Investors**

You can delete only unauthorized records in the system. To delete a record that you have previously entered:

- Invoke the UH NPI Preference Summary screen from the Browser.
- Select the status of the record that you want to retrieve for deletion.
- Specify any or all of the details and click 'Search' button. All records with the specified details are retrieved and displayed in the lower portion of the screen.
- Double click the record that you want to delete. The In UH NPI Preference Detail screen is displayed.
- Select Delete operation from the Action list. The system prompts you to confirm the deletion, and the record is deleted physically from the system database.

#### **4.14.5 Authorizing NPI Payment Preferences for Investors**

An unauthorized UH NPI Preference record must be authorized in the system for it to be processed. To authorize a record:

- Invoke the UH NPI Preference Summary screen from the Browser.
- Select the status of the record that you want to retrieve for authorization. Typically, choose the Unauthorized option.
- Specify any or all of the details of the record in the corresponding fields on the screen. Click 'Search' button. All transactions with the specified details that are pending authorization are retrieved and displayed in the lower portion of the screen.
- Double click the transaction that you wish to authorize. The UH NPI Preference Detail screen is displayed. Select Authorize operation from Action.

When the checker authorizes a transaction, details of validations, if any, that were overridden by the maker of the transaction during the Save operation, are displayed. If any of these overrides results in an error, the checker must reject the transaction.

#### **4.14.6 Amending NPI Payment Preferences for Investors**

After an UH NPI Preference record is authorized, it can be modified using the Unlock operation from Action list. To make changes to a transaction after authorization:

- Invoke the UH NPI Preference Summary screen from the Browser.
- Select the status of the transaction that you wish to retrieve for amendment. You can only amend only authorized records.
- Specify any or all of the details of the UH NPI Preference in the screen. All records with the specified details are retrieved and displayed in the lower portion of the screen.
- Double click the record that you want to amend. The UH NPI Preference Detail screen is displayed in Amendment mode. Click the Unlock operation from the Action list to amend the record.
- Amend the necessary information. Click the Save button to save the changes.

When you retrieve an NPI payment preferences record for the purpose of amendment in this screen, it is displayed in the NPI UnitHolder Preferences screen, in Amend mode. All the non-editable field values are displayed as labels, while the editable fields are enabled for data entry changes.

---

#### **Note**

When you make changes to any authorized record in the system database through the amendment operation, the record with the amended information is saved as an unauthorized record in the system. For your amendment changes to be effective, the amended record must be subsequently authorized. When it is authorized, it is saved in the system database as an authorized record with the amendment information, and is effective.

---

#### **4.14.7 Authorizing Amended NPI Payment Preferences for Investors**

An amended UH NPI Preference record must be authorized for the amendment to be made effective in the system. The authorization of amended records can only be done from Fund Manager Module and Agency branch Module.

The process of authorization is subsequently the same as that for normal transactions.

### **4.15 Fund UH Category Minimum Holding Period Details Screen**

This section contains the following topic:

- [Section 4.15.1, "Invoking Fund UH Category Minimum Holding Period Details Screen"](#)

#### **4.15.1 Invoking Fund UH Category Minimum Holding Period Details Screen**

You can capture the minimum holding period at Fund/ UH category/Transaction Type level using 'Fund UH Category Minimum Holding Period Detail' screen.

You can invoke this screen by typing 'UTDMINHL' in the field at the top right corner of the Application tool bar and click the adjoining arrow. The screen is displayed below:

In this screen you can maintain the following details:

### **Fund ID**

*Alphanumeric; 6 Characters; Mandatory*

Specify the fund of the unit holder. You can also select the fund from the option list provided. The list consists of valid and authorized funds maintained in the system.

### **Fund Name**

*Display*

Based on the ID selected, the name of the fund is displayed.

### **Transaction Type**

*Alphanumeric; 2 Characters; Mandatory*

Specify the type of the transaction. You can also select the transaction type from the option list provided.

### **Description**

*Display*

The description of the transaction type is displayed.

### **Rule for SI**

*Optional*

Select any of the following option from the drop-down list:

- First SI Transaction Date – On selecting this option, the system validates the minimum holding period by considering the SI first generation date i.e. the transaction date of the first transaction generated by the SI, which has not been reversed
- Default – On selecting this option, the minimum holding period will be validated considering last inflow date of transaction and current transaction date

## **Details**

### **UH Category**

*Alphanumeric; 2 Characters; Mandatory*

Specify the category of the unit holder. You can also select the UH category from the option list provided. The list consists of valid and authorized UH Categories maintained in the system.

### **Description**

*Display*

The description of the selected category is displayed.

### **Minimum Holding Period**

*Numeric; 5 Characters; Optional*

Indicate the number of days required for minimum holding.

### **Mandatory**

*Optional*

Check this option to indicate that the minimum holding period for fund/UH category wise is mandatory. If this option is checked, then on violating minimum holding period, the system displays an error message and the transaction will not be saved.

Click on Cancel to cancel the operation. Click on the save icon to save the details and you will be shown the following message:

The system displays the confirmation message as "Record Successfully Saved".

Click Ok and in the main screen click Exit button to exit.

The system displays the error message as "Failed to Save the Record".

If this option is unchecked, then on violating minimum holding period, an overriding message is triggered. However, you can save the transaction by overriding the message.

On saving the redemption/switch/transfer transaction, the system checks if any of the allotted inflow transaction (like subscription, switch in, transfer in) has been captured within the minimum holding period (based on the difference of the transaction date). If it exists, then an overriding message 'There are some inflow transactions within the Minimum Holding Period' is displayed along with any other warnings, if applicable.

---

### **Note**

Checking minimum holding period maintained at the UH Category level is independent of checking minimum holding period at fund level.

---

## **Example**

**Case 1:** Inflow involves transactions like subscriptions, switch-in, SI etc

Current Redemption Transaction Date: 10-May-2008

Minimum Holding Period at Fund/UH Category: 30

Last inflow transaction date for this Fund: 18-Apr-2008

No. of Days elapsed from date of last inflow transaction (10/May/08 -18/Apr/08): 22

Since the difference between last inflow date of the transaction and the current transaction date is less than Minimum Holding period, the system triggers a warning message 'There are some inflow transactions with in the Minimum Holding Period'. This transaction is saved only if the warning is accepted.

If the number of days elapsed from the date of last inflow transaction to current redemption transaction date is more than the minimum holding period defined at Fund/UH Category for redemption transaction type, the system will save the transaction without the above warning message.

**Case 2:** Inflow is only because of SI transaction

Rule for SI set up in new maintenance : First SI Transaction Date

The First SI subscription date for this fund: 10-Apr-2008

Current Normal Redemption transaction date: 05-May-2008

Minimum Holding Period for the Fund/UH Cat.: 30

Whether any inflow transactions other than SI: No

No. of Days elapsed from the first SI subscription transaction date (05/May/08 -10/Apr/08): 25

Since the difference between last inflow date of the transaction and the current transaction date is less than Minimum Holding period, the system triggers a warning message 'There are some inflow transactions with in the Minimum Holding Period'. This transaction is saved only if the warning is accepted.

If the outflow is because of the SI redemption transaction, the system will save the transaction without any warning.

If there were some other inflow transactions other than SI with in this period, then system will consider Last inflow transaction date instead of the first SI subscription transaction date for arriving at the no. of days elapsed.

## **4.16 Fund UH Category Minimum Holding Period Summary Screen**

This section contains the following topics:

- [Section 4.16.1, "Retrieving/Viewing minimum holding period at Fund/UH category/ transaction level"](#)
- [Section 4.16.2, "Editing Minimum Holding period at Fund/UH Category/Transaction Level"](#)
- [Section 4.16.3, "Deleting Minimum Holding Period at Fund/UH Category/Transaction Level"](#)
- [Section 4.16.4, "Authorizing Minimum Holding Period at Fund/UH Category/Transaction Level"](#)
- [Section 4.16.5, "Amending Minimum Holding Period at Fund/UH Category/Transaction Level"](#)

#### 4.16.1 Retrieving/Viewing minimum holding period at Fund/UH category/transaction level

The minimum holding period defined at the fund/UH category/ transaction type level must be authorized by another user. You can use the 'Fund UH Category Minimum Holding Period Summary' screen to perform the following operations:

- Retrieve
- Edit
- Delete
- Authorize
- Amend

You can invoke this screen by typing 'UTSMINHL' in the field at the top right corner of the Application tool bar and click the adjoining arrow. The screen is displayed below:

The screenshot shows the 'Fund UH Category Minimum Holding Period Summary' application window. At the top, there are search options: 'Search', 'Advanced Search', 'Reset', and 'Clear All'. Below this, a search bar indicates 'Search Is Case Sensitive'. The search criteria section includes five fields: 'Authorized' (dropdown), 'Open' (dropdown), 'Fund ID' (text input), 'Transaction Type' (text input), and 'Rule for SI' (dropdown). Below the search fields is a table with a header row containing the column names: 'Authorized', 'Open', 'Fund ID', 'Transaction Type', and 'Rule for SI'. The table body is currently empty. At the bottom right of the window, there is an 'Exit' button.

You can retrieve/view the UH minimum holding period record as follows:

- Invoke the 'Fund UH Category Minimum Holding Period Summary' screen from the Browser.
- Specify any or all of the following details in the screen:
  - The status of the transaction in the 'Authorized' field. If you choose the blank space, then both the authorized and the unauthorized status records will be retrieved for the specified criteria.
  - The status of the records in the 'Open' field. If you choose the blank space, then all the records are retrieved.
  - The fund ID in the 'Fund ID' field. If you choose the blank space, then all the records are retrieved.
  - The type of transaction in the 'Transaction Type' field. If you choose the blank space, then all the records are retrieved.
  - The rule for standing instruction in the 'Rule for SI' field.

- Click 'Search' button to view the records. All records with the specified details are retrieved and displayed in the lower portion of the screen.
- Double click the record that you want to view in the list of displayed records. The 'Fund UH Category Minimum Holding Period Detail' screen is displayed in the view mode.

#### **4.16.2 Editing Minimum Holding period at Fund/UH Category/Transaction Level**

You can modify the details that you have already entered into the system, provided it has not been subsequently authorized. You can perform this operation as follows:

- Invoke the 'Fund UH Category Minimum Holding Period Summary' screen from the Browser.
- Specify any or all of the following details in the screen:
  - The status of the transaction in the 'Authorized' field. If you choose the blank space, then both the authorized and the unauthorized status records will be retrieved for the specified criteria.
  - The status of the records in the 'Open' field. If you choose the blank space, then all the records are retrieved.
  - The fund ID in the 'Fund ID' field. If you choose the blank space, then all the records are retrieved.
  - The type of transaction in the 'Transaction Type' field. If you choose the blank space, then all the records are retrieved.
  - The rule for standing instruction in the 'Rule for SI' field.
- Click 'Search' button to view the records. All records with the specified details are retrieved and displayed in the lower portion of the screen.
- Double click the record that you want to modify in the list of displayed records. The 'Fund UH Category Minimum Holding Period Detail' screen is displayed.
- Select Unlock operation from the Action list to modify the record. Modify the necessary information.
- Click Save to save your changes. The 'Fund UH Category Minimum Holding Period Detail' screen is closed and the changes made are reflected in the 'Fund UH Category Minimum Holding Period Summary' screen.

#### **4.16.3 Deleting Minimum Holding Period at Fund/UH Category/Transaction Level**

You can delete only unauthorized records in the system. To delete a record that you have previously entered:

- Invoke the 'Fund UH Category Minimum Holding Period Summary' screen from the Browser.
- Specify any or all of the following details in the screen:
  - The status of the transaction in the 'Authorized' field. If you choose the blank space, then both the authorized and the unauthorized status records will be retrieved for the specified criteria.
  - The status of the records in the 'Open' field. If you choose the blank space, then all the records are retrieved.
  - The fund ID in the 'Fund ID' field. If you choose the blank space, then all the records are retrieved.
  - The type of transaction in the 'Transaction Type' field. If you choose the blank space, then all the records are retrieved.
  - The rule for standing instruction in the 'Rule for SI' field.



- Click 'Search' button to view the records. All records with the specified details are retrieved and displayed in the lower portion of the screen.
- Double click the record that you want to delete. The 'Fund UH Category Minimum Holding Period Detail' screen is displayed.
- Select Delete operation from the Action list. The system prompts you to confirm the deletion, and the record is deleted physically from the system database.

---

**Note**

The maker of the record can only delete the unauthorized record.

---

#### **4.16.4 Authorizing Minimum Holding Period at Fund/UH Category/Transaction Level**

Apart from the maker, someone else must authorize an unauthorized broker deal in the system for it to be processed. To authorize a record:

- Invoke the 'Fund UH Category Minimum Holding Period Summary' screen from the Browser.
- 'The status of the transaction in the 'Authorized' field. Choose the 'Unauthorized' status.
- Click 'Search' button to view the records. All the records with the specified details that are pending authorization are retrieved and displayed in the lower portion of the screen.
- Select the Authorization operation from the Action list to authorize the selected record.

#### **4.16.5 Amending Minimum Holding Period at Fund/UH Category/Transaction Level**

After a UH minimum holding period is authorized, it can be modified using the Unlock operation from Action list. To make changes to a record after authorization:

- Invoke the 'Fund UH Category Minimum Holding Period Summary' screen from the Browser.
- Select the status of the transaction that you wish to retrieve for amendment. You can only amend only authorized records.
- Click 'Search' button to view the records. All records with the specified details are retrieved and displayed in the lower portion of the screen.
- Double click the record that you want to amend. The 'Fund UH Category Minimum Holding Period Detail' screen is displayed in the amendment mode. Click the Unlock operation from the Action list to amend the record.
- Amend the necessary information. Click the Save button to save the changes.

### **4.17 UH Status Change Detail Screen**

This section contains the following topics:

- [Section 4.17.1, "Closing an Unit Holder Account"](#)
- [Section 4.17.2, "Invoking UH Status Change Detail Screen"](#)

#### **4.17.1 Closing an Unit Holder Account**

The investor may wish at any juncture, to close operations with the AMC. At such a time, the account maintained for the investor in the system database must be closed. To close a unit holder account, use the 'Unitholder Status Change Detail' screen. You can invoke this screen

by typing 'UTDACCLS' in the field at the top right corner of the Application tool bar and clicking on the adjoining arrow button.

Specify the following information in this screen:

- The ID of the unit holder whose account you want to close
- The reason for closure or any description / narrative regarding the same, in the Closure Remarks field.

In the event of an account closure request, the holdings of the investor in all funds transacted in must be brought down to zero. Therefore, when you close a unit holder account in the system, the following events take place:

- If the unit holder has entered into transactions, then the status of account is marked as Pending Closure.
- Subsequently, in this state, this account is still valid in the system, but it cannot be edited or amended (as the case may be), or used to enter into any further transactions. If the unit holder avails the check writing facility, any checks that have been issued through check-writing facility are marked invalid.
- After the transactions are allocated, and the holdings of the unit holder in all the funds that have been transacted in are brought down to zero, the status of the account is marked as Closed, and the account is then no longer valid in the system.

You can close any unit holder account, except in the following circumstances:

- The account is an unauthorized account in any way. The account closure facility applies only to authorized accounts. There must not be any details (whether new or amended) pending authorization.
- The agency branch from which the closure request is being made is not the one where the account was created. An account can be closed only in the branch where it was opened.

## 4.17.2 Invoking UH Status Change Detail Screen

Invoke the 'UH Status Change Detail' screen by typing 'UTDACCLS' in the field at the top right corner of the Application tool bar and clicking on the adjoining arrow button.

UnitHolder Status Change Detail

Save

Client Information

Unit Holder ID \*

CIF Number

Closure Remarks

Closure Reference No

UH Status

Current Status

A/C Status Date

Unit Holder Name

Find UH

Input by  DateTime  Mod No  Open

Authorized by  DateTime  Authorized

Cancel

Select 'New' from the Actions menu in the Application tool bar or click new icon to enter the details in the screen.

## **Client Information**

### **Unit Holder ID**

*Alphanumeric; 12 Characters; Mandatory*

Specify the ID of the non-CIF unit holder whose account you are closing. The name of the unit holder that you select is displayed alongside the field.

### **CIF Number**

*Display*

The system displays the CIF number for the selected unit holder ID.

### **Unit Holder Name**

*Display*

The system displays the name of CIF unit holder for the selected unit holder ID.

You can query for unit holder ID by clicking 'Find UH' button.

### **A/C Status Date**

*Date Format; Optional*

Select the account status date on which the account closure request is entered from the adjoining calendar.

### **Closure Remarks**

*Alphanumeric; 70 Characters; Optional*

Specify the reason for closing the account.

### **Closure Reference No**

*Alphanumeric; 12 Characters; Optional*

Specify the reference number of the unit holder account that you are closing.

### **UH Status**

*Optional*

Specify the status for the unit holder whose account is being processed. The statuses are:

- Active
- Closed

To close an account select 'Closed'; to re-open a closed account select 'Active'.

### **Current Status**

*Display*

The system will display the current status of the unit holder account. You can re-open a closed account only if the current status of the account is 'Pending for Closure'.

## **4.18 Unit Holder Status Change Summary Screen**

This section contains the following topics:

- [Section 4.18.1, "Retrieving Status Change"](#)
- [Section 4.18.2, "Editing Status Change"](#)
- [Section 4.18.3, "Viewing Status Change"](#)

- [Section 4.18.4, "Deleting Status Change"](#)
- [Section 4.18.5, "Authorizing Status Change"](#)
- [Section 4.18.6, "Amending Status Change"](#)
- [Section 4.18.7, "Authorizing Amended Status Change"](#)

#### 4.18.1 Retrieving Status Change

After you setup the NPI preferences for an investor, in the NPI UnitHolder Preferences screen, you can perform any of the following operations before the record is authorized:

- Edit the preferences
- Delete the record

To authorize the closure of an investor account, use the 'Unitholder Status Change Summary' screen. You can invoke this screen by typing 'UTSACCLS' in the field at the top right corner of the Application tool bar and clicking on the adjoining arrow button.

You can retrieve a previously entered record in the UnitHolder Status Change Summary screen, as follows:

- Specify any or all of the following details in the UnitHolder Status Change Summary screen:
  - The status of the transaction in the Authorized field. If you choose the "Blank Space" option, then all the transactions that involve the specified unit holder are retrieved.
  - The status of the Transaction in the Open field. If you choose the "Blank Space" option, then all the transactions that involve the specified unit holder are retrieved.
  - Unit Holder ID
  - Closure Remarks
  - Closure Reference No

Click 'Search' button to view the records. All records with the specified details are retrieved and displayed in the lower portion of the screen.

---

**Note**

You can also retrieve the individual record detail from the detail screen by doing query in the following manner:

- Press F7
  - Input the Unit Holder ID
  - Press F8
- 

You can perform Edit, Delete, Amend, Authorize, Reverse, Confirm operation by selecting from the Action list.

You can also search the record by using combination of % and alphanumeric value.

**Example**

You can search the record for Unit Holder ID by using the combination of % and alphanumeric value as follows:

Search by A%: System will fetch all the records whose Unit Holder ID starts from Alphabet 'A'. For example: AGC17, AGVO6, AGC74 and so forth.

Search by %7: System will fetch all the records whose Unit Holder ID ends by numeric value '7'. For example: AGC17, GSD267, AGC77 and so forth.

Search by %17%: System will fetch all the records whose Unit Holder ID contains the numeric value 17. For Example: GSD217, GSD172, AGC17 and so forth.

#### **4.18.2 Editing Status Change**

You can modify the details of Unit Holder Status Change parameters that you have already entered into the system, provided it has not been subsequently authorized. You can perform this operation as follows:

- Invoke the UnitHolder Status Change Summary screen from the Browser.
- Select the status of the record that you want to retrieve for modification in the Authorization Status field. You can only modify records that are unauthorized. Accordingly, choose the Unauthorized option.
- Specify any or all of the details in the corresponding fields to retrieve the record that is to be modified. All unauthorized records with the specified details are retrieved and displayed in the lower portion of the screen.
- Double click the record that you want to modify in the list of displayed records. The UnitHolder Status Change Detail screen is displayed.
- For editing, click the 'Unlock Action' at the upper left end of the required row in the result list. The selected closure record is displayed in edit mode in the 'UH A/c Closure Detail' screen. All editable value fields are enabled for modification, and the values for all non-editable fields appear as labels. Make your changes and Save the record.
- Click Save to save your changes. The UnitHolder Status Change Detail screen is closed and the changes made are reflected in the UnitHolder Status Change Summary screen.

#### **4.18.3 Viewing Status Change**

To view a record that you have previously entered, you must retrieve the same in the Unit Holder Status Change Summary screen, as follows:

- Invoke the Unit Holder Status Change Summary Screen from the Browser.

- Select the status of the record that you want to retrieve for viewing in the Authorization Status field. You can also view all records that are either unauthorized or authorized only, by choosing the Unauthorized / Authorized option.
- Specify any or all of the details of the record in the corresponding fields on the screen, and click 'Search' button. All records with the specified details are retrieved and displayed in the lower portion of the screen.
- Double click the record that you want to view in the list of displayed records. The Unit Holder Status Change Detail screen is displayed in View mode.

#### **4.18.4 Deleting Status Change**

You can delete only unauthorized records in the system. To delete a record that you have previously entered:

- Invoke the Unit Holder Status Change Summary screen from the Browser.
- Select the status of the record that you want to retrieve for deletion.
- Specify any or all of the details and click 'Search' button. All records with the specified details are retrieved and displayed in the lower portion of the screen.
- Double click the record that you want to delete. The Unit Holder Status Change Detail screen is displayed.
- Select Delete operation from the Action list. The system prompts you to confirm the deletion, and the record is deleted physically from the system database.

#### **4.18.5 Authorizing Status Change**

An unauthorized Unit Holder Status Change record must be authorized in the system for it to be processed. To authorize a record:

- Invoke the Unit Holder Status Change Summary screen from the Browser.
- Select the status of the record that you want to retrieve for authorization. Typically, choose the Unauthorized option.
- Specify any or all of the details of the record in the corresponding fields on the screen. Click 'Search' button. All transactions with the specified details that are pending authorization are retrieved and displayed in the lower portion of the screen.
- Double click the transaction that you wish to authorize. The Unit Holder Status Change Detail screen is displayed. Select Authorize operation from Action.

When the checker authorizes a transaction, details of validations, if any, that were overridden by the maker of the transaction during the Save operation, are displayed. If any of these overrides results in an error, the checker must reject the transaction.

#### **4.18.6 Amending Status Change**

After a Unit holder Status Change record is authorized, it can be modified using the Unlock operation from Action list. To make changes to a record after authorization:

- Invoke the Unit Holder Status Change Summary screen from the Browser.
- Select the status of the record that you wish to retrieve for amendment. You can only amend only authorized records.
- Specify any or all of the details of the Unit Holder Status Change in the screen. All records with the specified details are retrieved and displayed in the lower portion of the screen.
- Double click the record that you want to amend. The Unit Holder Status Change Detail screen is displayed in Amendment mode. Click the Unlock operation from the Action list to amend the record.

- Amend the necessary information. Click the Save button to save the changes.

#### 4.18.7 Authorizing Amended Status Change

An amended Unit Holder Status Change record must be authorized for the amendment to be made effective in the system. The authorization of amended records can only be done from Fund Manager Module and Agency branch Module.

The process of authorization is subsequently the same as that for normal transactions.

### 4.19 Auth Rep Maintenance Detail Screen

This section contains the following topic:

- [Section 4.19.1, "Invoking Auth Rep Maintenance Detail Screen"](#)

#### 4.19.1 Invoking Auth Rep Maintenance Detail Screen

To set up a new authorized representative in the system and associate this representative with the unit holder, you can use the 'Auth Rep Maintenance Detail' screen. You can invoke this screen by typing 'UTDATREP' in the field at the top right corner of the Application tool bar and clicking on the adjoining arrow button. The 'Auth Rep Maintenance Detail' screen opens.

Input by	DateTime	Mod No	Open
Authorized by	DateTime		Authorization Status

Select 'New' from the Actions menu in the Application tool bar or click new icon to enter the details of the Auth Rep Maintenance screen.

#### **Auth Rep ID**

*Alphanumeric; 12 Characters; Mandatory*

Indicate a unique ID for the authorized representative.

**Expiry Date**

*Date Format; Optional*

Specify an expiry date for the unit holder authorizing representative being defined. An error message is displayed on saving the transaction if the expiry date is less than the transaction date.

**Category**

*Mandatory*

Select the category from the drop-down list. The list displays the following values:

- Individual
- Corporate

**Title**

*Alphanumeric; 15 Characters; Optional*

Select the applicable title for the name of the authorized representative from the list provided. If you do not find the option you are looking for in the list, specify the same.

**First Name**

*Alphanumeric; 105 Characters; Mandatory*

Specify the first name of the authorized representative.

**Middle Name**

*Alphanumeric; 105 Characters; Optional*

Specify the middle name of the authorized representative.

**Last Name**

*Alphanumeric; 105 Characters; Optional*

Specify the last name of the authorized representative.

**Date of Birth**

*Date Format; Optional*

Select the date of birth of the guardian from the adjoining calendar.

The system will attach this detail to the unit holder account while creating a minor unit holder account.

**Address Line 1 and 2**

*Alphanumeric; 255 Characters; Optional*

Specify the address of the authorized representative.

**City**

*Alphanumeric; 80 Characters; Optional*

Specify the name of the city of residence of the authorized representative.

**State**

*Alphanumeric; 20 Characters; Optional*

If the specified city of residence is located in a state outside of the United States of America, specify the name of the state here.

**Country**

*Alphanumeric; 3 Characters; Optional*

Select the country code for address from the adjoining option list.



**Description**

*Display*

The system displays the description for the selected country code.

**Zip Code**

*Alphanumeric; 10 Characters; Optional*

Specify the zip code of the specified city of residence of the authorized representative.

**Int. Dialing Code +**

*Alphanumeric; 10 Characters; Optional*

Specify the international dialling code.

**Telephone 1**

*Alphanumeric; 15 Characters; Optional*

Specify the telephone number.

**Int. Dialing Code +**

*Alphanumeric; 10 Characters; Optional*

Specify the international dialling code.

**Telephone 2**

*Alphanumeric; 15 Characters; Optional*

Specify the alternative telephone number

**Int. Dialing Code +**

*Alphanumeric; 10 Characters; Optional*

Specify the international dialling code.

**Cellphone Number**

*Alphanumeric; 16 Characters; Optional*

Specify the cellphone number.

**Remarks**

*Alphanumeric; 255 Characters; Optional*

Specify remarks, if any.

**Nationality**

*Alphanumeric; 3 Characters; Optional*

Select the nationality from the adjoining option list.

**Description**

*Display*

The system displays the description for the selected nationality.

**Country of Domicile**

*Alphanumeric; 3 Characters; Optional*

Select the country of domicile from the adjoining option list.

**Description**

*Display*

The system displays the description for the selected

**Country of Birth**

*Alphanumeric; 3 Characters; Optional*

Select the country of birth from the adjoining option list.

**Description**

*Display*

The system displays the description for the selected country of birth.

**US Indicia Available**

*Display*

The system defaults US Indicia Available as Yes or No depending on the following:

- The nationality is US
- The country of birth is US
- The country of domicile is US
- The country of address is US
- The country code of the telephone number is 01

**FATCA Status**

*Display*

The system displays the FATCA Status based on the FATCA maintenance.

**FATCA Classification**

*Display*

The system displays the FATCA classification type.

**Description**

*Display*

The system displays the FATCA classification description.

Click 'Show Image' button to upload the necessary documents. Click 'Browse' button to browse the required documents and then click on 'Upload' button. The documents will be uploaded.

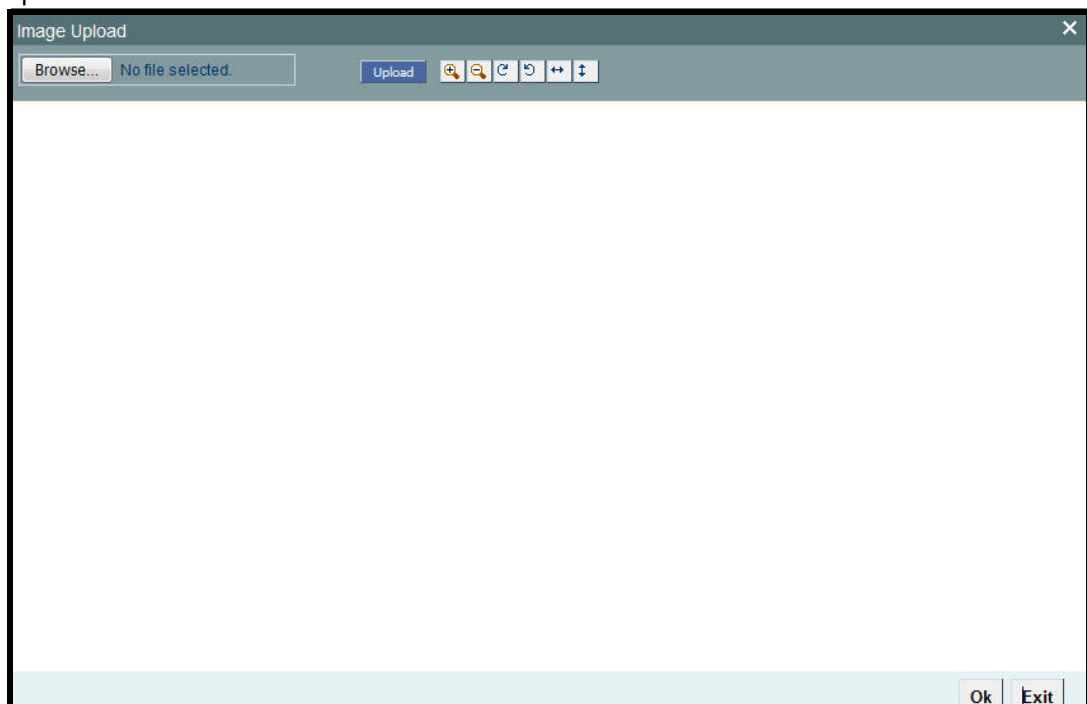

## 4.20 Auth Rep Maintenance Summary

This section contains the following topics:

- [Section 4.20.1, "Retrieving a Record in Auth Rep Maintenance Summary Screen"](#)
- [Section 4.20.2, "Editing Auth Rep Maintenance Record"](#)
- [Section 4.20.3, "Viewing Auth Rep Maintenance Record "](#)
- [Section 4.20.4, "Deleting Auth Rep Maintenance Record"](#)
- [Section 4.20.5, "Authorizing Auth Rep Maintenance Record "](#)
- [Section 4.20.6, "Amending Auth Rep Maintenance Record "](#)
- [Section 4.20.7, "Authorizing an Amended Auth Rep Maintenance Record "](#)

### 4.20.1 Retrieving a Record in Auth Rep Maintenance Summary Screen

You can retrieve a previously entered record in the Summary Screen, as follows:

Invoke the 'Auth Rep Maintenance Summary' screen by typing 'UTSATREP' in the field at the top right corner of the Application tool bar and clicking on the adjoining arrow button and specify any or all of the following details in the corresponding details.

The screenshot shows the 'Auth Rep Maintenance Summary' application window. At the top, there are search options: 'Search', 'Advanced Search', 'Reset', and 'Clear All'. Below this, a section titled 'Search Is Case Sensitive' contains three input fields: 'Authorization Status' (a dropdown menu), 'Auth Rep ID' (a text input with a magnifying glass icon), and 'Open' (a dropdown menu). Below the search fields is a table with the following columns: 'Authorization Status', 'Open', 'Auth Rep ID', and 'Expiry Date'. The table is currently empty. At the bottom right of the window, there is an 'Exit' button.

- The status of the record in the Authorization Status field. If you choose the 'Blank Space' option, then all the records are retrieved.

- The status of the record in the Open field. If you choose the 'Blank Space' option, then all records are retrieved
- Auth Rep ID

Click 'Search' button to view the records. All the records with the specified details are retrieved and displayed in the lower portion of the screen.

---

**Note**

You can also retrieve the individual record detail from the detail screen by querying in the following manner:

- Press F7
  - Input the Auth Rep ID
  - Press F8
- 

You can perform Edit, Delete, Amend, Authorize, Reverse, Confirm operations by selecting the operation from the Action list. You can also search a record by using a combination of % and alphanumeric value

#### **4.20.2 Editing Auth Rep Maintenance Record**

You can modify the details of Auth Rep Maintenance record that you have already entered into the system, provided it has not subsequently authorized. You can perform this operation as follows:

- Invoke the Auth Rep Maintenance Summary screen from the Browser.
- Select the status of the record that you want to retrieve for modification in the Authorization Status field. You can only modify records that are unauthorized. Accordingly, choose the Unauthorized option.
- Specify any or all of the details in the corresponding fields to retrieve the record that is to be modified.
- Click 'Search' button. All unauthorized records with the specified details are retrieved and displayed in the lower portion of the screen.
- Double click the record that you want to modify in the list of displayed records. The Auth Rep Maintenance Detail screen is displayed.
- Select Unlock Operation from the Action list to modify the record. Modify the necessary information.

Click Save to save your changes. The Auth Rep Maintenance Detail screen is closed and the changes made are reflected in the Auth Rep Maintenance Summary screen.

#### **4.20.3 Viewing Auth Rep Maintenance Record**

To view a record that you have previously input, you must retrieve the same in the Auth Rep Maintenance Summary screen as follows:

- Invoke the Auth Rep Maintenance Summary screen from the Browser.
- Select the status of the record that you want to retrieve for viewing in the Authorization Status field. You can also view all records that are either unauthorized or authorized only, by choosing the unauthorized / Authorized option.
- Specify any or all of the details of the record in the corresponding fields on the screen.
- Click 'Search' button. All records with the specified fields are retrieved and displayed in the lower portion of the screen.

- Double click the record that you want to view in the list of displayed records. The Auth Rep Maintenance Detail screen is displayed in View mode.

#### **4.20.4 Deleting Auth Rep Maintenance Record**

You can delete only unauthorized records in the system. To delete a record that you have previously entered:

- Invoke the Auth Rep Maintenance Summary screen from the Browser.
- Select the status of the record that you want to retrieve for deletion.
- Specify any or all of the details in the corresponding fields on the screen.
- Click 'Search' button. All records with the specified fields are retrieved and displayed in the lower portion of the screen.
- Double click the record that you want to delete in the list of displayed records. The Auth Rep Maintenance Detail screen is displayed.
- Select Delete Operation from the Action list. The system prompts you to confirm the deletion and the record is physically deleted from the system database.

#### **4.20.5 Authorizing Auth Rep Maintenance Record**

- An unauthorized Auth Rep Maintenance record must be authorized in the system for it to be processed. To authorize a record:
- Invoke the Auth Rep Maintenance Summary screen from the Browser.
- Select the status of the record that you want to retrieve for authorization. Typically, choose the unauthorized option.
- Specify any or all of the details in the corresponding fields on the screen.
- Click 'Search' button. All records with the specified details that are pending authorization are retrieved and displayed in the lower portion of the screen.
- Double click the record that you wish to authorize. The Auth Rep Maintenance Detail screen is displayed. Select Authorize operation from the Action List.

When a checker authorizes a record, details of validation, if any, that were overridden by the maker of the record during the Save operation are displayed. If any of these overrides results in an error, the checker must reject the record.

#### **4.20.6 Amending Auth Rep Maintenance Record**

After a Auth Rep Maintenance record is authorized, it can be modified using the Unlock operation from the Action List. To make changes to a record after authorization:

- Invoke the Auth Rep Maintenance Summary screen from the Browser.
- Select the status of the record that you want to retrieve for authorization. You can only amend authorized records.
- Specify any or all of the details in the corresponding fields on the screen.
- Click 'Search' button. All records with the specified details that are pending authorization are retrieved and displayed in the lower portion of the screen.
- Double click the record that you wish to authorize. The Auth Rep Maintenance Detail screen is displayed in amendment mode. Select Unlock operation from the Action List to amend the record.
- Amend the necessary information and click on Save to save the changes

## 4.20.7 Authorizing an Amended Auth Rep Maintenance Record

An amended Auth Rep Maintenance record must be authorized for the amendment to be made effective in the system. The authorization of amended records can be done only from Fund Manager Module and Agency Branch module.

The subsequent process of authorization is the same as that for normal transactions.

## 4.21 NotePad of Entities Detail Screen

This section contains the following topic:

Section 4.21.1, "Invoking NotePad of Entities Detail Screen"

### 4.21.1 Invoking NotePad of Entities Detail Screen

You can use the Entity NotePad facility to maintain information about any entity in the system which would be of relevance to the other entities either at the time of transaction input or in general.

You can invoke the 'NotePad Of Entities Detail' screen by typing 'UTDNTPDE' in the field at the top right corner of the Application tool bar and clicking on the adjoining arrow button.

You can specify the following details:

#### **Note Number**

##### *Display*

The system displays the unique Number for the note.

#### **From Entity Type**

##### *Display*

The system displays the Entity Type who is creating this information in the form of note pad. This information is taken from the Login Details..

#### **From Entity ID**

##### *Display*

The system displays the Entity ID of the entity that is creating this information. This information is taken from the Login details.

### **About Entity Type**

#### *Mandatory*

Select the entity about which the information is being entered from the drop-down list. The list displays the following values:

- Agent Name
- Broker
- AMC
- Agency Branch
- Registrar
- Trustee
- Unit Holder
- Distribution List Type

### **About Entity ID**

#### *Alphanumeric; 12 Characters; Mandatory*

Specify Entity about whom the Notepad is being created.

### **Notepad**

#### *Alphanumeric; 255 Characters; Mandatory*

Specify a memo text into which information about the entity is keyed in.

## **4.22 NotePad of Entities Summary Screen**

This section contains the following topics:

- [Section 4.22.1, "Retrieving Entity NotePad Information"](#)
- [Section 4.22.2, "Editing Entity NotePad Information"](#)
- [Section 4.22.3, "Viewing Entity NotePad Information"](#)
- [Section 4.22.4, "Deleting Entity NotePad Information"](#)
- [Section 4.22.5, "Authorizing Entity NotePad Information"](#)
- [Section 4.22.6, "Amending Entity NotePad Information"](#)
- [Section 4.22.7, "Authorizing Amended Entity NotePad Information"](#)

### **4.22.1 Retrieving Entity NotePad Information**

After you setup the NotePad entity, in the Notepad of Entities screen, you can perform any of the following operations before the record is authorized:

- Edit the preferences.
- Delete the record.

To authorize the NotePad entity, use the 'NotePad Of Entities Summary' screen. You can invoke this screen by typing 'UTSNTPDE' in the field at the top right corner of the Application tool bar and clicking on the adjoining arrow button.

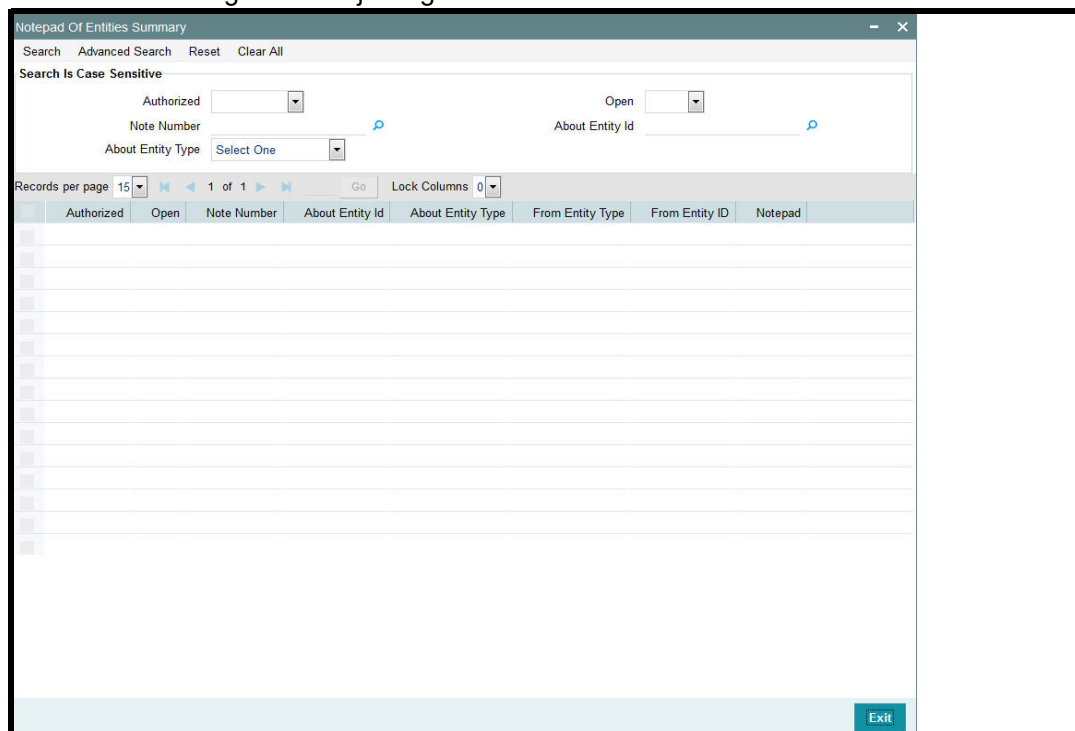

You can retrieve a previously entered record in the NotePad of Entities Summary screen, as follows:

- Specify any or all of the following details in the NotePad of Entities Summary screen:
- The status of the record in the Authorized field. If you choose the "Blank Space" option, then all the record that involves the specified unit holder are retrieved.
- The status of the NotePad in the Open field. If you choose the "Blank Space" option, then all the records that involve the specified unit holder are retrieved.
- The Note Number
- The About Entity ID
- The About Entity Type

Click 'Search' button to view the records. All records with the specified details are retrieved and displayed in the lower portion of the screen.

You can also retrieve the individual NotePad detail from the detail screen by doing query in the following manner:

- Press F7
- Input the Note Number
- Press F8

You can perform Edit, Delete, Amend, Authorize, Reverse, Confirm operation by selecting from the Action list.

You can also search the record by using combination of % and alphanumeric value.



### **For example,**

You can search the record for Note Number by using the combination of % and alphanumeric value as follows:

- Search by A%: System will fetch all the records whose Note Number starts from Alphabet 'A'. For Example: AGC17, AGVO6, AGC74 and so forth.
- Search by %7: System will fetch all the records whose Note Number ends by numeric value '7'. For Example: AGC17, GSD267, AGC77 and so forth.
- Search by %17%: System will fetch all the records whose Note Number contains the numeric value 17. For Example: GSD217, GSD172, AGC17 and so forth.

#### **4.22.2 Editing Entity NotePad Information**

You can modify the details of NotePad of Entities parameters that you have already entered into the system, provided it has not been subsequently authorized. You can perform this operation as follows:

- Invoke the NotePad of Entities Summary screen from the Browser.
- Select the status of the record that you want to retrieve for modification in the Authorization Status field. You can only modify records that are unauthorized. Accordingly, choose the Unauthorized option.
- Specify any or all of the details in the corresponding fields to retrieve the record that is to be modified. All unauthorized records with the specified details are retrieved and displayed in the lower portion of the screen.
- Double click the record that you want to modify in the list of displayed records. The NotePad of Entities Detail screen is displayed.
- Select Unlock Operation from Action list to modify the record. Modify the necessary information.
- Click Save to save your changes. NotePad of Entities Detail screen is closed and the changes made are reflected in the NotePad of Entities Summary screen.

#### **4.22.3 Viewing Entity NotePad Information**

To view a record that you have previously entered, you must retrieve the same in the NotePad of Entities Summary screen, as follows:

- Invoke the NotePad of Entities Summary Screen from the Browser.
- Select the status of the NotePad that you want to retrieve for viewing in the Authorization Status field. You can also view all records that are either unauthorized or authorized only, by choosing the Unauthorized / Authorized option.
- Specify any or all of the details of the NotePad in the corresponding fields on the screen, and click 'Search' button. All records with the specified details are retrieved and displayed in the lower portion of the screen.
- Double click the record that you want to view in the list of displayed records. The NotePad of Entities Detail screen is displayed in View mode.

#### **4.22.4 Deleting Entity NotePad Information**

You can delete only unauthorized records in the system. To delete a record that you have previously entered:

- Invoke the NotePad of Entities Summary screen from the Browser.
- Select the status of the record that you want to retrieve for deletion.

- Specify any or all of the details and click 'Search' button. All records with the specified details are retrieved and displayed in the lower portion of the screen.
- Double click the record that you want to delete. The NotePad of Entities Detail screen is displayed.
- Select Delete operation from the Action list. The system prompts you to confirm the deletion, and the record is deleted physically from the system database.

#### **4.22.5 Authorizing Entity NotePad Information**

An unauthorized NotePad of Entities record must be authorized in the system for it to be processed. To authorize a record:

- Invoke the NotePad of Entities Summary screen from the Browser.
- Select the status of the record that you want to retrieve for authorization. Typically, choose the Unauthorized option.
- Specify any or all of the details of the record in the corresponding fields on the screen. Click 'Search' button. All records with the specified details that are pending authorization are retrieved and displayed in the lower portion of the screen.
- Double click the NotePad that you wish to authorize. The NotePad of Entities Detail screen is displayed. Select Authorize operation from Action.

When the checker authorizes a NotePad, details of validations, if any, that were overridden by the maker of the NotePad during the Save operation, are displayed. If any of these overrides results in an error, the checker must reject the NotePad.

#### **4.22.6 Amending Entity NotePad Information**

After a NotePad of Entities record is authorized, it can be modified using the Unlock operation from Action list. To make changes to a NotePad after authorization:

- Invoke the NotePad of Entities Summary screen from the Browser.
- Select the status of the NotePad that you wish to retrieve for amendment. You can only amend only authorized records.
- Specify any or all of the details of the NotePad of Entities in the screen. All records with the specified details are retrieved and displayed in the lower portion of the screen.
- Double click the record that you want to amend. The NotePad of Entities Detail screen is displayed in Amendment mode. Click the Unlock operation from the Action list to amend the record.
- Amend the necessary information. Click the Save button to save the changes.

#### **4.22.7 Authorizing Amended Entity NotePad Information**

An amended NotePad of Entities record must be authorized for the amendment to be made effective in the system. The authorization of amended records can only be done from Fund Manager Module and Agency branch Module.

The process of authorization is subsequently the same as that for normal transactions.

### **4.23 Agency Branch Account Officer Maintenance Detail**

This section contains the following topics:

- [Section 4.23.1, "Invoking Agency Branch Account Officer Maintenance Detail Screen"](#)

## 4.23.1 Invoking Agency Branch Account Officer Maintenance Detail Screen

You can map the Agency branch and Account officer to the respective agent code, from this screen. You can invoke 'Agency Branch Account Officer Maintenance Detail' screen by typing 'UTDAGTAO' in the field at the top right corner of the Application tool bar and clicking on the adjoining arrow button.

Input by	DateTime	Mod No	Open
Authorized by	DateTime		Authorization Status

You can specify the following details:

### **Basic Information**

#### **Agent Code**

*Alphanumeric; 12 Characters; Mandatory*

Specify the agent code. Alternatively, you can select agent code from the option list. The list displays all valid agent code maintained in the system.

#### **Effective Date**

Date Format; Mandatory

Select the effective date from the adjoining calendar.

### **Agency Branch Account Officer Mapping**

#### **Agency Branch**

*Alphanumeric; 12 Characters; Mandatory*

Specify the agency branch. Alternatively, you can select agency branch code from the option list. The list displays all valid agency branch code maintained in the system.

#### **Account Officer**

*Alphanumeric; 12 Characters; Mandatory*

Specify the account officer details. Alternatively, you can select account officer details from the option list. The list displays all valid account officer details maintained in the system.

**Default***Mandatory*

Select 'Yes' from drop-down list to select default

**Account Officer Name***Display*

The system displays the name of the selected account officer.

## **4.24 Agency Branch Account Officer Maintenance Summary**

This section contains the following topics:

- [Section 4.24.1, "Retrieving a Record in Agency Branch Account Officer Maintenance Summary Screen"](#)
- [Section 4.24.2, "Editing Agency Branch Account Officer Maintenance Record"](#)
- [Section 4.24.3, "Viewing Agency Branch Account Officer Maintenance Record"](#)
- [Section 4.24.4, "Deleting Agency Branch Account Officer Maintenance Record"](#)
- [Section 4.24.5, "Authorizing Agency Branch Account Officer Maintenance Record"](#)
- [Section 4.24.6, "Amending Agency Branch Account Officer Maintenance Record"](#)
- [Section 4.24.7, "Authorizing Amended Agency Branch Account Officer Maintenance Record"](#)

### **4.24.1 Retrieving a Record in Agency Branch Account Officer Maintenance Summary Screen**

You can retrieve a previously entered record in the Summary Screen, as follows:

Invoke the 'Agency Branch Account Officer Maintenance Summary' screen by typing 'UTSAGTAO' in the field at the top right corner of the Application tool bar. Click on the

adjoining arrow button and specify any or all of the following details in the corresponding details.

Agency Branch AccountOfficer Maintenance Summary

Search Advanced Search Reset Clear All

Search Is Case Sensitive

Authorization Status  Open

Agent Code  Agency Branch

Account Officer Name

Records per page 15 1 of 1 Go Lock Columns 0

Authorization Status	Open	Agent Code	Agency Branch	Account Officer Name	Effective Date	Account Officer
----------------------	------	------------	---------------	----------------------	----------------	-----------------

Exit

- The status of the record in the Authorization Status field. If you choose the 'Blank Space' option, then all the records are retrieved.
- The status of the record in the Open field. If you choose the 'Blank Space' option, then all records are retrieved
- Agent Code
- Account Officer Name
- Agency Branch

Click 'Search' button to view the records. All the records with the specified details are retrieved and displayed in the lower portion of the screen.

---

#### Note

You can also retrieve the individual record detail from the detail screen by querying in the following manner:

- Press F7
- Input the Agent Code
- Press F8

---

You can perform Edit, Delete, Amend, Authorize, Reverse, Confirm operations by selecting the operation from the Action list. You can also search a record by using a combination of % and alphanumeric value

#### **4.24.2 Editing Agency Branch Account Officer Maintenance Record**

You can modify the details of Agency Branch Account Officer Maintenance record that you have already entered into the system, provided it has not subsequently authorized. You can perform this operation as follows:

- Invoke the Agency Branch Account Officer Maintenance Summary screen from the Browser.
- Select the status of the record that you want to retrieve for modification in the Authorization Status field. You can only modify records that are unauthorized. Accordingly, choose the Unauthorized option.
- Specify any or all of the details in the corresponding fields to retrieve the record that is to be modified.
- Click 'Search' button. All unauthorized records with the specified details are retrieved and displayed in the lower portion of the screen.
- Double click the record that you want to modify in the list of displayed records. The Agency Branch Account Officer Maintenance Detail screen is displayed.
- Select Unlock Operation from the Action list to modify the record. Modify the necessary information.

Click Save to save your changes. The Agency Branch Account Officer Maintenance Detail screen is closed and the changes made are reflected in the Agency Branch Account Officer Maintenance Summary screen.

#### **4.24.3 Viewing Agency Branch Account Officer Maintenance Record**

To view a record that you have previously input, you must retrieve the same in the Agency Branch Account Officer Maintenance Summary screen as follows:

- Invoke the Agency Branch Account Officer Maintenance Summary screen from the Browser.
- Select the status of the record that you want to retrieve for viewing in the Authorization Status field. You can also view all records that are either unauthorized or authorized only, by choosing the unauthorized / Authorized option.
- Specify any or all of the details of the record in the corresponding fields on the screen.
- Click 'Search' button. All records with the specified fields are retrieved and displayed in the lower portion of the screen.
- Double click the record that you want to view in the list of displayed records. The Agency Branch Account Officer Maintenance Detail screen is displayed in View mode.

#### **4.24.4 Deleting Agency Branch Account Officer Maintenance Record**

You can delete only unauthorized records in the system. To delete a record that you have previously entered:

- Invoke the Agency Branch Account Officer Maintenance Summary screen from the Browser.
- Select the status of the record that you want to retrieve for deletion.
- Specify any or all of the details in the corresponding fields on the screen.
- Click 'Search' button. All records with the specified fields are retrieved and displayed in the lower portion of the screen.
- Double click the record that you want to delete in the list of displayed records. The Agency Branch Account Officer Maintenance Detail screen is displayed.

- Select Delete Operation from the Action list. The system prompts you to confirm the deletion and the record is physically deleted from the system database.

#### **4.24.5 Authorizing Agency Branch Account Officer Maintenance Record**

- An unauthorized Agency Branch Account Officer Maintenance record must be authorized in the system for it to be processed. To authorize a record:
- Invoke the Agency Branch Account Officer Maintenance Summary screen from the Browser.
- Select the status of the record that you want to retrieve for authorization. Typically, choose the unauthorized option.
- Specify any or all of the details in the corresponding fields on the screen.
- Click 'Search' button. All records with the specified details that are pending authorization are retrieved and displayed in the lower portion of the screen.
- Double click the record that you wish to authorize. The Agency Branch Account Officer Maintenance Detail screen is displayed. Select Authorize operation from the Action List.

When a checker authorizes a record, details of validation, if any, that were overridden by the maker of the record during the Save operation are displayed. If any of these overrides results in an error, the checker must reject the record.

#### **4.24.6 Amending Agency Branch Account Officer Maintenance Record**

After a Agency Branch Account Officer Maintenance record is authorized, it can be modified using the Unlock operation from the Action List. To make changes to a record after authorization:

- Invoke the Agency Branch Account Officer Maintenance Summary screen from the Browser.
- Select the status of the record that you want to retrieve for authorization. You can only amend authorized records.
- Specify any or all of the details in the corresponding fields on the screen.
- Click 'Search' button. All records with the specified details that are pending authorization are retrieved and displayed in the lower portion of the screen.
- Double click the record that you wish to authorize. The Agency Branch Account Officer Maintenance screen is displayed in amendment mode. Select Unlock operation from the Action List to amend the record.
- Amend the necessary information and click on Save to save the changes

#### **4.24.7 Authorizing Amended Agency Branch Account Officer Maintenance Record**

An amended Agency Branch Account Officer Maintenance record must be authorized for the amendment to be made effective in the system. The authorization of amended records can be done only from Fund Manager Module and Agency Branch module.

The subsequent process of authorization is the same as that for normal transactions.

### **4.25 Account Officer IFA Maintenance Detail**

This section contains the following topics:

- [Section 4.25.1, "Invoking Account Officer IFA Maintenance Detail Screen"](#)

## 4.25.1 Invoking Account Officer IFA Maintenance Detail Screen

You can map the Account Officer and the IFA using 'Account Officer IFA Maintenance Detail' screen. You can invoke 'Account Officer IFA Maintenance Detail' screen by typing 'UTDAOIFA' in the field at the top right corner of the Application tool bar and clicking on the adjoining arrow button.

Account officer IFA Maintenance Detail

Save

Account Officer IFA Mapping

Agent Code \*

Agency Branch \*

Effective Date \*

Account Officer \*

IFA \*

Default \*

Agent

Branch Name

Account Officer Name

IFA Name

Input by  DateTime  Mod No  Open

Authorized by  DateTime  Authorization Status

Cancel

You can specify the following details:

### **Account Officer IFA Mapping**

#### **Agent Code**

*Alphanumeric; 12 Characters; Mandatory*

Specify the agent code. Alternatively, you can select agent code from the option list. The list displays all valid agent code maintained in the system.

#### **Agent**

*Display*

The system displays the description of the selected agent code.

#### **Agency Branch**

*Alphanumeric; 12 Characters; Mandatory*

Specify the agency branch code. Alternatively, you can select agency branch code from the option list. The list displays all valid agency branch code maintained in the system.



**Branch Name**

*Display*

The system displays the name of the selected agency branch code.

**Effective Date**

*Date Format; Mandatory*

Select the effective date from the adjoining calendar.

**Account Officer**

*Alphanumeric; 12 Characters; Mandatory*

Specify the account officer. Alternatively, you can select account officer from the option list. The list displays all valid account officer maintained in the system.

**Account Officer Name**

*Display*

The system displays the name of the selected account officer ID.

**IFA**

*Alphanumeric; 12 Characters; Mandatory*

Specify the IFA code. Alternatively, you can select IFA code from the option list. The list displays all valid IFA code maintained in the system.

**IFA Name**

*Display*

The system displays the name of the selected IFA code.

**Default**

*Mandatory*

Select the default status from the drop-down list. The list displays the following values:

- Yes
- No

## **4.26 Account Officer IFA Maintenance Summary**

This section contains the following topics:

- [Section 4.26.1, "Retrieving a Record in Account Officer IFA Maintenance Summary Screen"](#)
- [Section 4.26.2, "Editing Account Officer IFA Maintenance Record"](#)
- [Section 4.26.3, "Viewing Account Officer IFA Maintenance Record"](#)
- [Section 4.26.4, "Deleting Account Officer IFA Maintenance Record"](#)
- [Section 4.26.5, "Authorizing Account Officer IFA Maintenance Record"](#)
- [Section 4.26.6, "Amending Account Officer IFA Maintenance Record"](#)
- [Section 4.26.7, "Authorizing Amended Account Officer IFA Maintenance Record"](#)

### **4.26.1 Retrieving a Record in Account Officer IFA Maintenance Summary Screen**

You can retrieve a previously entered record in the Summary screen, as follows:

Invoke the 'Account Officer IFA Maintenance Summary' screen by typing 'UTSAOIFA' in the field at the top right corner of the Application tool bar and clicking on the adjoining arrow button and specify any or all of the following details in the corresponding details.

- The status of the record in the Authorization Status field. If you choose the 'Blank Space' option, then all the records are retrieved.
- The status of the record in the Open field. If you choose the 'Blank Space' option, then all records are retrieved
- Agent Code
- Effective Date
- IFA
- Agency Branch
- Account Officer
- Default

Click 'Search' button to view the records. All the records with the specified details are retrieved and displayed in the lower portion of the screen.

---

**Note**

You can also retrieve the individual record detail from the detail screen by querying in the following manner:

- Press F7
  - Input the Agent Code
  - Press F8
- 

You can perform Edit, Delete, Amend, Authorize, operations by selecting the operation from the Action list. You can also search a record by using a combination of % and alphanumeric value

#### **4.26.2 Editing Account Officer IFA Maintenance Record**

You can modify the details of Account Officer IFA Maintenance record that you have already entered into the system, provided it has not subsequently authorized. You can perform this operation as follows:

- Invoke the Account Officer IFA Maintenance Summary screen from the Browser.
- Select the status of the record that you want to retrieve for modification in the Authorization Status field. You can only modify records that are unauthorized. Accordingly, choose the Unauthorized option.
- Specify any or all of the details in the corresponding fields to retrieve the record that is to be modified.
- Click 'Search' button. All unauthorized records with the specified details are retrieved and displayed in the lower portion of the screen.
- Double click the record that you want to modify in the list of displayed records. The Account Officer IFA Maintenance Detail screen is displayed.
- Select Unlock Operation from the Action list to modify the record. Modify the necessary information.

Click Save to save your changes. The Account Officer IFA Maintenance Detail screen is closed and the changes made are reflected in the Account Officer IFA Maintenance Summary screen.

#### **4.26.3 Viewing Account Officer IFA Maintenance Record**

To view a record that you have previously input, you must retrieve the same in the Account Officer IFA Maintenance Summary screen as follows:

- Invoke the Account Officer IFA Maintenance Summary screen from the Browser.
- Select the status of the record that you want to retrieve for viewing in the Authorization Status field. You can also view all records that are either unauthorized or authorized only, by choosing the unauthorized / Authorized option.
- Specify any or all of the details of the record in the corresponding fields on the screen.
- Click 'Search' button. All records with the specified fields are retrieved and displayed in the lower portion of the screen.
- Double click the record that you want to view in the list of displayed records. The Account Officer IFA Maintenance Detail screen is displayed in View mode.

#### **4.26.4 Deleting Account Officer IFA Maintenance Record**

You can delete only unauthorized records in the system. To delete a record that you have previously entered:

- Invoke the Account Officer IFA Maintenance Summary screen from the Browser.
- Select the status of the record that you want to retrieve for deletion.
- Specify any or all of the details in the corresponding fields on the screen.

- Click 'Search' button. All records with the specified fields are retrieved and displayed in the lower portion of the screen.
- Double click the record that you want to delete in the list of displayed records. The Account Officer IFA Maintenance Detail screen is displayed.
- Select Delete Operation from the Action list. The system prompts you to confirm the deletion and the record is physically deleted from the system database.

#### **4.26.5 Authorizing Account Officer IFA Maintenance Record**

- An unauthorized Account Officer IFA Maintenance record must be authorized in the system for it to be processed. To authorize a record:
- Invoke the Account Officer IFA Maintenance Summary screen from the Browser.
- Select the status of the record that you want to retrieve for authorization. Typically, choose the unauthorized option.
- Specify any or all of the details in the corresponding fields on the screen.
- Click 'Search' button. All records with the specified details that are pending authorization are retrieved and displayed in the lower portion of the screen.
- Double click the record that you wish to authorize. The Account Officer IFA Maintenance Detail screen is displayed. Select Authorize operation from the Action List.

When a checker authorizes a record, details of validation, if any, that were overridden by the maker of the record during the Save operation are displayed. If any of these overrides results in an error, the checker must reject the record.

#### **4.26.6 Amending Account Officer IFA Maintenance Record**

After a Account Officer IFA Maintenance record is authorized, it can be modified using the Unlock operation from the Action List. To make changes to a record after authorization:

- Invoke the Account Officer IFA Maintenance Summary screen from the Browser.
- Select the status of the record that you want to retrieve for authorization. You can only amend authorized records.
- Specify any or all of the details in the corresponding fields on the screen.
- Click 'Search' button. All records with the specified details that are pending authorization are retrieved and displayed in the lower portion of the screen.
- Double click the record that you wish to authorize. The Account Officer IFA Maintenance Detail screen is displayed in amendment mode. Select Unlock operation from the Action List to amend the record.
- Amend the necessary information and click on Save to save the changes

#### **4.26.7 Authorizing Amended Account Officer IFA Maintenance Record**

An amended Account Officer IFA Maintenance record must be authorized for the amendment to be made effective in the system. The authorization of amended records can be done only from Fund Manager Module and Agency Branch module.

The subsequent process of authorization is the same as that for normal transactions.

### **4.27 Agent Price Basis Detail**

This section contains the following topics:

- [Section 4.27.1, "Invoking Agent Price Basis Detail Screen"](#)

## 4.27.1 Invoking Agent Price Basis Detail Screen

You can maintain component details in the 'Agent Price Basis Detail' screen for the required fund, transaction type, agent code and account type combination for Formula based funds.

You can invoke 'Agent Price Basis Detail' screen by typing 'UTDAGTPR' in the field at the top right corner of the Application tool bar and clicking on the adjoining arrow button. Select 'New' from the Actions menu in the Application tool bar or click new icon to enter the details.

The screenshot shows the 'Agent Price Basis Detail' window. It has a title bar with a close button. Below the title bar is a 'Save' button. The main area is divided into two sections: 'Basic Information' and 'Component Information'. In the 'Basic Information' section, there are fields for 'Fund ID \*', 'Effective Date \*', 'Transaction Type \*', 'Agent Code \*', 'Account Type \*', 'Transaction Name', 'Name', and 'Description'. In the 'Component Information' section, there are fields for 'Component ID \*', 'Default Value \*' (set to 'No'), and 'Component Description'. At the bottom, there are fields for 'Input by', 'Authorized by', 'DateTime', 'Mod No', 'Open', and 'Authorized', along with a 'Cancel' button.

You can specify the following details:

### **Basic Information**

#### **Fund ID**

*Alphanumeric; 6 Character; Mandatory*

Specify the fund code for which you want to maintain the price basis. Alternatively you can select fund ID from the option list. The list displays all valid fund ID maintained in the system.

#### **Effective Date**

*Date Format; Mandatory*

Select the Effective date for which you want to maintain the price basis from the adjoining calendar.

#### **Transaction Type**

*Alphanumeric; 15 Character; Mandatory*

Specify the transaction type for which you want to maintain the price basis. Alternatively you can select transaction type from the option list. The list displays all valid transaction type maintained in the system.

#### **Transaction Name**

*Display*

The system displays the name of the selected transaction type.

**Agent Code**

*Alphanumeric; 12 Character; Mandatory*

Specify the agent code for which you want to maintain the price basis. Alternatively you can select agent code from the option list. The list displays all valid agent code maintained in the system.

**Name**

*Display*

The system displays the name of the selected agent code.

**Account Type**

*Alphanumeric; 2 Character; Mandatory*

Specify the Account type for which you want to maintain the price basis. Alternatively you can select account type from the option list. The list displays all valid account type maintained in the system.

**Description**

*Display*

The system displays the description of the selected account type.

**Component Information****Component ID**

*Alphanumeric; 10 Character; Mandatory*

Specify the component ID for which you want to maintain the price basis. Alternatively you can select component ID from the option list. The list displays all valid component ID maintained in the system.

**Component Description**

*Display*

The system displays the description of the selected component ID.

**Default Value**

*Mandatory*

Select the default value from the drop-down list. The list displays the following values:

- Yes
- No

## **4.28 Agent Price Basis Summary**

This section contains the following topics:

- [Section 4.28.1, "Retrieving a Record in Agent Price Basis Summary Screen"](#)
- [Section 4.28.2, "Editing Agent Price Basis Record"](#)
- [Section 4.28.3, "Viewing Agent Price Basis Record"](#)
- [Section 4.28.4, "Deleting Agent Price Basis Record"](#)
- [Section 4.28.5, "Authorizing Agent Price Basis Record"](#)
- [Section 4.28.6, "Amending Agent Price Basis Record"](#)
- [Section 4.28.7, "Authorizing Amended Agent Price Basis Record"](#)

## 4.28.1 Retrieving a Record in Agent Price Basis Summary Screen

You can retrieve a previously entered record in the Summary Screen, as follows:

Invoke the 'Agent Price Basis Summary' screen by typing 'UTSAGTPR' in the field at the top right corner of the Application tool bar. Click on the adjoining arrow button and specify any or all of the following details in the corresponding details.

The screenshot shows the 'Agent Price Basis Summary' application window. At the top, there are search options: 'Search', 'Advanced Search', 'Reset', and 'Clear All'. Below this, a section titled 'Search Is Case Sensitive' contains several search filters: 'Authorized' (dropdown), 'Open' (dropdown), 'Fund ID' (text input with a magnifying glass icon), 'Effective Date' (calendar icon), 'Transaction Type' (text input with a magnifying glass icon), 'Agent Code' (text input with a magnifying glass icon), and 'Account Type' (text input with a magnifying glass icon). Below the filters is a table with columns: 'Authorized', 'Open', 'Fund ID', 'Effective Date', 'Transaction Type', 'Agent Code', 'Account Type', and 'Component ID'. The table is currently empty. At the bottom right of the window is an 'Exit' button.

- The status of the record in the Authorized field. If you choose the 'Blank Space' option, then all the records are retrieved.
- The status of the record in the Open field. If you choose the 'Blank Space' option, then all records are retrieved
- Fund ID
- Transaction Type
- Account Type
- Effective Date
- Agent Code
- Component ID

Click 'Search' button to view the records. All the records with the specified details are retrieved and displayed in the lower portion of the screen.

---

### Note

You can also retrieve the individual record detail from the detail screen by querying in the following manner:

- Press F7
  - Input the Fund ID
  - Press F8
- 

You can perform Edit, Delete, Amend, Authorize, Reverse, Confirm operations by selecting the operation from the Action list. You can also search a record by using a combination of % and alphanumeric value

#### **4.28.2 Editing Agent Price Basis Record**

You can modify the details of Agent Price Basis record that you have already entered into the system, provided it has not subsequently authorized. You can perform this operation as follows:

- Invoke the Agent Price Basis Summary screen from the Browser.
- Select the status of the record that you want to retrieve for modification in the Authorized field. You can only modify records that are unauthorized. Accordingly, choose the Unauthorized option.
- Specify any or all of the details in the corresponding fields to retrieve the record that is to be modified.
- Click 'Search' button. All unauthorized records with the specified details are retrieved and displayed in the lower portion of the screen.
- Double click the record that you want to modify in the list of displayed records. The Agent Price Basis Detail screen is displayed.
- Select Unlock Operation from the Action list to modify the record. Modify the necessary information.

Click Save to save your changes. The Agent Price Basis Detail screen is closed and the changes made are reflected in the Agent Price Basis Summary screen.

#### **4.28.3 Viewing Agent Price Basis Record**

To view a record that you have previously input, you must retrieve the same in the Agent Price Basis Summary screen as follows:

- Invoke the Agent Price Basis Summary screen from the Browser.
- Select the status of the record that you want to retrieve for viewing in the Authorized field. You can also view all records that are either unauthorized or authorized only, by choosing the unauthorized / Authorized option.
- Specify any or all of the details of the record in the corresponding fields on the screen.
- Click 'Search' button. All records with the specified fields are retrieved and displayed in the lower portion of the screen.
- Double click the record that you want to view in the list of displayed records. The Agent Price Basis Detail screen is displayed in View mode.

#### **4.28.4 Deleting Agent Price Basis Record**

You can delete only unauthorized records in the system. To delete a record that you have previously entered:

- Invoke the Agent Price Basis Summary screen from the Browser.
- Select the status of the record that you want to retrieve for deletion.
- Specify any or all of the details in the corresponding fields on the screen.



- Click 'Search' button. All records with the specified fields are retrieved and displayed in the lower portion of the screen.
- Double click the record that you want to delete in the list of displayed records. The Agent Price Basis Detail screen is displayed.
- Select Delete Operation from the Action list. The system prompts you to confirm the deletion and the record is physically deleted from the system database.

#### **4.28.5 Authorizing Agent Price Basis Record**

- An unauthorized Agent Price Basis record must be authorized in the system for it to be processed. To authorize a record:
- Invoke the Agent Price Basis Summary screen from the Browser.
- Select the status of the record that you want to retrieve for authorization. Typically, choose the unauthorized option.
- Specify any or all of the details in the corresponding fields on the screen.
- Click 'Search' button. All records with the specified details that are pending authorization are retrieved and displayed in the lower portion of the screen.
- Double click the record that you wish to authorize. The Agent Price Basis Detail screen is displayed. Select Authorize operation from the Action List.

When a checker authorizes a record, details of validation, if any, that were overridden by the maker of the record during the Save operation are displayed. If any of these overrides results in an error, the checker must reject the record.

#### **4.28.6 Amending Agent Price Basis Record**

After a Agent Price Basis record is authorized, it can be modified using the Unlock operation from the Action List. To make changes to a record after authorization:

- Invoke the Agent Price Basis Summary screen from the Browser.
- Select the status of the record that you want to retrieve for authorization. You can only amend authorized records.
- Specify any or all of the details in the corresponding fields on the screen.
- Click 'Search' button. All records with the specified details that are pending authorization are retrieved and displayed in the lower portion of the screen.
- Double click the record that you wish to authorize. The Agent Price Basis Detail screen is displayed in amendment mode. Select Unlock operation from the Action List to amend the record.
- Amend the necessary information and click on Save to save the changes

#### **4.28.7 Authorizing Amended Agent Price Basis Record**

An amended Agent Price Basis record must be authorized for the amendment to be made effective in the system. The authorization of amended records can be done only from Fund Manager Module and Agency Branch module.

The subsequent process of authorization is the same as that for normal transactions.

### **4.29 AMC Agent SLA Maintenance Summary**

This section contains the following topics:

- [Section 4.29.1, "Invoking AMC Agent SLA Maintenance Summary Screen"](#)

## 4.29.1 Invoking AMC Agent SLA Maintenance Summary Screen

You can set the distribution hierarchy for the agent in a AMC using 'AMC Agent SLA Maintenance Detail' screen. You can invoke this screen by typing 'UTDAMCSL' in the field at the top right corner of the Application tool bar and clicking on the adjoining arrow button.

Input by	DateTime	Mod No	Open
Authorized by	DateTime		Authorized

You can specify the following details:

### **AMC**

*Alphanumeric; 12 Characters; Mandatory*

Specify the AMC ID for which the Agent hierarchy needs to be mapped. Alternatively, you can select AMC ID from the option list. The list displays all valid AMC ID maintained in the system.

### **AMC Name**

*Display*

The system displays the AMC name of the selected AMC ID.

### **Agent ID**

*Alphanumeric; 12 Characters; Mandatory*

Specify the Agent ID that needs to be mapped with the AMC. Alternatively, you can select Agent ID from the option list. The list displays all valid Agent ID maintained in the system.

### **Agent Name**

*Display*

The system displays the agent name of the selected agent ID.

### **SLA Type**

*Numeric; 22 Characters; Mandatory*

Specify the SLA type. Alternatively, you can select SLA type from the option list. The list displays all valid SLA type maintained in the system.

### **SLA Type Description**

*Display*

The system displays the description for the selected SLA type.

## 4.30 Tax Credit

This section contains the following topics:

- [Section 4.30.1, "Invoking Tax Credit Screen"](#)

### 4.30.1 Invoking Tax Credit Screen

You can maintain tax credit details using 'Tax Credit' screen. You can invoke this screen by typing 'UTDTAXCR' in the field at the top right corner of the Application tool bar and clicking on the adjoining arrow.

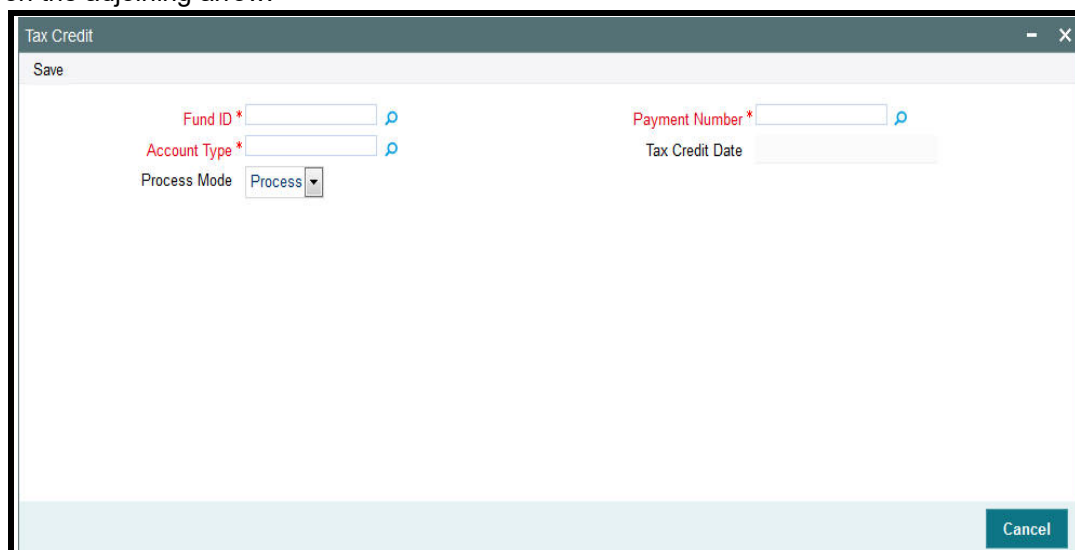

The screenshot shows a window titled "Tax Credit" with a "Save" button at the top left. The window contains several input fields and a dropdown menu:

- Fund ID \***: A text input field with a search icon.
- Account Type \***: A text input field with a search icon.
- Process Mode**: A dropdown menu currently showing "Process".
- Payment Number \***: A text input field with a search icon.
- Tax Credit Date**: A text input field.

A "Cancel" button is located at the bottom right of the window.

You can specify the following details:

#### **Fund ID**

*Alphanumeric; 6 Characters; Optional*

Specify the fund ID. Alternatively, you can select fund ID from the option list. The list displays all valid fund ID maintained in the system.

#### **Account Type**

*Alphanumeric; 1 Character; Optional*

Specify the account type. Alternatively, you can select account type from the option list. The list displays all valid account type maintained in the system.

#### **Process Mode**

*Optional*

Select the mode of processing from the drop-down list. The list displays the following values:

- Process
- Reverse

#### **Payment Number**

*Alphanumeric; 1 Character; Optional*

Specify the payment number. Alternatively, you can select payment number from the option list. The list displays all valid payment number maintained in the system.

**Tax Credit Date***Display*

The system displays the tax credited date.

---

## 5. Managing Brokers

Brokers are intermediaries between investors and their investment avenues.

An investor may approach the AMC, seeking to invest in its funds, on the basis of guidance received from a broker. Also, an AMC may contract a broker to market its funds and thereby attract investors.

Being an intermediary, a broker usually receives payments either from investors or the AMC, as the case may be. This payment is known as a commission.

Sometimes, brokers do not act as single entities, but as groups of brokers, in hierarchical structures that entail sharing of profits. The commission earned by a broker may not be credited just to the actual broker for the investment transaction, but could also share with other brokers who are part of the same hierarchical structure.

Oracle FLEXCUBE Investor Servicing enables the AMC to maintain records of brokers and their respective hierarchies in the system database, as well as process and maintain details of commission payments to brokers. This chapter deals with all aspects of maintaining brokers, their hierarchies and processing commission payments in the system.

This chapter contains the following sections:

- [Section 5.1, "Broker Type Detail Screen"](#)
- [Section 5.2, "Broker Type Summary Screen"](#)
- [Section 5.3, "Broker Maintenance Detail Screen"](#)
- [Section 5.4, "Broker Maintenance Summary Screen"](#)
- [Section 5.5, "Transaction Broker Amendment Screen"](#)
- [Section 5.6, "Broker Payment Currency Preference Detail Screen"](#)
- [Section 5.7, "FCIS Broker Payment Currency Preference Summary Screen"](#)
- [Section 5.8, "Broker Migration Screen"](#)
- [Section 5.9, "Broker Migration Summary Screen"](#)
- [Section 5.10, "Broker Journal Detail Screen"](#)
- [Section 5.11, "Broker Journal Summary Screen"](#)
- [Section 5.12, "Income Distribution Setup Screen"](#)
- [Section 5.13, "Raise Broker Commission Screen"](#)
- [Section 5.15, "Commission Payment Status Change Screen"](#)
- [Section 5.16, "Commission Payment Status Change Summary"](#)
- [Section 5.17, "Broker Commission Payment Screen"](#)
- [Section 5.18, "Minimum Commission Payment Amount Maintenance Screen"](#)
- [Section 5.19, "Minimum Commission Payment Amount Maintenance Summary Screen"](#)
- [Section 5.20, "Entity Commission Payment Inquiry Detail"](#)
- [Section 5.21, "FSA Registration Maintenance Detail"](#)
- [Section 5.22, "FSA Registration Maintenance Summary"](#)

### 5.1 Broker Type Detail Screen

This section contains the following topics:

- [Section 5.1.1, "Creating Broker Groups"](#)

- [Section 5.1.2, "Invoking Broker Type Details Screen"](#)

### **5.1.1 Creating Broker Groups**

In Oracle FLEXCUBE Investor Servicing, you can create groups of brokers with common characteristics such as the following:

- Frequencies at which commission payment is received
- Common consultants
- Common contact details

These group sets are known as broker types. Therefore, a broker type is a set of characteristics such as commission payment frequencies, common consultants and contact details, which you expect to be common to a group of brokers for whom you want to maintain records in the database.

Broker types are typically relevant in the case of brokerage firms with many individual brokers operating under them. They are also relevant in the case of countries where the tax is different based on the broker type, that is, the tax for an individual broker is different from the tax charged from the corporate broker.

### **5.1.2 Invoking Broker Type Details Screen**

To set up a broker type, use the 'Broker Type Detail' screen. You can invoke this screen by typing 'UTDBRKTY' in the field at the top right corner of the Application tool bar and clicking on the adjoining arrow button.

Specify the following mandatory information to set up a broker type:

1. A code that will uniquely identify the broker type, in the Broker Type field.
2. Descriptive text about the broker type, in the Description field.
3. The ID of the AMC for which the broker type is applicable, in the AMC ID field.
4. The commission payment frequency that would apply to any broker mapped to the broker type, in the Payment Details section. Select either Monthly or Bi-Monthly, as applicable.

After you have specified these details, save your changes by clicking the Save button.

Broker Type Detail

Save

**Basic Information**

Broker Type \*  
Description \*  
Distributor ID \*  
Distributor  
Broker Consultant

**Payment Details**

Payment Frequency \* Monthly Payment  
First Payment Date No 0  
Second Payment Date No 0  
Last Working Day No

**Contact Details**

Address Type *	Address Line 1 *	Address Line 2	City/Address Line 3	State/Address Line 4	Zip Code	Country *
Select						

Input by  
Authorized by  
DateTime  
Mod No  
Open  
Authorized  
Cancel

Select 'New' from the Actions menu in the Application tool bar or click new icon to enter the details of the Broker Type screen.

## **Basic Information**

### **Broker Type**

*Alphanumeric; 6 Characters; Mandatory*

Specify a unique alphanumeric identifier for the broker type.

### **Description**

*Alphanumeric; 255 Characters; Mandatory*

Specify the description of the broker type

### **Distributor ID**

*Alphanumeric; 12 Characters; Mandatory*

Select the ID of the AMC for which you are defining the broker type.

### **Distributor**

*Display*

The system displays the distributor details for the selected distributor ID.

### **Broker Consultant**

*Alphanumeric; 40 Characters; Mandatory*

Specify the name of the designated consultant for the broker type.

## **Payment Details**

In this section, specify the frequency pattern for the payment of commission to any of the brokers that would be mapped to the broker type.

### **Payment Frequency**

#### *Mandatory*

Select whether a monthly or bimonthly frequency of payment is preferred for brokers under this broker type from the drop-down list. The list displays the following values:

- Monthly Payment
- Bi-Monthly Payment

### **First Payment Date No**

#### *Optional*

If the payment frequency you have indicated for the broker type is monthly, indicate the date of every month on which the commission payment is to be processed for brokers under this broker type, by choosing the appropriate day of the month from the list.

If the payment frequency you have indicated for the broker type is bimonthly, indicate the date of every month on which the first commission payment is to be processed for brokers under this broker type, by choosing the appropriate day of the month from the list.

### **Second Payment Date No**

#### *Optional*

If the payment frequency you have indicated for the broker type is bimonthly, indicate the date of every month on which the second commission payment is to be processed for brokers under this broker type, by choosing the appropriate day of the month from the list.

This value must be higher than the one you selected in the First Payment Date No. field.

### **Last Working Day**

#### *Optional*

Select if the commission payment for brokers mapped to this broker type must be processed on the last working day of the month from the drop-down list. The list displays the following values:

- Yes
- No

## **Contact Details**

In this section, specify the means of communication with the main brokerage firm that represents the broker type. You can access this section by clicking the Contact Details link.

You can specify at least two addresses, and designate one as the default mailing address to be used for correspondence with the brokerage firm, and the other as the alternate address. Specify the default address under the Default Address head, and the alternate address under the Alternate Address head.

You can also maintain the SWIFT Address for the main brokerage firm of the broker type, in the SWIFT Address tab.

### **Address Type**

#### *Mandatory*

Select the type of address from the drop-down list. The list displays the following values:



- Correspondence Address
- Alternate Address
- SWIFT Address

**Address Lines 1-2**

*Alphanumeric; 80 Characters; Optional (Address Line 1 is Mandatory)*

Specify the postal address that is to be used for correspondence with the main brokerage firm for this broker type.

**City/ Address Line 3**

*Alphanumeric; 80 Characters; Optional*

Specify the name of the city of residence of the main brokerage firm for this broker type.

**State/ Address Line 4**

*Alphanumeric; 80 Characters; Optional*

Specify the state in which the city of residence of the main brokerage firm for this broker type is located.

**Zip Code**

*Alphanumeric; 6 Characters; Optional*

Specify the zip code of the specified city of residence of the main brokerage firm for this broker type.

**Country**

*Alphanumeric; 3 Characters; Mandatory*

Select the country in which the main brokerage firm for this broker type is domiciled, from the drop-down list.

**Telephone 1-2**

*Alphanumeric; 15 Characters; Optional*

Enter the contact telephone numbers of the main brokerage firm for this broker type.

**Cell Phone Number**

*Alphanumeric; 16 Characters; Optional*

Specify the cell phone number of the main brokerage firm for this broker type.

**Fax Number**

*Alphanumeric; 15 Characters; Optional*

Enter the fax number of the main brokerage firm for this broker type.

**Email**

*Alphanumeric; 60 Characters; Optional*

Specify the E-mail address of the main brokerage firm for this broker type.

**Contact Person**

*Alphanumeric; 70 Characters; Optional*

Specify the name of any contact person or official through whom communication with the main brokerage firm is possible.

**Effective From Date**

*Date Format; Optional*

Specify the date that marks the beginning of the period for which the specified Correspondence address is valid.

**Effective To Date**

*Date Format; Optional*

Specify the date that marks the end of the period for which the specified Correspondence address is valid.

**BIC Code**

*Alphanumeric; 12 Characters; Optional*

Specify the Bank Identifier Code (BIC) of the main brokerage firm for this broker type.

## **5.2 Broker Type Summary Screen**

This section contains the following topics:

- [Section 5.2.1, "Retrieving Broker Type in Broker Type Summary Screen"](#)
- [Section 5.2.2, "Editing Broker Types"](#)
- [Section 5.2.3, "Viewing Broker Types"](#)
- [Section 5.2.4, "Deleting Broker Types"](#)
- [Section 5.2.5, "Authorizing Broker Types"](#)
- [Section 5.2.6, "Amending Broker Types"](#)
- [Section 5.2.7, "Authorizing Amended Broker Types"](#)

### **5.2.1 Retrieving Broker Type in Broker Type Summary Screen**

After you have set up a broker type through the Broker Type Detail screen, you can:

- Make changes to the record before you authorize it. You can also delete the record, if deemed necessary.
- Have another user authorize it. You cannot map any individual brokers to the broker type until it is authorized.
- Make changes to the authorized record through an amendment operation, and then authorize your amendment changes.

To perform any of these operations, use the 'Broker Type Summary' screen. You can invoke this screen by typing 'UTSBRKTY' in the field at the top right corner of the Application tool bar and clicking on the adjoining arrow button.

You can also set up a record for each individual broker in the system and map these broker records to the authorized broker type. You can do this using the 'Broker Maintenance Detail' screen, which you can access from the Broker Maintenance menu in the Browser.

Broker Type Summary

Search Advanced Search Reset Clear All

Search Is Case Sensitive

Authorized [dropdown] Open [dropdown]

Broker Type [input] Payment Frequency [dropdown]

Last Working Day [dropdown]

Records per page: 15 1 of 1 Go Lock Columns: 0

Authorized	Open	Broker Type	Payment Frequency	Last Working Day
------------	------	-------------	-------------------	------------------

Exit

You can retrieve a previously entered record in the Broker Type Summary screen, as follows:

- Specify any or all of the following details in the Broker Type Summary screen:
- The status of the transaction in the Authorized field. If you choose the "Blank Space" option, then all the records that involve the specified unit holder are retrieved.
- The status of the record in the Open field. If you choose the "Blank Space" option, then all the records that involve the specified unit holder are retrieved.
- The Broker Type
- The Payment Frequency
- The Last Working Day
- Click 'Search' button to view the records. All records with the specified details are retrieved and displayed in the lower portion of the screen.

---

#### Note

You can also retrieve the individual record detail from the detail screen by doing query in the following manner:

- Press F7
  - Input the Broker Type
  - Press F8
-

You can perform Edit, Delete, Amend, Authorize, Reverse, Confirm operation by selecting from the Action list.

You can also search the record by using combination of % and alphanumeric value.

### **Example**

You can search the record for Broker Type by using the combination of % and alphanumeric value as follows:

- Search by A%: System will fetch all the records whose Broker Type starts from Alphabet 'A'. For Example: AGC17, AGVO6, AGC74 and so forth.
- Search by %7: System will fetch all the records whose Broker Type ends by numeric value '7'. For Example: AGC17, GSD267, AGC77 and so forth.
- Search by %17%: System will fetch all the records whose Broker type contains the numeric value 17. For Example: GSD217, GSD172, AGC17 and so forth.

## **5.2.2 Editing Broker Types**

You can modify the details of Broker Type parameters that you have already entered into the system, provided it has not been subsequently authorized. You can perform this operation as follows:

- Invoke the Broker Type Summary screen from the Browser.
- Select the status of the record that you want to retrieve for modification in the Authorization Status field. You can only modify records that are unauthorized. Accordingly, choose the Unauthorized option.
- Specify any or all of the details in the corresponding fields to retrieve the record that is to be modified. All unauthorized records with the specified details are retrieved and displayed in the lower portion of the screen.
- Double click the record that you want to modify in the list of displayed transactions. The Broker Type Detail screen is displayed.
- Select Unlock Operation from Action list to modify the record. Modify the necessary information.
- Click Save to save your changes. The Broker Type Detail screen is closed and the changes made are reflected in the Broker Type Summary screen.

## **5.2.3 Viewing Broker Types**

To view a record that you have previously entered, you must retrieve the same in the Broker Type Summary screen, as follows:

- Invoke the Broker Type Summary Screen from the Browser.
- Select the status of the record that you want to retrieve for viewing in the Authorization Status field. You can also view all records that are either unauthorized or authorized only, by choosing the Unauthorized / Authorized option.
- Specify any or all of the details of the record in the corresponding fields on the screen, and click 'Search' button. All records with the specified details are retrieved and displayed in the lower portion of the screen.
- Double click the record that you want to view in the list of displayed records. The Broker Type Detail screen is displayed in View mode.

## **5.2.4 Deleting Broker Types**

You can delete only unauthorized records in the system. To delete a record that you have previously entered:

- Invoke the Broker Type Summary screen from the Browser.
- Select the status of the record that you want to retrieve for deletion.
- Specify any or all of the details and click 'Search' button. All record with the specified details are retrieved and displayed in the lower portion of the screen.
- Double click the record that you want to delete. The Broker Type Detail screen is displayed.
- Select Delete operation from the Action list. The system prompts you to confirm the deletion, and the record is deleted physically from the system database.

### **5.2.5 Authorizing Broker Types**

An unauthorized Broker Type record must be authorized in the system for it to be processed. To authorize a record:

- Invoke the Broker Type Summary screen from the Browser.
- Select the status of the record that you want to retrieve for authorization. Typically, choose the Unauthorized option.
- Specify any or all of the details of the record in the corresponding fields on the screen. Click 'Search' button. All records with the specified details that are pending authorization are retrieved and displayed in the lower portion of the screen.
- Double click the transaction that you wish to authorize. The Broker Type Detail screen is displayed. Select Authorize operation from Action.

When the checker authorizes a record, details of validations, if any, that were overridden by the maker of the record during the Save operation, are displayed. If any of these overrides results in an error, the checker must reject the transaction.

### **5.2.6 Amending Broker Types**

After a Broker Type record is authorized, it can be modified using the Unlock operation from Action list. To make changes to a record after authorization:

- Invoke the Broker Type Summary screen from the Browser.
- Select the status of the record that you wish to retrieve for amendment. You can only amend only authorized records.
- Specify any or all of the details of the Broker Type in the screen. All records with the specified details are retrieved and displayed in the lower portion of the screen.
- Double click the record that you want to amend. The Broker Type Detail screen is displayed in Amendment mode. Click the Unlock operation from the Action list to amend the record.
- Amend the necessary information. Click the Save button to save the changes.

### **5.2.7 Authorizing Amended Broker Types**

An amended Broker Type record must be authorized for the amendment to be made effective in the system. The authorization of amended records can only be done from Fund Manager Module and Agency branch Module.

The process of authorization is subsequently the same as that for normal transactions.

## 5.3 Broker Maintenance Detail Screen

This section contains the following topics:

- [Section 5.3.1, "Maintaining Individual Brokers"](#)
- [Section 5.3.2, "Specifying Mandatory Information for Creating Broker Record"](#)
- [Section 5.3.3, "Saving Broker Record"](#)
- [Section 5.3.4, "Invoking Broker Maintenance Detail Screen"](#)
- [Section 5.3.5, "Broker Details Tab"](#)
- [Section 5.3.6, "Broker Contact Info Tab"](#)
- [Section 5.3.7, "Broker Bank Details Tab "](#)
- [Section 5.3.8, "Broker Legacy Details Tab"](#)
- [Section 5.3.9, "Broker Preference Tab"](#)
- [Section 5.3.10, "Related Parties Tab"](#)
- [Section 5.3.11, "Broker Add Info Tab"](#)

### 5.3.1 Maintaining Individual Brokers

In the Oracle FLEXCUBE Investor Servicing system, you can maintain a record in the database for each individual broker who wishes to transact with the AMC.

Just as with the unit holder account for an investor, the broker record in the system database is the single repository for all details concerning the broker, including details of commission processing and payment.

In Oracle FLEXCUBE Investor Servicing, when a broker wishes to reinvest the commission earnings from any fund back into the funds of the AMC, the reinvestment is effected through a default unit holder account that functions as the broker's investment account in the system database.

To maintain a record for a broker, use the 'FCIS Broker Maintenance Detail' screen. You can invoke this screen by typing 'UTDBRKMN' in the field at the top right corner of the Application tool bar and clicking on the adjoining arrow button.

You can set up a broker in the system database by creating a record for the same in the Broker Maintenance Detail screen, as follows:

- By specifying all the mandatory information that is necessary to form a profile of the broker in the database.
- Saving your specifications.

Before you begin to set up any new brokers in the system, you must ensure that the following static information sets have already been set up and entered into the system database and the required authorizations done:

- All reference data that is typically defined in the Data Entry menu item in the Fund Manager component. This includes:
- All static information such as required entities (agents, branches, agency branches, AMCs, registrars, trustees), countries, corporation types, investor categories, occupation types, identification types, banks and their branches, mode of payment types, currencies, additional information heads, fee categories and subcategories.
- Authorized funds with all necessary fund rules, agency branches, brokers, countries of domicile, account types, currencies and so on.

For a detailed account of this information, refer to the Fund Manager.

---

**Note**

You must also ensure that any broker types necessary for grouping the brokers have been set up and authorized.

---

### 5.3.2 **Specifying Mandatory Information for Creating Broker Record**

When you create a record for a broker in the Broker Maintenance Detail screen, you must specify the following data as mandatory information:

- A unique identifier for the broker record in the database, in the Broker Code field.
- The name of the broker, in the Broker Name field.
- The AMC in which the broker is designated to transact, in the AMC ID field.
- The system code of any broker that is designated as the immediate higher broker in the broker hierarchy, in the Parent Broker Code field. If the broker is to be designated as the highest in the hierarchy, then specify the code that you specified in the Broker Code field.
- If the broker is mapped to a broker type, indicate whether the frequency of commission payment defined for the selected broker type must also be deemed applicable to the broker. Indicate this in the Use Broker Type Payment Details field check box. If you select this check box the commission frequency of the broker type chosen will be defaulted for the broker.
- If the broker record has been amended, then indicate the Rule Effective Date from which the changes are effective in the system. Rule Effective date cannot be back dated. Rule Effective date can be Future Dated and system would make that rule effective only on that date during BOD
- You are allowed to amend only the last available record for which Latest Rule is 1. If a transaction exists with that Broker on that day, system will not allow you to save the Broker details
- If the status of the broker is to be disabled, indicate this by selecting the option 'WEEDDED' in the Broker Status field.
- If payment of commission is to be held back for any reason for the broker, indicate this by checking the Hold Back Payment field check box.

#### **Contact Details Section**

In the Contact Details section, you must specify the default contact address of the broker, in the Default Address field.

#### **Bank Details Section**

In the Bank Details section, you must specify the details of at least one bank account operated by the broker, and at designate at least one of the bank accounts as the default bank account. For each bank account, all the details on the screen are mandatory information.

#### **Payment Details Section**

In this section, you must specify the following:

- The currency in which the broker would prefer to receive commission payments. Select the preferred currency in the Payment Currency field.
- The percentage of earned commission that is to be paid by the broker to the immediate parent broker in the broker hierarchy. Indicate this in the Hierarchy Commission Percentage field.

- The ID of a unit holder account in the system that will function as the broker's account, typically for reinvestments requested by the broker. Indicate this in the Default Unit Holder ID field.
- The frequency at which commission processing and payment must be made for the broker, in the Payment Frequency field.
- The earliest future date on which the next commission payment is to be made, in the Next Payment Date field.
- For VAT registered brokers, indicate the applicability of VAT by checking the VAT Registered field check box in the VAT Details section. Also indicate the applicable VAT Registration Number for the broker.

### **5.3.3 Saving Broker Record**

After you have specified all of the mandatory information required for saving a record for a new broker into the database, save the record by clicking the Save button at the bottom of the Broker Maintenance Detail screen.

The record of the broker is now saved as an unauthorized record in the system database.

Alternatively, after you have specified all mandatory information, you can add further data before you save the record, as follows:

- The tax category corresponding to the broker, on the Broker Category field.
- The designated consultant for the broker, in the Broker Consultant field.
- If the broker is to be part of a broker type group, select the same in the Broker Type field.
- Any applicable additional information under any of the defined heads, in the Additional Information section.



### 5.3.4 Invoking Broker Maintenance Detail Screen

Select 'New' from the Actions menu in the Application tool bar or click new icon to enter the details of the FCIS Broker Maintenance screen.

### 5.3.5 Broker Details Tab

Click 'Broker Details' tab to enter the details.

The following fields are available in the Broker Maintenance Detail screen for data entry:

#### Broker Code

*Alphanumeric; 12 Characters; Mandatory*

Specify an alphanumeric code that would uniquely identify the record of the broker in the system.

This would be the identifier that you would use whenever you query the database for any details regarding the broker.

#### Broker Name

*Alphanumeric; 105 Characters; Mandatory*

Specify the name of the broker for whom you are setting up a record in this screen.

#### Parent Broker Code

*Alphanumeric; 9 Characters; Mandatory*

Select the broker code of the immediate higher broker to which this broker must report from the option list.

When you select a parent broker in this field, you indicate that the broker whose record you are creating now is a sub-broker of an authorized broker already existing in the system. It also means that the broker is part of an existing hierarchy structure.

---

**Note**

If it is necessary to set up the broker as the highest broker in a new hierarchy, specify the unique code that you entered for this broker in the Broker Code field in the screen. If the broker code and the parent broker code are identical for a broker, then it means that the broker is the highest broker in the hierarchy, and has no parent broker. You can change the parent broker code for a particular broker. The system changes the hierarchy and the level number of the broker and all its sub brokers based on the new parent broker code and level during authorization. The broker commission processing considers the latest broker maintenance for commission sharing.

---

**Parent Broker Name***Display*

When you select the parent broker for the broker in this field, the name of the selected parent broker is displayed in the Parent Broker Name field.

---

**Note**

Also, you must authorize a broker before you select the broker as a parent broker for another broker.

---

**Replicate Parent Details***Optional*

The system defaults the parent broker details, if Replicate Parent Details option is selected. Even if you input the broker details it will be overridden by the parent broker details only for the fields mentioned in the template. During authorization of broker amendment, the system replicates the fields specified in the template of the amended broker to all the sub-brokers for whom the Replicate Parent Details option is selected.

If Template ID is given and the Replicate Parent Details is selected as Yes, then click Enrich button to default the parent broker details based on Auto replication preference maintenance.

**Template ID**

*Alphanumeric; 6 Characters; Optional*

Specify the template ID.

**Broker Category***Mandatory*

Select the tax category applicable for the broker from the drop-down list. The list displays the following values:

- Individual
- Corporate

**Broker Type**

*Alphanumeric; 6 Characters; Optional*

From the list, select the broker type to be associated with the broker.

You can indicate that the frequency of payment that has been designated for the selected broker type must also apply to the broker, by checking the Use Broker Type Payment Details check box.

**Type Description**

*Alphanumeric; 255 Characters; Optional*

Provide a description of the broker type.

**Broker Base Currency**

*Alphanumeric; 3 Characters; Mandatory*

Specify the broker base currency. The adjoining option list displays valid broker base currencies maintained in the system. You can choose the appropriate one.

**Rule Effective Date**

*Date Format; Mandatory*

Specify the date from which the broker is effective in the system. The rule effective date must be equal to or greater than the application date.

By default, system will display the application date as the rule effective date.

**Broker Status**

*Alphanumeric; 1 Character; Mandatory*

From the list, specify the status of the broker. If the broker is to be disabled in the system, select the option 'WEEDED'.

**Status Description**

*Display*

The system displays the description for the selected broker status.

**Broker Consultant**

*Alphanumeric; 40 Characters; Optional*

Specify the name of the consultant preferred by the broker.

**AMC**

*Alphanumeric; 12 Characters; Mandatory*

Select the AMC in which the broker wishes to transact.

**AMC Description**

*Display*

The system displays the description for the selected AMC ID.

**Level Number**

*Display Only*

When you specify the code and the parent broker for the new broker, the level number of the new broker in the broker hierarchy structure is displayed here by the system. If you specified the code of the new broker itself as the parent broker code, (i.e., the new broker has no parent broker) the level number displayed is zero, and so on.

**Use Broker Type Payment Details**

*Optional*

If you have designated the new broker to be identified under a selected broker type in the system, then you can designate that the frequency of payment identified for the broker type be applicable by default to the new broker too. To do so, check this box.

### **Hold Back Payment**

#### *Mandatory*

Select 'Yes' from drop-down list to indicate that commission payments to the new broker must be held back and not paid out. The commission payment will be held back and not paid out until the tax liability of the broker falls below the commission earned, for a tax year.

### **Held From**

#### *Date Format; Optional*

Select the Held From date. from the adjoining calendar.

### **Overridden Percent**

#### *Numeric; 15 Characters; Optional*

Specify the overridden percentage.

For the purpose of computing and deducting withholding tax, the tax slabs (if any) maintained in the With Holding Tax Input for the broker category under which the broker is placed, are identified. However, you can specify a fixed percentage in this field that will override any slab details maintained for the broker category.

Therefore, the percentage that you specify here is used to compute tax, and supersedes any WHT slabs maintained in the With Holding Tax Input screen.

### **Broker Disable Status**

#### *Mandatory*

Select the broker status from the drop-down list. Select 'Yes' to indicate that the broker whose record you are creating is disabled.

If the broker disable status is selected as 'Yes' then the Broker is marked as Pending Closure on save. The broker needs to be authorized to incorporate the status change of the broker and then it will not be available for the new business. Also the system will check if the broker is associated with any active UH accounts, SI, or policy. If yes, the system displays the following message:

'Broker has pending transactions/business in the system' and broker status is marked as 'Pending closure'.

While the Broker is in Pending Status, any commission earned from Debit Orders is paid, but the Broker Code is not available for any new business.

A broker whose record in the system is disabled cannot be designated for an investor or for any transactions, and commission payments for the broker will also not be processed or paid out.

---

#### **Note**

You can re-enable the disabled broker if the broker is disabled by mistake.

---

### **Employer ID Number**

#### *Alphanumeric; 50 Characters; Optional*

Specify the employer ID number.

### **Tax ID**

#### *Alphanumeric; 50 Characters; Optional*

Specify the tax identification.

**Tax Circle**

*Alphanumeric; 15 Characters; Optional*

Select the tax circle country from the adjoining option list.

**Tax Certificate Effective Date**

*Date Format; Optional*

Specify the date from which the tax certificate is effective.

**Tax Certificate Expiry Date**

*Date Format; Optional*

Specify the expiry date of the tax certificate.

**FATCA Sponsor Type**

*Optional*

Select the FATCA sponsor type from the adjoining drop down list. The values are:

- Sponsoring Entity
- Sponsored Entity

If you select 'Sponsoring Entity', you need to specify the sponsoring entity type and sponsoring entity ID.

If you select 'Sponsored Entity', you need not to specify the sponsoring entity type and sponsoring entity ID.

**Sponsoring Entity Type**

*Numeric; 1 Character; Optional*

Specify the sponsoring entity type. You can also select the valid entity type from the adjoining option list.

**GIIN Issue Date**

*Date Format; Optional*

Specify the GIIN issue date.

The GIIN issue date cannot be greater than the application date.

**GIIN Verified Flag**

*Display*

System displays the GIIN verified flag based on the GIIN. In case the GIIN is entered and not chosen from the list, the flag GIIN verified will be set to 'NO'. If the GIIN is chosen from the list of values, then GIIN verified flag will be set to 'YES'.

**Global Intermediary Identification Number (GIIN)**

*Alphanumeric; 30 Characters; Optional*

Specify the global intermediary identification number.

**US Indicia Available**

*Display*

The system defaults US Indicia Available as Yes if any of the below mentioned values are true::

- The nationality is US
- The country of birth is US
- The country of domicile is US

- The country of incorporation is US
- The country of correspondence or alternate address is US
- The country code of the telephone number is 01
- The country code of the bank branch address is US

### **FATCA Status**

#### *Display*

If the 'US Indicia Available' is true then the 'FATCA Status' value depends on the FATCA Maintenance.

- If the 'US Indicia Available' is false then the 'FATCA Status' displays 'Not Applicable'.
- If the Broker is compliant then 'FATCA Status' displays 'Compliant'
- If the Broker is non compliant then 'FATCA Status' displays 'Recalcitrant'
- If the Broker is yet to be classified then 'FATCA Status' displays 'Pending classification'.

### **FATCA Classification**

#### *Display*

The system displays the FATCA classification type.

#### **Description**

##### *Display*

The system displays the description of FATCA classification.

### **Sponsoring Entity ID**

*Alphanumeric; 12 Characters; Optional*

Specify the sponsoring entity for the FATCA entity type. You can also select the valid entity ID from the adjoining option list.

### **GIIN Expiry Date**

*Date Format; Optional*

Specify the GIIN expiry date.

The GIIN expiry date cannot be lesser than the GIIN issue date.

### **Individual**

#### **Nationality**

*Alphanumeric; 3 Characters; Optional*

Select the nationality from the adjoining option list.

#### **Description**

##### *Display*

The system displays the description for the selected nationality.

#### **Country of Domicile**

*Alphanumeric; 3 Characters; Optional*

Select the country of domicile from the adjoining option list.

#### **Description**

##### *Display*

The system displays the description for the selected country of domicile.

### **Country of Birth**

*Alphanumeric; 3 Characters; Optional*

Select the country of birth from the adjoining option list.

### **Description**

*Display*

The system displays the description for the selected country of birth.

### **Corporate**

#### **Incorporation Country**

*Alphanumeric; 3 Characters; Optional*

Select the Incorporation country from the adjoining option list.

### **Description**

*Display*

The system displays the description for the selected country of incorporation.

### **Payment Details**

In this section, specify the parameters that will govern the processing and payment of commission due the broker.

Also, if the broker is VAT registered, indicate the corresponding registration number.

You can access this section through the Payment Details link.

#### **Hierarchy Commission Percentage**

*Numeric; 5 Characters; Mandatory*

Specify the percentage of the commission received that is to be paid by the broker to the immediate parent broker level.

For a given broker hierarchy structure, the commissions received at any level may be shared between the brokers of the hierarchy in a pre-defined manner.

To understand how earned commission would be shared in a hierarchy structure, let us consider an example.

Consider a four-tier broker setup as given below. Let us suppose that the transaction commission processed of a particular subscription transaction must be split amongst the brokers in the following manner.

The Top-Level (Level Zero) parent broker receives 10%

The Level 1 parent broker receives 15%

The Level 2 parent broker receives 25%

The Level 3 parent broker receives 50%

Such a setup entails that a subscription transaction commission of 1000 currency units (initiated by Level 4 broker) must be split amongst this broker hierarchy as follows:

The Top-Level (Level Zero) parent broker receives 100 currency units.

The Level 1 parent broker receives 150 currency units.

The Level 2 parent broker receives 250 currency units.

The Level 3 parent broker receives 500 currency units.

Therefore, this must be the pattern of receivables that must arise from this commission setup, for this hierarchy.

In Oracle FLEXCUBE, to enable this kind of a pattern, the following setup (called the payables method) is used.

Set the commission percentage of Top-Level (Level Zero) parent broker to 0% (i.e., this broker pays nothing to the immediate parent broker as the broker is a level zero broker)

Level 1 parent broker: 60% (Pays 60% of commission received to immediate parent broker)

Level 2 parent broker: 50% (Pays 50% of commission received to immediate parent broker)

Level 3 parent broker: 50% (Pays 50% of commission proceeds to immediate parent broker i.e. Level 2)

As a result of the above setup for the case mentioned above, (subscription commission of 1000 currency units) the split will be as follows:

<b>Broker</b>	<b>Receivable (Currency Units)</b>	<b>Payable (Currency Units)</b>	<b>Net Receivable (Currency Units)</b>
Level 3 Broker	1000	500	500
Level 2 broker	500	250	250
Level 1 broker	250	150	100
Level 0 broker	150	0	150

### **Payment Frequency**

#### *Optional*

From the drop-down list, indicate the frequency according to which commission payments must be made to the broker. The list displays the following values:

- Weekly
- Monthly
- Quarterly
- Half - Yearly
- Yearly
- Fortnightly

If you have designated the broker to be identified under a selected broker type, and also checked the Use Broker Type Payment Details check box in this screen, the frequency of payment identified for the selected broker type is also applicable by default for the broker. This frequency is displayed here.

### **Next Payment Date**

#### *Date Format; Optional*

Specify the earliest future date on which the next commission payment should be made to the broker. Do not specify a designated system holiday in this field. The commissions will be



processed based on the new payment date and the frequency specified will be used to make periodic payments.

### **Last Payment Date**

#### *Display*

The most recent date on which a commission payment was made to this broker is displayed here. When you are creating a new record for a broker in this screen, this field is empty.

### **Default Unit Holder ID**

#### *Alphanumeric; 12 Characters; Optional*

Select the ID of the unit holder account that is designated to be used as the default account in the system for the broker. This is typically so when the broker prefers that a unit holder receives the proceeds of the commission payments.

Whenever the broker opts for reinvestment of earned commission back into the funds of the AMC, (according to the income distribution setup options defined for the broker) the reinvestment will be effected through the unit holder ID you specify here.

You can query for unit holder ID by clicking 'Find UH' button.

### **VAT Details**

#### **VAT Registered**

##### *Mandatory*

Select 'Yes' option from the drop-down list to indicate that the broker is a VAT Registered broker.

#### **VAT Registration No.**

##### *Alphanumeric; 15 Characters; Optional*

If the broker is a VAT registered broker, specify the broker's VAT Registration Number.

#### **VAT Registration Date**

##### *Date Format; Optional*

Select the date of VAT registration from the adjoining calendar. VAT Registration date is mandatory if the broker is a VAT registered broker.

While processing broker commission, the system computes the VAT amount only if the transaction date is on or after the VAT registration date of the broker.

During periodic loan accrual processing, system computes the VAT amount only if the accrual date is on or after the VAT registration date maintained at the broker level.

#### **VAT Expiry Date**

##### *Date Format; Optional*

Select VAT expiry date from the adjoining calendar.

### 5.3.6 Broker Contact Info Tab

In this section, specify all the details of the available modes of communication and correspondence with the broker. Click 'Broker Contact Info' tab to enter the details.

The screenshot shows the 'FCIS Broker Maintenance Detail' window with the 'Broker Contact Info' tab selected. The window has a 'Save' button at the top left and a tab bar with 'Broker Contact Info' highlighted. Below the tab bar is a 'Broker Contact Info' section with a table. The table has columns for 'Address Type', 'Address Line 1', 'Address Line 2', 'City', 'Zip Code', 'US State', and 'State'. The 'Address Type' column has a dropdown menu with 'Correspondence' selected. The 'US State' column has a dropdown menu with 'No' selected. At the bottom of the window, there are fields for 'Input By', 'Authorized By', 'DateTime', 'Mod No', 'Authorized', 'Unauthorized', 'Open', and 'Open', along with a 'Cancel' button.

You can specify at least two addresses, and designate one as the default mailing address to be used for correspondence with the broker, and the other as the alternate address. Specify the default address under the Default Address head, and the alternate address under the Alternate Address head.

You can also maintain the SWIFT Address for the main brokerage firm of the broker type, in the SWIFT Address tab.

The following fields comprise the Correspondence; Alternate and SWIFT address information in the Address Type tab.

#### **Address Type**

##### *Mandatory*

Select the type of address from the drop-down list. The list displays the following values:

- Correspondence
- Alternate
- Swift

#### **Address Lines 1-2**

*Alphanumeric; 80 Characters; Optional (Address Line 1 is Mandatory)*

Specify the postal address that is to be used for correspondence with the broker.

**City**

*Alphanumeric; 80 Characters; Optional*

Specify the name of the city of residence of the broker. You can select the city from the drop down list provided. The available options depend on the values defined at the params maintenance. If the city is not available in the list, you can specify the city in the field provided alongside.

**Zip Code**

*Alphanumeric; 10 Characters; Optional*

Specify the zip code of the specified city of residence of the broker.

**US State**

*Optional*

Select 'Yes' option from drop-down list to indicate that the specified state is a US (United States) state.

**State**

*Alphanumeric; 80 Characters; Optional*

Specify the state in which the city of residence of the broker is located. You can select the state of residence from the drop down list provided. The available options depend on the values defined at the params maintenance. If the state is not available in the list, you can specify the city in the field provided alongside.

**Country**

*Alphanumeric; 3 Characters; Optional*

Select the country in which the broker is domiciled, from the drop-down list.

**Contact Person**

*Alphanumeric; 70 Characters; Optional*

Specify the name of any contact person or official through whom communication with the broker is possible.

**Int. Dialing Code +**

*Alphanumeric; 10 Characters; Optional*

Specify the international dialling code.

**Telephone 1**

*Alphanumeric; 60 Characters; Optional*

Enter the contact telephone numbers of the broker.

**Int. Dialing Code +**

*Alphanumeric; 10 Characters; Optional*

Specify the international dialling code.

**Telephone 2**

*Alphanumeric; 60 Characters; Optional*

Enter the contact telephone numbers of the broker.

**Int. Dialing Code +**

*Alphanumeric; 10 Characters; Optional*

Specify the international dialling code.

**Cell Phone Number**

*Alphanumeric; 60 Characters; Optional*

Specify the cell phone number of the broker.

**Int. Dialing Code +**

*Alphanumeric; 10 Characters; Optional*

Specify the international dialling code.

**Fax Number**

*Alphanumeric; 120 Characters; Optional*

Enter the fax number of the broker.

**Email**

*Alphanumeric; 255 Characters; Optional*

Specify the E-mail address of the broker.

**Effective From Date**

*Date Format; Optional*

Specify the date that marks the beginning of the period for which the specified alternate address is valid.

**Effective To Date**

*Date Format; Optional*

Specify the date that marks the end of the period for which the specified alternate address is valid.

**BIC Code**

*Alphanumeric; 12 Characters; Optional*

Specify the Bank Identifier Code (BIC) of the broker.

## 5.3.7 Broker Bank Details Tab

FCIS Broker Maintenance Detail

Save

Broker Details | Broker Contact Info | **Broker Bank Details** | Broker Legacy Details | Broker Preference | Related Parties | Broker Add Info

1 of 1

### Broker Bank Details

Bank\*  Bank Name

Branch\*  IBAN

Account Type\*  Account Name\*

Account Number\*  Account Currency\*

Default  Direct Debit Allowed

Swift Format  Bank Charged

### Beneficiary Details

Beneficiary  Beneficiary BIC Code

Beneficiary Add1  Beneficiary Acct No

Beneficiary Add2  Beneficiary Code

Beneficiary Add3  Beneficiary Info

### Intermediary Details

Intermediary  Intermediary BIC Code

Intermediary Add1  Intermediary Acct No

Intermediary Add2  Intermediary Code

Intermediary Add3  Intermediary Info

Input By  DateTime  Mod No

Authorized By  DateTime  Authorized  Unauthorized

Open  Open

Cancel

In this section, you specify details of any bank accounts operated by the broker, which are preferred for transacting with the AMC. You can access this section by clicking 'Broker bank Details' tab.

You can specify any number of preferred bank accounts for a broker for each currency, but you must designate one of these to be used by the broker as the default bank account for making or receiving payments in transactions in each currency.

For each bank account in each currency, specify the following details:

### **Broker Bank Details**

#### **Bank**

*Alphanumeric; 12 Characters; Mandatory*

From the list, select the name of the bank in which the account is held.

#### **Bank Name**

*Display*

The system displays the name of the bank for the selected bank code.

#### **Branch**

*Alphanumeric; 12 Characters; Mandatory*

From the list, select the name of the branch of the bank in which the account is held.

**Account Type**

*Alphanumeric; 1 Character; Mandatory*

From the list, select the nature of the account held by the broker.

The list provides all account types that have been set up in the Account Type Maintenance records.

**Account Number**

*Alphanumeric; 20 Characters; Mandatory*

Specify the number of the account held by the broker in the selected bank.

**Default**

*Optional*

Select 'Yes' to identify the bank account that is to be reckoned as the default bank account for the broker in the system.

**IBAN**

*Alphanumeric; 40 Characters; Optional*

Specify the IBAN (International Bank Account Number) of the account holder.

**Account Name**

*Alphanumeric; 100 Characters; Mandatory*

Specify the name in which the broker holds the specified bank account.

By default, the system reckons this to be the specified name of the broker, and the same is displayed here. It will be accepted into the database as the account holder's name if you do not specify any other.

**Account Currency**

*Alphanumeric; 3 Characters; Mandatory*

Select the currency of the bank accounts that you are designating for the broker. You can maintain any number of accounts in each currency; however, you must designate one default bank account for each currency.

---

**Note**

You can make commission payments where the commission currency is different from the broker bank account currency by selecting MCY option from the list of values for account currency.

---

**Direct Debit Allowed**

*Optional*

Select 'Yes' to allow the direct debit.

**SWIFT format**

*Optional*

Select the SWIFT format from the drop-down list. The list displays the following values::

- MT103
- MT202

**Bank Charged**

*Optional*

Select the bank charged details from the drop-down list. The list displays the following values:

- Beneficiary
- Remitter
- Share

### **Beneficiary Details**

#### **Beneficiary**

*Alphanumeric; 35 Characters; Optional*

Specify the beneficiary details.

#### **Beneficiary Add1-3**

*Alphanumeric; 105 Characters; Optional*

Enter beneficiary address.

#### **Beneficiary BIC Code**

*Alphanumeric; 24 Characters; Optional*

Enter beneficiary BIC Code.

#### **Beneficiary Acct Number**

*Alphanumeric; 34 Characters; Optional*

Enter beneficiary Account Number.

#### **Beneficiary Code**

*Alphanumeric; 24 Characters; Optional*

Enter beneficiary code.

#### **Beneficiary Info**

*Alphanumeric; 100 Characters; Optional*

Enter beneficiary information.

#### **Beneficiary IBAN**

*Alphanumeric; 40 Characters; Optional*

Specify the beneficiary IBAN details.

### **Intermediary Details**

#### **Intermediary**

*Alphanumeric; 35 Characters; Optional*

Enter the intermediary details.

#### **Intermediary Add 1-3**

*Alphanumeric; 105 Characters; Optional*

Enter intermediary address.

#### **Intermediary BIC Code**

*Alphanumeric; 24 Characters; Optional*

Enter intermediary BIC Code.

#### **Intermediary Acct Number**

*Alphanumeric; 34 Characters; Optional*

Enter intermediary Account Number.

**Intermediary Code**

*Alphanumeric; 24 Characters; Optional*

Enter intermediary code.

**Intermediary Info**

*Alphanumeric; 100 Characters; Optional*

Enter intermediary information.

**Intermediary IBAN**

*Alphanumeric; 40 Characters; Optional*

Enter intermediary IBAN details.

**Further Credit Details****Further Credit Name**

*Alphanumeric; 35 Characters; Optional*

Enter further credit name.

**Further Credit Acct Number**

*Alphanumeric; 35 Characters; Optional*

Enter further credit account number.

**Reference Section****Reference 1-2**

*Alphanumeric; 35 Characters; Optional*

Enter the reference details.



### 5.3.8 Broker Legacy Details Tab

Click 'Broker Legacy Details' tab to enter the details.

The screenshot shows a web application window titled "FCIS Broker Maintenance Detail". At the top, there is a "Save" button and a series of tabs: "Broker Details", "Broker Contact Info", "Broker Bank Details", "Broker Legacy Details" (which is highlighted in red), "Broker Preference", "Related Parties", and "Broker Add Info". Below the tabs, the "Broker Legacy Details" section is active. It features a table with one row and one column labeled "Legacy Code". A blue checkmark is visible in the first cell of the table. Above the table, there are navigation controls including "1 of 1" and a "Go" button. At the bottom of the window, there are several input fields: "Input By" and "Authorized By" (both empty), "DateTime" and "DateTime" (both empty), "Mod No" (empty), "Authorized" and "Unauthorized" (both empty), and "Open" and "Open" (both empty). A "Cancel" button is located in the bottom right corner.

#### **Legacy Code**

*Alphanumeric; 12 Characters; Optional*

Enter any legacy code linked to the broker. The legacy code for each broker must be unique in the system. System will not allow you to store duplicate legacy codes. While processing a transaction, you can search for the broker using the legacy codes specified here.

## 5.3.9 Broker Preference Tab

FCIS Broker Maintenance Detail

Save

Broker Details | Broker Contact Info | Broker Bank Details | Broker Legacy Details | **Broker Preference** | Related Parties | Broker Add Info

Broker Preference Details

Feed Type	Feed Structure	Start Date	Feed Frequency	Feed Format
<input checked="" type="checkbox"/>		MMDDYYYY		

Input By: \_\_\_\_\_ DateTime: \_\_\_\_\_ Mod No: \_\_\_\_\_  
Authorized By: \_\_\_\_\_ DateTime: \_\_\_\_\_ Authorized: \_\_\_\_\_ Unauthorized: \_\_\_\_\_  
Open: \_\_\_\_\_ Open: \_\_\_\_\_

Cancel

Click 'Broker Preferences' tab to enter the details.

### **Broker Preference Details**

#### **Feed Type**

*Alphanumeric; 20 Characters; Optional*

From the option list, select the type of feed the broker wishes to receive. The various types available are as follows:

- Transaction Feeds – All transactions, Subscription, Redemption, Switch, Transfer
- Brokerage Payment Feeds
- Investor Feeds
- NAV Feeds
- Scheme Feeds

You cannot maintain preferences for a feed type more than once. If a duplicate feed type is selected, then system will throw up an error.

#### **Feed Structure**

*Alphanumeric; 4 Characters; Optional*

Specify the format of the file being extracted. The options available in option list are as follows:

- DBF
- TXT
- XLS

The available options depend on the values defined in PARAMS maintenance.

### Start Date

*Date Format; Optional*

Specify the date that marks the beginning of the Feed period.

### Feed Frequency

*Alphanumeric; 20 Characters; Optional*

From the list, indicate the frequency according to which the data feed must be made to the broker.

### Feed Format

*Alphanumeric; 6 Characters; Optional*

Indicate the format of the Feed to be made to the broker.

The available options depend on the values defined in PARAMS maintenance.

## 5.3.10 Related Parties Tab

Click 'Related Parties' tab to specify the details

The screenshot shows the 'PCIS Broker Maintenance Detail' application window. The 'Related Parties' tab is selected. The table below is empty.

Entity Type *	Entity Type Description	Entity ID *	Entity Name	Reporting Level *	Preferred Mailing Mode
---------------	-------------------------	-------------	-------------	-------------------	------------------------

Input fields at the bottom: Input By, Authorized By, DateTime, Mod No (Authorized/Unauthorized), Open (Open), and a Cancel button.

You can specify the following details:

### Entity Type

*Alphanumeric; 2 Characters; Mandatory*

Select the entity type. Alternatively, you can select entity type from the option list. The list displays all valid entity types maintained in the system.

**Entity Type Description**

*Display*

The system displays the description for the selected entity type.

**Entity ID**

*Alphanumeric; 12 Characters; Mandatory*

Select the entity ID from the option list. These entities are based on the Entity Type chosen.

**Entity Name**

*Display*

The system displays the name of the entity for the selected entity ID.

**Reporting Level**

*Alphanumeric; 1 Character; Mandatory*

Select the reporting level from the option list. The following are the reporting levels:

- A: All Reports
- C: Contract notes and trade acknowledgement
- V: Valuations and statements
- N: No Reporting

**Preferred Mailing Mode**

*Alphanumeric; 1 Character; Optional*

Select the preferred mailing mode from the list. The following are the preferred mailing modes:

- Mail
- E-Mail
- Fax
- SWIFT

**Link Notes**

*Alphanumeric; 255 Characters; Optional*

The link notes stores free format text which is used to explain the reason for linking the entity with the unit holder.

---

**Note**

Related Parties are captured for informational purpose only and no processing impact is associated.

---

**Related Party Level**

*Mandatory*

Select the related party level from the adjoining drop-down list. Following are the options available:

- All
- Fund
- Fund Family
- Legal Entity
- AMC

### Related Party Value

*Alphanumeric; 12 Characters; Mandatory*

Specify the related party value. The adjoining option list displays all valid related party values maintained in the system. You can choose the appropriate one.

If you select 'All' in 'Related Party Level' field, then you need to select 'All' from the adjoining option list in 'Related Party Value' field as well. The system will not allow any more records to be added if ALL has been selected in the 'Related Party Level' field for a particular entity ID and entity type combination.

### 5.3.11 Broker Add Info Tab

If the AMC has designated any additional information heads for brokers, you can indicate the relevant information applicable to the broker under each head, in this section.

You can access this section by clicking 'Broker Add Info' tab.

Other Info Field	Field Value
<input checked="" type="checkbox"/> ADDRESS	BTP
<input type="checkbox"/> CONTACT NUMBER	

### Other Info Field

*Display*

Displays the other information in the field.

### Field Value

*Alphanumeric; 60 Characters; Optional*

Select the field value from the option list.

## 5.4 Broker Maintenance Summary Screen

This section contains the following topics:

- [Section 5.4.1, "Retrieving Broker Records in Broker Maintenance Summary Screen"](#)

- [Section 5.4.2, "Editing Broker Records "](#)
- [Section 5.4.3, "Viewing Broker Records"](#)
- [Section 5.4.4, "Deleting Broker Records "](#)
- [Section 5.4.5, "Authorizing Broker Records "](#)
- [Section 5.4.6, "Amending Broker Records"](#)
- [Section 5.4.7, "Authorizing Amended Broker Records"](#)
- [Section 5.4.8, "Amending Broker Details after Transaction Unitization "](#)

#### **5.4.1 Retrieving Broker Records in Broker Maintenance Summary Screen**

After you have set up a record for a broker in the system, you can perform the following maintenance operations, as required:

- Make changes to any information in the record before it is authorized.
- Have the record authorized by another user. Commission for a broker will only be processed by the system when the broker's maintenance record in the system is authorized.
- After authorization, you can make further changes to any information in the record through amendment.

To perform any of these operations, use the 'FCIS Broker Maintenance Summary' screen. You can invoke this screen by typing 'UTSBRKMN' in the field at the top right corner of the Application tool bar and clicking on the adjoining arrow button.

After a broker record is authorized, you can also:

- Set up the preferred currency and income distribution options applicable for the broker. You can do this by accessing the Broker Payment Currency Preference screen and Broker IDS Setup Detail screen.

- Set up a journal of commission payment details for the broker. This journal can be used to track advance payments of commissions and adjustment of the same. You can use the Broker Journal Detail screen from the Broker Journal menu in the Browser.

You can retrieve a previously entered record in the FCIS Broker Maintenance Summary screen, as follows:

- Specify any or all of the following details in the FCIS Broker Maintenance Summary screen:
  - The status of the transaction in the Authorization Status field. If you choose the “Blank Space” option, then all the records that involve the specified unit holder are retrieved.
  - The status of the record in the Record Status field. If you choose the “Blank Space” option, then all the records that involve the specified unit holder are retrieved.
  - The Broker Code
  - The Broker Name
  - The AMC
  - The Level Number
  - The Rule Effective Date
  - The Broker Type
  - The Broker Consultant
  - The Broker Category
  - The Hold Back Payment
  - The Broker Disable Status

- The Latest Rule

Click 'Search' button to view the records. All records with the specified details are retrieved and displayed in the lower portion of the screen.

---

**Note**

You can also retrieve the individual record detail from the detail screen by doing query in the following manner:

- Press F7
  - Input the Broker Code
  - Press F8
- 

You can perform Edit, Delete, Amend, Authorize, Reverse, Confirm operation by selecting from the Action list.

You can also search the record by using combination of % and alphanumeric value.

**Example**

You can search the record for Broker Code by using the combination of % and alphanumeric value as follows:

- Search by A%: System will fetch all the records whose Broker Code starts from Alphabet 'A'. For Example: AGC17, AGVO6, AGC74 and so forth.
- Search by %7: System will fetch all the records whose Broker Code ends by numeric value '7'. For Example: AGC17, GSD267, AGC77 and so forth.
- Search by %17%: System will fetch all the records whose Broker Code contains the numeric value 17. For Example: GSD217, GSD172, AGC17 and so forth.

**5.4.2 Editing Broker Records**

You can modify the details FCIS Broker Maintenance parameters that you have already entered into the system, provided it has not been subsequently authorized. You can perform this operation as follows:

- Invoke the FCIS Broker Maintenance Summary screen from the Browser.
- Select the status of the record that you want to retrieve for modification in the Authorized field. You can only modify records that are unauthorized. Accordingly, choose the Unauthorized option.
- Specify any or all of the details in the corresponding fields to retrieve the record that is to be modified. All unauthorized records with the specified details are retrieved and displayed in the lower portion of the screen.
- Double click the record that you want to modify in the list of displayed records. The FCIS Broker Maintenance Detail screen is displayed.
- Select Unlock Operation from Action list to modify the record. Modify the necessary information.
- Click Save to save your changes. The FCIS Broker Maintenance Detail screen is closed and the changes made are reflected in the FCIS Broker Maintenance Summary screen.

**5.4.3 Viewing Broker Records**

To view a record that you have previously entered, you must retrieve the same in the FCIS Broker Maintenance Summary screen, as follows:



- Invoke the FCIS Broker Maintenance Summary Screen from the Browser.
- Select the status of the record that you want to retrieve for viewing in the Authorized field. You can also view all records that are either unauthorized or authorized only, by choosing the Unauthorized / Authorized option.
- Specify any or all of the details of the record in the corresponding fields on the screen, and click 'Search' button. All records with the specified details are retrieved and displayed in the lower portion of the screen.
- Double click the record that you want to view in the list of displayed records. The FCIS Broker Maintenance Detail screen is displayed in View mode.

#### **5.4.4 Deleting Broker Records**

You can delete only unauthorized records in the system. To delete a **record** that you have previously entered:

- Invoke the FCIS Broker Maintenance Summary screen from the Browser.
- Select the status of the record that you want to retrieve for deletion.
- Specify any or all of the details and click 'Search' button. All records with the specified details are retrieved and displayed in the lower portion of the screen.
- Double click the record that you want to delete. The FCIS Broker Maintenance Detail screen is displayed.
- Select Delete operation from the Action list. The system prompts you to confirm the deletion, and the record is deleted physically from the system database.
- Only Maker can delete an unauthorized record.

#### **5.4.5 Authorizing Broker Records**

An unauthorized FCIS Broker Maintenance record must be authorized in the system for it to be processed. To authorize a record:

- Invoke the FCIS Broker Maintenance Summary screen from the Browser.
- Select the status of the record that you want to retrieve for authorization. Typically, choose the Unauthorized option.
- Specify any or all of the details of the record in the corresponding fields on the screen. Click 'Search' button. All records with the specified details that are pending authorization are retrieved and displayed in the lower portion of the screen.
- Double click the transaction that you wish to authorize. The FCIS Broker Maintenance Detail screen is displayed. Select Authorize operation from Action.

When the checker authorizes a record, details of validations, if any, that were overridden by the maker of the record during the Save operation, are displayed. If any of these overrides results in an error, the checker must reject the transaction.

#### **5.4.6 Amending Broker Records**

After a Broker Maintenance record is authorized, it can be modified using the Unlock operation from Action list. To make changes to a record after authorization:

- Invoke the Broker Maintenance Summary screen from the Browser.
- Select the status of the record that you wish to retrieve for amendment. You can only amend only authorized records.
- Specify any or all of the details of the Broker Maintenance in the screen. All records with the specified details are retrieved and displayed in the lower portion of the screen.

- Double click the record that you want to amend. The Broker Maintenance Detail screen is displayed in Amendment mode. Click the Unlock operation from the Action list to amend the record.
- Amend the necessary information. Click the Save button to save the changes.

## **5.4.7 Authorizing Amended Broker Records**

An amended Broker Journal record must be authorized for the amendment to be made effective in the system. The authorization of amended records can only be done from Fund Manager Module and Agency branch Module.

The process of authorization is subsequently the same as that for normal transactions.

The amended record with the changes is saved in the database as an amended, unauthorized record that you must subsequently authorize for your changes to be reflected as authorized in the database.

### **5.4.7.1 Details of Broker Record That Can Be Amended**

You can make changes to any of the following details in a broker record through an amendment operation:

- Broker Hierarchy
- VAT Information
- Next Payment Date
- Commission Information
- Enabling or Disabling brokers
- The status of the broker
- The rule effective date
- Legacy Codes
- Other Information
- Broker Details after transaction unitization

#### **Amending the Broker Hierarchy**

If you need to change the reporting structure in a broker hierarchy setup, you can amend the record of one of the concerned brokers and change the parent broker. You can also introduce an intermediate reporting level broker to whom the existing levels must report.

The following examples will make this clear:

### Example 1

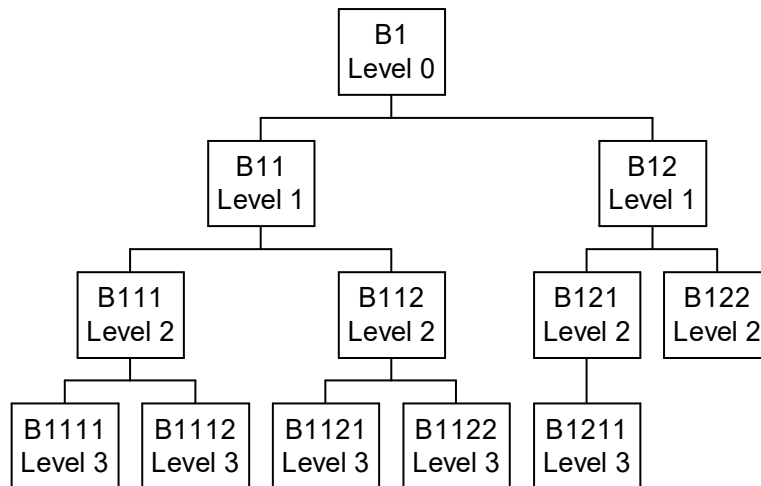

The above illustration is a sample Broker Hierarchy Structure that is referred to in the examples 1-3.

Consider the following hierarchy setup for representing a reporting structure:

Let us suppose that the record of broker B1 is amended, and as a result, the broker B1 undergoes a level change and now reports to broker B111. To enable this change, the broker code of broker B1 is altered from B1 (existing) to B111.

On authorization, this change will be interpreted by the system as follows:

Broker B111 will report to himself (become a level zero broker).

Broker B1 will report to broker B1

All brokers under broker B111 will report to broker B111.

All brokers under B1 broker will report to broker B1.

As a result of the above level changes the new hierarchy will look as follows:

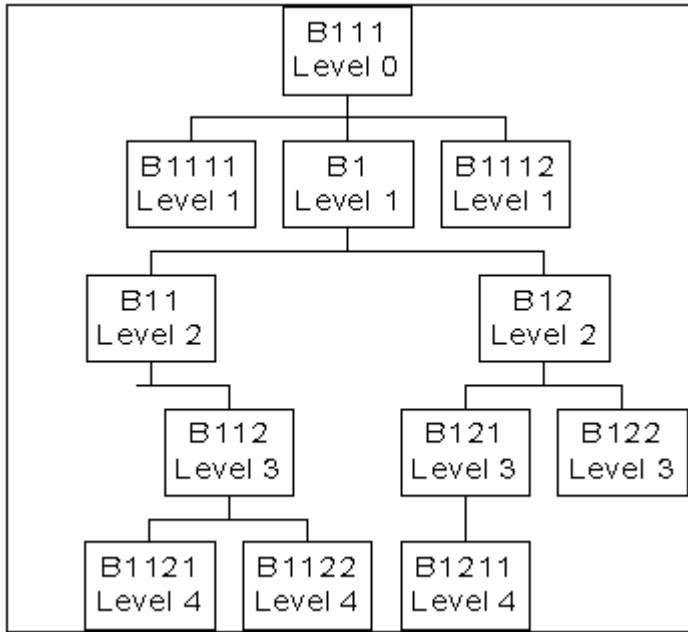

### **Example 2**

Let us suppose that, in the same original hierarchy structure, (the first figure) the record of the broker B11 is amended, and as a result, the broker B11 undergoes a level change and now reports to broker B111. To enable this change, the broker code of broker B11 is altered from B1 (existing) to B111.

On authorization, this will be interpreted by the system as follows:

Broker B111 will report to the original parent broker of broker B11, i.e., broker B1.

Broker B11 reports to broker B111.

All brokers under broker B111 will report to broker B111.

All brokers under broker B11 will report to broker B11.

As a result of the above level changes the new hierarchy will look as follows:

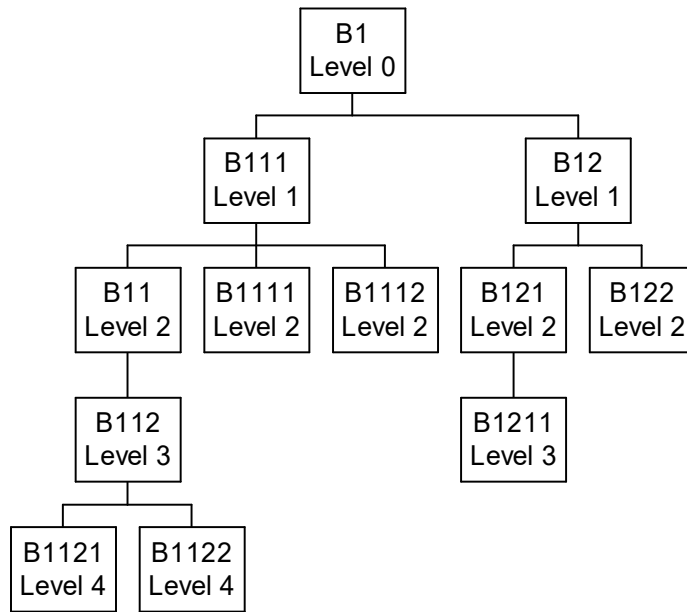

**Example 3**

If a new reporting level has to be incorporated so that an existing level reports to the new broker, the following level changes should be done.

For example, consider the original setup:

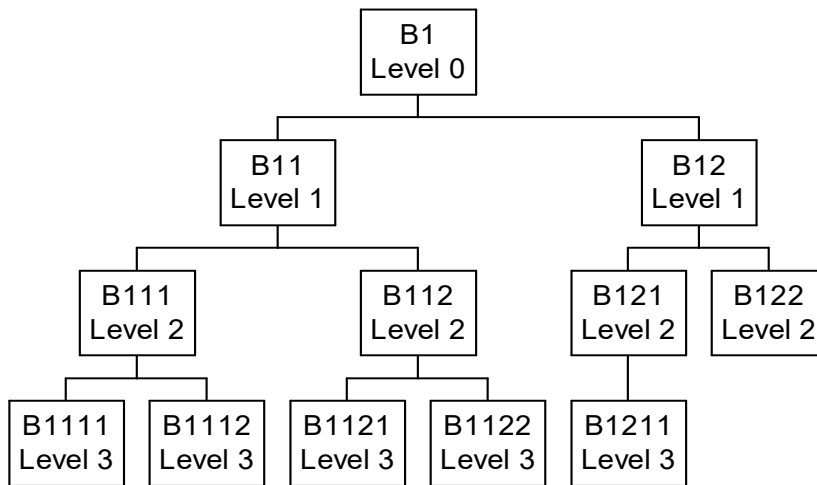

Let us suppose that a new broker Bx is required to be inserted as a level 3 broker under broker B111, and that all brokers who are currently reporting to B111 must now be made level 4 brokers who are required to report to broker Bx.

To meet the requirement, the following changes (amendments) must be done in the records of the brokers concerned:

Introduce broker Bx with parent broker as broker B111, and assign the level number 3 to this broker.

In the record of broker B1111, change the parent broker of broker B1111 to broker Bx, and change the level number assigned to broker B1111 from 3 to 4.

Do likewise in the record of broker B1112.

As a result of these amendments, the new reporting structure would look like this:

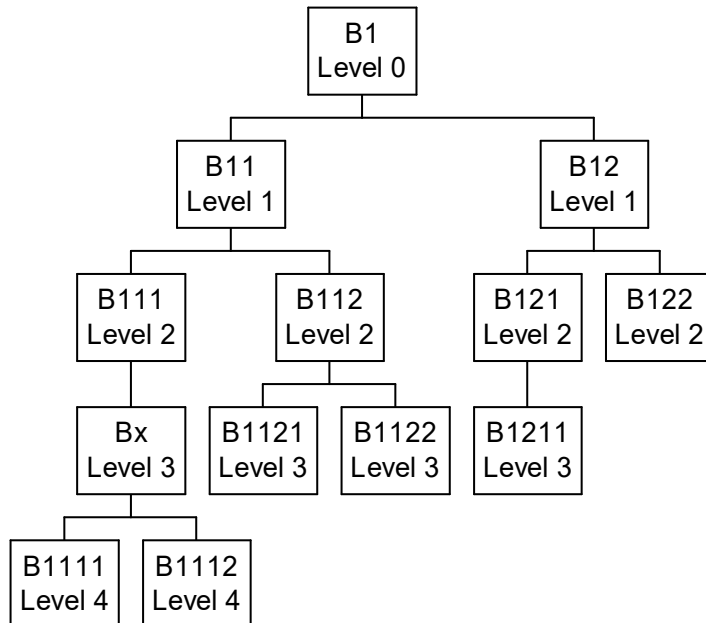

This structure reflects the desired changes.

#### **Amending VAT Information**

You can amend a broker record so that the VAT information can be changed. On authorization, this amended record will affect the VAT payment portion for VAT registered brokers. If the VAT Registered option is unchecked, for future payments VAT will not be added.

#### **Next Payment Date**

When you amend a broker record, you can alter the Next Payment Date. This possibility can be used in case a broker account is to be closed (disabled permanently) and the commission payable is to be paid out immediately.

#### **Commission Information**

When you amend a broker record, you can alter the Commission percentage payable by this broker to the immediate parent broker.

#### **Enabling or Disabling Brokers**

When you amend a broker record, you can disable or enable the broker. Therefore, this possibility can be used to disable a broker from initiating further transactions in the system. This restricts the agency branches in selecting the broker code in all the transaction screens. (To revoke the disabling of the broker, enable the broker again and authorize the details).

#### **Amending Other Information**

When you desire to change basic details such as addresses, names, contact persons, broker status, rule effective date and so on for a broker, you can amend the broker's record and make the required changes. On Amendment of Broker details, Rule Effective date will be defaulted with the current Application Date.

## 5.4.8 Amending Broker Details after Transaction Unitization

The system allows you to amend the broker details even after a transaction is unitized. If you amend the broker details of a transaction after unitization, the system passes the appropriate broker commission entries for the old and the new broker to the OMIPAY and GL interfaces.

The amendment of the broker details will not have any implications on:

- Re-computation of fees
- Oracle FLEXCUBE Commission Payments
- Periodic Loads applied on intermediary transactions.

## 5.5 Transaction Broker Amendment Screen

This section contains the following topic:

- [Section 5.5.1, "Invoking Transaction Broker Amendment Screen"](#)

### 5.5.1 Invoking Transaction Broker Amendment Screen

The 'Transaction Broker Amendment' screen displays the Transaction Broker Amendment details. You can invoke this screen by typing 'UTDTXBRM' in the field at the top right corner of the Application tool bar and clicking on the adjoining arrow button.

The screenshot shows a web-based application window titled "Transaction Broker Amendment Detail". At the top left, there is a "Save" button. Below it, the "Transaction Broker Amendment" section contains a "Transaction Option" dropdown menu with "UT" selected, and a "Transaction Number" field. To the right, there are three required fields: "Old Broker Code \*", "New Broker Code \*", and "Broker Name \*". At the bottom of the window, there are fields for "Input by", "DateTime", "Mod No", "Open", and "Authorized by". A "Cancel" button is located at the bottom right.

---

### Note

The screen restricts to modify transactions linked with single broker. For multiple brokers scenario you can reverse and recapture the transaction.

---

Select 'New' from the Actions menu in the Application tool bar or click new icon to enter the details of the Transaction Broker Amendment screen.

### Transaction Option

#### Mandatory

Select transaction option from the drop-down list. The list displays the following values:

- UT

- LEP

**Transaction Number**

*Alphanumeric; 16 Characters; Mandatory*

Enter UT transaction number or policy transaction number for amendment of Broker's information.

**Old Broker Code**

*Alphanumeric; 12 Characters; Mandatory*

Specify the Old Broker code.

**New Broker Code**

*Alphanumeric; 12 Characters; Mandatory*

Enter the New Broker Code.

**Broker Name**

*Display*

The system displays the broker name for the selected new broker code.

On authorization of the changes to the broker details:

- The system checks if the transaction is reversed or not. The system allows only non reversed transactions for broker change.
- The system internally corrects the broker's information for transaction and allocation related data stores and provides an internal log to historical data.

## **5.6 Broker Payment Currency Preference Detail Screen**

This section contains the following topic:

- [Section 5.6.1, "Invoking Payment Currency Preference Screen"](#)

### **5.6.1 Invoking Payment Currency Preference Screen**

You can specify preferred broker payments in multiple currencies based on the source currency of the commission through the Broker Payment Currency Preference screen. You



can invoke this screen by typing 'UTDBCYP' in the field at the top right corner of the Application tool bar and clicking on the adjoining arrow button.

FCIS Broker Payment Currency preference Detail

Save

Broker Payment Currency preference

Broker Code \*

Effective Date \*  MMDDYYYY

Broker Name

Broker Preferred Currency

1 of 1

<input checked="" type="checkbox"/>	Source Currency *	Preferred Currency *
<input checked="" type="checkbox"/>	<input type="text"/>	<input type="text"/>

Input by  DateTime  Mod No  Open

Authorized by  DateTime  Authorized

---

### Note

You cannot map multiple bank accounts to the same preferred currency.

---

Select 'New' from the Actions menu in the Application tool bar or click new icon to enter the details of the Broker Payment Currency Preference screen.

### Broker Payment Currency preference

#### Broker Code

*Alphanumeric; 12 Characters; Mandatory*

Select unique broker code from the adjoining list.

#### Broker Name

*Display*

The broker name will be displayed.

#### Effective Date

*Date Format, Mandatory*

Specify the date from which the broker payment currency is effective in the system.

### Broker Preferred Currency

#### Source Currency

*Alphanumeric; 3 Characters; Mandatory*

Specify the source currency of the payment.

#### Preferred Currency

*Alphanumeric; 3 Characters; Mandatory*

Select the preferred currency from the option list.

## 5.7 FCIS Broker Payment Currency Preference Summary Screen

This section contains the following topics:

- [Section 5.7.1, "Retrieving Broker Payment Currency Preference Summary"](#)
- [Section 5.7.2, "Editing Broker Payment Currency Preference "](#)
- [Section 5.7.3, "Viewing Broker Payment Currency Preference"](#)
- [Section 5.7.4, "Deleting Broker Payment Currency Preference"](#)
- [Section 5.7.5, "Authorizing Broker Payment Currency Preference"](#)
- [Section 5.7.6, "Amending Broker Payment Currency Preference"](#)
- [Section 5.7.7, "Authorizing Amended Broker Payment Currency Preference"](#)

### 5.7.1 Retrieving Broker Payment Currency Preference Summary

You can invoke the FCIS Broker Payment Currency Preference Summary screen by typing 'UTSBCYPR' in the field at the top right corner of the Application tool bar and clicking on the adjoining arrow button.

The screenshot displays the 'FCIS Broker Payment Currency preference Summary' application window. At the top, there is a search bar with options for 'Search', 'Advanced Search', 'Reset', and 'Clear All'. Below the search bar, there is a section for search criteria, including 'Authorization Status' (a dropdown menu), 'Open' (a dropdown menu), and 'Broker Code' (a text input field with a search icon). A table below shows columns for 'Authorization Status', 'Open', 'Broker Code', and 'Effective Date'. The table is currently empty. At the bottom right, there is an 'Exit' button.

You can retrieve a previously entered record in the FCIS Broker Payment Currency Preference Summary screen, as follows:

- Specify any or all of the following details in the FCIS Broker Payment Currency Preference Summary screen

- The status of the transaction in the Authorization Status field. If you choose the 'Blank Space' option, then all the records that involve the specified broker currency are retrieved.
- The status of the record in the Open field. If you choose the 'Blank Space' option, then all the records that involve the specified broker currency are retrieved.
- Broker Code

Click 'Search' button to view the records. All records with the specified details are retrieved and displayed in the lower portion of the screen.

You can also retrieve the individual record detail from the detail screen by doing query in the following manner:

- Press F7
- Input the Broker Code
- Press F8

You can perform Edit, Delete, Amend, Authorize, Reverse, Confirm operation by selecting from the Action list.

You can also search the record by using combination of % and alphanumeric value.

### **Example**

You can search the record for Broker Code by using the combination of % and alphanumeric value as follows:

- Search by A%: System will fetch all the records whose Broker Code starts from Alphabet 'A'. For Example: AGC17, AGVO6, AGC74 and so forth.
- Search by %7: System will fetch all the records whose Broker Code ends by numeric value '7'. For Example: AGC17, GSD267, AGC77 and so forth.
- Search by %17%: System will fetch all the records whose Broker Code contains the numeric value 17. For Example: GSD217, GSD172, AGC17 and so forth.

## **5.7.2 Editing Broker Payment Currency Preference**

You can modify the details of Broker Payment Currency Preference parameters that you have already entered into the system, provided it has not been subsequently authorized. You can perform this operation as follows:

- Invoke the FCIS Broker Payment Currency Preference screen from the Browser.
- Select the status of the record that you want to retrieve for modification in the Authorization Status field. You can only modify records that are unauthorized. Accordingly, choose the Unauthorized option.
- Specify any or all of the details in the corresponding fields to retrieve the record that is to be modified. All unauthorized records with the specified details are retrieved and displayed in the lower portion of the screen.
- Double click the record that you want to modify in the list of displayed records. The FCIS Broker Payment Currency Preference screen is displayed.
- Select Unlock Operation from Action list to modify the record. Modify the necessary information.
- Click Save to save your changes. The FCIS Broker Payment Currency Preference screen is closed and the changes made are reflected in the FCIS Broker Payment Currency Preference Summary screen.

### **5.7.3 Viewing Broker Payment Currency Preference**

To view a record that you have previously entered, you must retrieve the same in the FCIS Broker Payment Currency Preference Summary screen, as follows:

- Invoke the FCIS Broker Payment Currency Preference Screen from the Browser.
- Select the status of the record that you want to retrieve for viewing in the Authorization Status field. You can also view all records that are either unauthorized or authorized only, by choosing the Unauthorized/ Authorized option.
- Specify any or all of the details of the record in the corresponding fields on the screen, and click 'Search' button. All records with the specified details are retrieved and displayed in the lower portion of the screen.
- Double click the record that you want to view in the list of displayed records. The FCIS Broker Payment Currency Preference screen is displayed in View mode.

### **5.7.4 Deleting Broker Payment Currency Preference**

You can delete only unauthorized records in the system. To delete a record that you have previously entered:

- Invoke the FCIS Broker Payment Currency Preference Summary screen from the Browser.
- Select the status of the record that you want to retrieve for deletion.
- Specify any or all of the details and click 'Search' button. All records with the specified details are retrieved and displayed in the lower portion of the screen.
- Double click the record that you want to delete. The FCIS Broker Payment Currency Preference Detail screen is displayed.
- Select Delete operation from the Action list. The system prompts you to confirm the deletion, and the record is deleted physically from the system database.

### **5.7.5 Authorizing Broker Payment Currency Preference**

An unauthorized FCIS Broker Payment Currency Preference record must be authorized in the system for it to be processed. To authorize a record:

- Invoke the FCIS Broker Payment Currency Preference Summary screen from the Browser.
- Select the status of the record that you want to retrieve for authorization. Typically, choose the Unauthorized option.
- Specify any or all of the details of the record in the corresponding fields on the screen. Click 'Search' button. All record with the specified details that are pending authorization are retrieved and displayed in the lower portion of the screen.
- Double click the transaction that you wish to authorize. The FCIS Broker Payment Currency Preference Detail screen is displayed. Select Authorize operation from Action.

When the checker authorizes a record, details of validations, if any, that were overridden by the maker of the record during the Save operation, are displayed. If any of these overrides results in an error, the checker must reject the transaction.

### **5.7.6 Amending Broker Payment Currency Preference**

After a Broker Payment Currency Preference record is authorized, it can be modified using the Unlock operation from Action list. To make changes to a record after authorization:

- Invoke the FCIS Broker Payment Currency Preference Summary screen from the Browser.

- Select the status of the record that you wish to retrieve for amendment. You can only amend only authorized records.
- Specify any or all of the details of the FCIS Broker Payment Currency Preference in the screen. All records with the specified details are retrieved and displayed in the lower portion of the screen.
- Double click the record that you want to amend. The FCIS Broker Payment Currency Preference Detail screen is displayed in Amendment mode. Click the Unlock operation from the Action list to amend the record.
- Amend the necessary information. Click the Save button to save the changes.

### 5.7.7 **Authorizing Amended Broker Payment Currency Preference**

An amended Broker Payment Currency Preference record must be authorized for the amendment to be made effective in the system. The authorization of amended records can only be done from Fund Manager Module and Agency branch Module.

The process of authorization is subsequently the same as that for normal transactions.

---

#### **Note**

When a journal entry for a broker is authorized, the process for any adjustments specified in the entry to the next payment cycle or transaction for the broker is begun in the database. Subsequently, you cannot change a journal entry that has been authorized, in any way. The amendment operation is not available on authorized journal entries for brokers.

---

## 5.8 **Broker Migration Screen**

This section contains the following topics:

- [Section 5.8.1, "Processing Broker Merger"](#)
- [Section 5.8.2, "Invoking Broker Migration Screen"](#)

### 5.8.1 **Processing Broker Merger**

Broker merger is a scenario, where source broker code merges with target broker code to form a single entity.

Post RDR, if the broke merger is not due to advise, then the merger is considered as not advised and the new agent/broker will inherit the terms of holdings. Also. is eligible to receive commission.

Once the broker is merged, the commission due to source broker is paid to the target broker for the business mobilized by the source broker. Also, the system transfers the holdings of source broker to target broker. Post merger, if a transaction is received with source broker code, then the transaction is linked to the target broker code.

Merger of brokers is scheduled as a EOD batch process triggered by 'Broker Merger' activity on the day the merger is authorized.

---

#### **Note**

- If either the source or target broker is suspended or deceased, then the system disables broker merger.

- If source broker code is UK domiciled and target broker code is non UK domiciled or visa versa, then the system displays the warning message as “Source/target broker is UK Domiciled- Do you wish to continue”.

## 5.8.2 Invoking Broker Migration Screen

You can change the default broker, from one broker to the other, for all the unit holders, in bulk, through the Broker Migration screen.

You can invoke this screen by typing ‘UTDBRMIG’ in the field at the top right corner of the Application tool bar and clicking on the adjoining arrow button.

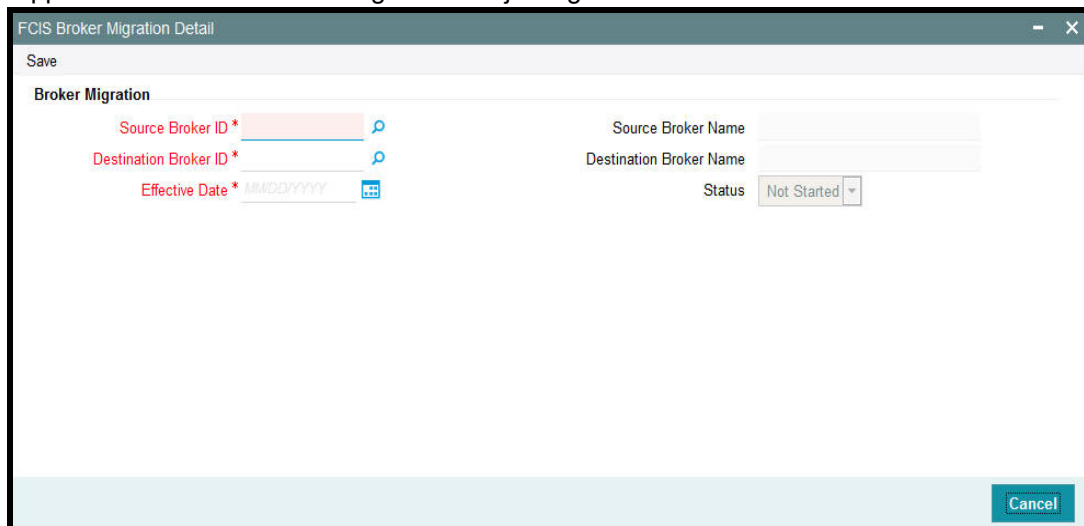

The system validates if the source broker status is Pending Closure before migration. Only the Brokers with disabled status as ‘No’ are mapped as destination brokers.

---

### Note

Duplicate entries with the same source and destination broker with the same effective date are not allowed.

---

Select 'New' from the Actions menu in the Application tool bar or click new icon to enter the details of the Broker Migration screen. Only save operation is applicable for the Broker Migration screen.

### Source Broker ID

*Alphanumeric; 12 Characters; Mandatory*

Source broker is the broker from whom migration is done. Select the source Broker ID of the option list.

### Source Broker Name

*Display*

The name of the source broker is displayed.

### Destination Broker ID

*Alphanumeric; 12 Characters; Mandatory*

Destination broker is the new broker to whom the details are migrated. Select the destination Broker ID of the option list.

### Destination Broker Name

*Display*

The name of the destination broker is displayed.

### Effective Date

*Date Format; Mandatory*

Specify the date from which the broker migration is effective in the system.

### Status

*Display*

The status of broker migration is displayed.

## 5.9 Broker Migration Summary Screen

This section contains the following topics:

- [Section 5.9.1, "Retrieving Broker Migration Summary"](#)
- [Section 5.9.2, "Viewing Broker Migration"](#)

### 5.9.1 Retrieving Broker Migration Summary

You can invoke the 'FCIS Broker Migration Summary' screen by typing 'UTSBRMIG' in the field at the top right corner of the Application tool bar and clicking on the adjoining arrow button.

The screenshot shows the 'FCIS Broker Migration Summary' application window. At the top, there is a search bar with options for 'Search', 'Advanced Search', 'Reset', and 'Clear All'. Below the search bar, there are input fields for 'Source Broker ID', 'Destination Broker ID', and 'Effective Date'. The 'Effective Date' field is set to 'MM/DD/YYYY'. Below the search fields, there is a table with columns: 'Source Broker ID', 'Destination Broker ID', 'Effective Date', and 'Status'. The table is currently empty. At the bottom right of the window, there is an 'Exit' button.

You can retrieve a previously entered record in the Broker Migration Summary screen, as follows:

- Specify any or all of the following details in the Broker Migration Summary screen:
- Source Broker ID
- Destination Broker ID
- Effective Date

Click 'Search' button to view the records. All records with the specified details are retrieved and displayed in the lower portion of the screen.

---

**Note**

You can also retrieve the individual record detail from the detail screen by doing query in the following manner:

- Press F7
  - Input the Source Broker ID
  - Press F8
- 

You can also search the record by using combination of % and alphanumeric value.

**Example**

You can search the record for Source Broker ID by using the combination of % and alphanumeric value as follows:

- Search by A%: System will fetch all the records whose Source Broker ID starts from Alphabet 'A'. For Example: AGC17, AGVO6, AGC74 and so forth.
- Search by %7: System will fetch all the records whose Source Broker ID ends by numeric value '7'. For Example: AGC17, GSD267, AGC77 and so forth.
- Search by %17%: System will fetch all the records whose Source Broker ID contains the numeric value 17. For Example: GSD217, GSD172, AGC17 and so forth.

## **5.9.2 Viewing Broker Migration**

To view a record that you have previously entered, you must retrieve the same in the Broker Migration Summary screen, as follows:

- Invoke the Broker Migration Summary Screen from the Browser.
- Select the status of the record that you want to retrieve for viewing in the Authorization Status field. You can also view all records that are either unauthorized or authorized only, by choosing the Unauthorized/ Authorized option.
- Specify any or all of the details of the record in the corresponding fields on the screen, and click 'Search' button. All records with the specified details are retrieved and displayed in the lower portion of the screen.
- Double click the record that you want to view in the list of displayed records. The Broker Migration Detail screen is displayed in View mode.

## **5.10 Broker Journal Detail Screen**

This section contains the following topics:

- [Section 5.10.1, "Maintaining Accounting Journal for Broker"](#)
- [Section 5.10.2, "Invoking Broker Journal Detail Screen"](#)



### **5.10.1 Maintaining Accounting Journal for Broker**

Brokers receive commission payments out of some of the transactions in every fund for which they are designated intermediaries.

With regard to commission earnings, brokers could request for:

- Advance payments
- Ad-hoc payments

Oracle FLEXCUBE Investor Servicing enables the AMC to keep track of the processing and actual payment of commission earnings for brokers, by providing an accounting 'journal' facility, which would record each payment made.

Using this journal, you can:

- Make an accounting entry for each payment made to a broker for earnings from a specific transaction in a fund
- Maintain the payables and receivables for a broker for earnings from a fund
- Adjust the effect of advance payments or ad-hoc payments made to a broker, on any future payments
- The journal for a broker is therefore a single repository for all commission payments received by the broker.

### **5.10.2 Invoking Broker Journal Detail Screen**

To maintain a journal of accounting entries for payments to a broker, use the 'Broker Journal Detail' screen. You can invoke this screen by typing 'UTDBRKJR' in the field at the top right corner of the Application tool bar and clicking on the adjoining arrow button.

In the screen, specify the following mandatory information for each accounting entry for a broker, for a transaction in a fund:

- The date of the entry, in the Entry Date field
- A unique reference number for the journal entry, in the Reference Number field.
- The currency for the journal entry, in the Journal Currency field.
- The payables or receivables resulting from the transaction, in the Payables and Receivables fields.
- Whether the entry is to be deemed an adjustment entry, as indicated in the Adjustment Entry field.
- Any applicable descriptive or narrative text qualifying the entry, in the Remarks field.
- The details of the mode of payment, in the Payment Details section.

After you have specified this data, save your changes by clicking the Save button at the end of the screen.

You must have another user to authorize a journal entry for the same to be reflected in the database.

Select 'New' from the Actions menu in the Application tool bar or click new icon to enter the details of the Broker Journal screen.

The following fields are available in the Broker Journal Detail screen for data entry:

### Journal Txn Number

#### *Display*

System displays the automatically generated Journal Txn Number here.

### Entry Date

#### *Date Format; Mandatory*

Specify the date on which the respective accounting entry was made in this journal. This date cannot be a future date.

---

### Note

System computes the VAT amount for the commission only if the broker journal entry date is on or after the broker VAT registration date.

---

**Reference Number**

*Alphanumeric; 16 Characters; Mandatory*

Specify a unique alphanumeric identifier for the journal entry. You will use this reference number to track this entry subsequently.

**Journal Type**

*Alphanumeric; 1 Character; Mandatory*

Select the Journal type from the adjoining drop-down list.

This list displays the following values:

General Journal (G): If you select General Journal, the broker code and the journal remarks are mandatory.

Client-Specific Journal (C): If you select Client-Specific Journal, the broker code, UHID and remarks are mandatory.

Transaction-Specific Journal (T): If you select Transaction-Specific Journal, broker code, transaction number, UHID and remarks are mandatory.

The system defaults Fund ID and Unit Holder ID on the selection of transaction number.

**Broker**

*Alphanumeric; 9 Characters; Mandatory*

Select the code of the broker for whom the accounting entry is being recorded in the journal.

**Broker Name**

*Display*

The broker name will be displayed.

**Product ID**

*Alphanumeric; 10 Characters; Optional*

Select the product ID from the option list.

**Product Name**

*Display*

The system displays the name of the product for the selected product ID.

**Fund ID**

*Alphanumeric; 6 Characters; Mandatory*

Select the fund ID in which the commission was earned by the broker, resulting in this journal entry.

The list contains all funds in which the broker has transacted and received commission, in the AMC. When you specify the fund, the ISIN Code of the fund is displayed in the ISIN Code field.

**Fund Name Short**

*Display*

The system displays the short name of the fund.

**ISIN Code**

*Alphanumeric; 25 Characters; Mandatory*

Select the ISIN Code of the selected fund. If you specify the ISIN Code of a fund, the fund is displayed in the Fund field.

**Transaction Number**

*Numeric; 16 Characters; Optional*

Select the Transaction Number from the adjoining option list.

---

**Note**

If the transaction number is given then system validates whether the transaction number belongs to the corresponding broker or not, while saving.

---

**Unit Holder ID**

*Alphanumeric; 12 Characters; Optional*

The system populates the Unit Holder ID from the transaction number selected.

You can also query unit holder ID by clicking 'Find UH' button.

**Unit Holder Name**

*Display*

The system defaults the Unit Holder Name as per the Unit Holder ID.

**Journal Currency**

*Alphanumeric; 3 Characters; Mandatory*

Select the currency for the journal entry. The base currency for the fund is displayed here, but you can choose a different currency.

**Payables**

*Alphanumeric; 18 Characters; Optional*

Specify the amount that the broker must pay to the AMC, if any, as a result of the transaction.

**Receivables**

*Alphanumeric; 18 Characters; Optional*

Specify the commission amount that the broker must receive from the AMC, if any, as a result of the transaction.

**Adjustment Entry**

*Mandatory*

Select the appropriate Adjustment Entry from the adjoining drop-down list to indicate that the payable or receivable amount specified for this journal entry must be adjusted or offset in the next commission payment cycle for the next transaction, for the selected broker.

If you select the option 'VAT Only', then the amount entered against Payables and Receivables is considered as VAT amount payable and receivable.

If the Adjustment entry is selected as VAT only, then the system will make changes only to the VAT amount.

**Remarks**

*Alphanumeric; 255 Characters; Mandatory*

Specify any narrative or descriptive text qualifying the journal entry. This information is mandatory.

**Currency Name**

*Display*

The system displays the name of the currency for the selected journal currency.

## **Payment Details**

In this section, specify the details of the mode in which the payables or receivables amount has to be paid out or received by the broker.

### **Payment Mode**

*Optional*

Select the mode in which the payment was made or received, either through check or by account transfer.

### **Bank**

*Alphanumeric; 12 Characters; Mandatory*

Select the code of the bank, in which the transfer account resides, which was used to make the payment.

### **Check Number**

*Alphanumeric; 12 Characters; Mandatory for check payments*

Specify the number of the check.

### **Account Currency**

*Alphanumeric; 3 Characters; Optional*

Select the currency of the transfer account, which was used to make the payment.

### **Account Number**

*Alphanumeric; 20 Characters; Optional*

Specify the number of the transfer account that was used to make the payment.

### **IBAN**

*Alphanumeric; 40 Characters; Optional*

Specify the IBAN (International Bank Account Number) of the account holder.

### **Branch**

*Alphanumeric; 12 Characters; Optional*

Select the code of the bank, in which the transfer account resides, which was used to make the payment.

### **Cheque Date**

*Date Format; Optional*

Specify the date on which the check was drawn.

### **Account Type**

*Alphanumeric; 1 Character; Optional*

Select the type of the transfer account, which was used to make the payment.

### **Maintained Bank Accounts**

*Alphanumeric; 35 Characters; Optional*

Select the maintained bank accounts from the option list.

## **5.11 Broker Journal Summary Screen**

This section contains the following topics:

- [Section 5.11.1, "Retrieving Journal Entry in Broker Journal Summary Screen"](#)
- [Section 5.11.2, "Editing Journal Entry "](#)

- [Section 5.11.3, "Viewing Journal Entry"](#)
- [Section 5.11.4, "Deleting Journal Entry "](#)
- [Section 5.11.5, "Authorizing Journal Entry"](#)

### 5.11.1 **Retrieving Journal Entry in Broker Journal Summary Screen**

After you have made an accounting entry in a broker journal, you can:

- Make changes to the entry before you authorize it. You can also delete the entry, if deemed necessary.
- Have another user authorize it. Adjustments to the next payment cycle, if any, sought as specified in the entry, can only be effected after it is authorized.

To perform any of these operations, use the 'Broker Journal Summary' screen. You can invoke this screen by typing 'UTSBRKJR' in the field at the top right corner of the Application tool bar and clicking on the adjoining arrow button.

You can retrieve a previously entered record in the Broker Journal Summary screen, as follows:

- Specify any or all of the following details in the Broker Journal Summary screen:
- The status of the transaction in the Authorization Status field. If you choose the 'Blank Space' option, then all the records that involve the specified unit holder are retrieved.
- The status of the record in the Open field. If you choose the 'Blank Space' option, then all the records that involve the specified unit holder are retrieved.
- The Journal Txn Number
- The Reference Number
- The Fund ID
- The Broker

- The Entry Date
- The Receivables
- The Product ID

Click 'Search' button to view the records. All records with the specified details are retrieved and displayed in the lower portion of the screen.

You can also retrieve the individual record detail from the detail screen by doing query in the following manner:

- Press F7
- Input the Journal Txn Number
- Press F8

You can perform Edit, Delete, Amend, Authorize, Reverse, Confirm operation by selecting from the Action list.

You can also search the record by using combination of % and alphanumeric value.

### **Example**

You can search the record for Journal Txn Number by using the combination of % and alphanumeric value as follows:

- Search by A%: System will fetch all the records whose Journal Txn Number starts from Alphabet 'A'. For Example: AGC17, AGVO6, AGC74 and so forth.
- Search by %7: System will fetch all the records whose Journal Txn Number ends by numeric value '7'. For Example: AGC17, GSD267, AGC77 and so forth.
- Search by %17%: System will fetch all the records whose Journal Txn Number contains the numeric value 17. For Example: GSD217, GSD172, AGC17 and so forth.

## **5.11.2 Editing Journal Entry**

You can modify the details of Broker Journal parameters that you have already entered into the system, provided it has not been subsequently authorized. You can perform this operation as follows:

- Invoke the Broker Journal Summary screen from the Browser.
- Select the status of the record that you want to retrieve for modification in the Authorized field. You can only modify records that are unauthorized. Accordingly, choose the Unauthorized option.
- Specify any or all of the details in the corresponding fields to retrieve the record that is to be modified. All unauthorized records with the specified details are retrieved and displayed in the lower portion of the screen.
- Double click the record that you want to modify in the list of displayed records. The Broker Journal Detail screen is displayed.
- Select Unlock Operation from Action list to modify the record. Modify the necessary information.
- Click Save to save your changes. The Broker Journal Detail screen is closed and the changes made are reflected in the Broker Journal Summary screen.

## **5.11.3 Viewing Journal Entry**

To view a record that you have previously entered, you must retrieve the same in the Broker Journal Summary screen, as follows:

- Invoke the Broker Journal Summary Screen from the Browser.
- Select the status of the record that you want to retrieve for viewing in the Authorized field. You can also view all records that are either unauthorized or authorized only, by choosing the Unauthorized/ Authorized option.
- Specify any or all of the details of the record in the corresponding fields on the screen, and click 'Search' button. All records with the specified details are retrieved and displayed in the lower portion of the screen.
- Double click the record that you want to view in the list of displayed records. The Broker Journal Detail screen is displayed in View mode.

#### **5.11.4 Deleting Journal Entry**

You can delete only unauthorized records in the system. To delete a record that you have previously entered:

- Invoke the Broker Journal Summary screen from the Browser.
- Select the status of the record that you want to retrieve for deletion.
- Specify any or all of the details and click 'Search' button. All records with the specified details are retrieved and displayed in the lower portion of the screen.
- Double click the record that you want to delete. The Broker Journal Detail screen is displayed.
- Select Delete operation from the Action list. The system prompts you to confirm the deletion, and the record is deleted physically from the system database.

#### **5.11.5 Authorizing Journal Entry**

An unauthorized Broker Journal record must be authorized in the system for it to be processed. To authorize a record:

- Invoke the Broker Journal Summary screen from the Browser.
- Select the status of the record that you want to retrieve for authorization. Typically, choose the Unauthorized option.
- Specify any or all of the details of the record in the corresponding fields on the screen. Click 'Search' button. All record with the specified details that are pending authorization are retrieved and displayed in the lower portion of the screen.
- Double click the transaction that you wish to authorize. The Broker Journal Detail screen is displayed. Select Authorize operation from Action.

When the checker authorizes a record, details of validations, if any, that were overridden by the maker of the record during the Save operation, are displayed. If any of these overrides results in an error, the checker must reject the transaction.

When a journal entry for a broker is authorized, the process for any adjustments specified in the entry to the next payment cycle or transaction for the broker is begun in the database. Subsequently, you cannot change a journal entry that has been authorized, in any way. The amendment operation is not available on authorized journal entries for brokers.

## **5.12 Income Distribution Setup Screen**

This section contains the following topics:

- [Section 5.12.1, "Setting Up Income Distribution Options for Brokers"](#)
- [Section 5.12.2, "Invoking Income Distribution Setup Screen"](#)



## 5.12.1 Setting Up Income Distribution Options for Brokers

An intermediary (such as a broker) derives commission earnings from the transactions in the funds of the AMC.

Brokers could wish to choose the manner in which they could use their commission earnings. They could:

- Receive the entire earnings, dividend or commission, as payment, either entirely through checks or account transfer, or a combination of both.
- Not receive the earnings by way of payment, but invest the earnings back into the funds of the AMC. This is known as reinvestment. Also, the reinvestment could be made into a designated unit holder account too.
- Receive a portion of the earnings by way of payment, and reinvest the remaining portion.

The pattern chosen by the broker to use commission earnings is known as the Income Distribution Setup pattern or the IDS pattern for the broker.

You can capture this pattern for any broker in the Oracle FLEXCUBE Investor Servicing system.

## 5.12.2 Invoking Income Distribution Setup Screen

Use the Income Distribution Setup Detail screen to set up the income distribution pattern for a broker. You can invoke this screen by typing 'UTDUHIDS' in the field at the top right corner of the Application tool bar and clicking on the adjoining arrow button.

In this screen, you set up the IDS pattern by:

- Specifying the broker for whom the pattern is being setup, in the Broker Code field.
- Specifying the mode of distribution, in the Distribution Mode field.
- Specifying the percentages that represent the portions of dividend earnings to be paid and reinvested, as desired by the broker, in the Payment Percentage and Reinvestment Percentage fields.
- Specifying the payment details for the paid portion, in the Payment Details section, and the reinvestment details, for the reinvestment portion, in the Reinvestment Details section.

- Saving your changes.

Select 'New' from the Actions menu in the Application tool bar or click new icon to enter the details of the 'Income Distribution Setup' screen.

*For further details on this screen, please refer 'Income Distribution Setup Screen' section in this User Manual*

## 5.13 Raise Broker Commission Screen

This section contains the following topics:

- [Section 5.13.1, "Invoking Raise Broker Commission"](#)
- [Section 5.13.2, "Calculating VAT Amount"](#)

### 5.13.1 Invoking Raise Broker Commission

You can raise broker commission using the 'Raise Broker Commission' screen. You can invoke this screen by typing 'UTDBRAIS' in the field at the top right corner of the Application tool bar and clicking on the adjoining arrow button.

The screenshot shows the 'Raise Broker Commission' application window. At the top, there is a 'Save' button. Below it, the main form contains several fields: 'To Date\*' (mandatory, date format MMDD/YYYY), 'Last Raise Date' (date format MMDD/YYYY), and 'Broker Type'. There are 'Process' and 'Submit' buttons. Below the form are two tables: 'AMC List' and 'Fund List'. The 'AMC List' table has columns 'AMC ID' and 'AMC Name'. The 'Fund List' table has columns 'Fund ID' and 'Fund Name'. Both tables show '1 of 1' records. A 'Cancel' button is located at the bottom right of the window.

#### To Date

*Date Format; Mandatory*

Specify the date until which you wish to raise the broker commission. This field is mandatory.

If you raise broker commission on current application date, the system will consider all the transactions allotted till the previous day. 'To date' should be less than or equal to the previous working date.

#### Last Raise Date

*Date Format; Optional*

Select the last raise date when the raise was made from the adjoining calendar.

#### Broker Type

*Alphanumeric; 6 Characters; Optional*

Specify the broker type for which the commission should be raised.

## **AMC List**

### **AMC ID**

*Alphanumeric; 6 Characters; Optional*

Specify the id of the AMC. The adjoining option list displays all valid AMC ids maintained in the system. You can select the appropriate one.

### **AMC Name**

*Alphanumeric; 10 characters; Optional*

When you select the AMC ID, the AMC name automatically gets populated. However, you are allowed to edit the same.

## **Fund List**

### **Fund ID**

*Alphanumeric; 6 characters; Optional*

Specify the fund id. The adjoining option list displays all valid fund ids maintained in the system. You can select the appropriate one.

### **Fund Name**

*Display*

When you select the fund id ,the fund name automatically gets populated.

The system logs the VAT amount details along with commission details.

The raising of commission is independent of the payment of commission, and the raise of commission and the payment of commission need not occur on the same day. The commission table shows the converted amount if the broker source currency is different from that of the preferred currency.

For raise broker commission, previous system date cannot be a holiday.

## **5.13.2 Calculating VAT Amount**

The system computes the VAT amount for periodic load accrual using the following formula:

(Load Amount \* VAT%)

The system computes the VAT for transaction load using the following formula:

(Load Amount \* VAT%)

The VAT will be calculated only if the VAT registered date is less than the transaction date.

The criteria based load setup should be done to achieve the VAT calculation based on the VAT registered date. The criteria based load set up should be done as below:

<b>LOAD ID</b>	<b>LOAD DESCRIPTION</b>	<b>CRITERIA</b>
203	Initial Broker Fee - Rands(Vat)	WHERE TransactionDetails.TRANSACTION-MODE = 'A' AND TransactionDetails.BROKER-CODE <> 'DIRECT' AND TransactionDetails.VATREGISTERED = '1'

LOAD ID	LOAD DESCRIPTION	CRITERIA
204	Initial Broker Fee - Rands(Non Vat)	WHERE TransactionDetails.TRANSACTION-MODE = 'A' AND TransactionDetails.BROKER-CODE <> 'DIRECT' AND TransactionDetails.VATREGISTERED = '0'
205	Initial Broker Fee - Units(Vat)	WHERE TransactionDetails.TRANSACTION-MODE = 'U' AND TransactionDetails.BROKER-CODE <> 'DIRECT' AND TransactionDetails.VATREGISTERED = '1'
206	Initial Broker Fee - Units(Non Vat)	WHERE TransactionDetails.TRANSACTION-MODE = 'U' AND TransactionDetails.BROKER-CODE <> 'DIRECT' AND TransactionDetails.VATREGISTERED = '0'

## 5.14 FCIS Broker Authorization

This section contains the following topics:

- [Section 5.14.1, "Invoking FCIS Broker Authorization Screen"](#)

### 5.14.1 Invoking FCIS Broker Authorization Screen

You can invoke 'FCIS Broker Authorization' screen by typing 'UTDBRKAU' in the field at the top right corner of the Application tool bar and clicking on the adjoining arrow button.

You can specify the following details:

#### Broker Code

*Alphanumeric; 12 Characters; Mandatory*

Specify broker code.

#### Rule Effective Date

*Date Format; Mandatory*

Select the rule effective date from the adjoining calendar.

After specifying broker code and rule effective date, click 'Execute Query' button. The system displays the following details:

**Broker Name**

*Display*

The system displays the broker name of the specified broker code.

**Parent Broker Code**

*Display*

The system displays the parent broker code of the specified broker code.

**Broker Base Currency**

*Display*

The system displays the broker base currency code.

**AMC ID**

*Display*

The system displays the AMC ID.

After specifying the necessary details click 'Authorize' button to authorise the broker details. Click 'View Changes' button to view the changes. You can also invoke 'View Changes' screen by typing 'UTD VWCHG' in the field at the top right corner of the Application tool bar and clicking on the adjoining arrow button.

## **5.15 Commission Payment Status Change Screen**

This section contains the following topics:

- [Section 5.15.1, "Invoking Commission Payment Status Change Screen"](#)
- [Section 5.15.2, "Search Results Tab"](#)
- [Section 5.15.3, "Exchange Rate Source Tab"](#)
- [Section 5.15.4, "Exchange Rate Maintenance Tab"](#)

### **5.15.1 Invoking Commission Payment Status Change Screen**

You can change the commission payment status using the 'Commission Payment Status Change' screen. This means that you can hold the commission payment for which the

commission is raised. You can invoke this screen by typing 'UTDCHPAY' in the field at the top right corner of the Application tool bar and clicking on the adjoining arrow button.

### Reference Number

#### *Display*

The system displays the reference number.

### Fund ID

*Alphanumeric; 12 Characters; Mandatory*

Specify the fund ID.

### Transaction Number

*Alphanumeric; 16 Characters; Optional*

Specify the transaction number.

### From Entity ID

*Alphanumeric; 12 characters; Optional*

Specify the entity from whom the commission is charged.

### To Entity ID

*Alphanumeric; 15 characters; Optional*

Specifies the entity for whom the commission is charged. This field is mandatory.

### Policy Number

*Alphanumeric; 10 characters; Optional*

Specify the policy number. The adjoining option list displays valid policy numbers maintained in the system. You can choose the appropriate one.

**Current Payment Status**

*Alphanumeric; 15 Characters; Optional*

Select the current payment status from the adjoining option list.

**Select All**

*Optional*

Select if all the records has to be selected or not from the drop-down list. The list displays the following values:

- Yes
- No

Click on 'Show Details' button to show all the records with the specified values.

**New Payment Status**

*Alphanumeric; 15 Characters; Optional*

Specify the new payment status for the commission record. This determines the eligibility for the payment of commission.

All commission records that have a Payment Status = 'P' will be eligible for Commission Payment. 'P' means payable.

All commission records that have a Payment Status = 'S' will not be eligible for the next commission payment run. After the next commission payment processing, system will update the commission records with Payment Status as 'S' to 'P' (Payable) status. 'S' means Single Payment Hold Back.

All commission records that have a Payment Status = 'I' will not be eligible for a commission payment run. 'I' means indefinite hold back.

System will not automatically update the commission records with payment status as 'I' to 'P'. This should be done manually.

You can select a record and change the Exchange Rate Source or Exchange Rate or New payment status and click on 'Process' button to update the commission record with new payment status, new exchange rate source applied, new exchange rate applied.



## 5.15.2 Search Results Tab

Click 'Search Results' tab to view the records for which broker commission is raised. However, you can override the details in this section.

Commission Payment Status Change

Save

Reference Number\*  Transaction Number

Fund ID\*  Policy Number

From Entity ID  Current Payment Status

To Entity ID  Select All Yes

Show Details

New Payment Status

Search Results Exchange Rate Source Exchange Rate Maintenance

Detail

1 of 1 Go

Fund ID	Load ID	From Entity	To Entity	Transaction Amount	Load Amount	Commission Currency
---------	---------	-------------	-----------	--------------------	-------------	---------------------

Input by  DateTime  Mod No  Open

Authorized by  DateTime  Authorized

Cancel

You can view the following fields:

- Fund ID
- Load ID
- From Entity
- To Entity
- Transaction Amount
- Load Amount
- Commission Currency
- Load amount in fee currency
- Commission amount in payment currency
- Commission Payment Amount
- VAT Amount
- VAT Amount in Pay CCY
- FX Source
- F X Rate
- Payment Status
- Select

### 5.15.3 Exchange Rate Source Tab

Click 'Exchange Rate Source' tab to map the exchange rate source and currency details.

Commission Payment Status Change

Save

Reference Number\*  Transaction Number

Fund ID\*  Policy Number

From Entity ID  Current Payment Status

To Entity ID  Select All

New Payment Status

Search Results **Exchange Rate Source** Exchange Rate Maintenance

Commission CCY to Exchange Rate Source Mapping

<input checked="" type="checkbox"/>	Commission Currency	Currency Name	New Exchange Rate Source
<input checked="" type="checkbox"/>	<input type="text"/>	<input type="text"/>	<input type="text"/>

Input by  DateTime  Mod No  Open

Authorized by  DateTime  Authorized

Specify the following details:

#### **Commission Currency**

*Alphanumeric; 3 Characters; Optional*

Specify the currency in which the commission is paid.

#### **Currency Name**

*Display*

The system display the name of the currency.

#### **New Exchange Rate Source**

*Alphanumeric; 6 Characters; Optional*

Select the exchange rate source from which the exchange rates are to be derived for the transaction.

For example, If the default source currency is USD and you are required to convert commission from GBP to EUR, then the system first converts from GBP to USD and then from USD to EUR.

## 5.15.4 Exchange Rate Maintenance Tab

Click 'Exchange Rate Maintenance' tab to maintain the exchange rate.

Commission Payment Status Change

Save

Reference Number \*  
Fund ID \*  
From Entity ID  
To Entity ID  
Transaction Number  
Policy Number  
Current Payment Status  
Select All Yes

Show Details

New Payment Status

Search Results | Exchange Rate Source | Exchange Rate Maintenance

Overriding Exchange Rate Details

Source Currency	Payment Currency	Exchange Rate Source	New Exchange Rate
<input checked="" type="checkbox"/>	<input type="checkbox"/>	<input type="checkbox"/>	<input type="checkbox"/>

Input by  
Authorized by  
DateTime  
Mod No  
Open Authorized  
Cancel

Specify the following fields:

### Source Currency

*Alphanumeric; 3 Characters; Optional*

The system displays the source currency, however, you can specify the currency in which the commission is paid from the adjoining option list.

### Payment Currency

*Alphanumeric; 3 Characters; Optional*

Specify the currency in which the commission is paid.

### Exchange Rate Source

*Alphanumeric; 6 characters; Optional*

Specify the exchange rate source from which the exchange rates are to be derived for the transaction.

### New Exchange Rate

*Alphanumeric; 15 Characters; Optional*

Specify the latest exchange rate maintained for an exchange rate source.

---

### Note

Payment status change of a record is also reflected in the Payment Enrichment screen.

---

# 5.16 Commission Payment Status Change Summary

This section contains the following topic:

- [Section 5.16.1, "Retrieving Commission Payment Status Change Summary Screen"](#)
- [Section 5.16.2, "Editing Commission Payment Status Change Record"](#)
- [Section 5.16.3, "Viewing Commission Payment Status Change Record"](#)
- [Section 5.16.4, "Deleting Commission Payment Status Change Record"](#)
- [Section 5.16.5, "Authorizing Commission Payment Status Change Record"](#)
- [Section 5.16.6, "Amending Commission Payment Status Change Record"](#)
- [Section 5.16.7, "Authorizing Amended Commission Payment Status Change Record"](#)

## 5.16.1 Retrieving Commission Payment Status Change Summary Screen

You can retrieve a previously entered record in the Summary Screen, as follows:

Invoke the 'Commission Payment Status Change Summary' screen by typing 'UTSCHPAY' in the field at the top right corner of the Application tool bar and clicking on the adjoining arrow button and specify any or all of the following details in the corresponding details.

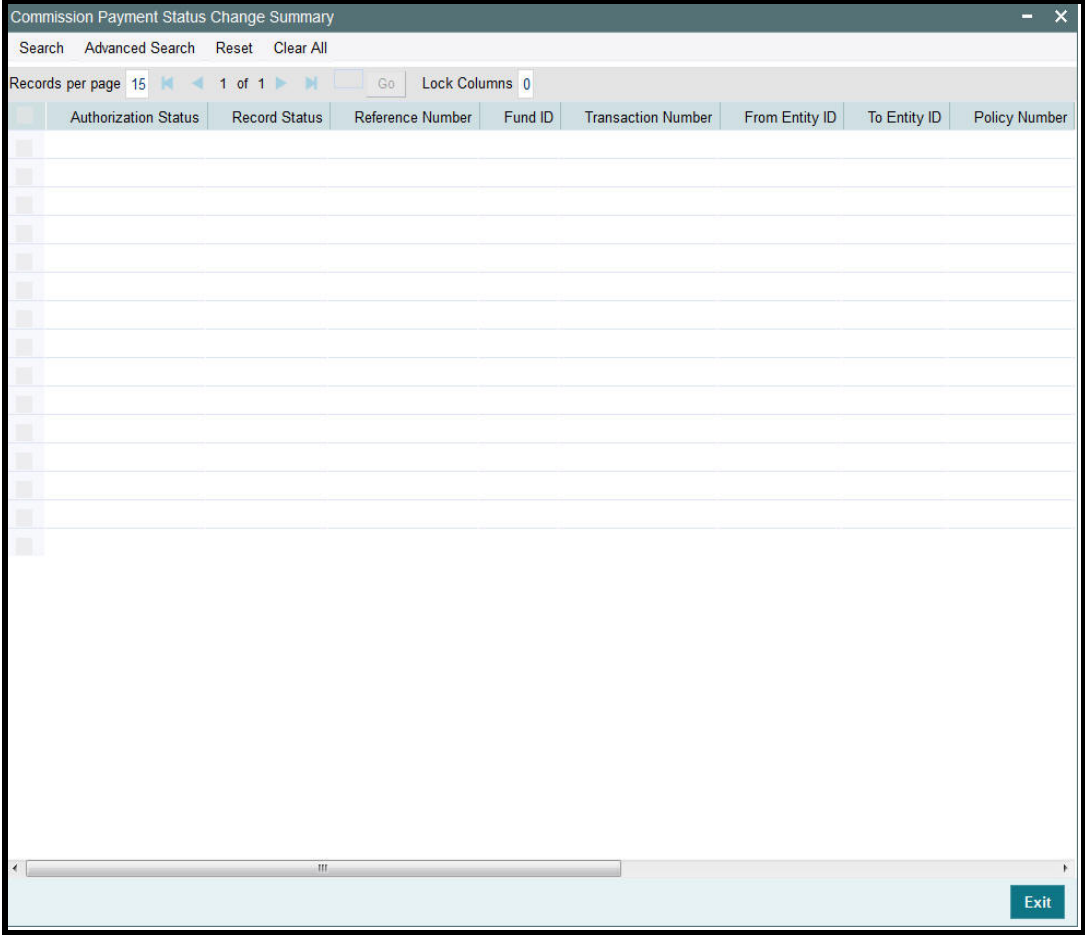

Click 'Search' button to view the records. All the records with the specified details are retrieved and displayed in the lower portion of the screen.

You can perform Edit, Delete, Amend, Authorize, operations by selecting the operation from the Action list. You can also search a record by using a combination of % and alphanumeric value.

### **5.16.2 Editing Commission Payment Status Change Record**

You can modify the details of Commission Payment Status Change record that you have already entered into the system, provided it has not subsequently authorized. You can perform this operation as follows:

- Invoke the 'Commission Payment Status Change Summary' screen from the Browser.
- Click 'Search' button. All unauthorized records with the specified details are retrieved and displayed in the lower portion of the screen.
- Double click the record that you want to modify in the list of displayed records. The Commission Payment Status Change Detail screen is displayed.
- Select Unlock Operation from the Action list to modify the record. Modify the necessary information.

Click Save to save your changes. The Commission Payment Status Change Detail screen is closed and the changes made are reflected in the Commission Payment Status Change Summary screen.

### **5.16.3 Viewing Commission Payment Status Change Record**

To view a record that you have previously input, you must retrieve the same in the Commission Payment Status Change Summary screen as follows:

- Invoke the Commission Payment Status Change Summary screen from the Browser.
- Click 'Search' button. All records with the specified fields are retrieved and displayed in the lower portion of the screen.
- Double click the record that you want to view in the list of displayed records. The KYC Chasing Detail screen is displayed in View mode.

### **5.16.4 Deleting Commission Payment Status Change Record**

You can delete only unauthorized records in the system. To delete a record that you have previously entered:

- Invoke the Commission Payment Status Change Summary screen from the Browser.
- Click 'Search' button. All records with the specified fields are retrieved and displayed in the lower portion of the screen.
- Double click the record that you want to delete in the list of displayed records. The Commission Payment Status Change Detail screen is displayed.
- Select Delete Operation from the Action list. The system prompts you to confirm the deletion and the record is physically deleted from the system database.

### **5.16.5 Authorizing Commission Payment Status Change Record**

- An unauthorized Commission Payment Status Change record must be authorized in the system for it to be processed. To authorize a record:
- Invoke the Commission Payment Status Change Summary screen from the Browser.
- Click 'Search' button. All records with the specified details that are pending authorization are retrieved and displayed in the lower portion of the screen.
- Double click the record that you wish to authorize. The Commission Payment Status Change Detail screen is displayed. Select Authorize operation from the Action List.

When a checker authorizes a record, details of validation, if any, that were overridden by the maker of the record during the Save operation are displayed. If any of these overrides results in an error, the checker must reject the record.

### 5.16.6 Amending Commission Payment Status Change Record

After a Commission Payment Status Change record is authorized, it can be modified using the Unlock operation from the Action List. To make changes to a record after authorization:

- Invoke the Commission Payment Status Change Summary screen from the Browser.
- Click 'Search' button. All records with the specified details that are pending authorization are retrieved and displayed in the lower portion of the screen.
- Double click the record that you wish to authorize. The Commission Payment Status Change Detail screen is displayed in amendment mode. Select Unlock operation from the Action List to amend the record.
- Amend the necessary information and click on Save to save the changes

### 5.16.7 Authorizing Amended Commission Payment Status Change Record

An amended Commission Payment Status Change record must be authorized for the amendment to be made effective in the system. The authorization of amended records can be done only from Fund Manager Module and Agency Branch module.

The subsequent process of authorization is the same as that for normal transaction

## 5.17 Broker Commission Payment Screen

This section contains the following topic:

- [Section 5.17.1, "Invoking Broker Commission Payment Screen"](#)

### 5.17.1 Invoking Broker Commission Payment Screen

You can determine the date of commission payment for all commission transactions raised from a specific agency branch or across all agency branches using the 'Broker Comm Payment' screen. You can invoke this screen by typing 'UTDBRCOP' in the field at the top right corner of the Application tool bar and clicking on the adjoining arrow button.

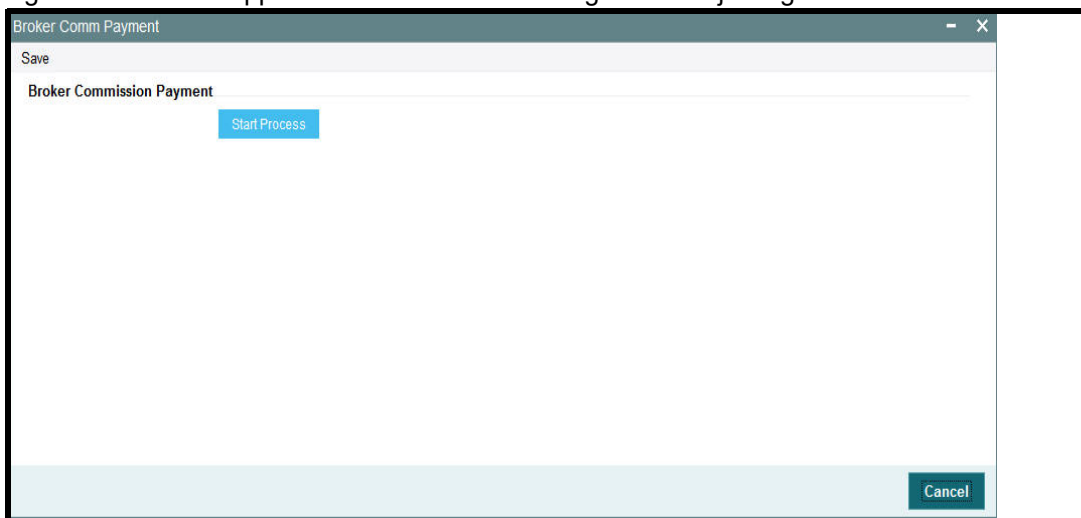

## **Broker Commission Payment**

Click the 'Start Process' button to process the commission payment.

---

### **Note**

If the amount in payment currency for the broker is greater than the minimum payment amount for Payment Currency, then all of those commission should be paid. You can make the payment at any time.

---

## **5.18 Minimum Commission Payment Amount Maintenance Screen**

This section contains the following topic:

- [Section 5.18.1, "Invoking Minimum Commission Payment Amount Maintenance"](#)

### **5.18.1 Invoking Minimum Commission Payment Amount Maintenance**

In this section specify the details to maintain a minimum payment amount for each commission payment currency. You can invoke this screen by typing 'UTDMINPY' in the field at the top right corner of the Application tool bar and clicking on the adjoining arrow button. The FCIS Min Comm Payment Amt Maintenance Detail screen is displayed:

The screenshot shows a software interface window titled "FCIS Min Comm Payment Amt Maintenance Detail". At the top left is a "Save" button. Below it is a text field labeled "Effective Date \*" with a date picker icon. A section titled "Detail" contains a table with two columns: "Payment Currency \*" and "Minimum Payment Amount \*". The table has one row with a search icon in the first column. At the bottom, there are fields for "Input by", "Authorized by", "DateTime", "Mod No", "Open", and "Authorized", along with a "Cancel" button.

### **Effective Date**

*Date Format; Mandatory*

Specify the date from which the commission payment should be effective in the system.

### **Details**

#### **Payment currency**

*Alphanumeric; 3 Characters; Mandatory*

Select appropriate currency from the adjoining option list.

## Minimum Payment Amount

*Alphanumeric; 25 Characters; Mandatory*

Specify the minimum payment amount for each commission payment amount.

---

### Note

You can maintain a new record, copy, unlock, delete, authorize and re-open a record in this screen.

---

### **Example**

The system validates the minimum payment amount specified for each payment currencies during payment processing.

If minimum payment amount is not maintained then the system considers the minimum amount as zero.

Assume that in minimum commission Payment Amount Maintenance screen the payment currency and minimum payment amount is maintained as follows:

Currency	Minimum Payment Amount
ZAR	150
USD	100
GBP	0

Then the system will make the broker commission payment as follows:

- If the Commission payment currency is ZAR, then system transfers the money to the broker if the commission amount is greater than or equal to 150 ZAR.
- If the Commission payment currency is USD, then system transfers the money to the broker if the commission amount is greater than or equal to 100 USD.
- If the Commission payment currency is GBP, then system transfers the money to the broker if the commission amount is greater than zero.
- If the minimum payment amount is not maintained for any of the currency then system will pay the broker if the commission amount is greater than zero.

System uses the default exchange rate for conversion.

## **5.19 Minimum Commission Payment Amount Maintenance Summary Screen**

This section contains the following topics:

- [Section 5.19.1, "Retrieving Minimum Commission Payment Amount Maintenance Summary"](#)
- [Section 5.19.2, "Editing Minimum Commission Payment Amount"](#)
- [Section 5.19.3, "Viewing Minimum Commission Payment Amount "](#)
- [Section 5.19.4, "Deleting Minimum Commission Payment Amount "](#)
- [Section 5.19.5, "Authorizing Minimum Commission Payment Amount "](#)
- [Section 5.19.6, "Amending Minimum Commission Payment Amount "](#)
- [Section 5.19.7, "Authorizing Amended Minimum Commission Payment Amount "](#)



## 5.19.1 Retrieving Minimum Commission Payment Amount Maintenance Summary

You can invoke the FCIS Broker Currency Preference Summary screen by typing 'UTSMINPY' in the field at the top right corner of the Application tool bar and clicking on the adjoining arrow button.

The screenshot shows a web application window titled "FCIS Min Comm Payment Amt Maintenance Summary". At the top, there is a search bar with options for "Search", "Advanced Search", "Reset", and "Clear All". Below the search bar, there are several input fields: "Authorized" (a dropdown menu), "Open" (a dropdown menu), and "Effective Date" (a date field with a calendar icon). Below these fields, there is a table with columns for "Authorized", "Open", and "Effective Date". The table is currently empty. At the bottom right of the window, there is an "Exit" button.

You can retrieve a previously entered record in the Minimum Commission Payment Amount Maintenance Summary screen, as follows:

- Specify any or all of the following details in the Minimum Commission Payment Amount Maintenance Summary screen:
- The status of the transaction in the Authorized field.
- The status of the record in the Open field. If you choose the 'Blank Space' option, then all the records that involve the specified Minimum Commission Payment Amount are retrieved.
- Effective Date

Click 'Search' button to view the records. All records with the specified details are retrieved and displayed in the lower portion of the screen.

---

### Note

You can also retrieve the individual record detail from the detail screen by doing query in the following manner:

- Press F7

- Input the Effective Date
  - Press F8
- 

You can perform Edit, Delete, Amend, Authorize, Reverse, Confirm operation by selecting from the Action list.

You can also search the record by using combination of % and alphanumeric value.

### **5.19.2 Editing Minimum Commission Payment Amount**

You can modify the details of Minimum Commission Payment Amount Maintenance parameters that you have already entered into the system, provided it has not been subsequently authorized. You can perform this operation as follows:

- Invoke the Minimum Commission Payment Amount Maintenance Summary screen from the Browser.
- Select the status of the record that you want to retrieve for modification in the Authorization Status field. You can only modify records that are unauthorized. Accordingly, choose the Unauthorized option.
- Specify any or all of the details in the corresponding fields to retrieve the record that is to be modified. All unauthorized records with the specified details are retrieved and displayed in the lower portion of the screen.
- Double click the record that you want to modify in the list of displayed records. The Minimum Commission Payment Amount Maintenance screen is displayed.
- Select Unlock Operation from Action list to modify the record. Modify the necessary information.
- Click Save to save your changes. The Minimum Commission Payment Amount Maintenance screen is closed and the changes made are reflected in the Minimum Commission Payment Amount Maintenance Summary screen.

### **5.19.3 Viewing Minimum Commission Payment Amount**

To view a record that you have previously entered, you must retrieve the same in the Broker Currency Preference Summary screen, as follows:

- Invoke the Minimum Commission Payment Amount Maintenance Summary Screen from the Browser.
- Select the status of the record that you want to retrieve for viewing in the Authorization Status field. You can also view all records that are either unauthorized or authorized only, by choosing the Unauthorized/ Authorized option.
- Specify any or all of the details of the record in the corresponding fields on the screen, and click 'Search' button. All records with the specified details are retrieved and displayed in the lower portion of the screen.
- Double click the record that you want to view in the list of displayed records. The Minimum Commission Payment Amount Maintenance screen is displayed in View mode.

### **5.19.4 Deleting Minimum Commission Payment Amount**

You can delete only unauthorized records in the system. To delete a record that you have previously entered:

- Invoke the Minimum Commission Payment Amount Maintenance Summary screen from the Browser.
- Select the status of the record that you want to retrieve for deletion.

- Specify any or all of the details and click 'Search' button. All records with the specified details are retrieved and displayed in the lower portion of the screen.
- Double click the record that you want to delete. The Minimum Commission Payment Amount Maintenance screen is displayed.
- Select Delete operation from the Action list. The system prompts you to confirm the deletion, and the record is deleted physically from the system database.

### **5.19.5 Authorizing Minimum Commission Payment Amount**

An unauthorized Minimum Commission Payment Amount Maintenance record must be authorized in the system for it to be processed. To authorize a record:

- Invoke the Minimum Commission Payment Amount Maintenance Summary screen from the Browser.
- Select the status of the record that you want to retrieve for authorization. Typically, choose the unauthorized option.
- Specify any or all of the details of the record in the corresponding fields on the screen. Click 'Search' button. All record with the specified details that are pending authorization are retrieved and displayed in the lower portion of the screen.
- Double click the transaction that you wish to authorize. The Minimum Commission Payment Amount Maintenance screen is displayed. Select Authorize operation from Action.

When the checker authorizes a record, details of validations, if any, that were overridden by the maker of the record during the Save operation, are displayed. If any of these overrides results in an error, the checker must reject the transaction.

### **5.19.6 Amending Minimum Commission Payment Amount**

After a Minimum Commission Payment Amount Maintenance record is authorized, it can be modified using the Unlock operation from Action list. To make changes to a record after authorization:

- Invoke Minimum Commission Payment Amount Maintenance Summary screen from the Browser.
- Select the status of the record that you wish to retrieve for amendment. You can only amend only authorized records.
- Specify any or all of the details of the Minimum Commission Payment Amount Maintenance in the screen. All records with the specified details are retrieved and displayed in the lower portion of the screen.
- Double click the record that you want to amend. The Minimum Commission Payment Amount Maintenance screen is displayed in Amendment mode. Click the Unlock operation from the Action list to amend the record.
- Amend the necessary information. Click the Save button to save the changes.

### **5.19.7 Authorizing Amended Minimum Commission Payment Amount**

An amended Minimum Commission Payment Amount Maintenance record must be authorized for the amendment to be made effective in the system. The authorization of amended records can only be done from Fund Manager Module and Agency branch Module. The process of authorization is subsequently the same as that for normal transactions.

## 5.20 Entity Commission Payment Inquiry Detail

This section contains the following topics:

- [Section 5.20.1, "Invoking Entity Commission Payment Inquiry Detail Screen"](#)
- [Section 5.20.2, "Payable Tab"](#)
- [Section 5.20.3, "Accrual Tab"](#)

### 5.20.1 Invoking Entity Commission Payment Inquiry Detail Screen

You can inquire entity commission payment using 'Entity Commission Payment Inquiry Detail' screen. You can invoke this screen by typing 'UTDENCMP' in the field at the top right corner of the Application tool bar.

Fund ID	Payment Number	Payment Indicator	Fund Base Currency	Gross Amount	Tax Deducted	Net Amount

You can specify the following details:

#### Entity Type

*Alphanumeric; 1 Character; Optional*

Specify the entity type. Alternatively, you can select entity type from the option list. The list displays all valid entity type maintained in the system.

#### Type of Information

*Mandatory*

Select the type of information from the drop-down list. The list displays the following values:

- Commission Paid
- Commission Accrued

**Entity ID**

*Alphanumeric; 12 Characters; Mandatory*

Specify the entity ID. Alternatively, you can select entity ID from the option list. The list displays all valid entity ID maintained in the system.

**Fund ID**

*Alphanumeric; 6 Characters; Mandatory*

Specify the fund ID. Alternatively, you can select fund ID from the option list. The list displays all valid fund ID maintained in the system.

**Payment Number**

*Numeric; 22 Characters; Optional*

Specify the payment number.

**Payment From Date**

*Date Format; Optional*

Select the date from when the entity commission payment has to be made from the adjoining calendar.

**Payment To Date**

*Date Format; Optional*

Select the date till when the entity commission payment has to be made from the adjoining calendar.

**Transaction Number**

*Alphanumeric; 16 Characters; Optional*

Specify the transaction number.

**Commission Type**

*Alphanumeric; 16 Characters; Optional*

Specify the type of commission. Alternatively, you can select commission type from the option list. The list displays all valid commission type maintained in the system.

**Accrual Date**

*Date Format; Optional*

Select the accrual date from the adjoining calendar.

## 5.20.2 Payable Tab

Click 'Accrual' tab in 'Entity Commission Payment Inquiry Detail' screen.

Entity Commission Payment Inquiry Detail

Save

Entity Type \*  Entity ID \*

Type of Information \* Commission Paid Fund ID \*

Payment Number  Transaction Number

Payment From Date  Commission Type

Payment To Date  Accrual Date

Find

Payable | Accrual

Commission Paid

Fund ID	Payment Number	Payment Indicator	Fund Base Currency	Gross Amount	Tax Deducted	Net Amount
---------	----------------	-------------------	--------------------	--------------	--------------	------------

Cancel

After specifying the necessary details, click 'Find' button. The system displays the following commission paid details:

- Fund ID
- Payment Number
- Payment Indicator
- Fund Base Currency
- Gross Amount
- Tax Deducted
- Net Amount
- Mode of Payment
- Instrument Amount
- Instrument Currency
- Payment Description
- View Details

### 5.20.3 Accrual Tab

Click 'Accrual' tab in 'Entity Commission Payment Inquiry Detail' screen.

Entity Commission Payment Inquiry Detail

Save

Entity Type \*  Entity ID \*

Type of Information \* Commission Paid Fund ID \*

Payment Number  Transaction Number

Payment From Date  Commission Type TC

Payment To Date  Accrual Date

Find

Payable **Accrual**

Commission Accrual

1 of 1 Go

Fund ID	Commission Amount	Commission Currency	Payment Description	View Details
---------	-------------------	---------------------	---------------------	--------------

Cancel

After specifying the necessary details, click 'Find' button. The system displays the following commission accrual details:

- Fund ID
- Commission Amount
- Commission Currency
- Payment Description
- View Details

### 5.21 FSA Registration Maintenance Detail

This section contains the following topics:

- [Section 5.21.1, "Invoking FSA Registration Maintenance Detail Screen"](#)

## 5.21.1 Invoking FSA Registration Maintenance Detail Screen

You can capture FSA registration number using 'FSA Registration Maintenance Detail' screen. You can invoke this screen by typing 'UTDFSA' in the field at the top right corner of the Application tool bar and clicking the adjoining arrow button.

The screenshot shows a software window titled "FSA Registration Maintenance Detail". The window contains a "Save" button at the top left. The main area has several input fields: "Entity Type \*" (with a dropdown arrow), "Entity ID \*" (with a dropdown arrow), "Entity Category Type" (with a dropdown menu showing "Individual"), "FSA Registration Number \*" (with a dropdown arrow), "FSA Registration Status \*" (with a dropdown arrow), "Entity Type Description", "Entity Name", "Hold Client Money" (with a "Yes" button), and "Status Description". At the bottom, there is a metadata section with fields for "Input by", "DateTime", "Mod No", "Record Status", "Authorized by", "DateTime", "Authorization Status", and "Status". There are "OK" and "Cancel" buttons on the right side of the bottom bar.

The system allows the open and closure of the FSA registration maintenance for an entity.

If you close a maintenance and then try to create a new record for that entity, then the system displays an error message stating that the maintenance already exists. You need to re-open the record to re-activate the same.

You can specify the following details:

### Entity Type

*Alphanumeric; 1 Character; Mandatory*

Specify the entity type. Alternatively, you can select entity type from the option list. The list displays all valid entity type maintained in the system.

### Entity Type Description

*Display*

The system displays the description for the selected Entity Type.

### Entity ID

*Alphanumeric; 12 Characters; Mandatory*

The system displays the entity ID based on the Entity Type selected. However, you can amend this field.

---

### Note

If Entity type selected is 'Broker', 'Account Officer', or 'IFA', then the system will not allow to maintain FSA registration for Direct entity.

---

### Entity Name

*Display*

The system displays the name of the selected Entity Name.



**Entity Category Type**

*Display*

The system display the entity category type.

**FSA Registration Number**

*Alphanumeric; 8 Characters; Mandatory*

Specify FSA registration number.

FSA Registration Number will be unique across all the entities (Broker/Entity). For Corporate entity, you can enter 7 characters and for Individual entity, you can enter 8 characters.

**Hold Client Money**

*Optional*

Select Hold client money status from the drop-down list. The list displays the following values:

- Yes
- No

**FSA Registration Status**

*Alphanumeric; 1 Character; Mandatory*

Specify FSA registration number. Alternatively, you can select FSA registration status from the option list. The list displays all valid FSA registration status maintained in the system.

**Status Description**

*Display*

The system displays the description for the selected FSA registration status.

## **5.22 FSA Registration Maintenance Summary**

This section contains the following topics:

- [Section 5.22.1, "Retrieving FSA Registration Maintenance Summary Record"](#)
- [Section 5.22.2, "Editing FSA Registration Maintenance Record"](#)
- [Section 5.22.3, "Viewing FSA Registration Maintenance Record"](#)
- [Section 5.22.4, "Deleting FSA Registration Maintenance Record"](#)
- [Section 5.22.5, "Authorizing FSA Registration Maintenance Records"](#)
- [Section 5.22.6, "Amending FSA Registration Maintenance Record"](#)
- [Section 5.22.7, "Authorizing Amended FSA Registration Maintenance Records"](#)

## 5.22.1 Retrieving FSA Registration Maintenance Summary Record

You can invoke 'FSA Registration Maintenance Summary' screen. You can invoke this screen by typing 'UTSFSA' in the field at the top right corner of the Application tool bar and clicking on the adjoining arrow button.

FSA Registration Maintenance Summary

Search Advanced Search Reset Clear All

Search Is Case Sensitive

Authorization Status  Record Status

Entity ID  Entity Type

FSA Registration Number

Records per page 15 1 of 1 Go Lock Columns 0

Authorization Status	Record Status	Entity ID	Entity Type	FSA Registration Number	FSA Registration Status	Hold Client Money
----------------------	---------------	-----------	-------------	-------------------------	-------------------------	-------------------

Exit

You can retrieve a previously entered record in the FSA Registration Maintenance Summary screen, as follows:

- Specify any or all of the following details in the FSA Registration Maintenance Summary screen:
- The status of the transaction in the Authorization Status field. If you choose the "Blank Space" option, then all the transactions that involve the specified unit holder are retrieved.
- The status of the record in the Record Status field. If you choose the "Blank Space" option, then all the records that involve the specified unit holder are retrieved.
- Entity ID
- Entity Type
- FSA Registration Number

Click 'Search' button to view the records. All records with the specified details are retrieved and displayed in the lower portion of the screen.

You can also retrieve the individual record detail from the detail screen by doing query in the following manner:

- Press F7
- Input the Entity ID and Entity Type
- Press F8

You can perform Edit, Delete, Amend, Authorize, Close and Reopen operation by selecting from the Action list.

You can also search the record by using combination of % and alphanumeric value.

### **5.22.2 Editing FSA Registration Maintenance Record**

You can modify the details of FSA Registration Maintenance parameters that you have already entered into the system, provided it has not been subsequently authorized. You can perform this operation as follows:

- Invoke the FSA Registration Maintenance Summary screen from the Browser.
- Select the status of the record that you want to retrieve for modification in the Authorization Status field. You can only modify records that are unauthorized. Accordingly, choose the Unauthorized option.
- Specify any or all of the details in the corresponding fields to retrieve the record that is to be modified. All unauthorized records with the specified details are retrieved and displayed in the lower portion of the screen.
- Double click the record that you want to modify in the list of displayed record. The FSA Registration Maintenance Detail screen is displayed.
- Select Unlock Operation from Action list to modify the record. Modify the necessary information.
- Click Save to save your changes. The FSA Registration Maintenance Detail screen is closed and the changes made are reflected in the IFSA Registration Maintenance Summary screen.

### **5.22.3 Viewing FSA Registration Maintenance Record**

To view a record that you have previously entered, you must retrieve the same in FSA Registration Maintenance Summary screen, as follows:

- Invoke the FSA Registration Maintenance Summary Screen from the Browser.
- Select the status of the transaction that you want to retrieve for viewing in the Authorization field. You can also view all records that are either unauthorized or authorized only, by choosing the Unauthorized/ Authorized option.
- Specify any or all of the details of the transaction in the corresponding fields on the screen, and click 'Search' button. All records with the specified details are retrieved and displayed in the lower portion of the screen.
- Double click the record that you want to view in the list of displayed records. The FSA Registration Maintenance Detail screen is displayed in View mode.

### **5.22.4 Deleting FSA Registration Maintenance Record**

You can delete only unauthorized records in the system. To delete a record that you have previously entered:

- Invoke the FSA Registration Maintenance Summary screen from the Browser.
- Select the status of the record that you want to retrieve for deletion.
- Specify any or all of the details and click 'Search' button. All records with the specified details are retrieved and displayed in the lower portion of the screen.
- Double click the record that you want to delete. The FSA Registration Maintenance Detail screen is displayed.
- Select Delete operation from the Action list. The system prompts you to confirm the deletion, and the record is deleted physically from the system database.

### **5.22.5 Authorizing FSA Registration Maintenance Records**

An unauthorized FSA Registration Maintenance record must be authorized in the system for it to be processed. To authorize a record:

- Invoke the FSA Registration Maintenance Summary screen from the Browser.
- Select the status of the record that you want to retrieve for authorization. Typically, choose the Unauthorized option.
- Specify any or all of the details of the record in the corresponding fields on the screen. Click 'Search' button. All transactions with the specified details that are pending authorization are retrieved and displayed in the lower portion of the screen.
- Double click the transaction that you wish to authorize. The FSA Registration Maintenance Detail screen is displayed. Select Authorize operation from Action.

When the checker authorizes a record, details of validations, if any, that were overridden by the maker of the transaction during the Save operation, are displayed. If any of these overrides results in an error, the checker must reject the transaction.

### **5.22.6 Amending FSA Registration Maintenance Record**

After an FSA Registration Maintenance record is authorized, it can be modified using the Unlock operation from Action list. To make changes to a transaction after authorization:

- Invoke the FSA Registration Maintenance Summary screen from the Browser.
- Select the status of the transaction that you wish to retrieve for amendment. You can only amend only authorized records.
- Specify any or all of the details of the FSA Registration Maintenance in the screen. All records with the specified details are retrieved and displayed in the lower portion of the screen.
- Double click the record that you want to amend. The FSA Registration Maintenance Detail screen is displayed in Amendment mode. Click the Unlock operation from the Action list to amend the record.
- Amend the necessary information. Click the Save button to save the changes.

### **5.22.7 Authorizing Amended FSA Registration Maintenance Records**

An amended FSA Registration Maintenance record must be authorized for the amendment to be made effective in the system. The authorization of amended records can only be done from Agency branch Module.

The process of authorization is subsequently the same as that for normal records.

---

## 6. Function ID Glossary

### U

UTCCIFND .....	2-50	UTDUHIOF .....	4-52
UTCUFHND .....	3-84	UTDUHLOA .....	4-32
UTDACCLS .....	4-69	UTDUHNPI .....	4-58
UTDACTYP .....	3-92	UTDUHNTX .....	4-41
UTDAGTAO .....	4-86	UTDUHPRD .....	3-88
UTDAGTPR .....	4-96	UTDURATX .....	4-41
UTDAMCSL .....	4-101	UTDVWCHG .....	5-66
UTDAOIFA .....	4-91	UTSACCLS .....	4-71
UTDATREP .....	4-74	UTSACTYP .....	3-95
UTDBCYPR .....	5-45	UTSAGTAO .....	4-87
UTDBRAIS .....	5-63	UTSAGTPR .....	4-98
UTDBRCOP .....	5-74	UTSAOIFA .....	4-93
UTDBRKAU .....	5-65	UTSATREP .....	4-78
UTDBRKJR .....	5-53	UTSBCYPR .....	5-46
UTDBRKMN .....	5-10	UTSBRKJR .....	5-58
UTDBRKTY .....	5-2	UTSBRKMN .....	5-34
UTDBRMIG .....	5-50	UTSBRKTY .....	5-6
UTDCADD .....	2-28	UTSBRMIG .....	5-51
UTDCFNMP .....	2-33	UTSCADD .....	2-30
UTDCHPAY .....	5-67	UTSCFNMP .....	2-35
UTDCIFAC .....	2-54	UTSCHPAY .....	5-72
UTDCIFCM .....	2-59	UTSCIFAC .....	2-56
UTDCIFEX .....	2-71	UTSCIFCM .....	2-68
UTDCIFLG .....	2-53	UTSCIFUH .....	2-40
UTDCIFUH .....	2-39	UTSCMHCH .....	2-46
UTDCMHCH .....	2-43	UTSCUST .....	2-19
UTDCUST .....	2-2	UTSFH .....	3-80
UTDENCMP .....	5-80	UTSFHIDS .....	4-15
UTDFH .....	3-10	UTSFSA .....	5-86
UTDFHIDS .....	4-2	UTSKYCCD .....	3-105
UTDFSA .....	5-84	UTSMINHL .....	4-66
UTDKYCCD .....	3-104	UTSMINPY .....	5-77
UTDLOIPR .....	4-38	UTSNTPDE .....	4-83
UTDMINHL .....	4-63	UTSSERLC .....	2-25
UTDMINPY .....	5-75	UTSUH .....	3-80
UTDNTPDE .....	4-81	UTSUHCOE .....	3-111
UTDSERLC .....	2-24	UTSUHDEL .....	4-26
UTDTAXCR .....	4-102	UTSUHIDS .....	4-15
UTDTXBMR .....	5-43	UTSUHIOF .....	4-55
UTDUH .....	3-10	UTSUHLOA .....	4-35
UTDUHCOE .....	3-109	UTSUHLOI .....	4-35
UTDUHDEL .....	4-20	UTSUHNPI .....	4-59
UTDUHIDS .....	4-2	UTSUHNTX .....	4-47
		UTSUHPRD .....	3-90
		UTSURATX .....	4-47