

Gateway Services User Guide

Oracle FLEXCUBE Universal Banking

Release 14.4.0.1.0

Part No. F33267-01

August 2020

Gateway Services User Guide
Oracle Financial Services Software Limited
Oracle Park

Off Western Express Highway
Goregaon (East)
Mumbai, Maharashtra 400 063
India

Worldwide Inquiries:

Phone: +91 22 6718 3000

Fax: +91 22 6718 3001

<https://www.oracle.com/industries/financial-services/index.html>

Copyright © 2007, 2020, Oracle and/or its affiliates. All rights reserved.

Oracle and Java are registered trademarks of Oracle and/or its affiliates. Other names may be trademarks of their respective owners.

U.S. GOVERNMENT END USERS: Oracle programs, including any operating system, integrated software, any programs installed on the hardware, and/or documentation, delivered to U.S. Government end users are “commercial computer software” pursuant to the applicable Federal Acquisition Regulation and agency-specific supplemental regulations. As such, use, duplication, disclosure, modification, and adaptation of the programs, including any operating system, integrated software, any programs installed on the hardware, and/or documentation, shall be subject to license terms and license restrictions applicable to the programs. No other rights are granted to the U.S. Government.

This software or hardware is developed for general use in a variety of information management applications. It is not developed or intended for use in any inherently dangerous applications, including applications that may create a risk of personal injury. If you use this software or hardware in dangerous applications, then you shall be responsible to take all appropriate failsafe, backup, redundancy, and other measures to ensure its safe use. Oracle Corporation and its affiliates disclaim any liability for any damages caused by use of this software or hardware in dangerous applications.

This software and related documentation are provided under a license agreement containing restrictions on use and disclosure and are protected by intellectual property laws. Except as expressly permitted in your license agreement or allowed by law, you may not use, copy, reproduce, translate, broadcast, modify, license, transmit, distribute, exhibit, perform, publish or display any part, in any form, or by any means. Reverse engineering, disassembly, or decompilation of this software, unless required by law for interoperability, is prohibited.

The information contained herein is subject to change without notice and is not warranted to be error-free. If you find any errors, please report them to us in writing.

This software or hardware and documentation may provide access to or information on content, products and services from third parties. Oracle Corporation and its affiliates are not responsible for and expressly disclaim all warranties of any kind with respect to third-party content, products, and services. Oracle Corporation and its affiliates will not be responsible for any loss, costs, or damages incurred due to your access to or use of third-party content, products, or services.

Contents

1. Preface	1-1
1.1 Introduction.....	1-1
1.2 Audience.....	1-1
1.3 Documentation Accessibility.....	1-1
1.4 Acronyms and Abbreviations.....	1-1
1.5 Organization	1-1
1.6 Related Documents.....	1-2
1.7 Glossary of Icons.....	1-2
2. Gateway Functions - An Overview	2-1
2.1 Introduction.....	2-1
2.2 Inbound Application Integration	2-1
2.2.1 EJB Based Synchronous Deployment Pattern	2-1
2.2.2 Web Services Based Synchronous Deployment Pattern.....	2-2
2.2.3 HTTP Servlet Based Synchronous Deployment Pattern	2-2
2.2.4 MDB Based Asynchronous Deployment Pattern	2-2
2.3 Outbound Application Integration	2-3
2.4 Responsibilities of Integration Gateway	2-3
2.5 Deployment of Oracle FLEXCUBE Integration Gateway.....	2-3
2.6 Deployment Patterns for Application Integration	2-4
3. External System Maintenance	3-1
3.1 Introduction.....	3-1
3.2 External System	3-1
3.2.1 Defining an External System	3-1
3.2.2 Specifying External System Details	3-2
3.2.3 Indicating Correlation Pattern	3-2
3.2.4 Specifying Message Exchange Pattern	3-2
3.2.5 Specifying Queue Details	3-3
3.2.6 Specifying External System Queue Details	3-3
3.2.7 Viewing External System Details	3-3
3.2.8 Accessing Services and Operations	3-4
3.3 Access Rights to an External System.....	3-5
3.3.1 Defining Access Rights to an External System.....	3-5
3.3.2 Viewing External System Function Details	3-6
3.3.3 Defining Access Rights to a User ID.....	3-7
3.3.4 Maintaining Upload Source Details.....	3-7
3.3.5 Specifying Upload Source Preferences	3-8
3.3.6 Maintaining Function ID Preferences.....	3-9
3.4 Gateway Password Generation Logic For External System Authentication.....	3-10
3.4.1 Password and Message ID as input	3-11
3.5 Incoming Message Browser	3-11

3.5.1	<i>Viewing Incoming Message Details</i>	3-13
3.6	Duplicate Message Browser	3-13
3.6.1	<i>Querying Duplicate Message Browser</i>	3-15
3.7	Outgoing Message Browser	3-16
3.7.1	<i>Querying Outgoing Message Browser</i>	3-19
3.8	Defining Notification Messages	3-19
3.8.1	<i>Viewing Installed Notification Details</i>	3-21
3.9	Defining the Notifications Enroutes	3-22
3.9.1	<i>Viewing Summary screen</i>	3-23
3.10	Maintaining MT Task Details	3-24
3.11	Amendment Maintenance	3-25
3.11.1	<i>Maintaining Gateway Amendment Details</i>	3-25
3.12	Gateway Maintenance for Approval Deployment	3-27
3.12.1	<i>Maintaining Gateway for Approval Deployment</i>	3-27
4.	Message Formats	4-1
4.1	Introduction	4-1
4.2	Oracle FLEXCUBE Envelope	4-2
4.2.1	<i>FCUBS HEADER</i>	4-3
4.2.2	<i>FCUBS_BODY</i>	4-5
4.3	Oracle FLEXCUBE NOTIFICATION	4-6
4.3.1	<i>FCUBS NOTIFICATION HEADER</i>	4-6
5.	Annexure – List of Messages	5-1
5.1	Introduction	5-1
5.2	Inbound Application Integration – Services	5-1
5.2.1	<i>FCUBSAccService</i>	5-1
5.2.2	<i>FCUBSLD Service</i>	5-7
5.2.3	<i>FCUBSCustomerService</i>	5-10
5.2.4	<i>FCUBSTDService</i>	5-16
5.2.5	<i>FCUBSIFService</i>	5-18
5.2.6	<i>FCUBSInteractionService</i>	5-20
5.2.7	<i>FCUBSICService</i>	5-21
5.2.8	<i>FCUBSSTService</i>	5-24
5.2.9	<i>FCUBSIAService</i>	5-27
5.2.10	<i>FCUBSRTService</i>	5-30
6.	Function ID Glossary	6-1

1. Preface

1.1 Introduction

This manual is designed to help you quickly get acquainted with the Integration Gateway of Oracle FLEXCUBE.

It provides an overview to the module, and provides information on using the Integration Gateway module of Oracle FLEXCUBE. This user manual is a supplement to the Common Core - Core Entities and Services User Manual and contains only specific functionalities and information related to Oracle FCUBS Gateway Services. Hence, this document should be read in conjunction with the Common Core - Core Entities and Services User Manual from the perspective of completeness in flow and understanding.

You can further obtain information specific to a particular field by placing the cursor on the relevant field and striking <F1> on the keyboard.

1.2 Audience

This manual is intended for the following User/User Roles:

Role	Function
IT department members responsible for integration	Input functions for maintenance related to the gateway
IT managers	Authorization functions

1.3 Documentation Accessibility

For information about Oracle's commitment to accessibility, visit the Oracle Accessibility Program website at <http://www.oracle.com/pls/topic/lookup?ctx=acc&id=docacc>.

1.4 Acronyms and Abbreviations

Abbreviation	Description
FLEXCUBE UBS	FLEXCUBE Universal Banking Solution

1.5 Organization

The manual is organized in the following manner:

Chapter	Description
Chapter 1	<i>About this Manual</i> gives information on the intended audience. It also lists the various chapters covered in this User Manual.
Chapter 2	<i>Gateway Functions - An Overview</i> explains the features of this module.





Chapter 3	<i>External System Maintenance</i> explains the maintenance of external systems and the various processes involved.
Chapter 4	<i>Message Formats</i> explains the different message formats.
Chapter 5	<i>Annexure – List of Messages</i> lists all the messages that you encounter while working with Oracle FLEXCUBE Gateway services.
Chapter 6	<i>Planned Outage Support Server</i> describes the process of having a support server to substitute the host server during downtime.
Chapter 7	<i>Function ID Glossary</i> has alphabetical listing of Function/Screen ID's used in the module with page references for quick navigation.

1.6 Related Documents

- Core Entities User Manual
- Procedures User Manual
- Settlements User Manual
- Profit and Charges User Manual
- Common Core - Core Entities and Services

1.7 Glossary of Icons

This User Manual may refer to all or some of the following icons:

Icons	Function
	Exit
	Add row
	Delete row
	Option List

2. Gateway Functions - An Overview

2.1 Introduction

Integration of different applications and solutions is a key area in today's systems. A variety of specialized applications deployed on disparate platforms and using different infrastructure need to be able to communicate and integrate seamlessly with Oracle FLEXCUBE in order to exchange data. The Oracle FLEXCUBE Integration Gateway (referred to as 'Gateway' in the rest of the document) will cater to these integration needs.

The integration needs supported by the Gateway can be broadly categorized from the perspective of the Gateway as follows:

- Inbound application integration – used when any external system needs to add, modify or query information within Oracle FLEXCUBE
- Outbound application integration – used when any external system needs to be notified of the various events that occur within Oracle FLEXCUBE.

2.2 Inbound Application Integration

Oracle FLEXCUBE Inbound Application Gateway provides XML based interfaces thus enhancing the need to communicate and integrate with the external systems. The data exchanged between Oracle FLEXCUBE and the external systems will be in the form of XML messages. These XML messages are defined in FCUBS in the form of XML Schema Documents (XSD) and are referred to as 'FCUBS formats'

For more information on FCUBS formats refer the Message Formats chapter in this User Manual.

FCUBS Inbound Application Integration Gateway uses the Synchronous and Asynchronous Deployment Pattern for addressing the integration needs.

The Synchronous Deployment Pattern is classified into the following:

- Oracle FLEXCUBE EJB Based Synchronous Inbound Application Integration Deployment Pattern
- Oracle FLEXCUBE Web Services Based Synchronous Inbound Application Integration Deployment Pattern
- Oracle FLEXCUBE HTTP Servlet Based Synchronous Inbound Application Integration Deployment Pattern

Asynchronous Deployment Pattern is:

- Oracle FLEXCUBE MDB Based Asynchronous Inbound Application Integration Deployment Pattern

2.2.1 EJB Based Synchronous Deployment Pattern

The Enterprise Java Beans (EJB) deployment pattern will be used in integration scenarios where the external system connecting to Oracle FLEXCUBE is 'EJB literate', i.e., the external system is capable of interacting with Oracle FLEXCUBE based upon the EJB interface. In this deployment pattern, the external system will use the RMI/IIOP protocol to communicate with the Oracle FLEXCUBE EJB.

In this deployment pattern the EJB displayed by Oracle FLEXCUBE will be a stateless session bean. The actual request will be in the form of an XML message. After the necessary processing is done in Oracle FLEXCUBE based on the request, the response is returned to the external system as an XML message. The transaction control for the processing will stay with the Oracle FLEXCUBE EJB.

2.2.2 Web Services Based Synchronous Deployment Pattern

The web services deployment pattern will be used in integration scenarios where the external system connecting to Oracle FLEXCUBE wants to connect using standards-based, interoperable web services.

This deployment pattern is especially applicable to systems which meet the following broad guidelines:

- Systems that are not 'EJB literate', i.e., such systems are not capable of establishing connections with Oracle FLEXCUBE based upon the EJB interface; and/or
- Systems that prefer to use a standards-based approach

In this deployment pattern, the external system will use the SOAP (Simple Object Access Protocol) messages to communicate to the Oracle FLEXCUBE web services.

The services displayed by Oracle FLEXCUBE are of a 'message based' style, i.e., the actual request will be in the form of an XML message, but the request will be a 'payload' within the SOAP message. After the necessary processing is done in Oracle FLEXCUBE based on the request, the response is returned to the external system as an XML message which will be a 'payload' within the response SOAP message. The transaction control for the processing will stay with the Oracle FLEXCUBE.

2.2.3 HTTP Servlet Based Synchronous Deployment Pattern

The HTTP servlet deployment pattern will be used in integration scenarios where the external system connecting to Oracle FLEXCUBE wants to connect to Oracle FLEXCUBE using simple HTTP messages.

This is especially applicable to systems such as the following:

- Systems that are not 'EJB literate', i.e., are not capable establishing a connections with Oracle FLEXCUBE based upon the EJB interface; and/or
- Systems that prefer to use a simple http message based approach without wanting to use SOAP as the standard

In this deployment pattern, the external system will make an HTTP request to the Oracle FLEXCUBE servlet.

For this deployment pattern, Oracle FLEXCUBE will display a single servlet. The actual request will be in the form of an XML message. This XML message is embedded into the body of the HTTP request sent to the Oracle FLEXCUBE servlet. After the necessary processing is done in Oracle FLEXCUBE based on the request, the response is returned to the external system as an XML message which is once again embedded within the body of the response HTTP message. The transaction control for the processing will stay with the Oracle FLEXCUBE.

2.2.4 MDB Based Asynchronous Deployment Pattern

The MDB deployment pattern is used in integration scenarios where the external system connecting to Oracle FLEXCUBE wants to connect to Oracle FLEXCUBE using JMS queues.

This is especially applicable to systems such as the following:

- Systems that prefer to use JMS queues based approach without wanting to wait for the reply

Here external system sends messages in XML format to request queue on which an MDB is listening. When a message arrives on the queue, it is picked up for processing. After the necessary processing is done in Oracle FLEXCUBE, based on the request, the response is sent to the response queue as an XML message

2.3 Outbound Application Integration

The Outbound Application Integration is also called the Oracle FLEXCUBE Notify Application Integration layer. This application layer sends out notification messages to the external system whenever events occur in Oracle FLEXCUBE.

The notification messages generated by FCUBS on the occurrence of these events will be XML messages. These XML messages are defined in FCUBS in the form of XML Schema Documents (XSD) and are referred to as 'FCUBS formats'

For more information on FCUBS formats refer the Message Formats chapter in this module.

2.4 Responsibilities of Integration Gateway

The primary responsibilities of Oracle FLEXCUBE Integration Gateway include the following:

- Authentication
- Duplicate recognition
- Validation
- Routing
- Logging of messages

2.5 Deployment of Oracle FLEXCUBE Integration Gateway

Message communication - incoming or outgoing from/to an external system in Oracle FLEXCUBE will happen only through an Oracle FLEXCUBE Integration Gateway. Hence, it becomes the first point of contact or last point of contact with the database in message flow. The Oracle FLEXCUBE Integration Gateway can be deployed to support both the distributed and single schema deployments of Oracle FLEXCUBE:

- Distributed deployment of FCUBS – In this situation the database components of the Gateway are deployed as two or more schemas
 - The messaging schema as part of SMS schema in the SMS and/or HO instance
 - The business schema(s) in the various branch schemas in the branch instance(s)
- Single schema deployment of FCUBS – In this situation the database components of the Gateway (messaging and business) are both deployed as part of the single Oracle FLEXCUBE schema.

2.6 Deployment Patterns for Application Integration

Business Integration Needs	Nature of Integration	Oracle FLEXCUBE Deployment Pattern	Remarks
Inbound Transactions into Oracle FLEXCUBE	Synchronous	FLEXCUBE UBS EJB	Recommended
		FLEXCUBE UBS HTTP Servlet	This can be used if the external system cannot communicate to Oracle FLEXCUBE using EJB.
		FLEXCUBE UBS Web Services	This can be used if the external system chooses to communicate only through Web Services.
	Asynchronous	FLEXCUBE UBS MDB	This can be used if the external system chooses to communicate only through JMS queues
Inbound Queries into Oracle FLEX-CUBE	Synchronous	FLEXCUBE UBS EJB	Recommended
		FLEXCUBE UBS In Servlet	This can be used if the external system cannot communicate to Oracle FLEXCUBE using EJB.
		FLEXCUBE UBS Web Services	This can be used if the external system chooses to communicate only through Web Services.
	Asynchronous	FLEXCUBE UBS MDB	This can be used if the external system chooses to communicate only through JMS queues
Handoffs from Oracle FLEX-CUBE	Asynchronous	FLEXCUBE UBS Notify	Recommended

3. External System Maintenance

3.1 Introduction

This chapter contains the following sections:

- [Section 3.2, "External System"](#)
- [Section 3.3, "Access Rights to an External System"](#)
- [Section 3.4, "Gateway Password Generation Logic For External System Authentication"](#)
- [Section 3.5, "Incoming Message Browser"](#)
- [Section 3.6, "Duplicate Message Browser"](#)
- [Section 3.7, "Outgoing Message Browser"](#)
- [Section 3.8, "Defining Notification Messages"](#)
- [Section 3.9, "Defining the Notifications Enroutes"](#)
- [Section 3.10, "Maintaining MT Task Details"](#)
- [Section 3.11, "Amendment Maintenance"](#)
- [Section 3.12, "Gateway Maintenance for Approval Deployment"](#)

3.2 External System

This section contains the following topics:

- [Section 3.2.1, "Defining an External System"](#)
- [Section 3.2.2, "Specifying External System Details"](#)
- [Section 3.2.3, "Indicating Correlation Pattern "](#)
- [Section 3.2.4, "Specifying Message Exchange Pattern"](#)
- [Section 3.2.5, "Specifying Queue Details"](#)
- [Section 3.2.6, "Specifying External System Queue Details"](#)
- [Section 3.2.7, "Viewing External System Details"](#)
- [Section 3.2.8, "Accessing Services and Operations "](#)

3.2.1 Defining an External System

You need to define an external system that will communicate with the Oracle FLEXCUBE Integration Gateway.

You can define an external system using the **External System Maintenance** page

You can invoke this screen by typing 'GWDETSYS' in the field at the top right corner of the Application tool bar and clicking the adjoining arrow button.

The various details required by the **External System Maintenance** page are described below.

3.2.2 Specifying External System Details

External System

Specify a name for the external system. This should be the same as the Source in an incoming message.

Description

Specify a brief description for the External System.

3.2.3 Indicating Correlation Pattern

Request

You can define a way in which the external system should correlate its request message with the response message. You can choose Message ID of a request message as the Correlation ID in the response message. Alternatively, you can choose Correlation ID of a request message and maintain it as the Correlation ID of the corresponding response message.

3.2.4 Specifying Message Exchange Pattern

Request Message

You can choose the Request message to be 'Full Screen' or 'Input Only'. If you select 'Full Screen' as the request message, the response message will also display 'Full Screen'.

Response Message

You can choose the Response message to be 'Full Screen' or 'Record Identification Msg'.

Note

You can select 'Record Identification Msg' as the response message only if you select 'Input Only' in the request message.

3.2.5 Specifying Queue Details

Default Response Queue

You can define a response queue for each of the In Queue's through which the External System will communicate with Oracle FLEXCUBE. Define a valid queue name as the Default Response Queue.

Dead Letter Queue

If the messages received are non-readable, such messages are directed to Dead Letter Queue defined for the external system.

Note

If the Dead Letter Queue is not defined, such messages will be redirected to a queue with the name of the request queue appended with '_E'.

XSD Validation Required

Check this box to indicate if the request message should be validated against its corresponding XSD.

Register Response Queue Message ID

Check this box to indicate if the message ID provided by the Response Queue should be logged when a response message is posted into the queue.

3.2.6 Specifying External System Queue Details

The 'External System Queues' list contains the 'In Queue' and 'Response Queue' lists. To add a record to the 'External System Queues' list click add icon. To delete a record from the list, select the record using its check box and then click delete icon.

In Queue

Specify the name of the queue from which the messages were received. The name of the queue will help identify the external system.

Note

This is required only if an incoming message does not display the source of the message. An In Queue is mapped to only one External System.

You can map multiple queues to a source. System will allow a source to post messages to multiple queues.

Response Queue

You can define Response Queue for every In Queue. This is required only when the External System fails to display the queue name on posting a request message into the In Queue.

3.2.7 Viewing External System Details

The details of previously defined external Systems can be viewed using the 'External System - Summary' screen as shown below. You can invoke this screen by typing 'GWSETSYS' in

the field at the top right corner of the Application tool bar and clicking the adjoining arrow button.

The screenshot shows a web application window titled "Summary". At the top, there are "Advanced Search" and "Reset" buttons. Below this, there are five search criteria fields: "Authorization Status" (a dropdown menu), "Record Status" (a dropdown menu), "External System" (a text input with a search icon), "Dead Letter Queue" (a text input with a search icon), and "Default Response Queue" (a text input with a search icon). Below the search fields is a pagination bar with "Records per page" set to 15, and buttons for "First", "Previous", "1 Of 1", "Next", "Last", and "Go". Below the pagination bar is a table with five columns: "Authorization Status", "Record Status", "External System", "Default Response Queue", and "Dead Letter Queue". The table is currently empty. At the bottom of the window, there are buttons for "Authoriza", "Record St", and "Exit".

This summary screen can be used to search for external systems which match the data specified for any of the following criteria:

- Authorization Status
- External System
- Dead Letter Queue
- Record Status
- Default Response Queue

The 'Result' list shows the external systems which match your query. The search functions available are:

Advanced

Click **Advanced** to specify queries with logical operators such as AND, OR and NOT.

Reset

Click **Reset** to empty the values in the criteria fields, so that you may begin a new search.

Query

After specifying your search criteria click **Query** to view the list of results which match your search criteria.

Refresh

Click **Refresh** to refresh the list of results.

3.2.8 Accessing Services and Operations

In a message it is mandatory to maintain a list of Service Names and Operation Codes. This information is called Gateway Operations.

A combination of every such Service Name and Operation Code is mapped to a combination of Function ID and Action. Every screen in Oracle FLEXCUBE is linked with a function ID. This information is called Gateway Functions.

You can gain access to an external system using the Gateway Functions. The Function IDs mapped in Gateway Functions should be valid Function IDs maintained in Oracle FLEXCUBE. Hence, for every new Service or Operation being introduced, it is important that you provide data in Gateway Operations and Gateway Functions.

Refer the Message Formats chapter for more information on Services and Operations.

3.3 Access Rights to an External System

This section contains the following topics:

- [Section 3.3.1, "Defining Access Rights to an External System"](#)
- [Section 3.3.2, "Viewing External System Function Details"](#)
- [Section 3.3.3, "Defining Access Rights to a User ID"](#)
- [Section 3.3.4, "Maintaining Upload Source Details"](#)
- [Section 3.3.5, "Specifying Upload Source Preferences"](#)
- [Section 3.3.6, "Maintaining Function ID Preferences"](#)

3.3.1 Defining Access Rights to an External System

You can define access rights to an external system using the 'External System Functions – Detailed' screen.

You can invoke this screen by typing 'GWDEFUN' in the field at the top right corner of the Application tool bar and clicking the adjoining arrow button.

The screenshot shows the 'External System Functions' screen. At the top, there is a title bar with 'External System Functions' and a minus sign. Below the title bar, there are two buttons: 'New' and 'Enter Query'. The main content area is divided into two columns. The left column contains five input fields: 'External System *', 'Function *', 'Action *', 'Service Name', and 'Operation Code'. The right column contains a 'Description' field with a text area containing the text 'Bulk SMS Check'. At the bottom of the screen, there is a 'Fields' section with labels for 'Maker', 'Checker', 'Date Time:', 'Mod No', 'Record Status', and 'Authorization Status'. An 'Exit' button is located in the bottom right corner.

In the above screen, you need to specify the following details:

External System

Select an external system for which you wish to provide access rights. The adjoining option list displays all the external systems you have maintained in the 'External Systems – Detailed' screen.

Function ID

Select a Function ID from the list of values by clicking the adjoining option list. The function ids are invoked from Gateway Functions.

Action

Select an action for the external system from the option list provided.

Service Name

This displays the service name based on the Function ID and Action you select.

Operation Code

This displays the Operation Code based on the Function ID and Action you select.

3.3.2 Viewing External System Function Details

You can view the access rights details which have already been defined using the 'External SystemFunctions - Summary' screen as shown below. You can invoke this screen by typing 'GWSETFUN' in the field at the top right corner of the Application tool bar and clicking the adjoining arrow button.

Authorization Status	Record Status	Function	Action	External System
----------------------	---------------	----------	--------	-----------------

This summary screen can be used to search for external system functions which match any of the following criteria:

- Authorization Status
- External System
- Record Status
- Action
- Function

The 'Result' list shows the external system functions which match your query. The search functions available are:

Advanced

Click **Advanced** to specify queries with logical operators such as AND, OR and NOT.

Reset

Click **Reset** to empty the values in the criteria fields, so that you may begin a new search.

Query

After specifying your search criteria click **Query** to view the list of results which match your search criteria.

Refresh

Click **Refresh** to refresh the list of results.

3.3.3 Defining Access Rights to a User ID

For a User ID to access a request message, you can individually map each Function ID to a User ID.

Note

You can provide access to functions only if the Function IDs provided in Gateway Functions are valid.

3.3.4 Maintaining Upload Source Details

Oracle FLEXCUBE facilitates upload of data from an external source. The details of the source from which data has to be uploaded need to be maintained in Oracle FLEXCUBE using the 'Upload Source Maintenance' screen. You can invoke the 'Upload Source Maintenance' screen by typing 'CODSORCE' in the field at the top right corner of the Application tool bar and clicking the adjoining arrow button.

Input By	Authorized By	Modification Number
Date Time	Date Time	Authorized Open

The following details need to be captured here:

Source Code

Specify a code for the for the source from which data has to be uploaded to Oracle FLEXCUBE.

Description

Give a small description for the source code specified.

Base Data From FLEXCUBE

Check this box to indicate if base data has to be uploaded from Oracle FLEXCUBE.

3.3.5 Specifying Upload Source Preferences

You can set preferences for upload of data from an external source in the 'Upload Source Preferences Maintenance' screen. You can invoke the 'Upload Source Preferences Maintenance' screen by typing 'CODUPLDM' in the field at the top right corner of the Application tool bar and clicking the adjoining arrow button.

Function ID Preference			
Maker	Date Time:	Mod No	Record Status
Checker	Date Time:	Authorization Status	Exit

The following details are captured here:

Source Code

Select Source Code from the option list. Depending on the source code you select here data is uploaded from that source into Oracle FLEXCUBE.

Module Code

You can choose to upload data from a source directly onto a module in FLEXCUBE. Indicate the module into which you would like to upload data from a given source.

On Override

Oracle FLEXCUBE generates override messages in case it encounters any discrepancies during data upload. You can choose to do any of the following:

- Ignore – Select this option to ignore such error messages and continue with the upload process.
- Override – Select this option to put the record on hold for user intervention later.
- Reject – Select this option to reject the record.

On Exception

In case a serious error occurs during data upload, Oracle FLEXCUBE generates an error message. You can choose to put the record with the error on hold. In such a case, choose

'Move To Queue' from the list of options available. If you would like to reject the record altogether, choose 'Reject'.

Post Upload Status

If you would like to automatically authorize the data that is uploaded into Oracle FLEXCUBE choose the 'Authorize' option here.

If you would like the record to be put on hold choose this option in this field.

If you would like the record to be unauthorized, choose the 'Unauthorized' option in this field. The record will not be authorized automatically on upload. You will have to manually authorize the data.

Purge Days (Calendar)

Specify the days maintained for purging of the data uploaded.

Allow Deferred Processing

Check this option to defer processing of amendment and cancellation uploads.

Allow EOD with Deferred

Check this option to proceed even if the records exist in the deferred processing log.

If it is unchecked, then the EOD process halts until the deferred process log is cleared.

Allow Delete

Check this option to delete the process log.

3.3.6 Maintaining Function ID Preferences

Click 'Function ID Preferences' button in the 'Upload Source Preferences Maintenance' screen.

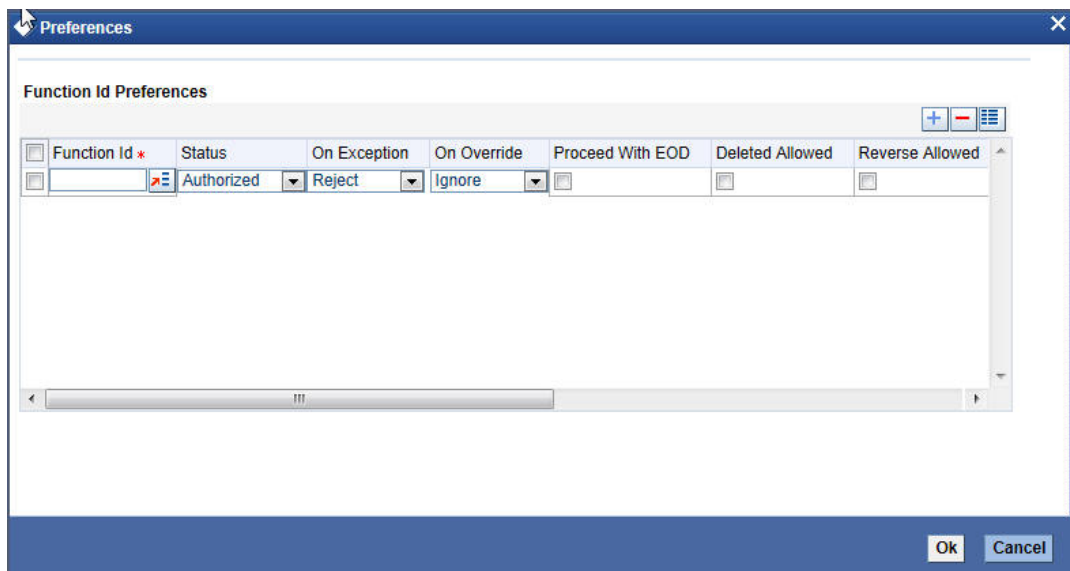

You can enter the following details:

Function Id

Specify the function ID. The adjoining option list displays all the function IDs maintained in the system. Select the appropriate one.

Status

Select the status of the record from the drop-down list and the available options are:

- Authorized
- Unauthorized
- Put On hold

On Exception

Select the record status in case of any exception while saving from the drop-down list and the available options are:

- Put On Hold
- Reject

On Override

Select the record status in case of any overriding a saved record from the drop-down list and the available options are:

- Put On Hold
- Reject
- Ignore

Proceed With EOD

Check this box, if you wish to proceed with EOD.

Deleted Allowed

Check this box, if deleting is allowed.

Reverse Allowed

Check this box, if reversal is allowed.

Amend Allowed

Check this box, if amendment is allowed.

Purge Days (Calendar)

Specify the calendar purge days

Allow Deferred Processing

Check this box, if deferred processing is allowed.

Allow EOD with Deferred

Check this box, if EOD with deferred is allowed.

3.4 Gateway Password Generation Logic For External System Authentication

This section describes the Encryption information for gateway authentication.

If Password authentication is required for an external system, then check the 'System Authentication Required' check box while maintaining the External System details in CODSORCE.

Once this check box is checked Oracle FLEXCUBE validates for Encrypted password as part of every request sent by the External System. The password encryption logic as below:

3.4.1 Password and Message ID as input

Message ID, present as part of the header in Request XML, is considered as hash. External System generates an unique Message ID, which is functional mandatory field in the header. Create a Message Digest with SHA-512 algorithm.

The hash created from the previous step and the password in clear text together is encrypted in DESede encryption method. Apply Base64 encoding to encrypted value and send to the Oracle FLEXCUBE gateway.

3.5 Incoming Message Browser

The messages received from the external system will be displayed in the Incoming Message Browser.

You can invoke the 'Incoming Message Browser' screen by typing 'GWDINBRW' in the field at the top right corner of the Application tool bar and clicking the adjoining arrow button.

Incoming Message Browser - Detail

Enter Query

Message Reference * _____

Message Id _____

Message Status _____

Operation Code _____

FLEXCUBE Reference _____

Their User Id _____

Queue Name _____

Request Queue Message Id _____

Repair Reason _____

External System _____

Correlation Id _____

Service Name _____

Branch _____

User Id _____

Branch Date _____

Server Date Stamp _____

XML View Text View

Exit

In the 'Incoming Message Browser' screen you can view the details of the messages received from the external systems. You can also view the messages in the XML format or the Text format.

Click 'Text View' button to view the incoming messages in text format as shown below:



Click 'XML View' button to view the 'Gateway Browser Window' screen which displays the messages in XML format.

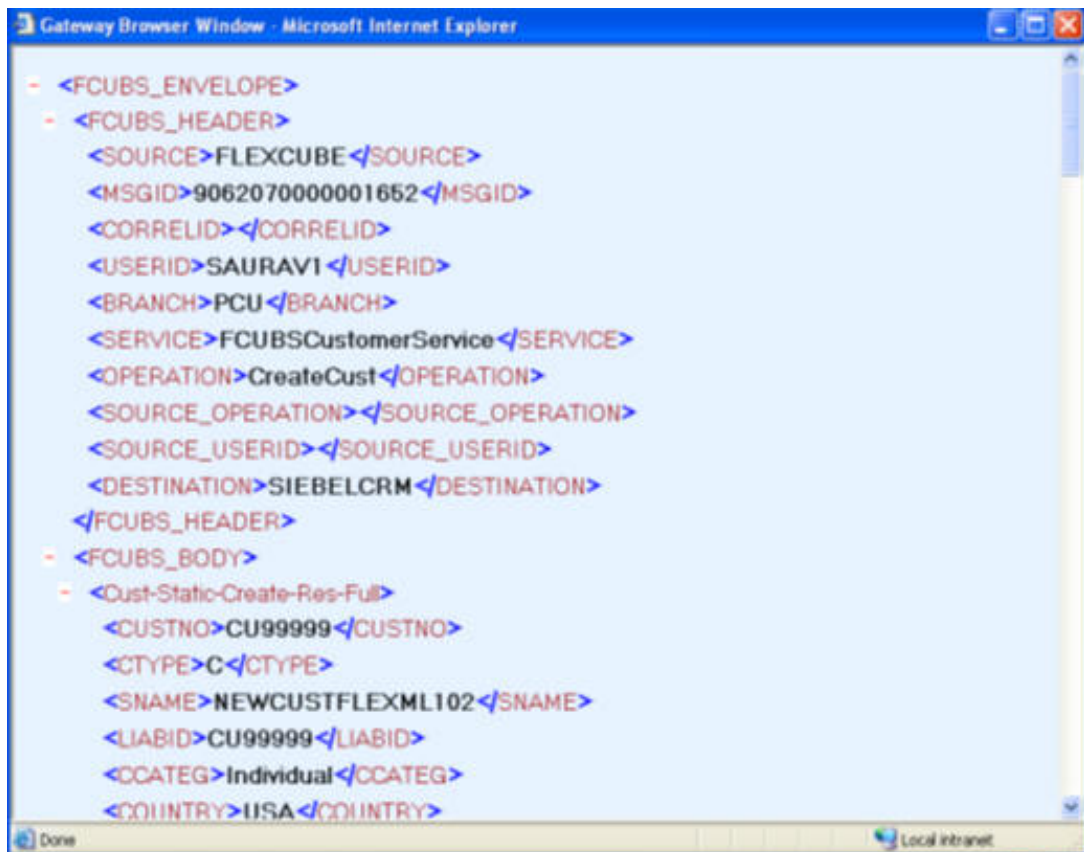

3.5.1 Viewing Incoming Message Details

The summary of all messages received from the external system can be viewed using the 'Incoming Message Browser - Summary' screen as shown below. You can invoke this screen by typing 'GWSINBRW' in the field at the top right corner of the Application tool bar and clicking the adjoining arrow button.

The screenshot shows the 'Incoming Message Browser' application window. It includes a search bar with 'Search', 'Advanced Search', and 'Reset' options. Below the search bar is a 'Case Sensitive' checkbox. The main area contains two columns of search criteria fields: 'Message Reference', 'External System', 'Correlation Id', 'Service Name', 'User Id', 'Branch Date', and 'Message Status' on the left; and 'Branch', 'Message Id', 'Request Queue Message Id', 'Operation Code', 'Their User Id', 'Server Date Stamp', and 'FLEXCUBE Reference' on the right. Each field has a magnifying glass icon. Below the search fields is a pagination bar with 'Records per page 15', 'First', 'Previous', '1 Of ...', 'Next', 'Last', 'Go', and 'Lock Columns 0'. A table header is visible below the pagination bar with columns: 'Message Reference', 'Branch', 'External System', 'Message Id', 'Correlation Id', 'Request Queue Message Id', 'Service Name', 'Operation Code', 'User Id', and 'Their User Id'. The table body is currently empty. At the bottom right of the window is an 'Exit' button.

This summary screen can be used to search for incoming messages which match the criteria (Message Reference Number, External System, Service Name etc) you specify. The 'Result' list shows the messages which match your query. The search functions available are:

Advanced

Click **Advanced** to specify queries with logical operators such as AND, OR and NOT.

Reset

Click **Reset** to empty the values in the criteria fields, so that you may begin a new search.

Search

Specify your search criteria to view the list of results which match your search criteria.

3.6 Duplicate Message Browser

If Oracle FLEXCUBE Integration Gateway identifies a duplicate message it will be sent to the Duplicate Messages Browser. You can invoke the 'Duplicate Message Browser - Summary'

screen by typing 'GWSPBROW' in the field at the top right corner of the Application tool bar and clicking the adjoining arrow button.

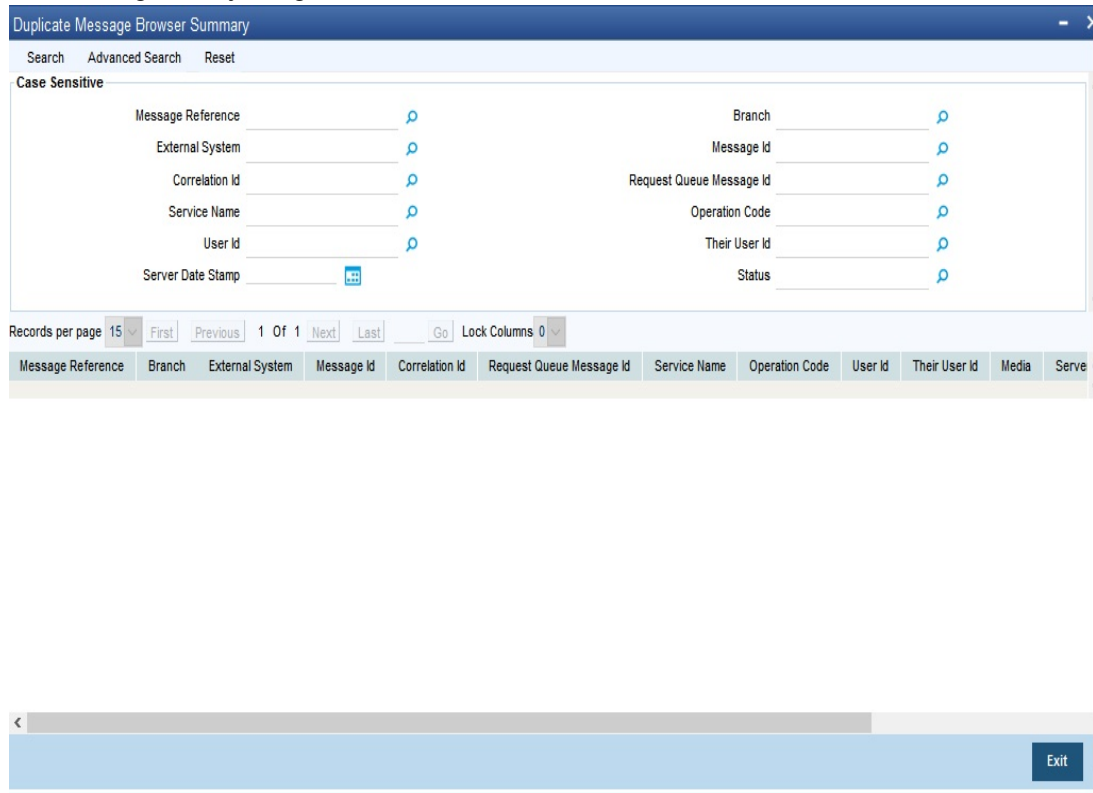

Click 'Text View' button in the 'Duplicate Message Browser - Summary' screen to view the duplicate messages in the text format.

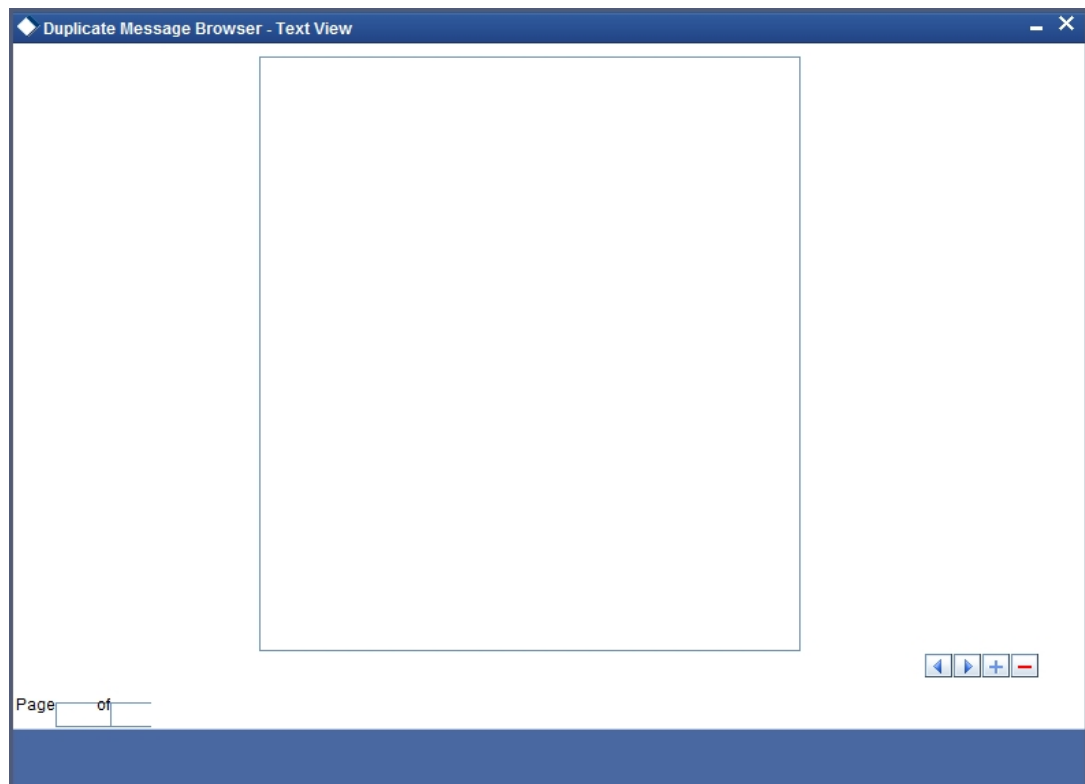

Click 'XML View' button in the 'Duplicate Message Browser - Summary' screen to view the duplicate messages in the following format:

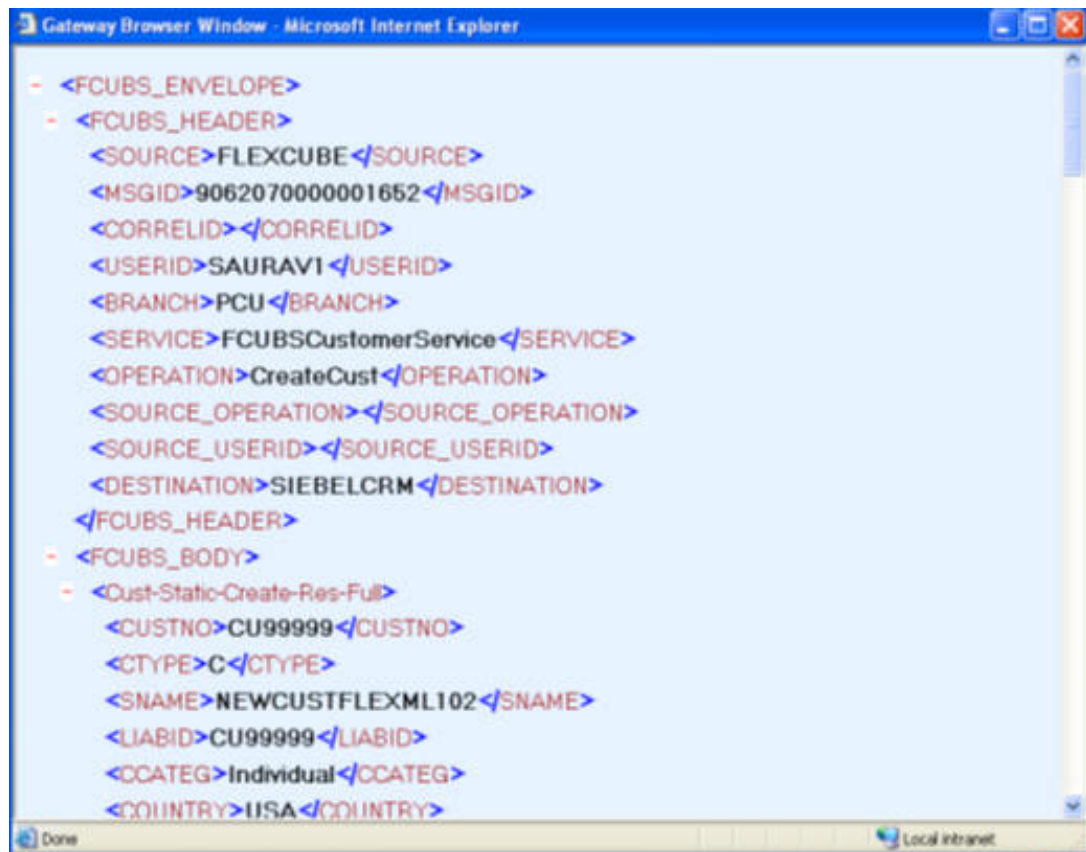

```
<FCUBS_ENVELOPE>
  <FCUBS_HEADER>
    <SOURCE>FLEXCUBE</SOURCE>
    <MSGID>9062070000001652</MSGID>
    <CORRELID></CORRELID>
    <USERID>SAURAVI</USERID>
    <BRANCH>PCU</BRANCH>
    <SERVICE>FCUBSCustomerService</SERVICE>
    <OPERATION>CreateCust</OPERATION>
    <SOURCE_OPERATION></SOURCE_OPERATION>
    <SOURCE_USERID></SOURCE_USERID>
    <DESTINATION>SIEBELCRM</DESTINATION>
  </FCUBS_HEADER>
  <FCUBS_BODY>
    <Cust-Static-Creat-Res-Full>
      <CUSTNO>CU99999</CUSTNO>
      <CTYPE>C</CTYPE>
      <SNAME>NEWCUSTFLEXML102</SNAME>
      <LIABID>CU99999</LIABID>
      <CCATEG>Individual</CCATEG>
      <COUNTRY>IISA</COUNTRY>
    </Cust-Static-Creat-Res-Full>
  </FCUBS_BODY>
</FCUBS_ENVELOPE>
```

3.6.1 Querying Duplicate Message Browser

You can query the list of duplicate messages using the 'Duplicate Message Browser - Summary' screen with functions for search. You can invoke this screen by typing

'GWSPBROW' in the field at the top right corner of the Application tool bar and clicking the adjoining arrow button.

The screenshot shows a web application window titled 'Summary'. At the top, there are 'Advanced Search' and 'Reset' buttons. Below these are two columns of search criteria fields, each with a dropdown arrow icon:

- Message Reference
- External System
- Correlation Id
- Service Name
- User Id
- Server Date Stamp
- Branch
- Message Id
- Request Queue Message Id
- Operation Code
- Their User Id
- Status

Below the search fields is a pagination bar with 'Records per page' set to 15, and buttons for 'First', 'Previous', '1 Of 1', 'Next', 'Last', and 'Go'. Below the pagination bar is a table header with the following columns: Message Reference, Branch, External System, Message Id, Correlation Id, Request Queue Message Id, Service Name, Operation Code, and User Id. The table body is currently empty. At the bottom right of the window is an 'Exit' button.

This query screen can be used to search for duplicate messages which match the criteria (Message Reference Number, External System, Service Name etc) you specify. The 'Result' list shows the messages which match your query. The search functions available are:

Advanced

Click **Advanced** to specify queries with logical operators such as AND, OR and NOT.

Reset

Click **Reset** to empty the values in the criteria fields, so that you may begin a new search.

Query

After specifying your search criteria click **Query** to view the list of results which match your search criteria.

Refresh

Click **Refresh** to refresh the list of results.

3.7 Outgoing Message Browser

Once the incoming messages have been processed, a response message will be sent to the external systems along with the status of the processed messages. The response messages will be displayed in the 'Outgoing Message Browser'. You can invoke the 'Outgoing Message

Browser' screen by typing 'GWDOTBRW' in the field at the top right corner of the Application tool bar and clicking on the adjoining arrow button.

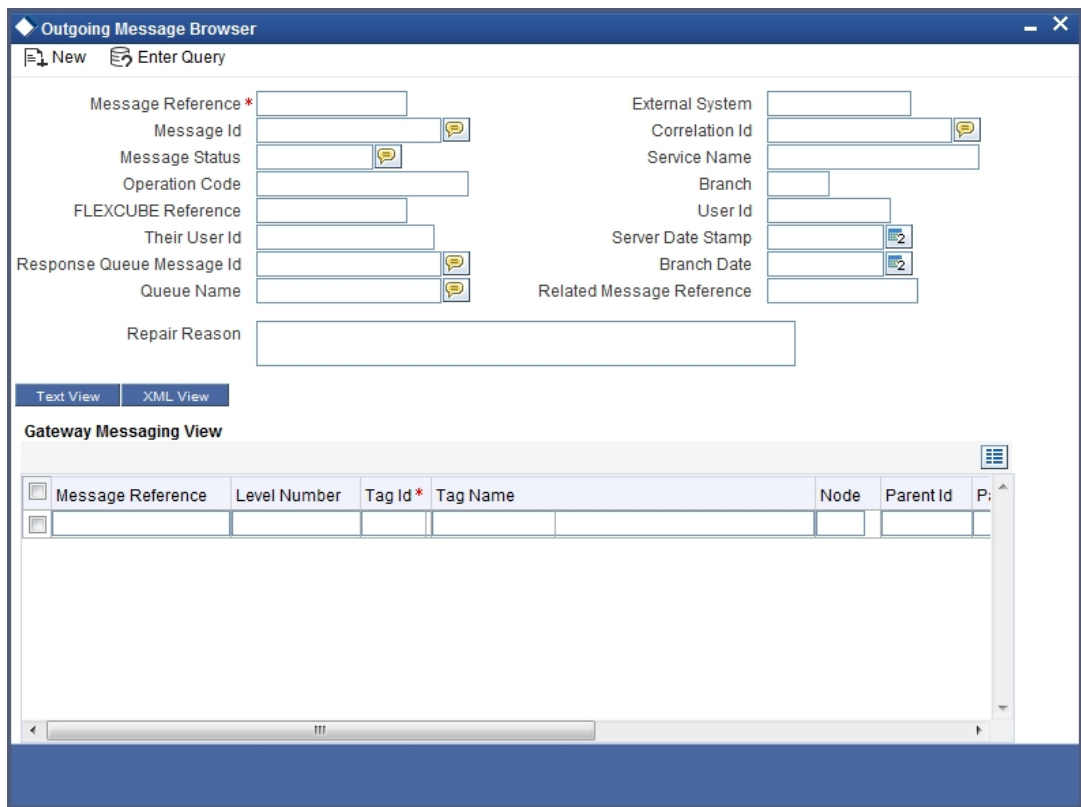

In the 'Outgoing Message Browser' screen you can view the details of the messages sent to the external systems. You can also view the messages in the XML format or the Text format.

Click 'Text View' button to view the response message in text format as shown below:

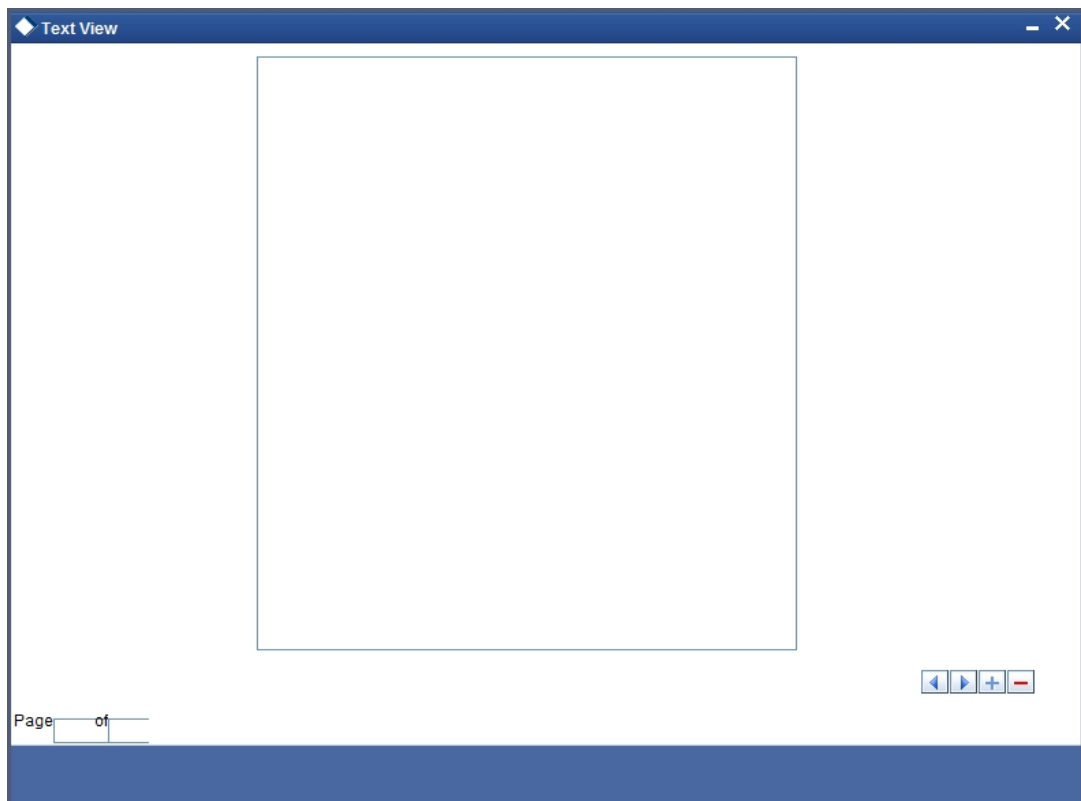

Click 'XML View' button to view the response messages in XML format as shown below:

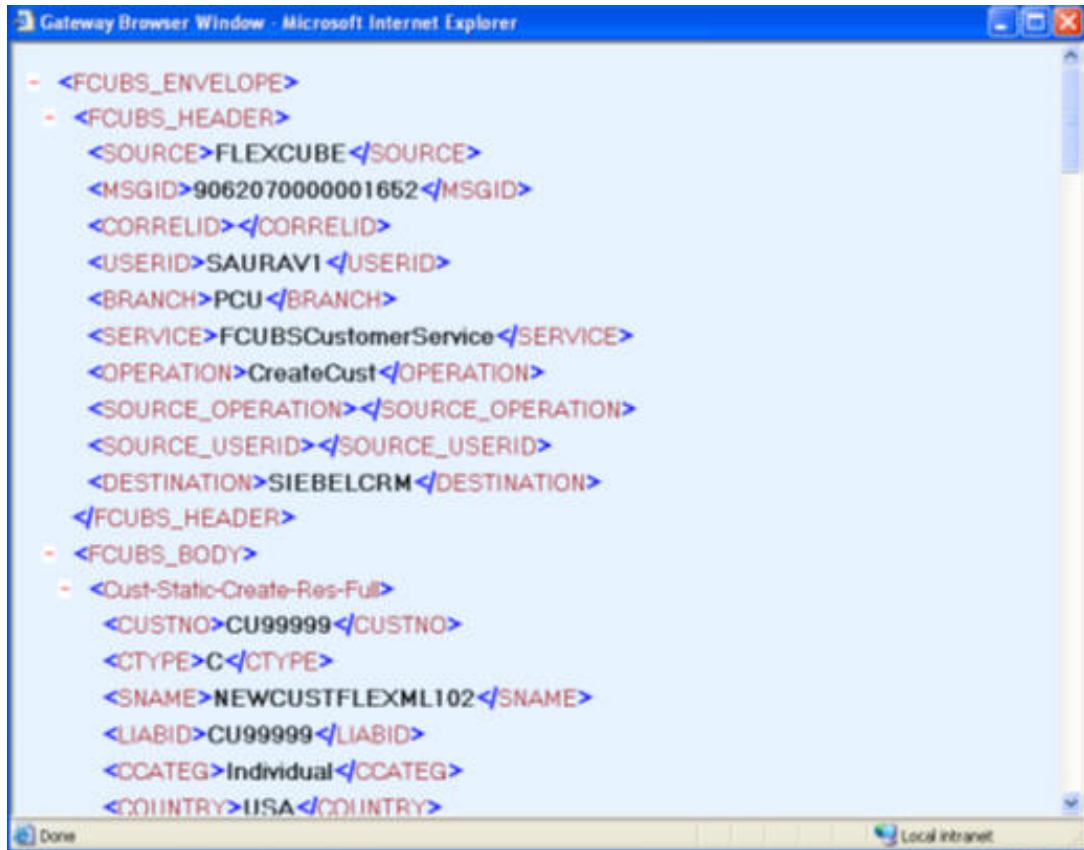

The screenshot shows a Microsoft Internet Explorer window titled "Gateway Browser Window - Microsoft Internet Explorer". The main content area displays XML data in a tree view. The root element is <FCUBS_ENVELOPE>, which contains <FCUBS_HEADER> and <FCUBS_BODY>. The <FCUBS_HEADER> element contains several sub-elements: <SOURCE>FLEXCUBE</SOURCE>, <MSGID>9062070000001652</MSGID>, <CORRELID></CORRELID>, <USERID>SAURAVI</USERID>, <BRANCH>PCU</BRANCH>, <SERVICE>FCUBSCustomerService</SERVICE>, <OPERATION>CreateCust</OPERATION>, <SOURCE_OPERATION></SOURCE_OPERATION>, <SOURCE_USERID></SOURCE_USERID>, and <DESTINATION>SIEBELCRM</DESTINATION>. The <FCUBS_BODY> element contains <Cust-Static-Create-Res-Full>, which in turn contains <CUSTNO>CU99999</CUSTNO>, <CTYPE>C</CTYPE>, <SNAME>NEWCUSTFLEXML102</SNAME>, <LIABID>CU99999</LIABID>, <CCATEG>Individual</CCATEG>, and <COUNTRY>IISA</COUNTRY>. The status bar at the bottom shows "Done" and "Local intranet".

```
- <FCUBS_ENVELOPE>
- <FCUBS_HEADER>
  <SOURCE>FLEXCUBE</SOURCE>
  <MSGID>9062070000001652</MSGID>
  <CORRELID></CORRELID>
  <USERID>SAURAVI</USERID>
  <BRANCH>PCU</BRANCH>
  <SERVICE>FCUBSCustomerService</SERVICE>
  <OPERATION>CreateCust</OPERATION>
  <SOURCE_OPERATION></SOURCE_OPERATION>
  <SOURCE_USERID></SOURCE_USERID>
  <DESTINATION>SIEBELCRM</DESTINATION>
</FCUBS_HEADER>
- <FCUBS_BODY>
- <Cust-Static-Create-Res-Full>
  <CUSTNO>CU99999</CUSTNO>
  <CTYPE>C</CTYPE>
  <SNAME>NEWCUSTFLEXML102</SNAME>
  <LIABID>CU99999</LIABID>
  <CCATEG>Individual</CCATEG>
  <COUNTRY>IISA</COUNTRY>
```

3.7.1 Querying Outgoing Message Browser

You can query the list of outgoing messages using the 'Outgoing Message Browser - Summary' screen. You can invoke this screen by typing 'GWSOTBRW' in the field at the top right corner of the Application tool bar and clicking the adjoining arrow button.

Outgoing Message Browser

Search Advanced Search Reset

Case Sensitive

Message Reference

Related Message Reference

Service Name

Message Id

Response Queue Message Id

Their User Id

Server Date Stamp

Branch

External System

Operation Code

Correlation Id

User Id

Branch Date

Message Status

Records per page 15 First Previous 1 Of 1 Next Last Go Lock Columns 0

Message Reference	Branch	Related Message Reference	External System	Service Name	Operation Code	Message Id	Correlation Id	Response Queue Message Id	User Id
-------------------	--------	---------------------------	-----------------	--------------	----------------	------------	----------------	---------------------------	---------

Exit

This query screen can be used to search for outgoing messages which match the criteria (Message Reference Number, External System, Service Name etc) you specify. The 'Result' list shows the messages which match your query. The search functions available are:

Advanced

Click **Advanced** to specify queries with logical operators such as AND, OR and NOT.

Reset

Click **Reset** to empty the values in the criteria fields, so that you may begin a new search.

Search

Specify your search criteria to view the list of results which match your search criteria.

3.8 Defining Notification Messages

The outgoing message browser also displays the notification messages. Every time the database layer receives a notification message, it updates the outgoing message browser to display the same.

At the branch level, you can maintain notification codes for each branch. You can do this using the 'Notifications Installed' screen.

You can invoke the 'Notifications Installed – Detailed' screen by typing 'GWDNTFIN' in the field at the top right corner of the Application tool bar and clicking the adjoining arrow button.

The screenshot shows a software window titled "Notifications Installed". At the top, there is a menu bar with "New" and "Enter Query" options. Below the menu bar, there are four input fields: "Branch Code *" with a dropdown arrow, "Notification Code *" with a dropdown arrow, "Branch Name" with a help icon, and "Description" with a help icon. At the bottom of the window, there is a "Fields" section with labels for "Input By Date Time", "Authorized By Date Time", and "Modification Number". Below these labels are checkboxes for "Authorized" and "Open", and an "Exit" button.

In this screen, you need to specify the following details:

Branch Code

Select a branch code for which you wish to assign a notification code. Once you select the branch code, the corresponding description is displayed.

Notification Code

From the list of values, select a notification code you wish to link with the branch. This will be used to generate notifications for the entire branch. Once you select the notification code, the corresponding description is displayed.

In addition to maintaining a notification code for a given branch, you can also specify a topic or a queue to which the notification messages should be sent.

You can define a topic/queue for a given branch and notification code in the 'Notifications Enroute' screen.

3.8.1 Viewing Installed Notification Details

You can view and query the list of notification messages using the 'Notifications Installed - Summary' screen. You can invoke this screen by typing 'GWSNTFIN' in the field at the top right corner of the Application tool bar and clicking the adjoining arrow button.

Notifications Installed Summary

Search Advanced Search Reset

Case Sensitive

Authorization Status Record Status

Branch Code Notification Code

Records per page 15 First Previous 1 Of 1 Next Last Go Lock Columns 0

Authorization Status	Record Status	Branch Code	Notification Code
----------------------	---------------	-------------	-------------------

Authorization Status A - Authorized U - Unauthorized

Record Status C - Closed O - Open

Exit

This summary screen can be used to search for notification messages which match the criteria (Message Reference Number, External System, Service Name etc) you specify. The 'Result' list shows the messages which match your query. The search functions available are:

Advanced

Click **Advanced** to specify queries with logical operators such as AND, OR and NOT.

Reset

Click **Reset** to empty the values in the criteria fields, so that you may begin a new search.

Search

Specify your search criteria to view the list of results which match your search criteria.

3.9 Defining the Notifications Enroutes

You can invoke the 'Notification Enroutes - Detailed' screen by typing 'GWDNTFEN' in the field at the top right corner of the Application tool bar and clicking the adjoining arrow button.

The screenshot shows the 'Notification Enroute Maintenance' application window. The window title is 'Notification Enroute Maintenance'. The interface includes a toolbar with 'New' and 'Enter Query' buttons. The main area contains two columns of input fields: 'Branch Code *', 'Description', and 'Destination Name *' on the left; and 'Notification Code *' and 'Description' on the right. A 'Fields' section at the bottom includes 'Input By', 'Date Time', 'Authorized By', 'Date Time', 'Modification Number', 'Authorized', 'Open', and an 'Exit' button.

In 'Notification Enroutes - Detailed' screen, you define the following details:

Branch Code

Specify a branch for which you wish to define a topic. If you want to use a single topic for all branches and for a given notification code, you can use a wildcard '****'. Once you select a Branch Code, the corresponding description is displayed.

Notification Code

Select a notification code from the list of notification codes provided. You can indicate a wildcard '****' if a single topic needs to be used for all notifications in a branch.

Destination Name

Specify the destination name.

Once you have captured the details, save the maintenance.

3.9.1 Viewing Summary screen

You can view and query the list of notifications enroute using the 'Notifications Enroutes - Summary' screen. You can invoke this screen by typing 'GWSNTFEN' in the field at the top right corner of the Application tool bar and clicking the adjoining arrow button.

Notifications En route Summary

Search Advanced Search Reset

Case Sensitive

Authorization Status Record Status

Branch Code Notification Code

Destination Name

Records per page 15 First Previous 1 Of 1 Next Last Go Lock Columns 0

Authorization Status	Record Status	Branch Code	Notification Code	Destination Name
----------------------	---------------	-------------	-------------------	------------------

Authorization Status A - Authorized U - Unauthorized

Record Status C - Closed O - Open

Exit

This summary screen can be used to search for notifications enroute which match the criteria (Message Reference Number, External System, Service Name etc) you specify. The 'Result' list shows the messages which match your query. The search functions available are:

Advanced

Click **Advanced** to specify queries with logical operators such as AND, OR and NOT.

Reset

Click **Reset** to empty the values in the criteria fields, so that you may begin a new search.

Search

Specify your search criteria to view the list of results which match your search criteria.

3.10 Maintaining MT Task Details

Using the 'Gateway Maintenance Detailed' screen, you can maintain the basis for creation of MT tasks for Gateway message. You can invoke this screen by typing 'STDGWINT' in the field at the top right corner of the Application tool bar and clicking the adjoining arrow button.

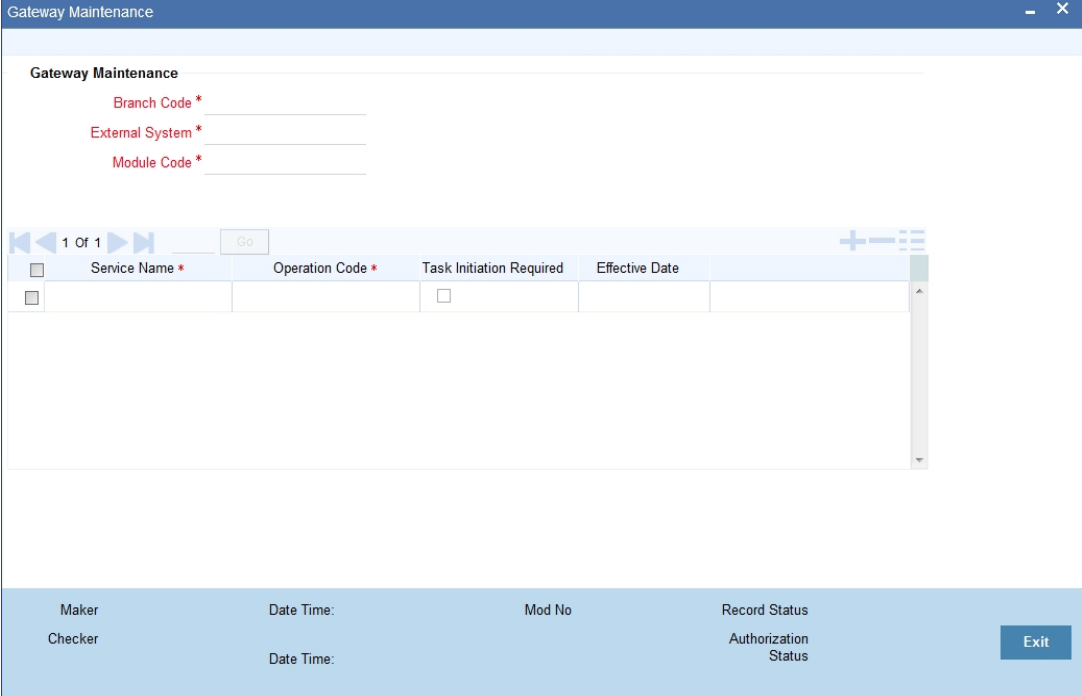

In this screen, you can specify the following details:

Branch Code

Specify the branch code of the bank. This adjoining option list displays all valid branches maintained in the system. You can choose the appropriate one.

External System

Specify the name of the external system. This adjoining option list displays all the external systems maintained in the system. You can choose the appropriate one.

Module Code

Specify the module name. This adjoining option list displays all the modules maintained in the system. You can choose the appropriate one.

Service Name

Specify the service name of the module selected. This adjoining option list displays all the service names maintained in the system. You can choose the appropriate one.

Operation code

Specify the operation code of the service. This adjoining option list displays all valid operation codes maintained in the system. You can choose the appropriate one.

Effective Date

Specify the date from which the gateway message maintenance becomes effective. Effective date should be equal to or greater than the application date.

3.11 Amendment Maintenance

This section contains the following topics:

- [Section 3.11.1, "Maintaining Gateway Amendment Details"](#)

3.11.1 Maintaining Gateway Amendment Details

To recall, you need to identify the fields that can be amended by an external system, say, a Siebel CRM application.

Every amendment request coming from such a system has the following data:

- **Service Name:** – This is a broad level grouping of similar operations within a module in Oracle FLEXCUBE. The service names are published by Oracle FLEXCUBE. As an example, you can consider FCUBSCustomerAccountService. This service is exposed by the FCUBS Interface Gateway to do a permissible operation on a customer account.
- **Operation Name:-** This is the name of the operation that the external system wishes to perform within the service. These operations names are published by Oracle FLEXCUBE. As an example, you can consider ModifyCustomer, which is for modification of a customer.
- **External Operation Name:-** This is the specific area of operation that an external system is performing on its side within the broad context of the Oracle FLEXCUBE's amendment. In an external system, if the personal details of a customer are changed, this has a unique name by which it is identified within Oracle FLEXCUBE. Similarly, if the limits related details of a customer are modified, it also has a unique name.

It is through the 'Gateway Amendment Maintenance' screen that you maintain a set of amendable fields, which can amend in Oracle FLEXCUBE whenever a request for the same will be send from an external system. Based on this maintenance, the amendment request is addressed by Oracle FLEXCUBE. Invoke this screen by typing 'GWDAMDMT' in the field at

the top right corner of the Application tool bar and clicking the adjoining arrow button. The screen is as shown below:

The screenshot shows the 'Gateway Amendment Maintenance' application window. At the top, there is a 'New' section with the following fields: 'External System*' (required), 'Origin System*' (required), 'Source Operation*' (required), 'Service Name', and 'Operation Code'. Below this is the 'Amendable Nodes' section, which includes a table with the following columns: 'Node Name*' (required), 'New Allowed', 'LBL_DELETE_ALLOWED', and 'All Records'. The table contains one row with checkboxes in the 'New Allowed', 'LBL_DELETE_ALLOWED', and 'All Records' columns. Below the table is the 'Amendable Fields' section, which includes a table with the following columns: 'Field Name*' (required). At the bottom of the window, there are fields for 'Maker', 'Checker', 'Date Time', 'Mod No', 'Record Status', and 'Authorization Status', along with an 'Exit' button.

External System

Select the relevant external system. Based on the maintenance here, only the fields that are selected as amendable can be modified if a request comes from the chosen external system.

Note

The maintenance pertaining to external systems is factory shipped for your bank.

Origin System

Specify the origin system for which the amendment details are applicable.

For example, if we have a record that is created by a specific external system say 'CRM', and the requirement is that, for records created by this specific external system, only a set of fields are modifiable then, we should specify Origin System as CRM and FLEXCUBE as the External System. This Origin System field is used to identify such requirements wherein the amendable fields can be different if the Origination and Modification of the record are of different external sources.

You can specify the Origin System with the same value as the External System for Non FP services. For FP module services, you can provide the value as 'FLEXCUBE' and the respective External system can be specified in the External System field.

This feature is made available only for the FP modules with source operation as PMDTRONL_MODIFY.

Source Operation

The free format text (without spaces) which identifies the amendment you are doing. This is mandatory.

Note

Source Operation will be defaulted as (FUNCTIONID)_MODIFY, if the Source Operation is not sent from an external system and the function ID will be derived from Service and Operation combination.

Service Name

The relevant service name, this is a broad level grouping of similar operations within a module in Oracle FLEXCUBE. The service names are published by Oracle FLEXCUBE.

Note

The maintenance pertaining to service names is factory shipped for your bank

Operation Code

The relevant operation code. This is the operation that the external system wishes to perform within the selected service. The operation names are published by Oracle FLEXCUBE. As an example, you can take 'ModifyCustomer', which is for modification of a customer record. Each operation under different service names is identified by a unique code.

Note

The maintenance pertaining to operation codes is factory shipped for your bank.

Amendable Nodes

Node Name

Specify the node name. Alternatively, you can select the node name from the option list. The list displays all valid nodes maintained in the system.

New Allowed

Check this box if 'New Allowed' is applicable.

Delete Allowed

Check this box if 'Delete Allowed' is applicable.

All Records

Check this box if all records are applicable.

3.12 Gateway Maintenance for Approot Deployment

This section contains the following topics:

- [Section 3.12.1, "Maintaining Gateway for Approot Deployment"](#)

3.12.1 Maintaining Gateway for Approot Deployment

The following function IDs are used for the gateway maintenance for Approot deployment. The function IDs detail and their descriptions are listed below:

Function ID	Summary Function ID	Description
CODAPSRC	COSAPSRC	Upload Source Maintenance

CODAPUPL	COSAPUPL	Upload Source Preferences Maintenance
GWDAPEFN	GWSAPEFN	Gateway Amendment Maintenance
GWDAPAMD	GWSAPAMD	External System Functions
GWDAPESY	GWSAPESY	External System Maintenance

4. Message Formats

4.1 Introduction

Data exchanged between Oracle FLEXCUBE and the external systems will be in the form of XML messages. These XML messages are defined in FCUBS in the form of XML Schema Documents (XSD) and are referred to as 'FCUBS formats'. An XML Schema is uniquely identified by its Namespace and its Root Element (root node). The root node for XSDs of gateway messages will be generated as per the following pattern:

- <OPERATION>_<MESSAGE EXCHANGE PATTERN>_REQ
- <OPERATION>_<MESSAGE EXCHANGE PATTERN>_RES
- Where
- <OPERATION> refers to an Oracle FLEXCUBE operation like CREATECUSTACC
- <MESSAGE_EXCHANGE_PATTERN> refers to the request & response message patterns exchanged. The Message Pattern is of the following types
 - FS (Full Screen) - This indicates that the payload will contain all the elements on the corresponding Oracle FLEXCUBE screen.
 - IO (Input Only) - This indicates that the payload will contain the only input elements on the corresponding Oracle FLEXCUBE screen.
 - PK (Primary Key): This indicates that the payload will contain only the Primary Key elements of the corresponding Oracle FLEXCUBE screen.

<MESSAGE_EXCHANGE_PATTERN> is a combination of message patterns. The <MESSAGE_EXCHANGE_PATTERN> available in FLEXCUBE is shown below:

- FSFS - Full Screen Request and Full Screen Response
- IOPK - Input Only Request and Primary Key Response
- IOFS - Input Only Request and Full Screen Response

Non-Query Formats

For example, consider the Operation 'CREATECUSTACC'. The root node of messages under this operation will be as under:

- CREATECUSTACC_FSFS_REQ

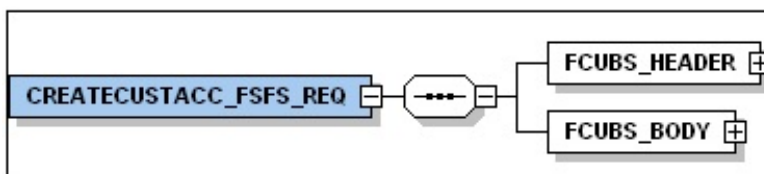

- CREATECUSTACC_FSFS_RES

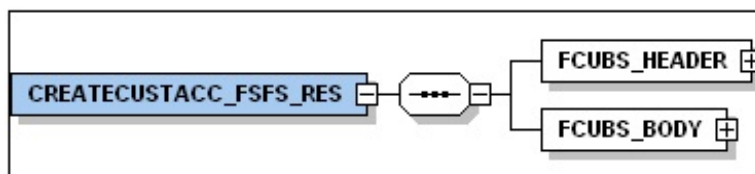

- CREATECUSTACC_IOPK_REQ

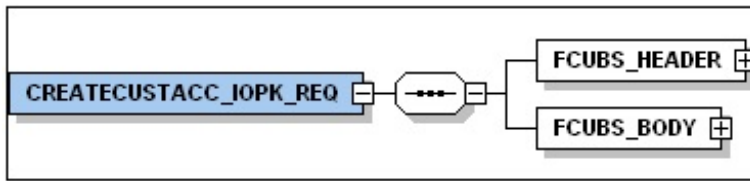

- CREATECUSTACC_IOPK_RES

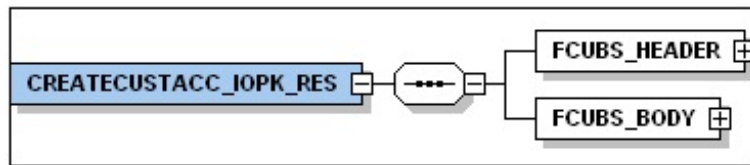

Query Formats

For example, consider the Operation 'QUERYCUSTACC'. The root node of messages under this operation will be as under:

- QUERYCUSTACC_IOFS_REQ

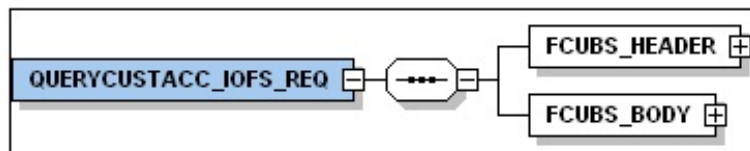

- QUERYCUSTACC_IOFS_RES

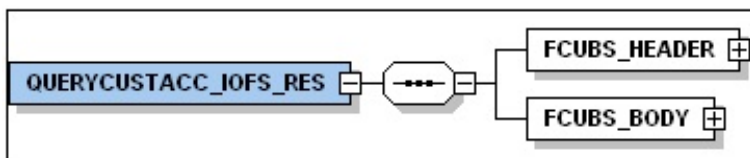

This chapter contains the following sections

- [Section 4.2, "Oracle FLEXCUBE Envelope"](#)
- [Section 4.3, "Oracle FLEXCUBE NOTIFICATION"](#):

4.2 Oracle FLEXCUBE Envelope

This section contains the following topics:

- [Section 4.2.1, "FCUBS HEADER"](#)
- [Section 4.2.2, "FCUBS_BODY"](#)

A standard gateway message in the Oracle FLEXCUBE Envelope contains two main components namely:

- FCUBS_HEADER – This is a node that forms the header of the FCUBS Envelope. The tags under the header portion of a message will identify a partner system, a service, an operation, user, branch, etc. These tags are constant across all messages.

- FCUBS_BODY – This node contains the actual payload of a message. The contents of this node will vary for each message.

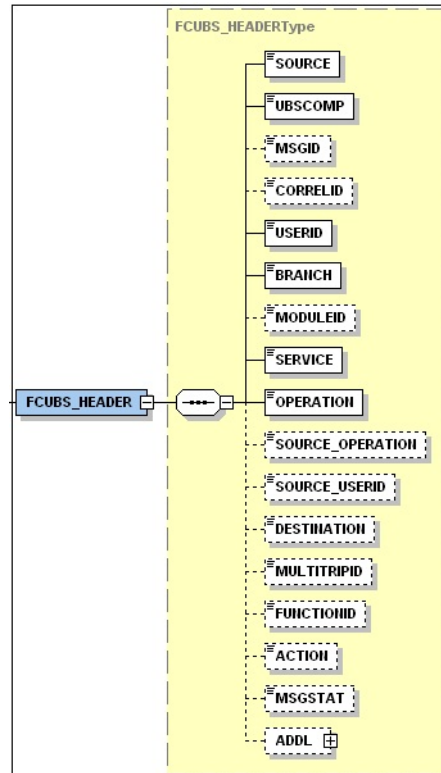

4.2.1 **FCUBS HEADER**

The tags under FCUBS HEADER have been described below:

SOURCE

This indicates the name of the External system that is the source of the message.

UBSCOMP

This indicates the Oracle FLEXCUBE component of the message - whether FCIS or FCUBS

MSGID

This unique ID identifies each message – incoming or outgoing in Oracle FLEXCUBE. Every message will have a distinct message ID.

CORRELID

This is the id using which any system which has sent a request to FC UBS can correlate to the response. In the External system maintenance, the Correlation Pattern can be configured for each external system. It can be maintained that either the 'MSGID' or the 'CORRELID' of the request message is returned back as the 'CORRELID' in the response message. Depending on this maintenance, Oracle FLEXCUBE will set either the 'MSGID' or the 'CORRELID' of the request message in the response message.

USERID

For request messages, this ID is used to submit message requests. Oracle FLEXCUBE will process this request using this id.

For response messages, the value of this will be 'null'.

BRANCH

This indicates the Oracle FLEXCUBE Branch Code where the request message needs to be processed. If the BRANCH is missing in the header, request message will be transmitted and processed in Head Office branch.

MODULEID

This indicates the module ID.

SERVICE

This provides details on the various services of Oracle FLEXCUBE. For every incoming message in Oracle FLEXCUBE, the service name is mandatory.

OPERATION

This indicates the functional operation.

SOURCE_OPERATION

This indicates the functional operation as registered in Oracle FLEXCUBE.

SOURCE_USERID

This is the User ID with which the request message was invoked from the SOURCE.

DESTINATION

For incoming messages, the destination will be Oracle FLEXCUBE. For response messages, system will populate the SOURCE of the request message as DESTINATION.

MULTIRIPID

This is a unique id which indicates overrides.

FUNCTIONID

This indicates the Oracle FLEXCUBE Function ID

MSGSTAT

This indicates whether the transaction is a SUCCESS or FAILURE.

ADDL

This is used to send additional parameters i.e. parameters not available in Oracle FLEXCUBE.

4.2.2 FCUBS_BODY

The FCUBS_BODY will contain the actual payload to perform the respective transaction. The contents of the payload will vary for each operation.

The following snapshot shows a sample FCUBS_BODY of QUERYCUSTACC operation.

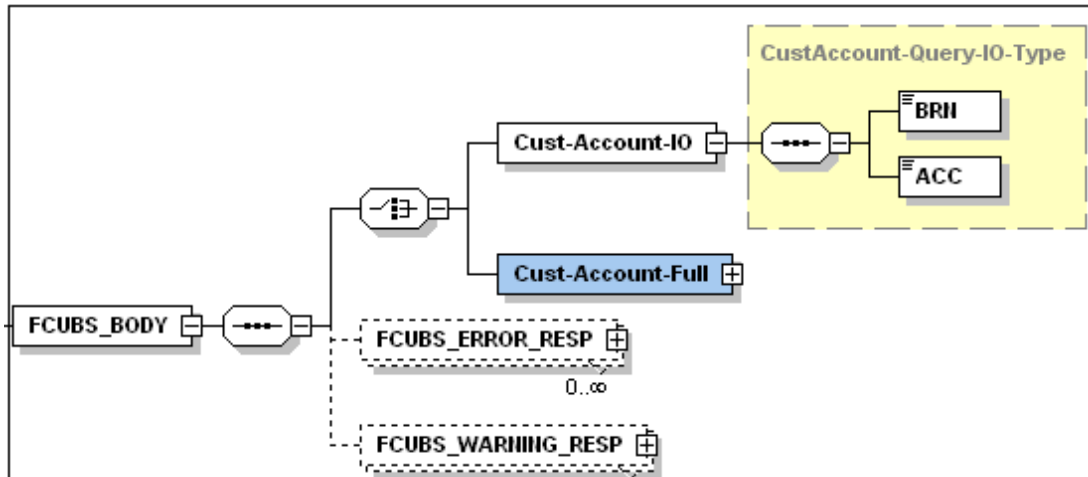

FCUBS_BODY will contain additional nodes for error response and warning response. A diagrammatic representation of the Error response is as shown below:

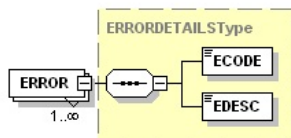
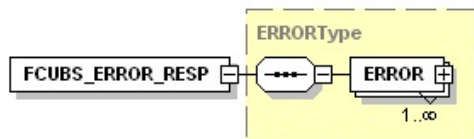

4.2.2.1 FCUBS_ERROR_RESP

The error response message will be sent from Oracle FLEXCUBE when errors are raised in a transaction. The error response will have another tag 'ERROR' within it.

ERROR

The 'ERROR' node will have tags for error code and error description. The 'ERROR' node will be generated for each error raised by FCUBS.

4.2.2.2 FCUBS_WARNING_RESP

The warning response message will be sent when overrides are raised in a transaction. The Warning response will have another tag 'WARNING' within it.

WARNING

This node will have tags for warning code and warning description. The 'WARNING' node will be generated for each override raised by FCUBS.

4.3 Oracle FLEXCUBE NOTIFICATION

The notification messages are generated in a standard format. The notification messages will consist of two main components:

FCUBS_NOTIF_HEADER – This forms the header portion of a notification message. This contains a standard set of tags that can identify a notification. These tags are constant across all notification messages.

FCUBS_NOTIF_IDENTIFIER – This will identify the maintenance records based on the information provided under this node. The contents of this node will vary for each notification.

A diagrammatic representation of FCUBS NOTIFICATION is as shown below:

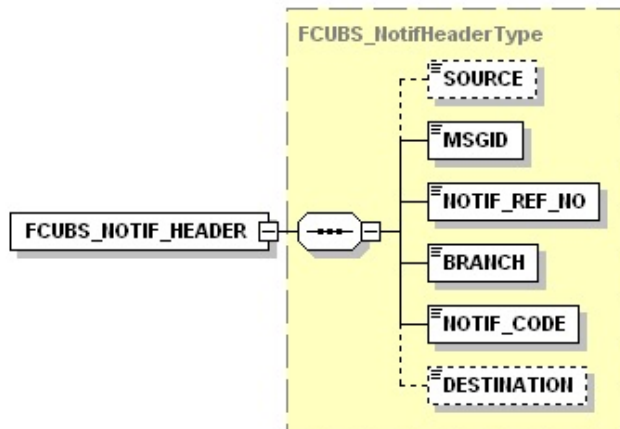
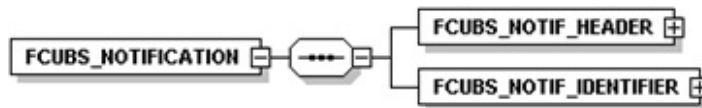

4.3.1 FCUBS NOTIFICATION HEADER

The tags under FCUBS NOTIFICATION HEADER have been described below:

SOURCE

This indicates the name of the External system or the source of the message.

MSGID

This is the unique reference number generated by Oracle FLEXCUBE.

NOTIF_REF_NO.

This unique reference number identifies each notification message generated in Oracle FLEXCUBE.

BRANCH

This indicates the branch in which notification has been triggered.

NOTIF_CODE

This indicates the code for the notification that has been triggered.

DESTINATION

For incoming messages, the DESTINATION should be Oracle FLEXCUBE. For response messages, system will populate the SOURCE of the request message as DESTINATION.

Refer 'Service-Documentation' available under 'Gateway' for details about each message.

5. Annexure – List of Messages

5.1 Introduction

This chapter lists out the various messages that fold under the purview of the following Gateway services:

- Inbound application integration – used when any external system needs to add, modify or query information within Oracle FLEXCUBE
- Outbound application integration – used when any external system needs to be notified of the various events that occur within Oracle FLEXCUBE.

5.2 Inbound Application Integration – Services

Oracle FLEXCUBE UBS Inbound Application Gateway provides XML based 'Services'. These services consist of one or more 'Operations'. These operations can be invoked by any external system to perform the relevant operation in Oracle FLEXCUBE UBS.

This chapter contains the following sections:

- [Section 5.2.1, "FCUBSAccService"](#)
- [Section 5.2.2, "FCUBSLD Service"](#)
- [Section 5.2.3, "FCUBSCustomerService"](#)
- [Section 5.2.4, "FCUBSTDSERVICE"](#)
- [Section 5.2.5, "FCUBSIFService"](#)
- [Section 5.2.6, "FCUBSInteractionservice"](#)
- [Section 5.2.7, "FCUBSICService"](#)
- [Section 5.2.8, "FCUBSSTService"](#)
- [Section 5.2.9, "FCUBSIAService"](#)
- [Section 5.2.10, "FCUBSRTService"](#)

5.2.1 FCUBSAccService

All account operations are logically grouped under a service called 'FCUBSAccService'.

Oracle FLEXCUBE supports the following operations under this service:

- CheckBookNew
- CheckBookModify
- CheckBookQuery
- CreateTDSim
- QueryGenAdvice
- Create TD CustAcc
- Modify TD CustAcc
- Authorize TD CustAcc
- Delete TD Cust Acc
- Query TDCustAcc
- CreateTDTopUp

- AuthorizeTDTopUp
- DeleteTDTopUp
- ModifyTDTopUp
- QueryCustAcc

5.2.1.1 **CheckBookNew**

This is the operation code for creating new Cheque Book in Oracle FLEXCUBE. It involves the following messages:

- CheckBookNew-Req-Full- This is the request message to create new cheque book in Oracle FLEXCUBE UBS. An external system which intends to create a new cheque book has to send the request in the format specified. The format of the message is called 'Full-screen', which includes all the fields (input fields and the display fields) as in the corresponding Oracle FLEXCUBE front-end screen.
- CheckBookNew -Req-IO- This is the request message to create new cheque book in Oracle FLEXCUBE UBS. An external system which intends to create the cheque book has to send the request in the specified format. The format of the message is called 'Input-only', which has only those fields that are actually required for creating a new cheque book.
- CheckBookNew -Res-Full- This is the response message which is sent back to the external system when a new cheque book is successfully created in Oracle FLEXCUBE UBS. The format of the message is called 'Full-screen response', which includes all the fields (input fields and the display fields) as in the corresponding Oracle FLEXCUBE screen.
- CheckBookNew -Res-PK- This is the response message which is sent back to the external system when anew cheque book is successfully created in Oracle FLEXCUBE UBS. The format of the message is called 'Primary-Key response', which includes only the primary key fields of the cheque book record in the Oracle FLEXCUBE data store.

5.2.1.2 **CheckBookModify**

This is the operation code for modifying new Cheque Book in Oracle FLEXCUBE. It involves the following messages:

- CheckBookModify-Req-Full- This is the request message to modify a cheque book in Oracle FLEXCUBE UBS. An external system which intends to modify a cheque book has to send the request in the format specified. The format of the message is called 'Full-screen', which includes all the fields (input fields and the display fields) as in the corresponding Oracle FLEXCUBE front-end screen.
- CheckBookModify-Req-IO- This is the request message to modify a cheque book in Oracle FLEXCUBE UBS. An external system which intends to modify a cheque book has to send the request in the specified format. The format of the message is called 'Input-only', which has only those fields that are actually required for modifying a cheque book.
- CheckBookModify -Res-Full- This is the response message which is sent back to the external system when a cheque book is successfully modified in Oracle FLEXCUBE UBS. The format of the message is called 'Full-screen response', which includes all the fields (input fields and the display fields) as in the corresponding Oracle FLEXCUBE screen.
- CheckBookModify -Res-PK- This is the response message which is sent back to the external system when a cheque book is successfully modified in Oracle FLEXCUBE UBS. The format of the message is called 'Primary-Key response', which includes only the primary key fields of the cheque book in the Oracle FLEXCUBE data store.

5.2.1.3 CheckBookQuery

This is the operation code for querying new Cheque Book in Oracle FLEXCUBE. It involves the following messages:

- CheckBookQuery-Req-Full- This is the request message to query a cheque book in Oracle FLEXCUBE UBS. An external system which intends to query a cheque book has to send the request in the format specified. The format of the message is called 'Full-screen', which includes all the fields (input fields and the display fields) as in the corresponding Oracle FLEXCUBE front-end screen.
- CheckBookQuery-Req-IO- This is the request message to query a cheque book in Oracle FLEXCUBE UBS. An external system which intends to query a cheque book has to send the request in the specified format. The format of the message is called 'Input-only', which has only those fields that are actually required for querying a cheque book.
- CheckBookQuery -Res-Full- This is the response message which is sent back to the external system when a cheque book is successfully queried in Oracle FLEXCUBE UBS. The format of the message is called 'Full-screen response', which includes all the fields (input fields and the display fields) as in the corresponding Oracle FLEXCUBE screen.
- CheckBookQuery -Res-PK- This is the response message which is sent back to the external system when a cheque book is successfully queried in Oracle FLEXCUBE UBS. The format of the message is called 'Primary-Key response', which includes only the primary key fields of the cheque book in the Oracle FLEXCUBE data store.

5.2.1.4 CreateTDSim

This is the operation code for creating TD simulation in Oracle FLEXCUBE. It involves the following messages:

- CreateTDSim-Req-Full- This is the request message to create TD simulation in Oracle FLEXCUBE UBS. An external system which intends to TD simulation has to send the request in the format specified. The format of the message is called 'Full-screen', which includes all the fields (input fields and the display fields) as in the corresponding Oracle FLEXCUBE front-end screen.
- CreateTDSim -Req-IO- This is the request message to create TD simulation in Oracle FLEXCUBE UBS. An external system which intends to TD simulation has to send the request in the specified format. The format of the message is called 'Input-only', which has only those fields that are actually required for creating TD simulation.
- CreateTDSim -Res-Full- This is the response message which is sent back to the external system when a TD simulation is successfully created in Oracle FLEXCUBE UBS. The format of the message is called 'Full-screen response', which includes all the fields (input fields and the display fields) as in the corresponding Oracle FLEXCUBE screen.
- CreateTDSim -Res-PK- This is the response message which is sent back to the external system when a TD simulation is successfully created in Oracle FLEXCUBE UBS. The format of the message is called 'Primary-Key response', which includes only the primary key fields of the TD simulation in the Oracle FLEXCUBE data store.

5.2.1.5 QueryGenAdvice

This is the operation code for querying GenAdvice in Oracle FLEXCUBE. It involves the following messages:

- QueryGenAdvice -Req-IO- This is the request message to query GenAdvice in Oracle FLEXCUBE UBS. An external system which intends to query GenAdvice has to send the request in the specified format. The format of the message is called 'Input-only', which has only those fields that are actually required for querying GenAdvice.

- QueryGenAdvice -Res-Full- This is the response message which is sent back to the external system when GenAdvice is successfully queried in Oracle FLEXCUBE UBS. The format of the message is called 'Full-screen response', which includes all the fields (input fields and the display fields) as in the corresponding Oracle FLEXCUBE screen.

5.2.1.6 CreateTDCustAcc

This is the operation code for creating TD in Oracle FLEXCUBE. It involves the following messages:

- CreateTDCustAcc-Req-Full- This is the request message to create TD in Oracle FLEXCUBE UBS. An external system which intends to create TD has to send the request in the format specified. The format of the message is called 'Full-screen', which includes all the fields (input fields and the display fields) as in the corresponding Oracle FLEXCUBE front-end screen.
- CreateTDCustAcc -Req-IO- This is the request message to create TD in Oracle FLEXCUBE UBS. An external system which intends to createTD has to send the request in the specified format. The format of the message is called 'Input-only', which has only those fields that are actually required for creating a TD.
- CreateTDCustAcc -Res-Full- This is the response message which is sent back to the external system when a TD is successfully created in Oracle FLEXCUBE UBS. The format of the message is called 'Full-screen response', which includes all the fields (input fields and the display fields) as in the corresponding Oracle FLEXCUBE screen.
- CreateTDCustAcc -Res-PK- This is the response message which is sent back to the external system when a TD is successfully created in Oracle FLEXCUBE UBS. The format of the message is called 'Primary-Key response', which includes only the primary key fields of the TD creation in the Oracle FLEXCUBE data store.

5.2.1.7 AuthorizeTDCustAcc

This is the operation code for authorizing the TD in Oracle FLEXCUBE. It involves the following messages:

- AuthorizeTDCustAcc-Req-Full- This is the request message to authorize TD in Oracle FLEXCUBE UBS. An external system which intends to authorize a TD has to send the request in the format specified. The format of the message is called 'Full-screen', which includes all the fields (input fields and the display fields) as in the corresponding Oracle FLEXCUBE front-end screen.
- AuthorizeTDCustAcc -Req-IO- This is the request message to authorize TD in Oracle FLEXCUBE UBS. An external system which intends to authorize a TD has to send the request in the specified format. The format of the message is called 'Input-only', which has only those fields that are actually required for creating TD simulation.
- AuthorizeTDCustAcc -Res-Full- This is the response message which is sent back to the external system when a TD is successfully authorized in Oracle FLEXCUBE UBS. The format of the message is called 'Full-screen response', which includes all the fields (input fields and the display fields) as in the corresponding Oracle FLEXCUBE screen.
- AuthorizeTDCustAcc -Res-PK- This is the response message which is sent back to the external system when a TD is successfully authorized in Oracle FLEXCUBE UBS. The format of the message is called 'Primary-Key response', which includes only the primary key fields of the TD authorization in the Oracle FLEXCUBE data store.

5.2.1.8 DeleteTDCustAcc

This is the operation code for deleting a TD in Oracle FLEXCUBE. It involves the following messages:

- DeleteTDCustAcc-Req-Full- This is the request message to delete TD in Oracle FLEXCUBE UBS. An external system which intends to delete a TD has to send the

request in the format specified. The format of the message is called 'Full-screen', which includes all the fields (input fields and the display fields) as in the corresponding Oracle FLEXCUBE front-end screen.

- DeleteTDCustAcc -Req-IO- This is the request message to delete TD in Oracle FLEXCUBE UBS. An external system which intends to delete a TD has to send the request in the specified format. The format of the message is called 'Input-only', which has only those fields that are actually required for creating TD simulation.
- DeleteTDCustAcc -Res-Full- This is the response message which is sent back to the external system when a TD is successfully deleted in Oracle FLEXCUBE UBS. The format of the message is called 'Full-screen response', which includes all the fields (input fields and the display fields) as in the corresponding Oracle FLEXCUBE screen.
- DeleteTDCustAcc -Res-PK- This is the response message which is sent back to the external system when a TD is successfully deleted in Oracle FLEXCUBE UBS. The format of the message is called 'Primary-Key response', which includes only the primary key fields of the TD deletion in the Oracle FLEXCUBE data store.

5.2.1.9 Query TDCustAcc

This is the operation code for querying TD account in Oracle FLEXCUBE. It involves the following messages:

- QueryTDCustAcc -Req-IO- This is the request message to query a TD account in Oracle FLEXCUBE UBS. An external system which intends to query TD account has to send the request in the specified format. The format of the message is called 'Input-only', which has only those fields that are actually required for querying a TD account
- QueryTDCustAcc -Res-Full- This is the response message which is sent back to the external system when TD account is successfully queried in Oracle FLEXCUBE UBS. The format of the message is called 'Full-screen response', which includes all the fields (input fields and the display fields) as in the corresponding Oracle FLEXCUBE screen.

5.2.1.10 CreateTDTopUp

This is the operation code for doing a top-up of TD in Oracle FLEXCUBE. It involves the following messages:

- CreateTDTopUp-Req-Full- This is the request message to top-up TD account in Oracle FLEXCUBE UBS. An external system which intends to top-up a TD account has to send the request in the format specified. The format of the message is called 'Full-screen', which includes all the fields (input fields and the display fields) as in the corresponding Oracle FLEXCUBE front-end screen.
- CreateTDTopUp -Req-IO- This is the request message to top-up TD account in Oracle FLEXCUBE UBS. An external system which intends to top-up TD account has to send the request in the specified format. The format of the message is called 'Input-only', which has only those fields that are actually required for topping up a TD.
- CreateTDTopUp -Res-Full- This is the response message which is sent back to the external system when a TD account is successfully topped-up in Oracle FLEXCUBE UBS. The format of the message is called 'Full-screen response', which includes all the fields (input fields and the display fields) as in the corresponding Oracle FLEXCUBE screen.
- CreateTDTopUp-Res-PK- This is the response message which is sent back to the external system when a TD account is successfully topped-up in Oracle FLEXCUBE UBS. The format of the message is called 'Primary-Key response', which includes only the primary key fields of the top-up in the Oracle FLEXCUBE data store.

5.2.1.11 AuthorizeTDTopUp

This is the operation code for authorizing top-up request of TD in Oracle FLEXCUBE. It involves the following messages:

- AuthorizeTDTopUp-Req-Full- This is the request message to authorize the top-up of TD account in Oracle FLEXCUBE UBS. An external system which intends to authorize the top-up has to send the request in the format specified. The format of the message is called 'Full-screen', which includes all the fields (input fields and the display fields) as in the corresponding Oracle FLEXCUBE front-end screen.
- AuthorizeTDTopUp -Req-IO- This is the request message to authorize the top-up of TD account in Oracle FLEXCUBE UBS. An external system which intends to authorize the top-up of TD account has to send the request in the specified format. The format of the message is called 'Input-only', which has only those fields that are actually required for topping up a TD.
- AuthorizeTDTopUp -Res-Full- This is the response message which is sent back to the external system when a TD account is topped-up is successfully authorized in Oracle FLEXCUBE UBS. The format of the message is called 'Full-screen response', which includes all the fields (input fields and the display fields) as in the corresponding Oracle FLEXCUBE screen.
- AuthorizeTDTopUp -Res-PK- This is the response message which is sent back to the external system when a TD account top-up, is authorized in Oracle FLEXCUBE UBS. The format of the message is called 'Primary-Key response', which includes only the primary key fields of the top-up in the Oracle FLEXCUBE data store.

5.2.1.12 DeleteTDTopUp

This is the operation code for deleting top-up request of TD in Oracle FLEXCUBE. It involves the following messages:

- DeleteTDTopUp-Req-Full- This is the request message to delete the top-up of TD account in Oracle FLEXCUBE UBS. An external system which intends to delete the top-up request created has to send the request in the format specified. The format of the message is called 'Full-screen', which includes all the fields (input fields and the display fields) as in the corresponding Oracle FLEXCUBE front-end screen.
- DeleteTDTopUp -Req-IO- This is the request message to delete the top-up of TD account in Oracle FLEXCUBE UBS. An external system which intends to delete the top-up of TD account has to send the request in the specified format. The format of the message is called 'Input-only', which has only those fields that are actually required for top-up of a TD.
- DeleteTDTopUp -Res-Full- This is the response message which is sent back to the external system when a top-up request is successfully deleted in Oracle FLEXCUBE UBS. The format of the message is called 'Full-screen response', which includes all the fields (input fields and the display fields) as in the corresponding Oracle FLEXCUBE screen.
- DeleteTDTopUp -Res-PK- This is the response message which is sent back to the external system when a top-up request is deleted from Oracle FLEXCUBE UBS. The format of the message is called 'Primary-Key response', which includes only the primary key fields of the top-up in the Oracle FLEXCUBE data store.

5.2.1.13 ModifyTDTopUp

This is the operation code for modifying account structure in Oracle FLEXCUBE. It involves the following messages:

- ModifyTDTopUp-Req-Full- This is the request message to modify a TD top-up in Oracle FLEXCUBE UBS. An external system which intends to modify a TD top-up has to send

the request in the format specified. The format of the message is called 'Full-screen', which includes all the fields (input fields and the display fields) as in the corresponding Oracle FLEXCUBE front-end screen.

- ModifyTDTopUp-Req-IO- This is the request message to modify a TD top-up in Oracle FLEXCUBE UBS. An external system which intends to modify a TD top-up has to send the request in the specified format. The format of the message is called 'Input-only', which has only those fields that are actually required for modifying a TD top-up.
- ModifyTDTopUp -Res-Full- This is the response message which is sent back to the external system when modifying a TD top-up is successfully modified in Oracle FLEXCUBE UBS. The format of the message is called 'Full-screen response', which includes all the fields (input fields and the display fields) as in the corresponding Oracle FLEXCUBE screen.
- ModifyTDTopUP -Res-PK- This is the response message which is sent back to the external system when modifying a TD top-up is successfully modified in Oracle FLEXCUBE UBS. The format of the message is called 'Primary-Key response', which includes only the primary key fields of the modifying a TD top-up in the Oracle FLEXCUBE data store.

5.2.1.14 QueryCustAcc

This service is used by external channels to retrieve customer account details from the Oracle FLEXCUBE Universal Banking System:

- QueryCustAcc -Req-IO- This is the request message to query a customer account details in Oracle FLEXCUBE UBS. An external system which intends to query a virtual account has to send the request in the specified format. The format of the message is called 'Input-only', which has only those fields that are actually required for querying virtual account.
- QueryCustAcc -Res-Full- This is the response message which is sent back to the external system when a customer account is successfully queried in Oracle FLEXCUBE UBS. The format of the message is called 'Full-screen response', which includes all the fields (input fields and the display fields) as in the corresponding Oracle FLEXCUBE screen.

5.2.2 FCUBSLD Service

Corporate deposit operations are logically grouped under a service called 'FCUBSLDService'.

Oracle FLEXCUBE supports the following operations under this service:

- LDActivateSimulate
- DeleteLDSIMContract
- QueryLDSIMContract
- LDVamiCreateSim
- LDVamiQuerySim
- QueryLDPaymentSim
- CreateLDPaymentSim

5.2.2.1 LDActivateSimulate

This is the operation code for activating corporate deposits simulation in Oracle FLEXCUBE. It involves the following messages:

- LDActivateSimulate-Req-Full- This is the request message to activate corporate deposits simulation in Oracle FLEXCUBE UBS. An external system which intends to activate corporate deposits simulation has to send the request in the format specified.

The format of the message is called 'Full-screen', which includes all the fields (input fields and the display fields) as in the corresponding Oracle FLEXCUBE front-end screen. LDActivateSimulate -Req-IO- This is the request message to activate corporate deposits simulation in Oracle FLEXCUBE UBS. An external system which intends to activate corporate deposits simulation has to send the request in the specified format. The format of the message is called 'Input-only', which has only those fields that are actually required for activating corporate deposits simulation.

- LDActivateSimulate -Res-Full- This is the response message which is sent back to the external system when corporate deposits simulation is successfully activated in Oracle FLEXCUBE UBS. The format of the message is called 'Full-screen response', which includes all the fields (input fields and the display fields) as in the corresponding Oracle FLEXCUBE screen.
- LDActivateSimulate -Res-PK- This is the response message which is sent back to the external system when an existing corporate deposits simulation is successfully activated in Oracle FLEXCUBE UBS. The format of the message is called 'Primary-Key response', which includes only the primary key fields of the corporate deposits simulation in the Oracle FLEXCUBE data store.

5.2.2.2 DeleteLDSIMContract

This is the operation code for deleting LD simulation contract in Oracle FLEXCUBE. It involves the following messages:

- DeleteLDSIMContract-Req-Full- This is the request message to delete LD simulation contract in Oracle FLEXCUBE UBS. An external system which intends to delete LD simulation contract has to send the request in the format specified. The format of the message is called 'Full-screen', which includes all the fields (input fields and the display fields) as in the corresponding Oracle FLEXCUBE front-end screen.
- DeleteLDSIMContract -Req-IO- This is the request message to delete LD simulation contract in Oracle FLEXCUBE UBS. An external system which intends to delete LD simulation contract has to send the request in the specified format. The format of the message is called 'Input-only', which has only those fields that are actually required for deleting LD simulation contract.
- DeleteLDSIMContract -Res-Full- This is the response message which is sent back to the external system when LD simulation contract is successfully deleted in Oracle FLEXCUBE UBS. The format of the message is called 'Full-screen response', which includes all the fields (input fields and the display fields) as in the corresponding Oracle FLEXCUBE screen.
- DeleteLDSIMContract -Res-PK- This is the response message which is sent back to the external system when an existing LD simulation contract is successfully deleted in Oracle FLEXCUBE UBS. The format of the message is called 'Primary-Key response', which includes only the primary key fields of the LD simulation contract in the Oracle FLEXCUBE data store.

5.2.2.3 QueryLDSIMContract

This is the operation code for querying LD simulation contract in Oracle FLEXCUBE. It involves the following messages:

- DeleteQueryLDSIMContract -Req-IO- This is the request message to query LD simulation contract in Oracle FLEXCUBE UBS. An external system which intends to query LD simulation contract has to send the request in the specified format. The format of the message is called 'Input-only', which has only those fields that are actually required for querying LD simulation contract.
- DeleteQueryLDSIMContract -Res-Full- This is the response message which is sent back to the external system when LD simulation contract is successfully queried in Oracle FLEXCUBE UBS. The format of the message is called 'Full-screen response',

which includes all the fields (input fields and the display fields) as in the corresponding Oracle FLEXCUBE screen.

5.2.2.4 LDVamiCreateSim

This is the operation code for creating LD VAMI Simulation contract in Oracle FLEXCUBE. It involves the following messages:

- LDVamiCreateSim-Req-Full- This is the request message to create LD VAMI simulation contract in Oracle FLEXCUBE UBS. An external system which intends to create LD VAMI simulation contract has to send the request in the format specified. The format of the message is called 'Full-screen', which includes all the fields (input fields and the display fields) as in the corresponding Oracle FLEXCUBE front-end screen.
- LDVamiCreateSim -Req-IO- This is the request message to create LD VAMI simulation contract in Oracle FLEXCUBE UBS. An external system which intends to create LD VAMI simulation contract has to send the request in the specified format. The format of the message is called 'Input-only', which has only those fields that are actually required for creating LD VAMI simulation.
- LDVamiCreateSim -Res-Full- This is the response message which is sent back to the external system when LD VAMI simulation contract is successfully created in Oracle FLEXCUBE UBS. The format of the message is called 'Full-screen response', which includes all the fields (input fields and the display fields) as in the corresponding Oracle FLEXCUBE screen.
- LDVamiCreateSim -Res-PK- This is the response message which is sent back to the external system when an LD VAMI simulation contract is successfully created in Oracle FLEXCUBE UBS. The format of the message is called 'Primary-Key response', which includes only the primary key fields of the LD VAMI simulation in the Oracle FLEXCUBE data store.

5.2.2.5 LDVamiQuerySim

This is the operation code for querying LD VAMI Simulation contract in Oracle FLEXCUBE. It involves the following messages:

- LDVamiQuerySim -Req-IO- This is the request message to query LD VAMI simulation contract in Oracle FLEXCUBE UBS. An external system which intends to query LD VAMI simulation contract has to send the request in the specified format. The format of the message is called 'Input-only', which has only those fields that are actually required for querying LD VAMI simulation.
- LDVamiQuerySim -Res-Full- This is the response message which is sent back to the external system when LD VAMI simulation contract is successfully queried in Oracle FLEXCUBE UBS. The format of the message is called 'Full-screen response', which includes all the fields (input fields and the display fields) as in the corresponding Oracle FLEXCUBE screen.

5.2.2.6 QueryLDPaymentSim

This is the operation code for querying LD Payment Simulation in Oracle FLEXCUBE. It involves the following messages:

- QueryLDPaymentSim -Req-IO- This is the request message to query LD payment simulation in Oracle FLEXCUBE UBS. An external system which intends to query LD payment simulation has to send the request in the specified format. The format of the message is called 'Input-only', which has only those fields that are actually required for querying LD payment simulation.
- QueryLDPaymentSim -Res-Full- This is the response message which is sent back to the external system when LD payment simulation is successfully queried in Oracle FLEXCUBE UBS. The format of the message is called 'Full-screen response', which

includes all the fields (input fields and the display fields) as in the corresponding Oracle FLEXCUBE screen.

5.2.2.7 CreateLDPaymentSim

This is the operation code for creating LD Payment Simulation in Oracle FLEXCUBE. It involves the following messages:

- CreateLDPaymentSim-Req-Full- This is the request message to create LD payment simulation in Oracle FLEXCUBE UBS. An external system which intends to create LD payment simulation has to send the request in the format specified. The format of the message is called 'Full-screen', which includes all the fields (input fields and the display fields) as in the corresponding Oracle FLEXCUBE front-end screen.
- CreateLDPaymentSim -Req-IO- This is the request message to create LD payment simulation in Oracle FLEXCUBE UBS. An external system which intends to create LD payment simulation has to send the request in the specified format. The format of the message is called 'Input-only', which has only those fields that are actually required for creating LD payment simulation.
- CreateLDPaymentSim -Res-Full- This is the response message which is sent back to the external system when LD payment simulation is successfully created in Oracle FLEXCUBE UBS. The format of the message is called 'Full-screen response', which includes all the fields (input fields and the display fields) as in the corresponding Oracle FLEXCUBE screen.
- CreateLDPaymentSim -Res-PK- This is the response message which is sent back to the external system when an LD payment simulation is successfully created in Oracle FLEXCUBE UBS. The format of the message is called 'Primary-Key response', which includes only the primary key fields of the LD payment simulation in the Oracle FLEXCUBE data store.

5.2.3 FCUBSCustomerService

Customer related operations are logically grouped under a service called 'FCUBSCustomerService'.

Oracle FLEXCUBE supports the following operations under this service:

- AccountStructureNew
- AccountStructureModify
- AccountStructureQuery
- CreateAmtBlk
- ModifyAmtBlk
- CloseAmtBlk
- CreateCustomer.
- ModifyCustomer.
- AuthorizeCustomer.
- QueryCustomer
- CreateClosureData
- AuthorizeClosureData
- ModifyClosureData
- QueryClosureData

5.2.3.1 AccountStructureNew

This is the operation code for creating Account Structure in Oracle FLEXCUBE. It involves the following messages:

- AccountStructureNew-Req-Full- This is the request message to create account structure in Oracle FLEXCUBE UBS. An external system which intends to create account structure has to send the request in the format specified. The format of the message is called 'Full-screen', which includes all the fields (input fields and the display fields) as in the corresponding Oracle FLEXCUBE front-end screen.
- AccountStructureNew-Req-IO- This is the request message to create account structure in Oracle FLEXCUBE UBS. An external system which intends to create account structure has to send the request in the specified format. The format of the message is called 'Input-only', which has only those fields that are actually required for creating account structure.
- AccountStructureNew -Res-Full- This is the response message which is sent back to the external system when account structure is successfully created in Oracle FLEXCUBE UBS. The format of the message is called 'Full-screen response', which includes all the fields (input fields and the display fields) as in the corresponding Oracle FLEXCUBE screen.
- AccountStructureNew -Res-PK- This is the response message which is sent back to the external system when a new account structure is successfully created in Oracle FLEXCUBE UBS. The format of the message is called 'Primary-Key response', which includes only the primary key fields of the account structure in the Oracle FLEXCUBE data store.

5.2.3.2 AccountStructureModify

This is the operation code for modifying account structure in Oracle FLEXCUBE. It involves the following messages:

- AccountStructureModify-Req-Full- This is the request message to modify an account structure in Oracle FLEXCUBE UBS. An external system which intends to modify an account structure has to send the request in the format specified. The format of the message is called 'Full-screen', which includes all the fields (input fields and the display fields) as in the corresponding Oracle FLEXCUBE front-end screen.
- AccountStructureModify-Req-IO- This is the request message to modify an account structure in Oracle FLEXCUBE UBS. An external system which intends to modify an account structure has to send the request in the specified format. The format of the message is called 'Input-only', which has only those fields that are actually required for modifying account structure.
- AccountStructureModify -Res-Full- This is the response message which is sent back to the external system when an account structure is successfully modified in Oracle FLEXCUBE UBS. The format of the message is called 'Full-screen response', which includes all the fields (input fields and the display fields) as in the corresponding Oracle FLEXCUBE screen.
- AccountStructureModify -Res-PK- This is the response message which is sent back to the external system when an account structure is successfully modified in Oracle FLEXCUBE UBS. The format of the message is called 'Primary-Key response', which includes only the primary key fields of the account structure in the Oracle FLEXCUBE data store.

5.2.3.3 AccountStructureQuery

This is the operation code for querying an account structure in Oracle FLEXCUBE. It involves the following messages:

- AccountStructureQuery-Req-Full- This is the request message to an account structure in Oracle FLEXCUBE UBS. An external system which intends to query an account structure has to send the request in the format specified. The format of the message is called 'Full-screen', which includes all the fields (input fields and the display fields) as in the corresponding Oracle FLEXCUBE front-end screen.
- AccountStructureQuery -Req-IO- This is the request message to query an account structure in Oracle FLEXCUBE UBS. An external system which intends to query an account structure has to send the request in the specified format. The format of the message is called 'Input-only', which has only those fields that are actually required for querying account structure.
- AccountStructureQuery -Res-Full- This is the response message which is sent back to the external system when an account structure is successfully queried in Oracle FLEXCUBE UBS. The format of the message is called 'Full-screen response', which includes all the fields (input fields and the display fields) as in the corresponding Oracle FLEXCUBE screen.
- AccountStructureQuery -Res-PK- This is the response message which is sent back to the external system when an an account structure is successfully queried in Oracle FLEXCUBE UBS. The format of the message is called 'Primary-Key response', which includes only the primary key fields of the account structure in the Oracle FLEXCUBE data store.

5.2.3.4 CreateAmtBlk

This is the operation code for creating an amount block in Oracle FLEXCUBE. It involves the following messages:

- CreateAmtBlk-Req-Full- This is the request message to create amount block in Oracle FLEXCUBE UBS. An external system which intends to create an amount block has to send the request in the format specified. The format of the message is called 'Full-screen', which includes all the fields (input fields and the display fields) as in the corresponding Oracle FLEXCUBE front-end screen.
- CreateAmtBlk -Req-IO- This is the request message to create an amount block in Oracle FLEXCUBE UBS. An external system which intends to create an amount block has to send the request in the specified format. The format of the message is called 'Input-only', which has only those fields that are actually required for creating amount block.
- CreateAmtBlk -Res-Full- This is the response message which is sent back to the external system when an amount block is successfully created in Oracle FLEXCUBE UBS. The format of the message is called 'Full-screen response', which includes all the fields (input fields and the display fields) as in the corresponding Oracle FLEXCUBE screen.
- CreateAmtBlk-Res-PK- This is the response message which is sent back to the external system when an amount block is successfully created in Oracle FLEXCUBE UBS. The format of the message is called 'Primary-Key response', which includes only the primary key fields of the amount block in the Oracle FLEXCUBE data store.

5.2.3.5 ModifyAmtBlk

This is the operation code for modifying amount block in Oracle FLEXCUBE. It involves the following messages:

- ModifyAmtBlk-Req-Full- This is the request message to modify an amount block in Oracle FLEXCUBE UBS. An external system which intends to modify an amount block has to send the request in the format specified. The format of the message is called 'Full-screen', which includes all the fields (input fields and the display fields) as in the corresponding Oracle FLEXCUBE front-end screen.

- **ModifyAmtBlk-Req-IO-** This is the request message to modify an amount block in Oracle FLEXCUBE UBS. An external system which intends to modify an amount block has to send the request in the specified format. The format of the message is called 'Input-only', which has only those fields that are actually required for modifying amount block.
- **ModifyAmtBlk -Res-Full-** This is the response message which is sent back to the external system when an amount block is successfully modified in Oracle FLEXCUBE UBS. The format of the message is called 'Full-screen response', which includes all the fields (input fields and the display fields) as in the corresponding Oracle FLEXCUBE screen.
- **ModifyAmtBlk -Res-PK-** This is the response message which is sent back to the external system when an amount block is successfully modified in Oracle FLEXCUBE UBS. The format of the message is called 'Primary-Key response', which includes only the primary key fields of the amount block in the Oracle FLEXCUBE data store.

5.2.3.6 CloseAmtBlk

This is the operation code for closing amount block in Oracle FLEXCUBE. It involves the following messages:

- **CloseAmtBlk-Req-Full-** This is the request message to close an amount block in Oracle FLEXCUBE UBS. An external system which intends to close an amount block has to send the request in the format specified. The format of the message is called 'Full-screen', which includes all the fields (input fields and the display fields) as in the corresponding Oracle FLEXCUBE front-end screen.
- **CloseAmtBlk-Req-IO-** This is the request message to close an amount block in Oracle FLEXCUBE UBS. An external system which intends to close an amount block has to send the request in the specified format. The format of the message is called 'Input-only', which has only those fields that are actually required for closing amount block.
- **CloseAmtBlk -Res-Full-** This is the response message which is sent back to the external system when an amount block is successfully closed in Oracle FLEXCUBE UBS. The format of the message is called 'Full-screen response', which includes all the fields (input fields and the display fields) as in the corresponding Oracle FLEXCUBE screen.
- **CloseAmtBulk -Res-PK-** This is the response message which is sent back to the external system when an amount block is successfully closed in Oracle FLEXCUBE UBS. The format of the message is called 'Primary-Key response', which includes only the primary key fields of the amount block in the Oracle FLEXCUBE data store.

5.2.3.7 CreateCustomer

This is the operation code for creating a customer record in Oracle FLEXCUBE. It involves the following messages:

- **CreateCustomer-Req-Full-** This is the request message to create customer record in Oracle FLEXCUBE UBS. An external system which intends to create an amount block has to send the request in the format specified. The format of the message is called 'Full-screen', which includes all the fields (input fields and the display fields) as in the corresponding Oracle FLEXCUBE front-end screen.
- **CreateCustomer -Req-IO-** This is the request message to create customer record in Oracle FLEXCUBE UBS. An external system which intends to create an amount block has to send the request in the specified format. The format of the message is called 'Input-only', which has only those fields that are actually required for creating a customer record.
- **CreateCustomer -Res-Full-** This is the response message which is sent back to the external system when customer record is successfully created in Oracle FLEXCUBE UBS. The format of the message is called 'Full-screen response', which includes all the

fields (input fields and the display fields) as in the corresponding Oracle FLEXCUBE screen.

- CreateCustomer-Res-PK- This is the response message which is sent back to the external system when a customer record is successfully created in Oracle FLEXCUBE UBS. The format of the message is called 'Primary-Key response', which includes only the primary key fields of the amount block in the Oracle FLEXCUBE data store.

5.2.3.8 ModifyCustomer

This is the operation code for modifying a customer record in Oracle FLEXCUBE. It involves the following messages:

- ModifyCustomer-Req-Full- This is the request message to modify a customer record in Oracle FLEXCUBE UBS. An external system which intends to modify a customer record has to send the request in the format specified. The format of the message is called 'Full-screen', which includes all the fields (input fields and the display fields) as in the corresponding Oracle FLEXCUBE front-end screen.
- ModifyCustomer-Req-IO- This is the request message to modify customer record in Oracle FLEXCUBE UBS. An external system which intends to modify a customer record has to send the request in the specified format. The format of the message is called 'Input-only', which has only those fields that are actually required for modifying a customer record.
- ModifyCustomer -Res-Full- This is the response message which is sent back to the external system when a customer record is successfully modified in Oracle FLEXCUBE UBS. The format of the message is called 'Full-screen response', which includes all the fields (input fields and the display fields) as in the corresponding Oracle FLEXCUBE screen.
- ModifyCustomer -Res-PK- This is the response message which is sent back to the external system when a customer record is successfully modified in Oracle FLEXCUBE UBS. The format of the message is called 'Primary-Key response', which includes only the primary key fields of the amount block in the Oracle FLEXCUBE data store.

5.2.3.9 Authorize Customer

This is the operation code for authorizing the customer record in Oracle FLEXCUBE. It involves the following messages:

- AuthorizeCustomer-Req-Full- This is the request message to authorize customer records in Oracle FLEXCUBE UBS. An external system which intends to authorize a record has to send the request in the format specified. The format of the message is called 'Full-screen', which includes all the fields (input fields and the display fields) as in the corresponding Oracle FLEXCUBE front-end screen.
- AuthorizeCustomer -Req-IO- This is the request message to authorize customer record in Oracle FLEXCUBE UBS. An external system which intends to authorize a record has to send the request in the specified format. The format of the message is called 'Input-only', which has only those fields that are actually required for creating a customer record.
- AuthorizeCustomer -Res-Full- This is the response message which is sent back to the external system when a customer record is successfully authorized in Oracle FLEXCUBE UBS. The format of the message is called 'Full-screen response', which includes all the fields (input fields and the display fields) as in the corresponding Oracle FLEXCUBE screen.
- AuthorizeCustomer -Res-PK- This is the response message which is sent back to the external system when a customer record is successfully authorized in Oracle FLEXCUBE UBS. The format of the message is called 'Primary-Key response', which includes only the primary key fields of the customer record authorization in the Oracle FLEXCUBE data store.

5.2.3.10 QueryCustomer

This service is used by external channels to query a customer record in Oracle FLEXCUBE:

- QueryClosureData -Req-IO- This is the request message to query a customer record in Oracle FLEXCUBE UBS. An external system which intends to query a customer record has to send the request in the specified format. The format of the message is called 'Input-only', which has only those fields that are actually required for querying a record.
- QueryClosureData -Res-Full- This is the response message which is sent back to the external system when a customer record is successfully queried in Oracle FLEXCUBE UBS. The format of the message is called 'Full-screen response', which includes all the fields (input fields and the display fields) as in the corresponding Oracle FLEXCUBE screen.

5.2.3.11 CreateClosureData

This is the operation code for creating a record in the 'Customer Closure Data (STSCUSCL) screen in Oracle FLEXCUBE. It involves the following messages:

- CreateClosureData-Req-Full- This is the request message to create a record in the 'Customer Closure Data (STSCUSCL) screen in Oracle FLEXCUBE UBS. An external system which intends to create a virtual account has to send the request in the format specified. The format of the message is called 'Full-screen', which includes all the fields (input fields and the display fields) as in the corresponding Oracle FLEXCUBE front-end screen.
- CreateClosureData -Req-IO- This is the request message to create a record in the 'Customer Closure Data (STSCUSCL) screen in Oracle FLEXCUBE UBS. An external system which intends to create a virtual account has to send the request in the specified format. The format of the message is called 'Input-only', which has only those fields that are actually required for creating a record.
- CreateClosureData -Res-Full- This is the response message which is sent back to the external system when a customer record is successfully created in Oracle FLEXCUBE UBS. The format of the message is called 'Full-screen response', which includes all the fields (input fields and the display fields) as in the corresponding Oracle FLEXCUBE screen.
- CreateClosureData-Res-PK- This is the response message which is sent back to the external system when a customer record is successfully created in the 'Customer Closure Data (STSCUSCL)' screen in Oracle FLEXCUBE UBS. The format of the message is called 'Primary-Key response', which includes only the primary key fields of creating a customer record in the Oracle FLEXCUBE data store.

5.2.3.12 AuthorizeClosureData

This is the operation code for authorizing a customer record in Oracle FLEXCUBE. It involves the following messages:

- AuthorizeCustomer-Req-Full- This is the request message to authorize customer records in Oracle FLEXCUBE UBS. An external system which intends to authorize a record has to send the request in the format specified. The format of the message is called 'Full-screen', which includes all the fields (input fields and the display fields) as in the corresponding Oracle FLEXCUBE front-end screen.
- AuthorizeClosureData -Req-IO- This is the request message to authorize records in 'Customer Closure Data (STSCUSCL) screen in Oracle FLEXCUBE UBS. An external system which intends to authorize a record has to send the request in the specified format. The format of the message is called 'Input-only', which has only those fields that are actually required for creating a customer record.

- AuthorizeClosureData -Res-Full- This is the response message which is sent back to the external system when a customer record is successfully authorized in 'Customer Closure Data (STSCUSCL) screen in Oracle FLEXCUBE UBS. The format of the message is called 'Full-screen response', which includes all the fields (input fields and the display fields) as in the corresponding Oracle FLEXCUBE screen.
- AuthorizeClosureData -Res-PK- This is the response message which is sent back to the external system when a 'Customer Closure Data (STSCUSCL) screen is successfully authorized in Oracle FLEXCUBE UBS. The format of the message is called 'Primary-Key response', which includes only the primary key fields of the customer record authorization in the Oracle FLEXCUBE data store.

5.2.3.13 ModifyClosureData

This is the operation code for modifying a record in the 'Customer Closure Data (STSCUSCL) screen' in Oracle FLEXCUBE. Here only the 'Closure Allowed' field can be modified. It involves the following messages:

- ModifyClosureData-Req-Full- This is the request message to modify a record in the 'Customer Closure Data (STSCUSCL) screen' in Oracle FLEXCUBE UBS. An external system which intends to modify a record has to send the request in the format specified. The format of the message is called 'Full-screen', which includes all the fields (input fields and the display fields) as in the corresponding Oracle FLEXCUBE front-end screen.
- ModifyClosureData-Req-IO- This is the request message to modify a record in the 'Customer Closure Data (STSCUSCL) screen' in Oracle FLEXCUBE UBS. An external system which intends to modify a record has to send the request in the specified format. The format of the message is called 'Input-only', which has only those fields that are actually required for modifying a record.
- ModifyClosureData -Res-Full- This is the response message which is sent back to the external system when record is successfully modified in 'Customer Closure Data (STSCUSCL) screen' in Oracle FLEXCUBE UBS. The format of the message is called 'Full-screen response', which includes all the fields (input fields and the display fields) as in the corresponding Oracle FLEXCUBE screen.
- ModifyClosureData -Res-PK- This is the response message which is sent back to the external system when a record is successfully modified in Oracle FLEXCUBE UBS. The format of the message is called 'Primary-Key response', which includes only the primary key fields of the record in the Oracle FLEXCUBE data store.

5.2.3.14 QueryClosureData

This service is used by external channels to query closure data in the 'Customer Closure Data (STSCUSCL) screen' in Oracle FLEXCUBE:

- QueryClosureData -Req-IO- This is the request message to query a customer closure data details in 'Customer Closure Data (STSCUSCL) screen' in Oracle FLEXCUBE UBS. An external system which intends to query a customer closure data has to send the request in the specified format. The format of the message is called 'Input-only', which has only those fields that are actually required for querying a record.
- QueryClosureData -Res-Full- This is the response message which is sent back to the external system when a customer closure record is successfully queried in Oracle FLEXCUBE UBS. The format of the message is called 'Full-screen response', which includes all the fields (input fields and the display fields) as in the corresponding Oracle FLEXCUBE screen.

5.2.4 FCUBSTDService

TD related operations are logically grouped under a service called 'FCUBSTDService'.

Oracle FLEXCUBE supports the following operations under this service:

- CreateTDRRedem
- AuthorizeTDRRedem
- DeleteTDRRedem
- QueryTDRRedem

5.2.4.1 CreateTDRRedem

This is the operation code for creating a redemption request of TD in Oracle FLEXCUBE. It involves the following messages:

- CreateTDRRedem-Req-Full- This is the request message to redeem TD account in Oracle FLEXCUBE UBS. An external system which intends to redeem a TD account has to send the request in the format specified. The format of the message is called 'Full-screen', which includes all the fields (input fields and the display fields) as in the corresponding Oracle FLEXCUBE front-end screen.
- CreateTDRRedem -Req-IO- This is the request message to redeem TD account in Oracle FLEXCUBE UBS. An external system which intends to redeem TD account has to send the request in the specified format. The format of the message is called 'Input-only', which has only those fields that are actually required for redeeming a TD.
- CreateTDRRedem -Res-Full- This is the response message which is sent back to the external system when a TD account is successfully redeemed in Oracle FLEXCUBE UBS. The format of the message is called 'Full-screen response', which includes all the fields (input fields and the display fields) as in the corresponding Oracle FLEXCUBE screen.
- CreateTDRRedem -Res-PK- This is the response message which is sent back to the external system when a TD account is successfully redeemed in Oracle FLEXCUBE UBS. The format of the message is called 'Primary-Key response', which includes only the primary key fields of the redemption in the Oracle FLEXCUBE data store.

5.2.4.2 AuthorizeTDRRedem

This is the operation code for authorizing redemption request of TD in Oracle FLEXCUBE. It involves the following messages:

- AuthorizeTDRRedem-Req-Full- This is the request message to authorize the redemption of TD account in Oracle FLEXCUBE UBS. An external system which intends to authorize the redemption has to send the request in the format specified. The format of the message is called 'Full-screen', which includes all the fields (input fields and the display fields) as in the corresponding Oracle FLEXCUBE front-end screen.
- AuthorizeTDRRedem -Req-IO- This is the request message to authorize the redemption of TD account in Oracle FLEXCUBE UBS. An external system which intends to authorize the redemption of TD account has to send the request in the specified format. The format of the message is called 'Input-only', which has only those fields that are actually required for redeeming a TD.
- AuthorizeTDRRedem -Res-Full- This is the response message which is sent back to the external system when a TD account is redeemed is successfully authorized in Oracle FLEXCUBE UBS. The format of the message is called 'Full-screen response', which includes all the fields (input fields and the display fields) as in the corresponding Oracle FLEXCUBE screen.
- AuthorizeTDRRedem -Res-PK- This is the response message which is sent back to the external system when a TD account redeemed, is authorized in Oracle FLEXCUBE UBS. The format of the message is called 'Primary-Key response', which includes only the primary key fields of the redemption in the Oracle FLEXCUBE data store.

5.2.4.3 DeleteTDRedem

This is the operation code for deleting redemption request of TD in Oracle FLEXCUBE. It involves the following messages:

- DeleteTDRedem-Req-Full- This is the request message to delete the redemption of TD account in Oracle FLEXCUBE UBS. An external system which intends to delete the redemption request created has to send the request in the format specified. The format of the message is called 'Full-screen', which includes all the fields (input fields and the display fields) as in the corresponding Oracle FLEXCUBE front-end screen.
- DeleteTDRedem -Req-IO- This is the request message to delete the redemption of TD account in Oracle FLEXCUBE UBS. An external system which intends to delete the redemption of TD account has to send the request in the specified format. The format of the message is called 'Input-only', which has only those fields that are actually required for redeeming a TD.
- DeleteTDRedem -Res-Full- This is the response message which is sent back to the external system when a redemption request is successfully deleted in Oracle FLEXCUBE UBS. The format of the message is called 'Full-screen response', which includes all the fields (input fields and the display fields) as in the corresponding Oracle FLEXCUBE screen.
- DeleteTDRedem -Res-PK- This is the response message which is sent back to the external system when a redemption request is deleted from Oracle FLEXCUBE UBS. The format of the message is called 'Primary-Key response', which includes only the primary key fields of the redemption in the Oracle FLEXCUBE data store.

5.2.4.4 QueryTDRedem

This is the operation code for querying TD redemption done in Oracle FLEXCUBE. It involves the following messages:

- QueryTDRedem -Req-IO- This is the request message to query the redemption made to TD account in Oracle FLEXCUBE UBS. An external system which intends to query TD redemption has to send the request in the specified format. The format of the message is called 'Input-only', which has only those fields that are actually required for querying TD redemption.
- QueryTDCustAcc -Res-Full- This is the response message which is sent back to the external system when redemption made to TD account successfully queried in Oracle FLEXCUBE UBS. The format of the message is called 'Full-screen response', which includes all the fields (input fields and the display fields) as in the corresponding Oracle FLEXCUBE screen.

5.2.5 FCUBSIFService

Oracle FLEXCUBE supports the following operations under this service:

- CreateExtAccEntries
- ReverseExtAccEntries
- CreateRTLResponse

5.2.5.1 CreateExtAccEntries

This is the operation code is for initiating debit or credit settlement transactions in Oracle FLEXCUBE. It involves the following messages:

- CreateExtAccEntries-Req-Full- This is the request message to create debit or credit settlement transactions in Oracle FLEXCUBE. An external system which intends to create debit or credit settlement transactions has to send the request in the format specified. The format of the message is called 'Full-screen', which includes all the fields

(input fields and the display fields) as in the corresponding Oracle FLEXCUBE front-end screen.

- CreateExtAccEntries-Req-IO- This is the request message to create debit or credit settlement transactions in Oracle FLEXCUBE. An external system which intends to create debit or credit settlement transactions has to send the request in the specified format. The format of the message is called 'Input-only', which has only those fields that are actually required for creating debit or credit settlement transactions.
- CreateExtAccEntries-Res-Full- This is the response message which is sent back to the external system when a debit or credit settlement transaction is successfully created in Oracle FLEXCUBE. The format of the message is called 'Full-screen response', which includes all the fields (input fields and the display fields) as in the corresponding Oracle FLEXCUBE screen.
- CreateExtAccEntries-Res-PK- This is the response message which is sent back to the external system when debit or credit settlement transaction is successfully created in Oracle FLEXCUBE. The format of the message is called 'Primary-Key response', which includes only the primary key fields of the debit or credit settlement transactions in the Oracle FLEXCUBE data store.

5.2.5.2 ReverseExtAccEntries

This is the operation code is for reversing debit or credit settlement transactions in Oracle FLEXCUBE. It involves the following messages:

- ReverseExtAccEntries-Req-Full- This is the request message to reverse debit or credit settlement transactions in Oracle FLEXCUBE. An external system which intends to reverse debit or credit settlement transactions has to send the request in the format specified. The format of the message is called 'Full-screen', which includes all the fields (input fields and the display fields) as in the corresponding Oracle FLEXCUBE front-end screen.
- ReverseExtAccEntries-Req-IO- This is the request message to reverse debit or credit settlement transactions in Oracle FLEXCUBE. An external system which intends to reverse debit or credit settlement transactions has to send the request in the specified format. The format of the message is called 'Input-only', which has only those fields that are actually required for creating debit or credit settlement transactions.
- ReverseExtAccEntries-Res-Full- This is the response message which is sent back to the external system when a debit or credit settlement transaction is successfully reverse in Oracle FLEXCUBE. The format of the message is called 'Full-screen response', which includes all the fields (input fields and the display fields) as in the corresponding Oracle FLEXCUBE screen.
- ReverseExtAccEntries-Res-PK- This is the response message which is sent back to the external system when debit or credit settlement transaction is successfully reversed in Oracle FLEXCUBE. The format of the message is called 'Primary-Key response', which includes only the primary key fields of the debit or credit settlement transactions in the Oracle FLEXCUBE data store.

5.2.5.3 CreateRTLResponse

Oracle FLEXCUBE supports the following operations under this service:

CreateRTLResponse - This is the operation code is for initiating a response to the RTL Block requested from Oracle FLEXCUBE. It involves the following messages:

- CreateRTLResponse-Req-Full - This is the request message to initiate a response to the RTL Block requested from Oracle FLEXCUBE. An external system which intends to send a response to the RTL Block has to send the request in the format specified. The format of the message is called 'Full-screen', which includes all the fields (input fields and the display fields) as in the corresponding Oracle FLEXCUBE front-end screen.

- **CreateRTLResponse-Req-IO** - This is the request message to initiate a response to the RTL Block requested from Oracle FLEXCUBE. An external system which intends to send a response to the RTL Block has to send the request in the format specified. The format of the message is called 'Input-only', which has only those fields that are actually required to send a response to the RTL Block.
- **CreateRTLResponse-Res-Full** - This is the response message which is sent back to the external system when a response to the RTL Block is successfully processed in Oracle FLEXCUBE. The format of the message is called 'Full-screen response', which includes all the fields (input fields and the display fields) as in the corresponding Oracle FLEXCUBE screen.
- **CreateRTLResponse-Res-PK** - This is the response message which is sent back to the external system when a response to the RTL Block is successfully processed in Oracle FLEXCUBE. The format of the message is called 'Primary-Key response', which includes only the primary key fields of the response to the RTL Block in the Oracle FLEXCUBE data store.

5.2.6 FCUBSInteractionservice

Oracle FLEXCUBE supports the following operations under this service:

- **CreateSpendClass**
- **ModifySpendClass**
- **CloseSpendClass**
- **ReopenSpendClass**
- **ModifySpEntryClass**

5.2.6.1 CreateSpendClass

This is the operation code for creating spend class in Oracle FLEXCUBE. It involves the following messages:

- **CreateSpendClass-Req-Full**- This is the request message to create spend class in Oracle FLEXCUBE. An external system which intends to create debit or credit settlement transactions has to send the request in the format specified. The format of the message is called 'Full-screen', which includes all the fields (input fields and the display fields) as in the corresponding Oracle FLEXCUBE front-end screen.
- **CreateSpendClass-Req-IO**- This is the request message to create spend class in Oracle FLEXCUBE. An external system which intends to create spend class has to send the request in the specified format. The format of the message is called 'Input-only', which has only those fields that are actually required for creating spend class.
- **CreateSpendClass-Res-Full**- This is the response message which is sent back to the external system when a spend class is successfully created in Oracle FLEXCUBE. The format of the message is called 'Full-screen response', which includes all the fields (input fields and the display fields) as in the corresponding Oracle FLEXCUBE screen.
- **CreateSpendClass-Res-PK**- This is the response message which is sent back to the external system when spend class is successfully created in Oracle FLEXCUBE. The format of the message is called 'Primary-Key response', which includes only the primary key fields of the spend class in the Oracle FLEXCUBE data store.

5.2.6.2 ModifySpendClass

This is the operation code for modifying spend class parameters in Oracle FLEXCUBE. It involves the following messages:

- **ModifySpendClass-Req-Full**- This is the request message to modify spend class parameters in Oracle FLEXCUBE. An external system which intends to modify spend

class parameters has to send the request in the format specified. The format of the message is called 'Full-screen', which includes all the fields (input fields and the display fields) as in the corresponding Oracle FLEXCUBE front-end screen.

- **ModifySpendClass-Req-IO-** This is the request message to modify spend class parameters in Oracle FLEXCUBE. An external system which intends to modify spend class parameters has to send the request in the specified format. The format of the message is called 'Input-only', which has only those fields that are actually required for modifying spend class parameters.
- **ModifySpendClass-Res-Full-** This is the response message which is sent back to the external system when spend class parameters are successfully modified in Oracle FLEXCUBE. The format of the message is called 'Full-screen response', which includes all the fields (input fields and the display fields) as in the corresponding Oracle FLEXCUBE screen.
- **ModifySpendClass-Res-PK-** This is the response message which is sent back to the external system when spend class parameters are successfully modified in Oracle FLEXCUBE. The format of the message is called 'Primary-Key response', which includes only the primary key fields of the spend class parameters in the Oracle FLEXCUBE data store.

5.2.6.3 CloseSpendClass

This is the operation code for closing spend class in Oracle FLEXCUBE.

5.2.6.4 ReopenSpendClass

This is the operation code for reopening spend class parameters in Oracle FLEXCUBE.

5.2.6.5 ModifySpEntryClass

This is the operation code for splitting transactions in Oracle FLEXCUBE.

5.2.7 FCUBSICService

Oracle FLEXCUBE supports the following operations under this service:

- CreatePreclosureFactor
- AuthorizePreclosureFactor
- DeletePreclosureFactor
- ModifyPreclosureFactor
- ClosePreclosureFactor
- ReopenPreclosureFactor
- QueryPreclosureFactor

5.2.7.1 CreatePreclosureFactor

This is the operation code for creating preclosure factor in Oracle FLEXCUBE. It involves the following messages:

- **CreatePreclosureFactor-Req-Full-** This is the request message to create preclosure factor in Oracle FLEXCUBE. An external system has to send the request in the format specified. The format of the message is called 'Full-screen', which includes all the fields (input fields and the display fields) as in the corresponding Oracle FLEXCUBE front-end screen.
- **CreatePreclosureFactor-Req-IO-** This is the request message to create preclosure factor in Oracle FLEXCUBE. An external system has to send the request in the specified

format. The format of the message is called 'Input-only', which has only those fields that are actually required for creating preclosure factor.

- CreatePreclosureFactor-Res-Full- This is the response message which is sent back to the external system when a preclosure factor is successfully created in Oracle FLEXCUBE. The format of the message is called 'Full-screen response', which includes all the fields (input fields and the display fields) as in the corresponding Oracle FLEXCUBE screen.
- CreatePreclosureFactor-Res-PK- This is the response message which is sent back to the external system when preclosure factor is successfully created in Oracle FLEXCUBE. The format of the message is called 'Primary-Key response', which includes only the primary key fields of the spend class in the Oracle FLEXCUBE data store.

5.2.7.2 AuthorizePreclosureFactor

This is the operation code for authorizing Preclosure Factor in Oracle FLEXCUBE. It involves the following messages:

- AuthPreclosureFactor-Req-Full- This is the request message to authorize the Preclosure Factor in Oracle FLEXCUBE. An external system which intends to authorize the Preclosure Factor has to send the request in the format specified. The format of the message is called 'Full-screen', which includes all the fields (input fields and the display fields) as in the corresponding Oracle FLEXCUBE front-end screen.
- AuthPreclosureFactor -Req-IO- This is the request message to authorize the Preclosure Factor in Oracle FLEXCUBE. An external system which intends to authorize the Preclosure Factor has to send the request in the specified format. The format of the message is called 'Input-only', which has only those fields that are actually required for Preclosure Factor.
- AuthPreclosureFactor -Res-Full- This is the response message which is sent back to the external system when a Preclosure Factor is successfully authorized in Oracle FLEXCUBE. The format of the message is called 'Full-screen response', which includes all the fields (input fields and the display fields) as in the corresponding Oracle FLEXCUBE screen.
- AuthPreclosureFactor -Res-PK- This is the response message which is sent back to the external system when a Preclosure Factor, is authorized in Oracle FLEXCUBE. The format of the message is called 'Primary-Key response', which includes only the primary key fields of the P2P payment parameters in the Oracle FLEXCUBE data store.

5.2.7.3 DeletePreclosureFactor

This is the operation code for deleting Preclosure Factor in Oracle FLEXCUBE. It involves the following messages:

- DeletePreclosureFactor-Req-Full- This is the request message to delete Preclosure Factor in Oracle FLEXCUBE. An external system which intends to delete Preclosure Factor has to send the request in the format specified. The format of the message is called 'Full-screen', which includes all the fields (input fields and the display fields) as in the corresponding Oracle FLEXCUBE front-end screen.
- DeletePreclosureFactor-Req-IO- This is the request message to delete Preclosure Factor in Oracle FLEXCUBE. An external system which intends to delete a Preclosure Factor has to send the request in the specified format. The format of the message is called 'Input-only', which has only those fields that are actually required for closing Preclosure Factor.
- DeletePreclosureFactor-Res-Full- This is the response message which is sent back to the external system when Preclosure Factor is successfully deleted in Oracle FLEXCUBE. The format of the message is called 'Full-screen response', which includes

all the fields (input fields and the display fields) as in the corresponding Oracle FLEXCUBE screen.

- DeletePreclosureFactor-Res-PK- This is the response message which is sent back to the external system when Preclosure Factor is successfully deleted in Oracle FLEXCUBE. The format of the message is called 'Primary-Key response', which includes only the primary key fields of the Preclosure Factor in the Oracle FLEXCUBE data store.

5.2.7.4 ModifyPreclosureFactor

This is the operation code for modifying spend class parameters in Oracle FLEXCUBE. It involves the following messages:

- ModifyPreclosureFactor-Req-Full- This is the request message to modify Preclosure Factor in Oracle FLEXCUBE. An external system which intends to modify Preclosure Factor has to send the request in the format specified. The format of the message is called 'Full-screen', which includes all the fields (input fields and the display fields) as in the corresponding Oracle FLEXCUBE front-end screen.
- ModifyPreclosureFactor-Req-IO- This is the request message to modify Preclosure Factor in Oracle FLEXCUBE. An external system which intends to modify Preclosure Factor has to send the request in the specified format. The format of the message is called 'Input-only', which has only those fields that are actually required for modifying Preclosure Factor.
- ModifyPreclosureFactor-Res-Full- This is the response message which is sent back to the external system when Preclosure Factors are successfully modified in Oracle FLEXCUBE. The format of the message is called 'Full-screen response', which includes all the fields (input fields and the display fields) as in the corresponding Oracle FLEXCUBE screen.
- ModifyPreclosureFactor-Res-PK- This is the response message which is sent back to the external system when Preclosure Factors are successfully modified in Oracle FLEXCUBE. The format of the message is called 'Primary-Key response', which includes only the primary key fields of the Preclosure Factor in the Oracle FLEXCUBE data store.

5.2.7.5 ClosePreclosureFactor

This is the operation code for closing preclosure factor in Oracle FLEXCUBE

5.2.7.6 ReopenPreclosureFactor

This is the operation code for reopening preclosure factor in Oracle FLEXCUBE

5.2.7.7 QueryPreclosureFactor

This is the operation code for querying preclosure factor done in Oracle FLEXCUBE. It involves the following messages:

- QueryPreclosureFactor -Req-IO- This is the request message to query the preclosure factor in Oracle FLEXCUBE. An external system which intends to query preclosure factor has to send the request in the specified format. The format of the message is called 'Input-only', which has only those fields that are actually required for querying preclosure factor.
- QueryPreclosureFactor-Res-Full- This is the response message which is sent back to the external system when preclosure factor is successfully queried in Oracle FLEXCUBE. The format of the message is called 'Full-screen response', which includes all the fields (input fields and the display fields) as in the corresponding Oracle FLEXCUBE screen.

5.2.8 **FCUBSSTService**

Oracle FLEXCUBE supports the following operations under this service:

- CreateAccClasMaint
- AuthorizeAccClasMaint
- ModifyAccClasMaint
- DeleteAccClasMaint
- QueryAccClasMaint
- CloseAccClasMaint
- ReopenAccClasMain

5.2.8.1 **CreateAccClasMaint**

This is the operation code for creating account class maintenance factor in Oracle FLEXCUBE. It involves the following messages:

- CreateAccClasMaint-Req-Full- This is the request message to create account class maintenance in Oracle FLEXCUBE. An external system has to send the request in the format specified. The format of the message is called 'Full-screen', which includes all the fields (input fields and the display fields) as in the corresponding Oracle FLEXCUBE front-end screen.
- CreateAccClasMaint-Req-IO- This is the request message to create account class maintenance in Oracle FLEXCUBE. An external system has to send the request in the specified format. The format of the message is called 'Input-only', which has only those fields that are actually required for creating account class maintenance factor.
- CreateAccClasMaint-Res-Full- This is the response message which is sent back to the external system when an account class maintenance is successfully created in Oracle FLEXCUBE. The format of the message is called 'Full-screen response', which includes all the fields (input fields and the display fields) as in the corresponding Oracle FLEXCUBE screen.
- CreateAccClasMaint-Res-PK- This is the response message which is sent back to the external system when an account class maintenance is successfully created in Oracle FLEXCUBE. The format of the message is called 'Primary-Key response', which includes only the primary key fields of the spend class in the Oracle FLEXCUBE data store.

5.2.8.2 **AuthorizeAccClasMaint**

This is the operation code for authorizing account class maintenance factor in Oracle FLEXCUBE. It involves the following messages:

- AuthorizeAccClasMaint-Req-Full- This is the request message to authorize account class maintenance in Oracle FLEXCUBE. An external system has to send the request in the format specified. The format of the message is called 'Full-screen', which includes all the fields (input fields and the display fields) as in the corresponding Oracle FLEXCUBE front-end screen.
- AuthorizeAccClasMaint-Req-IO- This is the request message to authorize account class maintenance in Oracle FLEXCUBE. An external system has to send the request in the specified format. The format of the message is called 'Input-only', which has only those fields that are actually required for creating account class maintenance factor.
- AuthorizeAccClasMaint-Res-Full- This is the response message which is sent back to the external system when an account class maintenance is successfully authorized in Oracle FLEXCUBE. The format of the message is called 'Full-screen response', which includes all the fields (input fields and the display fields) as in the corresponding Oracle FLEXCUBE screen.

- AuthorizeAccClasMaint-Res-PK- This is the response message which is sent back to the external system when an account class maintenance is successfully authorized in Oracle FLEXCUBE. The format of the message is called 'Primary-Key response', which includes only the primary key fields of the spend class in the Oracle FLEXCUBE data store.

5.2.8.3 ModifyAccClasMaint

This is the operation code for modifying account class maintenance factor in Oracle FLEXCUBE. It involves the following messages:

- ModifyAccClasMaint-Req-Full- This is the request message to modify account class maintenance in Oracle FLEXCUBE. An external system has to send the request in the format specified. The format of the message is called 'Full-screen', which includes all the fields (input fields and the display fields) as in the corresponding Oracle FLEXCUBE front-end screen.
- ModifyAccClasMaint-Req-IO- This is the request message to modify account class maintenance in Oracle FLEXCUBE. An external system has to send the request in the specified format. The format of the message is called 'Input-only', which has only those fields that are actually required for modifying account class maintenance factor.
- ModifyAccClasMaint-Res-Full- This is the response message which is sent back to the external system when an account class maintenance is successfully modified in Oracle FLEXCUBE. The format of the message is called 'Full-screen response', which includes all the fields (input fields and the display fields) as in the corresponding Oracle FLEXCUBE screen.
- ModifyAccClasMaint-Res-PK- This is the response message which is sent back to the external system when an account class maintenance is successfully modified in Oracle FLEXCUBE. The format of the message is called 'Primary-Key response', which includes only the primary key fields of the spend class in the Oracle FLEXCUBE data store.

5.2.8.4 DeleteAccClasMaint

This is the operation code for deleting account class maintenance factor in Oracle FLEXCUBE. It involves the following messages:

- DeleteAccClasMaint-Req-Full- This is the request message to delete account class maintenance in Oracle FLEXCUBE. An external system has to send the request in the format specified. The format of the message is called 'Full-screen', which includes all the fields (input fields and the display fields) as in the corresponding Oracle FLEXCUBE front-end screen.
- DeleteAccClasMaint-Req-IO- This is the request message to delete account class maintenance in Oracle FLEXCUBE. An external system has to send the request in the specified format. The format of the message is called 'Input-only', which has only those fields that are actually required for deleting account class maintenance factor.
- DeleteAccClasMaint-Res-Full- This is the response message which is sent back to the external system when an account class maintenance is successfully deleting in Oracle FLEXCUBE. The format of the message is called 'Full-screen response', which includes all the fields (input fields and the display fields) as in the corresponding Oracle FLEXCUBE screen.
- DeleteAccClasMaint-Res-PK- This is the response message which is sent back to the external system when an account class maintenance is successfully deleting in Oracle FLEXCUBE. The format of the message is called 'Primary-Key response', which includes only the primary key fields of the spend class in the Oracle FLEXCUBE data store.

5.2.8.5 QueryAccClasMaint

This is the operation code for querying account class maintenance factor in Oracle FLEXCUBE. It involves the following messages:

- QueryAccClasMaint-Req-Full- This is the request message to querying account class maintenance in Oracle FLEXCUBE. An external system has to send the request in the format specified. The format of the message is called 'Full-screen', which includes all the fields (input fields and the display fields) as in the corresponding Oracle FLEXCUBE front-end screen.
- QueryAccClasMaint-Req-IO- This is the request message to querying account class maintenance in Oracle FLEXCUBE. An external system has to send the request in the specified format. The format of the message is called 'Input-only', which has only those fields that are actually required for querying account class maintenance factor.
- QueryAccClasMaint-Res-Full- This is the response message which is sent back to the external system when an account class maintenance is successfully querying in Oracle FLEXCUBE. The format of the message is called 'Full-screen response', which includes all the fields (input fields and the display fields) as in the corresponding Oracle FLEXCUBE screen.
- QueryAccClasMaint-Res-PK- This is the response message which is sent back to the external system when an account class maintenance is successfully querying in Oracle FLEXCUBE. The format of the message is called 'Primary-Key response', which includes only the primary key fields of the spend class in the Oracle FLEXCUBE data store.

5.2.8.6 CloseAccClasMaint

This is the operation code for closing account class maintenance factor in Oracle FLEXCUBE. It involves the following messages:

- CloseAccClasMaint-Req-Full- This is the request message to closing account class maintenance in Oracle FLEXCUBE. An external system has to send the request in the format specified. The format of the message is called 'Full-screen', which includes all the fields (input fields and the display fields) as in the corresponding Oracle FLEXCUBE front-end screen.
- CloseAccClasMaint-Req-IO- This is the request message to closing account class maintenance in Oracle FLEXCUBE. An external system has to send the request in the specified format. The format of the message is called 'Input-only', which has only those fields that are actually required for closing account class maintenance factor.
- CloseAccClasMaint-Res-Full- This is the response message which is sent back to the external system when an account class maintenance is successfully closing in Oracle FLEXCUBE. The format of the message is called 'Full-screen response', which includes all the fields (input fields and the display fields) as in the corresponding Oracle FLEXCUBE screen.
- CloseAccClasMaint-Res-PK- This is the response message which is sent back to the external system when an account class maintenance is successfully closing in Oracle FLEXCUBE. The format of the message is called 'Primary-Key response', which includes only the primary key fields of the spend class in the Oracle FLEXCUBE data store.

5.2.8.7 ReopenAccClasMain

This is the operation code for reopening account class maintenance factor in Oracle FLEXCUBE. It involves the following messages:

- ReopenAccClasMaint-Req-Full- This is the request message to reopening account class maintenance in Oracle FLEXCUBE. An external system has to send the request

in the format specified. The format of the message is called 'Full-screen', which includes all the fields (input fields and the display fields) as in the corresponding Oracle FLEXCUBE front-end screen.

- ReopenAccClasMaint-Req-IO- This is the request message to reopening account class maintenance in Oracle FLEXCUBE. An external system has to send the request in the specified format. The format of the message is called 'Input-only', which has only those fields that are actually required for reopening account class maintenance factor.
- ReopenAccClasMaint-Res-Full- This is the response message which is sent back to the external system when an account class maintenance is successfully reopening in Oracle FLEXCUBE. The format of the message is called 'Full-screen response', which includes all the fields (input fields and the display fields) as in the corresponding Oracle FLEXCUBE screen.
- ReopenAccClasMaint-Res-PK- This is the response message which is sent back to the external system when an account class maintenance is successfully reopening in Oracle FLEXCUBE. The format of the message is called 'Primary-Key response', which includes only the primary key fields of the spend class in the Oracle FLEXCUBE data store.

5.2.9 FCUBSIAService

Oracle FLEXCUBE supports the following operations under this service:

- CreateIAAccClass
- AuthorizeIAAccClass
- ModifyIAAccClass
- DeleteIAAccClass
- QueryIAAccClass
- CloseIAAccClass
- ReopenIAAccClass

5.2.9.1 CreateIAAccClasMaint

This is the operation code for creating IA account class maintenance factor in Oracle FLEXCUBE. It involves the following messages:

- CreateIAAccClasMaint-Req-Full- This is the request message to create IA account class maintenance in Oracle FLEXCUBE. An external system has to send the request in the format specified. The format of the message is called 'Full-screen', which includes all the fields (input fields and the display fields) as in the corresponding Oracle FLEXCUBE front-end screen.
- CreateIAAccClasMaint-Req-IO- This is the request message to create IA account class maintenance in Oracle FLEXCUBE. An external system has to send the request in the specified format. The format of the message is called 'Input-only', which has only those fields that are actually required for creating IA account class maintenance factor.
- CreateIAAccClasMaint-Res-Full- This is the response message which is sent back to the external system when IA account class maintenance is successfully created in Oracle FLEXCUBE. The format of the message is called 'Full-screen response', which includes all the fields (input fields and the display fields) as in the corresponding Oracle FLEXCUBE screen.
- CreateIAAccClasMaint-Res-PK- This is the response message which is sent back to the external system when IA account class maintenance is successfully created in Oracle FLEXCUBE. The format of the message is called 'Primary-Key response', which includes only the primary key fields of the spend class in the Oracle FLEXCUBE data store.

5.2.9.2 AuthorizeIAAccClasMaint

This is the operation code for authorizing IA account class maintenance factor in Oracle FLEXCUBE. It involves the following messages:

- AuthorizeIAAccClasMaint-Req-Full- This is the request message to authorize IA account class maintenance in Oracle FLEXCUBE. An external system has to send the request in the format specified. The format of the message is called 'Full-screen', which includes all the fields (input fields and the display fields) as in the corresponding Oracle FLEXCUBE front-end screen.
- AuthorizeIAAccClasMaint-Req-IO- This is the request message to authorize IA account class maintenance in Oracle FLEXCUBE. An external system has to send the request in the specified format. The format of the message is called 'Input-only', which has only those fields that are actually required for creating IA account class maintenance factor.
- AuthorizeIAAccClasMaint-Res-Full- This is the response message which is sent back to the external system when an IA account class maintenance is successfully authorized in Oracle FLEXCUBE. The format of the message is called 'Full-screen response', which includes all the fields (input fields and the display fields) as in the corresponding Oracle FLEXCUBE screen.
- AuthorizeIAAccClasMaint-Res-PK- This is the response message which is sent back to the external system when IA account class maintenance is successfully authorized in Oracle FLEXCUBE. The format of the message is called 'Primary-Key response', which includes only the primary key fields of the spend class in the Oracle FLEXCUBE data store.

5.2.9.3 ModifyIAAccClasMaint

This is the operation code for modifying IA account class maintenance factor in Oracle FLEXCUBE. It involves the following messages:

- ModifyIAAccClasMaint-Req-Full- This is the request message to modify IA account class maintenance in Oracle FLEXCUBE. An external system has to send the request in the format specified. The format of the message is called 'Full-screen', which includes all the fields (input fields and the display fields) as in the corresponding Oracle FLEXCUBE front-end screen.
- ModifyIAAccClasMaint-Req-IO- This is the request message to modify IA account class maintenance in Oracle FLEXCUBE. An external system has to send the request in the specified format. The format of the message is called 'Input-only', which has only those fields that are actually required for modifying IA account class maintenance factor.
- ModifyIAAccClasMaint-Res-Full- This is the response message which is sent back to the external system when IA account class maintenance is successfully modified in Oracle FLEXCUBE. The format of the message is called 'Full-screen response', which includes all the fields (input fields and the display fields) as in the corresponding Oracle FLEXCUBE screen.
- ModifyIAAccClasMaint-Res-PK- This is the response message which is sent back to the external system when IA account class maintenance is successfully modified in Oracle FLEXCUBE. The format of the message is called 'Primary-Key response', which includes only the primary key fields of the spend class in the Oracle FLEXCUBE data store.

5.2.9.4 DeleteIAAccClasMaint

This is the operation code for deleting IA account class maintenance factor in Oracle FLEXCUBE. It involves the following messages:

- DeleteIAAccClasMaint-Req-Full- This is the request message to delete IA account class maintenance in Oracle FLEXCUBE. An external system has to send the request in the

format specified. The format of the message is called 'Full-screen', which includes all the fields (input fields and the display fields) as in the corresponding Oracle FLEXCUBE front-end screen.

- DeletelAAccClasMaint-Req-IO- This is the request message to delete IA account class maintenance in Oracle FLEXCUBE. An external system has to send the request in the specified format. The format of the message is called 'Input-only', which has only those fields that are actually required for deleting IA account class maintenance factor.
- DeletelAAccClasMaint-Res-Full- This is the response message which is sent back to the external system when an IA account class maintenance is successfully deleted in Oracle FLEXCUBE. The format of the message is called 'Full-screen response', which includes all the fields (input fields and the display fields) as in the corresponding Oracle FLEXCUBE screen.
- DeletelAAccClasMaint-Res-PK- This is the response message which is sent back to the external system when IA account class maintenance is successfully deleted in Oracle FLEXCUBE. The format of the message is called 'Primary-Key response', which includes only the primary key fields of the spend class in the Oracle FLEXCUBE data store.

5.2.9.5 QueryIAAccClasMaint

This is the operation code for querying IA account class maintenance factor in Oracle FLEXCUBE. It involves the following messages:

- QueryIAAccClasMaint-Req-Full- This is the request message to querying IA account class maintenance in Oracle FLEXCUBE. An external system has to send the request in the format specified. The format of the message is called 'Full-screen', which includes all the fields (input fields and the display fields) as in the corresponding Oracle FLEXCUBE front-end screen.
- QueryIAAccClasMaint-Req-IO- This is the request message to querying IA account class maintenance in Oracle FLEXCUBE. An external system has to send the request in the specified format. The format of the message is called 'Input-only', which has only those fields that are actually required for querying account class maintenance factor.
- QueryIAAccClasMaint-Res-Full- This is the response message which is sent back to the external system when IA account class maintenance is successfully queried in Oracle FLEXCUBE. The format of the message is called 'Full-screen response', which includes all the fields (input fields and the display fields) as in the corresponding Oracle FLEXCUBE screen.
- QueryIAAccClasMaint-Res-PK- This is the response message which is sent back to the external system when IA account class maintenance is successfully queried in Oracle FLEXCUBE. The format of the message is called 'Primary-Key response', which includes only the primary key fields of the spend class in the Oracle FLEXCUBE data store.

5.2.9.6 ClosetIAAccClasMaint

This is the operation code for closing IA account class maintenance factor in Oracle FLEXCUBE. It involves the following messages:

- ClosetIAAccClasMaint-Req-Full- This is the request message to closing IA account class maintenance in Oracle FLEXCUBE. An external system has to send the request in the format specified. The format of the message is called 'Full-screen', which includes all the fields (input fields and the display fields) as in the corresponding Oracle FLEXCUBE front-end screen.
- ClosetIAAccClasMaint-Req-IO- This is the request message to closing IA account class maintenance in Oracle FLEXCUBE. An external system has to send the request in the specified format. The format of the message is called 'Input-only', which has only those fields that are actually required for closing account class maintenance factor.

- CloseIAccClasMaint-Res-Full- This is the response message which is sent back to the external system when IA account class maintenance is successfully closed in Oracle FLEXCUBE. The format of the message is called 'Full-screen response', which includes all the fields (input fields and the display fields) as in the corresponding Oracle FLEXCUBE screen.
- CloseIAccClasMaint-Res-PK- This is the response message which is sent back to the external system when IA account class maintenance is successfully closed in Oracle FLEXCUBE. The format of the message is called 'Primary-Key response', which includes only the primary key fields of the spend class in the Oracle FLEXCUBE data store.

5.2.9.7 ReopenIAccClasMain

This is the operation code for reopening IA account class maintenance factor in Oracle FLEXCUBE. It involves the following messages:

- ReopenIAccClasMaint-Req-Full- This is the request message to reopening IA account class maintenance in Oracle FLEXCUBE. An external system has to send the request in the format specified. The format of the message is called 'Full-screen', which includes all the fields (input fields and the display fields) as in the corresponding Oracle FLEXCUBE front-end screen.
- ReopenIAccClasMaint-Req-IO- This is the request message to reopening IA account class maintenance in Oracle FLEXCUBE. An external system has to send the request in the specified format. The format of the message is called 'Input-only', which has only those fields that are actually required for reopening account class maintenance factor.
- ReopenIAccClasMaint-Res-Full- This is the response message which is sent back to the external system when IA account class maintenance is successfully reopened in Oracle FLEXCUBE. The format of the message is called 'Full-screen response', which includes all the fields (input fields and the display fields) as in the corresponding Oracle FLEXCUBE screen.
- ReopenIAccClasMaint-Res-PK- This is the response message which is sent back to the external system when IA account class maintenance is successfully reopened in Oracle FLEXCUBE. The format of the message is called 'Primary-Key response', which includes only the primary key fields of the spend class in the Oracle FLEXCUBE data store.

5.2.10 FCUBSRTService

Oracle FLEXCUBE supports the following operations under this service:

- UpdateAccPassbook
- IssueAccPassbook
- RePrintAccPassbook

5.2.10.1 UpdateAccPassbook

This is the operation code for updating passbook in Oracle FLEXCUBE. It involves the following messages:

- UpdateAccPassbook-Req-Full- This is the request message to updating passbook in Oracle FLEXCUBE. An external system has to send the request in the format specified. The format of the message is called 'Full-screen', which includes all the fields (input fields and the display fields) as in the corresponding Oracle FLEXCUBE front-end screen.
- UpdateAccPassbook-Req-IO- This is the request message to updating passbook in Oracle FLEXCUBE. An external system has to send the request in the specified format.

The format of the message is called 'Input-only', which has only those fields that are actually required for updating passbook.

- UpdateAccPassbook-Res-Full- This is the response message which is sent back to the external system when passbook is successfully updated in Oracle FLEXCUBE. The format of the message is called 'Full-screen response', which includes all the fields (input fields and the display fields) as in the corresponding Oracle FLEXCUBE screen.
- UpdateAccPassbook-Res-PK- This is the response message which is sent back to the external system when passbook is successfully updated in Oracle FLEXCUBE. The format of the message is called 'Primary-Key response', which includes only the primary key fields of the spend class in the Oracle FLEXCUBE data store.

5.2.10.2 IssueAccPassbook

This is the operation code for issuing passbook in Oracle FLEXCUBE. It involves the following messages:

- IssueAccPassbook-Req-Full- This is the request message to issuing in Oracle FLEXCUBE. An external system has to send the request in the format specified. The format of the message is called 'Full-screen', which includes all the fields (input fields and the display fields) as in the corresponding Oracle FLEXCUBE front-end screen.
- IssueAccPassbook-Req-IO- This is the request message to issuing passbook in Oracle FLEXCUBE. An external system has to send the request in the specified format. The format of the message is called 'Input-only', which has only those fields that are actually required for closing account class maintenance factor.
- IssueAccPassbook-Res-Full- This is the response message which is sent back to the external system when passbook is successfully issued in Oracle FLEXCUBE. The format of the message is called 'Full-screen response', which includes all the fields (input fields and the display fields) as in the corresponding Oracle FLEXCUBE screen.
- IssueAccPassbook-Res-PK- This is the response message which is sent back to the external system when passbook is successfully issued in Oracle FLEXCUBE. The format of the message is called 'Primary-Key response', which includes only the primary key fields of the spend class in the Oracle FLEXCUBE data store.

5.2.10.3 RePrintAccPassbook

This is the operation code for reprinting passbook in Oracle FLEXCUBE. It involves the following messages:

- RePrintAccPassbook-Req-Full- This is the request message to reprinting passbook in Oracle FLEXCUBE. An external system has to send the request in the format specified. The format of the message is called 'Full-screen', which includes all the fields (input fields and the display fields) as in the corresponding Oracle FLEXCUBE front-end screen.
- RePrintAccPassbook-Req-IO- This is the request message to reprinting passbook in Oracle FLEXCUBE. An external system has to send the request in the specified format. The format of the message is called 'Input-only', which has only those fields that are actually required for reopening account class maintenance factor.
- RePrintAccPassbook-Res-Full- This is the response message which is sent back to the external system when passbook is successfully reprinted in Oracle FLEXCUBE. The format of the message is called 'Full-screen response', which includes all the fields (input fields and the display fields) as in the corresponding Oracle FLEXCUBE screen.

RePrintAccPassbook-Res-PK- This is the response message which is sent back to the external system when passbook is successfully reprinted in Oracle FLEXCUBE. The format of the message is called 'Primary-Key response', which includes only the primary key fields of the spend class in the Oracle FLEXCUBE data store.

6. Function ID Glossary

C

CODSORCE3-7
CODUPLDM3-8

G

GWDAMDMT3-25
GWDEXFUN3-5
GWDINBRW3-11
GWDNTFEN3-22
GWDNTFIN3-20

GWDOTBRW 3-17
GWSEXFUN 3-6
GWSEXSYS 3-3
GWSINBRW 3-13
GWSNTFEN 3-23
GWSNTFIN 3-21
GWSOTBRW 3-19
GWSPBROW 3-14, 3-16

S

STDGWINT 3-24