

Oracle FLEXCUBE Process Framework User Guide

Oracle FLEXCUBE Universal Banking

Release 14.5.0.0.0

Part No. F42208-01

May 2021

Oracle FLEXCUBE Process Framework User Guide
Oracle Financial Services Software Limited
Oracle Park

Off Western Express Highway
Goregaon (East)
Mumbai, Maharashtra 400 063
India

Worldwide Inquiries:

Phone: +91 22 6718 3000

Fax: +91 22 6718 3001

<https://www.oracle.com/industries/financial-services/index.html>

Copyright © 2007, 2024, Oracle and/or its affiliates. All rights reserved.

Oracle and Java are registered trademarks of Oracle and/or its affiliates. Other names may be trademarks of their respective owners.

U.S. GOVERNMENT END USERS: Oracle programs, including any operating system, integrated software, any programs installed on the hardware, and/or documentation, delivered to U.S. Government end users are “commercial computer software” pursuant to the applicable Federal Acquisition Regulation and agency-specific supplemental regulations. As such, use, duplication, disclosure, modification, and adaptation of the programs, including any operating system, integrated software, any programs installed on the hardware, and/or documentation, shall be subject to license terms and license restrictions applicable to the programs. No other rights are granted to the U.S. Government.

This software or hardware is developed for general use in a variety of information management applications. It is not developed or intended for use in any inherently dangerous applications, including applications that may create a risk of personal injury. If you use this software or hardware in dangerous applications, then you shall be responsible to take all appropriate failsafe, backup, redundancy, and other measures to ensure its safe use. Oracle Corporation and its affiliates disclaim any liability for any damages caused by use of this software or hardware in dangerous applications.

This software and related documentation are provided under a license agreement containing restrictions on use and disclosure and are protected by intellectual property laws. Except as expressly permitted in your license agreement or allowed by law, you may not use, copy, reproduce, translate, broadcast, modify, license, transmit, distribute, exhibit, perform, publish or display any part, in any form, or by any means. Reverse engineering, disassembly, or decompilation of this software, unless required by law for interoperability, is prohibited.

The information contained herein is subject to change without notice and is not warranted to be error-free. If you find any errors, please report them to us in writing.

This software or hardware and documentation may provide access to or information on content, products and services from third parties. Oracle Corporation and its affiliates are not responsible for and expressly disclaim all warranties of any kind with respect to third-party content, products, and services. Oracle Corporation and its affiliates will not be responsible for any loss, costs, or damages incurred due to your access to or use of third-party content, products, or services.

Contents

1. Preface	1-1
1.1 Introduction.....	1-1
1.2 Audience.....	1-1
1.3 Documentation Accessibility.....	1-1
1.4 Abbreviations.....	1-1
1.5 Organization	1-1
1.6 Related Documents	1-1
1.7 Glossary of Icons.....	1-2
2. Getting Started with Oracle FLEXCUBE Process Framework	2-1
2.1 Landing Page	2-1
2.1.1 <i>Tasks</i>	2-2
2.1.2 <i>Quick Search</i>	2-4
2.1.3 <i>Application</i>	2-4
2.1.4 <i>Dashboard</i>	2-5
2.1.5 <i>Queue</i>	2-5
2.1.6 <i>Scheduling Acquired Tasks</i>	2-9
2.1.7 <i>Holding a Task</i>	2-10
2.1.8 <i>Quick View</i>	2-11
2.2 Viewing Stage Status	2-11
2.3 UCM Document Editor.....	2-12
2.4 BAM or BIP or OBIEE Maintenance	2-14
3. Origination Dashboards	3-1
3.1 Maintenances	3-1
3.1.1 <i>Maintaining Origination Dashboard Details</i>	3-1
3.1.2 <i>Maintaining Origination Dashboard Role Details</i>	3-4
3.2 Process Code Maintenance	3-5
3.2.1 <i>Maintaining Process Code Details</i>	3-6
3.2.2 <i>Business View of Stage Status</i>	3-7
3.3 Dashboards	3-9
4. Configurations	4-1
4.1 Configuring Landing Page	4-1
4.2 Configuring Queues.....	4-3
4.3 Configuring Sub-Stages	4-5
4.4 Checking Duplicate Transactions.....	4-6
4.5 Enabling User Rights	4-7
4.6 Task Assignment Workflow	4-8
4.6.1 <i>Configuring Workflow Task Assignment</i>	4-8
4.6.2 <i>Task Assignment Methods</i>	4-9
4.6.3 <i>Task Assignment Component</i>	4-15
4.6.4 <i>Process, Stage, Assignment Model and Roles Mapping Definition Screen</i>	4-16
4.6.5 <i>User Availability Details</i>	4-16
4.6.6 <i>Task Reassignment</i>	4-17
5. Reports	5-1

5.1	List of Task Assignment Rules Report	5-1
5.1.1	<i>Generating Task Assignment Rules Report</i>	5-1
5.1.2	<i>Contents of the Report</i>	5-1
5.2	Workflow Task Audit Log Report	5-2
5.2.1	<i>Generating Workflow Task Audit Log Report</i>	5-2
5.2.2	<i>Contents of the Report</i>	5-3
5.3	User Work Load Logically Grouped Based on Supervisor Report	5-3
5.3.1	<i>Generating Work Load Report of the User</i>	5-4
5.3.2	<i>Contents of the Report</i>	5-4
5.4	Assignment Vs Completed Analysis Report	5-5
5.4.1	<i>Generating Assignment Vs Completed Analysis Report</i>	5-5
5.4.2	<i>Contents of the Report</i>	5-5
5.5	Load Factor Report.....	5-6
5.5.1	<i>Generating Load Factor Report</i>	5-6
5.5.2	<i>Contents of the Report</i>	5-7
6.	Function ID Glossary	6-1

1. Preface

1.1 Introduction

This manual helps you get acquainted with the Process Framework module of Oracle FLEXCUBE Universal Banking system. This manual explains the basic design of Oracle the process framework and the common operations that you will follow while using it.

1.2 Audience

This manual is intended for the back-end and front-end staff who setup/use Oracle FLEXCUBE Universal Banking process framework.

1.3 Documentation Accessibility

For information about Oracle's commitment to accessibility, visit the Oracle Accessibility Program website at <http://www.oracle.com/pls/topic/lookup?ctx=acc&id=docacc>.

1.4 Abbreviations

The following abbreviations are used in this User Manual:

Abbreviation	Description
BPEL	Business Process Execution Language
WF	Workflow

1.5 Organization

This manual is organized as follows:

Chapter	Description
Chapter 1	<i>Preface</i> gives information on the intended audience. It also lists the various chapters covered in this User Manual.
Chapter 2	<i>Getting Started with Oracle FLEXCUBE Process Framework</i> explains the features of Oracle FLEXCUBE process framework accessible from the landing page.
Chapter 3	<i>Origination Dashboards</i> provides the details of origination dashboards in Oracle FLEXCUBE system.
Chapter 4	<i>Configurations</i> explains the methods to configure Queues, Landing and Sub-stages to suit your bank's requirements.
Chapter 5	Function ID Glossary contains the function IDs mentioned in this user manual.





1.6 Related Documents

- Security Management System user manual

- Procedures user manual

1.7 Glossary of Icons

This User Manual may refer to all or some of the following icons:

Icons	Function
	Exit
	Add row
	Delete row
	Option List

2. Getting Started with Oracle FLEXCUBE Process Framework

This chapter explains the features of Oracle FLEXCUBE process framework accessible from the landing page.

Each transaction in workflow can be configured as a process. At certain points in a process, input from the user-end is required. The input could be in the form of data to initiate or enrich a transaction or to authorize an existing transaction. To facilitate this, human tasks are generated by the workflow engine as and when required during the process. These human tasks are associated with a Function ID. When a user initiates a task, the different user roles associated to the Function ID are assigned to the task.

Also, each process (transaction) passes through the workflow layer in stages. Access to each stage is restricted to users who have the requisite rights. Once a task has been initiated or completed for a particular stage, it is placed in the relevant queue or task list (explained later). To proceed further with the process, a user - with relevant rights - needs to acquire it under his/her user ID.

Note

Oracle FLEXCUBE supports the co-existence of multiple composite versions of BPMN (Business Process Models and Notations) and BPEL process models. In BPMN processes, you can query the first task of a process by querying with the conversation id. You can customise the BPMN process using the BPM Composer.

This chapter contains the following sections:

- [Section 2.1, "Landing Page"](#)
- [Section 2.2, "Viewing Stage Status"](#)
- [Section 2.3, "UCM Document Editor"](#)
- [Section 2.4, "BAM or BIP or OBIEE Maintenance"](#)

2.1 Landing Page

This section contains the following topics:

- [Section 2.1.1, "Tasks"](#)
- [Section 2.1.2, "Quick Search"](#)
- [Section 2.1.3, "Application"](#)
- [Section 2.1.4, "Dashboard"](#)
- [Section 2.1.5, "Queue"](#)
- [Section 2.1.6, "Scheduling Acquired Tasks"](#)
- [Section 2.1.7, "Holding a Task"](#)
- [Section 2.1.8, "Quick View"](#)

2.1.1 Tasks

When you log into the application, the Landing Page, as shown below, is displayed:-

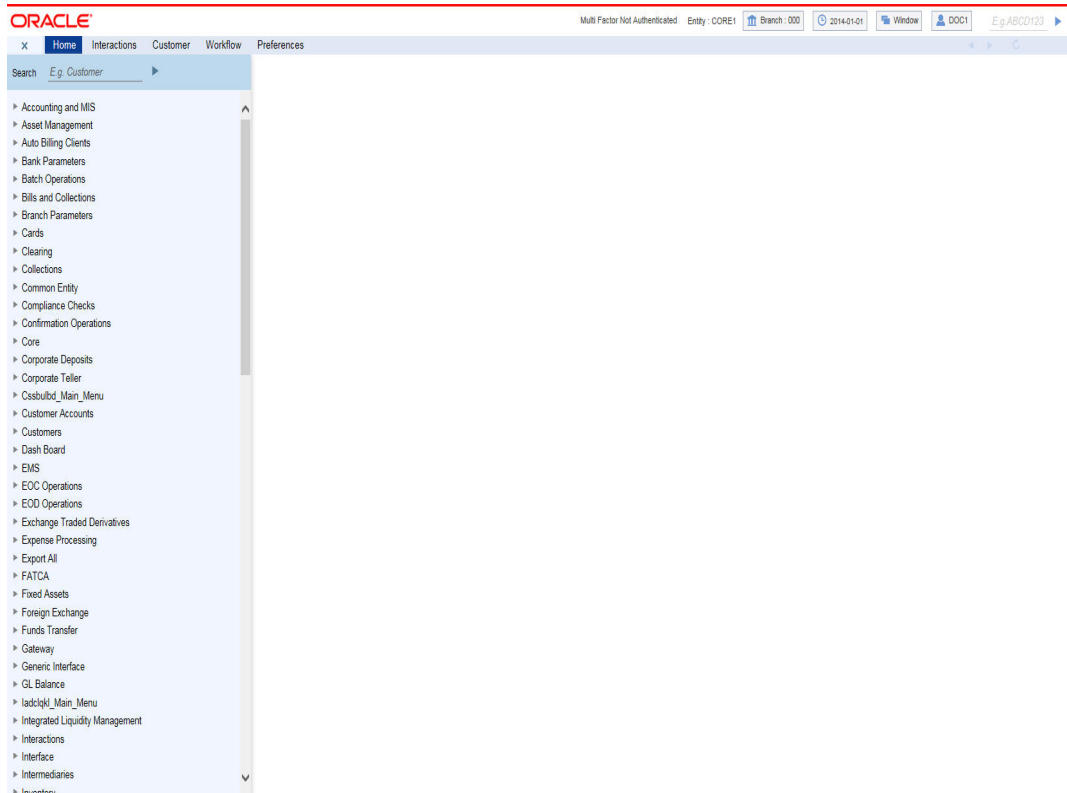

The following options are available to you in this screen:

- Menu
- Interactions
- Customer
- Workflow
- Tasks
- Preferences

Select 'Tasks' tab to view the tasks.

The screenshot displays the Oracle 'Tasks' tab. The top navigation bar includes 'Home', 'Interactions', 'Customer', 'Workflow', 'Tasks', and 'Preferences'. The 'Tasks' tab is active. Below the navigation bar, there is a search bar and a list of task categories. The categories include: Quick Search, Application #, Application, Origination Dashboard, Acceptance/Confirmation, Application Verification, Application Verification, Document Verification, Document Verification, Know Your Customer, Lending Approval, My Personalizations, Productivity of the Day, Standard, Underwriting, demo_1, demo_ap, Queue, Search, Administrative, Application Statuses Across Various Parameters, Applications, Count Across Conventional High 1, Count Across Conventional Low, Count Across Conventional Medium, and Quick View. At the bottom, there is a 'Summary Dash Board' table with the following data:

Queue Name	Count
Initiated	0
Reviewed	0
Processed	0
Cancelled	0
Approved	0
Funded	0

You have the following options under tasks:

- Quick Search
- Application
- Dashboard
- Queue
- Quick View

2.1.2 Quick Search

If you know the application number, you can quickly search for an application using the quick search feature.

Workflow Reference	Transaction Reference	Title	Assignee Users	Customer Name	Creation Date(From/To)	Priority	Channel	Originated By	Status
OpenSavingsAccount2683		Receive And Verify		FAIZY1	2013-06-22 12:12:46 IST	Low			RECVNWF
OpenSavingsAccount2735		Input savings account details			2013-06-24 18:07:02 IST	Low			RECVNWF
RetailLending2836		Loan Approval	Abel		2013-06-28 10:33:50 IST	Low			UNAPPR
RetailLending2837		Loan Approval	Abel		2013-06-28 10:47:36 IST	Low			UNAPPR
OpenSavingsAccount2883		Input savings account details		ORDLEADM11	2013-06-29 13:15:10 IST	Low	Internet	35258AA	INPUTDTL

Specify the application number and click the adjoining search button. You can also specify a part of the application number. If the application number of any record has the number you have specified as a part of it, then the system will fetch that record.

Click any record to view the details.

2.1.3 Application

Under 'Application' section, you can view the menu to access the Oracle FLEXCUBE Origination screens.

- Application
 - Maintenance
 - Operations
 - Reports
 - Templates
 - View

You can expand the menu items and invoke the Origination screens.

2.1.4 Dashboard

Under 'Dashboard' section, you can view the list of the maintained and configured dashboards along with the default dashboards.

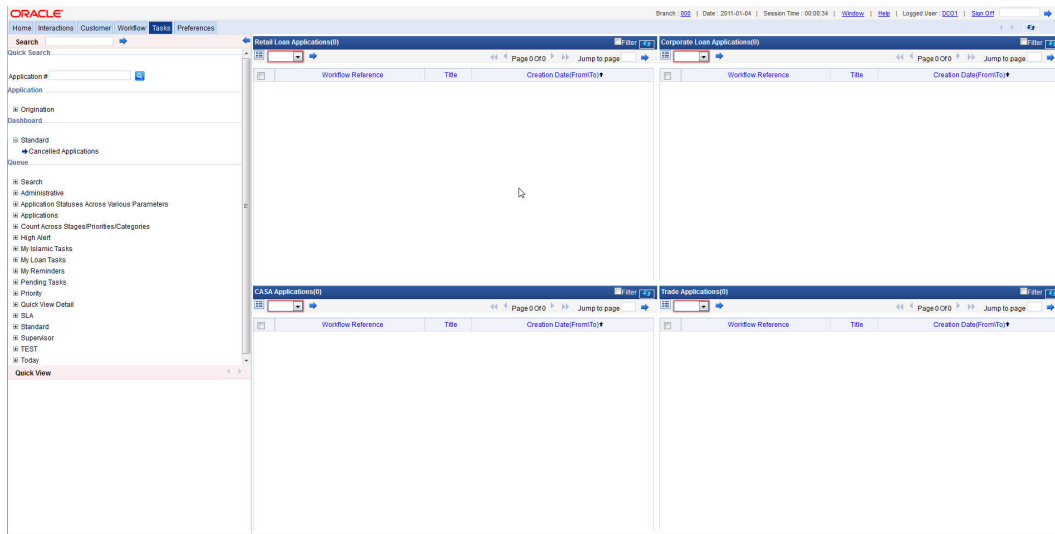

You can expand the menu items and invoke the dashboards.

2.1.5 Queue

The 'Queue' menu displays the tasks under various queues. You can expand the menu and view the number of tasks under each queue.

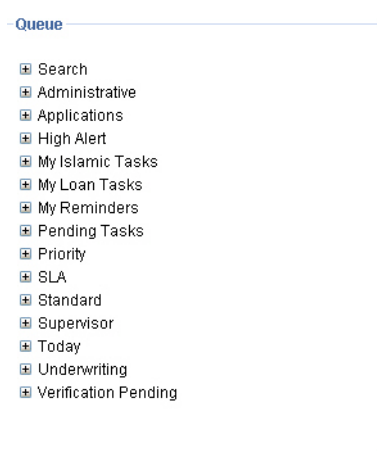

If you select 'Search' and then click 'All', the 'Task List - Search' window will be displayed on the right hand side.

Task List - Search					
Workflow Reference	=	<input type="text"/>	Customer Name	=	<input type="text"/>
Transaction Reference	=	<input type="text"/>	Creation Date(FromTo)	=	<input type="text"/> <input type="text"/>
Title	=	<input type="text"/>	Priority	=	<input type="text"/>
Assignee Group	=	<input type="text"/>	Channel	=	<input type="text"/>
Originated By	=	<input type="text"/>	Reminder	=	<input type="text"/> <input type="text"/>
Status	=	<input type="text"/>	Currency	=	<input type="text"/>
Comments	=	<input type="text"/>	<input type="button" value="Search"/>		
Amount	=	<input type="text"/>			

Here you need to input value for querying on the tasks. You can provide values for any or all of the following criteria:

- Work Reference
- Transaction Reference
- Title
- Assignee Group
- Assignee Users
- Customer Name
- Creation Date (From\To)
- Priority
- Channel – Channel from which the origination is initiated. In the search criteria, you can specify values available in 'COTMSOURCE' table of the 'Channel' field. These values are displayed in the 'Originated By' field of all stages of workflow.
- Originated By – Originator of the workflow
- Status – Status of the origination
- Comments

Click 'Search' button to initiate the query. Based on the details specified, the system will display all tasks satisfying the search criteria.

If you select 'Standard View', the system will display the number of records available in each of the task queues viz. 'Acquired', 'Assigned', 'Completed', 'Pending' and 'Supervisor'. Click the links to view the respective details in the right pane.

The Pending List displays tasks which are not yet acquired by anyone. On acquiring, the task goes to the Assigned List. From the Assigned List, you can capture the task and input the action. Then the transaction goes to Completed stage.

The following queues are available on this screen:

- Standard - this is the standard queue, which displays acquired, assigned, pending and completed applications
- Administrative - this queue displays the list of staled applications
- Applications - this queue lists the applications in each process
- Priority - this queue lists the applications with respect to their priority
- SLA - this queue lists the aging and expired applications
- Supervisor - this queue displays the applications escalated by the sub-ordinates and the list of acquired tasks

2.1.5.1 Operations under Standard Queue

The workflow actions that you can perform for a task are:

Acquire/Release

After a task is assigned to a group, you, as a user, can further process the task only if you acquire it. Select the transaction and click 'Acquire' button. The task will then be moved from the group queue to your task list. You can release the task that has already been acquired by clicking 'Release' button.

Reassign

A task can be re-assigned only by a supervisor to any of his subordinates. If you have the requisite rights, you can select the transaction and click 'Reassign' button in your task list. This is done when a contract is transferred from the maker of the contract to another user for further operations.

Resume

A task that has been suspended can be resumed when you click the 'Resume' button in your task list. You can then continue with the suspended task.

The system also gives you the option of carrying out the same action on many tasks simultaneously. To do this, you are required to select all the tasks that you want, by checking the box at the beginning of each row. The operations common to all the tasks are listed at the top of the Task Pane. You can select the appropriate one. The chosen action will be implemented for all the selected tasks. For example, after choosing the tasks that you require, you can acquire all of them in bulk (if the 'Acquire' operation is allowed for all the tasks).

Copy

A selected task can be copied by clicking on 'Copy' button in your task list. You can assign a task only if the task is assigned to your user role/ID.

Escalate

System allows you to escalate a task to a supervisor or a higher authority. Follows are the types of escalations:

- Auto Escalation - When a task remains acquired yet un-attended at the end of the specified time span, system automatically escalates the task to the user's supervisor. If the supervisor does not take any action for the same time period, then system escalates the task to the second level in the hierarchy. This process goes on for a per-defined number of levels.
- Manual Escalation - In case a task requires an action from a higher authority, you can manually escalate a task to the user's supervisor by clicking the 'Escalate' button in the task list.

A task can be escalated only if it is acquired.

On clicking the 'Escalate' button, the system invokes the 'Comments' screen.

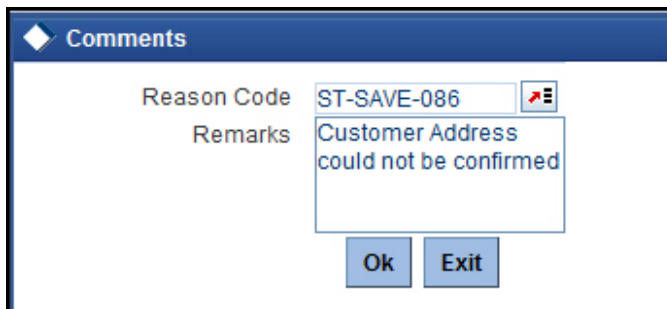

The system prompts to enter the following details:

Reason Code

Select the reason code from the adjoining option list. This list displays all valid reason codes maintained as 'Common'.

Remarks

Specify the reason for escalation here.

On escalation, the task appears under the 'Escalated' option in the Supervisor queue. When the supervisor opens the escalated task, system displays the reason of escalation and remarks as an information message.

2.1.5.2 Opening Multiple Queues

You can open multiple queues as tabs and perform the required tasks in each queue.

The screenshot shows the Oracle Supervisor interface. At the top, there are navigation tabs: Home, Interactions, Customer, Workflow, Tasks, and Preferences. Below this is a search bar and a 'Filters' section with various dropdown menus for Workflow Reference, Transaction Reference, Title, Assignee Users, Customer Name, Creator Date, Priority, Channel, and Status. A 'Low-Task List' table is displayed below the filters, showing a list of tasks with columns for Workflow Reference, Transaction Reference, Title, Assignee Users, Customer Name, Creation Date, Priority, Channel, Originated By, and Status. The table contains several rows of task data.

Workflow Reference	Transaction Reference	Title	Assignee Users	Customer Name	Creation Date	Priority	Channel	Originated By	Status
OpenSavingsAccount2735	OpenSavingsAccount2735	Input savings account details			2013-06-24 18:07:02 IST	Low			RECEIVED
OpenSavingsAccount2779	OpenSavingsAccount2779	Check Available Balance			2013-06-26 08:47:15 IST	Low			SALEACCOUNT
OpenSavingsAccount2782	OpenSavingsAccount2782	Input savings account details			2013-06-26 09:01:11 IST	Low			RECEIVED
OpenSavingsAccount2811	OpenSavingsAccount2811	Receive And Verify			2013-06-27 15:18:16 IST	Low			RECEIVED
OpenSavingsAccount2812	OpenSavingsAccount2812	Input savings account details			2013-06-27 15:20:14 IST	Low			RECEIVED
RetailLending2836	RetailLending2836	Loan Approval	Abel		2013-06-28 10:33:50 IST	Low			UNAPPR
RetailLending2837	RetailLending2837	Loan Approval	Abel		2013-06-28 10:47:39 IST	Low			UNAPPR
IslamicIslamicAccount2846	IslamicIslamicAccount2846	Application Entry		Retail_Customer_NRP_Lead_Enh	2013-06-28 12:52:42 IST	Low			NEWAPP
OpenSavingsAccount2883	OpenSavingsAccount2883	Input savings account details	ORACLEADM11		2013-06-29 13:15:10 IST	Low	Internet	36258AA	INPUTDTLS

Check the 'Apply Filters' box for a detailed search in a particular task in the queue. System displays the following tabs in each queue:

- History
- Interactions
- Documents
- Advices

History

Under the 'History' tab, system displays the audit trail for the selected task.

Title	Action Time	Pick Up Time	User ID	User Name	Action Code	Action Description	Branch	Remarks	View
Receive And Verify	Wed Aug 28 20:39:43 IST 2013	Wed Aug 28 20:38:42 IST 2013	fcatotp	FCATOP	PROCEED	PROCEED	002		View
Approve Account Opening	Thu Aug 29 12:03:31 IST 2013	Wed Aug 28 20:39:46 IST 2013	m23403	Venkat Maker	APPROVE	APPROVE	002		View
Input savings account details	Thu Aug 29 12:05:04 IST 2013	Thu Aug 29 12:03:31 IST 2013	m23403	Venkat Maker	PROCEED	PROCEED	002		View
Verify savings account details	Thu Aug 29 12:05:21 IST 2013	Thu Aug 29 12:05:04 IST 2013	m23403	Venkat Maker	APPROVED	APPROVED	002		View

Click the 'View' button to view the corresponding task screen.

Interactions

Under the 'Interactions' tab, system displays the customer interactions captured for a particular Application.

History	Interactions	Documents	Advices
Conversation ID			
Customer ID			
Conversation Date			
Subject			
Original Request			
Customer Reply			
Details			

System displays the relevant details for the selected task in the queue.

Documents

Under the 'Documents' tab, you can view the documents maintained for a particular task at each stage.

History	Interactions	Documents	Advices		
Title	Category	Document Ref No	Document Type	Remarks	View

Click the 'View' button to view the relevant documents for the selected task in the queue.

Advices

Under the 'Advices' tab, you can view the advices generated for a particular task at each stage.

History	Interactions	Documents	Advices		
Title	Report Description	Report Name	Document Name	Document Ref No	View

System displays the advices for the selected task in the queue.

Click the 'View' button to view the advices generated for a particular task.

2.1.6 Scheduling Acquired Tasks

Oracle FLEXCUBE allows you to schedule you acquired tasks for a specific day/time based on your work structure, by setting reminders for the acquired tasks in your task list.

Acquired-Task List									
Acquire Release Resume Renew Reassign Escalate Copy Stage Status Page 1 Of 1 Jump to page Go									
	Workflow Reference	Transaction Reference	Title	Assignee Group	Customer Name	Amount	Creation Date(FromTo)	Priority	
<input checked="" type="checkbox"/>	aka7093		LoanApproval	ALLROLES-001,ORIG-ROLE-001,ROLESCM-001			2012-10-26 10:50:33 IST	Low	Highlight Task Set Reminder Close
<input type="checkbox"/>	ahAccount7115		IslamicMudarabahAccount	ALLROLES-000,ROLESCE-000,ROLESCM-000			2012-10-26 18:03:03 IST		
<input type="checkbox"/>	CreateCorporateCustomer7382		Input Basic Details	ALLROLES-000,CORMROLE-000,CRMROLE-000			2012-11-12 17:47:46 IST		

You can set a reminder by clicking the Reminder button for a task. System displays the following list of activities in the drop-down list:

- Highlight Task - Select this option to highlight the task.
- Set Reminder - Select this option to schedule a reminder. On selecting this option, system invokes the 'Reminder' screen. In this screen, you can select the reminder date, time and remarks. Depending on the scheduled reminder time, system automatically sets the flag colour.

In case a reminder has already been set for a task, on clicking the reminder flag, you will get the following options:

- View Reminder - Select this option to view the set reminders at any point of time. On selecting this option, system displays an information message with the reminder date or time and the remarks provided.
- Reset Reminder - Select this option to change/reset an existing reminder with a new date, time and remarks.
- Dismiss Reminder - Select this option to dismiss a reminder.

On setting a reminder, system sets the reminder flag for the task. Reminder flags are colour-coded to differentiate between time-spaced and time-barred tasks. When a task crosses the scheduled reminder date or time, the flag turns from green to red (tasks which that not cross the scheduled date or time will have green flags). At any point of time, you can view the reminder date, time and remarks, if any.

System allows you to set reminders for multiple tasks together. Select the tasks for which you want to set reminders and then select the appropriate option.

2.1.7 Holding a Task

You can hold a task from processing using 'Hold' button. When you withhold a task for some purpose, you can add a comment stating the reason for holding the task.

Specify the reason code for holding the task.

When you pick up the held task again from the 'Pending' queue, the system will remind you of the hold and display the reason and remarks as an information message.

2.1.8 Quick View

You can view the configured quick access dashboards in the Quick View. This frame consists of crisp and precise task-related information.

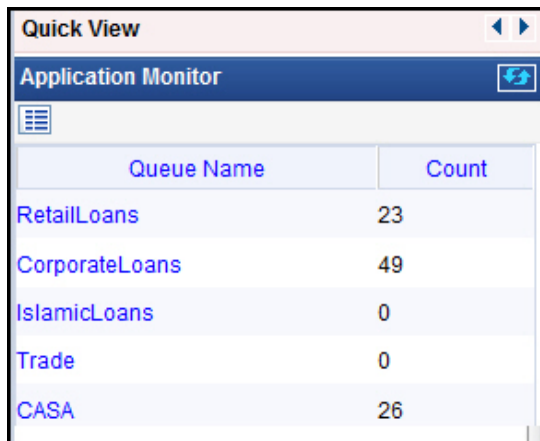

Queue Name	Count
RetailLoans	23
CorporateLoans	49
IslamicLoans	0
Trade	0
CASA	26

You can configure a dashboard for quick access by checking the 'Default' box in the 'Origination Dashboard Role Maintenance' screen.

2.2 Viewing Stage Status

In BPMN processes, the system allows you to view the flow diagram and the current stage of a particular task. On clicking the 'Stage Status' button in the task list, system displays the flow diagram, for the selected task, in a separate window.

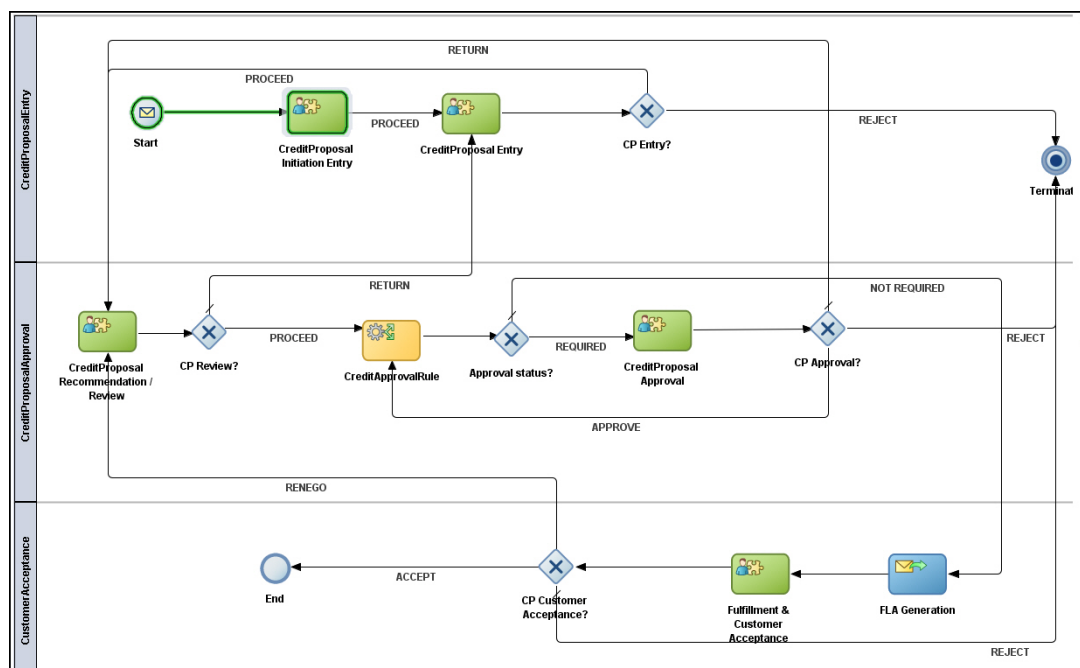

Note

System supports the Stage Status image only for BPMN Processes.

2.3 UCM Document Editor

You can upload and view the documents through the 'Documents' screen.

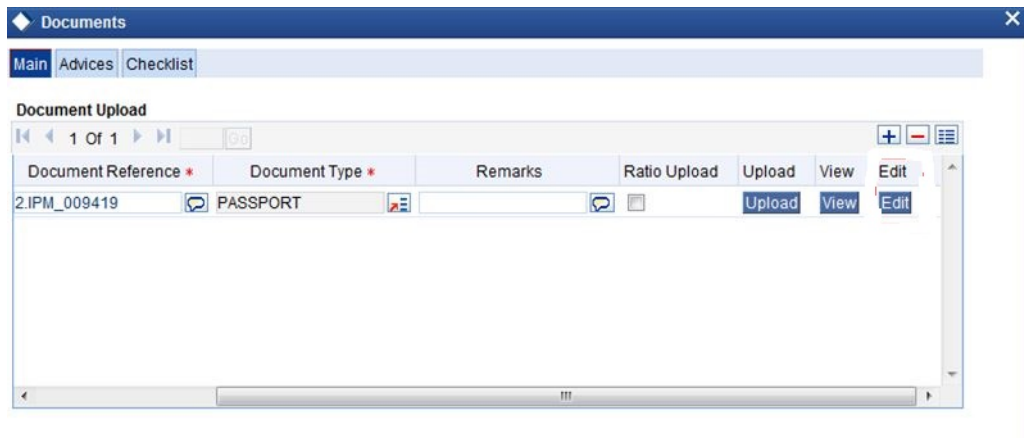

Main

Document Reference

Specify the document reference number.

Document Type

Select the type of document. The adjoining option list displays all the document types maintained in the system. Select the appropriate one.

Remarks

Specify remarks, if any.

Ratio Upload

Check this box if you require ratio upload.

Upload

Click 'Upload' button to open the 'Document Upload' sub-screen.

In the 'Document Upload' sub-screen, specify the corresponding document path and click the 'Submit' button. Once the document is uploaded through the upload button, the system displays the document reference number.

View

Click 'View' to view the document uploaded.

Edit

Using the 'Edit' button, you can edit the document details. When you click 'Edit' button, the system invokes a screen that displays the document and the properties

You can modify the document related information and click 'Update' button to update the changes. The system saves the changes made to the document.

Note

The changes made to the document using this Edit option will not be reverted even if you do not save the transaction. If you wish to revert the changes, you need to invoke the Document screen and manually modify it again.

Advices

Click 'Advices' tab in Documents screen to view advice details.

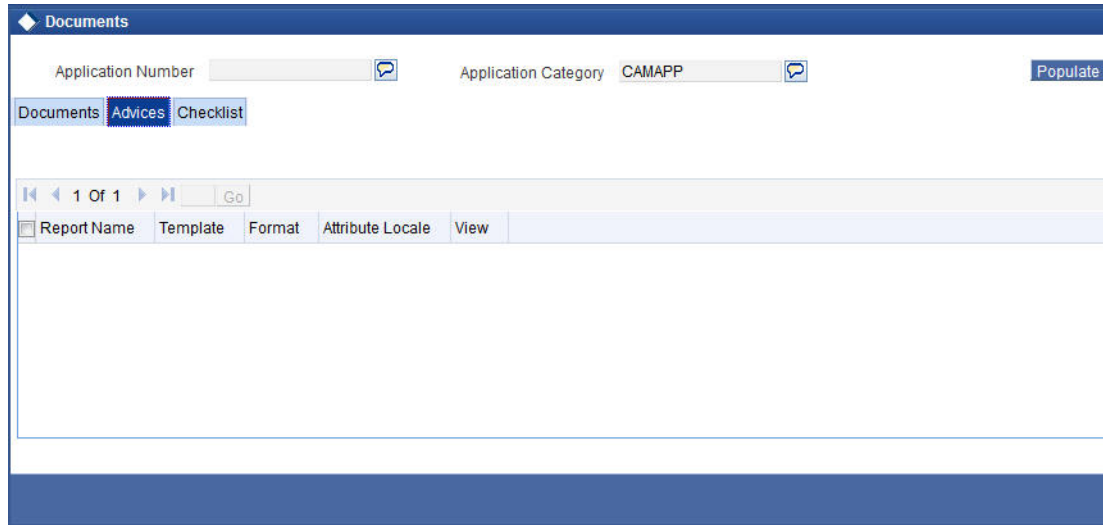

The screenshot shows the 'Documents' screen with the 'Advices' tab selected. At the top, there are search filters for 'Application Number' and 'Application Category' (set to 'CAMAPP'), along with a 'Populate' button. Below the filters are three tabs: 'Documents', 'Advices' (highlighted), and 'Checklist'. A pagination bar shows '1 Of 1' with navigation arrows and a 'Go' button. Below the pagination is a table header with columns: 'Report Name', 'Template', 'Format', 'Attribute Locale', and 'View'. The table body is currently empty.

Report Name

The system displays the report name.

Template

The system displays the template.

View

Click 'View' to view the document.

Checklist

Click 'Checklist' tab in Documents screen to view checklist details

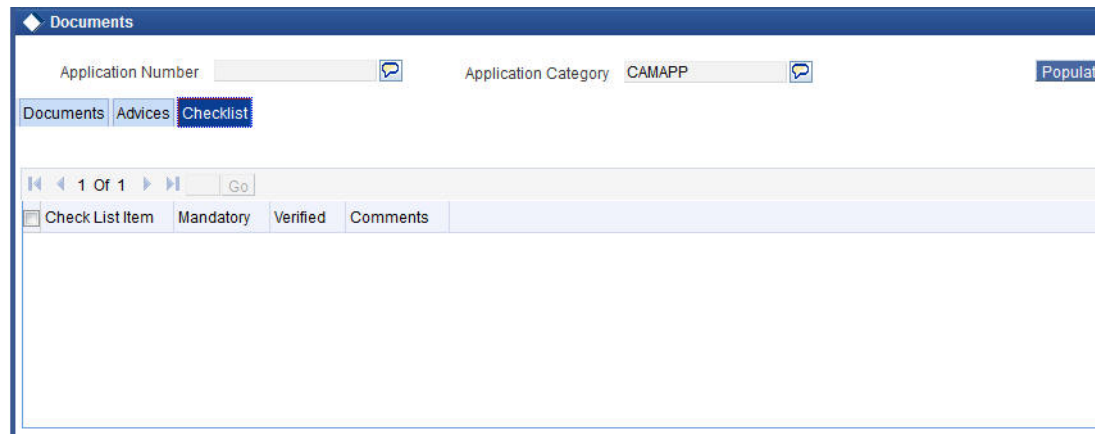

The screenshot shows the 'Documents' screen with the 'Checklist' tab selected. At the top, there are search filters for 'Application Number' and 'Application Category' (set to 'CAMAPP'), along with a 'Populate' button. Below the filters are three tabs: 'Documents', 'Advices', and 'Checklist' (highlighted). A pagination bar shows '1 Of 1' with navigation arrows and a 'Go' button. Below the pagination is a table header with columns: 'Check List Item', 'Mandatory', 'Verified', and 'Comments'. The table body is currently empty.

Checklist Item

The system displays the checklist details.

Mandatory

This field is updated based on the maintenances in Documents sub screen.

Verified

Check this box to indicate whether the documents are verified.

Comments

Specify comments, if any.

2.4 BAM or BIP or OBIEE Maintenance

You can invoke the 'BAM or BIP or OBIEE Maintenance' screen by typing 'ORDBAMMT' in the field at the top right corner of the Application tool bar and clicking the adjoining arrow button

The screenshot displays a web application window titled "BAM or BIP or OBIEE Report Maintenance Screen". The window contains a "New" form with the following fields:

- Report Id ***: A text input field.
- Report Description**: A text input field.
- Report Type**: A dropdown menu with "BAM - Business Analysis Monitoring" selected.
- Url**: A text input field.
- Report Parameters**: A text input field.

At the bottom of the form, there is a section for user and record information:

- Maker**: A text input field.
- Checker**: A text input field.
- Date Time:**: A text input field (appears twice).
- Mod No**: A text input field.
- Record Status**: A text input field.
- Authorization Status**: A text input field.
- Exit**: A blue button.

Report Id

Specify the Report Id.

Report Description

Specify the Report description.

Report Type

Select the type of report that has to be maintained. The options are:

- BAM-Business Analysis Monitoring
- BIP- Business Intelligence Publisher
- OBIEE- Oracle Business Intelligence Enterprise Edition

URL

Specify the URL.

Report Parameters

specify the Report parameter.

Dashboards from different analytical tools like BAM, BIP or OBIEE can be integrated with FCUBS Origination Dashboard.

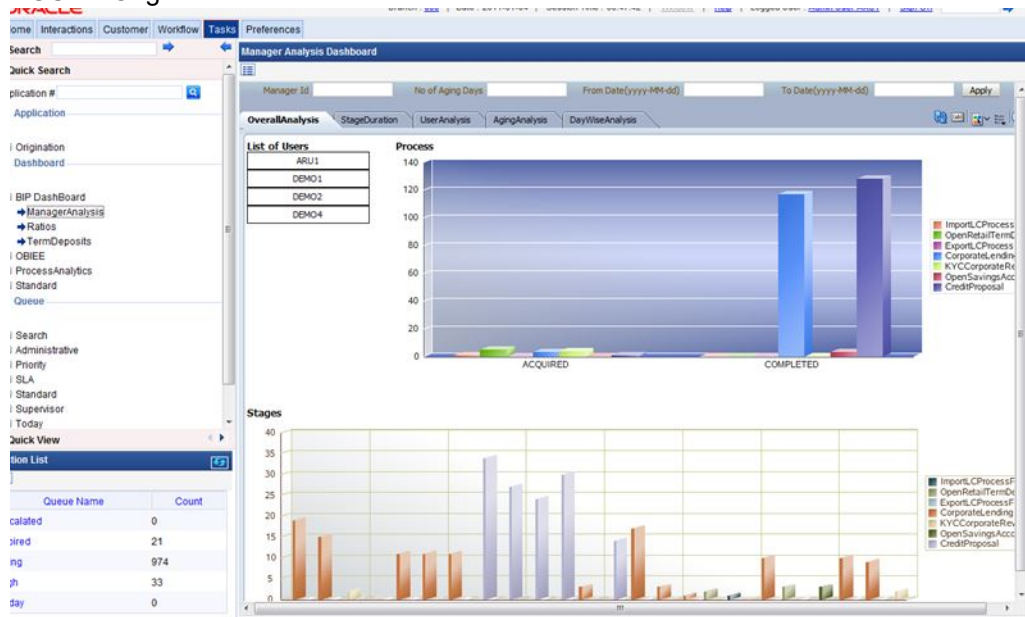

3. Origination Dashboards

This chapter contains the following sections:

- [Section 3.1, "Maintenances"](#)
- [Section 3.2, "Process Code Maintenance"](#)
- [Section 3.3, "Dashboards"](#)

3.1 Maintenances

This section contains the following topics:

- [Section 3.1.1, "Maintaining Origination Dashboard Details"](#)
- [Section 3.1.2, "Maintaining Origination Dashboard Role Details"](#)

3.1.1 Maintaining Origination Dashboard Details

You can maintain dashboard related information using the 'Origination Dashboard Maintenance' screen. You can invoke this screen by typing 'ORDDSHMT' in the field at the top right corner of the Application tool bar and clicking the adjoining arrow button.

The screenshot displays the 'Dashboard Maintenance Screen' with the following elements:

- Header:** 'Dashboard Maintenance Screen' and a 'New' button.
- Form Fields:** 'Dashboard Id *' (with a red asterisk), 'Partition Per Page *' (with a red asterisk and value '6'), and 'Description'.
- Dashboard Mapping Details:** A table with columns: Sequence Number, Queue Type, Queues, Report Id, Fields, and Action. A 'Go' button is present above the table.
- Dashboard Menu Details:** A table with columns: Language Code *, Main Menu *, and Sub Menu *. A 'Go' button is present above the table.
- Footer:** 'Maker', 'Date Time:', and 'Mod No'.

Specify the following details:

Dashboard Id

Specify the dashboard id here.

Partition Per Page

Specify the number of partitions to be displayed per page.

Description

The system displays the dashboard description in the task pane.

Dashboard Mapping Details

Sequence Number

Specify the sequence number for the dashboard. It is used to sequence the order in which the frames are displayed in dashboard.

Queue Type

Select the queue type from the adjoining drop-down list. This list displays the following values:

- Queue - If you select this option, then system displays all valid queue ids in the 'Queue Id' option list.
- Count - If you select this option, then system displays the title for the frame selected. This is used when you want to configure a summary dashboard having multiple queue and their corresponding count.
- Report- If you select this option, then system displays all valid report ids in the Report Id option list.
- Alert Summary- If you select this option, then system displays all valid Queue Ids and report ids in the Queue Id and Report Id option list
- Summary- If you select this option, then system displays all valid Queue Ids in the Queue Id option list.

Queue ID

If the 'Queue Type' is 'Queue', then the adjoining option list displays all valid queue ids maintained in the system. If the 'Queue Type' is 'Count', then the adjoining option list displays the title for the view.

Report Id

Select the report id for the dashboard from the adjoining option list. This list displays all valid report ids maintained in the system.

Fields

System displays the fields of the dashboard here, based on the fields selected from the 'Mapping Details' screen.

Actions

System displays the fields of the dashboard here, based on the fields selected from the 'Mapping Details' screen.

Note

Each dashboard should have minimum one and maximum six frames. If more than six dashboards are mapped to the main menu dashboard, then system displays the error message, "Cannot map more than 6 Queues for a Dashboard."

Dashboard Menu details

Language Code

Specify the language code of the dashboard.

Main Menu

Specify the main menu name here.

Sub Menu

Specify the sub menu name here.

3.1.1.1 Specifying the Mapping Details

You can select the fields and actions by clicking the 'Mapping Details' button in the 'Origination Dashboard Maintenance' screen. This screen is used to select the action and columns that you want to perform on a particular frame of the dashboard ..

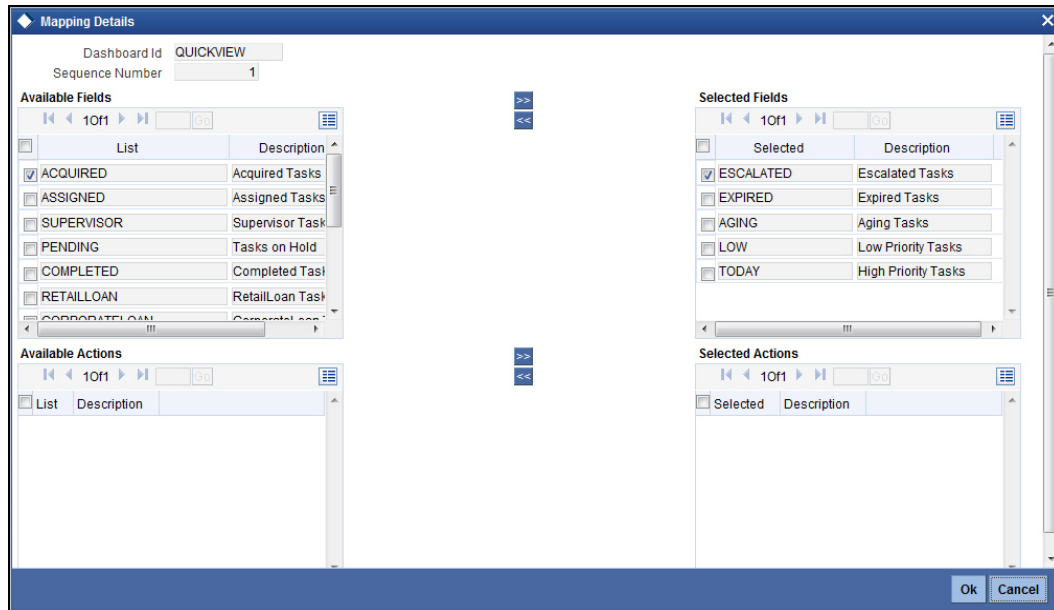

In this screen, you can select the required fields and actions for the dashboard from the Available Fields and Available Actions. Available fields displays all the queues maintained from SMDQUEMT screen, if the option selected is Count in queue type. Available action displays all the actions listed in the header of the task bar. On clicking the right-arrow button, system moves the selected fields and actions to the Selected Fields and Selected Actions sections respectively. Similarly, to de-select an action or a field, click the left-arrow button. Available fields displays blank if the queue type is selected queue and if the option is selected as 'Queue'. The mapping details are not allowed if the queue type is selected as BAM. The system displays an error message as "No field mappings available for selected queue criteria".

3.1.1.2 Navigating Across Dashboards

Instead of having multiple dashboards for the same set of Criteria Queue/ Report/Count, there is a facility to map them all to the 'Dashboard Maintenance Screen'. Mapping is based on the priority of the sequence number specified. You can also configure the partition to be displayed

in the dashboard per page. If there are more than one page then navigation is allowed both ways (ie. To and Fro).

Workflow Reference	Title	Creation Date(FromTo)
RetailLending8104	Application Input	2014-05-07 17:43:01 IST
RetailLending8107	Application Verification	2014-05-07 18:03:01 IST

Workflow Reference	Title	Creation Date(FromTo)
RetailLending338	Application Entry	2014-05-01 23:15:21 IST
RetailLending8108	Application Input	2014-05-07 18:12:25 IST

Workflow Reference	Title	Creation Date(FromTo)
CorporateLending6498	ApplicationEntry	2014-01-22 10:53:53 IST
CorporateLending6498	Application Enrichment	2014-01-22 10:54:56 IST
CorporateLending6498	ApplicationVerification	2014-01-22 10:55:56 IST
CorporateLending6498	Calculate Ratio	2014-01-22 10:57:12 IST
CorporateLending6498	Collateral Valuation	2014-01-22 10:57:12 IST
CorporateLending6498	Credit Evaluation	2014-01-22 10:57:12 IST
CorporateLending6498	Legal Verification	2014-01-22 10:57:12 IST
CorporateLending6498	Underwriting	2014-01-22 10:59:00 IST
CorporateLending6498.1	ApplicationEntry	2014-01-22 11:33:20 IST
CorporateLending6498	Application Enrichment	2014-01-22 11:33:21 IST

3.1.2 Maintaining Origination Dashboard Role Details

You can define the role and user for each dashboard using the 'Origination Dashboard Role Maintenance' screen. You can invoke this screen by typing 'ORDDSHRL' in the field at the top-right corner of the Application tool bar and clicking the adjoining arrow button.

LBL_CVS_ORDDSHRL

[New](#)

Map To:

Dashboard or Alert Id:

Description:

1 Of 1

Map To	User / Role Id	Map to Quick View	Set As Landing Page
<input type="checkbox"/> Role		<input type="checkbox"/>	<input type="checkbox"/>

Maker _____ Date Time: _____ Mod No _____

Checker _____ Date Time: _____

Specify the following details:

Map To

You can map user role to alert or dashboard. Select the appropriate option, i.e. Alert or Dashboard from the option list

Dashboard Id

Select the dashboard id from the adjoining option list. This list displays all valid dashboard ids maintained in the system.

Description

System displays the description for the selected dashboard ID/alert ID.

Map To

Select the dashboard mapping from the adjoining drop-down list. This list displays the following values:

- Role - If you select this option, then you can map the dashboard user with specific roles.
- User - If you select this option, then you can map the dashboard to a user.

User/Role Id

Select the user id or role id (based on the mapping type) from the adjoining option list. This list displays all valid user ids and role ids maintained in the system. You can select the appropriate one.

Map to Quick View

Check this box to indicate that the dashboard should be included in the Quick View frame in the left corner of the 'Tasks' tab of Oracle FLEXCUBE, for a specific user or role.

Set as Landing Page

Check this box to set this dashboard as the landing page dashboard. If you check this option, the user will see this as the default dashboard when navigated to the 'Tasks' tab of Oracle FLEXCUBE.

If a dashboard is mapped as default for a role or user id, then you cannot map another dashboard as default. The system displays an error as "User /Role already has default dashboard" in such case.

If there are different dashboards mapped to role and user id having the same role, then dashboard mapped to the user id will take precedence over the dashboard mapped as default for the role.

3.2 Process Code Maintenance

This section contains the following topics:

- [Section 3.2.1, "Maintaining Process Code Details"](#)
- [Section 3.2.2, "Business View of Stage Status"](#)

3.2.1 Maintaining Process Code Details

You can maintain the process code details in the 'Process Code Maintenance' screen. To invoke this screen by type 'STDPCODE' in the field at the top-right corner of the Application tool bar and click the adjoining arrow button.

Process Code Maintenance Detailed

New

Process Code Detailed * _____ Version * _____
Process Description _____ Default Version
Process Name * _____

Stage

1 Of 1 [Go] + - [List Icon]

<input type="checkbox"/>	Serial Number *	Stage Id *	Parent Stage Id
<input type="checkbox"/>			

Stage Title

1 Of 1 [Go] + - [List Icon]

<input type="checkbox"/>	Language Code *	Stage Title
<input type="checkbox"/>		

Application Mask

Maker	Date Time:	Mod No	Record Status	Exit
Checker	Date Time:		Authorization Status	

Specify the following details in the above screen:

Process Code Detailed

Specify a unique code for the process.

Process Description

Give an appropriate description for the process.

Process Name

Specify the name of the process.

Rule ID

Specify the Rule ID to be mapped to this process. Alternatively, you can also select the required Rule ID from the option list. The list displays all valid rule IDs maintained in the system.

Rule Description

The system displays the rule description based on the rule ID.

Version

Specify the process version.

You can view the stage, stage title and stage tasks status in this screen.

Stage

You can view the following details of each stage in this multi grid:

- Serial Number - Serial number of the process.
- Process Code - Unique process code of the stage.
- Stage ID - Indicates different stages of a particular process.
- Parent Stage ID - Indicates parent stage ID for the current stage.

Stage Title

You can view the following title details of each stage in this multi grid:

- Language Code - Indicates the language of the current stage.
- Stage Title - Indicates the title of the stage.

Stage Tasks

You can view the following task details of each stage in this multi grid:

- Serial Number - Serial number of the process.
- Task ID - Indicates the different tasks of a particular process.
- Flow ID - Indicates the different parallel flows in a stage.
- Task Type - Indicates whether the task type is human task or service call.
- Function ID - If the task type is human, then the function ID is mandatory.
- Service Identification - Indicates the service name for a service type task.
- TAT (in minutes) - Indicates the approximate duration required to complete a task.
- TAT Warning (in minutes) - Indicates the approximate duration required to send warning notification to a task.
- TAT Escalation (in minutes) - Indicates the approximate duration required to send escalation notification to a task.
- Estimated Completion Duration - Indicates approximate duration required to complete a task.

3.2.2 Business View of Stage Status

Click 'Stage Status' button in the landing page queues to view the business representation on the progress of the process. The system displays the following screen:

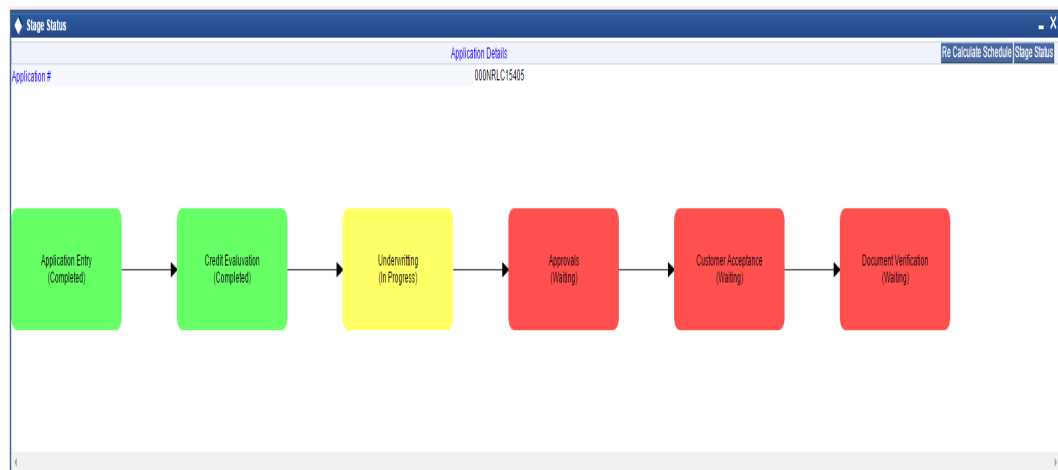

In this screen, you can view the graphical representation of the application flow.

You can view the Work Flow Reference Number on the top of the screen.

You can mouse over a stage to view the schedule details window. The following details are displayed in the tool-tip window:

- Stage
- Projected Arrival Date
- Projected Completion Date
- Actual Arrival Date
- Actual Completion Date

Click 'Re calculate Schedule' button to re-calculate the projected arrival date and projected completion date of the up coming stages. The system calculates these dates based on the current stage status.

Click 'Stage Status' button to view the detailed application flow for BPMN process. The system displays an error message for BPEL process.

Title	Action Time	Pick Up Time	User ID	User Name	Action Code	Action Description	Branch	Remarks	View
Receive And Verify	Tue Sep 16 20:12:01 IST 2014	Tue Sep 16 20:10:29 IST 2014	ant1	ANT1	PROCEED	PROCEED	002		View
Input savings account details	Tue Sep 16 20:21:26 IST 2014	Tue Sep 16 20:13:15 IST 2014	ant1	ANT1	PROCEED	PROCEED	002		View
Verify savings account details	Tue Sep 16 20:22:35 IST 2014	Tue Sep 16 20:22:04 IST 2014	ant1	ANT1	APPROVED	APPROVED	002		View

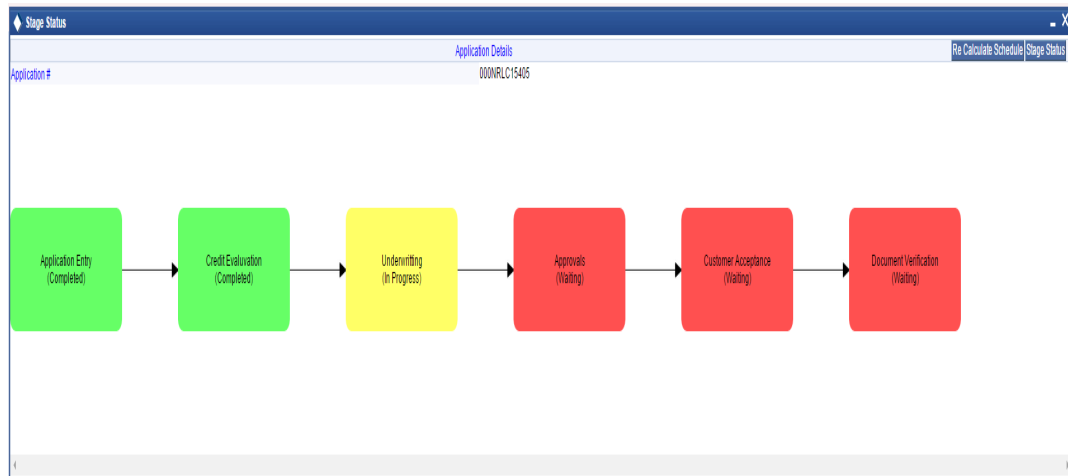

3.3 Dashboards

Oracle FLEXCUBE allows you to configure dashboards with multiple queues, count various queues and map dashboards to specific user roles or users.

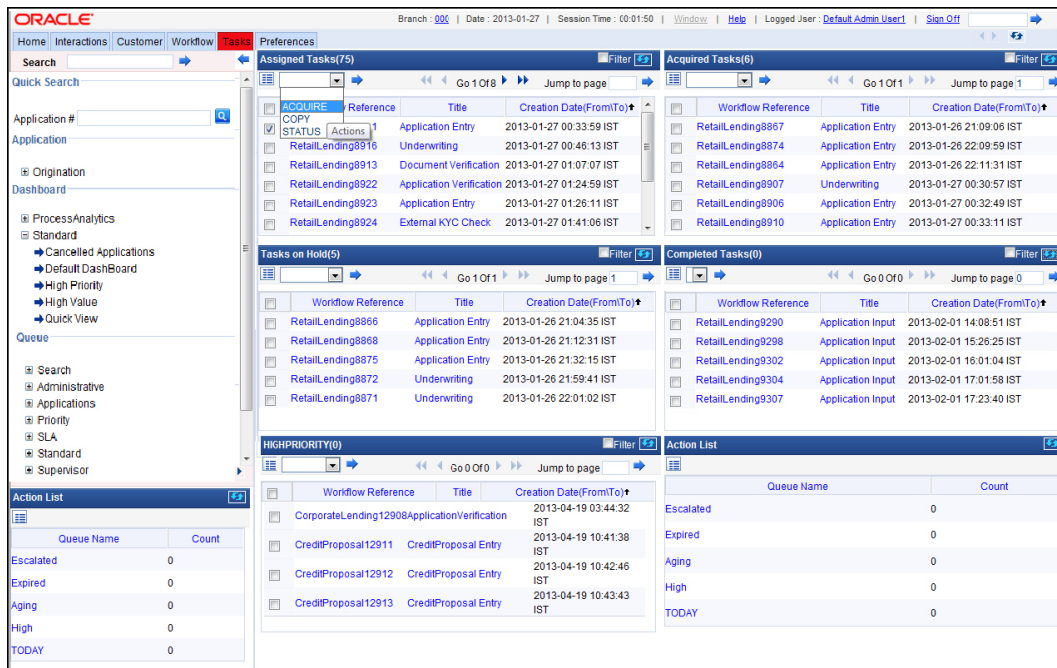

Mouse over on an item on the dashboard to view the details in a pop-up window.

Following are the features of Origination Dashboards:

- **Blow Up** - On clicking the 'Blow Up' button, system gives a detailed view of the particular frame in the dashboard.
- **Refresh** - On clicking the 'Refresh' button, system refreshes the particular frame in the dashboard.
- **Filter Search** - On checking the 'Filter' box, system displays the filter criteria. Using the filter option, you can search a particular task in a particular queue dashboard as well as in all queue dashboards.
- **Actions** - You can select task-specific actions such as Acquire, Copy, Release, Status, Resume, etc, on the dashboard queues.
- **Tool Tip** - You can view the details of the task when you place the cursor on the Workflow Reference Number of a particular task in the queue frames of the dashboard.

Note

Each dashboard has minimum one to maximum six frames.

Following are the pre-configured dashboards available in the system:

- **Default Dashboard** - This dashboard lists the Assigned, Acquired, Pending, Completed, High Priority tasks along with the Action List which lists the Escalated, Expired, Aging, High Priority and Today queue count.
- **Cancelled Applications** - This dashboard lists the cancelled Applications in Retail Lending, Corporate Lending, CASA and Trade.
- **High Priority** - This dashboard lists the high priority Applications in Retail Lending, Corporate Lending, CASA and Trade.

- High Value - This dashboard lists the high value Applications in Retail Lending, Corporate Lending, CASA and Trade.
- Quick View - This dashboard can be mapped to the Quick View frame. It displays details such as task count in each category (Escalated, Expired, Aging, High Priority and Today queue count) and Assigned, Acquired and High Priority Queue Dashboard.

You can click on workflow reference number to launch the application. The system launches the queue on click of the queue name in the count dashboards.

In addition to the pre-configured dashboards, you can create additional dashboards using the 'Origination Dashboard Maintenance' screen.

4. Configurations

Oracle FLEXCUBE Process Framework allows you to configure Queues, Landing and Sub-stages in the workflow layer to suit your bank's requirements. It also keeps track of duplication of transactions on the basis of the fields that you indicate.

This chapter contains the following topics:

- [Section 4.1, "Configuring Landing Page "](#)
- [Section 4.2, "Configuring Queues"](#)
- [Section 4.3, "Configuring Sub-Stages"](#)
- [Section 4.4, "Checking Duplicate Transactions"](#)
- [Section 4.5, "Enabling User Rights "](#)
- [Section 4.6, "Task Assignment Workflow"](#)

4.1 Configuring Landing Page

The page that is displayed on invoking the application is called as the 'Landing Page'. As mentioned above, you can launch a search for a particular task on the basis of the fields displayed in the Task List pane under the 'All' sub-menu in the 'Search' main menu item. The fields under this sub-menu (All) are pre-defined in the system and represent all process flows. The search fields under the 'All' sub-menu are displayed as shown in the screen below:

Queue Name	Count
Initiated	0
Reviewed	0
Processed	0
Cancelled	0
Approved	0
Funded	0

You can also choose to maintain additional fields for specific process flows, When you maintain additional fields for search operation for a process flow, the process flow is displayed under the 'Search' main menu and all the fields (pre-defined and the additional ones maintained for the process flow) become available for you to search on.

You can define the process-flow specific additional fields in the 'Landing Page Configuration' screen, which you can invoke by typing 'SMDLNDPG' in the field at the top right corner of the Application tool bar and clicking the adjoining arrow button. The following screen is displayed:

The screenshot shows a web application window titled 'Screen Name'. Inside, there's a 'New' button and a 'Maintenance Details' section with a 'Process Code' input field. Below this is another 'Maintenance Details' section containing a table with columns: 'Field Name', 'Field Label', 'Display', 'Searchable', and 'Sequence Number'. The table has one row with checkboxes for 'Display' and 'Searchable'. At the bottom, there are fields for 'Maker', 'Date Time', 'Mod No', 'Record Status', 'Checker', and 'Authorization Status', along with an 'Exit' button.

Here, you can capture the following details:

Process Code

Specify the function ID associated with the process work flow for which you are defining additional details.

Field Name

Select the field name which should appear in the Task List pane when you carry out a search for a task under the process flow mentioned above.

Field Label

Specify the name that should be displayed in the Task List pane.

Display

Check this box if the value of the field specified should be displayed as part of task details when you click on a task. This is applicable only when the 'Process Code' field is 'specified as 'All'.

Searchable

Check this box to indicate that the field should be made available for searching tasks. This facility is available for any 'Process Code'.

Seq No

Specify the order of display for the filed.

For instance, if you have maintained the fields 'Currency' and Product ID as an additional field for the Export LC process flow, you can see these fields along with the ones available under the 'All' sub-menu, when you click the 'Export LC' queue under the 'Search' main menu item.

4.2 Configuring Queues

A queue represents a set of human tasks that are grouped on the basis of the common characteristics they share. For instance, you could have groups based on whether the tasks have been completed, deleted or the type of transaction

You can define the basis for grouping for each queue in the 'Queue Maintenance' screen. To invoke this screen, type 'SMDQUEMT' in the field at the top right corner of the Application tool bar and click the adjoining arrow button. The following screen is displayed:

In this screen, you are required to specify the following details:

Queue ID

Specify a unique identification code for the queue.

Queue Type

Indicate the type of tasks that should be displayed for the queue you are defining. Select one of the following values from the adjoining drop-down list:

- Editable tasks: Tasks where the user will be allowed to modify existing data.
- Read-only Tasks: Tasks where the user can only view existing information.
- Normal Tasks – All the tasks for which the user has rights (editable/read-only)
- Supervisor – All tasks pertaining to the all the subordinates of the user.
- Current stage – The current stage of a process instance in which the user has performed at least one task.

Queue Criteria

Specify the criteria to be used to filter all tasks. The criteria specified here and the queue type you have indicated earlier determine the tasks that are displayed under each queue.

You can also associate Function IDs to queues by specifying them here. If you do so, only those Function IDs that have been associated can be accessed by the user. If there is no such association in the criteria, all Function IDs will be made available for the queue.

Sub Queues

The system displays the sub queues that are mapped to the parent queue generally queue.

When you click the Map Sub queue button, the system will provide the feature to map sub queue to the parent queue.

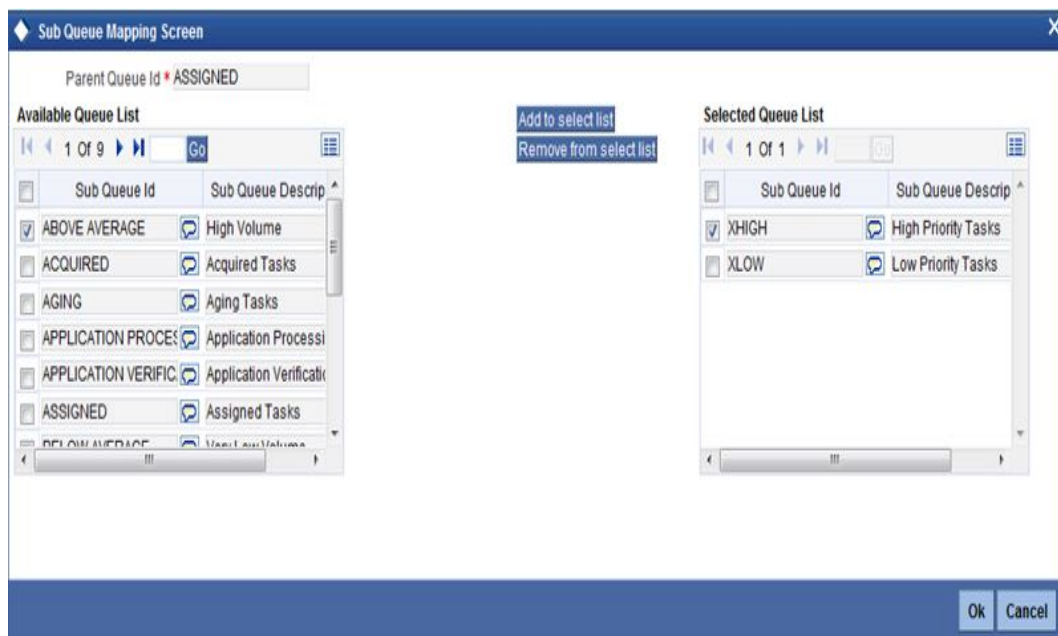

Filter Column

Indicate the basis for filtering the tasks.

Operator

Indicate the operator.

Filter Value

Specify the value to be considered for filtering.

Others

If 'Filter Value' chosen is 'Others', you can specify the value here.

Language Code

Indicate the language code to be used for the queue ID.

Main Menu

Indicate the name of the group under which the queue should be placed.

Sub-Menu

Specify the name for the queue. This will appear under the Main Menu.

Description

Specify a relevant description that will be displayed when you point the mouse on the Sub-Menu.

Workflow places the tasks that meet the criteria specified for each queue.

4.3 Configuring Sub-Stages

In the BPEL workflow layer, there are several points at which human tasks are generated. These tasks can be further divided into sub-stages which have entry conditions, exit outcomes etc. You can capture these details in the 'Task Sub Stage Maintenance' screen. You can invoke this screen by typing 'SMDSUBST' in the field at the top right corner of the Application tool bar and clicking the adjoining arrow button. The following screen is displayed:

The screenshot shows a web application window titled "Task Sub Stage Maintenance". At the top left, there is a "New" button. Below it, there is a text input field labeled "Function Id *". Underneath the input field is a table with the following columns: "Sequence Number *", "Sub Stage Function Id *", "Sub Stage Name *", "Outcome list *", "Reject To Stage", and "Entry Rule". The table is currently empty. At the bottom of the window, there are several fields: "Maker", "Checker", "Date Time", "Mod No", "Record Status", "Authorization Status", and an "Exit" button.

You are required to maintain the following details in this screen:

Function ID

Specify the Function ID associated with the human task for which you are defining sub-stages. The adjoining option list displays all valid function IDs available in the system. You can select the appropriate one.

Seq No

The system displays the sequence number for the current sub-stage.

Sub Stage Function Id

Specify the Function ID for the sub-stage. The adjoining option list displays all valid function IDs available in the system. You can select the appropriate one. The roles and the screen displayed for the sub-stage are fetched accordingly. This can be the same as the main Function ID for the task.

Sub Stage Name

Specify a unique name for the sub-stage.

Outcome List

Specify the possible outcomes allowed for this sub-stage. You can have any of the following:

- **MOVENXT:** If this is chosen, the current Function ID screen will be closed and the process will move on to the next sub-stage in sequential order

- AUTOMOVENXT: If this option is selected, the task will go to the next stage. The next sub-stage will be acquired automatically (provided the user has the relevant rights). The Function ID of the next sub-stage will be displayed in the screen.
- MOVEPREV: If this is chosen, the task will be moved to the previous stage mentioned or to the sub-stage sequence number specified in the 'Reject To Stage' field.

To facilitate this configuration, you need to map the first sub-stage to the Function ID of the human task. Also, you will be allowed to select only the 'MOVEPREV' option for the last sub-stage you have defined.

Entry Rule

Specify the conditions that need to be fulfilled for this sub-stage to be initiated. The specification is done in the same syntax as that for the queue configuration. If the criteria specified are satisfied, then the transaction comes to this sub-stage. If not, it moves to the next sub-stage.

Reject To Stage

This is the sub-stage to which a task is sent to in case the task is rejected at any point in the sub-stage process. If you do not specify any value for this, a rejected task will be sent to the previous level.

4.4 Checking Duplicate Transactions

During initiation of a process flow, when you enter and save the data, the system checks for duplicate transactions among all authorized and unauthorized tasks carried out on the same day. This check is performed based on a list of fields maintained for every transaction type. If duplicate transactions exist, The system will display the overrides message with Workflow reference numbers of all the matching tasks.

You can however, override the message and continue with the current process.

You can define the fields that need to be matched for duplication in the 'Function Description Maintenance' screen. You can invoke this screen by typing 'SMDFNDSC' in the field at the top right corner of the Application tool bar and clicking the adjoining arrow button.

In this screen, you are required to indicate the following details to facilitate checking for duplicate transactions:

Duplicate Check

Check this box to ensure that a validation is carried out to track duplication of transactions.

Field Name

Specify the field that should be the basis on which transaction duplication is checked.

Enabled

Check the box against each field whose values you want the system to compare across transactions.

4.5 Enabling User Rights

As mentioned earlier, each human task has a Function ID and the roles assigned to the Function ID are inherited by the task when it is initiated. A user, with access rights to the Function ID for the task, can either view the details of the task or perform edit operations on it.

You can define these rights in the 'Process Stage Rights' screen. To invoke this screen, type 'SMDROLDF' in the field at the top right corner of the Application tool bar and click the adjoining arrow button. In the 'Role Maintenance' screen that is displayed, click 'Process Rights' button. The following screen is displayed:

Role Profile Definition

New

Role Id *

Role Description

Centralisation Role

Maintenance | Reports | Batch | Online | Process Stage Rights | Acc Class Restriction | Branch Restriction | Rights | Web Branch | Fields

Maker Date Time: Mod No Record Status

Checker Date Time: Authorization Status

Exit

Specify the following details in the screen:

Role Function

Specify the Function ID for which you wish to define rights. The adjoining option list displays all valid function IDs available in the system. You can select the appropriate one.

Editable

Check this box if you wish to allow editing of data for this task/Function ID. If you do not check this box, the user can only view details for the role function specified earlier.

You can, therefore, use this screen to allow only editing or only modifying rights for a user for different role functions.

4.6 Task Assignment Workflow

This section contains the following topics:

- [Section 4.6.1, "Configuring Workflow Task Assignment"](#)
- [Section 4.6.2, "Task Assignment Methods"](#)
- [Section 4.6.3, "Task Assignment Component"](#)
- [Section 4.6.4, "Process, Stage, Assignment Model and Roles Mapping Definition Screen"](#)
- [Section 4.6.5, "User Availability Details"](#)
- [Section 4.6.6, "Task Reassignment"](#)

4.6.1 Configuring Workflow Task Assignment

Oracle FLEXCUBE allows you to assign different workflow tasks to different users based on the roles associated with the screen that initiates the task. Each task in a specific stage is assigned to users belonging to that specific assignee group. You can also balance the load of the users by checking the number of applications in each user queues and then assign the task to the user whom the task can be assigned.

You can map the process stage and associated assignee groups in the 'Process Stage-Assignee Group Mapping' screen. To invoke this screen, type 'ORDCACMR' in the field at the top right corner of the Application tool bar and click the adjoining arrow button. The task component refers this screen while preparing the list of users for the assignee group.

Function Id *	Function Id Description	Assignment Model *	Stage Assignment Order *	Rule Set Id	Rule Set Preview
		Do not auto-assign			Rule Set Preview

Specify the following in this screen:

Process

Specify the process code. Alternatively, you can select the process code from the option list. The list displays all valid process codes maintained in the system.

Process Description

The system displays the process description.

Process Assignment Order

Specify the process assignment order number.

Stage-Priority Assignment Model Mapping

Function ID

Specify the function ID of the stage associated with the process. Alternatively you can select the function ID from the option list. The list displays all valid function IDs.

Function ID Description

Specify a brief description on the function ID.

Assignment Model

Select the task assignment model from the drop-down list. The list displays the following values:

- Round Robin Method
- Count Based Approach
- Rule Based Approach
- Total TAT Based Approach

Stage Assignment Order

Specify the stage assignment order.

Rule Set ID

Specify the rule set ID. Alternatively, you can select the rule set ID from the option list. The list displays all valid rule set IDs.

Click 'Rule Set Preview' to view the Rule Set details.

Stage - Role Mapping

Role

Specify the role of the stage. Alternatively, you can select the role from the option list. The list displays all valid roles.

Role Description

Specify a brief description on the role.

4.6.2 Task Assignment Methods

There are different task assigning methods to assign the tasks to the members in an assignee group. The task assignment component will run as a background process at regular intervals and assign the unassigned tasks by applying appropriate task assignment method.

4.6.2.1 Round-Robin Method

In the Round Robin method, the task is assigned to the users in an assignee group based on the alphabetical order. When the last user is assigned with a task, then the subsequent tasks

will be again assigned based on the same alphabetical order. This iteration is repeated till the tasks are completed.

Assignment cycle starts by assigning 'Task 1' to 'User 1'

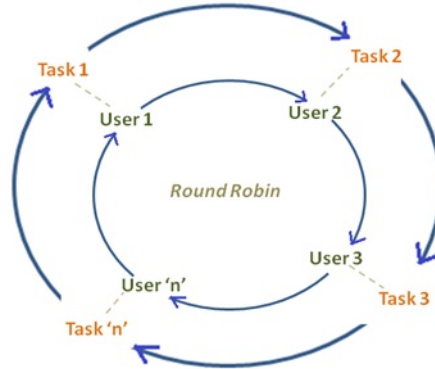

4.6.2.2 Count Based Approach

In count based approach, you can specify an overall task count that a user in the group can handle. You can also reserve slots for a specific process-stage combination within this overall task count. You can maintain the values for count based task assignment in the 'Count Based Attributes Maintenance' screen.

In this screen, you can define the minimum and maximum limit of tasks that can be handled by users of each process stage combination. You can also indicate the order of priority among the tasks. The task assignment component then assigns the task in highest to lowest order of priority. You can invoke this screen by typing 'ORDCACCB' in the field at the top right corner of the Application tool bar and clicking the adjoining arrow button

Count based task assignment attributes

New

User*
Name

User Overall Task Limit

Forenoon Afternoon

Minimum Task(s)* Minimum Task(s)*

Maximum Task(s)* Maximum Task(s)*

User Process Level Task Limit

1 Of 1

<input type="checkbox"/>	Process *	Function Id *	Forenoon Minimum Tasks(s) *	Forenoon Maximum Tasks(s) *	Afternoon Minimum Task(s) *	Afternoon
<input type="checkbox"/>						

Maker Date Time: Mod No Record Status

Checker Date Time: Authorization Status

Specify the following in this screen:

User ID

Specify the user ID. Alternatively, you can select the user ID from the option list. The list displays all valid user IDs.

Name

The system displays the name of the user.

Overall Limit - Forenoon**Minimum Tasks**

Specify the overall minimum load limit of the user for forenoon session.

Maximum Tasks

Specify the overall maximum load limit of the user for forenoon session.

Overall Limit - Afternoon**Minimum Tasks**

Specify the overall minimum load limit of the user for afternoon session.

Maximum Tasks

Specify the overall maximum load limit of the user for afternoon session.

Process Level Load Limit**Process**

Specify the name of the process.

Function ID

Specify the function ID of the stage.

Function ID Description

Specify a brief description on the function ID.

Forenoon Minimum Tasks

Specify the minimum process level load limit of the user during forenoon session.

Forenoon Maximum Tasks

Specify the maximum process level load limit of the user during forenoon session.

Afternoon Minimum Tasks

Specify the minimum process level load limit of the user during afternoon session.

Afternoon Maximum Tasks

Specify the maximum process level load limit of the user during afternoon session.

Overall task Limit is the number of tasks that a user can handle. Process stage Task Limit is the number of tasks that is reserved for the user in the overall limit for a given process-stage combination. Minimum and maximum overall limit for a session will be greater than or equal to the sum of minimum and maximum limits reserved for different process-stage combination.

Assigning Tasks based on the count based approach:

If Minimum Process-Stage Task Count Limit is not reached, then for a given task, select the users for whom the current task count is lesser than their minimum task cap for the process-stage combination in the task.

- If one user is found, then acquire the task for that user.

- If more than one user is found, find user who has the maximum task cap limit for this process stage combination.
- If there are more than one user who has maximum task cap limit for that process-stage combination, then find a user who has lesser minimum overall limit.
- If more than one user has lesser minimum overall limit, then find a user who has higher maximum overall limit.
- If more than one user has higher maximum overall limit, then you can assign it to any of these users as these users will be equally qualified.
- If there are no users with least task count, go to maximum process-stage task count limit not reached section.

If Maximum Process-Stage Task Count Limit is not reached for a given process-stage combination, then select the users for whom the current task count is lesser than their maximum task cap for the process-stage combination.

- If one user is found, then acquire the task for that user.
- If more than one user is found, find the user who has lesser minimum overall limit.
- If there are more than one user who has lesser minimum overall limit, then find a user who has higher maximum overall limit.
- If there is more than one user who has higher maximum overall limit, you can assign it to one of these users.
- If no user is found then go to minimum overall task count limit has not reached section.

If Minimum Overall Task Count Limit has not reached, then select the user for whom the current task count is lesser than minimum overall task count.

- If one user is found, then acquire the task for that user.
- If more than one user is found then find out who has higher minimum overall limit.
- If there are more than one user who has higher minimum overall limit, then find a user who has higher maximum overall limit.
- If there are more than one user who has higher maximum overall limit, then you can assign the task to one of them.
- If no users are found then go to maximum overall task count limit not reached section.

If Maximum Overall Task Count Limit has not reached, then select the users for whom the current task count is lesser than maximum overall task count limit. From these users find the users with least current task count.

- If one user is found, then acquire the task for that user.
- If more than one user is found then find the user who has higher maximum overall limit.
- If there are more than one users who has higher maximum overall limit, then assign the task to one of them.
- If there are no users found, then you can leave the task at group level as the task limit of each user has been exhausted.

4.6.2.3 Rule Based Approach

In rule based approach, you can assign the task by configuring certain rules. You can configure the attribute criteria and assign the task when criteria matches. If more than one rule

matches the criteria, then the rule with higher priority is applied. The table below displays the attributes for the rules:

Attribute	Relational Operator	Comments
Customer	=	Customer ID
Process	=	Process that initiated the task
Stage	=	Stage of Task
Priority	=	Priority list applicable for tasks
Country	=	Country available in the task
Product	=	Product available in the task
Amount	>, <, =	Amount available in the task
Currency	=	Currency available in the task

You can maintain the rules for rule based assignment method in 'Task Rules Maintenance' screen. You invoke this screen by typing 'ORDCACRB' in the field at the top right corner of the Application tool bar and clicking the adjoining arrow button.

Maintain the following in this screen:

Rule Set ID

Specify the rule set ID.

Rule ID

Specify the rule number.

Rule Description

Specify the description for the rule.

Expression

Specify the rule expression.

Disable

Check this box to disable the rule.

Function ID

Specify the function ID of the stage associated with the rule.

Function ID Description

Specify a brief description on the function ID.

Branch Code

Specify the branch code. Alternatively, you can select the branch code from the option list. The list displays all valid branch codes.

Role

Specify the role.

Assignee User

Select the assignee user from the adjoining option list.

Execution Order

Specify the order in which the rules should be executed.

4.6.2.4 Total TAT Based Approach

In this approach, you can define approximate turn around time and priority for each process stage. In this approach the task is assigned based on the time required for the pending tasks of the users. This approach determines the total turn around time required for each tasks of the users and assigns the pending task to the least assigned user. These unassigned tasks will be assigned in highest to lowest order of priority.

You can maintain the TAT based assignment attributes in 'Process Code Maintenance' screen. To invoke this screen, type 'STDPCODE' in the field at the top right corner of the Application tool bar and click the adjoining arrow button.

Serial Number *	Stage Id *	Parent Stage Id

Language Code *	Stage Title

Application Mask

Maker	Date Time:	Mod No	Record Status
Checker	Date Time:		Authorization Status

For more details on Process Code Maintenance screen, refer to the section Process Code Maintenance in Origination Dashboards chapter of this user manual.

ORTAT Batch

The system runs the ORTAT batch at regular intervals to warn/escalate/reassign those tasks that are pending. You can configure this batch in Job Details (SMSJOBBER) screen.

- Task TAT - This batch is run at regular intervals to warn the user on the tasks for which the defined warning time has elapsed but the task is still in processing state. The user will receive an email notification with the task. When the user navigates to the acquired view of task page, then the tasks which have exceeded the TAT and TAT warning are highlighted.
- Task TAT Escalation/Reassignment - This batch is run at regular intervals to identify the task that has exceeded the escalation TAT. This batch will apply escalation rules as mentioned in the TAT definition screen to escalate/reassign the pending task to another user group. An email notification is send to the user or group to which the task was assigned before escalation/reassignment and to the user or group to which the task is assigned after escalation/reassignment. If the task is reassigned and the user or group navigates to acquired view of the task page, the tasks which have exceeded TAT are highlighted.

4.6.3 Task Assignment Component

The task assignment component batch job is run at regular intervals to fetch all the unacquired tasks. The task assignment component checks the process and stage associated with each unacquired tasks and determines the assignment method that needs to be applied. The unassigned tasks are grouped based on the assignment method that needs to be applied. The task assignment component sorts the unassigned tasks in highest to lowest priority order.

For each task, the task assignment component checks the Process Stage- Assignee Group Mapping' screen and assigns the tasks to the user by applying assignment method logic.

4.6.4 Process, Stage, Assignment Model and Roles Mapping Definition Screen

You can assign tasks in a specific stage to users belonging to a specific role through 'Process Stage Assignment Model Mapping' screen. To invoke this screen, type 'ORDCACMR' in the field at the top right corner of the Application tool bar and click the adjoining arrow button.

Function Id *	Function Id Description	Assignment Model *	Stage Assignment Order *	Rule Set Id	Rule Set Preview
		Do not auto-assign			Rule Set Preview

For more details on Process, Stage Assignment Model and Role Mapping screen, refer to the section *Configuring Workflow Task Assignment* of this user manual.

4.6.5 User Availability Details

You can maintain the user availability details to handle different tasks in 'User Availability' screen. In the user availability screen you can maintain forenoon and afternoon sessions during which the user will not be able to handle the tasks. To invoke this screen, type 'ORDCACUA' in the field at the top right corner of the Application tool bar and click the adjoining arrow button.

Maker	Date Time:	Mod No	Record Status
Checker	Date Time:		Authorization Status

Specify the following here:

User

Select the user for whom you are setting the unavailable time.

Start Date

Specify the date from which the user is unavailable.

Include Forenoon

Check this box to indicate that the user is not available during forenoon session.

Include Afternoon

Check this box to indicate that the user is not available during afternoon session.

End Date

Specify the date to which the user is unavailable.

Include Forenoon

Check this box to indicate that the user is not available during forenoon session.

Include Afternoon

Check this box to indicate that the user is not available during afternoon session.

4.6.6 Task Reassignment

You can reassign one or more tasks from a user to another user through Bulk Reassignment/Release screen. To invoke this screen type 'ORDCACRA' in the top right corner of the Application tool bar and click the adjoining arrow button.

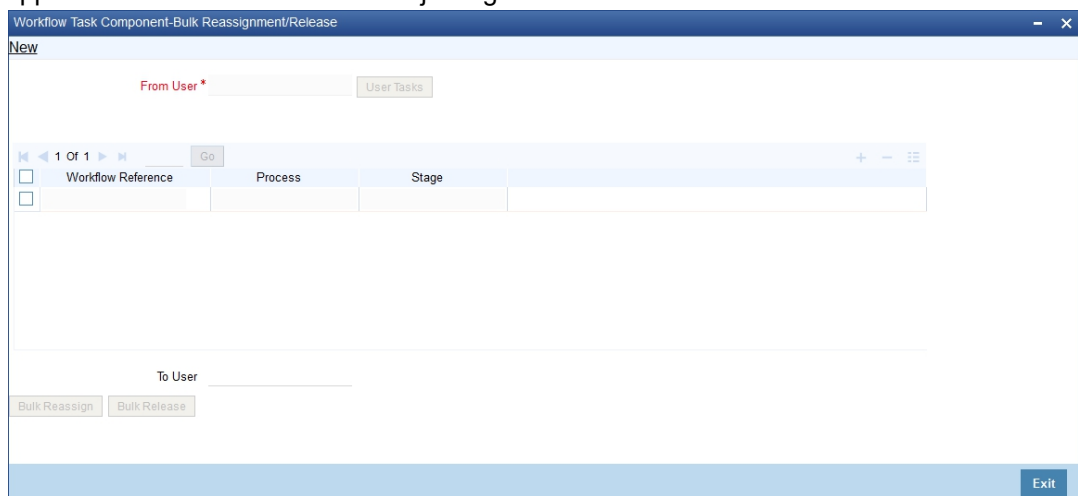

Specify the following here:

From User

Specify the user from whom the tasks has to be reassigned. Alternatively, you can select the user from the option list. The list displays all the users maintained in the system.

Click 'User Tasks' button to fetch all the pending tasks of the selected user.

To User

Specify the user to whom the tasks has to be reassigned. Alternatively, you can select the user from the option list. The list displays all the users maintained in the system

Workflow Reference

The system displays the task name.

Process

The system displays the process.

Stage

The system displays the process stage.

Bulk Reassign

To reassign the selected tasks in bulk to selected 'To User', click 'Bulk Reassign' button.

Bulk Release

To release the selected tasks in bulk from selected 'From User', click 'Bulk Release' button.

5. Reports

This chapter deals with the various reports that are available for the Process framework.

This chapter contains the following sections:

- [Section 5.1, "List of Task Assignment Rules Report"](#)
- [Section 5.2, "Workflow Task Audit Log Report"](#)
- [Section 5.3, "User Work Load Logically Grouped Based on Supervisor Report"](#)
- [Section 5.4, "Assignment Vs Completed Analysis Report"](#)
- [Section 5.5, "Load Factor Report"](#)

5.1 List of Task Assignment Rules Report

This section contains the following topics:

- [Section 5.1.1, "Generating Task Assignment Rules Report"](#)
- [Section 5.1.2, "Contents of the Report"](#)

5.1.1 Generating Task Assignment Rules Report

This report provide the list of rules for a given User ID and process flow. You can invoke this report by typing 'ORRCACAR' in the field at the top right corner of the Application tool bar and clicking on the adjoining arrow button.

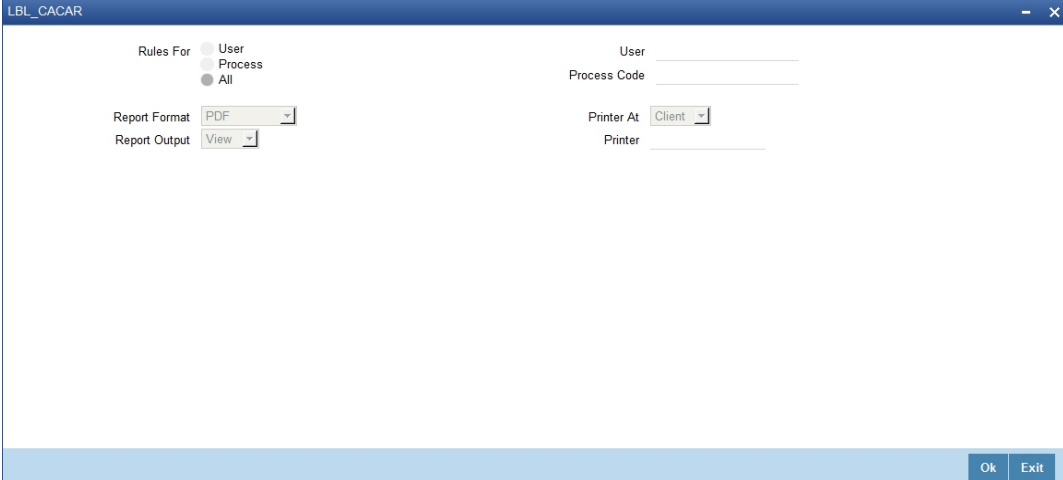

The screenshot shows a dialog box titled 'LBL_CACAR'. It contains several input fields and controls:

- Rules For:** Radio buttons for 'User', 'Process', and 'All'. 'All' is selected.
- Report Format:** A dropdown menu set to 'PDF'.
- Report Output:** A dropdown menu set to 'View'.
- User:** An empty text input field.
- Process Code:** An empty text input field.
- Printer At:** A dropdown menu set to 'Client'.
- Printer:** An empty text input field.
- Buttons:** 'Ok' and 'Exit' buttons at the bottom right.

Specify the following details:

From Date

Specify, from the adjoining calendar button, the date from which you require details.

To Date

Specify, from the adjoining calendar button, the date till which you require details.

Click 'OK' button to generate the report. Click 'Exit' to return to the Reports Browser.

5.1.2 Contents of the Report

The contents of the report are discussed under the following heads:

Header

The Header carries the Report Name, Run Date and Time and the Period for which the report is generated.

Body of the Report

The following details are displayed in the report:

Field Name	Field Description
Process	This is the process
Stage	This is the stage of the process
Rule	This is the rule ID
Rule Description	This is the description of the rule
Expression	This indicates the rule expression
Start Date	This indicates the start date
End Date	This indicates the end date
Disable	This indicates whether the rule is disabled
Assignee User	This is the user to whom the task is assigned
Execution Order	This indicates the order of execution

5.2 Workflow Task Audit Log Report

This section contains the following topics:

- [Section 5.2.1, "Generating Workflow Task Audit Log Report"](#)
- [Section 5.2.2, "Contents of the Report"](#)

5.2.1 Generating Workflow Task Audit Log Report

This report lists the workflow task assignment in chronological order. You can invoke the 'Workflow Task Audit Log' screen by typing 'ORRCACAD' in the field at the top right corner of the Application tool bar and clicking on the adjoining arrow button.

The screenshot shows a dialog box titled "LBL_CACAD" with a "Workflow Reference*" section. It contains several input fields and buttons:

- Workflow Reference***: A text input field.
- Report Format**: A dropdown menu with "PDF" selected.
- Report Output**: A dropdown menu with "View" selected.
- Printer At**: A dropdown menu with "Client" selected.
- Printer**: A text input field.
- Buttons**: "Ok" and "Exit" buttons are located at the bottom right of the dialog.

Specify the following details:

From Date

Specify, from the adjoining calendar button, the date from which you require details.

To Date

Specify, from the adjoining calendar button, the date till which you require details.

Click 'OK' button to generate the report. Click 'Exit' to return to the Reports Browser.

5.2.2 **Contents of the Report**

The contents of the report are discussed under the following heads:

Header

The Header carries the Report Name, Run Date and Time and the Period for which the report is generated.

Body of the Report

The following details are displayed in the report:

Field Name	Field Description
Workflow Reference	This is the workflow reference number
Event	This is the event
Assignee Group	This is the assignee group
Updated By	This indicates the group or user who has updated the event.
Event Date	This indicates the event date
Comments	This indicates the comment

5.3 **User Work Load Logically Grouped Based on Supervisor Report**

This section contains the following topics:

- [Section 5.3.1, "Generating Work Load Report of the User"](#)
- [Section 5.3.2, "Contents of the Report"](#)

5.3.1 Generating Work Load Report of the User

This report provides a list of open, closed and total number of tasks of direct reports of a supervisor. You can invoke this screen by typing 'ORRCACLD' in the field at the top right corner of the Application tool bar and clicking on the adjoining arrow button.

The screenshot shows a window titled 'LBL_CACLD' with the following fields and controls:

- Load Report For ***: Radio buttons for 'Delegates of Supervisor' (selected), 'Role', and 'User'.
- Supervisor**: Text input field.
- Role**: Text input field.
- User**: Text input field.
- From Date ***: Text input field with a calendar icon.
- To Date ***: Text input field with a calendar icon.
- Report Format**: Dropdown menu set to 'PDF'.
- Report Output**: Dropdown menu set to 'View'.
- Printer At**: Dropdown menu set to 'Client'.
- Printer**: Text input field.
- Buttons**: 'Ok' and 'Exit' buttons at the bottom right.

Specify the following details:

From Date

Specify, from the adjoining calendar button, the date from which you require details.

To Date

Specify, from the adjoining calendar button, the date till which you require details.

Supervisor ID

Specify the supervisor ID. Alternatively, you can select the supervisor ID from the option list. The list displays all valid supervisor IDs.

Click 'OK' button to generate the report. Click 'Exit' to return to the Reports Browser.

5.3.2 Contents of the Report

The contents of the report are discussed under the following heads:

Header

The Header carries the Report Name, Run Date and Time, Supervisor ID, User ID and the Period for which the report is generated.

Body of the Report

The following details are displayed in the report:

Field Name	Field Description
Total Task for the Period	This indicates the total tasks during the specified period
User ID	This is the user identification number
Pending Tasks	This is the number of pending tasks
Completed Tasks	This is the number of completed tasks

5.4 Assignment Vs Completed Analysis Report

This section contains the following topics:

- [Section 5.4.1, "Generating Assignment Vs Completed Analysis Report"](#)
- [Section 5.4.2, "Contents of the Report"](#)

5.4.1 Generating Assignment Vs Completed Analysis Report

This report lists tasks assigned to users and number of open, closed and total number of tasks. You can invoke the 'Underwriting Status By Month and Intermediary Report' screen by typing 'ORRCACLD' in the field at the top right corner of the Application tool bar and clicking on the adjoining arrow button.

The screenshot shows a window titled 'LBL_CACLD' with the following fields and controls:

- Load Report For:** Radio buttons for 'Delegates of Supervisor', 'Role', and 'User'. 'Delegates of Supervisor' is selected.
- Supervisor:** Text input field.
- Role:** Text input field.
- User:** Text input field.
- From Date:** Text input field with a calendar icon.
- To Date:** Text input field with a calendar icon.
- Report Format:** Dropdown menu set to 'PDF'.
- Report Output:** Dropdown menu set to 'View'.
- Printer At:** Dropdown menu set to 'Client'.
- Printer:** Text input field.
- Buttons:** 'Ok' and 'Exit' buttons at the bottom right.

From Date

Specify, from the adjoining calendar button, the date from which you require details.

To Date

Specify, from the adjoining calendar button, the date till which you require details.

Assignee Group

Specify the assignee group. Alternatively, you can select the assignee group from the option list. The list displays all valid assignee groups.

Click 'OK' button to generate the report. Click 'Exit' to return to the Reports Browser.

5.4.2 Contents of the Report

The contents of the PDF report are discussed under the following heads:

Header

The Header carries the Report Name, Run Date and Time, User ID, Assignee Group, Month for which report is being generated and the Period for which the report is generated.

Body of the Report

The following details are displayed in the report:

Field Name	Field Description
Total Task for the Period	This number of tasks within the specified period.

Field Name	Field Description
Assignee Group	This is the assignee group to which the task is assigned.
User ID	This is the user identification number
Pending Tasks	This is the number of pending tasks
Completed Tasks	This is the number of completed tasks

5.5 Load Factor Report

This section contains the following topics:

- [Section 5.5.1, "Generating Load Factor Report"](#)
- [Section 5.5.2, "Contents of the Report"](#)

5.5.1 Generating Load Factor Report

This report lists the number of pending and completed tasks assigned to each user and a load factor which indicates the percentage of group tasks assigned to user during the specified period. You can invoke this screen by typing 'ORRCACLF' in the field at the top right corner of the Application tool bar and clicking on the adjoining arrow button.

The screenshot shows a window titled 'LBL_CACLF' with the following fields and controls:

- Load Report For:** Radio buttons for 'Delegates of Supervisor' (selected) and 'User Role'.
- Supervisor:** Text input field.
- Role:** Text input field.
- From Date *:** Text input field with a calendar icon.
- To Date *:** Text input field with a calendar icon.
- Report Format:** Dropdown menu set to 'PDF'.
- Report Output:** Dropdown menu set to 'View'.
- Printer At:** Dropdown menu set to 'Client'.
- Printer:** Text input field.
- Buttons:** 'Ok' and 'Exit' buttons at the bottom right.

Specify the following details:

From Date

Specify, from the adjoining calendar button, the date from which you require details.

To Date

Specify, from the adjoining calendar button, the date till which you require details.

Assignee Group

Specify the assignee group. Alternatively, you can select the assignee group from the option list. The list displays all valid assignee groups.

Supervisor ID

Specify the supervisor ID. Alternatively, you can select the supervisor ID from the option list. The list displays all valid supervisor IDs.

Click 'OK' button to generate the report. Click 'Exit' to return to the Reports Browser.

5.5.2 Contents of the Report

The contents of the report are discussed under the following heads:

Header

The Header carries the Report Name, Run Date and Time, Assignee Group, Month for which report is being generated and the Period for which the report is generated.

Body of the Report

The following details are displayed in the report:

Field Name	Field Description
Number of Sessions in the Period	This indicates the number of sessions during the specified period
Peak Session Load	This indicates the peak session load
Average Session Load	This indicates the average session load
User	This indicates the user ID
Total Number of tasks	This indicates the total number of tasks
Peak Session	This indicates the date and time of peak session
Pending Tasks	This indicates the number of pending tasks
Completed Tasks	This indicates the number of completed tasks
Percentage of Tasks Handles	This indicates the percentage of tasks handled.

6. Function ID Glossary

G

GEDMLIAB2-14

O

ORDCACCB4-10

ORDCACMR4-8, 4-16

ORDCACRA4-17

ORDCACRB4-13

ORDCACUA4-16

ORDDSHMT3-1

ORDDSHRL3-4

ORRCACAD5-2

ORRCACAR5-1

ORRCACLD5-4, 5-5

ORRCACLF5-6

S

SMDFNDSC4-6

SMDLNDPG4-2

SMDQUEMT4-3

SMDROLDF4-7

SMDSUBST4-5

STDPCODE3-6, 4-14